



## WEEE DISASSEMBLY INSTRUCTIONS

### SUPERMICRO AS -1115HS-TNR ENCLOSURE

#### **Abstract**

This document provides clear guidance for end-of-life recyclers on how to identify and disassemble reportable materials in compliance with the Waste Electrical and Electronic Equipment (WEEE) directive.

# Table of Contents

|     |  |    |
|-----|--|----|
| 1.  | Product Views.....   | 1  |
| 2.  | Reportable Materials on AS -1115HS-TNR .....                   | 3  |
| 3.  | Disassemble Instructions .....                                 | 4  |
|     | 3.3 Step-by-Step Disassembly Instructions .....                | 6  |
| 1.  | Removing Cable and Chassis Top Cover .....                     | 6  |
| 2.  | Removing Hard Disk Drive (HDD) / Solid State Drive (SDD) ..... | 7  |
| 3.  | Removing Power Supply .....                                    | 9  |
| 4.  | Removing Advanced I/O (AIOM) Network Card .....                | 11 |
| 5.  | Removing AIOM Cable .....                                      | 11 |
| 6.  | Removing Add-on Module (AOM) .....                             | 12 |
| 7.  | Removing Fan .....   | 12 |
| 8.  | Removing Backplane .....                                       | 13 |
| 9.  | Removing the Riser Bracket and Riser Card .....                | 13 |
| 10. | Removing Processor .....                                       | 14 |
| 11. | Removing DIMM.....   | 15 |
| 12. | Removing the Network Card.....                                 | 15 |
| 13. | Removing the M.2 from the Motherboard .....                    | 16 |
| 14. | Removing the Power Supply Shroud and Air Shroud.....           | 16 |
| 15. | Removing Motherboard.....                                      | 17 |

# 1. Product Views

Front view



Rear view



Product construct view



Hard Disk Drive/ Solid State Drive

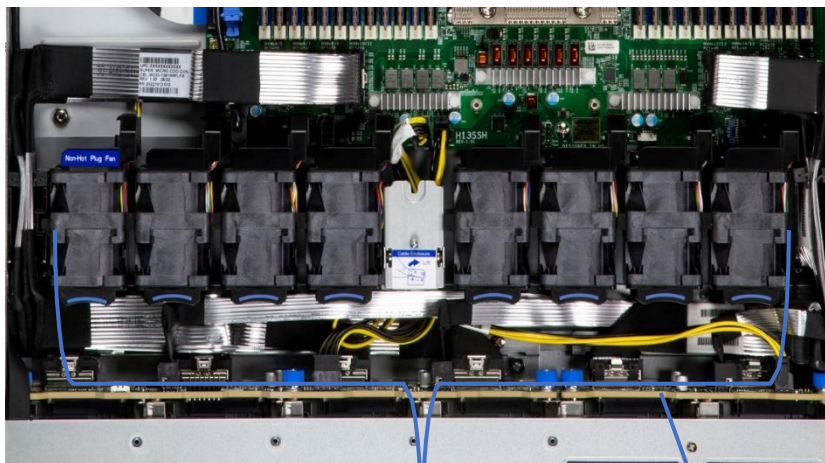

Fans

Backplane



Power Supply

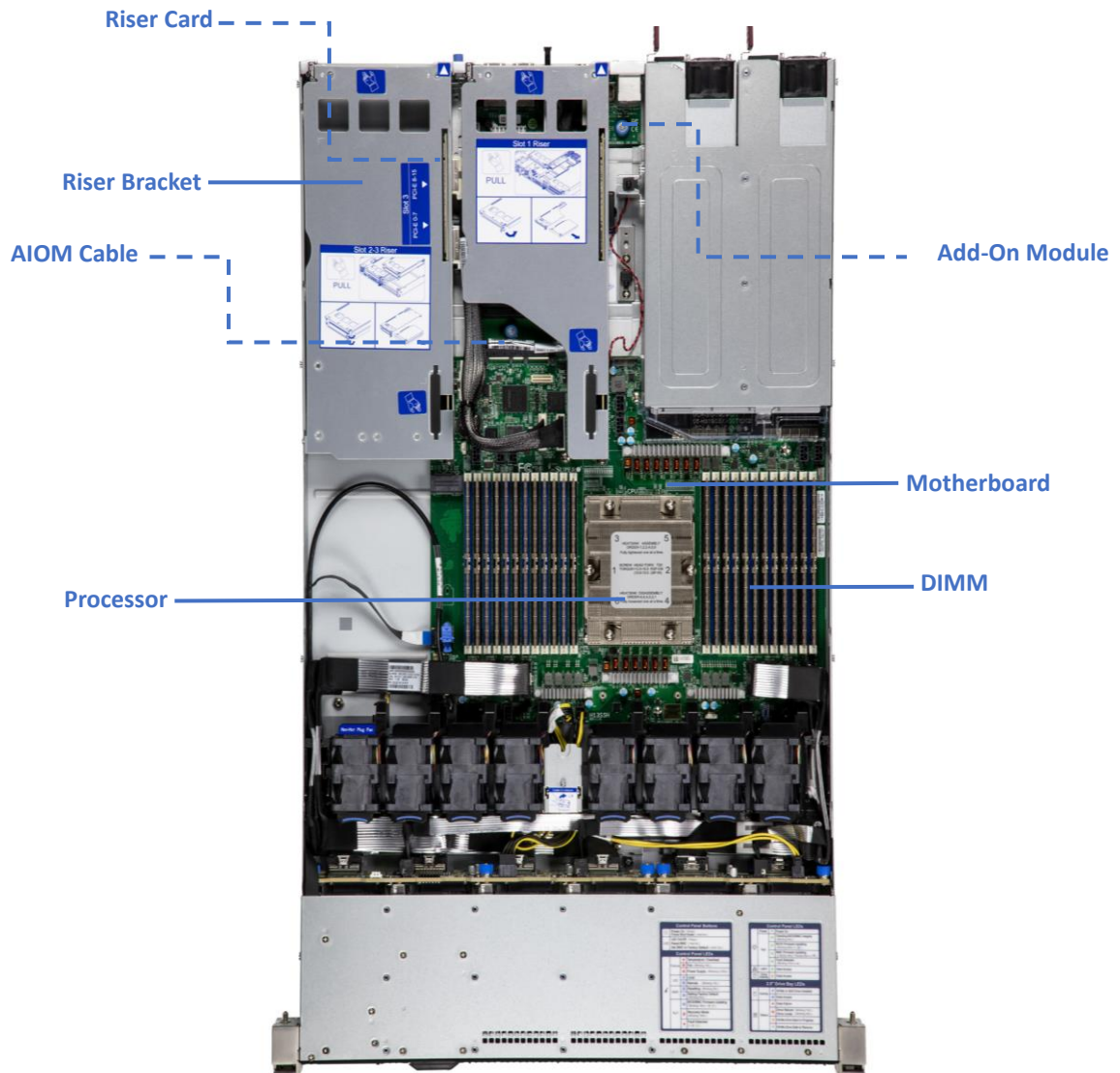

## 2. Reportable Materials on AS -1115HS-TNR

According to Article 8(2) and Annex VII of WEEE directive 2012/19/EU, Below materials and components should be selectively treated.

| Description   | Notes   | No.   | Quantity |
|---|---|---|----------|
| Printed Circuit Boards (PCB) or Printed Circuit Assemblies (PCA)                                      | With a surface greater than 10 sq cm (Depending on the product configuration)         | 2.3, 3.5, 4.1, 5.1, 6.1, 8.1, 9.2, 10.2, 11.1, 12.1, 13.1, 15.1 | 28       |
| Batteries   | All types, including standard alkaline and lithium coin or button style batteries     | 15.2  | 1        |
| Mercury-containing components   | For example, mercury in lamps, display backlights, scanner lamps, switches, batteries |   |          |
| Liquid Crystal Displays (LCD) with a surface greater than 100 sq cm                                   | Includes background illuminated displays with gas discharge lamps                     |   |          |
| Cathode Ray Tubes (CRT)   |   |   |          |
| Capacitors / condensers (Containing PCB/PCT)  |   |   |          |
| Electrolytic Capacitors / Condensers measuring greater than 2.5 cm in diameter or height              | Depending on the power supply model   | 3.6   | 2        |
| External electrical cables and cords  |   | 1.1   | 2        |
| Gas Discharge Lamps   |   |   |          |
| Plastics containing Brominated Flame Retardants   |   |   |          |
| Components and parts containing toner and ink, including liquids, semi-liquids (gel/paste), and toner | Include the cartridges, print heads, tubes, vent chambers, and service stations.      |   |          |
| Components and waste containing asbestos  |   |   |          |
| Components, parts, and materials containing refractory ceramic fibers                                 |   |   |          |
| Components, parts, and materials containing radioactive substances                                    |   |   |          |



### 3. Disassemble Instructions

The intent of this document is to provide guidance to recyclers on the presence of materials and components at the product / family level, as required by the EU WEEE Directive 2012/10/EU. This document should also help direct recyclers to proper methods for removing parts and general product disassembly instructions.

This chapter consists of three subsections:





Recommended disassembly tools, disassembled flowchart, and step-by-step disassembly instructions to direct recycler proper methods to treat.

#### 3.1 Recommended Disassembly Tools

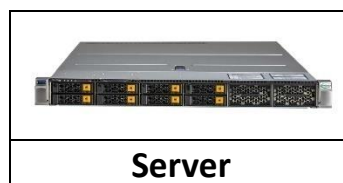
|                         |                      |   |
|-------------------------|----------------------|---|
| <b>Disassembly tool</b> | Cross screwdriver    |   |
|                         | Flathead screwdriver |  |

#### 3.2 Disassembled flowchart

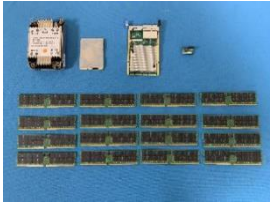

|   |   |  |   |
|---|---|--|---|
|  |  |  |  |
| Chassis   | Power Supplies  | RAM, CPU, Heatsink,<br>AIOM Card   | Power Cords   |

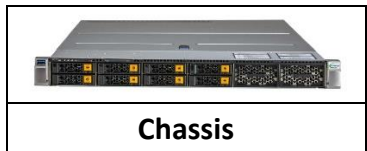

**Chassis**





|  |  |   |   |
|--|--|---|---|
|   |   |   |  |
| Backplane  | Fans   | Screws  | Motherboard, Riser Cards, Backplane, Add-On Module, AIOM Cable                      |
|  |  |  |   |
| Battery  | Cables   | Power Supply Air Shroud   |   |







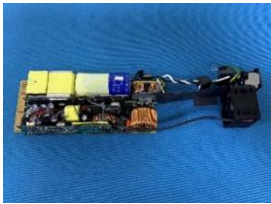

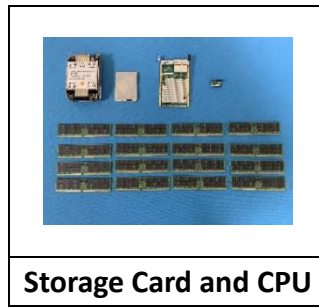
**Power Supply**



|   |   |  |
|---|---|--|
|  |  |  |
| Power Enclosure*2   | Screws and Standoff*2 Set   | Power Supply Module*2  |



|  |   |   |   |
|--|---|---|---|
|   |  |   |  |
| Heat Sink  | Processor   | SSD *6set   | Add-On Module   |
|  |  |  |   |
| Network Card *4  | M.2 *2  | AIOM Card   |   |

### 3.3 Step-by-Step Disassembly Instructions

#### 1. Removing Cable and Chassis Top Cover

1. Use the operating system to power down the system.
2. After the system has completely shut-down, disconnect the power cords from the power supply modules.
3. Remove all cables/ unit from the server IO port.

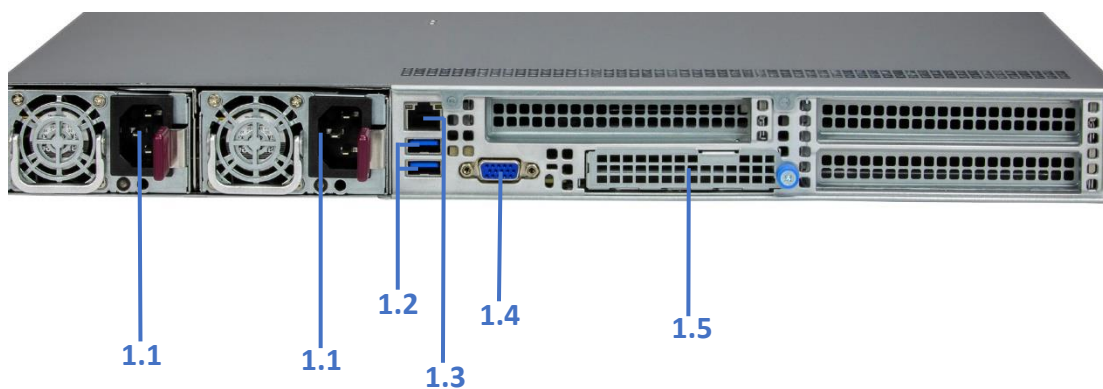



4. The chassis top cover can be lifted off after pressing down on the release button and lifting the cover off.

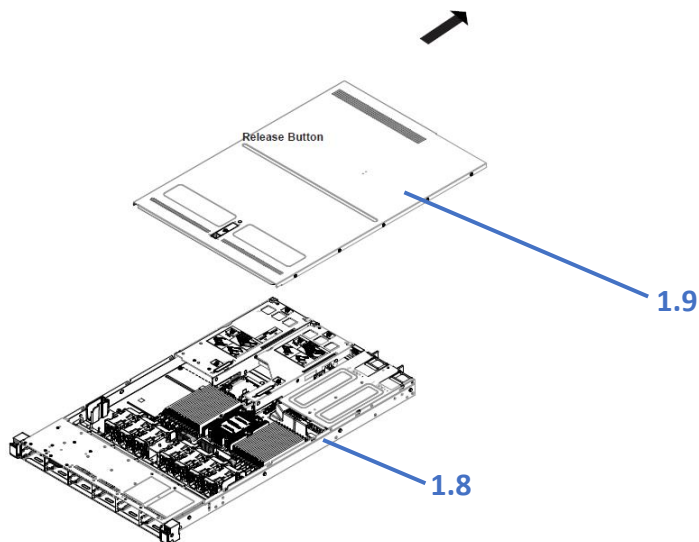

| No.                 | Description                   | No. | Description |
|---------------------|-------------------------------|-----|-------------|
| <a href="#">1.1</a> | Power Cable                   | 1.8 | Chassis     |
| 1.2                 | USB 3.0 Ports                 | 1.9 | Top Cover   |
| 1.3                 | BMC LAN Port                  |     |             |
| 1.4                 | VGA Port                      |     |             |
| 1.5                 | PCIe 5.0 x16 AIOM Slot (NCSI) |     |             |

## 2. Removing Hard Disk Drive (HDD) / Solid State Drive (SDD)

1. Press the release button to extend the drive carrier handle.
2. Use the drive carrier handle to pull the drive out of the chassis.

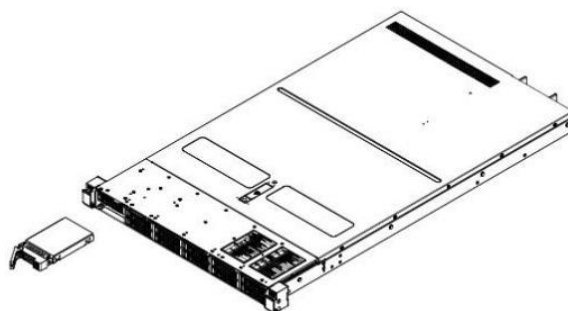
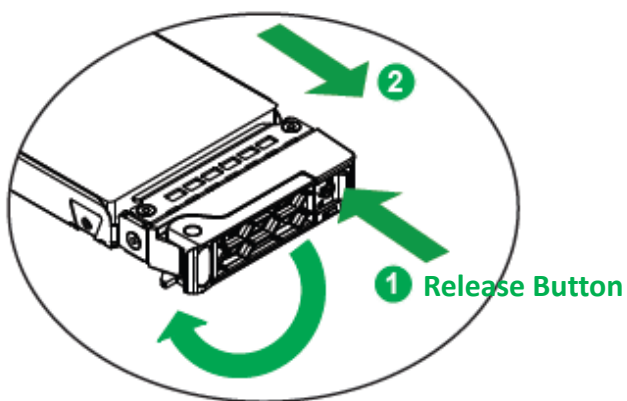

3. Unscrew the two screws holding the drive in place.

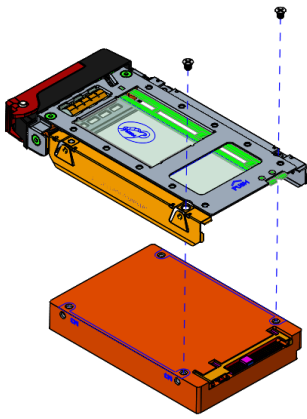

2.1

4. Push the drive from the opening below (circled in red) to release the drive from the tray.



5. Use a cross screwdriver to remove the drive enclosure.



2.2

6. Use a cross screwdriver to remove screws and lift off the PCB

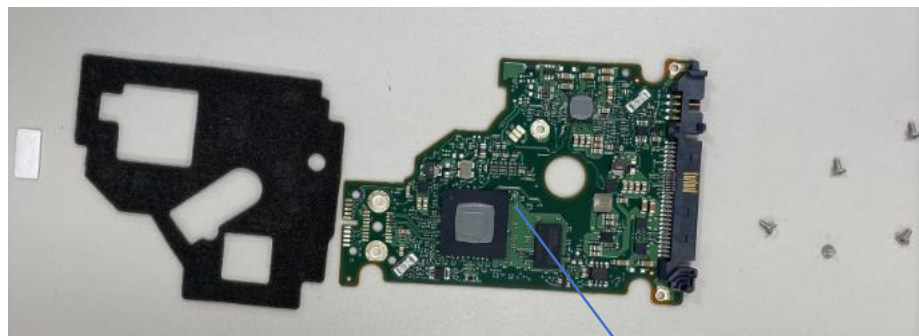

2.3

| No.                 | Description          |
|---------------------|----------------------|
| 2.1                 | HDD/ SSD             |
| 2.2                 | Hard Drive Enclosure |
| <a href="#">2.3</a> | Hard Drive PCB       |

### 3. Removing Power Supply

1. Push the release tab back on the power supply.
2. Use the handle to gently slide the power supply out the back of the chassis.

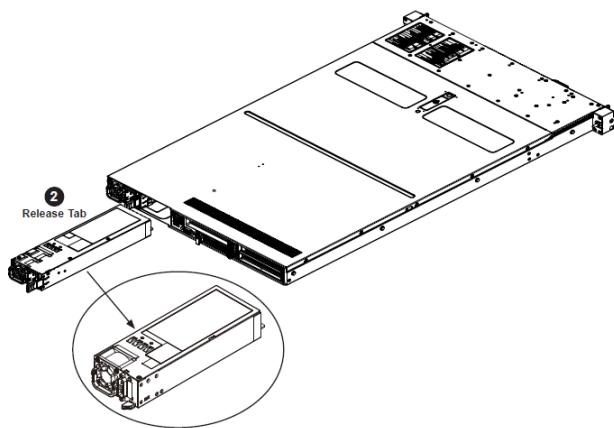

3.2

3. Remove the screw from the enclosure



3.1



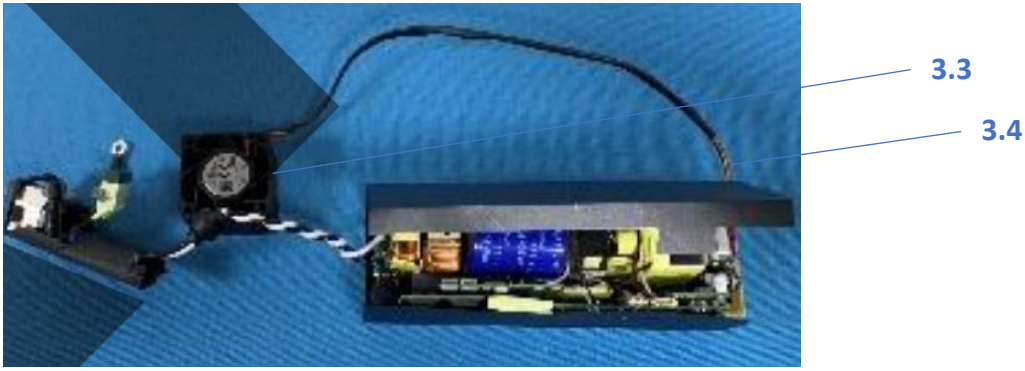

4. Cut the power leads connected to the fan and lift the main board from the chassis

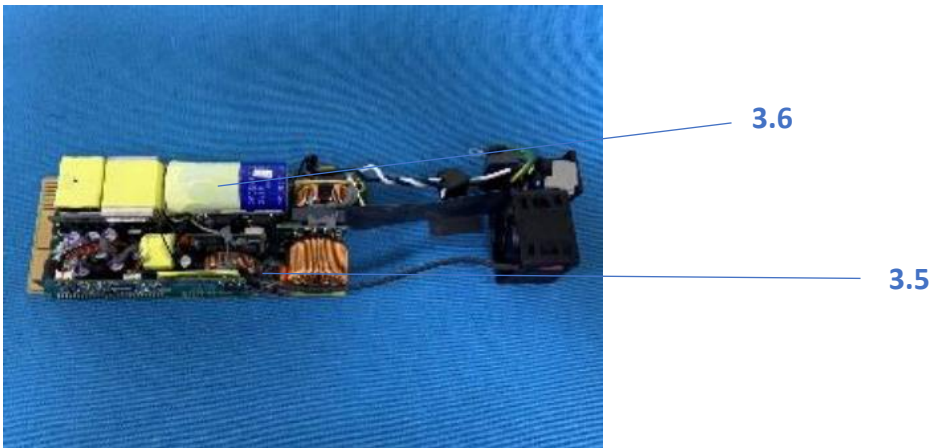

5. Use a flathead screwdriver to cut the capacitor adhesive and pin solder.



| No.                 | Description      |
|---------------------|------------------|
| 3.1                 | Power Supply     |
| 3.2                 | Power Enclosure  |
| 3.3                 | Fan              |
| 3.4                 | Fan Cable        |
| <a href="#">3.5</a> | Power Module PCB |
| <a href="#">3.6</a> | Capacitor        |

## 4. Removing Advanced I/O (AIOM) Network Card

1. Loosen the thumbscrew (circled in red) using your hand.



2. Slide the AIOM out of the opening.

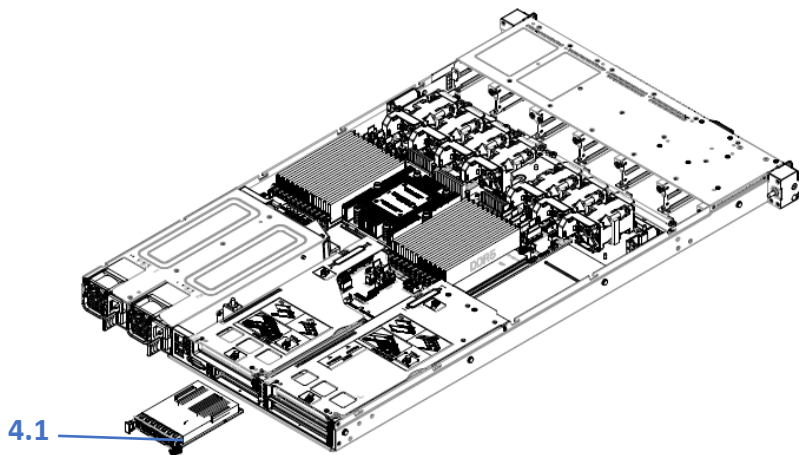

| No.                 | Description       |
|---------------------|-------------------|
| <a href="#">4.1</a> | AIOM Network Card |

## 5. Removing AIOM Cable

1. Unscrew the two screws (circled in red) using a screwdriver and loosen the thumb screw by hand.

2. Remove the cable from the motherboard.

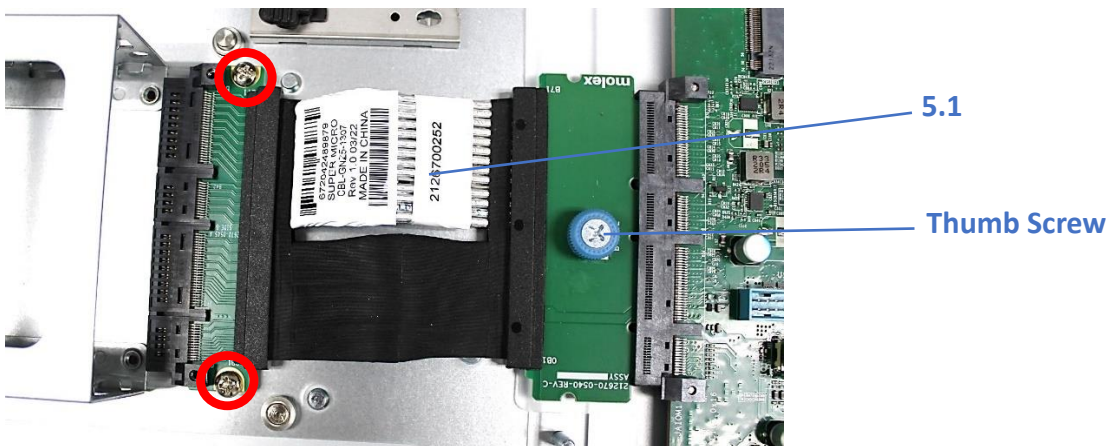

| No.                 | Description |
|---------------------|-------------|
| <a href="#">5.1</a> | AIOM Cable  |

## 6. Removing Add-on Module (AOM)

1. Loosen the thumbscrew shown below.
2. Slide the AOM away from the rear and lift the AOM out of the system.

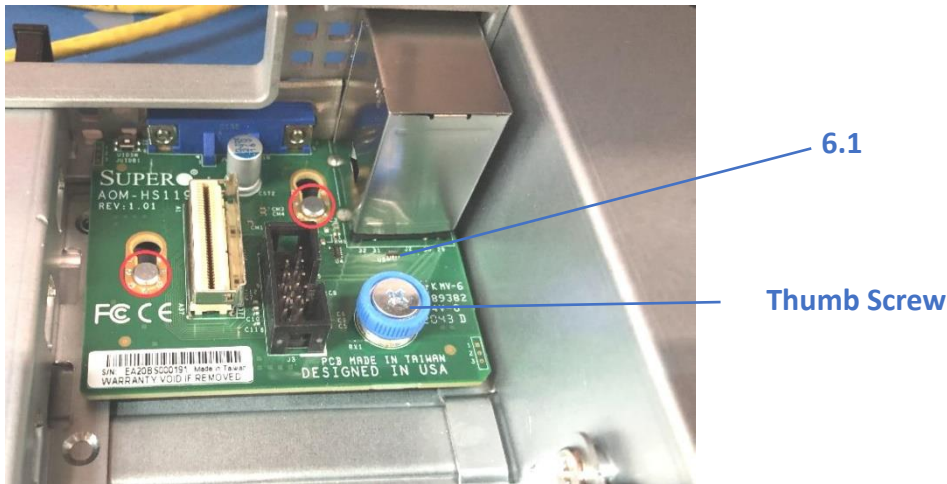

| No.                 | Description   |
|---------------------|---------------|
| <a href="#">6.1</a> | Add-on Module |

## 7. Removing Fan

1. Pull on the fan using the fan tab (circled in red) and lift the fan up and out of the chassis for each fan; disconnecting the fan from the motherboard.
2. When removing Fan 8, be sure to unplug the cable from the motherboard as it is not-hot plug fan.

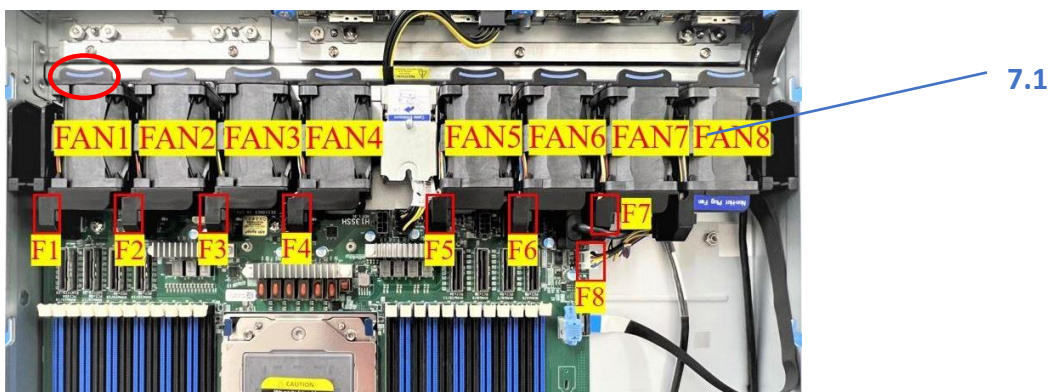

| No. | Description  |
|-----|--------------|
| 7.1 | Cooling Fans |

## 8. Removing Backplane

1. Ensure all the cables are disconnected and pull the backplane bracket out of the chassis.
2. Unscrew the 3 thumbscrews by hand (circled in red) and 3 screws holding the backplane using a screwdriver (circled in yellow) as shown below to remove the backplane from the system.

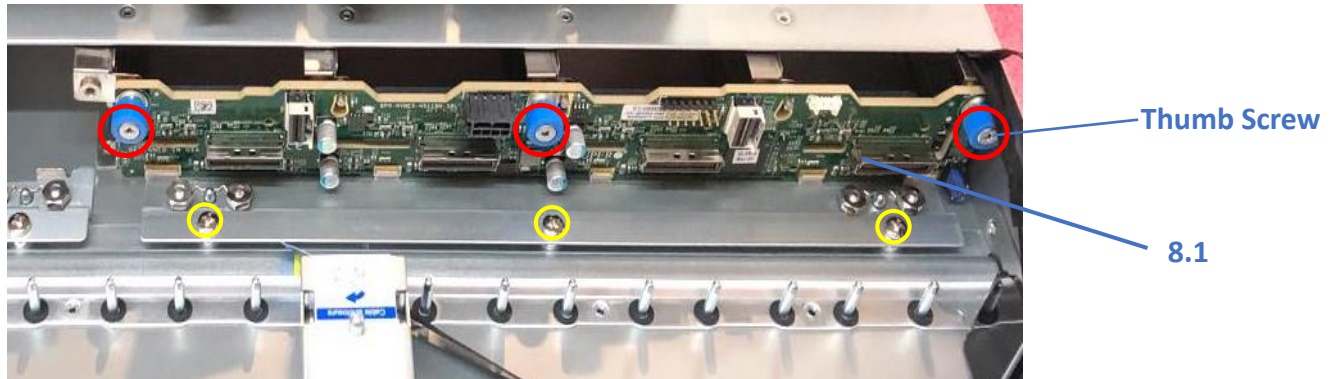

| No.                 | Description |
|---------------------|-------------|
| <a href="#">8.1</a> | Backplane   |

## 9. Removing the Riser Bracket and Riser Card

1. Disconnect any cables connecting the riser cards to the system.
3. Lift the riser card bracket out from the chassis
4. Unscrew the thumb screw holding the riser card and remove the riser card from the bracket.

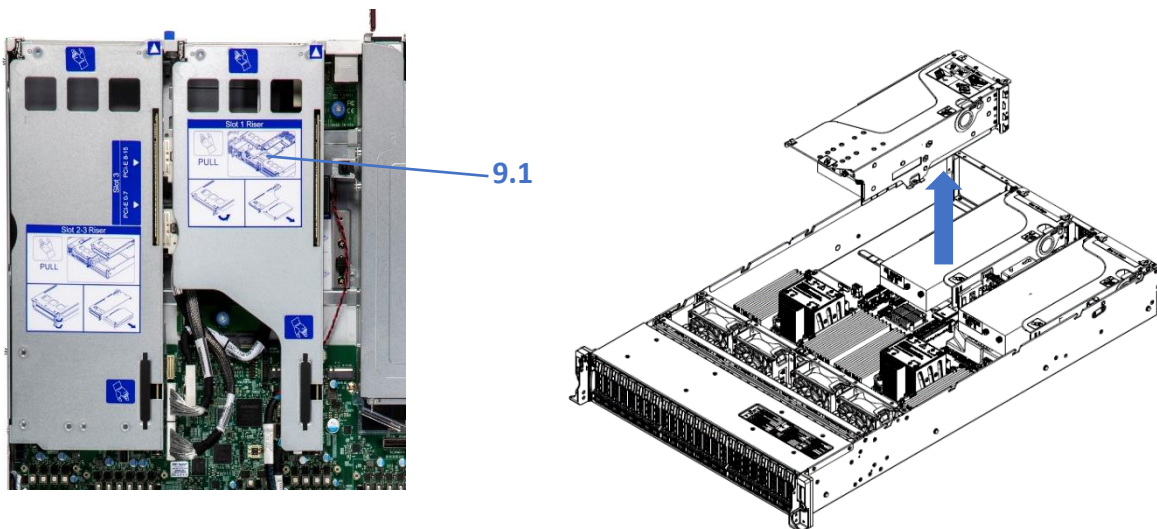

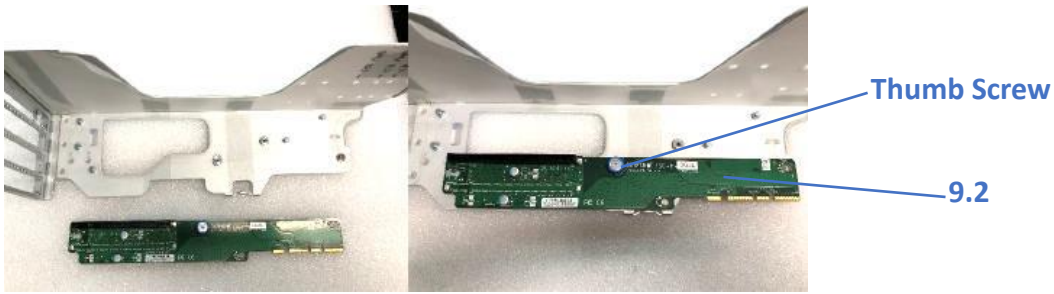

| No.                 | Description        |
|---------------------|--------------------|
| 9.1                 | Riser Card Bracket |
| <a href="#">9.2</a> | Riser Cards        |

## 10. Removing Processor

1. Removing the PHM (Processor Heatsink Module) from the motherboard, first shut down the system and unplug the AC power cord from all power supplies
2. Use a T30-bit screwdriver to loosen the four peek nuts on the heatsink in the sequence of 6,5,4,3,2,1, as shown in the picture below:

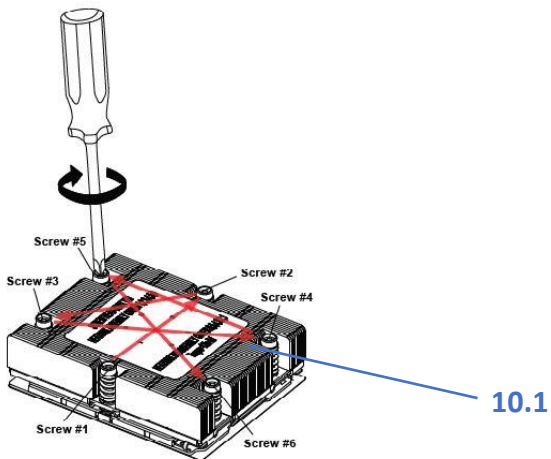

3. Once the screws have been removed, lift the heatsink module off the socket.
4. Loosen the socket screw.

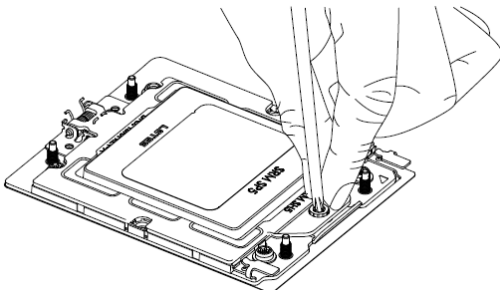

5. Gently remove the processor from the socket.



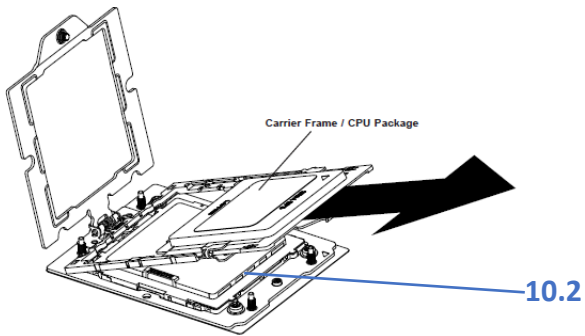

**Note:** Please handle the processor with care to avoid damaging it or its pins

| No.                  | Description |
|----------------------|-------------|
| 10.1                 | Heat Sink   |
| <a href="#">10.2</a> | Processor   |

## 11. Removing DIMM

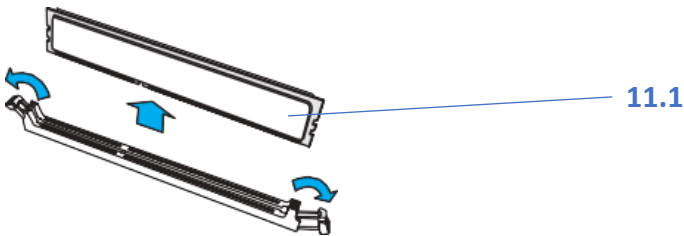

1. Hand press both release tabs on the ends of the DIMM module to unlock it
2. Once the DIMM module is loose, remove it from the memory slot

| No.                  | Description |
|----------------------|-------------|
| <a href="#">11.1</a> | DIMM        |

## 12. Removing the Network Card

- 1.- Find the slot 1 and remove the gold finger and unlock the hock.

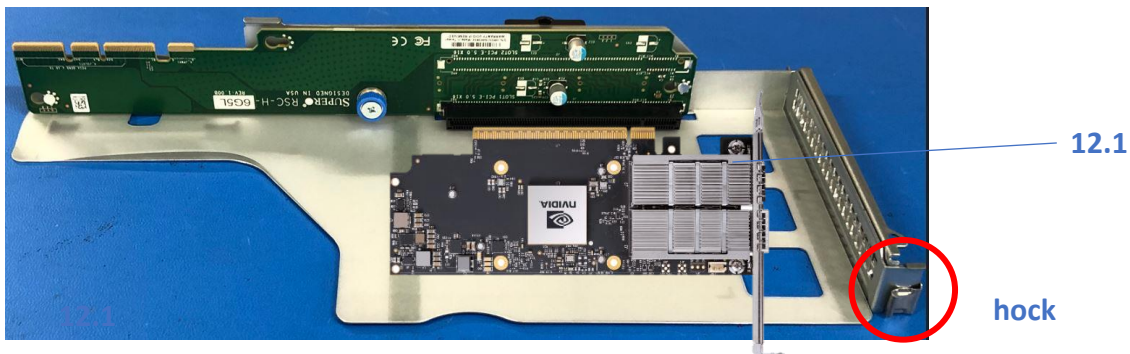

| No.                  | Description  |
|----------------------|--------------|
| <a href="#">12.1</a> | Network Card |

### 13. Removing the M.2 from the Motherboard

1. Locate the M.2 on the motherboard at the J7 connector and press down on the clip holding the M.2 in place.
2. Gently pull the M.2 out of the socket.

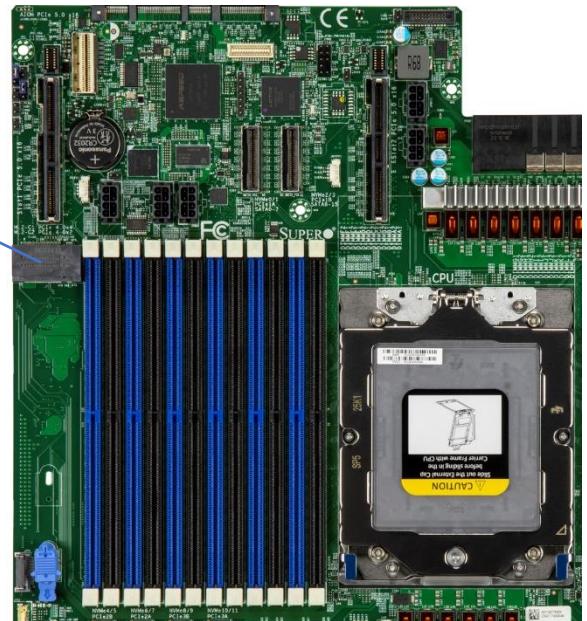
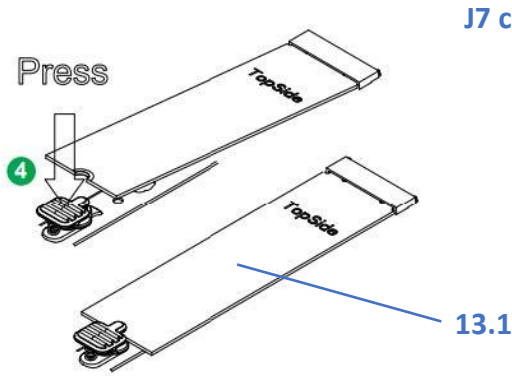

| No.                  | Description |
|----------------------|-------------|
| <a href="#">13.1</a> | M.2         |

### 14. Removing the Power Supply Shroud and Air Shroud

1. Locate the Power Supply Shroud on the motherboard and lift it out of the system using the latch.



2. Locate the Air Shroud on top of the DIMM slots and CPU and pull them out of the system.

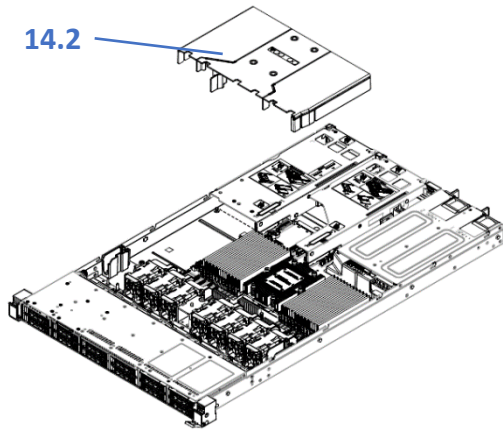

| No.  | Description         |
|------|---------------------|
| 14.1 | Power Supply Shroud |
| 14.2 | Air Shroud          |

## 15. Removing Motherboard

1. Unscrew the screws (circled in red) on the motherboard and lift the motherboard out of the chassis.
2. Push aside the small clamp that covers the edge of the battery. When the battery is released, lift it out of the holder.

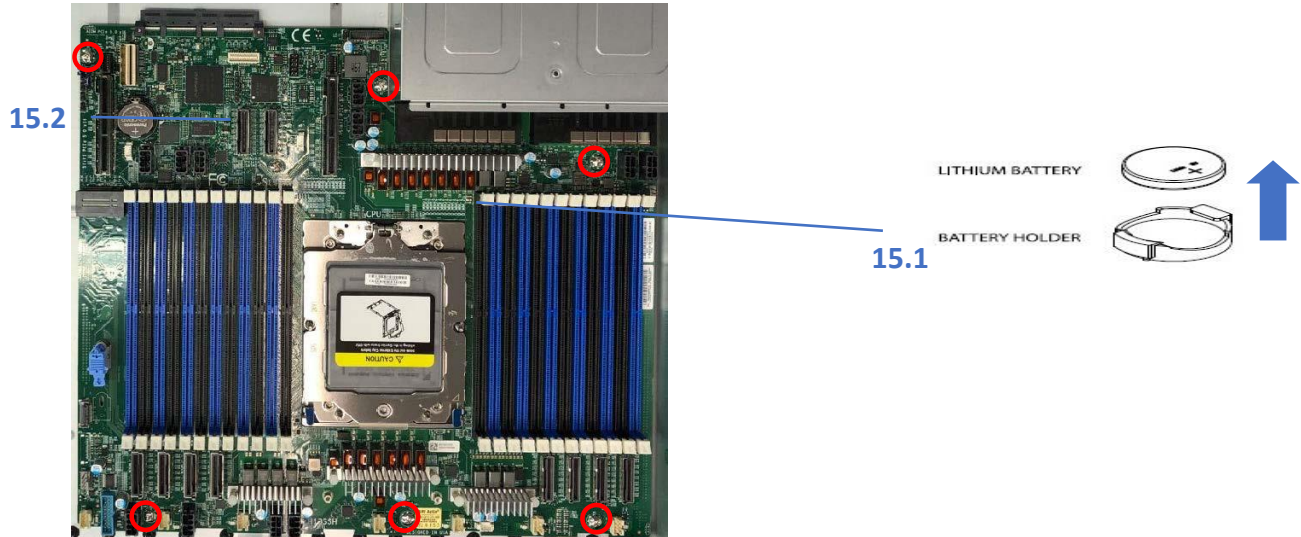

| No.                  | Description |
|----------------------|-------------|
| <a href="#">15.1</a> | Motherboard |
| <a href="#">15.2</a> | Battery     |

When all the steps are complete, the chassis enclosure can be recycled.