

**SUPER**  <sup>®</sup>

**SUPER**  <sup>®</sup> X8DAL-3  
**SUPER**  <sup>®</sup> X8DAL-i

# USER'S MANUAL

Revision 1.1b

---

The information in this User's Manual has been carefully reviewed and is believed to be accurate. The vendor assumes no responsibility for any inaccuracies that may be contained in this document, makes no commitment to update or to keep current the information in this manual, or to notify any person or organization of the updates. **Please Note: For the most up-to-date version of this manual, please see our website at [www.supermicro.com](http://www.supermicro.com).**

Super Micro Computer, Inc. ("Supermicro") reserves the right to make changes to the product described in this manual at any time and without notice. This product, including software and documentation, is the property of Supermicro and/or its licensors, and is supplied only under a license. Any use or reproduction of this product is not allowed, except as expressly permitted by the terms of said license.

IN NO EVENT WILL SUPER MICRO COMPUTER, INC. BE LIABLE FOR DIRECT, INDIRECT, SPECIAL, INCIDENTAL, SPECULATIVE OR CONSEQUENTIAL DAMAGES ARISING FROM THE USE OR INABILITY TO USE THIS PRODUCT OR DOCUMENTATION, EVEN IF ADVISED OF THE POSSIBILITY OF SUCH DAMAGES. IN PARTICULAR, SUPER MICRO COMPUTER, INC. SHALL NOT HAVE LIABILITY FOR ANY HARDWARE, SOFTWARE, OR DATA STORED OR USED WITH THE PRODUCT, INCLUDING THE COSTS OF REPAIRING, REPLACING, INTEGRATING, INSTALLING OR RECOVERING SUCH HARDWARE, SOFTWARE, OR DATA.

Any disputes arising between manufacturer and customer shall be governed by the laws of Santa Clara County in the State of California, USA. The State of California, County of Santa Clara shall be the exclusive venue for the resolution of any such disputes. Supermicro's total liability for all claims will not exceed the price paid for the hardware product.

---

FCC Statement: This equipment has been tested and found to comply with the limits for a Class A digital device pursuant to Part 15 of the FCC Rules. These limits are designed to provide reasonable protection against harmful interference when the equipment is operated in a commercial environment. This equipment generates, uses, and can radiate radio frequency energy and, if not installed and used in accordance with the manufacturer's instruction manual, may cause harmful interference with radio communications. Operation of this equipment in a residential area is likely to cause harmful interference, in which case you will be required to correct the interference at your own expense.

---

California Best Management Practices Regulations for Perchlorate Materials: This Perchlorate warning applies only to products containing CR (Manganese Dioxide) Lithium coin cells. "Perchlorate Material-special handling may apply. See [www.dtsc.ca.gov/hazardouswaste/perchlorate](http://www.dtsc.ca.gov/hazardouswaste/perchlorate)".

**WARNING:** Handling of lead solder materials used in this product may expose you to lead, a chemical known to the State of California to cause birth defects and other reproductive harm.

---

Manual Revision 1.1b

Release Date: Aug. 16, 2011

Unless you request and receive written permission from Super Micro Computer, Inc., you may not copy any part of this document.

Information in this document is subject to change without notice. Other products and companies referred to herein are trademarks or registered trademarks of their respective companies or mark holders.

Copyright © 2011 by Super Micro Computer, Inc.  
All rights reserved.

**Printed in the United States of America**

## Preface

### About this Manual

This manual is written for system integrators, PC technicians and knowledgeable PC users. It provides information for the installation and use of the **SUPER** X8DAL-3/X8DAL-i motherboard.

### About this Motherboard

The **SUPER** X8DAL-3/X8DAL-i supports the Intel® 5500/5600 Series Processor platform, the first dual-processing platform that supports the Intel QuickPath Interconnect (QPI) Technology, providing the next generation point-to-point system interface to replace the current Front Side Bus. With the Intel 5500 chipset built in, the X8DAL-3/X8DAL-i substantially enhances system performance with increased bandwidth and scalability, optimized for CAD workstations or graphic intensive systems. Please refer to our web site (<http://www.supermicro.com/products/>) for processor and memory support updates. This product is intended to be installed and serviced by professional technicians.

### Manual Organization

**Chapter 1** describes the features, specifications and performance of the motherboard and provides detailed information about the chipset.

**Chapter 2** provides hardware installation instructions. Read this chapter when installing the processor, memory modules and other hardware components into the system. If you encounter any problems, see **Chapter 3**, which describes troubleshooting procedures for video, memory and system setup stored in the CMOS.

**Chapter 4** includes an introduction to the BIOS and provides detailed information on running the CMOS Setup utility.

**Appendix A** lists BIOS POST Error Codes. **Appendix B** and **Appendix C** provide the Windows OS and Other Software Installation Instructions.

### Conventions Used in the Manual

Special attention should be given to the following symbols for proper installation and to prevent damage done to the components or injury to yourself:



**Danger/Caution:** Instructions to be strictly followed to prevent catastrophic system failure or to avoid bodily injury.



**Warning:** Important information given to ensure proper system installation or to prevent damage to the components.



**Note:** Additional Information given to differentiate various models or to ensure correct system setup.

## Contacting Supermicro

### Headquarters

Address: Super Micro Computer, Inc.  
980 Rock Ave.  
San Jose, CA 95131 U.S.A.

Tel: +1 (408) 503-8000

Fax: +1 (408) 503-8008

Email: marketing@supermicro.com (General Information)  
support@supermicro.com (Technical Support)

Web Site: www.supermicro.com

### Europe

Address: Super Micro Computer B.V.  
Het Sterrenbeeld 28, 5215 ML  
's-Hertogenbosch, The Netherlands

Tel: +31 (0) 73-6400390

Fax: +31 (0) 73-6416525

Email: sales@supermicro.nl (General Information)  
support@supermicro.nl (Technical Support)  
rma@supermicro.nl (Customer Support)

### Asia-Pacific

Address: Super Micro Computer, Inc.  
4F, No. 232-1, Liancheng Rd.  
Chung-Ho 235, Taipei County  
Taiwan, R.O.C.

Tel: +886-(2) 8226-3990

Fax: +886-(2) 8226-3991

Web Site: www.supermicro.com.tw

Technical Support:

Email: support@supermicro.com.tw

Tel: +886-(2) 8226-5990

---

---

## Table of Contents

### ***Preface***

### ***Chapter 1 Introduction***

1-1	Overview .....	1-1
1-2	Chipset Overview .....	1-9
1-3	Special Features .....	1-10
1-4	PC Health Monitoring (w/SDII or SDIII) .....	1-10
1-5	ACPI Features.....	1-11
1-6	Power Supply .....	1-11
1-7	Super I/O.....	1-12

### ***Chapter 2 Installation***

2-1	Static-Sensitive Devices.....	2-1
	Precautions .....	2-1
	Unpacking .....	2-1
2-2	Motherboard Installation.....	2-2
	Tools Needed .....	2-2
	Installation Instructions.....	2-2
2-3	Processor and Heatsink Installation.....	2-3
	Installing a CPU Heatsink .....	2-5
2-4	Memory Installation .....	2-7
2-5	Control Panel Connectors/IO Ports.....	2-11
	1. Back Panel Connectors/IO Ports.....	2-11
	ATX PS/2 Keyboard and PS/2 Mouse Ports.....	2-12
	Universal Serial Bus (USB).....	2-13
	Serial Ports.....	2-14
	Ethernet Ports .....	2-15
	(Back_Panel) High Definition Audio (HD Audio) .....	2-16
	CD Header .....	2-16
	Front Panel Audio.....	2-17
	2. Front Control Panel.....	2-18
	3. Front Control Panel Pin Definitions .....	2-19
	NMI Button .....	2-19
	Power LED .....	2-19
	HDD LED.....	2-20
	NIC1/NIC2 LED Indicators .....	2-20
	Overheat (OH)/Fan Fail.....	2-21
	Power Fail LED .....	2-21

	Reset Button .....	2-22
	Power Button .....	2-22
2-6	Connecting Cables.....	2-23
	Power Connectors .....	2-23
	Fan Headers.....	2-24
	Chassis Intrusion .....	2-24
	Internal Speaker.....	2-25
	Power LED/Speaker.....	2-25
	Overheat LED/Fan Fail (JOH1).....	2-26
	Power SMB (I <sup>2</sup> C) Connector .....	2-26
	T-SGPIO 1/2 & 3-SGPIO 1/2 Headers.....	2-27
	I-Button.....	2-27
2-7	Jumper Settings .....	2-28
	Explanation of Jumpers .....	2-28
	GLAN Enable/Disable .....	2-28
	CMOS Clear.....	2-29
	Watch Dog Enable/Disable .....	2-29
	I <sup>2</sup> C Bus to PCI-Exp. Slots .....	2-30
	Audio Enable .....	2-30
	SAS Enable/Disable (X8DAL-3 only) .....	2-31
	SAS RAID Mode Select (X8DAL-3) .....	2-31
	USB Wake-Up .....	2-32
2-8	Onboard LED Indicators .....	2-33
	GLAN LEDs.....	2-33
	Onboard Power LED .....	2-34
	SAS Heartbeat LED (X8DAL-3) .....	2-34
2-9	Serial ATA and SAS Connections .....	2-35
	Serial ATA Ports.....	2-35
	SAS Ports (X8DAL-3 only).....	2-35

### **Chapter 3 Troubleshooting**

3-1	Troubleshooting Procedures .....	3-1
	Before Power On .....	3-1
	No Power .....	3-1
	No Video .....	3-2
	Losing the System's Setup Configuration.....	3-2
	Memory Errors .....	3-2
3-2	Technical Support Procedures .....	3-3
3-3	Frequently Asked Questions .....	3-3
3-4	Returning Merchandise for Service.....	3-4

**Chapter 4 BIOS**

4-1	Introduction.....	4-1
4-2	Main Setup .....	4-2
4-3	Advanced Setup Configurations.....	4-3
4-4	Security Settings .....	4-20
4-5	Boot Configuration .....	4-21
4-6	Exit Options.....	4-23

**Appendix A BIOS Error Beep Codes**

A-1	BIOS Error Beep Codes .....	A-1
-----	-----------------------------	-----

**Appendix B Installing the Windows OS**

B-1	Installing the Windows OS to a RAID System.....	B-1
B-2	Installing the Windows OS to a Non-RAID System.....	B-2

**Appendix C Software Installation Instructions**

C-1	Installing Software Programs.....	C-1
C-2	Configuring Supero Doctor III .....	C-2



# Chapter 1

## Introduction

### 1-1 Overview

#### Checklist

Congratulations on purchasing your computer motherboard from an acknowledged leader in the industry. Supermicro boards are designed with the utmost attention to detail to provide the highest standards in quality and performance. Check that the following items have all been included with your motherboard. If anything listed here is damaged or missing, contact your retailer.

The following items are included in the retail box.

- One (1) Supermicro Mainboard
- Six (6) Serial ATA cables (CBL-0044L) (For X8DAL-i)
- Eight (8) Serial ATA cables (CBL-0044L) (For X8DAL-3)
- One (1) I/O backpanel shield (MCP-260-74301-0N)
- One (1) Supermicro CD containing drivers and utilities
- One (1) User's/BIOS Manual

SUPER<sup>®</sup> X8DAL-3/X8DAL-i Image

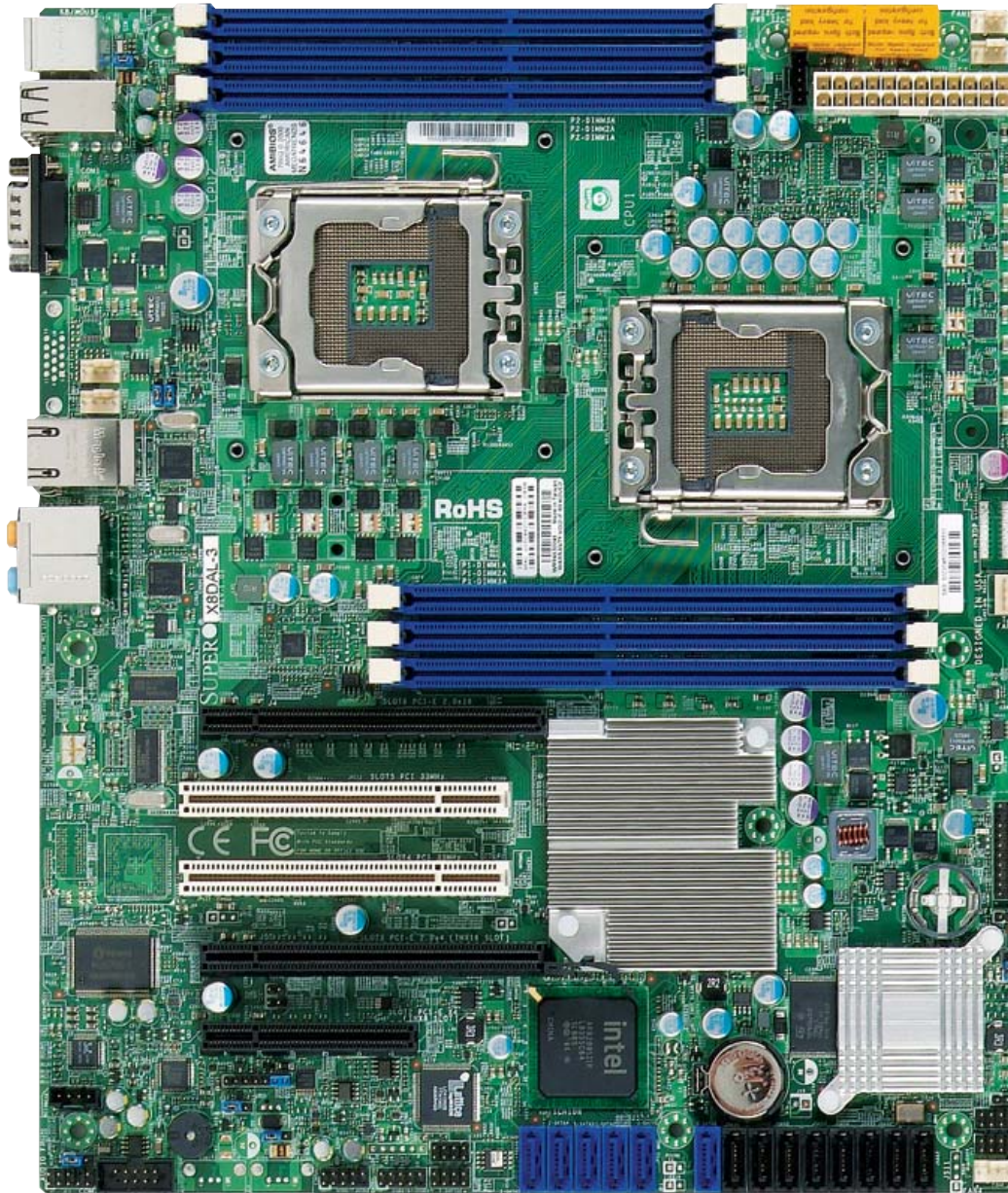

 **Note:** The drawings and pictures shown in this manual were based on the latest PCB Revision available at the time of publishing of the manual. The motherboard you've received may or may not look exactly like the graphics shown in the manual.

## SUPER<sup>®</sup> X8DAL-3/X8DAL-i Layout

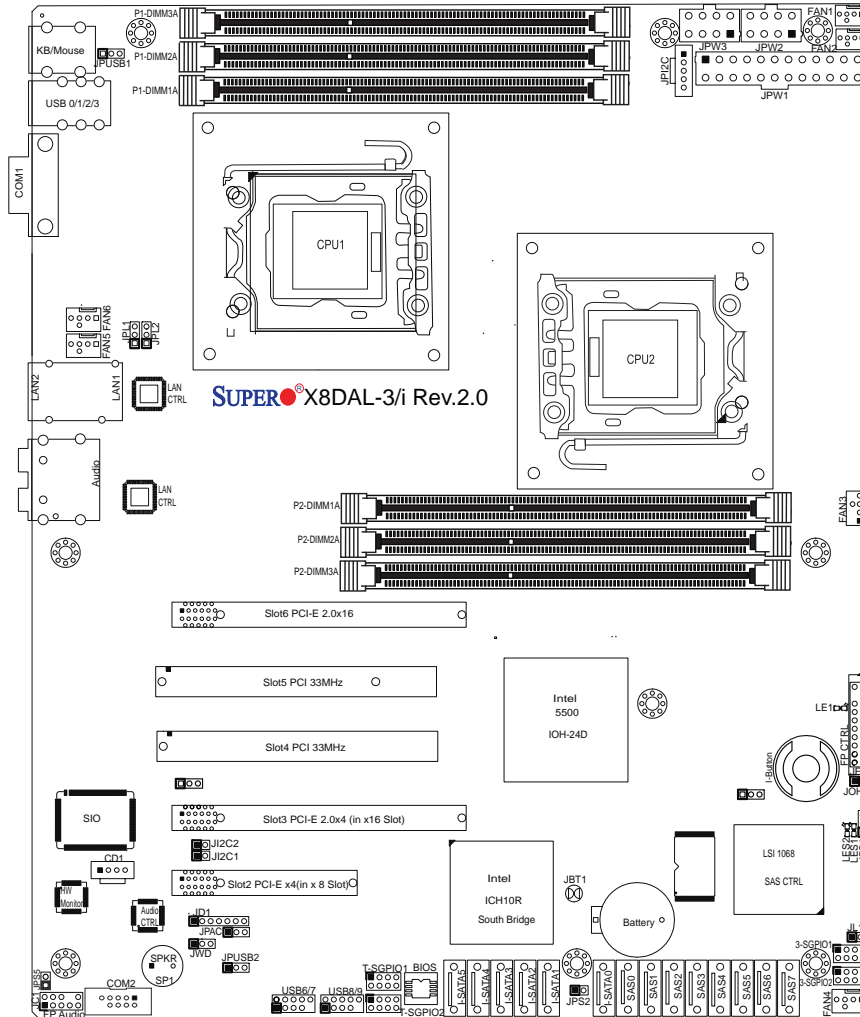

### Differences between X8DAL-3/X8DAL-i

	X8DAL-3	X8DAL-i
SATA (ICH10R)	Yes	Yes
SAS (1068E)	Yes	No
3-SGPIO 1/2	Yes	No
T-SGPIO 1/2	Yes	Yes



#### Note

SAS Ports, SAS jumpers, and the LSI 1068E chip are available on the X8DAL-3 only. For SAS RAID configuration, refer to the LSI User Guide posted on our website @ <http://www.supermicro.com/support/manuals/>

X8DAL-3/X8DAL-i Quick Reference

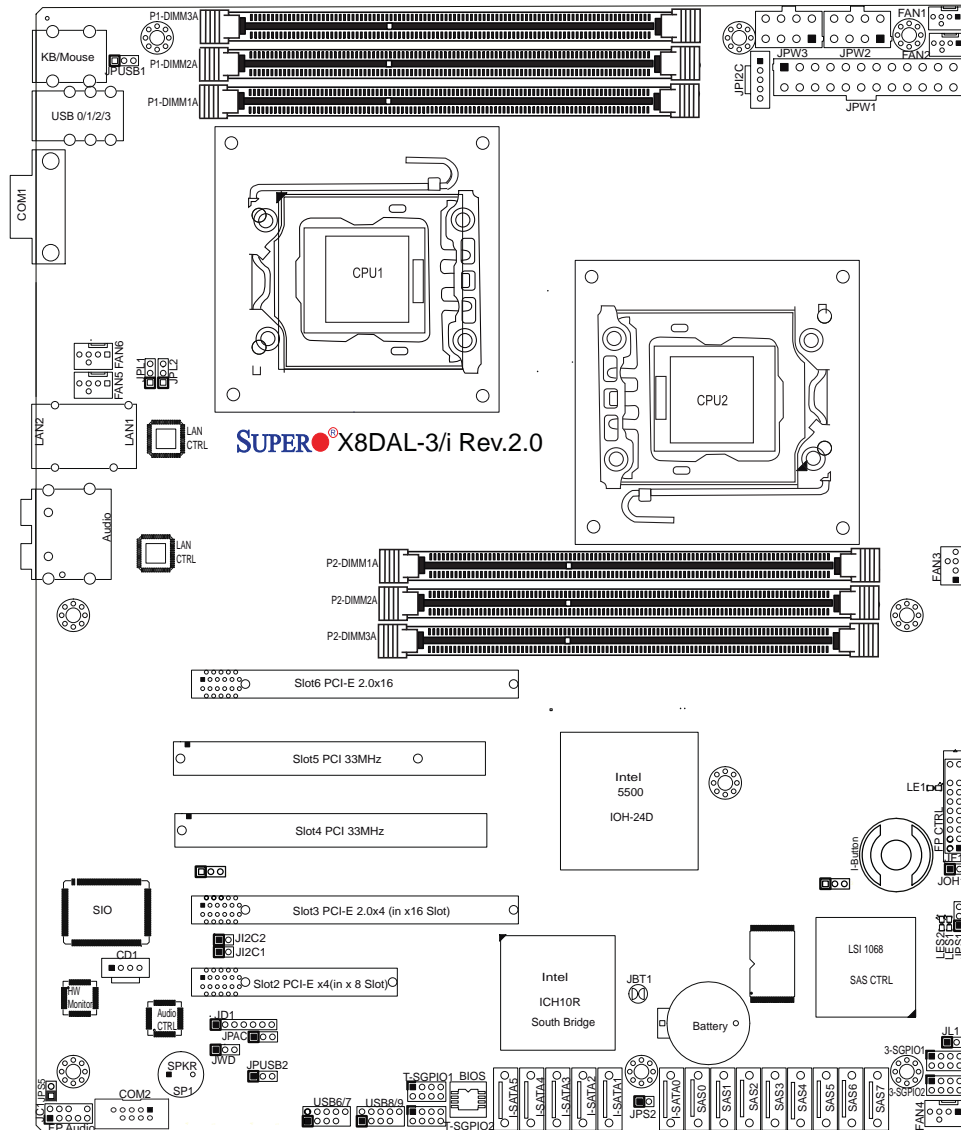

 **Notes**

1. Jumpers not indicated are for test purposes only.
2. " ■ " indicates the location of Pin 1.
3. When LE1 is on, the onboard power connection is on. Make sure to unplug the power cables before removing or installing components.

 **Warning!** 1. To prevent damage to the power supply or motherboard, please use a power supply that contains a 24-pin and two 8-pin power connectors. Be sure to connect these connectors to the 24-pin (JPW1) and the two 8-pin (JPW2,JPW3) power connectors on the motherboard. Failure in doing so will void the manufacturer warranty on your power supply and motherboard.

2. To avoid possible system overheating, be sure to provide adequate airflow to the system.

**X8DAL-3/X8DAL-i Quick Reference**

<b>Jumper</b>	<b>Description</b>	<b>Default Setting</b>
JBT1	CMOS Clear	Open (Normal)
JI <sup>2</sup> C1/JI <sup>2</sup> C2	SMB to PCI/PCI-E Slots	Open/Open (Disabled)
JPAC1	Audio Enabled	Pins 1-2 (Enabled)
JPL1/JPL2	LAN1/2 Enable	Pins 1-2 (Enabled)
JPS1	SAS Enable	Pins 1-2 (Enabled) (X8DAL-3)
JPS2	SAS RAID Mode Select	Closed (SR RAID) (X8DAL-3)
JPUSB1	Backpanel USB Wake-Up	Pins 1-2 (Enabled)
JPUSB2	Front Access USB Wake-Up	Pins 2-3 (Disabled)
JWD	Watch Dog	Pins 1-2 (Reset)

<b>Connector</b>	<b>Description</b>
Audio/CD1/JC1	Audio Input_Output_Mic/CD-ROM/HD Audio Headers
COM1/COM2	COM1/COM2 Serial Port/Header
FAN 1-6	System/CPU Fan Headers (Fans 1~2: CPU Fans)
I-Button	I-Button for HostRAID Storage (X8DAL-3)
JD1	PWR LED/Speaker Header (Pins 4~7: Speaker)
JF1	Front Panel Connector
JL1	Chassis Intrusion Header
JOH1	Overheat LED Header
JPI <sup>2</sup> C	Power Supply SMBbus I <sup>2</sup> C Header
JPW1, JPW2/JPW3	24-pin ATX PWR, 8-pin Secondary PWR (See Page 1-4)
LAN1/LAN2	G-LAN (RJ45) Ports
SAS 0~7	SAS Ports 0~7 (X8DAL-3 only)
I-SATA0 ~ I-SATA5	(Intel South Bridge) SATA Ports
SP1	Speaker/Internal Buzzer
3-SGPIO-1/3-SGPIO-2	Serial General Purpose I/O Headers for SAS (X8DAL-3)
T-SGPIO-1/T-SGPIO-2	Serial General Purpose I/O Headers for SATA
USB 0~3	Backplane Universal Serial Bus (USB) Ports
USB 6/7, 8/9	Front Panel USB Connections

<b>LED</b>	<b>Description</b>
LE1	Onboard Standby LED Indicator
LES2	SAS Heartbeat LED (X8DAL-3)



## **Motherboard Features**

### **CPU**

- Two Intel® 5500/5600 Series (LGA 1366) processors, each processor supporting two full-width Intel QuickPath Interconnect (QPI) @6.4 GT/s with a total of up to 51.2 GB/s Data Transfer Rate (6.4 GB/s per direction)

### **Memory**

- Six 240-pin DIMM sockets support up to 96 GB of Registered ECC or 24 GB Unbuffered ECC/Non-ECC DDR3 1333 MHz/1066 MHz/800 MHz Memory (See Section 2-4 in Chapter 2 for DIMM Slot Population.)

### **Chipset**

- Intel 5500 chipset, including: the 5500 North Bridge and the ICH10R South Bridge.

### **Expansion Slots**

- One PCI-E 2.0 x16 slot (Slot 6)
- One PCI-E 2.0 x4 slot in x16 slot (Slot 3)
- One PCI-E x4 (in x8) slots (Slot 2)
- Two 32-bit PCI 33 slots (Slot 4 and Slot 5)

### **BIOS**

- 4 MB AMI SPI Flash ROM
- PCI 2.2, DMI 2.3, ACPI 1.0/2.0/3.0, Plug and Play (PnP), DMI 2.3, USB Keyboard support, and SMBIOS 2.3

### **PC Health Monitoring**

- Onboard voltage monitors for Vcore1, Vcore2, 1.5V, 5VDD, 5VSB, 12V, -12V, 3.3Vcc, 3.3VSB, VBAT and Vtt.
- Fan status monitor with firmware control
- Tachometer Monitoring
- Pulse Width Modulation (PWM) fan control.
- Low-noise fan speed control
- CPU/chassis temperature monitoring
- Platform Environment Control Interface (PECI) ready
- Thermal Monitor 2 (TM2) support
- CPU fan auto-off in sleep mode
- CPU slow-down on temperature overheat
- CPU thermal trip support for processor protection, power LED
- Power-up mode control for recovery from AC power loss
- Auto-switching voltage regulator for CPU cores

- System overheat/Fan Fail LED Indicator and control
- Chassis intrusion detection/header
- System resource alert via Supero Doctor III

### **ACPI Features**

- Slow blinking LED for suspend state indicator
- Main switch override mechanism
- ACPI/ACPM Power Management

### **Onboard I/O**

- Intel ICH10R supports six SATA2 ports (with RAID0, RAID1, RAID10, RAID5 supported in the Windows OS Environment, and RAID0, RAID1, RAID10 supported in the Linux platforms) (**Note 1**)
- LSI 1068E supports eight SAS ports with RAID 5 support optional w/AOC-ibutton68 (For X8DAL-3) (**Note 2**)
- Dual 82574LGigabit Ethernet controllers support two Giga-bit LAN ports
- HD ALC883 Audio Controller supports High Definition 7.1 Audio with Line-in, Line-out and Microphone
- One COM port and one Serial Header
- PS/2 mouse and PS/2 keyboard ports
- Up to Eight USB 2.0 connections (4 Backpanel USB Ports, and 2 Headers w/4 connections supported)
- Super I/O: Winbond W83627DHG-P

### **Other**

- Console redirection
- Onboard Fan Speed Control by Thermal Management via BIOS

### **CD/Diskette Utilities**

- BIOS flash upgrade utility and device drivers

### **Dimensions**

- Ext. ATX 12.00" (L) x 10.00" (W) (304.80 mm x 254.20 mm)



**Note 1:** For more information on SATA HostRAID configuration, please refer to the Intel SATA HostRAID User's Guide posted on our website @ <http://www.supermicro.com/support/manuals/>.

**Note 2:** For more information on LSI SAS RAID configuration, please refer to the LSI MegaRAID User's Guide posted on our website @ <http://www.supermicro.com/support/manuals/>.

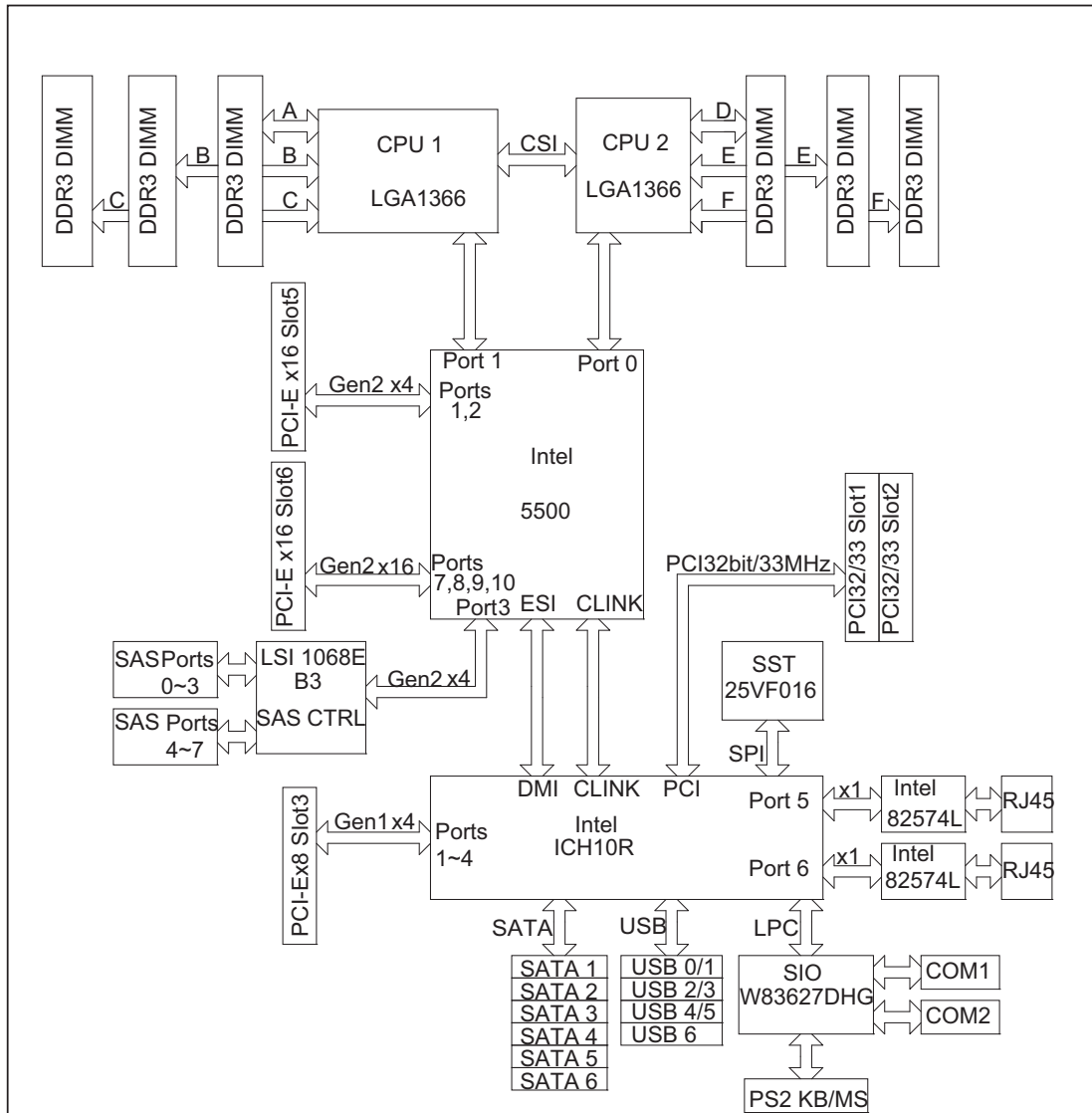

### Block Diagram of the Intel 5500 Chipset Platform

 **Note:** This is a general block diagram. Please see the previous Motherboard features pages for details on the features of each motherboard.



## 1-2 Chipset Overview

Built upon the functionality and the capability of the Intel 5500 chipset platform, the X8DAL-3/X8DAL-i motherboard provides the performance required for dual-processor-based CAD workstations or graphic-intensive systems. The 5500 chipset consists of the 5500 (LGA 1366) processor, the 5500 (North Bridge), and the South Bridge (ICH10R). With the Intel QuickPath interconnect (QPI) controller built in, the 5500/5600 Series Processor platform is the first dual-processing platform that offers the next generation point-to-point system interconnect interface, replacing the current Front Side Bus Technology that substantially enhances system performance with increased bandwidth and scalability.

The 5500 North Bridge connects to each processor through an independent QPI link. Each link consists of 20 pairs of unidirectional differential lanes for transmission and receiving in addition to a differential forwarded clock. A full-width QPI link pair provides 84 signals. Each processor supports two QPI links, one going to the other processor and the other to the North Bridge.

The 5500 Chipset supports up to 24 PCI Express Gen2 lanes, peer-to-peer read and write transactions. The ICH10R provides up to six PCI-Express ports, six SATA ports and eight USB connections.

In addition, the 5500 platform also supports a wide range of RAS (Reliability, Availability and Serviceability) features. These features include memory interface ECC, x4/x8 Single Device Data Correction (SDDC), Cyclic Redundancy Check (CRC), parity protection, out-of-band register access via SMBus, memory mirroring, memory sparing, and Hot-plug support on the PCI-Express Interface.

### **Main Features of the 5500/5600 Series Processor and the 5500 Chipset**

- Four processor cores in each processor with 8MB shared cache among cores
- Two full-width Intel QuickPath interconnect links, up to 6.4 GT/s of data transfer rate in each direction
- Virtualization Technology, Integrated Management Engine supported
- Point-to-point cache coherent interconnect, Fast/narrow unidirectional links, and Concurrent bi-directional traffic
- Error detection via CRC and Error correction via Link level retry

## 1-3 Special Features

### Recovery from AC Power Loss

BIOS provides a setting for you to determine how the system will respond when AC power is lost and then restored to the system. You can choose for the system to remain powered off (in which case you must hit the power switch to turn it back on) or for it to automatically return to a power-on state. See the Advanced BIOS Setup section to change this setting. The default setting is **Last State**.

## 1-4 PC Health Monitoring (w/SDII or SDIII)

This section describes the PC health monitoring features of the X8DAL-3/X8DAL-i. All have an onboard System Hardware Monitor chip that supports PC health monitoring via SuperO Doctor II or III. An onboard voltage monitor will scan these onboard voltages continuously: Vcore1, Vcore2, 1.5V, 5VDD, 5VSB, 12V, -12V, 3.3Vcc, 3.3VSB, VBAT and Vtt. Once a voltage becomes unstable, a warning is given or an error message is sent to the screen. Users can adjust the voltage thresholds to define the sensitivity of the voltage monitor.

### Fan Status Monitor with Firmware Control

The PC health monitor can check the RPM status of the cooling fans. The onboard CPU and chassis fans are controlled by Thermal Management via BIOS (under Hardware Monitoring in the Advanced Setting).

### Environmental Temperature Control

The thermal control sensor monitors the CPU temperature in real time and will turn on the thermal control fan whenever the CPU temperature exceeds a user-defined threshold. The overheat circuitry runs independently from the CPU. Once it detects that the CPU temperature is too high, it will automatically turn on the thermal fan control to cool down the system, effectively preventing CPU overheating. The onboard chassis thermal circuitry can monitor the overall system temperature and alert users when the chassis temperature is too high.



**Note:** To avoid system overheating, be sure to provide adequate airflow to the system.

### System Resource Alert

This feature is available when used with Supero Doctor III in the Windows OS environment or used with Supero Doctor II in Linux. Supero Doctor is used to

notify the user of certain system events. For example, you can also configure Supero Doctor to provide you with warnings when the system temperature, CPU temperatures, voltages and fan speeds go beyond a pre-defined range.

## 1-5 ACPI Features

ACPI stands for Advanced Configuration and Power Interface. The ACPI specification defines a flexible and abstract hardware interface that provides a standard way to integrate power management features throughout a PC system, including its hardware, operating system and application software. This enables the system to automatically turn on and off peripherals such as CD-ROMs, network cards, hard disk drives and printers.

In addition to enabling operating system-directed power management, ACPI provides a generic system event mechanism for Plug and Play and an operating system-independent interface for configuration control. ACPI leverages the Plug and Play BIOS data structures while providing a processor architecture-independent implementation that is compatible with both Windows 2000 and Windows 2003 Operating Systems.

### **Slow Blinking LED for Suspend-State Indicator**

When the CPU goes into a suspend state, the chassis power LED will start blinking to indicate that the CPU is in suspend mode. When the user presses any key, the CPU will wake-up and the LED will automatically stop blinking and remain on.

### **Main Switch Override Mechanism**

When an ATX power supply is used, the power button may function as a system suspend button, allowing the system to enter a SoftOff state. The monitor will be suspended and the hard drive will spin down. Pressing the power button again to "wake-up" the whole system. During the SoftOff state, the ATX power supply provides power to keep the required circuitry in the system "alive." In case the system malfunctions and you want to turn off the power, just press and hold the power button for 4 seconds. This option can be set in the BIOS Setup utility.

## 1-6 Power Supply

As with all computer products, a stable power source is necessary for proper and reliable operation. It is even more important for processors that have high CPU clock rates.

The X8DAL-3/X8DAL-i can accommodate 24-pin ATX power supplies. Although most power supplies generally meet the specifications required by the CPU, some

are inadequate. In addition, the two 12V 8-pin power connections are also required to ensure adequate power supply to the system. Also your power supply must supply 1.5A for the Ethernet ports.

It is strongly recommended that you use a high quality power supply that meets ATX power supply Specification 2.02 or above. It must also be SSI compliant. (For more information, please refer to the web site at <http://www.ssiforum.org/>). Additionally, in areas where noisy power transmission is present, you may choose to install a line filter to shield the computer from noise. It is recommended that you also install a power surge protector to help avoid problems caused by power surges.



**Warning:** To prevent damage to the power supply or motherboard, please use a power supply that contains a 24-pin and two 8-pin power connectors. Be sure to connect these connectors to the 24-pin (JPW1) and the two 8-pin (JPW2,JPW3) power connectors on the motherboard for adequate power supply to your system. Failure in doing so will void the manufacturer warranty on your power supply and motherboard.

## 1-7 Super I/O

The wide range of functions integrated onto the Super I/O greatly reduces the number of components required for interfacing with floppy disk drives. It also provides two high-speed, 16550 compatible serial communication ports (UARTs). Each UART includes a 16-byte send/receive FIFO, a programmable baud rate generator, complete modem control capability and a processor interrupt system. Both UARTs provide legacy speed with baud rate of up to 115.2 Kbps as well as an advanced speed with baud rates of 250 K, 500 K, or 1 Mb/s, which support higher speed modems.

The Super I/O provides functions that comply with ACPI (Advanced Configuration and Power Interface), which includes support of legacy and ACPI power management through an SMI or SCI function pin. It also features auto power management to reduce power consumption.

## Chapter 2

### Installation

#### 2-1 Static-Sensitive Devices

Electrostatic Discharge (ESD) can damage electronic components. To prevent damage to your motherboard, it is important to handle it very carefully. The following instructions are generally sufficient to protect your equipment from ESD.

##### Precautions

- Use a grounded wrist strap designed to prevent static discharge.
- Touch a grounded metal object before removing the motherboard from the antistatic bag.
- Handle the motherboard by its edges only; do not touch its components, peripheral chips, memory modules or gold contacts.
- When handling chips or modules, avoid touching their pins.
- Put the motherboard and peripherals back into their antistatic bags when not in use.
- For grounding purposes, make sure that your computer chassis provides excellent conductivity between different components, including the power supply, the chassis, mounting fasteners and the motherboard.
- Use only the correct type of onboard CMOS battery as specified by the manufacturer. Do not install the onboard battery upside down to avoid possible explosion.

##### Unpacking

The motherboard is shipped in antistatic packaging to avoid static damage. When unpacking the board, make sure that the person handling it is static protected.

## 2-2 Motherboard Installation

All motherboards have standard mounting holes to fit different types of chassis. Make sure that the locations of all the mounting holes for both motherboard and chassis match. Although a chassis may have both plastic and metal mounting fasteners, metal ones are highly recommended because they ground the motherboard to the chassis. Make sure that the metal standoffs click in or are screwed in tightly. Then use a screwdriver to secure the motherboard onto the motherboard tray. **Note:** Some components are very close to the mounting holes. Please take precautionary measures to prevent damage to these components when installing the motherboard to the chassis.

### Tools Needed

1. Phillips Screwdriver



2. Pan head #6 screws



### Installation Instructions

1. Install the IO shield into the chassis.
2. Locate the mounting holes on the motherboard. Refer to the layout on the right for mounting hole locations.
3. Locate the matching mounting holes on the chassis. Align the mounting holes on the motherboard against those on the chassis.
4. Install standoffs in the chassis as needed.
5. Install the motherboard into the chassis carefully to avoid damage to motherboard components.



**Warning:** To avoid damaging the motherboard and its components, please do not apply any force greater than 8 *lb/sq.in* (8 lbs. per square inch) when installing a screw into a mounting hole.

6. Insert a Pan head #6 screw into a mounting hole on the motherboard and its matching mounting hole on the chassis, using a Phillips screwdriver.
7. Repeat Step 4 to insert #6 screws to all mounting holes.
8. Make sure that the motherboard is securely installed in the chassis.

**Locations of Mounting Holes**

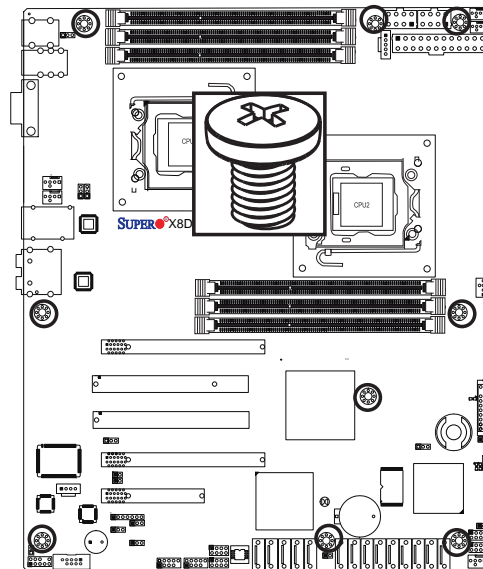

## 2-3 Processor and Heatsink Installation



When handling the processor package, avoid placing direct pressure on the label area of the fan.

### Notes:

1. Always connect the power cord last and always remove it before adding, removing or changing any hardware components. Make sure that you install the
2. Make sure to install the motherboard into the chassis before you install the CPU heatsink and heatsink fans.
3. When purchasing a motherboard without a 5500/5600 Series processor pre-installed, make sure that the CPU socket plastic cap is in place, and none of the CPU socket pins are bent; otherwise, contact the retailer immediately.
4. Refer to the MB Features Section for more details on CPU support.

### Installing an LGA 1366 Processor

1. Press the socket clip to release the load plate that covers the CPU socket from its locking position.



**Socket Clip**    **Load Plate**

2. Gently lift the socket clip to open the load plate.

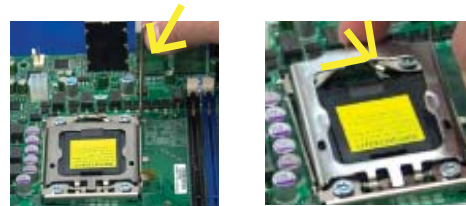

3. Hold the plastic cap at its north and south center edges to remove it from the CPU socket.

### **Plastic Cap**

**Hold the north & south edges of the plastic cap to remove it**





4. After removing the plastic cap, using your thumb and the index finger, hold the CPU at the north and south center edges.
5. Align the CPU key, which is the semi-circle cutout against the socket key, which is the notch below the gold color dot, on the side of the socket.
6. When both CPU and the socket are aligned, carefully lower the CPU straight down into the socket. (Do not rub the CPU against the surface of the socket or its pins to avoid damaging the CPU or the socket.)
7. With the CPU inside the socket, inspect the four corners of the CPU to make sure that the CPU is properly installed.
8. Once the CPU is securely seated on the socket, lower the CPU load plate to the socket.
9. Use your thumb to gently push the socket clip down to the clip lock.

 **Warning:** Be sure to save the plastic cap. The motherboard must be shipped with the plastic cap properly installed to protect the CPU socket pins. Shipment without the plastic cap properly installed on the CPU will cause damage to the socket pins.

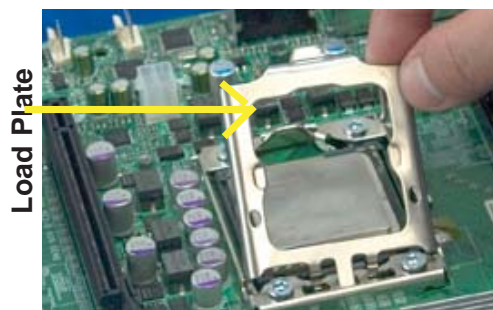
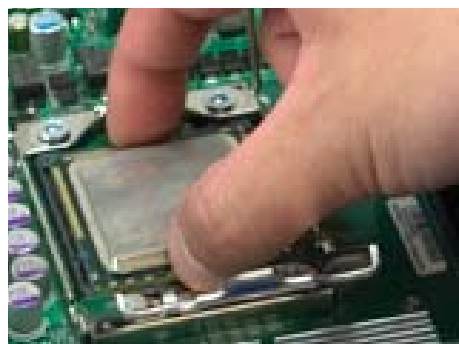
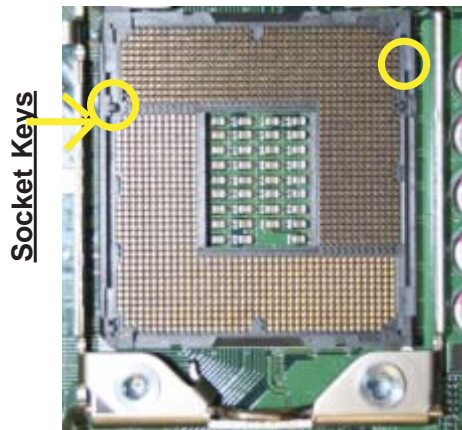
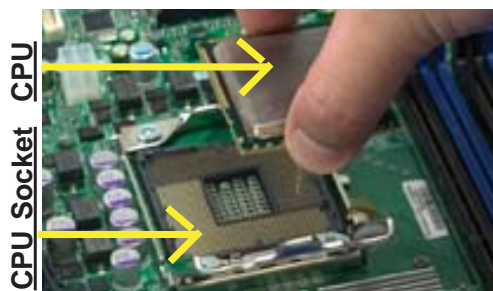



## Installing a CPU Heatsink

1. Do not apply any thermal grease to the heatsink or the CPU die because the required amount has already been applied.
2. Place the heatsink on top of the CPU so that the four mounting holes are aligned with those on the retention mechanism.
3. Install two diagonal screws (ie the #1 and the #2 screws) and tighten them until just snug (-do not fully tighten the screws to avoid possible damage to the CPU.)
4. Finish the installation by fully tightening all four screws.

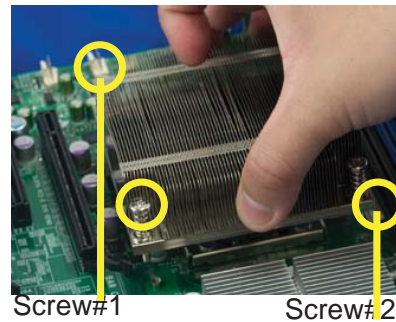
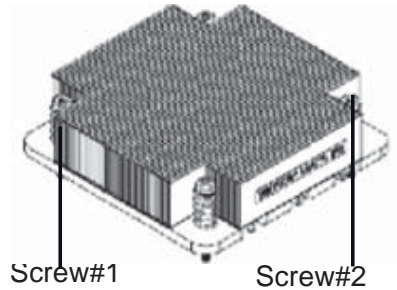

Install Screw#1

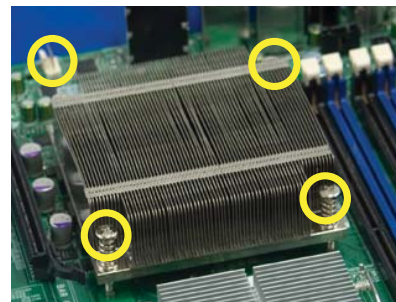
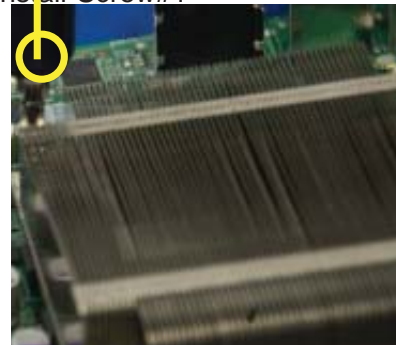

## Removing the Heatsink



**Warning:** We do not recommend that the CPU or the heatsink be removed. However, if you do need to remove the heatsink, please follow the instructions below to remove the heatsink and prevent damage to the CPU or other components.

1. Unplug the power cord from the power supply.
2. Disconnect the heatsink fan wires from the CPU fan header.
3. Using a screwdriver, loosen and remove the heatsink screws from the motherboard in the sequence as show in the picture on the right.
4. Hold the heatsink as shown in the picture on the right and gently wriggle the heatsink to loosen it from the CPU. (Do not use excessive force when wriggling the heatsink.)
5. Once the heatsink is loosened, remove it from the CPU socket.
6. To reinstall the CPU and the heatsink, clean the surface of the CPU and the heatsink to get rid of the old thermal grease. Reapply the proper amount of thermal grease on the surface before reinstalling them on the motherboard.

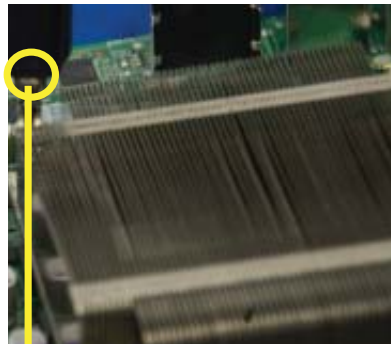

Using a screwdriver to remove Screw#1

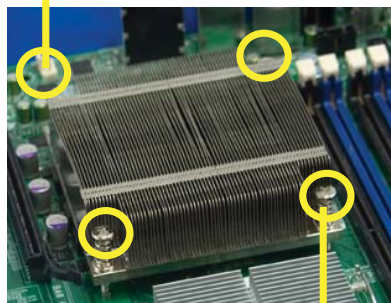

Remove Screw#2



## 2-4 Memory Installation

**Note:** Check the Supermicro web site for recommended memory modules.

### CAUTION



Exercise extreme care when installing or removing DIMM modules to prevent any possible damage. Also note that the memory is interleaved to improve performance (See step 1).

### DIMM Installation

1. Insert the desired number of DIMMs into the memory slots, starting with P1-DIMM 1A. For best memory performance, please install memory modules of the same type and same speed on the memory slots as indicated on the tables below. (See the Memory Installation Table Below.)
2. Insert each DIMM module vertically into its slot. Pay attention to the notch along the bottom of the module to prevent inserting the DIMM module incorrectly.
3. Gently press down on the DIMM module until it snaps into place in the slot. Repeat for all modules.

**Press down the release tabs**

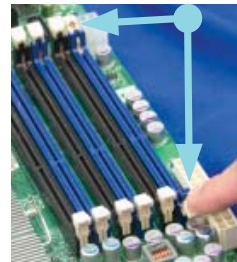

**Insert & press down a DIMM module into the slot**

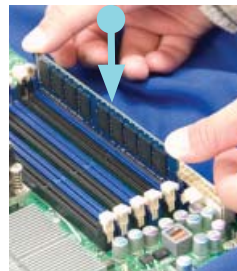

### Memory Support

#### Installing and Removing DDR3 Memory

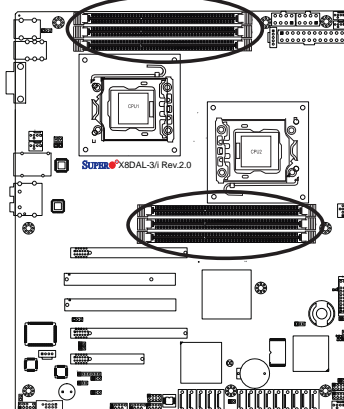

#### To Remove:

Use your thumbs to gently push the release tabs near both ends of the module. This should release it from the slot.

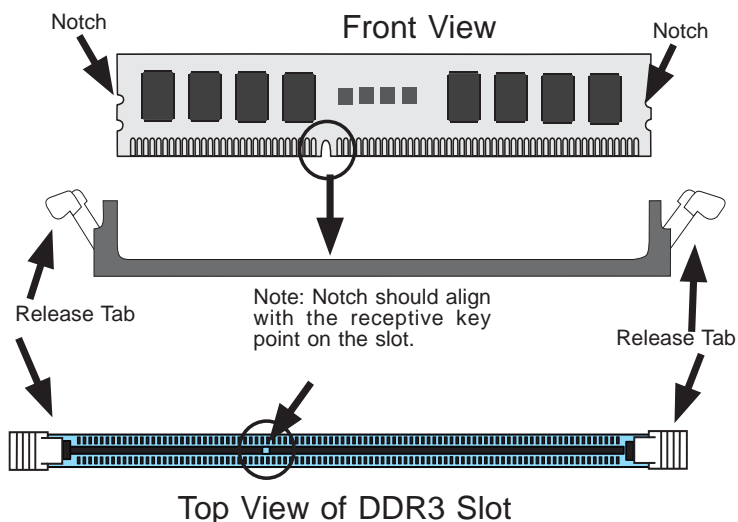

**To Install:** Insert module vertically and press down until it snaps into place. Pay attention to the alignment notch at the bottom.

The X8DAL-3/X8DAL-i supports up to 96 GB of Registered ECC or 24 GB Unbuffered ECC/Non-ECC DDR3 1333 MHz/1066 MHz/800 MHz in six DIMMs.

 **Note:** Memory speed support is dependent on the type of CPU used.

### DIMM Module Population Configuration

For memory to work properly, follow the tables below for memory installation:

Memory Population for Optimal Performance -For a motherboard with One CPU (CPU1) installed			
Branch 0		Branch 1	Branch 2
3 DIMMs	P1 DIMM1A	P1 DIMM2A	P1 DIMM3A

Memory Population for Optimal Performance -For a motherboard with One CPU (CPU2) installed			
Branch 0		Branch 1	Branch 2
3 DIMMs	P2 DIMM1A	P2 DIMM2A	P2 DIMM3A

Memory Population for Optimal Performance -For a motherboard with Two CPUs installed						
CPU1			CPU2			
Branch 0		Branch 1	Branch 2	Branch 0		Branch 2
6 DIMMs	P1-DIMM1A	P1-DIMM2A	P1-DIMM3A	P2-DIMM1A	P2-DIMM2A	P2-DIMM3A

### Memory Support for the Motherboard with the 5500 Series Processor(s) Installed

RDIMM Population for Motherboard with the 5500 Processor Installed		
RDIMM (Reg. DIMM/ Registered DIMM)	Speeds (in MHz)	Ranks per DIMM (any combination; SR=Single Rank, DR=Dual Rank, QR=Quad Rank)
Reg. DDR3 ECC	800,1066,1333	SR or DR
Reg. DDR3 ECC	800,1066	QR

UDIMM Population for Motherboard with the 5500 Processor Installed		
UDIMM (Unb. DIMM/ Unbuffered DIMM)	Speeds (in MHz)	Ranks per DIMM (any combination; SR=Single Rank, DR=Dual Rank, QR=Quad Rank)
Unb. DDR3 ECC/ Non-ECC	800,1066,1333	SR, or DR

## Memory Support for the Motherboard with the 5600 Series Processor(s) Installed

### 1.5V DIMMs

1.5V RDIMM Population for the Motherboard w/5600 Series Processors				
DIMM Slots per Channel	DIMMs Populated per Channel	RDIMM (Reg. DIMM/ Registered DIMM)	Speeds (in MHz)	Ranks per DIMM (any combination; SR=Single Rank, DR=Dual Rank, QR=Quad Rank)
3	1	Reg. DDR3 ECC	800,1066,1333	SR or DR
3	1	Reg. DDR3 ECC	800,1066 (Note 1)	QR
<b>Note:</b> 1333 MHz RDIMMs will run at 1066 MHz (-BIOS automatic downgrading).				

1.5V UDIMM Population for the Motherboard w/5600 Processors Installed				
DIMM Slots per Channel	DIMMs Populated per Channel	UDIMM (Unb. DIMM/ Unbuffered DIMM)	Speeds (in MHz)	Ranks per DIMM (any combination; SR=Single Rank, DR=Dual Rank, QR=Quad Rank)
3	1	Unb. DDR3 ECC/Non-ECC	800,1066,1333	SR or DR
<b>Note:</b> Mixing of 1.35V and 1.5V DIMMs is not recommended.				

### 1.35V DIMMs

1.35V RDIMM Population for the Motherboard w/5600 Processors				
DIMM Slots per Channel	DIMMs Populated per Channel	RDIMM (Reg. DIMM/ Registered DIMM)	Speeds (in MHz)	Ranks per DIMM (any combination; SR=Single Rank, DR=Dual Rank, QR=Quad Rank)
3	1	Reg. DDR3 ECC	800,1066,1333	SR or DR
3	1	Reg. DDR3 ECC	800 (Note 1)	QR
<b>Note 1:</b> 1333/1066 MHz QR RDIMMs will run at 800 MHz (-BIOS automatic downgrading).				
<b>Note 2:</b> Mixing of 1.35V and 1.5V DIMMs is not recommended.				

1.35V UDIMM Population for the Motherboard w/5600 Processors Installed				
DIMM Slots per Channel	DIMMs Populated per Channel	UDIMM (Unb. DIMM/ Unbuffered DIMM)	Speeds (in MHz)	Ranks per DIMM (any combination; SR=Single Rank, DR=Dual Rank, QR=Quad Rank)
3	1	Unb. DDR3 ECC	800,1066, 1333	SR or DR
<b>Note:</b> Mixing of 1.35V and 1.5V DIMMs is not recommended.				

 **Note 1:** Due to OS limitations, some operating systems may not show more than 4 GB of memory.

**Note 2:** Due to memory allocation to system devices, the amount of memory that remains available for operational use will be reduced when 4 GB of RAM is used. The reduction in memory availability is disproportional. (See the following Table.)

Possible System Memory Allocation & Availability		
System Device	Size	Physical Memory Remaining (-Available) (4 GB Total System Memory)
Firmware Hub flash memory (System BIOS)	1 MB	3.99 GB
Local APIC	4 KB	3.99 GB
Area Reserved for the chipset	2 MB	3.99 GB
I/O APIC (4 Kbytes)	4 KB	3.99 GB
PCI Enumeration Area 1	256 MB	3.76 GB
PCI Express (256 MB)	256 MB	3.51 GB
PCI Enumeration Area 2 (if needed) -Aligned on 256-MB boundary-	512 MB	3.01 GB
VGA Memory	16 MB	2.85 GB
TSEG	1 MB	2.84 GB
Memory available for the OS & other applications		2.84 GB

## 2-5 Control Panel Connectors/I/O Ports

The I/O ports are color coded in conformance with the PC 99 specification. See the picture below for the colors and locations of the various I/O ports.

### 1. Back Panel Connectors/I/O Ports

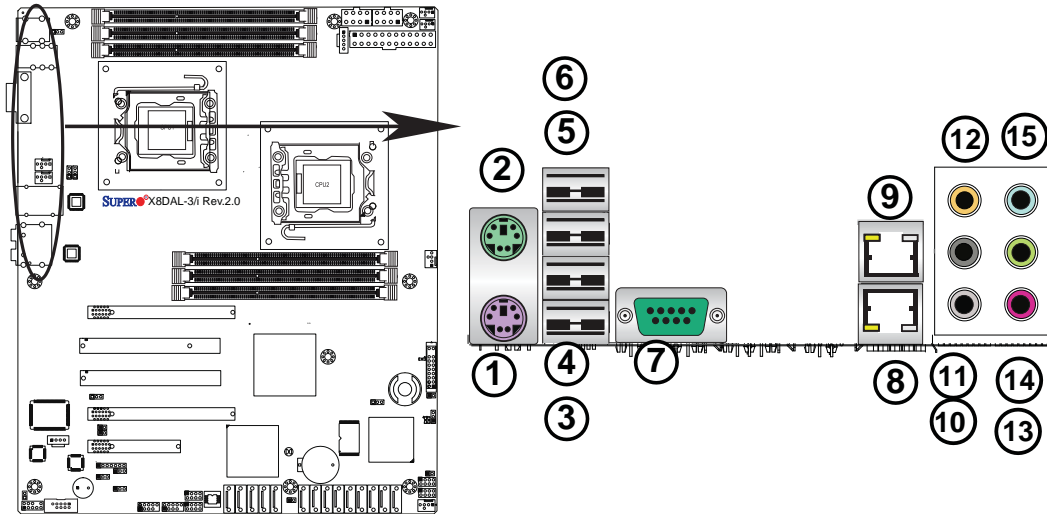

### Back Panel Connectors

1. Keyboard (Purple)
2. PS/2 Mouse (Green)
3. Back Panel USB Port 0
4. Back Panel USB Port 1
5. Back Panel USB Port 2
6. Back Panel USB Port 3
7. COM Port 1 (Turquoise)
8. LAN Port 1
9. LAN Port 2
10. Side_Surround (Grey)
11. Back_Surround (Black)
12. CEN/LFE (Orange)
13. Microphone-In (Pink)
14. Front (Green)
15. Line-In (Blue)

### ATX PS/2 Keyboard and PS/2 Mouse Ports

The ATX PS/2 keyboard and PS/2 mouse are located next to the Back Panel USB Ports 0~3 on the motherboard. See the table at right for pin definitions.

PS/2 Keyboard/Mouse Pin Definitions			
PS2 Keyboard		PS2 Mouse	
Pin#	Definition	Pin#	Definition
1	KB Data	1	Mouse Data
2	No Connection	2	No Connection
3	Ground	3	Ground
4	Mouse/KB VCC (+5V)	4	Mouse/KB VCC (+5V)
5	KB Clock	5	Mouse Clock
6	No Connection	6	No Connection

VCC: with 1.5A PTC (current limit)

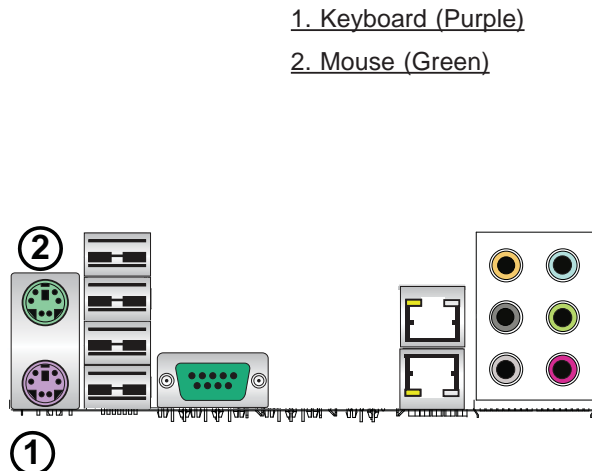
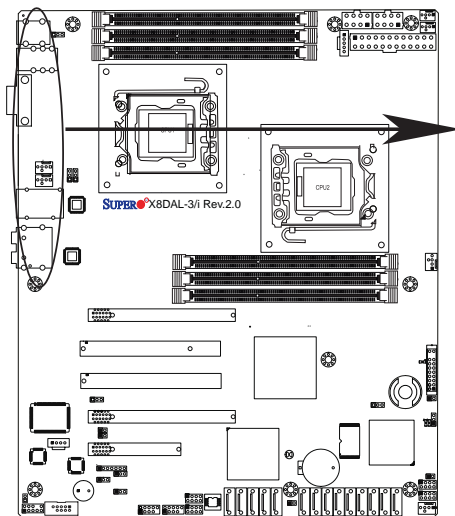



## Universal Serial Bus (USB)

Four Universal Serial Bus ports (USB 0~USB 3) are located on the I/O back panel. Additionally, four USB connections (USB 6/7, 8/9) are on the motherboard to provide front chassis access. (Cables are not included). See the tables on the right for pin definitions.

Back Panel USB (USB 0~3)	
Pin#	Definitions
1	+5V
2	PO-
3	PO+
4	Ground
5	N/A

Front Panel USB Pin Definitions (USB 6/7, 8/9)			
USB 6, 8		USB 7, 9	
Pin #	Definition	Pin #	Definition
1	+5V	1	+5V
2	PO-	2	PO-
3	PO+	3	PO+
4	Ground	4	Ground
5	Key	5	No connection

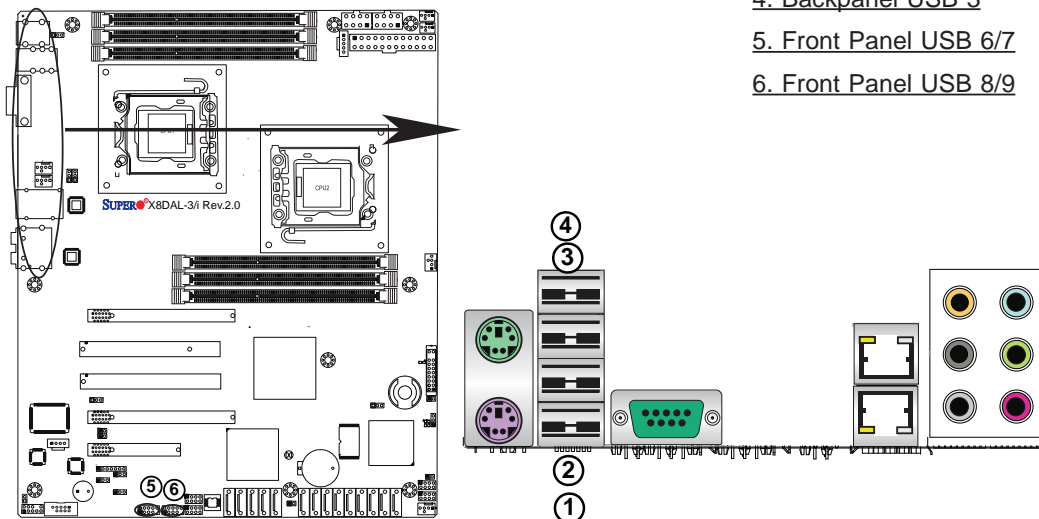

### Serial Ports

Two COM connections (COM1 & COM2) are located on the motherboard. COM1 port is located on the I/O backpanel. COM2, located next to the Front Panel Audio connector, provides front panel serial access. See the table on the right for pin definitions.

Serial Ports-COM1/COM2 Pin Definitions			
Pin #	Definition	Pin #	Definition
1	DCD	6	DSR
2	RXD	7	RTS
3	TXD	8	CTS
4	DTR	9	RI
5	Ground	10	N/A

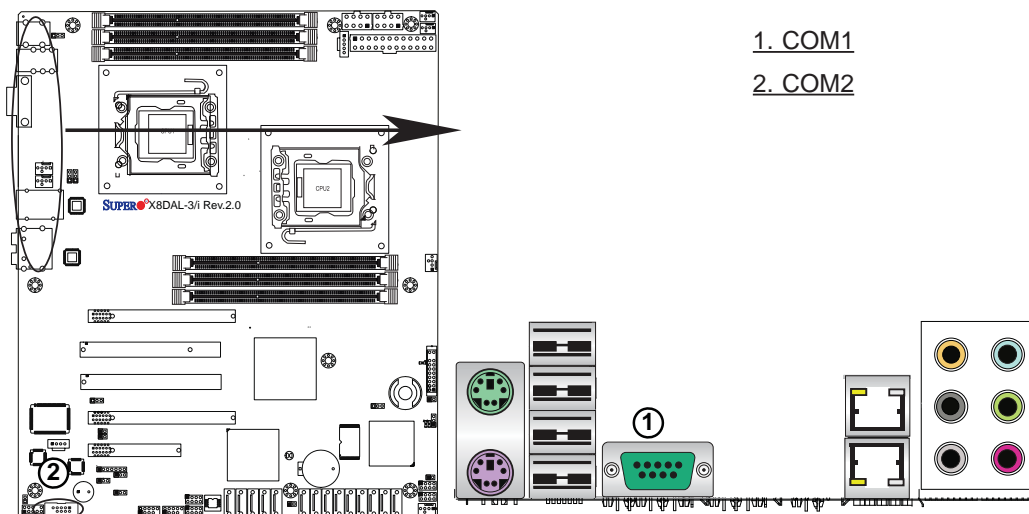

## Ethernet Ports

Two Ethernet ports (LAN 1/LAN2) are located at on the IO backplane. These ports accept RJ45 type cables. (**Note:** Please refer to the LED Indicator Section for LAN LED information.)

LAN Ports Pin Definition			
Pin#	Definition		
1	P2V5SB	10	SGND
2	TD0+	11	Act LED
3	TD0-	12	P3V3SB
4	TD1+	13	Link 100 LED (Yellow, +3V3SB)
5	TD1-	14	Link 1000 LED (Yellow, +3V3SB)
6	TD2+	15	Ground
7	TD2-	16	Ground
8	TD3+	17	Ground
9	TD3-	88	Ground

(NC: No Connection)

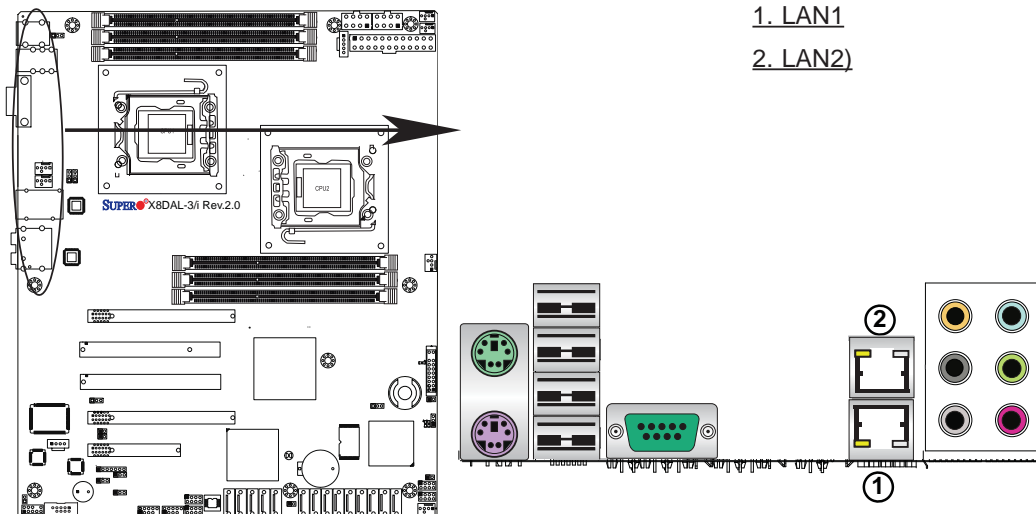

### (Back\_Panel) High Definition Audio (HD Audio)

This motherboard features a 7.1+2 Channel High Definition Audio (HDA) codec that provides 10 DAC channels. The HD Audio connections simultaneously supports multiple-streaming 7.1 sound playback with 2 channels of independent stereo output through the front panel stereo out for front L&R, rear L&R, center and subwoofer speakers. Use the Advanced software included in the CD-ROM with your motherboard to enable this function.

(BP) HD Audio	
Conn#	Signal
1	Side_Surround
2	Back_Surround
3	CEN/LFE
4	Microphone_In
5	Front
6	Line_In

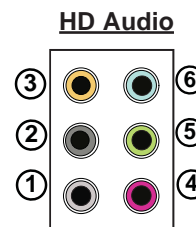

### CD Header

There is a 4-pin CD header (CD1) and a Front Pane Accessible Audio header (JC1) on the motherboard. These headers allow you to use the onboard sound for audio CD playback. Connect an audio cable from your CD drive to the CD header that fits your cable's connector. See the tables at right for pin definitions. (For details on FP Audio, please see the next page.)

CD1 Pin Definition	
Pin#	Definition
1	Left
2	Ground
3	Ground
4	Right

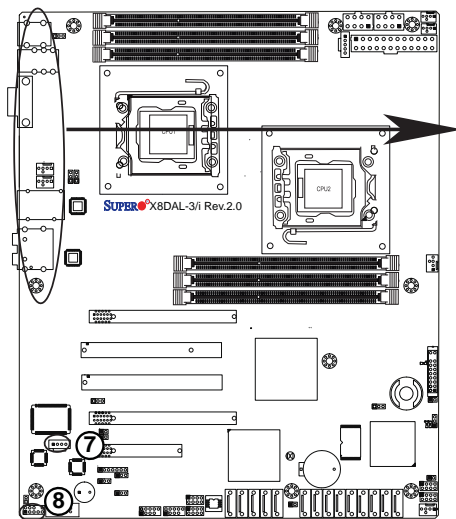

- 1~6 (See above)
- 7. CD-In Header
- 8. Front Panel Audio Header

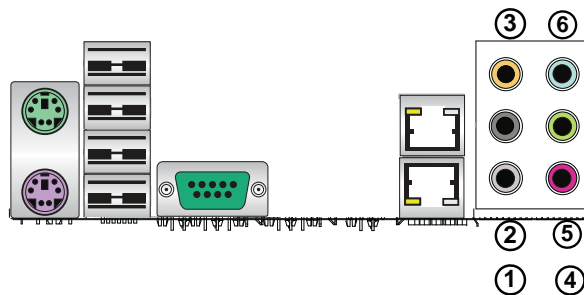

## Front Panel Audio

When front panel headphones are plugged in, the back panel audio output is disabled. This is done through the FP Audio header (JC1). If the front panel interface card is not connected to the Front Panel Audio header, jumpers should be put on the pin-pairs of 1/2, 5/6, and 9/10 on the FP Audio Header. If these jumpers are not installed, the back panel line\_out connector will be disabled and microphone input Pin 1 will be left floating, which can lead to excessive back panel microphone noise and cross talk. See the table on the right for pin definitions.

Front Panel Audio	
Pin#	Signal
1	Microphone_Left
2	Audio_Ground
3	Microphone_Right
4	FP Audio_Detect
5	Line_2_Right
6	Ground
7	FP_Jack_Detect
8	Key
9	Line_2_Left
10	Ground

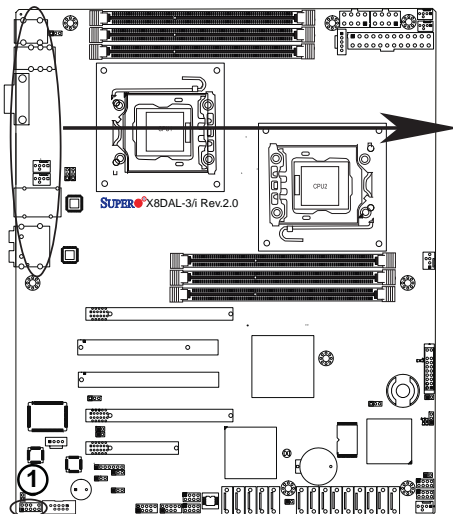

1. Front Panel Audio Header

## 2. Front Control Panel

JF1 contains header pins for various buttons and indicators that are normally located on a control panel at the front of the chassis. These connectors are designed specifically for use with Supermicro server chassis. See the figure below for the descriptions of the various control panel buttons and LED indicators. Refer to the following section for descriptions and pin definitions.

JF1 Header Pins

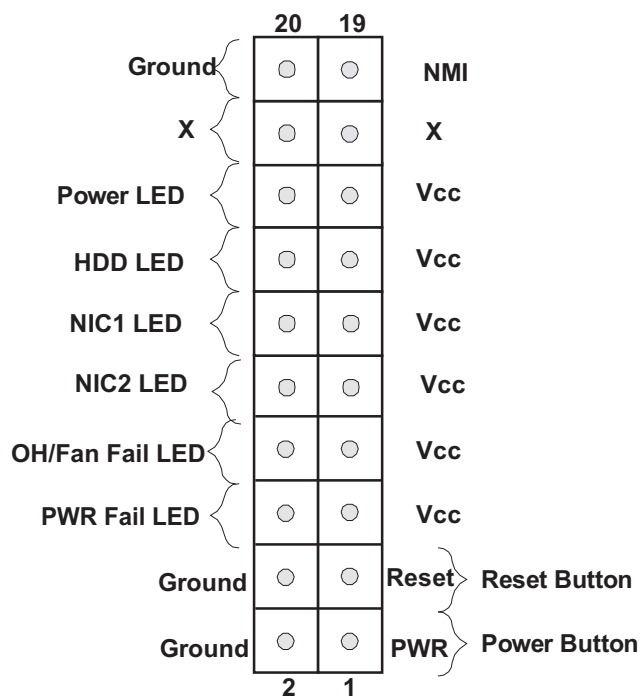
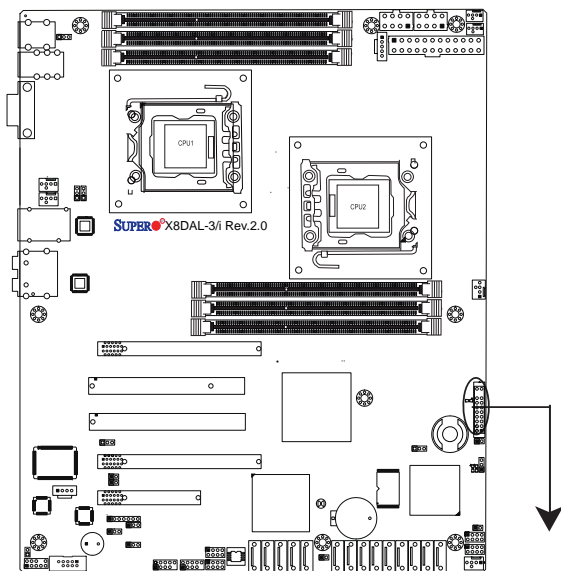

### 3. Front Control Panel Pin Definitions

#### NMI Button

The non-maskable interrupt button header is located on pins 19 and 20 of JF1. Refer to the table on the right for pin definitions.

NMI Button Pin Definitions (JF1)	
Pin#	Definition
19	Control
20	Ground

#### Power LED

The Power LED connection is located on pins 15 and 16 of JF1. Refer to the table on the right for pin definitions.

Power LED Pin Definitions (JF1)	
Pin#	Definition
15	+5V
16	Ground

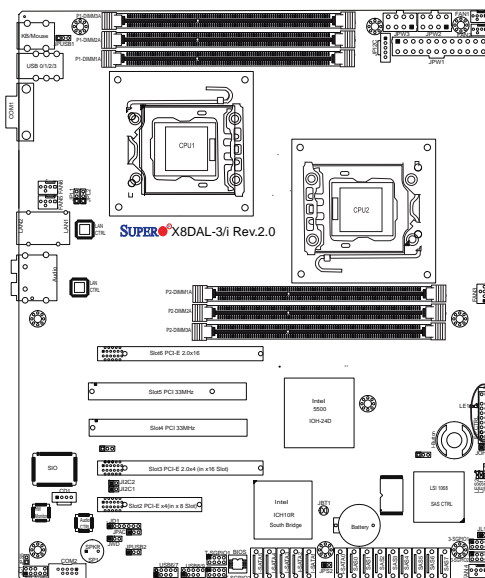

A. NMI

B. PWR LED

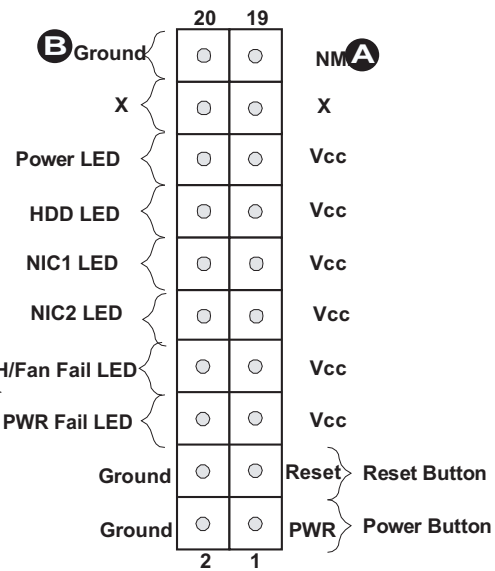

### HDD LED

The HDD LED connection is located on pins 13 and 14 of JF1. Attach a cable here to indicate HDD/SATA activities from the ICH10R South Bridge. See the table on the right for pin definitions.

HDD LED Pin Definitions (JF1)	
Pin#	Definition
13	+5V
14	HD Active

### NIC1/NIC2 LED Indicators

The NIC (Network Interface Controller) LED connection for GLAN port 1 is located on pins 11 and 12 of JF1, and the LED connection for GLAN Port 2 is on Pins 9 and 10. Attach the NIC LED cables to display network activities. Refer to the table on the right for pin definitions.

GLAN1/2 LED Pin Definitions (JF1)	
Pin#	Definition
9/11	Vcc
10/12	Ground

- A. HDD LED
- B. NIC1 LED
- C. NIC2 LED

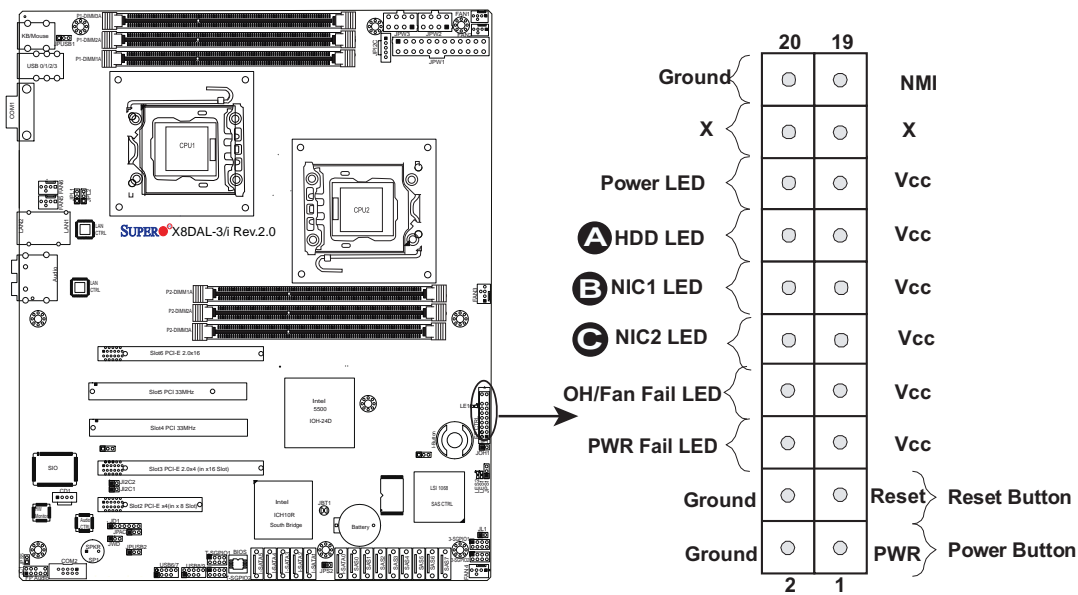



### Overheat (OH)/Fan Fail

Connect an LED cable to the OH/ Fan Fail connection on pins 7 and 8 of JF1 to provide advanced warnings for chassis overheat/fan failure. Refer to the table on the right for pin definitions.

OH/Fan Fail LED Pin Definitions (JF1)	
Pin#	Definition
7	Vcc
8	OH/Fan Fail LED

OH/Fan Fail Indicator Status	
State	Definition
Off	Normal
On	Overheat
Flash- ing	Fan Fail

### Power Fail LED

The Power Fail LED connection is located on pins 5 and 6 of JF1. Refer to the table on the right for pin definitions.

PWR Fail LED Pin Definitions (JF1)	
Pin#	Definition
5	Vcc
6	Ground

- A. OH/Fan Fail LED
- B. PWR Supply Fail

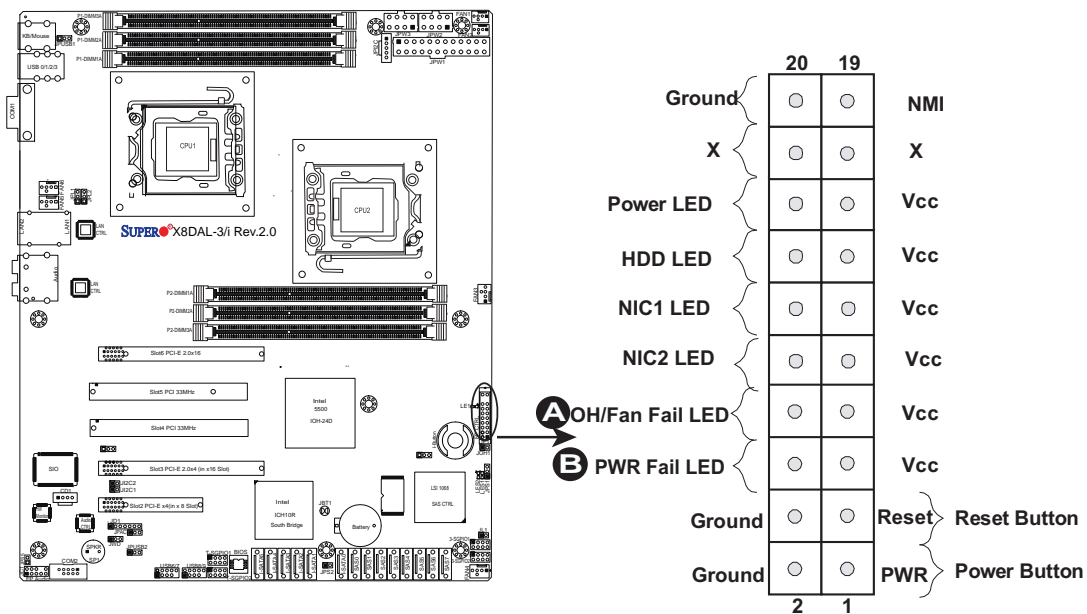

### Reset Button

The Reset Button connection is located on pins 3 and 4 of JF1. Attach it to a hardware reset switch on the computer case. Refer to the table on the right for pin definitions.

Reset Button Pin Definitions (JF1)	
Pin#	Definition
3	Reset
4	Ground

### Power Button

The Power Button connection is located on pins 1 and 2 of JF1. Momentarily contacting both pins will power on/off the system. This button can also be configured to function as a suspend button (with a setting in the BIOS - see Chapter 4). To turn off the power when set to suspend mode, press the button for at least 4 seconds. Refer to the table on the right for pin definitions.

Power Button Pin Definitions (JF1)	
Pin#	Definition
1	Signal
2	+3V Standby

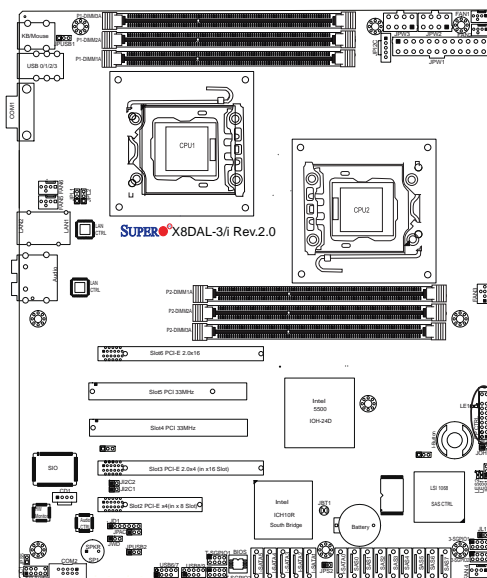

A. Reset Button

B. PWR Button

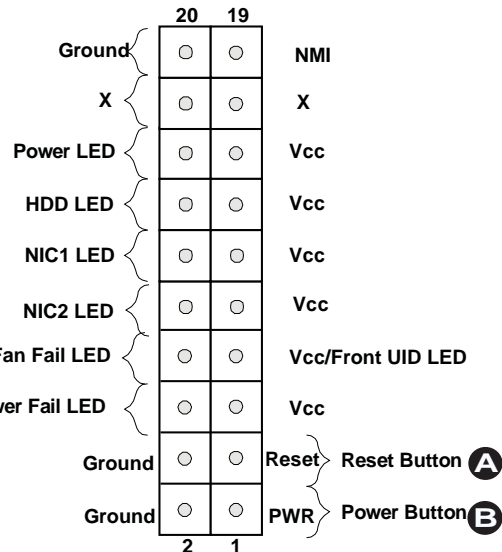

## 2-6 Connecting Cables

### Power Connectors

A 24-pin main power supply connector (JPW1) and two 8-pin CPU PWR connectors (JPW2/JPW3) on the motherboard. These power connectors meet the SSI EPS 12V specification. In addition to the 24-pin ATX power connector, the 12V 8-pin CPU PWR connectors at JPW2/JPW3 must also be connected to your power supply. See the table on the right for pin definitions.



**Warning:** To prevent damage to the power supply or motherboard, please use a power supply that contains a 24-pin and two 8-pin power connectors. Be sure to connect these connectors to the 24-pin (JPW1) and the two 8-pin (JPW2,JPW3) power connectors on the motherboard. Failure in doing so will void the manufacturer warranty on your power supply and motherboard.

ATX Power 24-pin Connector Pin Definitions			
Pin#	Definition	Pin #	Definition
13	+3.3V	1	+3.3V
14	-12V	2	+3.3V
15	COM	3	COM
16	PS_ON	4	+5V
17	COM	5	COM
18	COM	6	+5V
19	COM	7	COM
20	Res (NC)	8	PWR_OK
21	+5V	9	5VSB
22	+5V	10	+12V
23	+5V	11	+12V
24	COM	12	+3.3V

12V 8-pin PWR Connector Pin Definitions	
Pins	Definition
1 through 4	Ground
5 through 8	+12V

**(Required)**

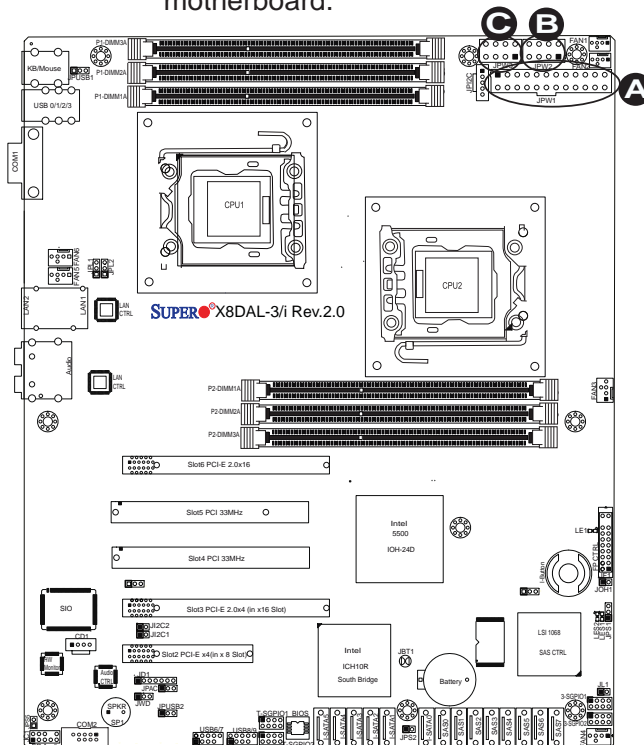

A. 24-pin ATX PWR (Req'd)  
 B/C. 8-pin Processor PWR  
 (Required)

### Fan Headers

This motherboard has four chassis/system fan headers (Fan 3 to Fan6) and two CPU fans (Fan1/Fan2) on the motherboard. All these 4-pin fans headers are backward compatible with the traditional 3-pin fans. However, fan speed control is available for 4-pin fans only. The fan speeds are controlled by Thermal Management via Hardware Monitoring in the Advanced Setting in the BIOS. (The Default setting is Disabled.) See the table on the right for pin definitions.

Fan Header Pin Definitions	
Pin#	Definition
1	Ground
2	+12V
3	Tachometer
4	PWR Modulation

### Chassis Intrusion

A Chassis Intrusion header is located at JL1 on the motherboard. Attach an appropriate cable from the chassis to inform you of a chassis intrusion when the chassis is opened.

Chassis Intrusion Pin Definitions (JL1)	
Pin#	Definition
1	Intrusion Input
2	Ground

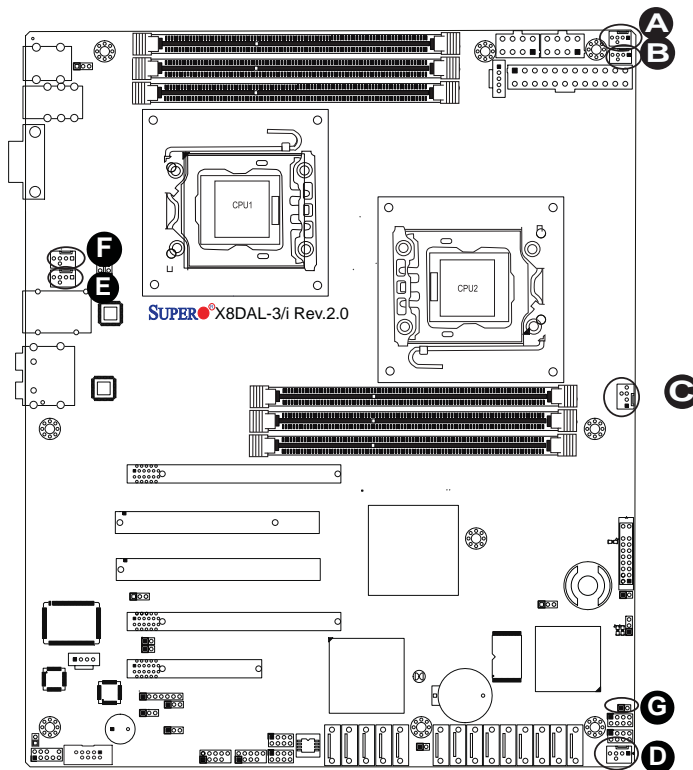

- A. Fan 1 (CPU2 Fan)
- B. Fan 2 (CPU1 Fan)
- C. Fan 3
- D. Fan 4
- E. Fan 5
- F. Fan 6
- G. Chassis Intrusion

### Internal Speaker

The Internal Speaker, located at SP1, can be used to provide audible indications for various beep codes. See the table on the right for pin definitions. Refer to the layout below for the locations of the Internal Buzzer (SP1).

Internal Buzzer (SP1) Pin Definition		
Pin#	Definitions	
Pin 1	Pos. (+)	Beep In
Pin 2	Neg. (-)	Alarm Speaker

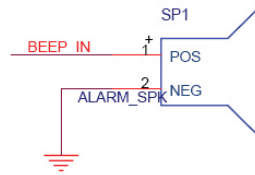

### Power LED/Speaker

On the JD1 header, pins 1~3 are used for power LED indication, and pins 4-7 are for the speaker. See the tables on the right for pin definitions. If you wish to use the onboard speaker, you should close pins 6~7 with a jumper. Connect a cable to pins 4~7 of JD1 to use an external speaker.

PWR LED Connector Pin Definitions	
Pin Setting	Definition
Pin 1	Anode (+)
Pin2	Cathode (-)
Pin3	NA

Speaker Connector Pin Definitions	
Pin Setting	Definition
Pins 4~7	External Speaker
Pins 6~7	Internal Speaker

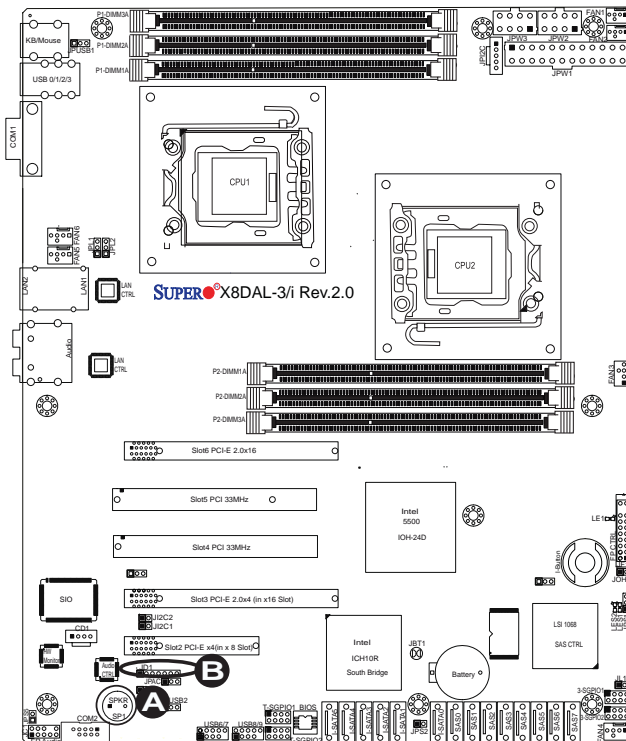

A. Internal Speaker (Buzzer)

B. PWR LED/Speaker

### Overheat LED/Fan Fail (JOH1)

The JOH1 header is used to connect an LED indicator to provide warnings of chassis overheating or fan failure. This LED will blink when a fan failure occurs. Refer to the table on right for pin definitions.

Overheat LED Pin Definitions	
Pin#	Definition
1	5vDC
2	OH Active

OH/Fan Fail LED Pin Definitions	
State	Message
Solid	Overheat
Blinking	Fan Fail

### Power SMB (I<sup>2</sup>C) Connector

Power System Management Bus (I<sup>2</sup>C) Connector (JPI<sup>2</sup>C) monitors power supply, fan and system temperatures. See the table on the right for pin definitions.

PWR SMB Pin Definitions	
Pin#	Definition
1	Clock
2	Data
3	PWR Fail
4	Ground
5	+3.3V

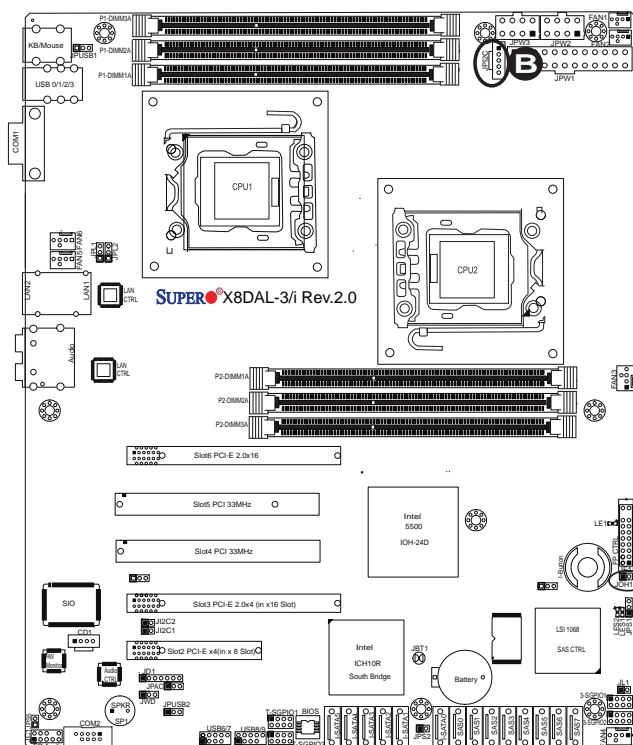

- A. OH LED
- B. PWR SMB

## T-SGPIO 1/2 & 3-SGPIO 1/2 Headers

Two SGPIO (Serial-Link General Purpose Input/Output) headers (T-SGPIO-1/T-SGPIO-2) are located on the motherboard. In addition, 3-SGPIO 1/2 located on the X8DAL-3 models. These headers support serial link interfaces for the onboard SATA and SAS connectors. See the table on the right for pin definitions. Refer to the board layout below for the location.

T-SGPIO Pin Definitions			
Pin#	Definition	Pin	Definition
1	NC	2	NC
3	Ground	4	Data
5	Load	6	Ground
7	Clock	8	NC

**Note:** NC= No Connections

## I-Button

An onboard I-Button, located next to the LSI SAS Controller, is a 1-wire computer chip enclosed in a durable stainless steel can. I-Button stores instructions, provides electronic interface and allows HostRAID to operate with Mega-RAID firmware.

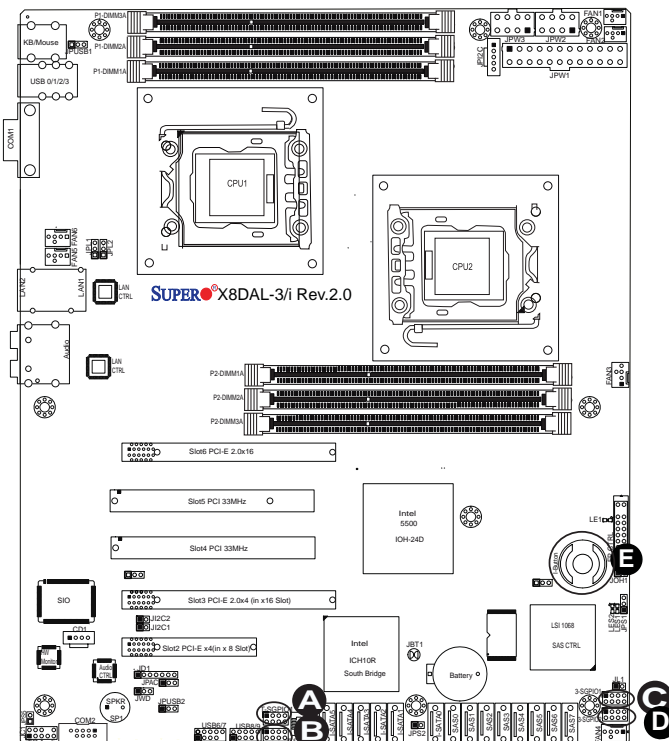

- A. T-SGPIO-1
- B. T-SGPIO-2
- C. 3-SGPIO-1 (X8DAL-3)
- D. 3-SGPIO-2 (X8DAL-3)
- E. I-Button (X8DAL-3)

## 2-7 Jumper Settings

### Explanation of Jumpers

To modify the operation of the motherboard, jumpers can be used to choose between optional settings. Jumpers create shorts between two pins to change the function of the connector. Pin 1 is identified with a square solder pad on the printed circuit board. See the motherboard layout pages for jumper locations.

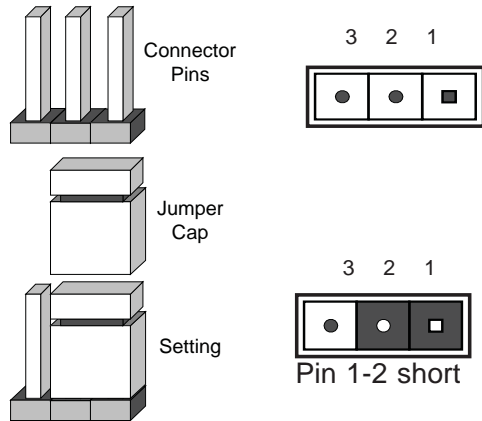

**Note:** On two pin jumpers, "Closed" means the jumper is on and "Open" means the jumper is off the pins.



### GLAN Enable/Disable

JPL1/JPL2 enable or disable the GLAN Port1/GLAN Port2 on the motherboard. See the table on the right for jumper settings. The default setting is **Enabled**.

GLAN Enable Jumper Settings	
Pin#	Definition
1-2	Enabled (default)
2-3	Disabled

- A. GLAN Port 1 Enable
- B. GLAN Port 2 Enable

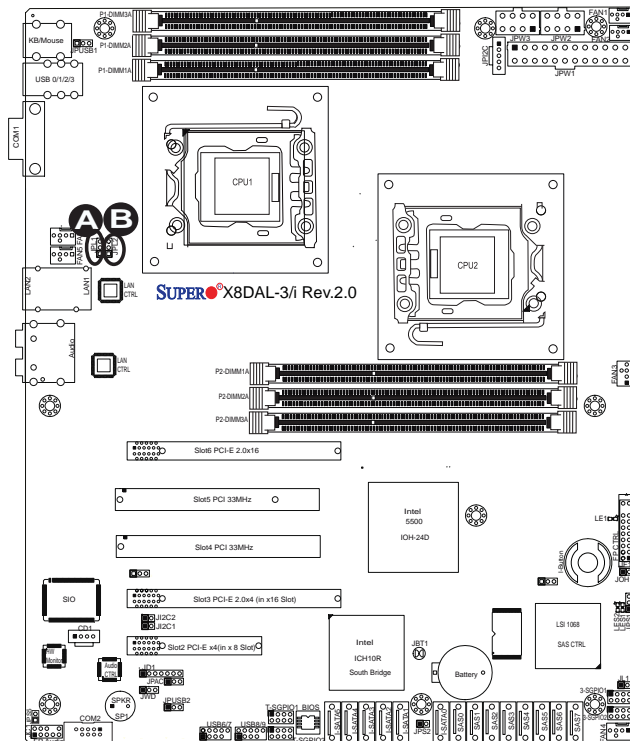



## CMOS Clear

JBT1 is used to clear CMOS. Instead of pins, this "jumper" consists of contact pads to prevent the accidental clearing of CMOS. To clear CMOS, use a metal object such as a small screwdriver to touch both pads at the same time to short the connection. Always remove the AC power cord from the system before clearing CMOS.



**Note:** For an ATX power supply, you must completely shut down the system, remove the AC power cord and then short JBT1 to clear CMOS.



## Watch Dog Enable/Disable

Watch Dog (JWD) is a system monitor that can reboot the system when a software application hangs. Close Pins 1-2 to reset the system if an application hangs. Close Pins 2-3 to generate a non-maskable interrupt signal for the application that hangs. See the table on the right for jumper settings. Watch Dog must also be enabled in the BIOS.

Watch Dog Jumper Settings (JWD)	
Jumper Setting	Definition
Pins 1-2	Reset (default)
Pins 2-3	NMI
Open	Disabled

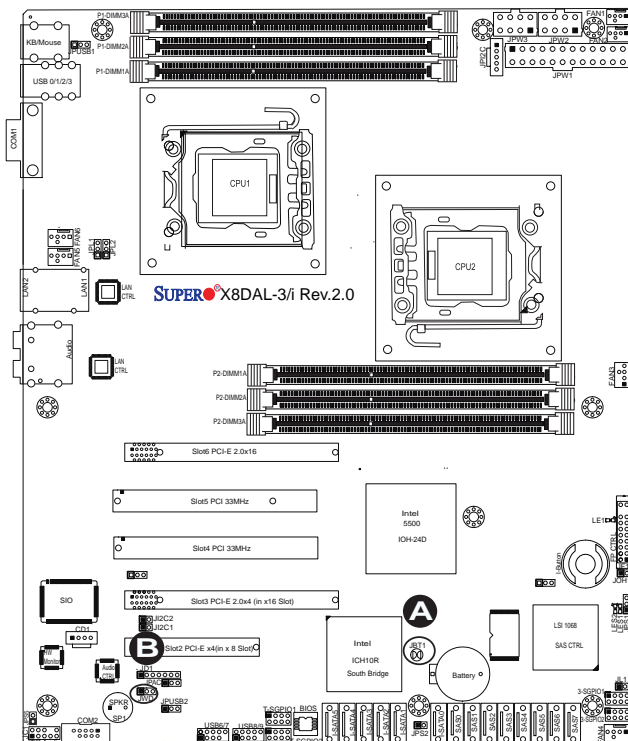

A. Clear CMOS

B. Watch Dog Enable

### I<sup>2</sup>C Bus to PCI-Exp. Slots

Jumpers JI<sup>2</sup>C1 and JI<sup>2</sup>C2 allow you to connect the System Management Bus (I<sup>2</sup>C) to PCI and PCI-Express slots. These two jumpers are to be set at the same time. The default setting is Open to disable the connections. See the table on the right for jumper settings.

I <sup>2</sup> C for PCI/PCI-E slots Jumper Settings	
Jumper Setting	Definition
Closed	Enabled
Open	Disabled (Default)

### Audio Enable

Jumper JPAC1 allows you to enable Audio connection. See the table on the right for jumper settings.

Audio Enable Jumper Settings	
Jumper Setting	Definition
1-2	Enabled (Default)
2-3	Disabled

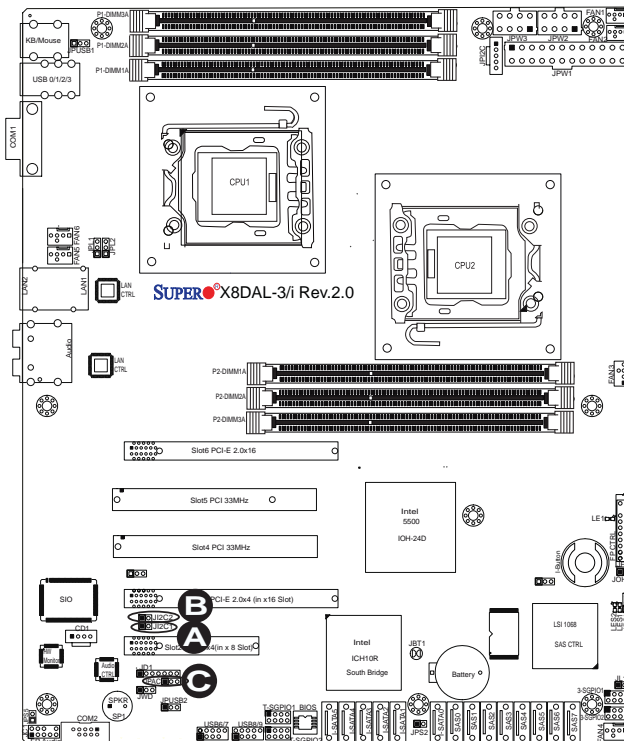

- A. JI<sup>2</sup>C1
- B. JI<sup>2</sup>C2
- C. Audio Enable

### SAS Enable/Disable (X8DAL-3 only)

Jumper JPS1 allows you to enable or disable the onboard SAS connections. The default setting is Pins 1-2 to enable the connection. See the table on the right for jumper settings.

SAS Enable Jumper Settings	
Jumper Setting	Definition
1-2	SAS Enabled (Default)
2-3	SAS Disabled

### SAS RAID Mode Select (X8DAL-3)

Jumper JPS2 allows you to select RAID Configuration settings for the onboard SAS connections. See the table on the right for jumper settings.

SAS RAID Config. Select Jumper Settings	
Jumper Setting	Definition
Open	Integrated Target Mode (IT)
Closed	Software RAID (SR) (Default)

 **Note:** For more information on LSI SAS RAID please refer to the LSI Mega-RAID User's Guide @ <http://www.supermicro.com/support/manuals/>.

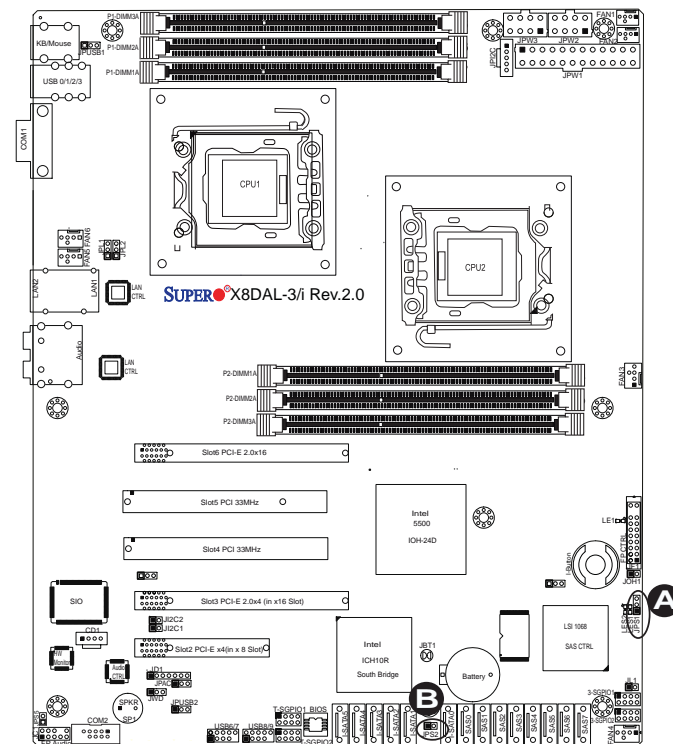

A. SAS Enable

B. SAS RAID Mode Select

## USB Wake-Up

The system may be woken up from the standby state by pushing a key on a USB keyboard connected to an enabled USB port. JPUSB1 is for the rear I/O USB ports and JPUSB2 is for the front access USB headers. See the tables on the right for jumper settings.

### JPUSB1 (BackPanel USB Wake-up Enable)

Pin#	Definition
1-2	Enabled (Default)
2-3	Disabled

### JPUSB2 (Front Panel USB Wake-up Enable)

Pin#	Definition
1-2	Enabled
2-3	Disabled (Default)

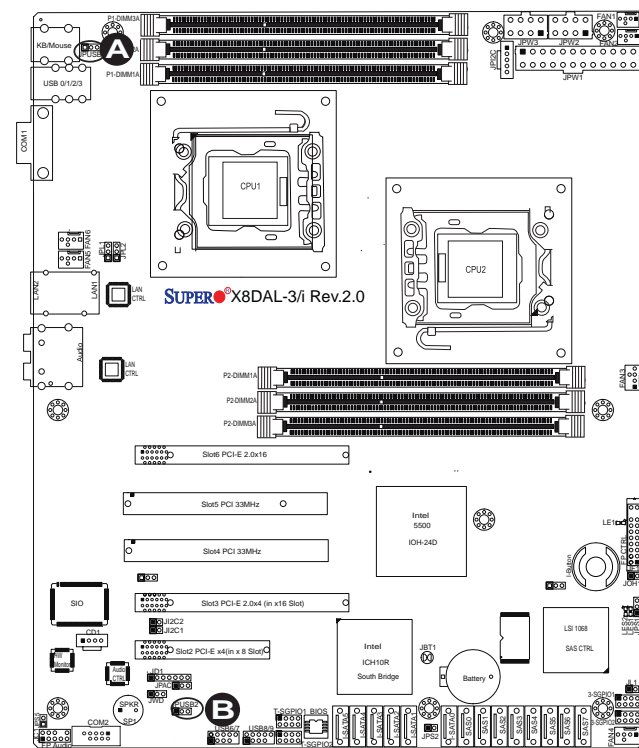

- A. Backplane USB Wake-UP Enable
- B. Front Panel USB Wake-UP Enable

## 2-8 Onboard LED Indicators

### GLAN LEDs

Two LAN ports (LAN 1/LAN 2) are located on the IO Backplane of the motherboard. Each Ethernet LAN port has two LEDs. The Yellow LED on the right indicates activity, while the Link LED may be green, amber or off to indicate the speed of the connections. See the tables at right for more information.

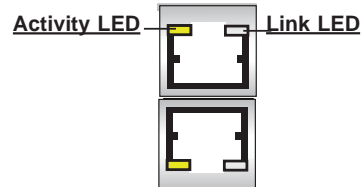

**Rear View** (when facing the rear side of the chassis)

LAN 1/LAN 2 Activity LED (Left) LED State		
Color	Status	Definition
Yellow	Flashing	Active

LAN 1/LAN 2 Link LED (Right) LED State	
LED Color	Definition
Off	No Connection or 10 Mbps
Green	100 Mbps
Amber	1 Gbps

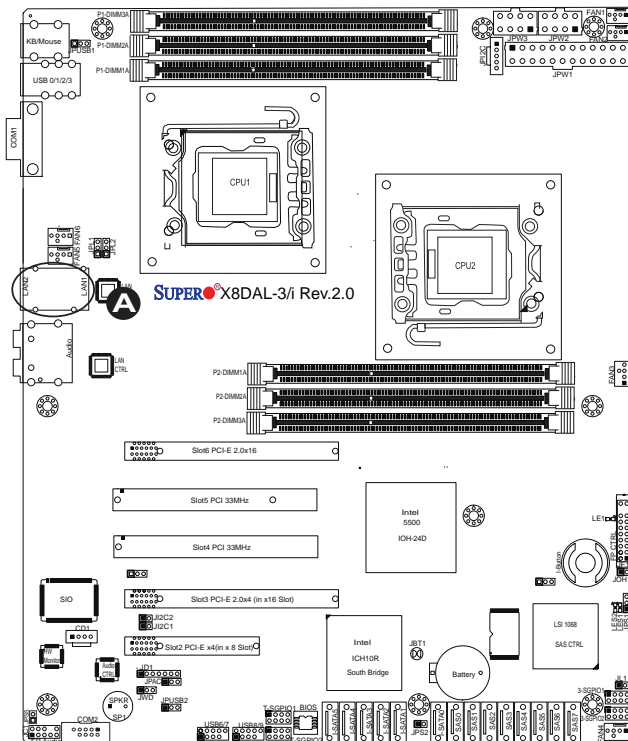

### A. LAN1/2 LEDs

### Onboard Power LED

An Onboard Power LED is located at LE1 on the motherboard. When this LED is on, the system is on. Be sure to turn off the system and unplug the power cord before removing or installing components. See the tables at right for more information.

Onboard PWR LED (LE1) Settings	
LED Color	Definition
Off	System Off (PWR cable not connected)
Green	System Power On

### SAS Heartbeat LED (X8DAL-3)

An Onboard SAS Heartbeat LED is located at LES2. When LES2 is blinking, SAS connections work properly. See the layout below for the location of LES2.

SAS Heartbeat LED (LES2) Settings	
LED Color	Definition
Blinking	SAS: Normal

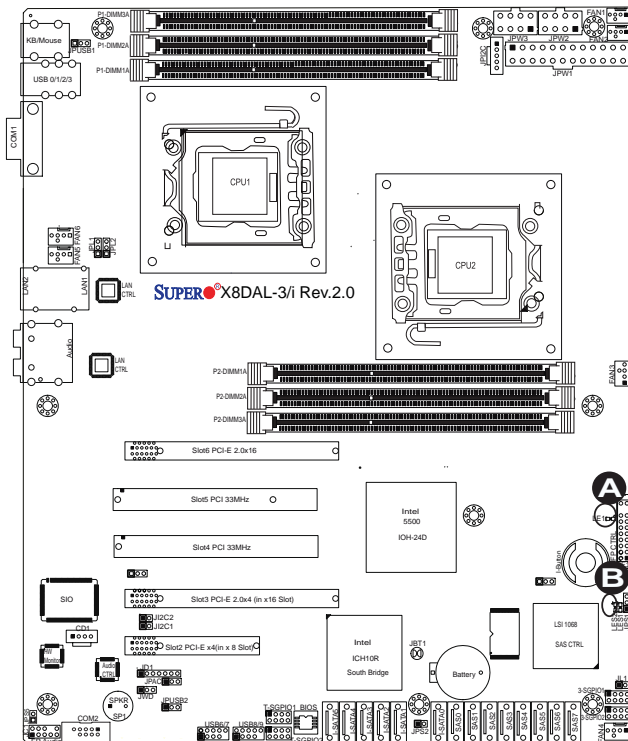

- A. PWR LED
  - B. SAS Heartbeat LED
- (X8DA:-3)

## 2-9 Serial ATA and SAS Connections

### Serial ATA Ports

There are Six Serial ATA Ports (I-SATA0~I-SATA 5) located on the motherboard. These ports provide serial-link signal connections, which are faster than the connections of Parallel ATA. See the table on the right for pin definitions.

Serial ATA Pin Definitions	
Pin#	Definition
1	Ground
2	TX_P
3	TX_N
4	Ground
5	RX_N
6	RX_P
7	Ground

### SAS Ports (X8DAL-3 only)

SAS Ports 0~7 provide SAS (Serial-Attached SCSI) connections on the X8DAL-3. See the layout below for SAS port locations.



**Note 1:** For more information on SATA HostRAID configuration, please refer to the Intel SATA HostRAID User's Guide posted on our website @ <http://www.supermicro.com/support/manuals/>.

**Note 2:** For more information on LSI SAS RAID configuration, please refer to the LSI MegaRAID User's Guide posted on our website @ <http://www.supermicro.com/support/manuals/>.

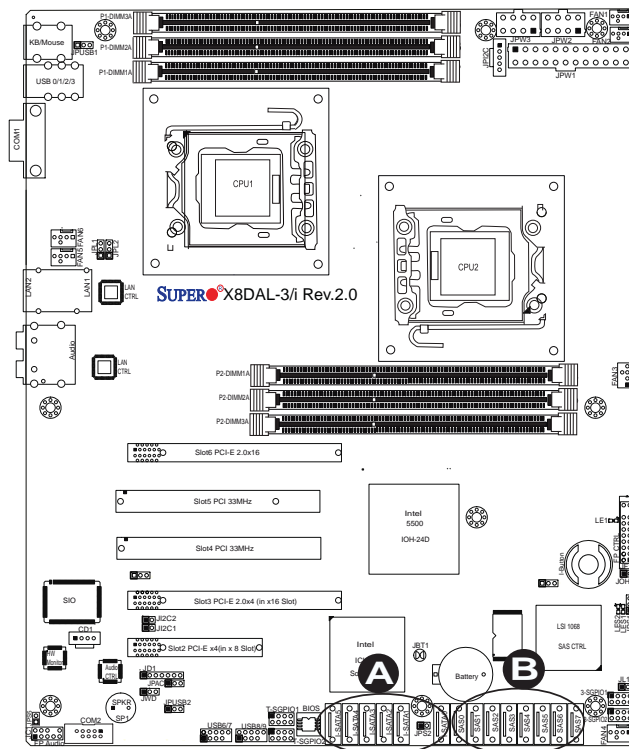

A. I-SATA0~5

B. SAS 0~7 (X8DAL-3)

## Notes



## Chapter 3

# Troubleshooting

### 3-1 Troubleshooting Procedures

Use the following procedures to troubleshoot your system. If you have followed all of the procedures below and still need assistance, refer to the 'Technical Support Procedures' and/or 'Returning Merchandise for Service' section(s) in this chapter. Note: Always disconnect the power cord before adding, changing or installing any hardware components.

#### **Before Power On**

1. Make sure that there are no short circuits between the motherboard and chassis.
2. Disconnect all ribbon/wire cables from the motherboard, including those for the keyboard and mouse.
3. Remove all add-on cards.
4. Install CPU 1 first and connect the chassis speaker and the power LED to the motherboard. (Making sure that the CPU is fully seated. Also, Check all jumper settings as well.)

#### **No Power**

1. Make sure that there are no short circuits between the motherboard and the chassis.
2. Make sure that all jumpers are set to their default positions.
3. Check that the 115V/230V switch on the power supply is properly set.
4. Turn the power switch on and off to test the system.
5. The battery on your motherboard may be old. Check to verify that it still supplies ~3VDC. If it does not, replace it with a new one.

## **No Video**

1. If the power is on but you have no video, remove all the add-on cards and cables.
2. Use the speaker to determine if any beep codes exist. Refer to the Appendix A for details on beep codes.

## **Losing the System's Setup Configuration**

1. Make sure that you are using a high quality power supply. A poor quality power supply may cause the system to lose the CMOS setup information. Refer to Section 1-6 for details on recommended power supplies.
2. The battery on your motherboard may be old. Check to verify that it still supplies ~3VDC. If it does not, replace it with a new one.
3. If the above steps do not fix the Setup Configuration problem, contact your vendor for repairs.

## **Memory Errors**

When a No\_Memory\_Beep\_Code is issued by the system, check the following:

1. Make sure that the DIMM modules are properly and fully installed.
2. Check if different speeds of DIMMs have been installed and check if the BIOS setup is configured for the fastest speed of RAM used. (It is recommended to use the same RAM speed for all DIMMs in the system.)
3. Make sure you are using the correct type of DDR3 Registered ECC or Unbuffered ECC/Non-ECC 1333/1066/800 MHz SDRAM (recommended by the manufacturer.)
4. Check for bad DIMM modules or slots by swapping a single module between all memory slots and check the results.
5. Make sure that all memory modules are fully seated in their slots. Make sure to follow the instructions given on DIMM population in Section 2-4 in Chapter 2.
6. Check the position of the 115V/230V switch on the power supply.
7. Please follow the instructions given in the DIMM Population Tables listed in Section 2-4 to install your memory modules.

## 3-2 Technical Support Procedures

Before contacting Technical Support, please take the following steps. Also, please note that as a motherboard manufacturer, Supermicro does not sell directly to end-users, so it is best to first check with your distributor or reseller for troubleshooting services. They should know of any possible problem(s) with the specific system configuration that was sold to you.

1. Please go through the 'Troubleshooting Procedures' and 'Frequently Asked Question' (FAQ) sections in this chapter or see the FAQs on our web site (<http://www.supermicro.com/support/faqs/>) before contacting Technical Support.
2. BIOS upgrades can be downloaded from our web site at (<http://www.supermicro.com/support/bios/>).
3. If you still cannot resolve the problem, include the following information when contacting Supermicro for technical support:
  - Motherboard model and PCB revision number
  - BIOS release date/version (this can be seen on the initial display when your system first boots up)
  - System configuration
  - An example of a Technical Support form is on our web site at (<http://www.supermicro.com/support/contact.cfm>).
  - Distributors: For immediate assistance, please have your account number ready when placing a call to our technical support department. We can be reached by e-mail at [support@supermicro.com](mailto:support@supermicro.com) or by fax at: (408) 503-8000, option 2.

## 3-3 Frequently Asked Questions

**Question:** What are the various types of memory that my motherboard can support?

**Answer:** The X8DAL-3/X8DAL-i has six 240-pin DIMM slots that support DDR3 Registered ECC or Unbuffered ECC/Non-ECC 1333/1066/800 MHz SDRAM modules. It is strongly recommended that you do not mix memory modules of different speeds and sizes. Please follow all memory installation instructions given on Section 2-4 in Chapter 2.

**Question: How do I update my BIOS?**

**Answer:** It is recommended that you **do not** upgrade your BIOS if you are not experiencing any problems with your system. Updated BIOS files are located on our web site at <http://www.supermicro.com/support/bios/>. Please check our BIOS warning message and the information on how to update your BIOS on our web site. Select your motherboard model and download the BIOS file to your computer. Also, check the current BIOS revision and make sure that it is newer than your BIOS before downloading. You can choose from the zip file and the .exe file. If you choose the zip BIOS file, please unzip the BIOS file onto a bootable USB device. Run the batch file using the format flash.bat filename.rom from your bootable USB device to flash the BIOS. Then, your system will automatically reboot. Please note that this process may take a few minutes to complete. Do not be concerned if the screen is paused for a few minutes.



**Warning:** Do not shut down or reset the system while updating the BIOS to prevent possible system boot failure!



**Note:** The SPI BIOS chip used on this motherboard cannot be removed. Send your motherboard back to our RMA Department for repair.

**Question: What's on the CD that came with my motherboard?**

**Answer:** The supplied CD has drivers and programs that are needed for your system. Please review the CD and install the applications you need. Applications on the CD include chipset drivers for the Windows OS, security and audio drivers.

### 3-4 Returning Merchandise for Service

A receipt or copy of your invoice marked with the date of purchase is required before any warranty service will be rendered. You can obtain service by calling your vendor for a Returned Merchandise Authorization (RMA) number. When returning to the manufacturer, the RMA number should be prominently displayed on the outside of the shipping carton, and mailed prepaid or hand-carried. Shipping and handling charges will be applied for all orders that must be mailed when service is complete. For faster service, You can also request a RMA authorization online (<http://www.supermicro.com/support/rma/>).

This warranty only covers normal consumer use and does not cover damages incurred in shipping or from failure due to the alternation, misuse, abuse or improper maintenance of products.

During the warranty period, contact your distributor first for any product problems.

---

---

## Chapter 4

### BIOS

#### 4-1 Introduction

This chapter describes the AMI BIOS Setup Utility for the X8DAL-3. The AMI ROM BIOS is stored in a Flash EEPROM and can be easily updated. This chapter describes the basic navigation of the AMI BIOS Setup Utility setup screens.



**Note:** For instructions on BIOS recovery, please refer to the instruction guide posted at <http://www.supermicro.com/support/manuals/>.

#### Starting BIOS Setup Utility

To enter the AMI BIOS Setup Utility screens, press the <Delete> key while the system is booting up.



**Note:** In most cases, the <Delete> key is used to invoke the AMI BIOS setup screen. There are a few cases when other keys are used, such as <F1>, <F2>, etc.

Each main BIOS menu option is described in this manual. The Main BIOS setup menu screen has two main frames. The left frame displays all the options that can be configured. Grayed-out options cannot be configured. Options in blue can be configured by the user. The right frame displays the key legend. Above the key legend is an area reserved for a text message. When an option is selected in the left frame, it is highlighted in white. Often a text message will accompany it. (**Note:** the AMI BIOS has default text messages built in. Supermicro retains the option to include, omit, or change any of these text messages.)

The AMI BIOS Setup Utility uses a key-based navigation system called "hot keys". Most of the AMI BIOS setup utility "hot keys" can be used at any time during the setup navigation process. These keys include <F1>, <F10>, <Enter>, <ESC>, arrow keys, etc.



**Note:** Options printed in **Bold** are default settings.

#### How To Change the Configuration Data

The configuration data that determines the system parameters may be changed by entering the AMI BIOS Setup utility. This Setup utility can be accessed by pressing <Del> at the appropriate time during system boot.

## Starting the Setup Utility

Normally, the only visible Power-On Self-Test (POST) routine is the memory test. As the memory is being tested, press the <Delete> key to enter the main menu of the AMI BIOS Setup Utility. From the main menu, you can access the other setup screens. An AMI BIOS identification string is displayed at the left bottom corner of the screen below the copyright message.



**Warning!** Do not upgrade the BIOS unless your system has a BIOS-related issue. Flashing the wrong BIOS can cause irreparable damage to the system. In no event shall Supermicro be liable for direct, indirect, special, incidental, or consequential damages arising from a BIOS update. If you have to update the BIOS, do not shut down or reset the system while the BIOS is updating. This is to avoid possible boot failure.

## 4-2 Main Setup

When you first enter the AMI BIOS Setup Utility, you will enter the Main setup screen. You can always return to the Main setup screen by selecting the Main tab on the top of the screen. The Main BIOS Setup screen is shown below.

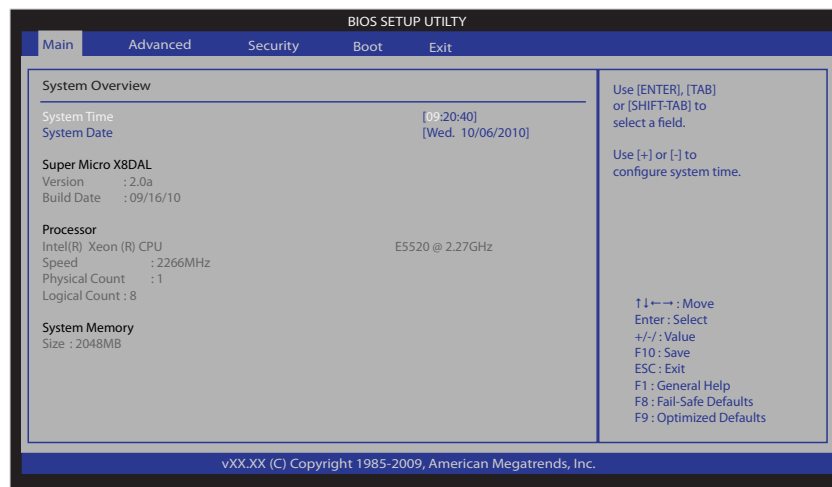

**System Overview:** The following BIOS information will be displayed:

### System Time/System Date

Use this option to change the system time and date. Highlight *System Time* or *System Date* using the arrow keys. Key in new values through the keyboard and press <Enter>. Press the <Tab> key to move between fields. The date must be entered in Day MM/DD/YY format. The time is entered in HH:MM:SS format. (**Note:** The time is in the 24-hour format. For example, 5:30 P.M. appears as 17:30:00.)

### Super Micro X8DAL BIOS

- **Version:** This item displays the BIOS revision used in your system.
- **Build Date:** This item displays the date when this BIOS was completed.

## Processor

The AMI BIOS will automatically display the status of the processor used in your system:

- **CPU Type:** This item displays the type of CPU used in the motherboard.
- **Speed:** This item displays the speed of the CPU detected by the BIOS.
- **Physical Count:** This item displays the number of processors installed in your system as detected by the BIOS.
- **Logical Count:** This item displays the number of CPU Cores installed in your system as detected by the BIOS.

## System Memory

This displays the size of memory available in the system.

## 4-3 Advanced Setup Configurations

Use the arrow keys to select Boot Setup and hit <Enter> to access the submenu items:

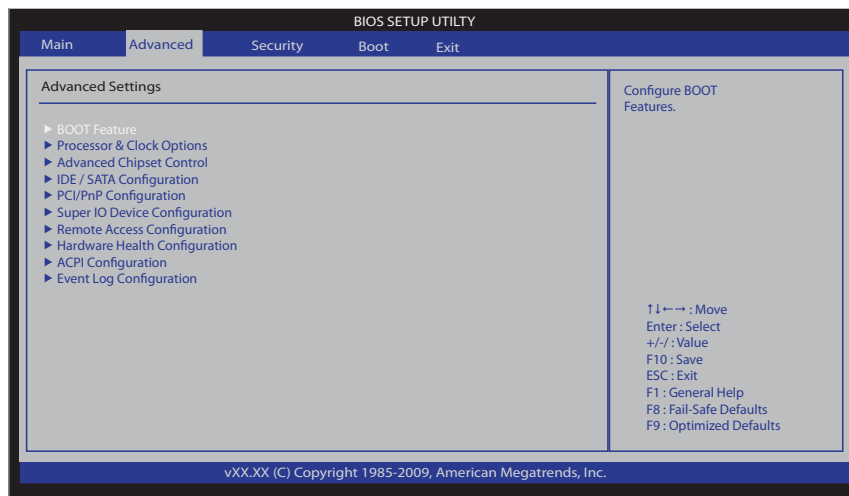

### ► Boot Features

#### Quick Boot

If this item is set to Enabled, this option will skip certain tests during POST to reduce the time needed for system boot. The options are **Enabled** and Disabled.

#### Quiet Boot

This option allows the bootup screen options to be modified between POST messages or the OEM logo. Select Disabled to display the POST messages. Select Enabled to display the OEM logo instead of the normal POST messages. The options are **Enabled** and Disabled.

### **AddOn ROM Display Mode**

This sets the display mode for Option ROM. The options are **Force BIOS** and **Keep Current**.

### **Bootup Num-Lock**

This feature selects the Power-on state for Numlock key. The options are **Off** and **On**.

### **Wait For 'F1' If Error**

This forces the system to wait until the 'F1' key is pressed if an error occurs. The options are **Disabled** and **Enabled**.

### **Hit 'Del' Message Display**

This feature displays "Press DEL to run Setup" during POST. The options are **Enabled** and **Disabled**.

### **Interrupt 19 Capture**

Interrupt 19 is the software interrupt that handles the boot disk function. When this item is set to **Enabled**, the ROM BIOS of the host adaptors will "capture" Interrupt 19 at boot and allow the drives that are attached to these host adaptors to function as bootable disks. If this item is set to **Disabled**, the ROM BIOS of the host adaptors will not capture Interrupt 19, and the drives attached to these adaptors will not function as bootable devices. The options are **Enabled** and **Disabled**.

## **► Power Configuration**

### **Watch Dog Function**

If enabled, the Watch Dog Timer will allow the system to reboot when it is inactive for more than 5 minutes. The options are **Enabled** and **Disabled**.

### **Power Button Function**

If set to **Instant\_Off**, the system will power off immediately as soon as the user hits the power button. If set to **4\_Second\_Override**, the system will power off when the user presses the power button for 4 seconds or longer. The options are **Instant\_Off** and **4\_Second\_Override**.

### **Restore on AC Power Loss**

Use this feature to set the power state after a power outage. Select **Power-Off** for the system power to remain off after a power loss. Select **Power-On** for the system power to be turned on after a power loss. Select **Last State** to allow the system to resume its last state before a power loss. The options are **Power-On**, **Power-Off** and **Last State**.



## **EUP Support**

Enable this feature for EuP support to meet Eco-design requirements for energy-efficient products. Disable this feature to supply standby power and allow the machine to "wake-up" in the S5 state. The options are Enabled and **Disabled**.

## **► Processor and Clock Options**

This submenu allows the user to configure the Processor and Clock settings.

### **Clock Spread Spectrum**

Select Enable to use the feature of Clock Spectrum, which will allow the BIOS to monitor and attempt to reduce the level of Electromagnetic Interference caused by the components whenever needed. The options are **Disabled** and Enabled.

### **Hardware Prefetcher (Available when supported by the CPU)**

If set to Enabled, the hardware pre fetcher will pre fetch streams of data and instructions from the main memory to the L2 cache in the forward or backward manner to improve CPU performance. The options are Disabled and **Enabled**.

### **Adjacent Cache Line Prefetch (Available when supported by the CPU)**

The CPU fetches the cache line for 64 bytes if this option is set to Disabled. The CPU fetches both cache lines for 128 bytes as comprised if **Enabled**.

### **L1 Data Prefetcher (Available when supported by the CPU)**

Select Enabled to activate L1 Data Prefetcher to enhance system performance for UP platforms. For DP/MP servers, enable or disable this feature based on application specifications. The options are **Enabled** and Disabled.

### **Data Reuse Optimization (Available when supported by the CPU)**

Select Enabled to maximize Data Reuse support to enhance system performance for UP platforms. For DP/MP servers, enable or disable this feature based on application specifications. The options are **Enabled** and Disabled.

### **MPS and ACPI MADT Ordering**

This feature allows the user to configure the MPS (Multi-Processor Specifications) and ACPI settings for the motherboard. Select Modern Ordering if XP or a newer version of the Windows OS is used in the motherboard. Select Legacy Ordering if 2000 or an earlier version of the Windows OS is used. The options are **Modern Ordering** and Legacy Ordering.

### **Intel® Virtualization Technology (Available when supported by the CPU)**

Select Enabled to use the feature of Virtualization Technology to allow one platform to run multiple operating systems and applications in independent partitions, creat-

---

ing multiple "virtual" systems in one physical computer. The options are **Enabled** and Disabled. **Note:** If there is any change to this setting, you will need to power off and restart the system for the change to take effect. Please refer to Intel's web site for detailed information.

**Execute-Disable Bit Capability (Available when supported by the OS and the CPU)**

Set to Enabled to enable the Execute Disable Bit which will allow the processor to designate areas in the system memory where an application code can execute and where it cannot, thus preventing a worm or a virus from flooding illegal codes to overwhelm the processor or damage the system during an attack. The default is **Enabled**. (Refer to Intel and Microsoft Web Sites for more information.)

**Intel AES-NI (Available when supported by the OS and the CPU)**

If set to Enabled, Intel AES-NI will add new encryption features to help accelerate AES SW application, providing code authorization and signature verification to improve system performance. The default is **Disabled**. (Refer to Intel and Microsoft Web Sites for more information.)

**Simultaneous Multi-Threading (Available when supported by the CPU)**

Set to Enabled to use the Simultaneous Multi-Threading Technology, which will result in increased CPU performance. The options are Disabled and **Enabled**.

**Active Processor Cores**

Set to Enabled to use a processor's Second Core and beyond. (Please refer to Intel's web site for more information.) The options are **All**, 1 and 2.

**Intel® EIST Technology**

EIST (Enhanced Intel SpeedStep Technology) allows the system to automatically adjust processor voltage and core frequency in an effort to reduce power consumption and heat dissipation. **Please refer to Intel's web site for detailed information.** The options are Disable (Disable GV3) and **Enable (Enable GV3)**.

**Intel® TurboMode Tech. (Available when Intel® EIST Technology is enabled)**

Select Enabled to use the Turbo Mode to boost system performance. The options are **Enabled** and Disabled.

**C1E Support**

Select Enabled to use the feature of Enhanced Halt State. C1E significantly reduces the CPU's power consumption by reducing the CPU's clock cycle and voltage during a "Halt State." The options are Disabled and **Enabled**.

**Intel® C-STATE Tech**

This feature allows the user to set Processor Idle state for power saving. The options are Disabled and **Enabled**.

**C-State package limit setting (Available when Intel® C-State Tech is enabled)**

If set to Auto, the AMI BIOS will automatically set the limit on the C-State package register. The options are **Auto**, C1, C3, C6 and C7.

**C1 Auto Demotion**

Select Enable for the CPU to conditionally demote C3, C6 or C7 requests to C1 based on un-core auto-demote information. The options are Disabled and **Enabled**.

**C3 Auto Demotion**

Select Enable for the CPU to conditionally demote C6 or C7 requests to C3 based on un-core auto-demote information. The options are Disabled and **Enabled**.

**ACPI T State**

Select Enabled to allow the BIOS to report processor throttling in ACPI. The options are Enabled and **Disabled**.

**►Advanced Chipset Control**

The items included in the Advanced Settings submenu are listed below:

**►CPU Bridge Configuration****Request Transaction ID**

This feature is used to determine how a QPI Transaction ID is initiated. The options are **Balanced** and IO Biased.

**QPI Links Speed**

This feature selects QPI's data transfer speed. The options are Slow-mode, and **Full Speed**.

**QPI Frequency**

This selects the desired QPI frequency. The options are **Auto**, 4.800 GT, 5.866GT, 6.400 GT.

**QPI L0s and L1**

This enables the QPI power state to low power. L0s and L1 are automatically selected by the motherboard. The options are **Disabled** and Enabled.

---

### Memory Frequency

This feature forces a DDR3 frequency slower than what the system has detected. The available options are **Auto**, Force DDR-800, Force DDR-1066, and Force DDR-1333.

### Memory Mode

The options are **Independent**, Channel Mirror, and Lockstep.

Independent - All DIMMs are available to the operating system.

Channel Mirror - The motherboard maintains two identical copies of all data in Channel 1 and Channel 2 memory for redundancy.

Lockstep - The motherboard uses two areas of memory to run the same set of operations in parallel.

### Demand Scrubbing

A memory error-correction scheme where the Processor writes corrected data back into the memory block from where it was read by the Processor. The options are Enabled and **Disabled**.

### Patrol Scrubbing

A memory error-correction scheme that works in the background looking for and correcting resident errors. The options are Enabled and **Disabled**.

### Throttling - Closed Loop

Throttling improves reliability and reduces power in the processor by automatic voltage control during processor idle states. The options are Disabled and **Enabled**.

## ► North Bridge Configuration

This feature allows the user to configure the settings for the Intel North Bridge.

### Intel I/O AT

This feature works with the Intel I/O AT (Acceleration Technology) to accelerate the performance of TOE devices. (**Note:** A TOE device is a specialized, dedicated processor that is installed on an add-on card or a network card to handle some or all packet processing of this add-on card.) When this feature is set to Enabled, it will enhance overall system performance by providing direct memory access for data transferring. The options are **Enabled** and Disabled.

### DCA (Direct Cache Access) Technology (Available when Intel I/O AT is enabled)

This feature works in conjunction with the Intel I/O AT (Acceleration Technology) to accelerate the performance of the TOE device. When this feature set to Enabled, it

will enhance overall system performance by providing direct cache access for data transferring. The options are **Enabled** and Disabled.

### **DCA Prefetch Delay**

A DCA Prefetch is used with TOE components to prefetch data in order to shorten execution cycles and maximize data processing efficiency. Prefetching too frequently can saturate the cache directory and delay necessary cache accesses. This feature reduces or increases the frequency the system prefetches data. The options are [8], [16], **[32]**, [40], [48], [56], [64], [72], [80], [88], [96], [104], [112], [120]

### **Intel VT-d**

Select Enabled to enable Intel's Virtualization Technology support for Direct I/O VT-d by reporting the I/O device assignments to VMM through the DMAR ACPI Tables. This feature offers fully-protected I/O resource-sharing across the Intel platforms, providing the user with greater reliability, security and availability in networking and data-sharing. The settings are Enabled and **Disabled**.

### **Active State Power Management**

Select Enabled to start Active-State Power Management for signal transactions between L0 and L1 Links on the PCI Express Bus. This maximizes power-saving and transaction speed. The options are Enabled and **Disabled**.

### **IOH PCIE Max Payload Size**

Some add-on cards perform faster with the coalesce feature, which limits the payload size to 128B; while others, with a payload size of 256B which inhibits the coalesce feature. Please refer to your add-on card user guide for the desired setting. The options are **256B** and 128MB.

## **► South Bridge Configuration**

This feature allows the user to configure the settings for the Intel South Bridge.

### **USB Functions**

This feature allows the user to decide the number of onboard USB ports to be enabled. The Options are: Disabled, and **Enabled**. (If this item is set to Enabled, USB 2.0 Controller will be enabled.)

### **Legacy USB Support**

Select Enabled to use Legacy USB devices. If this item is set to Auto, Legacy USB support will be automatically enabled if a legacy USB device is installed on the motherboard, and vice versa. The settings are Disabled, **Enabled** and Auto.

### **Port64h/60h Emulation**

Select Enabled to enable 64h/60h emulation for complete USB keyboard support for operating systems that are not compatible with USB devices. The options are Enabled and **Disabled**.

### **USB 2.0 Controller**

Select Enabled to activate USB 2.0 Controller. The options are **Enabled** and Disabled. (**Note:** If the item - USB Functions is enabled, USB 2.0 Controller will always be enabled. When the item - USB Functions is set to Disabled, the user has the option to enable or disable USB 2.0 Controller.)

### **USB 2.0 Controller Mode**

This setting allows you to select the USB 2.0 Controller mode. The options are **Hi-Speed (480 Mbps)** and Full Speed (12 Mbps).

### **BIOS EHCI Hand-Off**

Select Enabled to enable BIOS Enhanced Host Controller Interface support to provide a workaround solution for an operating system that does not have EHCI Hand-Off support. When enabled, the EHCI Interface will be changed from the BIOS-controlled to the OS-controlled. The options are Disabled and **Enabled**.

### **HDA Controller**

Select Enabled to activate the onboard High-Definition Audio controller. The options are **Enabled** and Disabled.

### **Route Port 80h Cycle to**

Use this item to decide where to route Port 80h Cycle to. The Options are **LPC** and PCI.

## **► IDE/SATA Configuration**

When this submenu is selected, the AMI BIOS automatically detects the presence of the IDE devices and displays the following items.

### **SATA#1 Configuration**

If Compatible is selected, it sets SATA#1 to legacy compatibility mode, while selecting Enhanced sets SATA#1 to native SATA mode. The options are Disabled, Compatible and **Enhanced**.

#### **Configure SATA#1 as**

This feature allows the user to select the drive type for SATA#1. The options are **IDE**, RAID and AHCI. (When the option-RAID is selected, the item-ICH RAID Code Base will appear.)

**ICH RAID Code Base (This feature is available when the option-RAID is selected)**

Select Intel to enable Intel's SATA RAID firmware to configure Intel's SATA RAID settings. Select Adaptec to enable Adaptec's SATA RAID firmware to configure Adaptec's SATA RAID settings. The options are **Intel** and Adaptec.

**SATA#2 Configuration (This feature is available when the option-IDE is selected)**

Selecting Enhanced will set SATA#2 to native SATA mode. The options are Disabled, and **Enhanced**.

**IDE Detect Timeout (sec)**

Use this item to set the time-out value for the BIOS to detect the ATA, ATAPI devices installed in the system. The options are 0 (sec), 5, 10, 15, 20, 25, 30, and **35**.

**Primary IDE Master/Slave, Secondary IDE Master/Slave, Third IDE Master, and Fourth IDE Master**

These settings allow the user to set the parameters of Primary IDE Master/Slave, Secondary IDE Master/Slave, Third and Fourth IDE Master slots. Hit <Enter> to activate the following submenu screen for detailed options of these items. Set the correct configurations accordingly. The items included in the submenu are:

**Type**

Select the type of device connected to the system. The options are Not Installed, **Auto**, CD/DVD and ARMD.

**LBA/Large Mode**

LBA (Logical Block Addressing) is a method of addressing data on a disk drive. In the LBA mode, the maximum drive capacity is 137 GB. For drive capacities over 137 GB, your system must be equipped with a 48-bit LBA mode addressing. If not, contact your manufacturer or install an ATA/133 IDE controller card that supports 48-bit LBA mode. The options are Disabled and **Auto**.

**Block (Multi-Sector Transfer)**

Block Mode boosts the IDE drive performance by increasing the amount of data transferred. Only 512 bytes of data can be transferred per interrupt if Block Mode is not used. Block Mode allows transfers of up to 64 KB per interrupt. Select Disabled to allow data to be transferred from and to the device one sector at a time. Select Auto to allow data transfer from and to the device occur multiple sectors at a time if the device supports it. The options are **Auto** and Disabled.

### **PIO Mode**

The IDE PIO (Programmable I/O) Mode programs timing cycles between the IDE drive and the programmable IDE controller. As the PIO mode increases, the cycle time decreases. The options are **Auto**, 0, 1, 2, 3, and 4.

Select Auto to allow the AMI BIOS to automatically detect the PIO mode. Use this value if the IDE disk drive support cannot be determined.

Select 0 to allow the AMI BIOS to use PIO mode 0. It has a data transfer rate of 3.3 MBs.

Select 1 to allow the AMI BIOS to use PIO mode 1. It has a data transfer rate of 5.2 MBs.

Select 2 to allow the AMI BIOS to use PIO mode 2. It has a data transfer rate of 8.3 MBs.

Select 3 to allow the AMI BIOS to use PIO mode 3. It has a data transfer rate of 11.1 MBs.

Select 4 to allow the AMI BIOS to use PIO mode 4. It has a data transfer bandwidth of 32-Bits. Select Enabled to enable 32-Bit data transfer.

### **DMA Mode**

Select Auto to allow the BIOS to automatically detect IDE DMA mode when the IDE disk drive support cannot be determined.

Select SWDMA0 to allow the BIOS to use Single Word DMA mode 0. It has a data transfer rate of 2.1 MBs.

Select SWDMA1 to allow the BIOS to use Single Word DMA mode 1. It has a data transfer rate of 4.2 MBs.

Select SWDMA2 to allow the BIOS to use Single Word DMA mode 2. It has a data transfer rate of 8.3 MBs.

Select MWDMA0 to allow the BIOS to use Multi Word DMA mode 0. It has a data transfer rate of 4.2 MBs.

Select MWDMA1 to allow the BIOS to use Multi Word DMA mode 1. It has a data transfer rate of 13.3 MBs.

Select MWDMA2 to allow the BIOS to use Multi-Word DMA mode 2. It has a data transfer rate of 16.6 MBs.

Select UDMA0 to allow the BIOS to use Ultra DMA mode 0. It has a data transfer rate of 16.6 MBs. It has the same transfer rate as PIO mode 4 and Multi Word DMA mode 2.

Select UDMA1 to allow the BIOS to use Ultra DMA mode 1. It has a data transfer rate of 25 MBs.



Select UDMA2 to allow the BIOS to use Ultra DMA mode 2. It has a data transfer rate of 33.3 MBs.

Select UDMA3 to allow the BIOS to use Ultra DMA mode 3. It has a data transfer rate of 44.4 MBs.

Select UDMA4 to allow the BIOS to use Ultra DMA mode 4. It has a data transfer rate of 66.6 MBs.

Select UDMA5 to allow the BIOS to use Ultra DMA mode 5. It has a data transfer rate of 100 MBs.

Select UDMA6 to allow the BIOS to use Ultra DMA mode 6. It has a data transfer rate of 133 MBs. The options are **Auto**, SWDMAn, MWDMAAn, and UDMAAn.

### **S.M.A.R.T.**

Self-Monitoring Analysis and Reporting Technology (SMART) can help predict impending drive failures. Select Auto to allow the AMI BIOS to automatically detect hard disk drive support. Select Disabled to prevent the AMI BIOS from using the S.M.A.R.T. Select Enabled to allow the AMI BIOS to use the S.M.A.R.T. to support hard drive disk. The options are Disabled, Enabled, and **Auto**.

### **32Bit Data Transfer**

Select Enable to enable the function of 32-bit IDE data transfer. The options are **Enabled** and Disabled.

## **►PCI/PnP Configuration**

### **Clear NVRAM**

This feature clears the NVRAM during system boot. The options are **No** and Yes.

### **Plug & Play OS**

Selecting Yes allows the OS to configure Plug & Play devices. (This is not required for system boot if your system has an OS that supports Plug & Play.) Select **No** to allow the AMI BIOS to configure all devices in the system.

### **PCI Latency Timer**

This feature sets the latency Timer of each PCI device installed on a PCI bus. Select 64 to set the PCI latency to 64 PCI clock cycles. The options are 32, **64**, 96, 128, 160, 192, 224 and 248.

### **PCI IDE BusMaster**

When enabled, the BIOS uses PCI bus mastering for reading/writing to IDE drives. The options are Disabled and **Enabled**.

### SR-IOV Support

Single Root I/O Virtualization is an industry-standard mechanism that allow devices to advertise their capability to be simultaneously shared among several virtual machines. SR-IOV is capable of partitioning a PCI function into several virtual interfaces for sharing the resources of a PCI Express device under a virtual environment. The options are **Disabled** and Enabled.

### Slot 2 PCIE X4 in X8 Slot, Slot 3 PCIE X4 in X16 Slot, Slot 4 PCI 33MHz, Slot 5 PCI 33MHz, Slot 6 PCIE X16

This feature allows you to Enable or Disable the Option ROM of a PCI slot specified. The options are **Enable** and Disable.

### Onboard LAN Option ROM Select

This feature allows the user to select the onboard LAN option ROM type. The options are iSCSI and **PXE**.

### Load Onboard LAN1 Option ROM/Load Onboard LAN2 Option ROM

Select Enabled to enable the onboard LAN1 or LAN2 Option ROM. This is to boot computer using a network interface. The options are Enabled and **Disabled**.

### Load Onboard SAS Option ROM

Select Enabled to enable the onboard SAS Option ROM. This is to boot computer using a network interface. The options are **Enabled** and Disabled.

### Boot Graphics Adapter Priority

This feature allows the user to select the priority graphics adapter for system boot. The options are **Slot 6** and Offboard VGA.

## ► Super IO Device Configuration

### Serial Port1 Address/ Serial Port2 Address

This option specifies the base I/O port address and the Interrupt Request address of Serial Port 1 and Serial Port 2. Select Disabled to prevent the serial port from accessing any system resources. When this option is set to Disabled, the serial port physically becomes unavailable. Select 3F8/IRQ4 to allow the serial port to use 3F8 as its I/O port address and IRQ 4 for the interrupt address. The options for Serial Port1 are Disabled, **3F8/IRQ4**, 3E8/IRQ4, 2E8/IRQ3. The options for Serial Port2 are Disabled, **2F8/IRQ3**, 3E8/IRQ4, and 2E8/IRQ3.

## ► Remote Access Configuration

### Remote Access

This allows the user to enable the Remote Access feature. The options are **Disabled** and Enabled.

If Remote Access is set to Enabled, the following items will display:

### Serial Port Number

This feature allows the user decide which serial port to be used for Console Redirection. The options are **COM 1** and COM 2.

### Base Address, IRQ

This item displays the based address and IRQ of the serial port specified.

### Serial Port Mode

This feature allows the user to set the serial port mode for Console Redirection. The options are **115200 8, n 1**; 57600 8, n, 1; 38400 8, n, 1; 19200 8, n, 1; and 9600 8, n, 1.

### Flow Control

This feature allows the user to set the flow control for Console Redirection. The options are **None**, Hardware, and Software.

### Redirection After BIOS POST

Select Disabled to turn off Console Redirection after Power-On Self-Test (POST). Select Always to keep Console Redirection active all the time after POST. (Note: This setting may not be supported by some operating systems.) Select Boot Loader to keep Console Redirection active during POST and Boot Loader. The options are Disabled, Boot Loader, and **Always**.

### Terminal Type

This feature allows the user to select the target terminal type for Console Redirection. The options are ANSI, **VT100**, and VT-UTF8.

### VT-UTF8 Combo Key Support

A terminal keyboard definition that provides a way to send commands from a remote console. Available options are **Enabled** and Disabled.

### Sredir Memory Display Delay

This feature defines the length of time in seconds to display memory information. The options are **No Delay**, Delay 1 Sec, Delay 2 Sec, and Delay 4 Sec.

## ► Hardware Health Monitor

This feature allows the user to monitor system health and review the status of each item as displayed.

### CPU Overheat Alarm

This option allows the user to select the CPU Overheat Alarm setting which determines when the CPU OH alarm will be activated to provide warning of possible CPU overheat.

 **Warning!** 1. Any temperature that exceeds the CPU threshold temperature predefined by the CPU manufacturer may result in CPU overheat or system instability. When the CPU temperature reaches this predefined threshold, the CPU and system cooling fans will run at full speed. 2. To avoid possible system overheating, please be sure to provide adequate airflow to your system.

The options are:

- **The Early Alarm:** Select this setting if you want the CPU overheat alarm (including the LED and the buzzer) to be triggered as soon as the CPU temperature reaches the CPU overheat threshold as predefined by the CPU manufacturer.
- **The Default Alarm:** Select this setting if you want the CPU overheat alarm (including the LED and the buzzer) to be triggered when the CPU temperature reaches about 5°C above the threshold temperature as predefined by the CPU manufacturer to give the CPU and system fans additional time needed for CPU and system cooling. In both the alarms above, please take immediate action as shown below.

### CPU1 Temperature/CPU2 Temperature/System Temperature

This feature displays current temperature readings for the CPU and the System.

The following items will be displayed for your reference only:

#### CPU1 Temperature/CPU2 Temperature

The CPU Temperatures feature will display the CPU temperature status as detected by the BIOS:

**Low** – This level is considered as the ‘normal’ operating state. The CPU temperature is well below the CPU ‘Temperature Tolerance’. The motherboard fans and CPU will run normally as configured in the BIOS (Fan Speed Control).

User intervention: No action required.

**Medium** – The processor is running warmer. This is a ‘precautionary’ level and generally means that there may be factors contributing to this condition, but the CPU is still within its normal operating state and below the CPU ‘Temperature Tolerance’.

The motherboard fans and CPU will run normally as configured in the BIOS. The fans may adjust to a faster speed depending on the Fan Speed Control settings.

User intervention: No action is required. However, consider checking the CPU fans and the chassis ventilation for blockage.

**High** – The processor is running hot. This is a ‘caution’ level since the CPU’s ‘Temperature Tolerance’ has been reached (or has been exceeded) and may activate an overheat alarm. The system may shut down if it continues for a long period to prevent damage to the CPU.

User intervention: If the system buzzer and Overheat LED has activated, take action immediately by checking the system fans, chassis ventilation and room temperature to correct any problems.

**Notes:**



The CPU thermal technology that reports absolute temperatures (Celsius/Fahrenheit) has been upgraded to a more advanced feature by Intel in its newer processors. The basic concept is each CPU is embedded by unique temperature information that the motherboard can read. This ‘Temperature Threshold’ or ‘Temperature Tolerance’ has been assigned at the factory and is the baseline on which the motherboard takes action during different CPU temperature conditions (i.e., by increasing CPU Fan speed, triggering the Overheat Alarm, etc). Since CPUs can have different ‘Temperature Tolerances’, the installed CPU can now send information to the motherboard what its ‘Temperature Tolerance’ is, and not the other way around. This results in better CPU thermal management.

Supermicro has leveraged this feature by assigning a temperature status to certain thermal conditions in the processor (Low, Medium and High). This makes it easier for the user to understand the CPU’s temperature status, rather than by just simply seeing a temperature reading (i.e., 25°C).

The information provided above is for your reference only. For more information on thermal management, please refer to Intel’s Web site at [www.Intel.com](http://www.Intel.com).

**System Temperature:** The system temperature will be displayed (in degrees in Celsius and Fahrenheit) as it is detected by the BIOS.

### **Fan Speed Readings**

This feature displays the fan speed readings from Fan1 through Fan6.

### **Fan Speed Control Modes**

This feature allows the user to decide how the system controls the speeds of the onboard fans. The CPU temperature and the fan speed are correlative. When the CPU on-die temperature increases, the fan speed will also increase for effective system cooling. Select "Full Speed/FS" to allow the onboard fans to run at full speed for maximum cooling. The FS setting is recommended for special system

configuration or debugging. Select "Performance/PF" for better system cooling. The PF setting is recommended for high-power-consuming and high-density systems. Select "Balanced/BL" for the onboard fans to run at a speed that will balance the needs between system cooling and power saving. The BL setting is recommended for regular systems with normal hardware configurations. Select "Energy Saving/ES" for best power efficiency and maximum quietness. The Options are: Full Speed/FS, Performance/PF, **Balanced/BL**, and Energy Saving/ES.

### **Voltage Readings**

The following voltage readings will be displayed.

Vcore1, Vcore2, 1.5V, 5VDD, 5VSB, 12V, -12V, 3.3Vcc, 3.3VSB, VBAT and Vtt.

### **► ACPI Configuration**

Use this feature to configure Advanced Configuration and Power Interface (ACPI) power management settings for your system.

#### **High Precision Event Timer**

Select Enabled to activate the High Precision Event Timer (HPET) that produces periodic interrupts at a much higher frequency than a Real-time Clock (RTC) does in synchronizing multimedia streams, providing smooth playback and reducing the dependency on other timestamp calculation devices, such as an x86 RDTSC Instruction embedded in the CPU. The High Performance Event Timer is used to replace the 8254 Programmable Interval Timer. The options are **Enabled** and Disabled.

#### **USB Device Wakeup**

Select Enable to "wake-up" the system via a USB device when the system is in S3 or S4 State. The options are Enabled and **Disabled**.

#### **ACPI Aware O/S**

Enable ACPI support if it is supported by the OS to control ACPI through the Operating System. Otherwise, disable this feature. The options are **Yes** and No.

#### **Suspend Mode**

This setting allows you to configure the ACPI (Advanced Configuration and Power Interface) state for your system when it is in the Suspend mode. The options are **S1 (POS)**, S3 (STR) and Auto.

#### **ACPI APIC Support**

Select Enabled to include the ACPI APIC Table Pointer in the RSDT (Root System Description Table) pointer list. The options are **Enabled** and Disabled.

**APIC ACPI SCI IRQ**

When this item is set to Enabled, APIC ACPI SCI IRQ is supported by the system. The options are Enabled and **Disabled**.

**Headless Mode**

This feature is used to enable system to function without a keyboard, monitor and/or mouse attached. The options are Enabled and **Disabled**.

**ACPI Version Features**

The options are ACPI v1.0, **ACPI v2.0** and ACPI v3.0. Please refer to ACPI's website for further explanation: <http://www.acpi.info/>.

**NUMA Support**

Select Enabled to enable Non-Uniform Memory Access support to enhance software execution performance for NUMA-aware operating systems. Select Disabled for better memory accessibility for non-NUMA operating systems. The options are **Enabled** and Disabled.

**►Event Log Configuration****View Event Log**

Use this option to view the System Event Log.

**Mark all event as read**

This option marks all events as read. The options are OK and Cancel.

**Clear event log**

This option clears the Event Log memory of all messages. The options are OK and Cancel.

**PCIe Error Log**

Use this option to enable PCI-Exp. error (PERR) logging. The options are Yes and **No**.

**Memory Error Log**

Use this option to enable memory. error logging. The options are **Yes** and No.

## 4-4 Security Settings

The AMI BIOS provides a Supervisor and a User password. If you use both passwords, the Supervisor password must be set first.

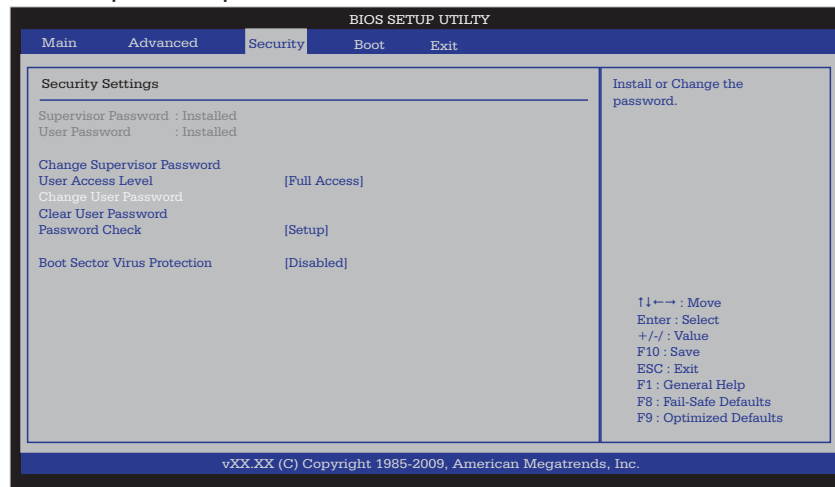

### Supervisor Password

This item indicates if a Supervisor password has been entered for the system. "Not Installed" means a Supervisor password has not been used.

### User Password

This item indicates if a user password has been entered for the system. "Not Installed" means that a user password has not been used.

### Change Supervisor Password

Select this feature and press <Enter> to access the submenu, and then type in a new Supervisor Password.

### User Access Level (Available when Supervisor Password is set as above)

Available options are **Full Access**: grants full User read and write access to the Setup Utility, **View Only**: allows access to the Setup Utility but the fields cannot be changed, **Limited**: allows only limited fields to be changed such as Date and Time, **No Access**: prevents User access to the Setup Utility.

### Change User Password

Select this feature and press <Enter> to access the submenu, and then type in a new User Password.

### Clear User Password (Available only when User Password has been set)

This item allows you to clear a user password after it has been entered.

### Password Check

This item allows you to check a password after it has been entered. The options are **Setup** and **Always**.



## Boot Sector Virus Protection

When Enabled, the AMI BIOS displays a warning when any program (or virus) issues a Disk Format command or attempts to write to the boot sector of the hard disk drive. The options are Enabled and **Disabled**.

## 4-5 Boot Configuration

Use this feature to configure boot settings.

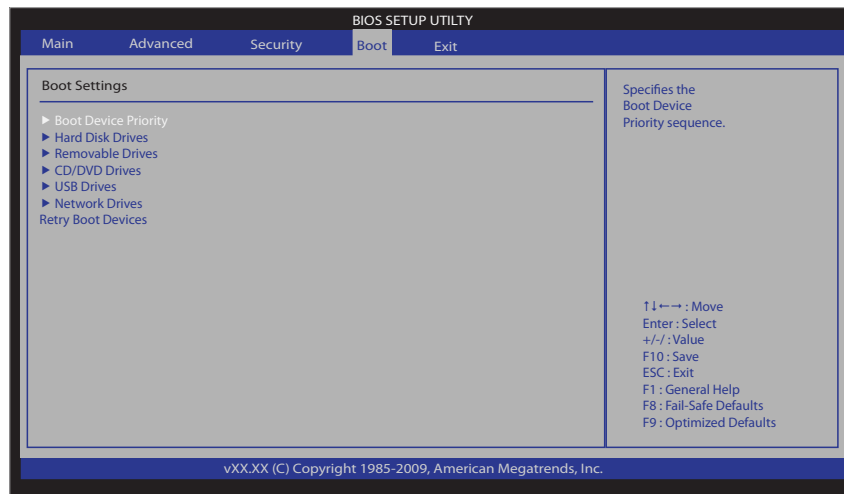

### ► Boot Device Priority

This feature allows the user to specify the sequence of priority for the Boot Device. The settings are 1st boot device, 2nd boot device, 3rd boot device, 4th boot device, 5th boot device and Disabled.

- 1st Boot Device

### ► Hard Disk Drives

This feature allows the user to specify the boot sequence from all available hard disk drives. The settings are Disabled and a list of all hard disk drives that have been detected (i.e., 1st Drive, 2nd Drive, 3rd Drive, etc).

- 1st Drive

### ► Removable Drives

This feature allows the user to specify the boot sequence from available Removable Drives. The settings are 1st boot device, 2nd boot device, and Disabled.

- 1st Drive
- 2nd Drive

### ► **CD/DVD Drives**

This feature allows the user to specify the boot sequence from available CD/DVD Drives (i.e., 1st Drive, 2nd Drive, etc).

### ► **USB Drives**

This feature allows the user to specify the boot sequence from available USB Drives (i.e., 1st Drive, 2nd Drive, etc).

### ► **Network Drives**

This feature allows the user to specify the boot sequence from available Network Drives (i.e., 1st Drive, 2nd Drive, etc).

### **Retry Boot Devices**

Select Enabled to enable Retry Boot Devices support to allow the system to attempt to boot from a specific boot device after a boot failure. The options are Enabled and **Disabled**.

## 4-6 Exit Options

Select the Exit tab from the AMI BIOS Setup Utility screen to enter the Exit BIOS Setup screen.

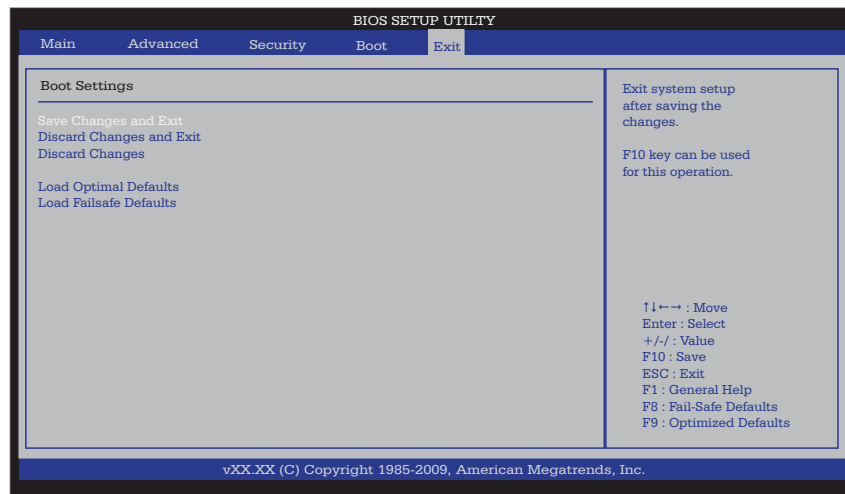

### Save Changes and Exit

When you have completed the system configuration changes, select this option to leave the BIOS Setup Utility and reboot the computer, so the new system configuration parameters can take effect. Select Save Changes and Exit from the Exit menu and press <Enter>.

### Discard Changes and Exit

Select this option to quit the BIOS Setup without making any permanent changes to the system configuration, and reboot the computer. Select Discard Changes and Exit from the Exit menu and press <Enter>.

### Discard Changes

Select this option and press <Enter> to discard all the changes and return to the AMI BIOS Utility Program.

### Load Optimal Defaults

To set this feature, select Load Optimal Defaults from the Exit menu and press <Enter>. Then, select OK to allow the AMI BIOS to automatically load Optimal Defaults to the BIOS Settings. The Optimal settings are designed for maximum system performance, but may not work best for all computer applications.

### Load Fail-Safe Defaults

To set this feature, select Load Fail-Safe Defaults from the Exit menu and press <Enter>. The Fail-Safe settings are designed for maximum system stability, but not for maximum performance.

## Notes

---

---

## Appendix A

### BIOS Error Beep Codes

During the POST (Power-On Self-Test) routines, which are performed each time the system is powered on, errors may occur.

**Non-fatal errors** are those which, in most cases, allow the system to continue the boot-up process. The error messages normally appear on the screen.

**Fatal errors** will not allow the system to continue the boot-up procedure. If a fatal error occurs, you should consult with your system manufacturer for possible repairs.

These fatal errors are usually communicated through a series of audible beeps. The numbers on the fatal error list correspond to the number of beeps for the corresponding error.

#### A-1 BIOS Error Beep Codes

BIOS Error Beep Codes		
Beep Code	Error Message	Description
1 beep	Refresh	Circuits have been reset. (Ready to power up)
5 short beeps + 1 long beep	Memory error	No memory detected in the system
8 beeps	Display memory read/write error	Video adapter missing or with faulty memory
1 continuous beep w/ Front Panel OH LED on	System Overheat	1 continuous beep with the front panel OH LED on

## Notes

## Appendix B

### Installing the Windows OS

After all hardware components have been installed, you must first configure Intel South Bridge RAID Settings before you install the Windows OS and other software drivers. To configure RAID settings, please refer to RAID Configuration User Guides posted on our website at [www.supermicro.com/support/manuals](http://www.supermicro.com/support/manuals).

#### B-1 Installing the Windows OS to a RAID System

1. Insert Microsoft's Windows XP/2003/2008/Vista Setup CD in the CD Driver, and the system will start booting up from CD.
2. Press the <F6> key when the message-" Press F6 if you need to install a third party SCSI or RAID driver" displays.
3. When the Windows OS Setup screen appears, press "S" to specify additional device(s).
4. Insert the driver diskette-"Intel AA Windows XP/2003/2008/Vista Driver for ICH10R" into Drive A: and press the <Enter> key.
5. Choose the Intel(R) ICH10R *SATA RAID Controller* from the list indicated in the Windows OS Setup Screen, and press the <Enter> key.
6. Press the <Enter> key to continue the installation process. (If you need to specify any additional devices to be installed, do it at this time.) Once all devices are specified, press the <Enter> key to continue with the installation.
7. From the Windows OS Setup screen, press the <Enter> key. The Windows OS Setup will automatically load all device files and then, continue the Windows OS installation.
8. After the Windows OS Installation is completed, the system will automatically reboot.

## **B-2 Installing the Windows OS to a Non-RAID System**

1. Insert Microsoft's Windows XP/Windows 2003/Windows 2008/Windows Vista Setup CD in the CD Driver, and the system will start booting up from CD.
2. Continue with the OS installation. The Windows OS Setup screen will display.
3. From the Windows OS Setup screen, press the <Enter> key. The Windows OS Setup will automatically load all device files and then continue with the Windows OS installation.
4. After the Windows OS Installation is completed, the system will automatically reboot.
5. Insert the Supermicro Setup CD that came with your motherboard into the CD Drive during system boot, and the main screen will display.



## Appendix C

### Software Installation Instructions

#### C-1 Installing Software Programs

After you have installed the Windows Operating System, a screen as shown below will appear. You are ready to install software programs and drivers that have not yet been installed. To install these software programs and drivers, click the icons to the right of these items.

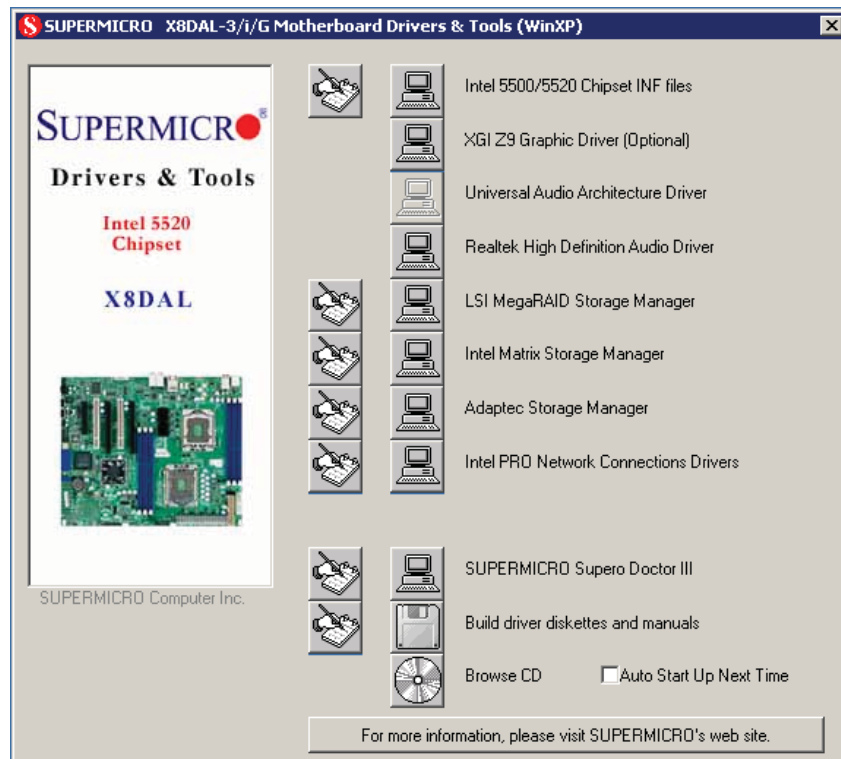

**Driver/Tool Installation Display Screen**



#### Notes:

1. Click the icons showing a hand writing on the paper to view the readme files for each item. Click on a computer icon to the right of an item to install an item (from top to the bottom) one at a time. After installing each item, you must reboot the system before proceeding with the next item on the list. The bottom icon with a CD on it allows you to view the entire contents of the CD.

2. When making a storage driver diskette by booting into a Driver CD, please set the SATA Configuration to "Compatible Mode" and configure SATA as IDE in the BIOS Setup. After making the driver diskette, be sure to change the SATA settings back to your original settings.

## C-2 Configuring Supero Doctor III

The Supero Doctor III program is a Web-based management tool that supports remote management. It includes Remote and Local Management tools. The local management is called the SD III Client. The Supero Doctor III program included on the CDROM that came with your motherboard allows you to monitor the environment and operations of your system. Supero Doctor III displays crucial system information such as CPU temperature, system voltages and fan status. See the Figure below for a display of the Supero Doctor III interface.



**Note:** 1 The default user name and password are ADMIN.

**Note 2:** In the Windows OS environment, the Supero Doctor III settings take precedence over the BIOS settings. When first installed, Supero Doctor III adopts the temperature threshold settings previously set in BIOS. Any subsequent changes to these thresholds must be made within Supero Doctor, since the SD III settings override the BIOS settings. For the Windows OS to adopt the BIOS temperature threshold settings, please change the SDIII settings to be the same as those set in BIOS.

### Supero Doctor III Interface Display Screen-I (Health Information)



## Supero Doctor III Interface Display Screen-II (Remote Control)



 **Note:** SD III Software Revision 1.0 can be downloaded from our Web site at: [ftp://ftp.supermicro.com/utility/Supero\\_Doctor\\_III/](ftp://ftp.supermicro.com/utility/Supero_Doctor_III/). You can also download SDIII User's Guide at: <http://www.supermicro.com/PRODUCT/Manuals/SDIII/UserGuide.pdf>. For Linux, we will still recommend that you use Supero Doctor II.

## Notes

(Disclaimer Continued)

The products sold by Supermicro are not intended for and will not be used in life support systems, medical equipment, nuclear facilities or systems, aircraft, aircraft devices, aircraft/emergency communication devices or other critical systems whose failure to perform be reasonably expected to result in significant injury or loss of life or catastrophic property damage. Accordingly, Supermicro disclaims any and all liability, and should buyer use or sell such products for use in such ultra-hazardous applications, it does so entirely at its own risk. Furthermore, buyer agrees to fully indemnify, defend and hold Supermicro harmless for and against any and all claims, demands, actions, litigation, and proceedings of any kind arising out of or related to such ultra-hazardous use or sale.