

SUPERO[®]

H8SCM
H8SCM-F

USER'S MANUAL

Revision 1.2c

The information in this User's Manual has been carefully reviewed and is believed to be accurate. The vendor assumes no responsibility for any inaccuracies that may be contained in this document, and makes no commitment to update or to keep current the information in this manual, or to notify any person or organization of the updates. **Please Note: For the most up-to-date version of this manual, please see our web site at www.supermicro.com.**

Super Micro Computer, Inc. ("Supermicro") reserves the right to make changes to the product described in this manual at any time and without notice. This product, including software and documentation, is the property of Supermicro and/or its licensors, and is supplied only under a license. Any use or reproduction of this product is not allowed, except as expressly permitted by the terms of said license.

IN NO EVENT WILL Super Micro Computer, Inc. BE LIABLE FOR DIRECT, INDIRECT, SPECIAL, INCIDENTAL, SPECULATIVE OR CONSEQUENTIAL DAMAGES ARISING FROM THE USE OR INABILITY TO USE THIS PRODUCT OR DOCUMENTATION, EVEN IF ADVISED OF THE POSSIBILITY OF SUCH DAMAGES. IN PARTICULAR, SUPER MICRO COMPUTER, INC. SHALL NOT HAVE LIABILITY FOR ANY HARDWARE, SOFTWARE, OR DATA STORED OR USED WITH THE PRODUCT, INCLUDING THE COSTS OF REPAIRING, REPLACING, INTEGRATING, INSTALLING OR RECOVERING SUCH HARDWARE, SOFTWARE, OR DATA.

Any disputes arising between manufacturer and customer shall be governed by the laws of Santa Clara County in the State of California, USA. The State of California, County of Santa Clara shall be the exclusive venue for the resolution of any such disputes. Supermicro's total liability for all claims will not exceed the price paid for the hardware product.

FCC Statement: Refer to Supermicro's web site for FCC Compliance Information.

California Best Management Practices Regulations for Perchlorate Materials: This Perchlorate warning applies only to products containing CR (Manganese Dioxide) Lithium coin cells. "Perchlorate Material-special handling may apply. See www.dtsc.ca.gov/hazardouswaste/perchlorate".

WARNING: Handling of lead solder materials used in this product may expose you to lead, a chemical known to the State of California to cause birth defects and other reproductive harm.

Manual Revision 1.2c

Release Date: March 11, 2014

Unless you request and receive written permission from Super Micro Computer, Inc., you may not copy any part of this document.

Information in this document is subject to change without notice. Other products and companies referred to herein are trademarks or registered trademarks of their respective companies or mark holders.

Copyright © 2014 by Super Micro Computer, Inc.
All rights reserved.

Printed in the United States of America

Preface

About This Manual

This manual is written for system integrators, PC technicians and knowledgeable PC users. It provides information for the installation and use of the H8SCM(-F) serverboard.

The H8SCM(-F) serverboard is based on the AMD® SR5650/SP5100 chipset and supports one AMD Socket C32 type processor with up to 32 GB of ECC/Non-ECC UDIMM or up to 128 GB of ECC RDIMM SDRAM memory. The H8SCM serverboard does not have IPMI capability, whereas the H8SCM-F serverboard does.

Please refer to the motherboard specifications pages on our web site for updates on supported processors (<http://www.supermicro.com/aplus/>). This product is intended to be professionally installed.

Manual Organization

Chapter 1 includes a checklist of what should be included in your motherboard box, describes the features, specifications and performance of the motherboard and provides detailed information about the chipset.

Chapter 2 begins with instructions on handling static-sensitive devices. Read this chapter when installing the processor(s) and memory modules and when installing the motherboard in a chassis. Also refer to this chapter to connect the hard disk drives, the various ports, and the power and reset buttons and the system LEDs.

If you encounter any problems, see **Chapter 3**, which describes troubleshooting procedures for the video, the memory and the setup configuration stored in CMOS. For quick reference, a general FAQ (Frequently Asked Questions) section is provided. Instructions are also included for contacting technical support. In addition, you can visit our web site for more detailed information.

Chapter 4 includes an introduction to BIOS and provides detailed information on running the CMOS Setup utility.

Appendix A provides BIOS Error Beep Code Messages.

Appendix B lists BIOS POST Checkpoint Codes.

Table of Contents

Chapter 1 Introduction

1-1	Overview	1-1
	Checklist.....	1-1
1-2	Contacting Supermicro.....	1-2
	H8SCM(-F) Quick Reference.....	1-5
1-3	Serverboard Features	1-7
1-4	Chipset Overview	1-10
	AMD SR5650/SP5100 Chipset	1-10
	HyperTransport Technology	1-10
1-5	PC Health Monitoring.....	1-10
1-6	Power Configuration Settings.....	1-11
1-7	Power Supply	1-12
1-8	Super I/O.....	1-13

Chapter 2 Installation

2-1	Standardized Warning Statements	2-1
	About Standardized Warning Statements	2-1
2-2	Static-Sensitive Devices.....	2-4
	Precautions	2-4
	Unpacking	2-4
2-3	Processor and Heatsink Installation.....	2-5
2-4	Mounting the Serverboard into a Chassis	2-7
2-5	Installing Memory.....	2-7
	DIMM Module Population Configuration	2-9
2-6	PCI Expansion Cards.....	2-9
2-7	I/O Port and Control Panel Connections	2-10
	Front Control Panel.....	2-10
2-8	Connector Definitions	2-11
	Power Connectors	2-11
	Power Connector.....	2-11
	Reset Connector	2-11
	Power Fail LED	2-12
	Overheat/Fan Fail LED (OH).....	2-12
	NIC2 (Activity) LED	2-12
	NIC1 (Activity) LED	2-12
	HDD LED.....	2-12
	Power On LED	2-13

- NMI Button 2-13
- LAN1/2 (Ethernet Ports)..... 2-13
- Universal Serial Bus Ports 2-13
- Chassis Intrusion 2-14
- USB Headers 2-14
- Serial Ports..... 2-14
- Fan Headers..... 2-14
- SGPIO 2-15
- Trusted Platform Module Header 2-15
- Power SMB (I²C) Connector 2-15
- ATX PS/2 Keyboard and PS/2 Mouse Ports..... 2-16
- Power LED/Speaker..... 2-16
- Compact Flash Card PWR Connector..... 2-16
- Overheat LED..... 2-17
- Wake-On-LAN 2-17
- JIPMB (H8SCM-F only)..... 2-17
- Video Connector..... 2-17
- 2-9 Jumper Settings 2-18
 - Explanation of Jumpers 2-18
 - CMOS Clear..... 2-18
 - LAN1/2 Enable/Disable 2-19
 - VGA Enable/Disable..... 2-19
 - Compact Flash Master/Slave Select..... 2-19
 - Watch Dog Enable/Disable 2-19
 - Onboard Speaker Enable/Disable..... 2-20
 - I2C to PCI-Express Slot 2-20
 - BMC Jumper 2-20
- 2-10 Onboard Indicators..... 2-21
 - GLAN LEDs..... 2-21
 - IPMI Dedicated LAN LEDs..... 2-21
 - BMC Heartbeat LED 2-21
 - Power LED 2-22
- 2-11 IDE and SATA Drive Connections..... 2-22
 - SATA Ports 2-22
 - IDE Connector..... 2-23
- 2-12 Enabling SATA RAID..... 2-24
 - Serial ATA (SATA)..... 2-24
 - Installing the OS/SATA Driver 2-24

Building a Driver Diskette.....	2-24
Enabling SATA RAID in the BIOS.....	2-25
Using the DotHill and Adaptec RAID Utility	2-27
Installing the RAID Driver During OS Installation.....	2-27
2-13 Installing Drivers.....	2-28
Supero Doctor III.....	2-29
2-14 Serverboard Battery.....	2-31
Chapter 3 Troubleshooting	
3-1 Troubleshooting Procedures.....	3-1
Before Power On	3-1
No Power	3-1
No Video	3-2
Memory Errors	3-2
Losing the System's Setup Configuration.....	3-2
3-2 Technical Support Procedures.....	3-2
3-3 Frequently Asked Questions.....	3-3
3-4 Returning Merchandise for Service.....	3-4
Chapter 4 BIOS	
4-1 Introduction.....	4-1
4-2 Main Menu	4-2
4-3 Advanced Settings Menu	4-2
4-3 Security Menu	4-16
4-4 Boot Menu.....	4-16
4-5 Exit Menu	4-17
Appendix A BIOS Error Beep Codes	
Appendix B BIOS POST Checkpoint Codes	
B-1 Uncompressed Initialization Codes.....	B-1
B-2 Bootblock Recovery Codes.....	B-2
B-3 Uncompressed Initialization Codes.....	B-3

Chapter 1

Introduction

1-1 Overview

Checklist

Congratulations on purchasing your computer motherboard from an acknowledged leader in the industry. Supermicro boards are designed with the utmost attention to detail to provide you with the highest standards in quality and performance.

Please check that the following items have all been included with your motherboard. If anything listed here is damaged or missing, contact your retailer.

- One (1) H8SCM(-F) serverboard
- One (1) I/O shield (MCP-260-00027-0N)
- One (1) Retention bracket (BKT-0012L)
- One (1) 9-pin serial port cable (CBL-0010L)
- One (1) ATA 66/100 IDE LP cable (CBL-0036L-03)
- Six (6) 2ft. Amphenol, SATA cable (CBL-0044L)

Note: For your system to work properly, please follow the links below to download all necessary drivers/utilities and the user's manual for your motherboard.

- Supermicro product manuals: <http://www.supermicro.com/support/manuals/>
- Product drivers and utilities: <ftp://ftp.supermicro.com>
- Product safety information:
http://super-dev/about/policies/safety_information.cfm
- If you have any questions, please contact our support team at:
support@supermicor.com

1-2 Contacting Supermicro

Headquarters

Address: Super Micro Computer, Inc.
980 Rock Ave.
San Jose, CA 95131 U.S.A.

Tel: +1 (408) 503-8000

Fax: +1 (408) 503-8008

Email: marketing@supermicro.com (General Information)
support@supermicro.com (Technical Support)

Web Site: www.supermicro.com

Europe

Address: Super Micro Computer B.V.
Het Sterrenbeeld 28, 5215 ML
's-Hertogenbosch, The Netherlands

Tel: +31 (0) 73-6400390

Fax: +31 (0) 73-6416525

Email: sales@supermicro.nl (General Information)
support@supermicro.nl (Technical Support)
rma@supermicro.nl (Customer Support)

Web Site: www.supermicro.com

Asia-Pacific

Address: Super Micro Computer, Inc.
3F, No. 150, Jian 1st Rd.
Zhonghe Dist., New Taipei City 235
Taiwan (R.O.C)

Tel: +886-(2) 8226-3990

Fax: +886-(2) 8226-3992

Email: support@supermicro.com.tw

Tel: +886-(2)-8226-3990

Web Site: www.supermicro.com.tw

Figure 1-1. H8SCM(-F) Image

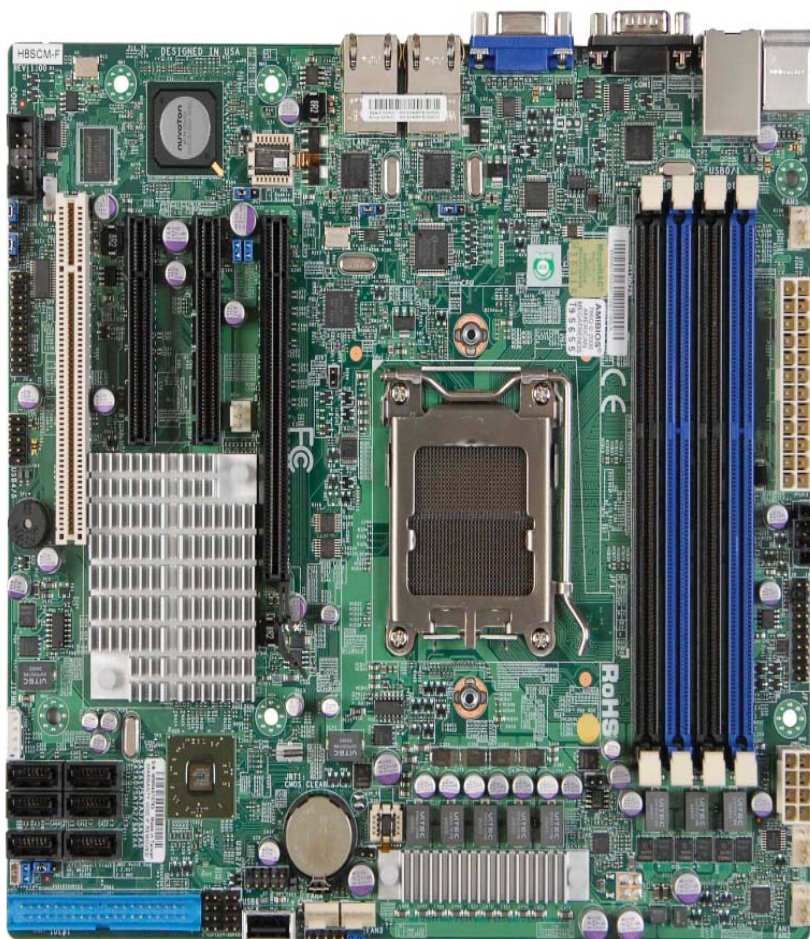
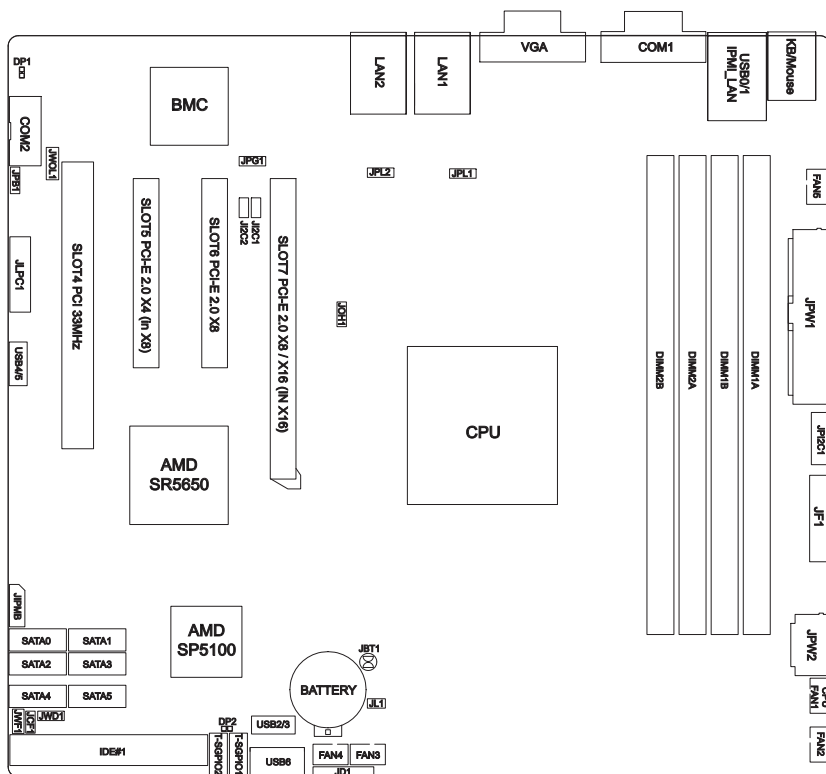

Figure 1-2. H8SCM(-F) Serverboard Layout
(not drawn to scale)



Notes:

Jumpers not indicated are for test purposes only.
Not all ports, jumpers or LED Indicators are available on all serverboards.

H8SCM(-F) Quick Reference		
Jumper	Description	Default Setting
JBT1	CMOS Clear	(See Section 2-8)
JCF1	Compact Flash Master/Slave	Closed (Master)
JI2C1/JI2C2	I2C to PCI-E Slot Enable/Disable	Both Open (Disabled)
JPB1	BMC Enable/Disable	Pins 1-2 (Enabled)
JPG1	VGA Enable/Disable	Pins 1-2 (Enabled)
JPL1	LAN 1 Enable/Disable	Pins 1-2 (Enabled)
JPL2	LAN 2 Enable/Disable	Pins 1-2 (Enabled)
JWD1	Watch Dog	Pins 1-2 (Reset)

LED	Description
LAN Ports	LEDs for the LAN Ethernet ports
Dedicated IPMI LAN (H8SCM-F only)	LEDs for the dedicated IPMI LAN Ethernet port (H8SCM-F only)
DP1	LED for BMC Heartbeat
DP2	LED for Serverboard Power-On

Connector	Description
COM1/COM2	COM1 Serial Port/Header
FAN 1-5	Chassis/CPU Fan Headers
IDE#1	IDE Disk Drive Connector
IPMI LAN (H8SCM-F only)	Dedicated IPMI LAN Port (H8SCM-F only)
JD1	Speaker Header
JF1	Front Panel Connector
JL1	Chassis Intrusion Header
JOH1	Overheat Warning Header
JIPMB (H8SCM-F only)	System Management Bus Header for the IPMI Slot
JPI2C1	Power I ² C Header
JPW1	24-pin Main ATX Power Connector
JPW2	+12V 8-pin CPU Power Connectors
JWF1	Compact Flash Card Power Connector
JWOL1	Wake-On-LAN Header
JLPC1	TPM Header
LAN1/2	Gigabit Ethernet (RJ45) Ports
PS2 Mouse/Keyboard	PS2 Mouse/Keyboard connectors
SATA0 ~ SATA5	SATA Ports
T-SGPIO-1/TSGPIO-2	Serial General Purpose Input/Output Header for SATA
USB0/1, USB2/3, USB4/5, USB6	Universal Serial Bus (USB) Ports, Headers and Type-A Port
VGA	VGA Connector

1-3 Serverboard Features

CPU

- Single AMD Opteron 4000 series (AMD Socket C32 type) processor

Note: Refer to our web site for details on supported processors.

Memory

- Up to four (4) single and dual channel DIMM slots that support up to 32 GB of ECC/ Non-ECC UDIMM or up to 128 GB of ECC RDIMM DDR3-1600/1333/1066 Mhz speed, 1 GB, 2 GB, 4 GB, 8 GB, 16 GB or 32 GB size SDRAM memory in 1.5V or 1.35V voltages.

Note: Refer to Section 2-5 before installing memory and our web site for recommended DIMMs.

Chipset

- AMD SR5650 chipset and one SP5100 Southbridge chipset

Expansion Slots

- One (1) PCI-Express x8 (in x16 slot) Gen. 2
- One (1) PCI-Express x8 Gen. 2
- One (1) PCI-Express x4 (in x8 slot) Gen. 2
- One (1) PCI slot

BIOS

- 16 Mb AMI BIOS® SPI Flash ROM
- APM 1.2, DMI 2.3, PCI 2.2, ACPI 1.0 (ACPI 2.0 is BIOS supported), SMBIOS 2.3, Real Time Clock Wakeup, Plug and Play (PnP), BIOS resume hot keys, Hardware BIOS Virus Protection

PC Health Monitoring

- Onboard voltage monitors
- Fan status monitor with firmware/software on/off and speed control
- Watch Dog
- Environmental temperature monitoring via BIOS
- Power-up mode control for recovery from AC power loss
- System resource alert (via included utility program)
- Auto-switching voltage regulator for the CPU core
- CPU thermal trip support
- I²C temperature sensing logic

- Chipkill Support

ACPI Features

- Microsoft OnNow
- Slow blinking LED for suspend state indicator
- BIOS support for USB keyboard
- Wake-On-LAN (WOL)

Onboard I/O

- Six (6) SATA ports supported by an on-chip SATA controller (RAID 0, 1 and 10 supported)
- Seven (7) USB (Universal Serial Bus 2.0) ports (2x rear, 4x header, 1x type A)
- Two (2) LAN ports supported by two onboard Intel® 82574L Ethernet controllers for 10/100/1000Base-T
- One (1) dedicated IPMI LAN port (H8SCM-F only)
- One (1) VGA port supported by an onboard Matrox® G200 graphics controller (with 16 MB DDR2 memory)
- One (1) UDMA IDE 133/100 connector
- Two COM Ports (one external serial port, one Fast UART 16550 port)

Other

- Onboard power LED
- Chassis intrusion detection

Utilities

- BIOS flash upgrade utility
- Super Doctor III
- IPMI 1.5 / 2.0

Dimensions

- Micro-ATX form: (LxW) 9.6" x 8.6" (244 x 218 mm)

Figure 1-3. AMD SR5650/SP5100 Chipset:
System Block Diagram

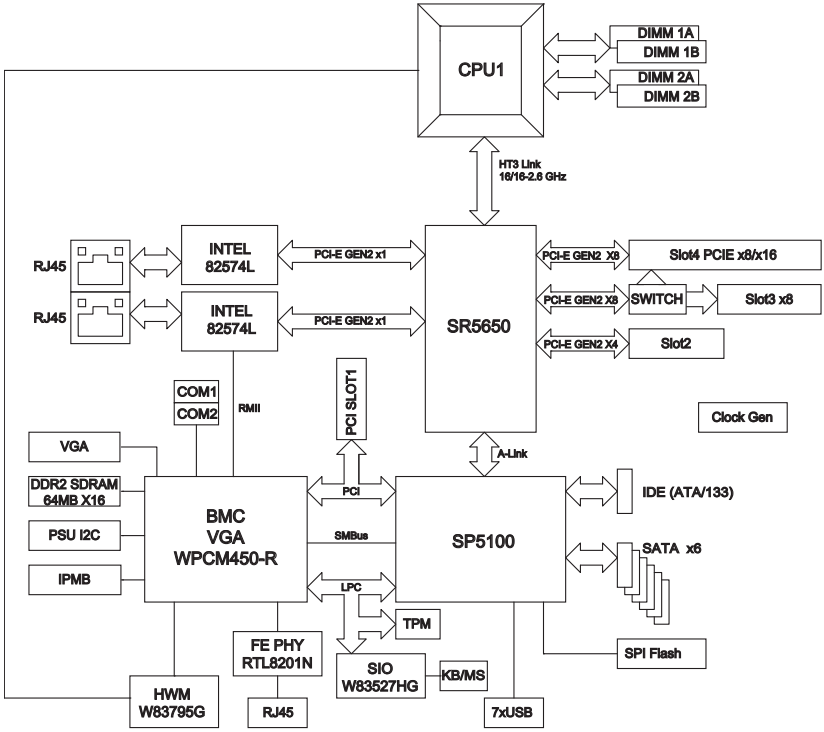

Note: This is a general block diagram and may not exactly represent the features on your motherboard. See the previous pages for the actual specifications of your motherboard.

1-4 Chipset Overview

The H8SCM(-F) serverboard is based on the AMD SR5650/SP5100 chipset. This chipset functions as a Media and Communications Processor (MCP). Controllers for the system memory are integrated directly into AMD Opteron processors.

AMD SR5650/SP5100 Chipset

The AMDSR5650/SP5100 are each a single-chip, high-performance HyperTransport peripheral controller. It includes a 22-lane PCI Express interface, an AMD Opteron 16-bit Hyper Transport interface link, a six-port Serial ATA interface and a seven-port USB 2.0 interface. This hub connects directly to the CPU.

HyperTransport Technology

HyperTransport technology is a high-speed, low latency point to point link that was designed to increase the communication speed by a factor of up to 48x between integrated circuits. This is done partly by reducing the number of buses in the chipset to reduce bottlenecks and by enabling a more efficient use of memory in multi-processor systems. The end result is a significant increase in bandwidth within the chipset.

1-5 PC Health Monitoring

This section describes the PC health monitoring features of the H8SCM(-F) serverboard. The serverboard has an onboard System Hardware Monitor chip that supports PC health monitoring.

Onboard Voltage Monitors

The onboard voltage monitor will continuously scan crucial voltage levels. Once a voltage becomes unstable, it will give a warning or send an error message to the screen. Users can adjust the voltage thresholds to define the sensitivity of the voltage monitor. Real time readings of these voltage levels are all displayed in BIOS.

Fan Status Monitor with Firmware/Software Speed Control

The PC health monitor can check the RPM status of the cooling fans. The onboard fans are controlled by thermal management via BIOS.

CPU Overheat/Fan Fail LED and Control

This feature is available when the user enables the CPU overheat/Fan Fail warning function in the BIOS. This allows the user to define an overheat temperature. When this temperature is exceeded or when a fan failure occurs, the Overheat/Fan Fail warning LED is triggered.

Auto-Switching Voltage Regulator for the CPU Core

The 5-phase-switching voltage regulator for the CPU core can support up to AMD Opteron 4000 series processors and auto-sense voltage IDs ranging from 0.8 V to 1.55V. This will allow the regulator to run cooler and thus make the system more stable.

1-6 Power Configuration Settings

This section describes the features of your motherboard that deal with power and power settings.

Microsoft OnNow

The OnNow design initiative is a comprehensive, system-wide approach to system and device power control. OnNow is a term for a PC that is always on but appears to be off and responds immediately to user or other requests.

Slow Blinking LED for Suspend-State Indicator

When the CPU goes into a suspend state, the chassis power LED will start blinking to indicate that the CPU is in suspend mode. When the user presses any key, the CPU will wake-up and the LED will automatically stop blinking and remain on.

BIOS Support for USB Keyboard

If a USB keyboard is the only keyboard in the system, it will function like a normal keyboard during system boot-up.

Note: To wake up the system from an S4 state by the USB keyboard/mouse, please connect the keyboard/mouse to USB port 0/1 at the rear I/O side.

Main Switch Override Mechanism

The power button can function as a system suspend button. When the user depresses the power button, the system will enter a SoftOff state. The monitor will be suspended and the hard drive will spin down. Depressing the power button again will cause the whole system to wake-up. During the SoftOff state, the power supply provides power to keep the required circuitry in the system alive. In case the system malfunctions and you want to turn off the power, just depress and hold the power button for 4 seconds. The power will turn off and no power will be provided to the motherboard.

Wake-On-LAN (WOL)

Wake-On-LAN is defined as the ability of a management application to remotely power up a computer that is powered off. Remote PC setup, up-dates and access tracking can occur after hours and on weekends so that daily LAN traffic is kept to a minimum and users are not interrupted. The motherboard has a 3-pin header (WOL) to connect to the 3-pin header on a Network Interface Card (NIC) that has WOL capability. Wake-On-LAN must be enabled in BIOS.

1-7 Power Supply

As with all computer products, a stable power source is necessary for proper and reliable operation. It is even more important for processors that have high CPU clock rates.

The H8SCM(-F) serverboard requires the use of proprietary power supplies. Please refer to the pinout information for the power connectors in Section 7 of Chapter 2 for detailed information on power requirements.

In areas where noisy power transmission is present, you may choose to install a line filter to shield the computer from noise. It is recommended that you also install a power surge protector to help avoid problems caused by power surges.

Warning: To prevent the possibility of explosion, do not use the wrong type of onboard CMOS battery or install it upside down.

1-8 Super I/O

The disk drive adapter functions of the Super I/O Winbond® BMC chip includes a data separator, write pre-compensation circuitry, decode logic, data rate selection, a clock generator, drive interface control logic and interrupt and DMA logic. The wide range of functions integrated onto the Super I/O greatly reduces the number of components required for interfacing with floppy disk drives.

The Super I/O provides two high-speed, 16550 compatible serial communication ports (UARTs), one of which supports serial infrared communication. Each UART includes a 16-byte send/receive FIFO, a programmable baud rate generator, complete modem control capability and a processor interrupt system. Both UARTs provide legacy speed with baud rate of up to 115.2 Kbps as well as an advanced speed with baud rates of 250 K, 500 K, or 1 Mb/s, which support higher speed modems.

The Super I/O provides functions that comply with ACPI (Advanced Configuration and Power Interface), which includes support of legacy and ACPI power management through a SMI or SCI function pin. It also features auto power management to reduce power consumption.

The IRQs, DMAs and I/O space resources of the Super I/O can be flexibly adjusted to meet ISA PnP requirements, which support ACPI and APM (Advanced Power Management).

Notes

Chapter 2

Installation

2-1 Standardized Warning Statements

About Standardized Warning Statements

The following statements are industry standard warnings, provided to warn the user of situations which have the potential for bodily injury. Should you have questions or experience difficulty, contact Supermicro's Technical Support department for assistance. Only certified technicians should attempt to install or configure components.

Read this section in its entirety before installing or configuring components in the Supermicro chassis.

These warnings may also be found on our web site at http://www.supermicro.com/about/policies/safety_information.cfm.

Battery Handling



Warning!

There is a danger of explosion if the battery is replaced incorrectly. Replace the battery only with the same or equivalent type recommended by the manufacturer. Dispose of used batteries according to the manufacturer's instructions

電池の取り扱い

電池交換が正しく行われなかった場合、破裂の危険性があります。交換する電池はメーカーが推奨する型、または同等のものを使用下さい。使用済電池は製造元の指示に従って処分して下さい。

警告

電池更換不當會有爆炸危險。請只使用同類電池或制造商推薦的功能相當的電池更換原有電池。請按製造商的說明處理廢舊電池。

警告

電池更換不當會有爆炸危險。請使用製造商建議之相同或功能相當的電池更換原有電池。請按照製造商的說明指示處理廢棄舊電池。

Warnung

Bei Einsetzen einer falschen Batterie besteht Explosionsgefahr. Ersetzen Sie die Batterie nur durch den gleichen oder vom Hersteller empfohlenen Batterietyp. Entsorgen Sie die benutzten Batterien nach den Anweisungen des Herstellers.

Attention

Danger d'explosion si la pile n'est pas remplacée correctement. Ne la remplacer que par une pile de type semblable ou équivalent, recommandée par le fabricant. Jeter les piles usagées conformément aux instructions du fabricant.

¡Advertencia!

Existe peligro de explosión si la batería se reemplaza de manera incorrecta. Reemplazar la batería exclusivamente con el mismo tipo o el equivalente recomendado por el fabricante. Desechar las baterías gastadas según las instrucciones del fabricante.

אזהרה!

קיימת סכנת פיצוץ של הסוללה במידה והוחלפה בדרך לא תקינה. יש להחליף את הסוללה בסוג התואם מחברת יצרן מומלצת.

סילוק הסוללות המשמשות יש לבצע לפי הוראות היצרן.

هناك خطر من انفجار في حالة استبدال البطارية بطريقة غير صحيحة فعليك استبدال البطارية فقط بنفس النوع أو ما يعادلها كما أوصت به الشركة المصنعة تخلص من البطاريات المستعملة وفقا لتعليمات الشركة الصانعة

경고!

배터리가 올바르게 교체되지 않으면 폭발의 위험이 있습니다. 기존 배터리와 동일하거나 제조사에서 권장하는 동등한 종류의 배터리로만 교체해야 합니다. 제조사의 안내에 따라 사용된 배터리를 처리하여 주십시오.

Waarschuwing

Er is ontploffingsgevaar indien de batterij verkeerd vervangen wordt. Vervang de batterij slechts met hetzelfde of een equivalent type die door de fabrikant aanbevolen wordt. Gebruikte batterijen dienen overeenkomstig fabrieksvoorschriften afgevoerd te worden.

Product Disposal



Warning!

Ultimate disposal of this product should be handled according to all national laws and regulations.

製品の廃棄

この製品を廃棄処分する場合、国の関係する全ての法律・条例に従い処理する必要があります。

警告

本产品的废弃处理应根据所有国家的法律和规章进行。

警告

本產品的廢棄處理應根據所有國家的法律和規章進行。

Warnung

Die Entsorgung dieses Produkts sollte gemäß allen Bestimmungen und Gesetzen des Landes erfolgen.

¡Advertencia!

Al deshacerse por completo de este producto debe seguir todas las leyes y reglamentos nacionales.

Attention

La mise au rebut ou le recyclage de ce produit sont généralement soumis à des lois et/ou directives de respect de l'environnement. Renseignez-vous auprès de l'organisme compétent.

סילוק המוצר

אזהרה!

סילוק סופי של מוצר זה חייב להיות בהתאם להנחיות וחוקי המדינה.

عند التخلص النهائي من هذا المنتج ينبغي التعامل معه وفقا لجميع القوانين واللوائح الوطنية

경고!

이 제품은 해당 국가의 관련 법규 및 규정에 따라 폐기되어야 합니다.

Waarschuwing

De uiteindelijke verwijdering van dit product dient te geschieden in overeenstemming met alle nationale wetten en reglementen.

2-2 Static-Sensitive Devices

Electrostatic Discharge (ESD) can damage electronic components. To prevent damage to your system board, it is important to handle it very carefully. The following measures are generally sufficient to protect your equipment from ESD.

Precautions

- Use a grounded wrist strap designed to prevent static discharge.
- Touch a grounded metal object before removing the board from the antistatic bag.
- Handle the board by its edges only; do not touch its components, peripheral chips, memory modules or gold contacts.
- When handling chips or modules, avoid touching their pins.
- Put the motherboard and peripherals back into their antistatic bags when not in use.
- For grounding purposes, make sure your computer chassis provides excellent conductivity between the power supply, the case, the mounting fasteners and the motherboard.
- Use only the correct type of CMOS onboard battery as specified by the manufacturer. Do not install the CMOS onboard battery upside down, which may result in a possible explosion.

Unpacking

The motherboard is shipped in antistatic packaging to avoid static damage. When unpacking the board, make sure the person handling it is static protected.

2-3 Processor and Heatsink Installation

Caution: Exercise extreme caution when handling and installing the processor. Always connect the power cord last and always remove it before adding, removing or changing any hardware components.

Installation Procedure

Follow the procedures as listed below to install the motherboard into a chassis.

1. Install the processor(s) and the heatsink(s).
2. Install the motherboard in the chassis.
3. Install the memory and add-on cards.
4. Finally, connect the cables and install the drivers.

Installing the Processors

1. Begin by removing the cover plate that protects the CPU. Lift the lever on the CPU socket until it points straight up. With the lever raised, lift open the silver CPU retention plate.
2. Use your thumb and your index finger to hold the CPU. Locate and align pin 1 of the CPU socket with pin 1 of the CPU. Both are marked with a triangle.



Triangles



3. Align pin 1 of the CPU with pin 1 of the socket. Once aligned, carefully place the CPU into the socket. *Do not drop the CPU on the socket, move the CPU horizontally or vertically or rub the CPU against the socket or against any pins of the socket, which may damage the CPU and/or the socket.*



4. With the CPU inserted into the socket, inspect the four corners of the CPU to make sure that it is properly installed and flush with the socket. Then, gently lower the silver CPU retention plate into place.



5. Carefully press the CPU socket lever down until it locks into its retention tab.



Installing the Heatsinks

We recommend the use of active type heatsinks (except for 1U systems). Use any onboard fan header for the CPU's heatsink fan. To install the heatsink, please follow the installation instructions that are included with your heatsink package.

Note: Make sure the heatsink is placed so that the fins of the heatsink are in the direction of the airflow in your system.

2-4 Mounting the Serverboard into a Chassis

All motherboards have standard mounting holes to fit different types of chassis. Make sure that the locations of all the mounting holes for both the motherboard and the chassis match. Although a chassis may have both plastic and metal mounting fasteners, metal ones are highly recommended because they ground the motherboard to the chassis. Make sure that the metal standoffs click in or are screwed in tightly.

Check the Compatibility of the Serverboard Ports and the I/O Shield

1. The H8SCM(-F) serverboard requires a chassis that can support a board of (LxW) 9.6" x 8.6" (244 x 218 mm) in size.
2. Make sure that the I/O ports on the motherboard align with their respective holes in the I/O shield at the rear of the chassis.

Mounting the Serverboard onto the Tray in the Chassis

1. Carefully mount the motherboard onto the motherboard tray by aligning the motherboard mounting holes with the raised metal standoffs in the tray.
2. Insert screws into all the mounting holes in the motherboard that line up with the standoffs.
3. Then use a screwdriver to secure the motherboard to the mainboard tray - tighten until just snug (if too tight you might strip the threads). Metal screws provide an electrical contact to the motherboard ground to provide a continuous ground for the system.

Caution: Exercise extreme caution when installing or removing memory modules to prevent any possible damage.

2-5 Installing Memory

Installing Memory

1. Insert each memory module vertically into its slot, paying attention to the notch along the bottom of the module to prevent inserting the module incorrectly (see Figure 2-1).
2. Install to slots CPU1/DIMM1A, CPU1/DIMM2A, CPU1/DIMM1B and CPU1/DIMM2B, etc. Always install in groups of two and in the numerical order of the DIMM slots. See support information below.
3. Gently press down on the memory module until it snaps into place.

Note: 1 GB, 2 GB, 4 GB, 8 GB, 16 GB or 32 GB size memory modules are supported. It is highly recommended that you remove the power cord from the system before installing or changing memory modules. Please refer to our web site for memory that has been tested on the H8SCM(-F) serverboard.

Figure 2-1. Installing DIMM into Slot

To Install: Insert module vertically and press down until it snaps into place. Pay attention to the alignment notch at the bottom.

To Remove: Use your thumbs to gently push the release tabs near both ends of the module. This should release it from the slot.

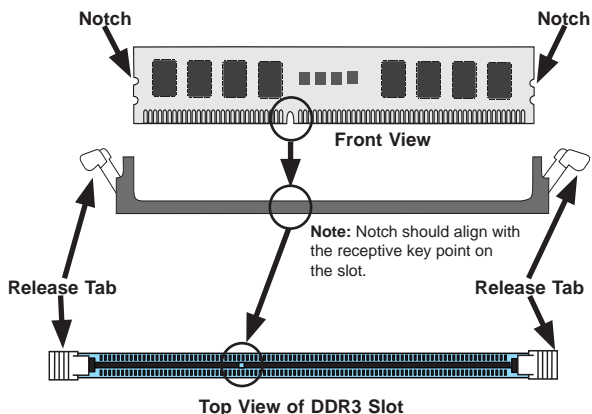

Memory Support

The H8SCM(-F) serverboard supports single and dual channel, DDR3-1600/1333/1066 Mhz speed registered ECC/Unbuffered ECC/non-ECC SDRAM. Only interleaved memory is supported, so you must populate two DIMM slots at a time, one per channel (see procedure above).

Populating two adjacent slots at a time with memory modules of the same size and type will result in interleaved (128-bit) memory, which is faster than non-interleaved (64-bit) memory.

Maximum Memory

The H8SCM(-F) serverboard supports up to 32 GB of ECC/Non-ECC UDIMM or up to 128 GB of ECC RDIMM in four (4) DIMM slots.

Memory Population for Optimal Performance				
# DIMMS	Channel 1		Channel 2	
2 DIMMs	DIMM1A		DIMM2A	
4 DIMMs	DIMM1A	DIMM1B	DIMM2A	DIMM2B

Note: Memory speed support is dependent on the type of CPU used on the board.

DIMM Module Population Configuration

For memory to work properly, follow the tables below for memory installation:

Per Channel DIMM Populations Options					
DIMM Type	DIMM A	DIMM B	Max. MHz, 1.5V DIMMs	Max. MHz, 1.35V DIMMs (6-core Only)	Max. GB/ Channel
Unbuffered DIMM (UDIMM)	SR or DR	Empty	1600 MHz	1333 MHz	8GB
	SR	SR	1333 MHz	1333 MHz	8 GB
	DR	DR	1066 MHz	1066 MHz	16 GB
Registered DIMM (RDIMM)	SR or DR	Empty	1600 MHz	1333 MHz	16 GB
	SR	SR	1333 MHz	1333 MHz	16 GB
	DR	DR	1066 MHz	1066 MHz	32 GB
	QR	Empty	1333 MHz	1066 MHz	32 GB
	QR	QR	800 MHz	800 MHz	64 GB

Note 1: Due to OS limitations, some operating systems may not show more than 4 GB of memory.

Note 2: Due to memory allocation to system devices, the amount of memory that remains available for operational use will be reduced when 4 GB of RAM is used. The reduction in memory availability is disproportional.

2-6 PCI Expansion Cards

A riser card is used to support one standard size (full height full length) PCI expansion card.

Installing a PCI Expansion Card

1. Confirm that you have the correct riser card for your chassis model and the add-on card includes a standard bracket.
2. Remove the chassis cover.
3. Install the riser card by sliding card into the appropriate slot in the serverboard.
4. Choose the PCI slot shield in which to place the add-on card.
5. In that slot, open the PCI slot shield lever and slide the shield sideways.
6. From inside the chassis, remove the PCI slot shield.
7. Slide the add-on card into the riser card and attach the add-on card bracket in place of the PCI slot shield.
8. Secure the add-on card by closing the PCI slot shield lever.
9. Connect cables to the add-on card as necessary.

2-7 I/O Port and Control Panel Connections

The I/O ports are color coded to make setting up your system easier. See Figure 2-2 below for the colors and locations of the various I/O ports.

Figure 2-2. I/O Port Locations and Definitions

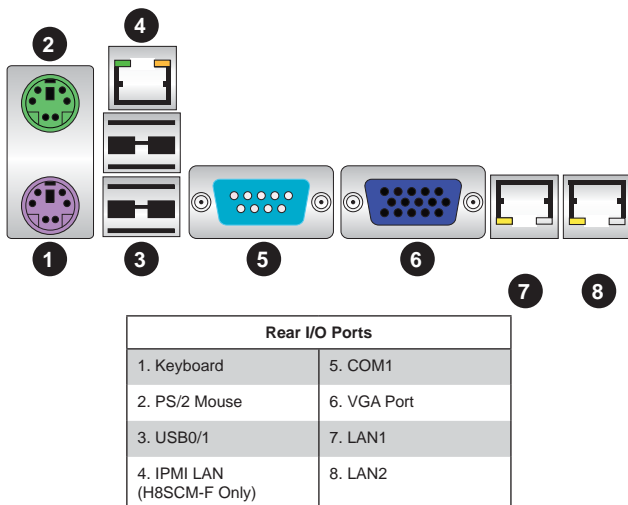

Front Control Panel

JF1 contains header pins for various front control panel connectors. See Figure 2-3 for the pin definitions of the various connectors. Refer to Section 2-6 for details.

Figure 2-3. JF1: Front Control Panel Header (JF1)

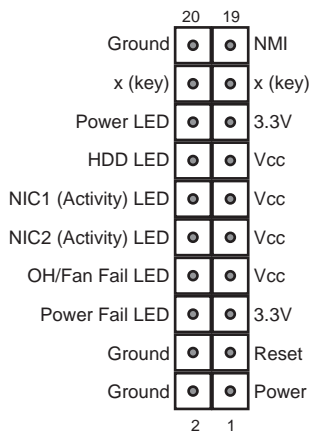

2-8 Connector Definitions

Power Connectors

A 24-pin main power supply connector(JPW1) and three 8-pin CPU PWR connector (JPW2) on the motherboard. These power connectors meet the SSI EPS 12V specification. In addition to the 24-pin ATX power connector, the 12V 8-pin CPU PWR connector at JPW2 must also be connected to your power supply. See the table on the right for pin definitions.

Warning: To prevent damage to the power supply or motherboard, please use a power supply that contains both a 24-pin and 8-pin power connectors. Be sure to connect these connectors to the 24-pin (JPW1) and the three 8-pin (JPW2) power connectors on the motherboard. Failure in doing so will void the manufacturer warranty on your power supply and motherboard.

Power Connector

The Power connector is on pins 1 and 2 of JF1. This header should be connected to the chassis power button. See the table on the right for pin definitions.

Reset Connector

The reset connector is located on pins 3 and 4 of JF1 and attaches to the reset switch on the computer chassis. See the table on the right for pin definitions.

ATX Power 24-pin Connector Pin Definitions (JPW1)			
Pin#	Definition	Pin#	Definition
13	+3.3V	1	+3.3V
14	-12V	2	+3.3V
15	COM	3	COM
16	PS_ON	4	+5V
17	COM	5	COM
18	COM	6	+5V
19	COM	7	COM
20	Res (NC)	8	PWR_OK
21	+5V	9	5VSB
22	+5V	10	+12V
23	+5V	11	+12V
24	COM	12	+3.3V

12V 8-pin PWR Connector Pin Definitions (JPW2)	
Pins	Definition
1 through 4	Ground
5 through 8	+12V

Required Connection

Power Button Pin Definitions (JF1)	
Pin#	Definition
1	Power
2	Ground

Reset Button Pin Definitions (JF1)	
Pin#	Definition
3	Reset
4	Ground

Power Fail LED

The Power Fail LED connection is located on pins 5 and 6 of JF1. Refer to the table on the right for pin definitions.

PWR Fail LED Pin Definitions (JF1)	
Pin#	Definition
5	3.3V
6	Power Fail LED

Overheat/Fan Fail LED (OH)

Connect an LED to the OH connection on pins 7 and 8 of JF1 to provide advanced warning of chassis overheating or fan failure. Refer to the table on the right for pin definitions and status indicators.

OH/Fan Fail LED Pin Definitions (JF1)	
Pin#	Definition
7	Vcc
8	OH/Fan Fail (Red) LED

OH/Fan Fail LED Status	
State	Indication
Solid	Overheat
Blinking	Fan fail

NIC2 (Activity) LED

The LED connections for LAN2 are on pins 9 and 10 of JF1. Attach LAN LED cables to display network activity. See the table on the right for pin definitions.

NIC2 LED Pin Definitions (JF1)	
Pin#	Definition
9	Vcc
10	Activity

NIC1 (Activity) LED

The LED connections for LAN1 are on pins 11 and 12 of JF1. Attach LAN LED cables to display network activity. See the table on the right for pin definitions.

NIC1 LED Pin Definitions (JF1)	
Pin#	Definition
11	Vcc
12	Activity

HDD LED

The HDD LED connection is located on pins 13 and 14 of JF1. Attach the hard drive LED cable here to display disk activity (for any hard drives on the system, including SAS, Serial ATA and IDE). See the table on the right for pin definitions

HDD LED Pin Definitions (JF1)	
Pin#	Definition
13	Vcc
14	HD LED

Power On LED

The Power On LED connector is located on pins 15 and 16 of JF1. This connection is used to provide LED indication of power being supplied to the system. See the table on the right for pin definitions.

Power LED Pin Definitions (JF1)	
Pin#	Definition
15	Vcc
16	Power LED

NMI Button

The non-maskable interrupt button header is located on pins 19 and 20 of JF1. Refer to the table on the right for pin definitions.

NMI Button Pin Definitions (JF1)	
Pin#	Definition
19	NMI
20	Ground

LAN1/2 (Ethernet Ports)

Two Gigabit Ethernet ports (designated LAN1 and LAN2) are located beside the VGA port. Additionally, there is a dedicated LAN for IPMI on top of the two rear USB ports for the H8SCM-F serverboard. These Ethernet ports accept RJ45 type cables.



LAN Ports (LAN1/2) Pin Definition			
Pin#	Definition	Pin#	Definition
1	P2V5SB	10	SGND
2	TD0+	11	Act LED
3	TD0-	12	P3V3SB
4	TD1+	13	Link 100 LED (Yellow, +3V3SB)
5	TD1-	14	Link 1000 LED (Yellow, +3V3SB)
6	TD2+	15	Ground
7	TD2-	16	Ground
8	TD3+	17	Ground
9	TD3-	18	Ground

Note: NC indicates no connection.

Universal Serial Bus Ports

Two Universal Serial Bus ports (USB 2.0) are located beside the Keyboard and Mouse PS2 ports (USB0/1). One additional Type A port (USB6) is included on the motherboard. See the table on the right for pin definitions.

Universal Serial Bus Ports Pin Definitions (USB 0/1, USB6)			
Pin#	USB0 Definition	Pin#	USB1 Definition
1	+5V	1	+5V
2	PO-	2	PO-
3	PO+	3	PO+
4	Ground	4	Ground

Chassis Intrusion

A Chassis Intrusion header is located at JL1. Attach the appropriate cable to inform you of a chassis intrusion.

Chassis Intrusion Pin Definitions (JL1)	
Pin#	Definition
1	Battery voltage
2	Intrusion signal

USB Headers

Four USB 2.0 headers (USB2/3 and USB4/5) are also included on the motherboard. These may be connected to provide front side access. A USB cable (not included) is needed for the connection. See the table on the right for pin definitions.

Universal Serial Bus Headers Pin Definitions (USB2/3, USB4/5)			
USB2		USB3	
Pin#	Definition	Pin#	Definition
1	+5V	1	+5V
2	PO-	2	PO-
3	PO+	3	PO+
4	Ground	4	Ground
5	Key	5	NC

Note: NC indicates no connection.

Serial Ports

The COM1 serial port is located beside the VGA port. Refer to the motherboard layout for the location of the COM2 header. See the table on the right for pin definitions.

Serial Port Pin Definitions (COM1/COM2)			
Pin #		Definition	
Pin #	Definition	Pin#	Definition
1	DCD	6	DSR
2	RXD	7	RTS
3	TXD	8	CTS
4	DTR	9	RI
5	Ground	10	NC

Note: NC indicates no connection.

Fan Headers

This motherboard has five fan headers (Fan1 to Fan5). These 4-pin fans headers are backward compatible with 3-pin fans. However, fan speed control is available for 4-pin fans only. The fan speeds are controlled by the BIOS (H8SCM) or IPMI if present (H8SCM-F). See the table on the right for pin definitions

Fan Header Pin Definitions	
Pin#	Definition
1	Ground
2	+12V
3	Tachometer
4	PWR Modulation

SGPIO

The T-SGPIO1/ T-SGPIO2 (Serial General Purpose Input/Output) headers provide a bus between the SATA controller and the backplane to provide SATA enclosure management functions. Connect the appropriate cable from the backplane to the T-SGPIO1 header to utilize SATA management functions on your system.

SGPIO Header Pin Definitions (T-SGPIO1/TSGPIO2)			
Pin#	Definition	Pin #	Definition
1	NC	2	NC
3	Ground	4	Data
5	Load	6	Ground
7	NC	8	NC

Note: NC indicates no connection.

Trusted Platform Module Header

The JLPC1 header is used to connect a Trusted Platform Module (TPM), available separately from a third-party vendor. A TPM is a security device that allows encryption and authentication of hard drives, disallowing access if the TPM associated with it is not installed in the system. See the table on the right for pin definitions.

Trusted Platform Module Header Pin Definitions (JLPC1)			
Pin#	Definition	Pin#	Definition
1	LCLK	2	GND
3	LFRAME	4	No Pin
5	LRESET	6	VCC5
7	LAD3	8	LAD2
9	VCC3	10	LAD1
11	LAD0	12	GND
13	RSV0	14	RSV1
15	SB3V	16	SERIRQ
17	GND	18	CLKRUN
19	LPCPD	20	RSV2

Power SMB (I²C) Connector

The Power System Management Bus (I²C) connector (JPI²C1) monitors the power supply, fan and system temperatures. See the table on the right for pin definitions.

Power SMB Pin Definitions (JPI²C1)	
Pin#	Definition
1	Clock
2	Data
3	PWR Fail
4	Ground
5	+3.3V

ATX PS/2 Keyboard and PS/2 Mouse Ports

The ATX PS/2 keyboard and PS/2 mouse are located next to the Back Panel USB Ports 0/1 on the motherboard. See the table at right for pin definitions.

PS/2 Keyboard/Mouse Pin Definitions			
PS2 Keyboard		PS2 Mouse	
Pin#	Definition	Pin#	Definition
1	KB Data	1	Mouse Data
2	No Connection	2	No Connection
3	Ground	3	Ground
4	Mouse/KB VCC (+5V)	4	Mouse/KB VCC (+5V)
5	KB Clock	5	Mouse Clock
6	No Connection	6	No Connection

VCC: with 1.5A PTC (current limit)

Power LED/Speaker

On the JD1 header, pins 1~3 are used for power LED indication, and pins 4-7 are for the speaker. See the tables on the right for pin definitions. If you wish to use the onboard speaker, you should close pins 6~7 with a jumper. Connect a cable to pins 4~7 of JD1 to use an external speaker.

PWR LED Connector Pin Definitions (JD1)	
Pin Setting	Definition
Pin 1	Anode (+)
Pin2	Cathode (-)
Pin3	NA

Speaker Connector Pin Definitions	
Pin Setting	Definition
Pins 4~7	External Speaker
Pins 6~7	Internal Speaker

Compact Flash Card PWR Connector

A Compact Flash Card Power Connector is located at JWF1. For the Compact Flash Card to work properly, you will need to enable with JCF1 and connect a Compact Flash Card power cable to JWF1 first.

Overheat LED

Connect an LED to the JOH1 header to provide warning of chassis overheating. See the table on the right for pin definitions.

Overheat LED Pin Definitions (JOH1)	
Pin#	Definition
1	3.3V
2	OH Active

Wake-On-LAN

The Wake-On-LAN header is designated JWOL1. See the table on the right for pin definitions. You must have a LAN card with a Wake-On-LAN connector and cable to use the Wake-On-LAN feature.

Wake-On-LAN Pin Definitions (JWOL1)	
Pin#	Definition
1	+5V Standby
2	Ground
3	Wake-up

JIPMB (H8SCM-F only)

A System Management Bus header for the IPMI slot is located at IPMB. Connect the appropriate cable here to use the IPMB I²C connection on your system.

JIPMB Pin Definitions	
Pin#	Definition
1	Data
2	Ground
3	Clock
4	No Connection

Video Connector

A Video (VGA) connector is located below the COM Port on the IO backplane. This connector is used to provide video and CRT display.

2-9 Jumper Settings

Explanation of Jumpers

To modify the operation of the motherboard, jumpers can be used to choose between optional settings. Jumpers create shorts between two pins to change the function of the connector. Pin 1 is identified with a square solder pad on the printed circuit board. See the diagram at right for an example of jumping pins 1 and 2. Refer to the motherboard layout page for jumper locations.

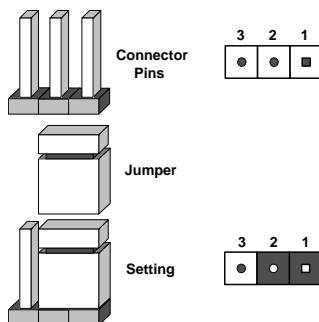

Note: On two-pin jumpers, "Closed" means the jumper is on and "Open" means the jumper is off the pins.

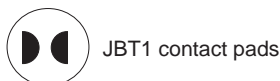

CMOS Clear

JBT1 is used to clear CMOS, which will also clear any passwords. Instead of pins, this jumper consists of contact pads to prevent accidentally clearing the contents of CMOS.

To Clear CMOS

1. First power down the system and unplug the power cord(s). It is also recommended that you remove the onboard battery from the serverboard.
2. With the power disconnected, short the CMOS pads with a metal object such as a small screwdriver.
3. Remove the screwdriver (or shorting device).
4. Reconnect the power cord(s) and power on the system.

Note 1. For an ATX power supply, you must completely shut down the system, remove the AC power cord, and then short JBT1 to clear CMOS.

Note 2. Be sure to remove the onboard CMOS Battery before you short JBT1 to clear CMOS.

Note 3. Clearing CMOS will also clear all passwords.

Note 4: Do not use the PW_ON connector to clear CMOS.

LAN1/2 Enable/Disable

Change the setting of jumper JPL1 or JPL2 to enable or disable the LAN1 or LAN2 Ethernet port. See the table on the right for jumper settings. The default setting is enabled.

LAN1/2 En/Disable Jumper Settings (JPL1/JPL2)	
Jumper Setting	Definition
Pins 1-2	Enabled
Pins 2-3	Disabled

VGA Enable/Disable

JPG1 allows you to enable or disable the VGA port. The default position is on pins 1 and 2 to enable VGA. See the table on the right for jumper settings.

VGA Enable/Disable Jumper Settings (JPG1)	
Jumper Setting	Definition
Pins 1-2	Enabled
Pins 2-3	Disabled

Compact Flash Master/Slave Select

A Compact Flash Master (Primary)/Slave (Secondary) Select Jumper is located at JCF1. Close this jumper to enable Compact Flash Card. For the Compact Flash Card or the Compact Flash Jumper (JCF1) to work properly, you will need to connect the Compact Flash Card power cable to JWF1 first. Refer to the board layout below for the location.

Compact Flash Card Master/Slave Select (JCF1)	
Jumper Setting	Definition
Open	Slave (Secondary)
Closed	Master (Primary)

Watch Dog Enable/Disable

JWD1 enables the Watch Dog function, a system monitor that takes action when a software application freezes the system. Jumping pins 1-2 will have WD reboot the system if a program freezes. Jumping pins 2-3 will generate a non-maskable interrupt for the program that has frozen. See the table on the right for jumper settings. Watch Dog must also be enabled in BIOS.

Watch Dog Jumper Settings (JWD1)	
Jumper Setting	Definition
Pins 1-2	Reset
Pins 2-3	NMI
Open	Disabled

Note: When Watch Dog is enabled, the user must write their own application software to disable the Watch Dog Timer.

Onboard Speaker Enable/Disable

The JD1 header allows you to use either an external speaker or the internal (onboard) speaker. To use the internal onboard speaker, close pins 6 and 7 with a jumper. To use an external speaker, remove the jumper and connect the speaker wires to pins 4 (+5V) and 7 (control signal). See the table on the right for settings and the table associated with the Power LED/Keylock/Speaker connection (previous section) for jumper settings.

Onboard Speaker Enable/Disable Pin Definitions (JD1)	
Jumper Setting	Definition
Pins 6 and 7	Jump for onboard speaker
Pins 4 and 7	Attach external speaker wires

Note: Pins 4-7 are used only for the onboard speaker.

I²C to PCI-Express Slot

J1²C1/J1²C2 allows you to enable the I²C bus to communicate with the PCI-Express slot. For the jumpers to work properly, please set both jumpers to the same setting. If enabled, both jumpers must be enabled. If disabled, both jumpers must be disabled. See the table on the right for jumper settings.

I ² C to PCI-Express Slot Jumper Settings (J1 ² C1/J1 ² C2)	
Jumper Setting	Definition
Closed	Enabled
Open	Disabled

BMC Jumper

JPB1 is used to enable or disable the BMC (Baseboard Management Control) Chip and the onboard IPMI connection. This jumper is used together with the IPMI settings in the BIOS. The default position is on pins 1 and 2 to Enable BMC. See the table on the right for jumper settings.

BMC Jumper Enable (JPB1) Jumper Settings	
Jumper Setting	Definition
Pins 1-2	Enabled (default)
Pins 2-3	Disabled

2-10 Onboard Indicators

GLAN LEDs

There are two LAN ports (LAN1/2) on the motherboard. Each Ethernet LAN port has two LEDs. The Yellow LED on the right indicates connection and activity. The Link LED on the left side may be green, amber or off to indicate the speed of the connection. See the tables at right for more information.

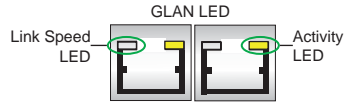

GLAN Activity Indicator (Right) LED Settings

Color	Status	Definition
Off	No Connections	
Yellow	Flashing	Active

LAN Connection Speed Indicator (Left) LED Settings

LED Color	Definition
Off	10 MHz
Green	100 MHz
Amber	1 GHz

IPMI Dedicated LAN LEDs

In addition to LAN Ports 1/2, an IPMI Dedicated LAN is also located on the I/O Backplane. The amber LED on the right indicates connection and activity; while the green LED on the left indicates the speed of the connection. See the tables at right for more information.

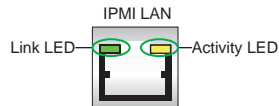

IPMI LAN Link/Speed LED (Left) & Activity LED (Right)

Color	Status	Definition
Off	Off	No Connection
Green: Solid	Link/Speed (Left)	100 Mb/s
Amber Blinking	Activity (Right)	Active

BMC Heartbeat LED

A BMC (Baseboard Management Control) Heartbeat LED is located at DP1 on the motherboard. When DP1 is on, the BMC Controller functions normally. See the tables at right for more information.

BMC Heartbeat (DP1) LED Settings

Color	Status	Definition
Green	Blinking	BMC: Normal
Off	Off	Not functioning normally

Power LED

DP2 is an Onboard Power LED. When this LED is lit, it means power is present on the serverboard. Be sure to turn off the system and unplug the power cord(s) before removing or installing components.

Power LED (DP2)	
State	System Status
On	Standby power present on motherboard
Off	No power connected

2-11 IDE and SATA Drive Connections

Use the following information to connect the IDE hard disk drive cables.

- A red mark on a wire typically designates the location of pin 1.
- The 80-wire ATA133/100/66 IDE hard disk drive cable that came with your system has two connectors to support two drives. This special cable should be used to take advantage of the speed this new technology offers. The blue connector connects to the onboard IDE connector interface and the other connector(s) to your hard drive(s). Consult the documentation that came with your disk drive for details on actual jumper locations and settings for the hard disk drive.

SATA Ports

There are no jumpers to configure the SATA ports, which are designated SATA0 through SATA5. See the table on the right for pin definitions.

SATA Ports Pin Definitions (SATA0-SATA5)			
Pin#	Definition	Pin#	Definition
1	Ground	5	RXN
2	TXP	6	RXP
3	TXN	7	Ground
4	Ground		

IDE Connector

There is one IDE connector on the serverboard. See the table on the right for pin definitions.

IDE Drive Connector Pin Definitions (IDE#1)			
Pin#	Definition	Pin#	Definition
1	Reset IDE	2	Ground
3	Host Data 7	4	Host Data 8
5	Host Data 6	6	Host Data 9
7	Host Data 5	8	Host Data 10
9	Host Data 4	10	Host Data 11
11	Host Data 3	12	Host Data 12
13	Host Data 2	14	Host Data 13
15	Host Data 1	16	Host Data 14
17	Host Data 0	18	Host Data 15
19	Ground	20	Key
21	DRQ3	22	Ground
23	I/O Write	24	Ground
25	I/O Read	26	Ground
27	IOCHRDY	28	BALE
29	DACK3	30	Ground
31	IRQ14	32	IOCS16
33	Addr1	34	Ground
35	Addr0	36	Addr2
37	Chip Select 0	38	Chip Select 1
39	Activity	40	Ground

2-12 Enabling SATA RAID

Now that the hardware is set up, you must install the operating system and the SATA RAID drivers, if you wish to use RAID with your SATA drives. The installation procedure differs depending on whether you wish to have the operating system installed on a RAID array or on a separate non-RAID drive. See the instructions below for details.

Serial ATA (SATA)

Serial ATA (SATA) is a physical storage interface that employs a single cable with a minimum of four wires to create a point-to-point connection between devices. This connection is a serial link that supports a SATA transfer rate from 150 MBps. The serial cables used in SATA are thinner than the traditional cables used in Parallel ATA (PATA) and can extend up to one meter in length, compared to only 40 cm for PATA cables. Overall, SATA provides better functionality than PATA.

Installing the OS/SATA Driver

Before installing the OS (operating system) and SATA RAID driver, you must decide if you wish to have the operating system installed as part of a bootable RAID array or installed to a separate non-RAID hard drive. If on a separate drive, you may install the driver either during or after the OS installation. If you wish to have the OS on a SATA RAID array, you must follow the procedure below and install the driver during the OS installation.

Building a Driver Diskette

You must first build a driver diskette from Supermicro drivers for your system. Drivers can be found at <ftp://ftp.supermicro.com>. (You will have to create this disk on a computer that is already running and with the OS installed.)

Building a Driver Diskette

1. Install your system drives from the FTP website. A display as shown in Figure 2-7 will appear.
2. Click on the icon labeled "Build Driver Diskettes and Manuals" and follow the instructions to create a floppy disk with the drivers on it.
3. Once it's been created, remove the floppy and insert the installation CD for the Windows Operating System you wish to install into the CD-ROM drive of the new system you are about to configure.

Note: You need to have an external USB floppy when building the driver diskette. Window's Vista, Windows 2008 or later Windows OS systems can use a USB stick instead of a floppy.

Enabling SATA RAID in the BIOS

Before installing the Windows operating system, you must change some settings in the BIOS. Boot up the system and hit the <Delete> key to enter the BIOS Setup Utility. After the setup utility loads,

1. Use the arrow keys to move to the "Exit" menu. Scroll down using the arrow keys to "Load Optimal Defaults" and press <Enter>. Select "OK" to confirm, then <Enter> to load the default settings.
2. Use the arrow keys to move to the "Advanced" menu, then scroll down to "IDE configuration". On this submenu, scroll down to "OnChip SATA Type" and choose the "RAID" option (Figure 2-4). "RAID Codebase" submenu appears. This setting allows you to select the codebase for your RAID setup. Options are either Adaptec or DoHill.

Figure 2-4. BIOS Setup Screen

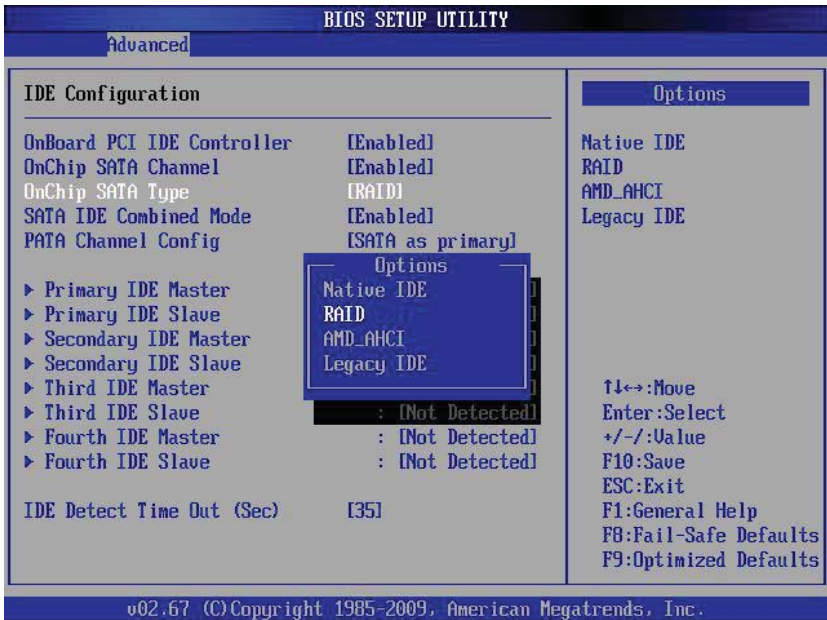

3. Press the <Esc> key twice and scroll to the "Exit" menu. Select "Save Changes and Exit" and press <Enter>, then press <Enter> again to verify.
4. After exiting the BIOS Setup Utility, the system reboots. When prompted during the startup, to use the DoHill RAID Utility program press the <CTRL+R> key (Figure 2-5), or to use the Adaptec RAID Utility program press the <CTRL+A> key (Figure 2-6).

Figure 2-5. DotHill RAID Utility Program Screen

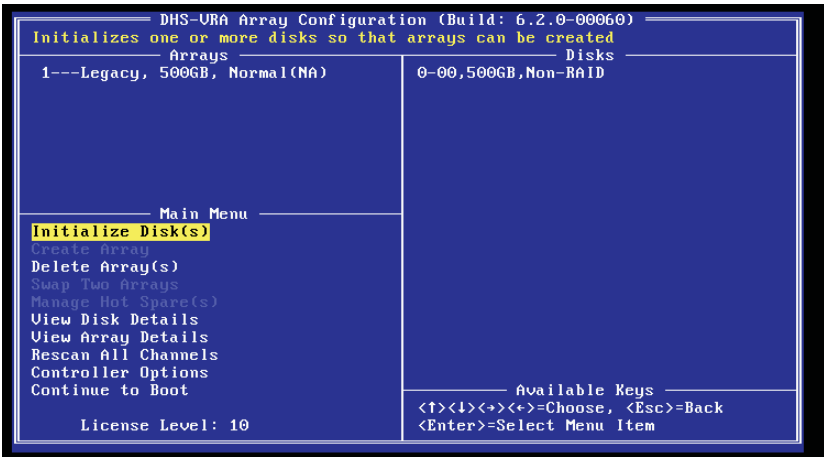

Figure 2-6. Adaptec RAID Utility Program Screen



Using the DotHill and Adaptec RAID Utility

The RAID Utility program allows you to define the drives you want to include in the RAID array and the mode and type of RAID.

Installing the RAID Driver During OS Installation

You may also use the procedure below to install the RAID driver during the Windows OS installation:

1. With the Windows OS installation CD-ROM in the CD drive, restart the system.
2. Press <Enter> again to continue with the Windows setup.
3. When you see the prompt, hit the <F6> key to enter Windows setup.
4. Eventually a blue screen will appear with a message that begins "Windows could not determine the type of one or more storage devices . . ." When you see the screen, hit the <S> key to "Specify Additional Device", then insert the driver diskette you just created into the floppy drive.
5. Highlight "Manufacturer Supplied Hardware Support Disk" and hit the <Enter> key.
6. Highlight the first "Adaptec RAID" driver shown and press the <Enter> key to install it.

2-13 Installing Drivers

The Supermicro Website contains drivers and utilities for your system at <ftp://ftp.supermicro.com>, some of which must be installed, such as the chipset driver. After downloading and installing the drivers and utilities, the display shown in Figure 2-7 should appear.

Click the icons showing a hand writing on paper to view the readme files for each item. Click the computer icons to the right of these items to install each item (from top to the bottom) one at a time. After installing each item, you should reboot the system before moving on to the next item on the list. The bottom icon with a CD on it allows you to view the entire contents of the utilities.

Figure 2-7. Driver/Tool Installation Display Screen

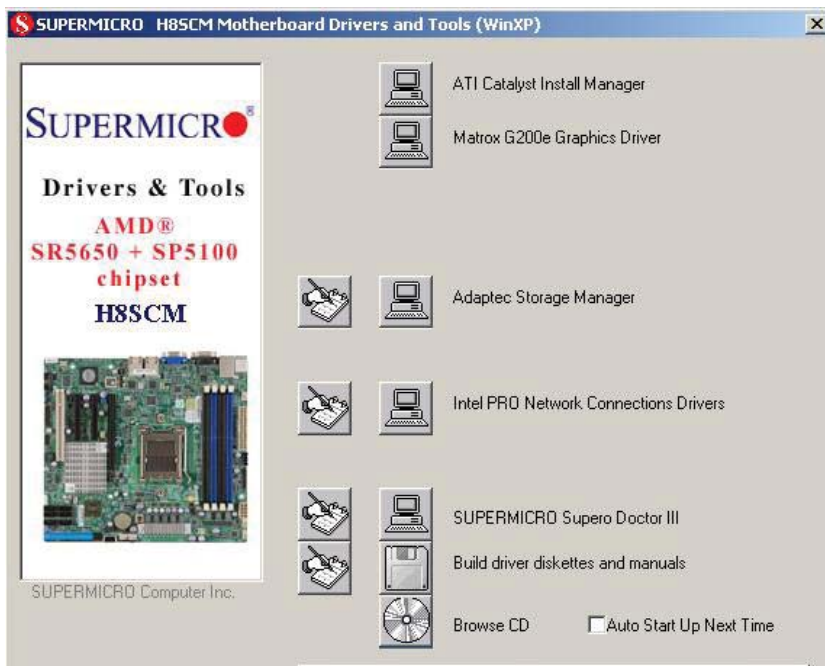

Supero Doctor III

The SuperDoctor® III program is a Web base management tool that supports remote management capability. It includes Remote and Local Management tools. The local management is called SD III Client. The SuperDoctor III program included on the CD-ROM that came with your motherboard allows you to monitor the environment and operations of your system. SuperDoctor III displays crucial system information such as CPU temperature, system voltages and fan status. See the Figure below for a display of the SuperDoctor III interface.

Note: The default User Name and Password for SuperDoctor III is ADMIN / ADMIN.

Note: When SuperDoctor is first installed, it adopts the temperature threshold settings that have been set in BIOS. Any subsequent changes to these thresholds must be made within SuperDoctor, as the SuperDoctor settings override the BIOS settings. To set the BIOS temperature threshold settings again, you would first need to uninstall SuperDoctor.

Figure 2-8. Supero Doctor III Interface Display Screen (Health Information)

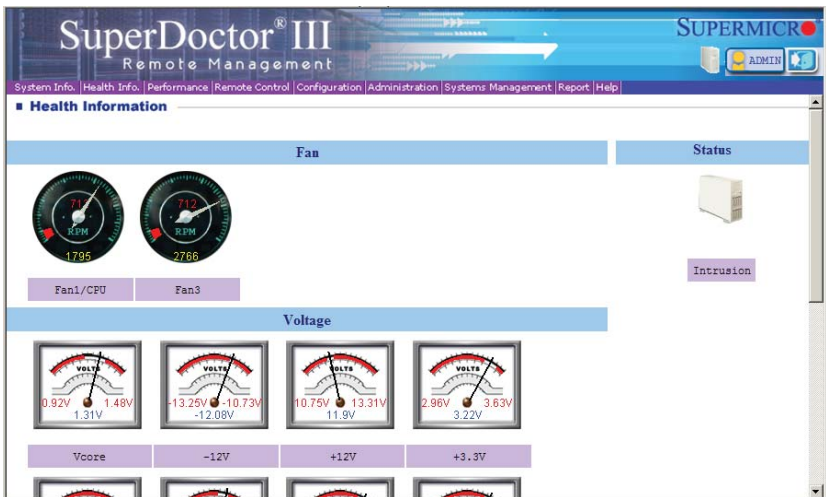
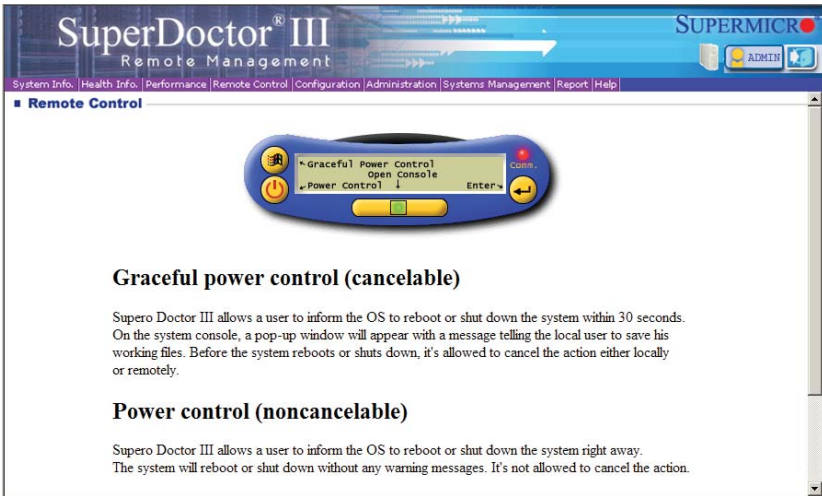

Figure 2-9. Supero Doctor III Interface Display Screen (Remote Control)



Note: The SuperDoctor III program and User's Manual can be downloaded from the Supermicro web site at <http://www.supermicro.com/products/accessories/software/SuperDoctorIII.cfm>. For Linux, we recommend that you use the SuperoDoctor II application instead.

2-14 Serverboard Battery

Caution: There is a danger of explosion if the onboard battery is installed upside down, which will reverse its polarities (see Figure 2-10). This battery must be replaced only with the same or an equivalent type recommended by the manufacturer (CR2032). Dispose of used batteries according to the manufacturer's instructions.

Figure 2-10. Installing the Onboard Battery

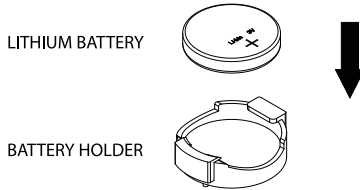

Please handle used batteries carefully. Do not damage the battery in any way; a damaged battery may release hazardous materials into the environment. Do not discard a used battery in the garbage or a public landfill. Please comply with the regulations set up by your local hazardous waste management agency to dispose of your used battery properly.

Notes

Chapter 3

Troubleshooting

3-1 Troubleshooting Procedures

Use the following procedures to troubleshoot your system. If you have followed all of the procedures below and still need assistance, refer to the 'Technical Support Procedures' and/or 'Returning Merchandise for Service' section(s) in this chapter. Always disconnect the AC power cord before adding, changing or installing any hardware components.

Before Power On

1. Check that the onboard power LED is lit (DP2 on the motherboard).
2. Make sure that the power connector is connected to your power supply.
3. Make sure that no short circuits exist between the motherboard and chassis.
4. Disconnect all cables from the motherboard, including those for the keyboard and mouse.
5. Remove all add-on cards.
6. Install a CPU and heatsink (making sure it is fully seated) and connect the internal (chassis) speaker and the power LED to the motherboard. Check all jumper settings as well.
7. Use the correct type of onboard CMOS battery (CR2032) as recommended by the manufacturer. To avoid possible explosion, do not install the CMOS battery upside down.

No Power

1. Make sure that no short circuits exist between the motherboard and the chassis.
2. Verify that all jumpers are set to their default positions.
3. Check that the 115V/230V switch on the power supply is properly set.
4. Turn the power switch on and off to test the system.
5. The battery on your motherboard may be old. Check to verify that it still supplies ~3VDC. If it does not, replace it with a new one.

No Video

1. If the power is on but you have no video, remove all the add-on cards and cables.
2. Use the speaker to determine if any beep codes exist. Refer to Appendix A for details on beep codes.

Note: If you are a system integrator, VAR or OEM, a POST diagnostics card is recommended. For I/O port 80h codes, refer to App. B.

Memory Errors

1. Make sure that the DIMM modules are properly and fully installed.
2. You should be using proper ECC DDR-3 memory (see next page). Also, it is recommended that you use the same memory type and speed for all DIMMs in the system. [See Section 2-5 for memory details.](#)
3. Check for bad DIMM modules or slots by swapping modules between slots and noting the results.
4. Check the power supply voltage 115V/230V switch.

Losing the System's Setup Configuration

1. Make sure that you are using a high quality power supply. A poor quality power supply may cause the system to lose the CMOS setup information. Refer to Section 1-6 for details on recommended power supplies.
2. The battery on your motherboard may be old. Check to verify that it still supplies ~3VDC. If it does not, replace it with a new one.
3. If the above steps do not fix the setup configuration problem, contact your vendor for repairs.

3-2 Technical Support Procedures

Before contacting Technical Support, please take the following steps. Also, note that as a motherboard manufacturer, we do not sell directly to end-users, so it is best to first check with your distributor or reseller for troubleshooting services. They should know of any possible problem(s) with the specific system configuration that was sold to you.

1. Please review the 'Troubleshooting Procedures' and 'Frequently Asked Questions' (FAQs) sections in this chapter or see the FAQs on our web site before contacting Technical Support.

2. BIOS upgrades can be downloaded from our web site.

Note: Not all BIOS can be flashed depending on the modifications to the boot block code.

3. If you still cannot resolve the problem, include the following information when contacting us for technical support:
 - Serverboard model and PCB revision number
 - BIOS release date/version (this can be seen on the initial display when your system first boots up)
 - System configuration

An example of a Technical Support form is posted on our web site.

Distributors: For immediate assistance, please have your account number ready when contacting our technical support department by e-mail.

3-3 Frequently Asked Questions

Question: What type of memory does my motherboard support?

Answer: The H8SCM(-F) serverboard supports up to 32 GB of ECC/Non-ECC UDIMM or up to 128 GB of ECC RDIMM in DDR3-1600/1333/1066 Mhz speed, 1 GB, 2 GB, 4 GB, 8 GB, 16 GB or 32 GB size SDRAM memory. See Section 2-5 for details on installing memory.

Question: How do I update my BIOS?

Answer: It is recommended that you **not** upgrade your BIOS if you are not experiencing problems with your system. Updated BIOS files are located on our web site. Please check our BIOS warning message and the information on how to update your BIOS on our web site. Also, check the current BIOS revision and make sure it is newer than your current BIOS before downloading.

Select your motherboard model on the web page and download the corresponding BIOS file to your computer. Unzip the BIOS update file, in which you will find the readme.txt (flash instructions), the afudos.exe (BIOS flash utility) and the BIOS image (xxx.rom) files. Copy these files to a bootable floppy disk, insert the disk into drive A and reboot the system. At the DOS prompt after rebooting, enter the command "flash" (without quotation marks) then type in the BIOS file that you want to update with (xxxx.rom).

Question: What's on the CD that came with my motherboard?

Answer: The supplied compact disc has quite a few drivers and programs that will greatly enhance your system. We recommend that you review the CD and install the applications you need. Applications on the CD include chipset drivers for Windows and security and audio drivers.

Question: Why can't I turn off the power using the momentary power on/off switch?

Answer: The instant power off function is controlled in BIOS by the Power Button Mode setting. When the On/Off feature is enabled, the motherboard will have instant off capabilities as long as the BIOS has control of the system. When the Standby or Suspend feature is enabled or when the BIOS is not in control such as during memory count (the first screen that appears when the system is turned on), the momentary on/off switch must be held for more than four seconds to shut down the system. This feature is required to implement the ACPI features on the motherboard.

3-4 Returning Merchandise for Service

A receipt or copy of your invoice marked with the date of purchase is required before any warranty service will be rendered. You can obtain service by calling your vendor for a Returned Merchandise Authorization (RMA) number. When returning to the manufacturer, the RMA number should be prominently displayed on the outside of the shipping carton, and mailed prepaid or hand-carried. Shipping and handling charges will be applied for all orders that must be mailed when service is complete.

For faster service, RMA authorizations may be requested online (<http://www.supermicro.com/support/rma/>).

This warranty only covers normal consumer use and does not cover damages incurred in shipping or from failure due to the alteration, misuse, abuse or improper maintenance of products.

During the warranty period, contact your distributor first for any product problems.

Chapter 4

BIOS

4-1 Introduction

This chapter describes the AMIBIOS™ Setup utility for the H8SCM(-F) serverboard. The 16 Mb AMI BIOS® is stored in a flash chip and can be easily upgraded using a floppy disk-based program.

Note: Due to periodic changes to the BIOS, some settings may have been added or deleted and might not yet be recorded in this manual. Please refer to the Manual Download area of our web site for any changes to BIOS that may not be reflected in this manual.

Starting the Setup Utility

To enter the BIOS Setup Utility, hit the <Delete> key while the system is booting-up. (In most cases, the <Delete> key is used to invoke the BIOS setup screen. There are a few cases when other keys are used, such as <F1>, <F2>, etc.) Each main BIOS menu option is described in this manual.

The Main BIOS screen has two main frames. The left frame displays all the options that can be configured. "Grayed-out" options cannot be configured. The right frame displays the key legend. Above the key legend is an area reserved for a text message. When an option is selected in the left frame, it is highlighted in white. Often a text message will accompany it. (Note that BIOS has default text messages built in. We retain the option to include, omit, or change any of these text messages.) Settings printed in **Bold** are the default values.

A " ►" indicates a submenu. Highlighting such an item and pressing the <Enter> key will open the list of settings within that submenu.

The BIOS setup utility uses a key-based navigation system called hot keys. Most of these hot keys (<F1>, <F10>, <Enter>, <ESC>, <Arrow> keys, etc.) can be used at any time during the setup navigation process.

4-2 Main Menu

When you first enter AMI BIOS Setup Utility, you will see the Main Menu screen. You can always return to the Main Menu by selecting the **Main** tab on the top of the screen with the arrow keys.

The Main Menu screen provides you with a system overview, which includes the version, built date and ID of the AMIBIOS, the type, speed and number of the processors in the system and the amount of memory installed in the system.

System Time/System Date

You can edit this field to change the system time and date. Highlight *System Time* or *System Date* using the <Arrow> keys. Enter new values through the keyboard. Press the <Tab> key or the <Arrow> keys to move between fields. The date must be entered in DAY/MM/DD/YYYY format. The time is entered in HH:MM:SS format. Please note that time is in a 24-hour format. For example, 5:30 A.M. appears as 05:30:00 and 5:30 P.M. as 17:30:00.

4-3 Advanced Settings Menu

► Boot Feature

Quick Boot

If Enabled, this option will skip certain tests during POST to reduce the time needed for the system to boot up. The options are **Enabled** and Disabled.

Quiet Boot

If Disabled, normal POST messages will be displayed on boot-up. If **Enabled**, this display the OEM logo instead of POST messages.

Add On ROM Display Mode

This option sets the display mode for Option ROM. The options are **Force BIOS** or Keep Current.

Bootup Num Lock

This option selects the power-on state for the NUM lock to either **On** or Off.

PS/2 Mouse Support

Use this option to select support for the PS/2 mouse. Options are Disabled, Enabled or **Auto**.

Wait for F1 if Error

This setting controls the system response when an error is detected during the boot sequence. When enabled, BIOS will stop the boot sequence when an error is detected, at which point you will need to press the F1 button to re-enter the BIOS setup menu. The options are **Enabled** and **Disabled**.

Hit 'DEL' Message Display

Use this option to **Enable** or **Disable** the "Press DEL to run setup" message in POST.

Watch Dog Function

Allows system to restart when system is inactive more than 5-minutes. The options are **Enabled** and **Disabled**.

Power Button Function

This sets the function of the power button when you turn off the system. Options include 4-second Override and **Instant Off**.

Restore on AC Power Loss

This sets the action that occurs when an AC power loss occurs. Options include Power Off, Power On and **Last State**.

Interrupt 19 Capture

Select **Enabled** to allow ROMs to trap Interrupt 19. The options are **Enabled** and **Disabled**.

EUP Support

This setting allows you to enable or disable supplied standby power in S5. Set to **Enabled** to for EUP requirements and set to **Disabled** for waking capability.

► Processor and Clock Options**CPU Configuration**

This displays static information on the Module Version, Physical Count and Logical Count for the system's processor(s) and clock.

CPU Information

The information for the installed processor includes Revision, Cache L1/L2/L3, Speed, NB CLK, Able to Change Frequency and uCode Patch Level.

GART Error Reporting

This option should remain disabled for normal operation. The driver developer may enable this option for testing purposes. Options are Enabled or **Disabled**.

Microcode Update

This setting **Enables** or Disables microcode updating.

Secure Virtual Machine Mode

This setting is used to **Enable** or Disable SVM.

Power Now

This setting is used to **Enable** or Disable the AMD Power Now feature.

Power Cap

This option can decide the highest P-state in the OS. Options include **P-state 0** through P-state 4.

ACPI SRAT Table

This option **Enables** or Disables the building of the ACPI SRAT Table.

CPU Down Core Mode

This option sets down core support for the CPU. Options include **Disabled**, 1 Core through n Cores in odd numbered increments. The value n is depend on the core per CPU node.

C1E Support

This option specifies C1E support. Options include **Enabled** and Disabled.

Clock Speed Spectrum

This option enables or **disables** spread spectrum modulation.

▶ Advanced Chipset Control

▶ NorthBridge Configuration

▶ Memory Configuration

Bank Interleaving

Select Auto to automatically enable a bank-interleaving memory scheme when this function is supported by the processor. The options are **Auto** and Disabled.

Node Interleaving

This option enables node memory interleaving. Options include Auto or **Disabled**.

Channel Interleaving

This option enables channel memory interleaving. Options include **Auto** or Disabled.

CS Sparing

This setting will reserve a spare memory rank in each node when enabled. Options are Enabled and **Disabled**.

Bank Swizzle Mode

This setting **Enables** or Disables the bank swizzle mode.

▶ ECC Configuration

ECC Mode

This submenu affects the DRAM scrub rate based on its setting. Options include Disabled, **Basic**, Good, Super, Max and User. Selecting User activates the other options for user setting.

DRAM ECC Enable

This setting allows hardware to report and correct memory errors automatically, maintaining system integrity. Options are **Enabled** or Disabled. This option is only active if ECC Mode above is set to *User*.

► DRAM Timing Configuration

DRAM Timing Config

This option allows you to set the DRAM timing configuration for the system. Options include **Auto** or **Manual**.

Memory Clock Speed

This options sets the memory clock speed. Options include 200 Mhz, 266 Mhz, 333 Mhz, 400 Mhz, 533 Mhz, 667 Mhz, 800 Mhz and 933 Mhz.

IOMMU

This setting is used to enable or disable or set the GART size in systems without AGP. Options include **Enabled** and **Disabled**.

OHCI/EHCI HC Device Functions

These settings allow you to either **Enable** or **Disable** functions for OHCI or EHCI bus devices.

USB 2.0 Controller Mode

Use this setting to configure the USB 2.0 Controller in either **Hi-Speed** (480 Mps) or **Full Speed** (12 Mps) mode. Options include **Enabled** (Hi-Speed Mode) or **Disabled** (Full Speed Mode).

Legacy USB Support

Select "Enabled" to enable the support for USB Legacy. Disable Legacy support if there are no USB devices installed in the system. "Auto" disabled Legacy support if no USB devices are connected. The options are **Disabled**, **Enabled** and **Auto**.

Route Port 80h Cycles To

This option allows you to set route 80h cycles to either **PCI** or **LPC**.

► IDE Configuration

Onboard PCI IDE Controller

This setting allows you to **Enable** or **Disable** the PCI IDE controller.

On Chip SATA Channel

This setting allows you to **Enable** or **Disable** the OnChip SATA channel.

On Chip SATA Type

Use this setting to set the On Chip SATA type. Options include **Native IDE**, RAID, AHCI and Legacy IDE.

RAID Codebase

This submenu appears when you choose "RAID" from the "On Chip SATA Type" setting above. This setting allows you to select the codebase for using your RAID setup. Options are either Adaptec or **DotHill**.

SATA IDE Combined Mode

This setting allows you to **Enable** or Disable the SATA IDE combined mode.

PATA Channel Configuration

This allows you to set PATA channel configuration. Options include **SATA as Primary** or SATA as secondary.

► Primary/Secondary/Third/Fourth IDE Master/Slave

LBA/Large Mode

LBA (Logical Block Addressing) is a method of addressing data on a disk drive. The options are Disabled and **Auto**.

Block (Multi-Sector Transfer)

Block mode boosts IDE drive performance by increasing the amount of data transferred. Only 512 bytes of data can be transferred per interrupt if block mode is not used. Block mode allows transfers of up to 64 KB per interrupt.

Select "Disabled" to allow the data to be transferred from and to the device one sector at a time. Select "Auto" to allows the data transfer from and to the device occur multiple sectors at a time if the device supports it. The options are **Auto** and Disabled.

PIO Mode

PIO (Programmable I/O) mode programs timing cycles between the IDE drive and the programmable IDE controller. As the PIO mode increases, the cycle time decreases.

The options are **Auto**, 0, 1, 2, 3, and 4. Select Auto to allow BIOS to auto detect the PIO mode. Use this value if the IDE disk drive support cannot be determined. Select 0 to allow BIOS to use PIO mode 0, which has a data transfer rate of 3.3 MBs. Select 1 to allow BIOS to use PIO mode 1, which has a data transfer rate of 5.2 MBs. Select 2 to allow BIOS to use PIO mode 2, which has a data transfer rate of 8.3 MBs. Select 3 to allow BIOS to use PIO mode 3, which has a data transfer rate of 11.1 MBs. Select 4 to allow BIOS to use PIO mode 4, which has a data transfer rate of 16.6 MBs. This setting generally works with all hard disk drives manufactured after 1999. For other disk drives, such as IDE CD-ROM drives, check the specifications of the drive.

DMA Mode

Selects the DMA Mode. Options are **Auto**, SWDMA0, SWDMA1, SWDMA2, MWDMA0, MDWDMA1, MWDMA2, UDMA0, UDMA1, UDMA2, UDMA3, UDMA4 and UDMA5. (SWDMA=Single Word DMA, MWDMA=Multi Word DMA, UDMA=UltraDMA.)

S.M.A.R.T.

Self-Monitoring Analysis and Reporting Technology (SMART) can help predict impending drive failures. Select "Auto" to allow BIOS to auto detect hard disk drive support. Select "Disabled" to prevent AMI BIOS from using the S.M.A.R.T. Select "Enabled" to allow AMI BIOS to use the S.M.A.R.T. to support hard drive disk. The options are Disabled, Enabled, and **Auto**.

32-Bit Data Transfer

Select "Enabled" to activate the function of 32-Bit data transfer. Select "Disabled" to deactivate the function. The options are **Enabled** and Disabled.

IDE Detect Timeout (Sec)

Use the +/- keys to adjust and select the time out for detecting ATA/ATAPI devices. The default value is **35**.

► PCI/PnP Configuration

Clear NVRAM

Select Yes to clear NVRAM during boot-up. The options are Yes and **No**.

Plug & Play O/S

Select Yes to allow the OS to configure Plug & Play devices. (This is not required for system boot if your system has an OS that supports Plug & Play.) Select **No** to allow AMIBIOS to configure all devices in the system.

PCI Latency Timer

This option sets the latency of all PCI devices on the PCI bus. Select a value to set the PCI latency in PCI clock cycles. Options are 32, **64**, 96, 128, 160, 192, 224 and 248.

PCI IDE Busmaster

Use this setting to **Enable** or Disable BIOS enabled uses of PCI Busmastering for reading or writing to IDE drives.

ROM Scan Ordering

This setting determines which kind of option ROM activates prior to another. Options include **Onboard First** and Addon First.

PCI Slot 4

These settings **Enable** or Disable the specified PCI slot in your system.

PCIe x4 Slot5/PCI x8 Slot 6/PCI x8/x16 Slot 7

These settings **Enable** or Disable the specified PCIe slot in your system.

Onboard LAN Option ROM Select

This setting allows you to select the onboard LAN option ROM for iSCSI or **PXE**.

Note: You must enable **ONLY** LAN1 when the iSCSI support option is specified.

Load Onboard LAN 1 Option ROM

This option allows you to enable or **disable** the onboard LAN 1 option ROM.

Load Onboard LAN 2 Option ROM

This option allows you to enable or **disable** the onboard LAN 2 option ROM.

Primary Video Controller

This option specifies the primary video controller for **Onboard VGA** or Other.

► SuperIO Device Configuration

Serial 1 Address

This option specifies the base I/O port address and Interrupt Request address of serial port 1. Select "Disabled" to prevent the serial port from accessing any system resources. When this option is set to *Disabled*, the serial port physically becomes unavailable. Select "3F8/IRQ4" to allow the serial port to use 3F8 as its I/O port address and IRQ 4 for the interrupt address. Options include Disabled, **3F8/IRQ4**, 3E8/IRQ4 and 2E8/IRQ3

Serial 2 Address

This option specifies the base I/O port address and Interrupt Request address of serial port 2. Select "Disabled" to prevent the serial port from accessing any system resources. When this option is set to "Disabled", the serial port physically becomes unavailable. Select "2F8/IRQ3" to allow the serial port to use 2F8 as its I/O port address and IRQ 3 for the interrupt address. Options include Disabled, **2F8/IRQ3**, 3E8/IRQ4 and 2F8/IRQ3.

Serial Port 2 Attribute

This option allows you to set COM2 as a normal serial port or as virtual COM for SOL. Options are **SOL** or **COM**.

► Remote Access Configuration

Remote Access

Use this option to **Enable** or Disable Remote Access in your system. If enabled, the settings below will appear.

Serial Port Number

Use this setting to select the serial port for console redirection. Options include COM1, **COM2***. The displayed base address and IRQ for the serial port changes to reflect the selection you make.

Note: Make sure the selected port is enabled.

Serial Port Mode

Selects the serial port settings to use. Options are (**115200 8, n, 1**), (57600 8, n, 1), (38400 8, n, 1), (19200 8, n, 1) and (09600 8, n, 1).

Flow Control

Selects the flow control to be used for console redirection. Options are **None**, Hardware and Software.

Redirection After BIOS POST

Options are Disable (no redirection after BIOS POST), Boot Loader (redirection during POST and during boot loader) and **Always** (redirection always active). Note that some OS's may not work with this set to Always.

Terminal Type

Selects the type of the target terminal. Options are **ANSI**, VT100 and VT-UTF8.

VT-UTF8 Combo Key Support

Allows you to **Enable** or Disable VT-UTF8 combination key support for ANSI/VT100 terminals.

Sredir Memory Display Delay

Use this setting to set the delay in seconds to display memory information. Options are **No Delay**, 1 sec, 2 secs and 4 secs.

► Hardware Health Configuration

CPU Overheat Alarm

This setting allows you to specify the type of alarm for CPU overheating. Options include The Early Alarm and **The Default Alarm**.

Fan Speed Control Modes

This feature allows the user to determine how the system will control the speed of the onboard fans. The options are Full Speed/FS (Max Cooling), Performance/PF (Better Cooling), **Balanced/BL** (Balance between performance and energy saving), Energy Saving/ES (Lower Power and Noise).

Other items in the submenu are systems monitor displays for the following information:

CPU Temperature, NB Temperature, Air Temperature, System Temperature, Fan 1-6 Reading, CPU VCore, CPU Mem VTT, CPU Mem, 1.1V, 1.8V, 5V +12V, -12V, 3.3 Vcc, 3.3 VSB, VBAT and HT Voltage.

CPU Temperature Display (CTD)

CPU Temperature descriptions are defined as:

Low → [Tctl Value = Lowest Value, Tctl Value = -45]

Medium → [Tctl Value = -46, Tctl Value = 60]

High → [Tctl Value = -61 and Above]

Note: Only CPU temperature (Low, Medium, High) and system temperature (RT1) are required to be displayed in BIOS and in-system monitoring software. Other Serverboard components such as memory, chipset, SAS and 10Gb controllers, and others are not required to display temperatures. For debugging and testing purposes, BIOS and system monitoring software can show motherboard components' temperatures (such as memory, chipset, SAS and 10Gb controllers). However for SMCI standard release version BIOS and system monitoring software, motherboard components' temperatures are NOT required to be displayed.

CPU Overheating Alarm (COA)

CPU Overheating Alarm (COA) has “**Early Alarm**” and “**Default Alarm**” (default) options in the BIOS, and is required to be implemented in all fan speed control modes.

The **Early Alarm** is enabled when the Tctl value = 65, and is disabled when the Tctl value drops from 65 to 62.

The **Default Alarm** (default setting) is enabled when the Tctl value = 70, and is disabled when the Tctl value drops from 70 to 67.

When COA (either Early or Default Alarm) is *enabled*, the following actions are required to be executed:

- System overheating LED is required to be ON and to solid red.
- Onboard buzzer or speaker is required to be ON and to be a continuous sound.
- All system fans are required to be operated at full speed.
- System monitoring software (such as Super Doctor and IPMI if available) is required to report and record CPU overheating events in the event logs.

When COA (either Early or Default Alarm) is *disabled*, the following actions are required to be executed:

- System overheating LED is required to be OFF.
- Onboard buzzer or speaker is required to be OFF.
- All system fans are required to be returned to a normal, non-CPU-overheating LFSC condition.

Condition	When a CPU is overheating
Front Panel Overheating LED	On and Solid Red
Onboard Buzzer or Speaker	On and Continuous Sound
System Fan Speed Controls	Full Speed
BMC	Report PROCHOT
BMC Event Log	Record PROCHOT
Super Doctor	Report PROCHOT
Super Doctor Event Log	Record PROCHOT

► ACPI Configuration

PS2 KB/MS Wakeup

This setting allows you to Enable or **Disable** PS2 keyboard and mouse wakeup.

ACPI Aware O/S

This setting Enables or Disables ACPI support for the system's operating system. Options include **Yes** (enabled) or **No** (disabled).

ACPI APIC Support

Determines whether to include the ACPI APIC table pointer in the RSDT pointer list. The available options are **Enabled** and **Disabled**.

Headless Mode

Use this setting to Enable or **Disable** headless operation mode through ACPI.

ACPI Version Features

Use this setting to determine which ACPI version to use. Options are ACPI v1.0, **ACPI v2.0** and ACPI v3.0.

► Trusted Computing

TCG/TPM Support

This setting enables/disables TPM/TCG (TPM 1.1/1.2) support in BIOS. Options include **No** or **Yes**.

► IPMI Configuration

This menu shows static information about the IPMI firmware revision and status of the BMC, as well as options for IPMI configuration.

► View BMC System Event Log

Pressing the Enter key will open the following settings. Use the "+" and "-" keys to navigate through the system event log.

Clear BMC System Event Log

Selecting this and pressing the Enter key will clear the BMC system event log.

► Set LAN Configuration

Use the "+" and "-" keys to choose the desired channel number. This displays Channel Number and Channel Number Status information.

This menu contains options for inputting settings for the SET LAN Configuration Command. See IPMI 1.5 Specification, table 11.1 for details. Use the "+" and "-" keys to choose the desired channel number.

Note: Each question in this group may take a considerable amount of time.

IP Address Source

Select the source of this machine's IP address. If Static is selected, you will need to know and enter manually the IP address of this machine below. If DHCP is selected, the BIOS will search for a DHCP (Dynamic Host Configuration Protocol) server in the network it is attached to, and request the next available IP address. The options are **DHCP** and Static.

The following items are assigned IP addresses automatically if DHCP is selected under IP Address Source above:

IP Address

This submenu sets the IP address source as either Static or **DHCP**. Selecting Static allows you to manually set the IP Address, Subnet Mask and Gateway Address.

In the field provided here enter the IP address in the decimal form of xxx.xxx.xxx.xxx with xxx having a value of less than 256 and in decimal form only. The IP address and current IP address in the BMC are shown.

Subnet Mask

In the field provided here enter the Subnet address in the decimal form of xxx.xxx.xxx.xxx with xxx having a value of less than 256 and in decimal form only. The current subnet address in the BMC is shown.

Gateway Address

In the field provided here enter the Gateway address in the decimal form of xxx.xxx.xxx.xxx with xxx having a value of less than 256 and in decimal form only. The current Gateway address in the BMC is shown.

MAC Address

In the field provided here enter the MAC address in the hex form of xx.xx.xx.xx.xx.xx with xx in hex form only. The current MAC address in the BMC is shown.

BMC Watch Dog Timer Action

This setting is used to set the Watch Dog function, which allows the BMC to reset or powerdown the system if the OS crashes or hangs. Options include **Disabled**, Reset System, Power Down and Power Cycle.

► Event Log Configuration**View Event Log**

Pressing the Enter key will open the event log. Use the "↑" and "↓" keys to navigate through the system event log.

Mark All Events as Read

Selecting this and pressing the Enter key marks all events as read in the event log.

Clear Event Log

Selecting this and pressing the Enter key clears the system event log.

SR56x0 (RD890S) PCIE Error Log

This setting allows you set an error log ofr PCIE errors. Options include Yes or **No**.

4-3 Security Menu

AMI BIOS provides a Supervisor and a User password. If you use both passwords, the Supervisor password must be set first.

Change Supervisor Password

Select this option and press <Enter> to access the sub menu, and then type in the password.

Change User Password

Select this option and press <Enter> to access the sub menu, and then type in the password.

Boot Sector Virus Protection

This option is near the bottom of the Security Setup screen. Select "Disabled" to deactivate the Boot Sector Virus Protection. Select "Enabled" to enable boot sector protection. When "Enabled", AMI BIOS displays a warning when any program (or virus) issues a Disk Format command or attempts to write to the boot sector of the hard disk drive. The options are Enabled and **Disabled**.

4-4 Boot Menu

The Boot Menu is accessible only when the "Load Onboard LAN Option ROM" setting (in the PCI/PnP Configuration menu) is enabled.

► Boot Device Priority

This feature allows you to prioritize the boot sequence from the list of available devices. A device that is in parenthesis has been disabled in the corresponding type menu.

► Hard Disk Drives

This feature allows you to specify the boot sequence from the list of available hard disk drives. A device that is in parenthesis has been disabled in the corresponding type menu.

► Removable Drives

This feature allows you to specify the boot sequence from the list of available CD/DVD drives. A device that is in parenthesis has been disabled in the corresponding type menu.

Retry Boot Devices

This option allows you to retry boot devices. Options include Enabled and **Disabled**.

4-5 Exit Menu

Select the Exit tab from AMI BIOS Setup Utility screen to enter the Exit BIOS Setup screen.

Save Changes and Exit

When you have completed the system configuration changes, select this option to leave BIOS Setup and reboot the computer, so the new system configuration parameters can take effect. Select Save Changes and Exit from the Exit menu and press <Enter>.

Discard Changes and Exit

Select this option to quit BIOS Setup without making any permanent changes to the system configuration and reboot the computer. Select Discard Changes and Exit from the Exit menu and press <Enter>.

Discard Changes

Select this option and press <Enter> to discard all the changes and return to AMI BIOS Utility Program.

Load Optimal Defaults

To set this feature, select Load Optimal Defaults from the Exit menu and press <Enter>. Then Select "OK" to allow BIOS to automatically load the Optimal Defaults as the BIOS Settings. The Optimal settings are designed for maximum system performance, but may not work best for all computer applications.

Load Fail-Safe Defaults

To set this feature, select Load Fail-Safe Defaults from the Exit menu and press <Enter>. The Fail-Safe settings are designed for maximum system stability, but not maximum performance.

Notes

Appendix A

BIOS Error Beep Codes

During the POST (Power-On Self-Test) routines, which are performed each time the system is powered on, errors may occur.

Non-fatal errors are those which, in most cases, allow the system to continue the boot-up process. The error messages normally appear on the screen.

Fatal errors are those which will not allow the system to continue the boot-up procedure. If a fatal error occurs, you should consult with your system manufacturer for possible repairs.

These fatal errors are usually communicated through a series of audible beeps. The numbers on the fatal error list (on the following page) correspond to the number of beeps for the corresponding error. All errors listed, with the exception of Beep Code 8, are fatal errors.

A-1 AMIBIOS Error Beep Codes

Beep Code	Error Message	Description
1 beep	Refresh	Circuits have been reset (Ready to power up)
5 shorts, 1 long beep	Memory error	No memory detected in system
1 long, 8 short	Video error	Video adapter disabled or missing

Notes

Appendix B

BIOS POST Checkpoint Codes

When AMIBIOS performs the Power On Self Test, it writes checkpoint codes to I/O port 0080h. If the computer cannot complete the boot process, diagnostic equipment can be attached to the computer to read I/O port 0080h.

B-1 Uncompressed Initialization Codes

The uncompressed initialization checkpoint codes are listed in order of execution:

Checkpoint	Code Description
D0h	The NMI is disabled. Power on delay is starting. Next, the initialization code checksum will be verified.
D1h	Initializing the DMA controller, performing the keyboard controller BAT test, starting memory refresh and entering 4 GB flat mode next.
D3h	Starting memory sizing next.
D4h	Returning to real mode. Executing any OEM patches and setting the Stack next.
D5h	Passing control to the uncompressed code in shadow RAM at E000:0000h. The initialization code is copied to segment 0 and control will be transferred to segment 0.
D6h	Control is in segment 0. Next, checking if <Ctrl> <Home> was pressed and verifying the system BIOS checksum. If either <Ctrl> <Home> was pressed or the system BIOS checksum is bad, next will go to checkpoint code E0h. Otherwise, going to checkpoint code D7h.

B-2 Bootblock Recovery Codes

The bootblock recovery checkpoint codes are listed in order of execution:

Checkpoint	Code Description
E0h	The onboard floppy controller if available is initialized. Next, beginning the base 512 KB memory test.
E1h	Initializing the interrupt vector table next.
E2h	Initializing the DMA and Interrupt controllers next.
E6h	Enabling the floppy drive controller and Timer IRQs. Enabling internal cache memory.
Edh	Initializing the floppy drive.
Eeh	Looking for a floppy diskette in drive A:. Reading the first sector of the diskette.
Efh	A read error occurred while reading the floppy drive in drive A:.
F0h	Next, searching for the AMIBOOT.ROM file in the root directory.
F1h	The AMIBOOT.ROM file is not in the root directory.
F2h	Next, reading and analyzing the floppy diskette FAT to find the clusters occupied by the AMIBOOT.ROM file.
F3h	Next, reading the AMIBOOT.ROM file, cluster by cluster.
F4h	The AMIBOOT.ROM file is not the correct size.
F5h	Next, disabling internal cache memory.
FBh	Next, detecting the type of flash ROM.
FCh	Next, erasing the flash ROM.
FDh	Next, programming the flash ROM.
FFh	Flash ROM programming was successful. Next, restarting the system BIOS.

B-3 Uncompressed Initialization Codes

The following runtime checkpoint codes are listed in order of execution.

These codes are uncompressed in F0000h shadow RAM.

Checkpoint	Code Description
03h	The NMI is disabled. Next, checking for a soft reset or a power on condition.
05h	The BIOS stack has been built. Next, disabling cache memory.
06h	Uncompressing the POST code next.
07h	Next, initializing the CPU and the CPU data area.
08h	The CMOS checksum calculation is done next.
0Ah	The CMOS checksum calculation is done. Initializing the CMOS status register for date and time next.
0Bh	The CMOS status register is initialized. Next, performing any required initialization before the keyboard BAT command is issued.
0Ch	The keyboard controller input buffer is free. Next, issuing the BAT command to the keyboard controller.
0Eh	The keyboard controller BAT command result has been verified. Next, performing any necessary initialization after the keyboard controller BAT command test.
0Fh	The initialization after the keyboard controller BAT command test is done. The keyboard command byte is written next.
10h	The keyboard controller command byte is written. Next, issuing the Pin 23 and 24 blocking and unblocking command.
11h	Next, checking if <End> or <Ins> keys were pressed during power on. Initializing CMOS RAM if the Initialize CMOS RAM in every boot AMIBIOS POST option was set in AMIBCP or the <End> key was pressed.
12h	Next, disabling DMA controllers 1 and 2 and interrupt controllers 1 and 2.
13h	The video display has been disabled. Port B has been initialized. Next, initializing the chipset.
14h	The 8254 timer test will begin next.
19h	Next, programming the flash ROM.
1Ah	The memory refresh line is toggling. Checking the 15 second on/off time next.
2Bh	Passing control to the video ROM to perform any required configuration before the video ROM test.
2Ch	All necessary processing before passing control to the video ROM is done. Looking for the video ROM next and passing control to it.
2Dh	The video ROM has returned control to BIOS POST. Performing any required processing after the video ROM had control
23h	Reading the 8042 input port and disabling the MEGAKEY Green PC feature next. Making the BIOS code segment writable and performing any necessary configuration before initializing the interrupt vectors.
24h	The configuration required before interrupt vector initialization has completed. Interrupt vector initialization is about to begin.
25h	Interrupt vector initialization is done. Clearing the password if the POST DIAG switch is on.
27h	Any initialization before setting video mode will be done next.
28h	Initialization before setting the video mode is complete. Configuring the monochrome mode and color mode settings next.

Checkpoint	Code Description
2Ah	Bus initialization system, static, output devices will be done next, if present. See the last page for additional information.
2Eh	Completed post-video ROM test processing. If the EGA/VGA controller is not found, performing the display memory read/write test next.
2Fh	The EGA/VGA controller was not found. The display memory read/write test is about to begin.
30h	The display memory read/write test passed. Look for retrace checking next.
31h	The display memory read/write test or retrace checking failed. Performing the alternate display memory read/write test next.
32h	The alternate display memory read/write test passed. Looking for alternate display retrace checking next.
34h	Video display checking is over. Setting the display mode next.
37h	The display mode is set. Displaying the power on message next.
38h	Initializing the bus input, IPL, general devices next, if present. See the last page of this chapter for additional information.
39h	Displaying bus initialization error messages. See the last page of this chapter for additional information.
3Ah	The new cursor position has been read and saved. Displaying the Hit message next.
3Bh	The Hit message is displayed. The protected mode memory test is about to start.
40h	Preparing the descriptor tables next.
42h	The descriptor tables are prepared. Entering protected mode for the memory test next.
43h	Entered protected mode. Enabling interrupts for diagnostics mode next.
44h	Interrupts enabled if the diagnostics switch is on. Initializing data to check memory wraparound at 0:0 next.
45h	Data initialized. Checking for memory wraparound at 0:0 and finding the total system memory size next.
46h	The memory wraparound test is done. Memory size calculation has been done. Writing patterns to test memory next.
47h	The memory pattern has been written to extended memory. Writing patterns to the base 640 KB memory next.
48h	Patterns written in base memory. Determining the amount of memory below 1 MB next.
49h	The amount of memory below 1 MB has been found and verified.
4Bh	The amount of memory above 1 MB has been found and verified. Checking for a soft reset and clearing the memory below 1 MB for the soft reset next. If this is a power on situation, going to checkpoint 4Eh next.
4Ch	The memory below 1 MB has been cleared via a soft reset. Clearing the memory above 1 MB next.
4Dh	The memory above 1 MB has been cleared via a soft reset. Saving the memory size next. Going to checkpoint 52h next.
4Eh	The memory test started, but not as the result of a soft reset. Displaying the first 64 KB memory size next.
4Fh	The memory size display has started. The display is updated during the memory test. Performing the sequential and random memory test next.
50h	The memory below 1 MB has been tested and initialized. Adjusting the displayed memory size for relocation and shadowing next.
51h	The memory size display was adjusted for relocation and shadowing.

Checkpoint	Code Description
52h	The memory above 1 MB has been tested and initialized. Saving the memory size information next.
53h	The memory size information and the CPU registers are saved. Entering real mode next.
54h	Shutdown was successful. The CPU is in real mode. Disabling the Gate A20 line, parity, and the NMI next.
57h	The A20 address line, parity, and the NMI are disabled. Adjusting the memory size depending on relocation and shadowing next.
58h	The memory size was adjusted for relocation and shadowing. Clearing the Hit message next.
59h	The Hit message is cleared. The <WAIT...> message is displayed. Starting the DMA and interrupt controller test next.
60h	The DMA page register test passed. Performing the DMA Controller 1 base register test next.
62h	The DMA controller 1 base register test passed. Performing the DMA controller 2 base register test next.
65h	The DMA controller 2 base register test passed. Programming DMA controllers 1 and 2 next.
66h	Completed programming DMA controllers 1 and 2. Initializing the 8259 interrupt controller next.
67h	Completed 8259 interrupt controller initialization.
7Fh	Extended NMI source enabling is in progress.
80h	The keyboard test has started. Clearing the output buffer and checking for stuck keys. Issuing the keyboard reset command next.
81h	A keyboard reset error or stuck key was found. Issuing the keyboard controller interface test command next.
82h	The keyboard controller interface test completed. Writing the command byte and initializing the circular buffer next.
83h	The command byte was written and global data initialization has completed. Checking for a locked key next.
84h	Locked key checking is over. Checking for a memory size mismatch with CMOS RAM data next.
85h	The memory size check is done. Displaying a soft error and checking for a password or bypassing WINBIOS Setup next.
86h	The password was checked. Performing any required programming before WINBIOS Setup next.
87h	The programming before WINBIOS Setup has completed. Uncompressing the WINBIOS Setup code and executing the AMIBIOS Setup or WINBIOS Setup utility next.
88h	Returned from WINBIOS Setup and cleared the screen. Performing any necessary programming after WINBIOS Setup next.
89h	The programming after WINBIOS Setup has completed. Displaying the power on screen message next.
8Ch	Programming the WINBIOS Setup options next.
8Dh	The WINBIOS Setup options are programmed. Resetting the hard disk controller next.
8Fh	The hard disk controller has been reset. Configuring the floppy drive controller next.
91h	The floppy drive controller has been configured. Configuring the hard disk drive controller next.
95h	Initializing the bus option ROMs from C800 next. See the last page of this chapter for additional information.
96h	Initializing before passing control to the adaptor ROM at C800.

Checkpoint	Code Description
97h	Initialization before the C800 adaptor ROM gains control has completed. The adaptor ROM check is next.
98h	The adaptor ROM had control and has now returned control to BIOS POST. Performing any required processing after the option ROM returned control.
99h	Any initialization required after the option ROM test has completed. Configuring the timer data area and printer base address next.
9Ah	Set the timer and printer base addresses. Setting the RS-232 base address next.
9Bh	Returned after setting the RS-232 base address. Performing any required initialization before the Coprocessor test next.
9Ch	Required initialization before the Coprocessor test is over. Initializing the Coprocessor next.
9Dh	Coprocessor initialized. Performing any required initialization after the Coprocessor test next.
9Eh	Initialization after the Coprocessor test is complete. Checking the extended keyboard, keyboard ID, and Num Lock key next. Issuing the keyboard ID command next.
A2h	Displaying any soft errors next.
A3h	The soft error display has completed. Setting the keyboard typematic rate next.
A4h	The keyboard typematic rate is set. Programming the memory wait states next.
A5h	Memory wait state programming is over. Clearing the screen and enabling parity and the NMI next.
A7h	NMI and parity enabled. Performing any initialization required before passing control to the adaptor ROM at E000 next.
A8h	Initialization before passing control to the adaptor ROM at E000h completed. Passing control to the adaptor ROM at E000h next.
A9h	Returned from adaptor ROM at E000h control. Performing any initialization required after the E000 option ROM had control next.
Aah	Initialization after E000 option ROM control has completed. Displaying the system configuration next.
Abh	Uncompressing the DMI data and executing DMI POST initialization next.
B0h	The system configuration is displayed.
B1h	Copying any code to specific areas.
00h	Code copying to specific areas is done. Passing control to INT 19h boot loader next.