

Board Layout

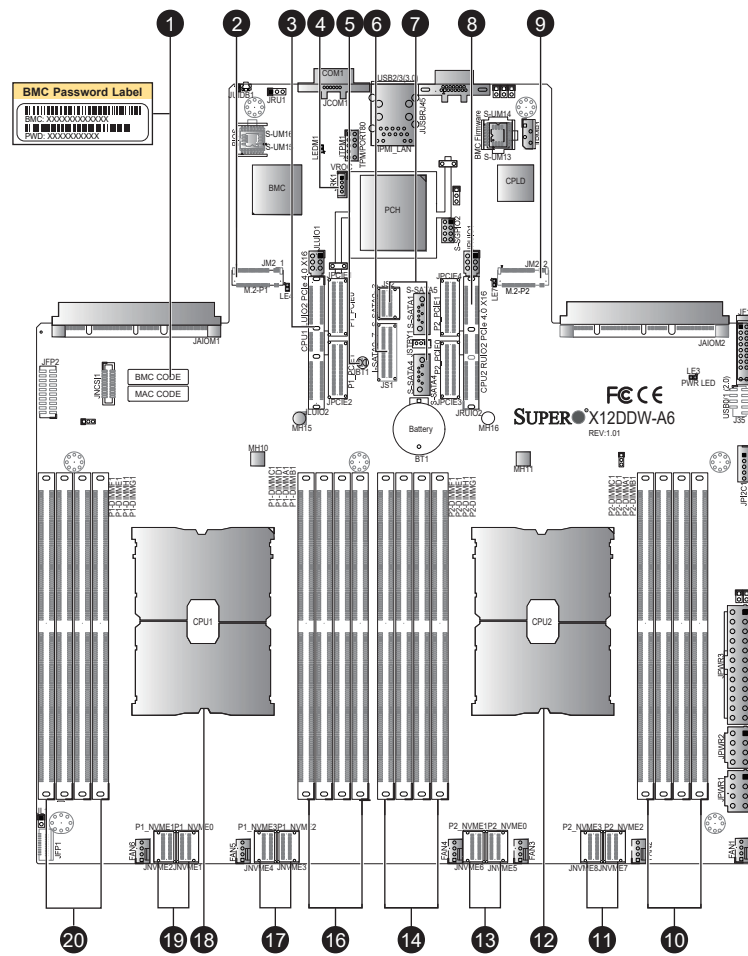

No.	Description
1	BMC Password Label
2	PCIe 3.0 x2 NVMe M.2 slot from PCH supported by CPU1
3	Left side PCIe 4.0 x16 riser card slot supported by CPU1
4	JRK1: RAID Key for onboard NVMe devices
5	JBT1: Clear CMOS
6	I-SATA 0-7: SATA 3.0 ports
7	S-SATA 0-3/S-SATA4, 5: SATA 3.0 ports/Powered SATA connectors
8	Right side PCIe 4.0 x16 riser card slot supported by CPU2
9	PCIe 3.0 x2 NVMe M.2 slot from PCH supported by CPU2
10	P2-DIMMB1/P2-DIMMA1/P2-DIMMD1/P2-DIMMC1 slot
11	NVMe PCI-E 4.0 x4 SlimSAS ports 2 and 3 (from CPU2)
12	CPU2
13	NVMe PCI-E 4.0 x4 SlimSAS ports 0 and 1 (from CPU2)
14	P2-DIMMG1/P2-DIMMH1/P2-DIMME1/P2-DIMMF1 slot
15	P1-DIMMB1/P1-DIMMA1/P1-DIMMD1/P1-DIMMC1 slot
16	NVMe PCI-E 4.0 x4 SlimSAS ports 2 and 3 (from CPU1)
17	CPU1
18	NVMe PCI-E 4.0 x4 SlimSAS ports 0 and 1 (from CPU1)
19	P1-DIMMG1/P1-DIMMH1/P1-DIMME1/P1-DIMMF1 slot

Front View and Features

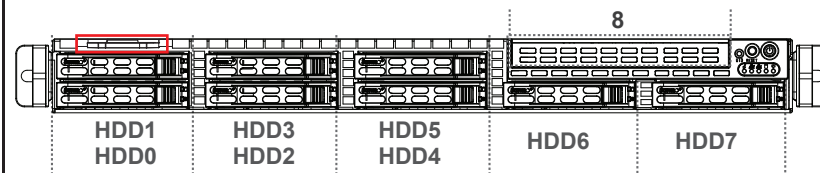

Slot	Description
0~7	2.5" Hot-Swap SATA3/SAS3* Drive Bays
8	Slim DVD Bay**

* SAS3 support requires additional parts in optional parts list
 ** DVD support requires additional parts in optional parts list

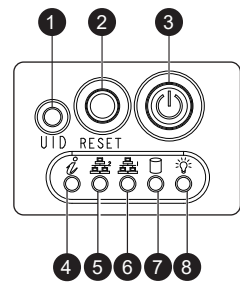

No.	Description
1	UID Button
2	Reset Button
3	Power Button
4	Universal Information LED
5	NIC2 LED
6	NIC1 LED
7	HDD LED
8	Power LED
9	Device Activity LED
10	Device Status LED
11	Service/Asset Tag, Pull-out identifier (with BMC ADMIN default password underneath)

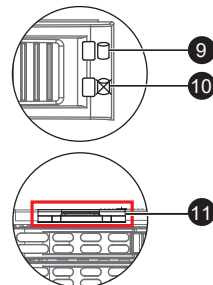

Rear View and Features

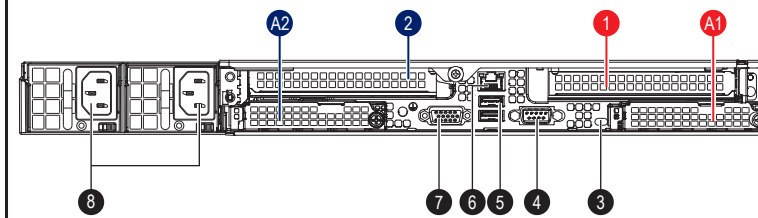

No.	Description
1	PCIe 4.0 x16 slot: full height, half-length (CPU1)
2	PCIe 4.0 x16 slot: full height, half-length (CPU2)
A1	PCIe 4.0 x16 OCP 3.0 AIOM slot (CPU1)
A2	PCIe 4.0 x16 OCP 3.0 AIOM slot (CPU2)
3	UID LED/BMC Reset
4	COM Port
5	USB Ports
6	Dedicated IPMI LAN port
7	VGA Port
8	Power Supplies

Memory

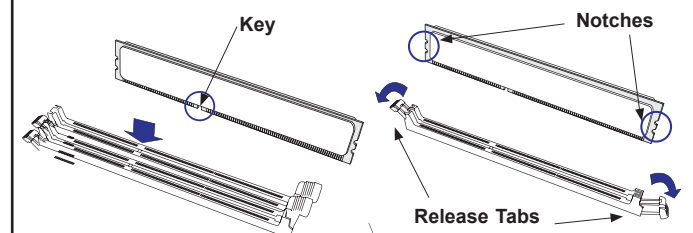

DIMM Installation

1. Insert the desired number of DIMMs into the memory slots.
Note: Unbalanced population will impact memory performance. Refer to server manual for full population guide.
2. Push the release tabs outwards on both ends of the DIMM slot to unlock it.
3. Align the key of the DIMM module with the receptive point on the memory slot.
4. Align the notches on both ends of the module against the receptive points on the ends of the slot.
5. Use two thumbs together to press the notches on both ends of the module straight down into the slot until the module snaps into place.
6. Press the release tabs to the lock positions to secure the DIMM module into the slot.

BMC Password Label

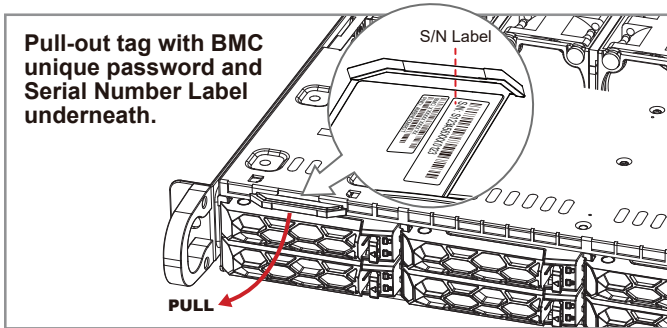

Each system comes with a unique default password for the ADMIN user. This can be found on a sticker on the motherboard and a sticker underneath the service tag on chassis. If necessary, the password can be reset by the Supermicro IPMICFG tool.

For more information, please visit <https://www.supermicro.com/en/solutions/management-software/bmc-resources>

CPU Installation

1. Put processor into bracket – attention to the lineup Pin and key on both processor and carrier.
2. Put processor carrier module into HS. Processor Carrier Assembly
3. Put processor heatsink module into MB.

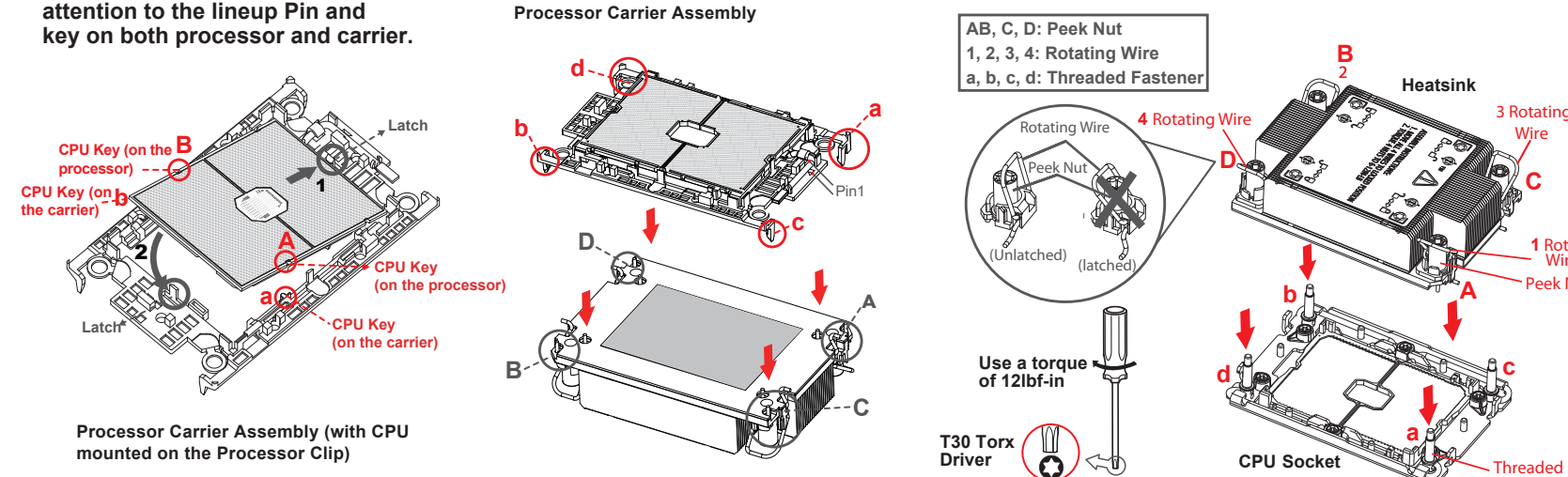

Caution and Product Resources

- SAFETY INFORMATION:**
 IMPORTANT: See installation instructions and safety warning before connecting system to power supply.
http://www.supermicro.com/about/policies/safety_information.cfm
- WARNING:**
 To reduce risk of electric shock/damage to equipment, disconnect power from server by disconnecting all power cords from electrical outlets. If any CPU socket empty, install protective plastic CPU cap.
- CAUTION:**
 Always be sure all power supplies for this system have the same power output. If mixed power supplies are installed, the system will not operate.
- CAUTION:**
 This unit has redundant power sources. Please disconnect all the power cords before servicing.
- PRODUCT RESOURCES:**
 For more information go to: <http://www.supermicro.com/support>

