



MICROBLADE[®] SERVER

MBI-310I-1D96N



USER'S MANUAL

Revision 1.0

The information in this User's Manual has been carefully reviewed and is believed to be accurate. The vendor assumes no responsibility for any inaccuracies that may be contained in this document, and makes no commitment to update or to keep current the information in this manual, or to notify any person or organization of the updates. Please Note: For the most up-to-date version of this manual, please see our website at www.supermicro.com.

Super Micro Computer, Inc. ("Supermicro") reserves the right to make changes to the product described in this manual at any time and without notice. This product, including software and documentation, is the property of Supermicro and/or its licensors, and is supplied only under a license. Any use or reproduction of this product is not allowed, except as expressly permitted by the terms of said license.

IN NO EVENT WILL Super Micro Computer, Inc. BE LIABLE FOR DIRECT, INDIRECT, SPECIAL, INCIDENTAL, SPECULATIVE OR CONSEQUENTIAL DAMAGES ARISING FROM THE USE OR INABILITY TO USE THIS PRODUCT OR DOCUMENTATION, EVEN IF ADVISED OF THE POSSIBILITY OF SUCH DAMAGES. IN PARTICULAR, SUPER MICRO COMPUTER, INC. SHALL NOT HAVE LIABILITY FOR ANY HARDWARE, SOFTWARE, OR DATA STORED OR USED WITH THE PRODUCT, INCLUDING THE COSTS OF REPAIRING, REPLACING, INTEGRATING, INSTALLING OR RECOVERING SUCH HARDWARE, SOFTWARE, OR DATA.

Any disputes arising between manufacturer and customer shall be governed by the laws of Santa Clara County in the State of California, USA. The State of California, County of Santa Clara shall be the exclusive venue for the resolution of any such disputes. Supermicro's total liability for all claims will not exceed the price paid for the hardware product.

FCC Statement: This equipment has been tested and found to comply with the limits for a Class A or Class B digital device pursuant to Part 15 of the FCC Rules. These limits are designed to provide reasonable protection against harmful interference when the equipment is operated in industrial environment for Class A device or in residential environment for Class B device. This equipment generates, uses, and can radiate radio frequency energy and, if not installed and used in accordance with the manufacturer's instruction manual, may cause harmful interference with radio communications. Operation of this equipment in a residential area is likely to cause harmful interference, in which case you will be required to correct the interference at your own expense.

California Best Management Practices Regulations for Perchlorate Materials: This Perchlorate warning applies only to products containing CR (Manganese Dioxide) Lithium coin cells. "Perchlorate Material-special handling may apply. See www.dtsc.ca.gov/hazardouswaste/perchlorate".



WARNING: This product can expose you to chemicals including lead, known to the State of California to cause cancer and birth defects or other reproductive harm. For more information, go to www.P65Warnings.ca.gov.

The products sold by Supermicro are not intended for and will not be used in life support systems, medical equipment, nuclear facilities or systems, aircraft, aircraft devices, aircraft/emergency communication devices or other critical systems whose failure to perform be reasonably expected to result in significant injury or loss of life or catastrophic property damage. Accordingly, Supermicro disclaims any and all liability, and should buyer use or sell such products for use in such ultra-hazardous applications, it does so entirely at its own risk. Furthermore, buyer agrees to fully indemnify, defend and hold Supermicro harmless for and against any and all claims, demands, actions, litigation, and proceedings of any kind arising out of or related to such ultra-hazardous use or sale.

Manual Revision 1.0

Release Date: January 10, 2025

mk

Unless you request and receive written permission from Super Micro Computer, Inc., you may not copy any part of this document. Information in this document is subject to change without notice. Other products and companies referred to herein are trademarks or registered trademarks of their respective companies or mark holders.

Copyright © 2025 by Super Micro Computer, Inc.
All rights reserved.

Printed in the United States of America

Preface

About this Manual

This manual is written for professional system integrators and technicians. It provides information for the installation and use of the blade server. Installation and maintenance should be performed by certified service technicians only.

Please refer to the MBI-310I-1D96N server specifications [page](#) on our website for updates on supported memory, processors and operating systems.

Notes

For your system to work properly, please follow the links below to download all necessary drivers/utilities and the user's manual for your server.

- Supermicro product manuals: <https://www.supermicro.com/support/manuals/>
- Product drivers and utilities: <https://www.supermicro.com/wdl>
- Product safety info: https://www.supermicro.com/about/policies/safety_information.cfm

If you have any questions, please contact our support team at:
support@supermicro.com

This manual may be periodically updated without notice. Please check the Supermicro website for possible updates to the manual revision level.

Secure Data Deletion

A secure data deletion tool designed to fully erase all data from storage devices can be found on our website: https://www.supermicro.com/about/policies/disclaimer.cfm?url=/wdl/utility/Lot9_Secure_Data_Deletion_Utility/

Warnings

Special attention should be given to the following symbols used in this manual.



Warning! Indicates important information given to prevent equipment/property damage or personal injury.



Warning! Indicates high voltage may be encountered when performing a procedure.

Contents

Chapter 1 Introduction

1.1 Overview.....	8
Eligible Enclosures.....	8
1.2 System Features.....	9
Front View.....	9
Control Panel.....	10
Top view.....	11
System Block Diagrams.....	13
1.3 Motherboard Layout.....	14
Quick Reference.....	15
Motherboard Block Diagram.....	16

Chapter 2 Installation and Setup

2.1 Unpacking the System.....	17
2.2 Installing or Removing the Blade Unit.....	18
Installing a Blade Unit into the Enclosure.....	18
Removing a Blade Unit from the Enclosure.....	18
2.3 Powering On or Off.....	19
2.4 Processor and Heatsink Installation.....	19
2.5 Memory.....	20
Memory Support.....	20
Memory Population.....	20
Installing Memory.....	21
2.6 Replacing the Battery.....	22
2.7 Storage Drives.....	23
M.2 SSDs.....	25
Checking the Temperature of an NVMe Drive.....	26
2.8 System Cooling.....	27
Installing the Air Shrouds.....	27
Overheating.....	28

Chapter 3 Motherboard Connections

3.1 Headers and Connectors.....	29
3.2 Jumpers.....	31
Explanation of Jumpers.....	31

3.3 LED Indicators.....	32
Chapter 4 Software	
4.1 Microsoft Windows OS Installation.....	33
4.2 Driver Installation.....	35
4.3 BMC.....	36
BMC ADMIN User Password	36
Chapter 5 Optional Components	
5.1 TPM Security Module.....	37
5.2 Intel Virtual RAID on CPU (VROC).....	38
Requirements and Restrictions	38
Supported SSDs and Operating Systems	38
Additional Information	39
Hardware Key	39
Configuring Intel VMD.....	40
Configuring VMD Manually.....	40
Creating NVMe RAID Configurations.....	44
Status Indications.....	45
Hot-Swap Drives	45
Hot-unplug	45
Hot-plug	45
Related Information Links	45
Chapter 6 Troubleshooting and Support	
6.1 Information Resources.....	46
Website	46
Direct Links.....	46
Direct Links for General Support and Information	46
6.2 BMC Interface	47
6.3 Troubleshooting Procedures	48
General Technique	48
No Power	48
No Video	48
System Boot Failure	48
Memory Errors	48
Losing the System Setup Configuration	49
When the System Becomes Unstable	49

6.4 Crash Dump Using the BMC Dashboard.....50

6.5 UEFI BIOS Recovery51

 Overview51

 Recovering the UEFI BIOS Image.....51

 Recovering the Main BIOS Block with a USB Device.....51

6.6 CMOS Clear56

6.7 BMC Reset.....56

6.8 Where to Get Replacement Components57

6.9 Reporting an Issue57

 Technical Support Procedures57

 Returning Merchandise for Service.....57

 Vendor Support Filing System58

6.10 Feedback.....58

6.11 Contacting Supermicro.....59

Appendix A BIOS POST Codes

Appendix B Standardized Warning Statements for AC Systems

Appendix C Specifications and Compliance

Contacting Supermicro

Headquarters

Address: Super Micro Computer, Inc.
980 Rock Ave.
San Jose, CA 95131 U.S.A.

Tel: +1 (408) 503-8000

Fax: +1 (408) 503-8008

Email: marketing@supermicro.com (General Information)
Sales-USA@supermicro.com (Sales Inquiries)
Government_Sales-USA@supermicro.com (Gov. Sales Inquiries)
support@supermicro.com (Technical Support)
RMA@supermicro.com (RMA Support)
Webmaster@supermicro.com (Webmaster)

Website: www.supermicro.com

Europe

Address: Super Micro Computer B.V.
Het Sterrenbeeld 28, 5215 ML
's-Hertogenbosch, The Netherlands

Tel: +31 (0) 73-6400390

Fax: +31 (0) 73-6416525

Email: Sales_Europe@supermicro.com (Sales Inquiries)
Support_Europe@supermicro.com (Technical Support)
RMA_Europe@supermicro.com (RMA Support)

Website: www.supermicro.nl

Asia-Pacific

Address: Super Micro Computer, Inc.
3F, No. 150, Jian 1st Rd.
Zhonghe Dist., New Taipei City 235
Taiwan (R.O.C)

Tel: +886-(2) 8226-3990

Fax: +886-(2) 8226-3992

Email: Sales-Asia@supermicro.com.tw (Sales Inquiries)
Support@supermicro.com.tw (Technical Support)
RMA@supermicro.com.tw (RMA Support)

Website: www.supermicro.com.tw

Chapter 1

Introduction

1.1 Overview

The MBI-310I-1D96N blade is a compact, self-contained server that connects into a pre-cabled enclosure that provides power, cooling, management and networking functions. A Supermicro 6U Microblade enclosure can hold 20 blades. Each blade contains two computing nodes.

In this manual, “blade” or “blade unit” refers to a single blade, and “blade enclosure” is the chassis that houses the blades, power supplies and other modules. “Blade system” refers to the enclosure, blades units, and various management and networking modules.

System Overview (per Node)	
Motherboard	B3SD1-20C-25G
Processor	Single Intel® Xeon® D-2796NT Processor SoC in socket FCBGA 2579 with up to 20 cores and 120 W TDP
Memory	Up to 256 GB of DDR4 ECC LRDIMM memory with speeds of up to 2933 MT/s in two DIMM slots; DIMM Size: Up to 256 GB
Storage Drives	One fixed internal 2.5" NVMe U.2 drive One M.2 SATA/NVMe One SATA DOM
I/O Ports	LAN: Two 25 GbE and one dedicated BMC port
System Cooling	One air shroud
Blade Form Factor	3U height; 1.2" x 4.94" x 23.2" (depth) (30.5 x 125.5 x 589.3 mm)

Eligible Enclosures

- MBE-620E-830/630/430/822/622/422

1.2 System Features

The following views of the system display the main features. Refer to [Appendix C](#) for additional specifications.

Front View

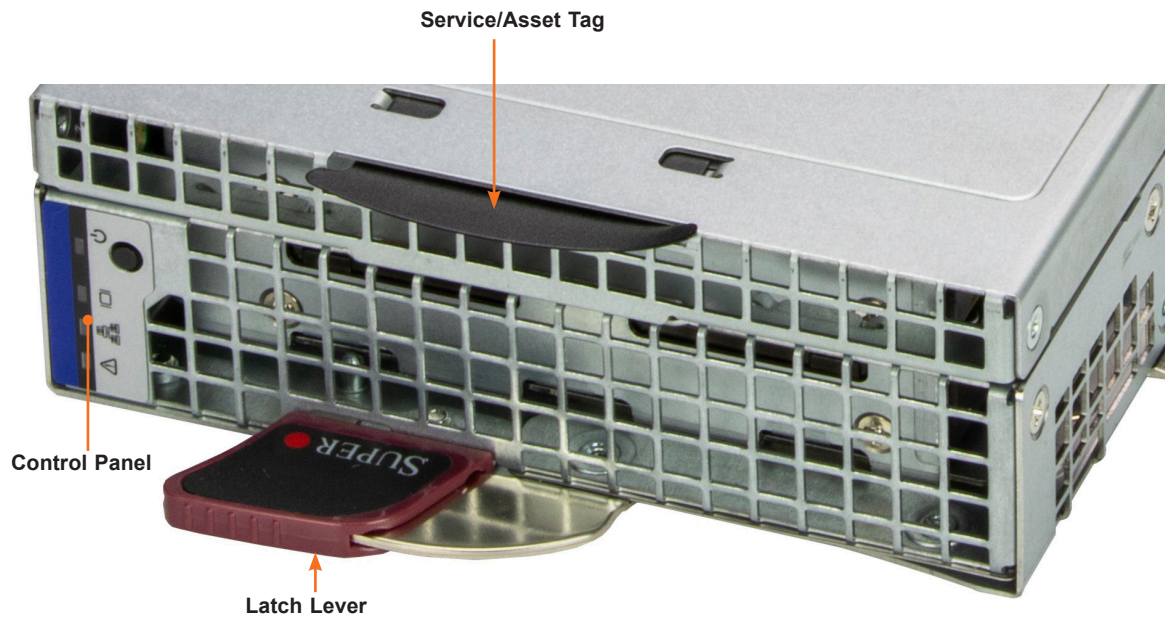

Figure 1-1. Front View

Chassis Front Features	
Features	Descriptions
Control Panel	Power button and status indicators
Latch Lever	Lever to secure the blade in the enclosure
Service/Asset Tag	Pull-out identifier (with BMC ADMIN default password sticker)

Control Panel

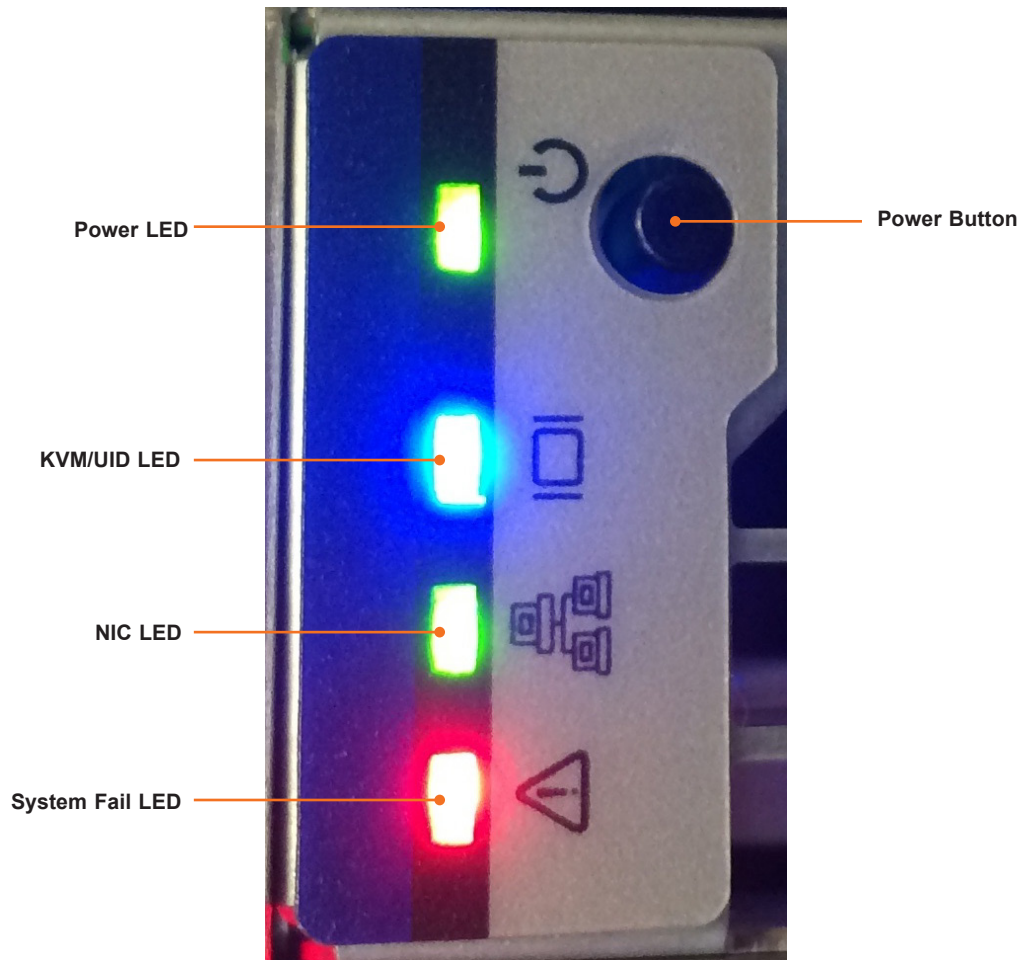

Figure 1-2. Control Panel

Control Panel Features		
Feature	State	Description
Power button		The main power switch applies or removes primary power from the power supply to the server but maintains standby power.
Power LED	Green	Power on
	Amber steady	Power off
	Amber blinking	Before the BMC is ready, blinks until every node is ready
KVM/UID LED	Blue steady	Indicates that KVM has been initialized
	Blue blinking	Unit Identifier indicator (The UID function is activated with a management program.)
NIC LED	Green blinking	Indicates traffic (Tx and RX data) on the LAN connection to this blade module
	Amber blinking	Indicates traffic over the network (when present in the system)
System Fail LED	Red	Indicates a fatal error. This may be a memory error, a VGA error or any other fatal error that prevents the operating system from booting.

Top view

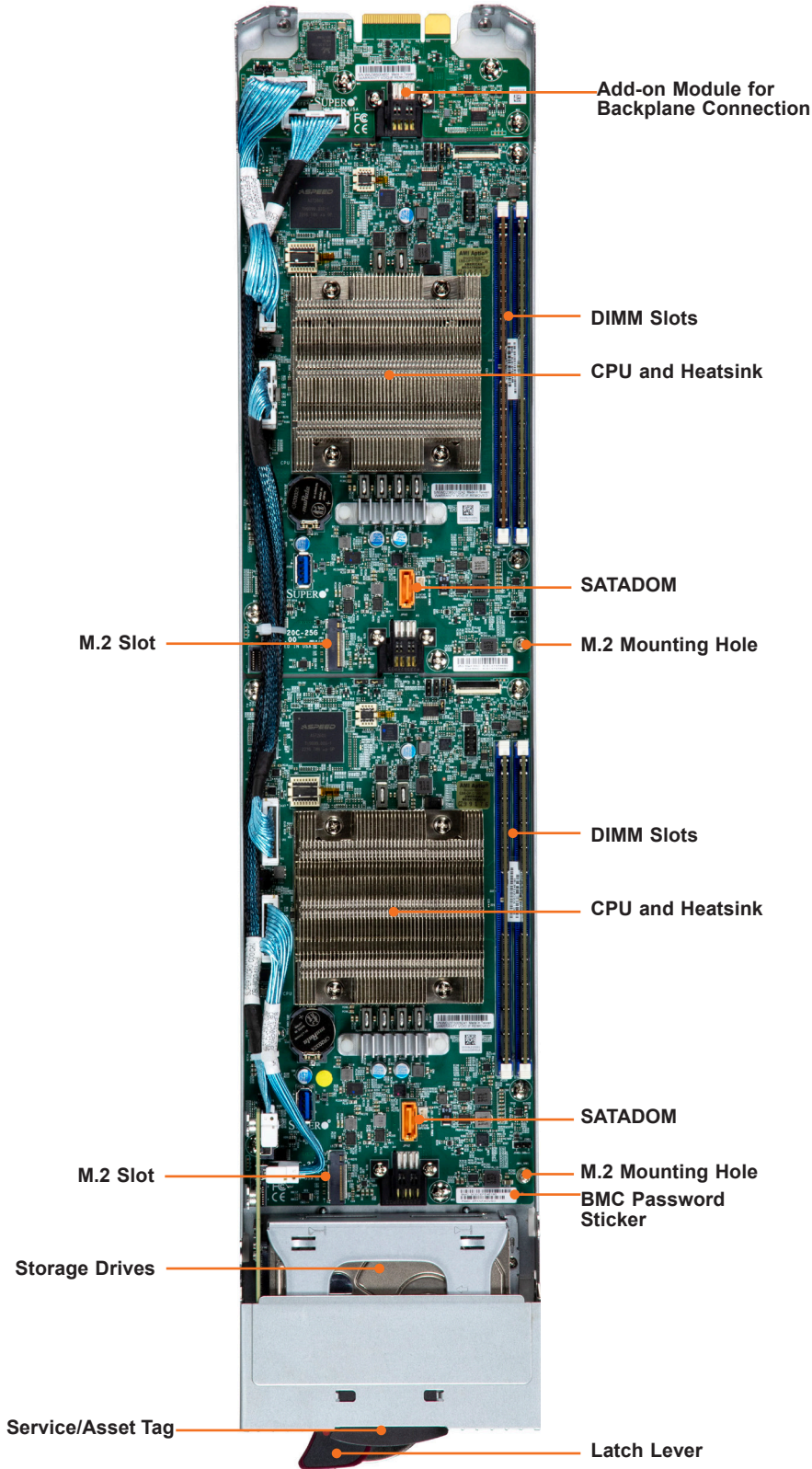

Figure 1-3. Components

Components	
Feature	Description
Drives	Two 2.5" storage drives
M.2	Slot for M.2 SSD
SATA DOM	SATA port that supports disk-on-module (DOM)
Add-on Module	Provides connection to blade enclosure backplane
DIMM Slots	Memory
CPU and Heatsink	Processors and heatsinks
BMC Password	Sticker showing the BMC ADMIN default password
Service/Asset Tag	Pull-out identifier (with BMC ADMIN default password sticker)

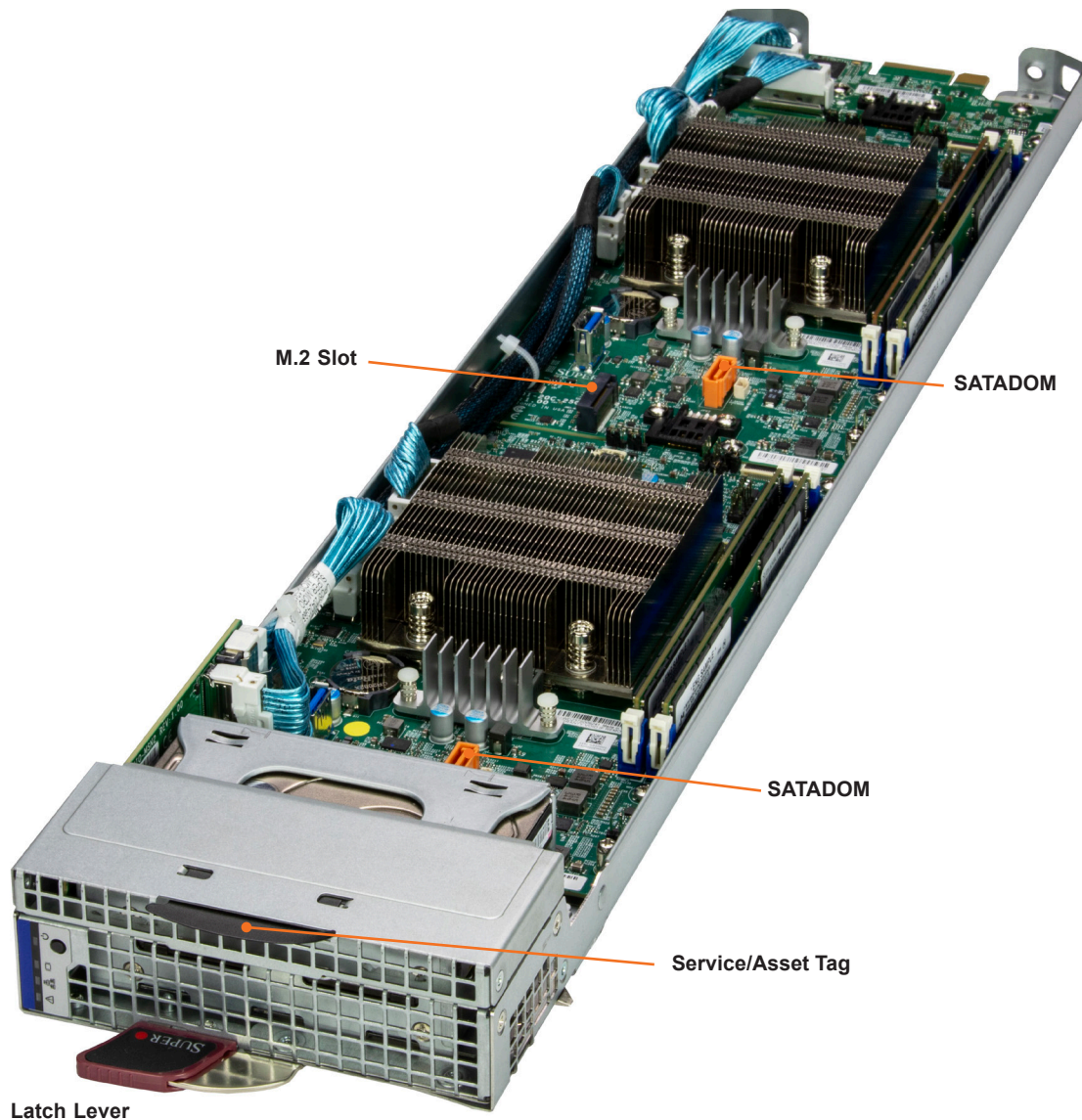
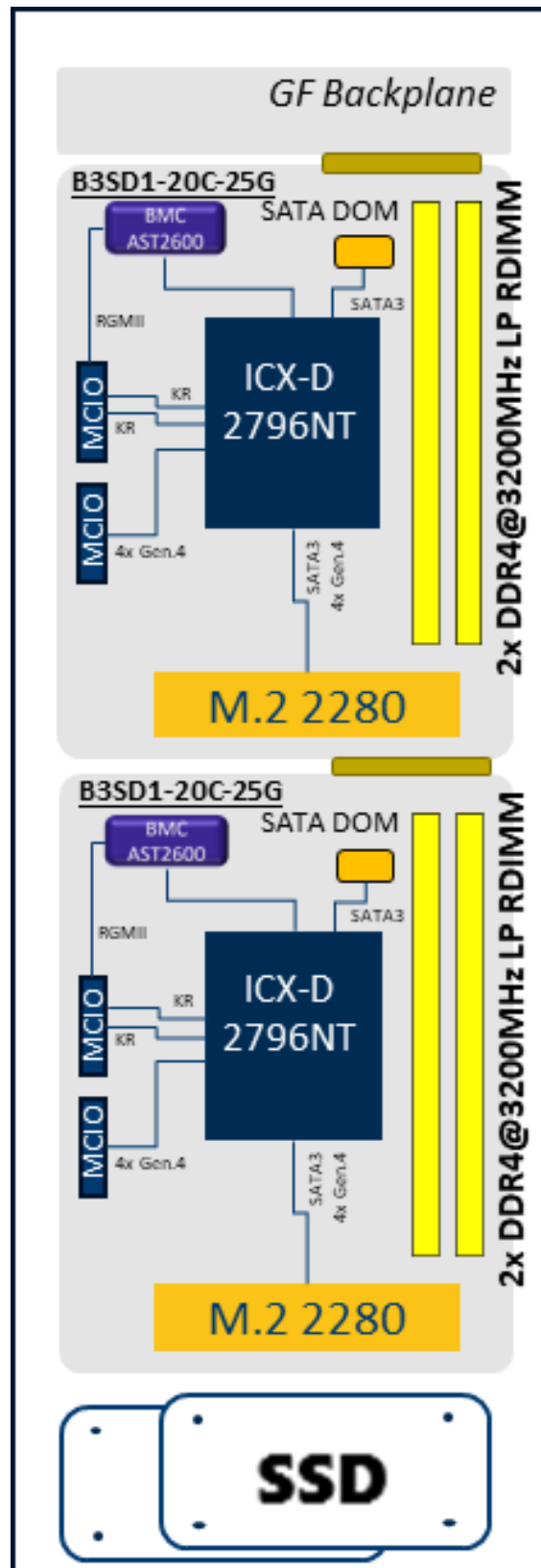

Figure 1-4. Components

System Block Diagrams



<Placeholder--Do we have a system block diagram? >

Figure 1-5. System Block Diagram

1.3 Motherboard Layout

Below is a layout of the B3SD1-20C-25G motherboard with jumper, connector and LED locations shown. See the table on the following page for descriptions. For detailed descriptions, pinout information and jumper settings, refer to [Chapter 3](#) or the [Motherboard Manual](#).

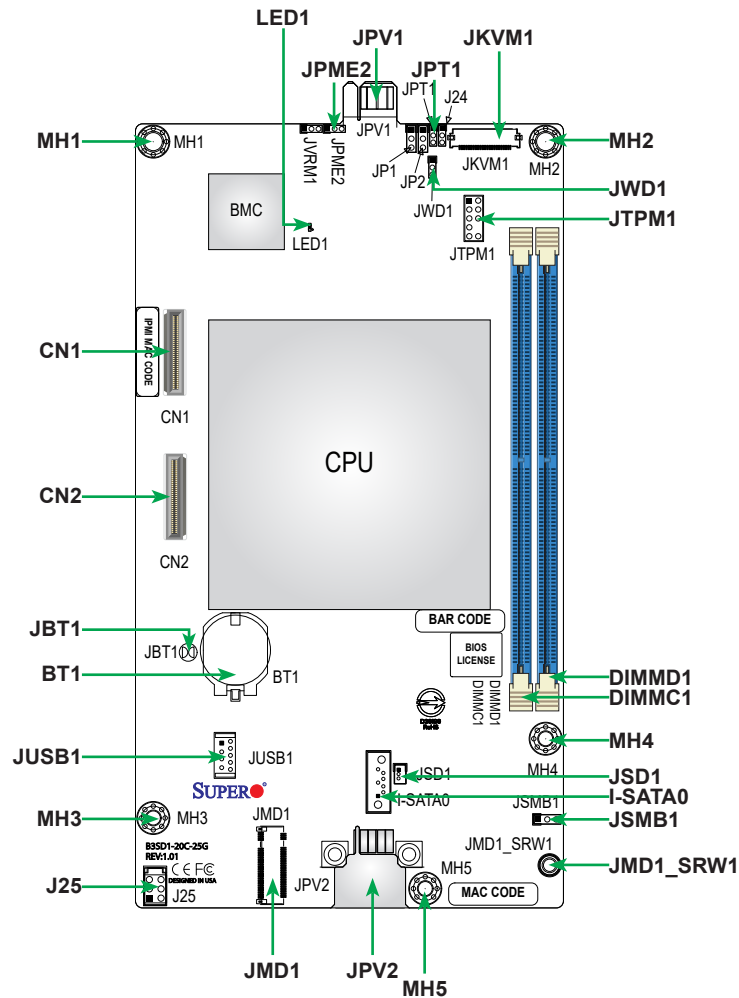

Figure 1-6. Motherboard Layout

Quick Reference

Jumper	Description	Default Setting
JBT1	Onboard CMOS Clear	Open (Normal)
JPME2	Manufacturing Mode	Pins 1-2 (Normal)
JPT1	Onboard TPM 2.0 Enable/Disable	Pins 1-2 (Enable)
JWD1	Watchdog Timer	Pins 1-2 (Reset)

Connector	Description
BT1	Onboard CMOS Battery
CN1	MCIO Connector
CN2	MCIO Connector
I-SATA0	SATA DOM Port
JKVM1	VGA/USB Module Connector
JMD1	M.2 Slot for 2280
JMD1_SRW1	M.2 Mounting Hole
JPV1	Gold Finger to JPV2 of Node 1 or Backplane through AOM-BPNIO-GFR for Power Delivery
JPV2	12 V Power Straddle Connector to Node 2
JSD1	SATA DOM Power Connector
JSMB1	System Management Bus Header
JTPM1	Trusted Platform Module (TPM)/Port 80 Connector
JUSB1	Internal USB 3.0 Type-A Port for Debugging
J25	Power Connector for HDD Backplane
M.2-HC	M.2 M-Key PCIe 4.0 or SATA 3.0 Connector (2280)
MH1 – MH5	Motherboard Mounting Holes

LED	Description	Status
LED1	BMC Heartbeat LED	Blinking Green: BMC Normal

Motherboard Block Diagram

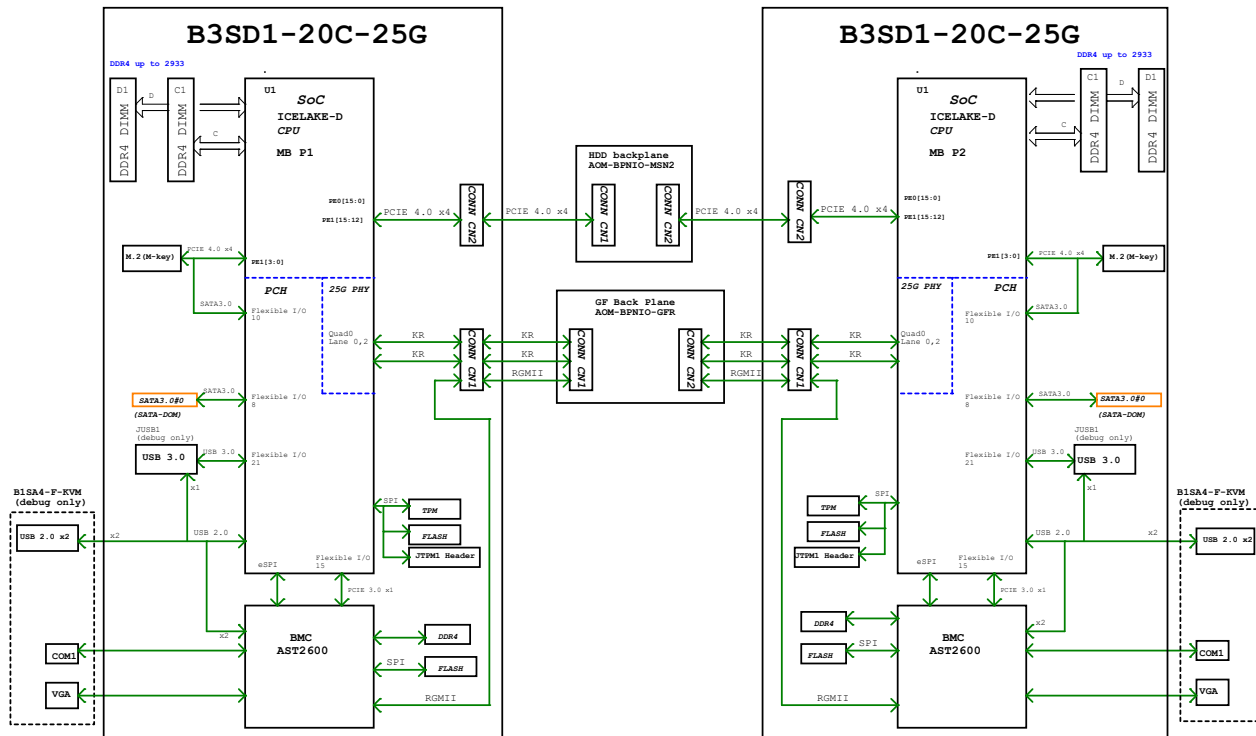

Figure 1-7. Motherboard Block Diagram

Chapter 2

Installation and Setup

This chapter provides instructions on installing and replacing main system components. To prevent compatibility issues, only use components that match the specifications or part numbers.

Up to 20 blade modules may be installed into a blade enclosure, depending upon your enclosure and blade. Blade modules with Windows and Linux operating systems may be mixed together in the same blade enclosure.

2.1 Unpacking the System

Inspect the box the system was shipped in and note if it was damaged in any way. If any equipment appears damaged, please file a damage claim with the carrier who delivered it.

Decide on a suitable location for the rack unit that will hold the enclosure. It should be situated in a clean, dust-free area that is well ventilated. Avoid areas where heat, electrical noise and electromagnetic fields are generated. It will also require a grounded AC power outlet nearby. Be sure to read the precautions and considerations noted in [Appendix B](#).

2.2 Installing or Removing the Blade Unit

Installing a Blade Unit into the Enclosure

1. Pull the locking lever out, and push the blade into its bay. **Caution:** Insert the blade carefully so the rear connectors are not damaged.
2. As the blade is seated in the enclosure, push the lever into its locked position.

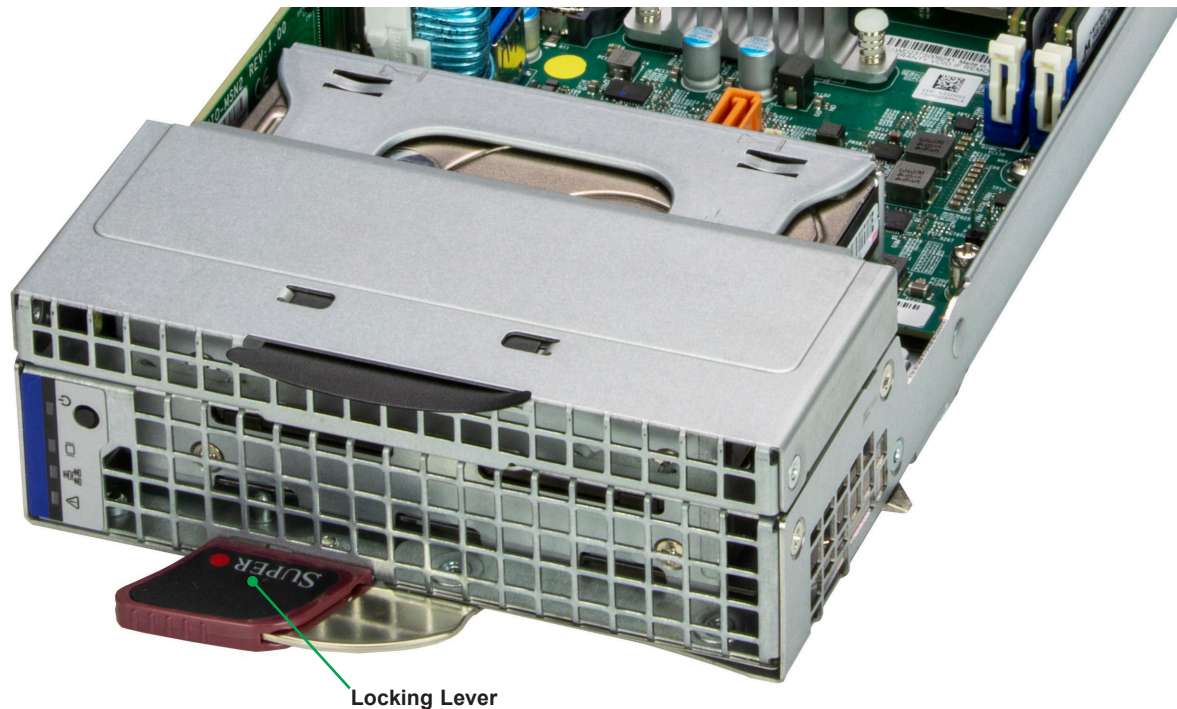

Figure 2-1. Blade Locking Lever

Removing a Blade Unit from the Enclosure

A blade can be removed from the enclosure while other blades continue to operate.

Note: When a blade is removed, please ensure the slot is filled with a dummy blade to ensure the neighboring blades do not overheat.

Removing a Blade Unit from the Enclosure

1. Power down the blade unit.
2. Push and hold the locking lever out.
3. Use the locking lever to pull the blade from the enclosure.

2.3 Powering On or Off

Each blade unit may be powered on and off independently from the rest of the blades in the enclosure.

A blade unit may be powered on or off in any of the following ways:

- Press the power button on the blade unit.
- Use IPMIView or the browser based management utility to power down; requires Operator or Admin privileges on the CMM.
- Use SMCIPMItool when connected to the CMM to power down; requires Operator or Admin privileges on the CMM.
- Use IPMIview or a browser connected to the onboard BMC chip to power down.
- Use SMCIPMItool to use a Command Line Interface to the onboard BMC chip; requires Operator or Admin privileges.

2.4 Processor and Heatsink Installation

The processor and heatsink are installed by the manufacturer and are not serviceable by the customer.

2.5 Memory

Memory Support

Each motherboard supports up to 256 GB of DDR4 ECC LRDIMM memory with speeds of up to 2933 MT/s in two DIMM slots. For validated memory, use our [Product Resources page](#).

- For optimal performance, use memory of the same type, size, and speed. Mixed speeds can be installed, but will run at the speed of the slowest DIMM.

Memory Population

The following memory population table was created based on guidelines provided by Intel to support Supermicro motherboards.

Memory Slots	
DIMMs	Slots
1	C1 or D1
2	C1, D1

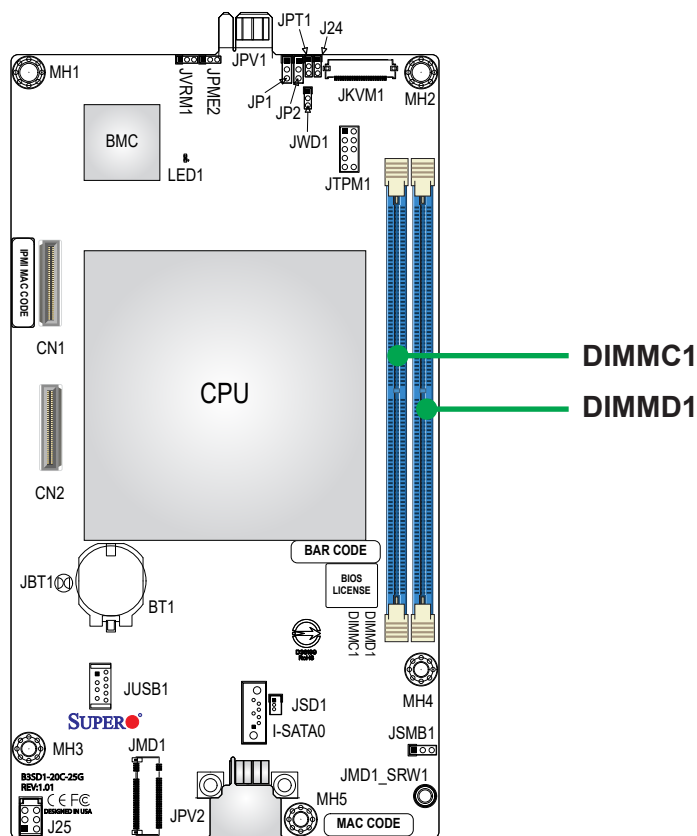

Figure 2-2. Memory Slots Labeled

Installing Memory

ESD Precautions

Electrostatic Discharge (ESD) can damage electronic components including memory modules. To avoid damaging DIMM modules, it is important to handle them carefully. The following measures are generally sufficient.

- Use a grounded wrist strap designed to prevent static discharge.
- Handle the memory module by its edges only.
- Put the memory modules into the antistatic bags when not in use.

Installing Memory

Follow the memory population guidelines in the table above.

1. Push the release tabs outwards on both ends of the DIMM slot to unlock it.

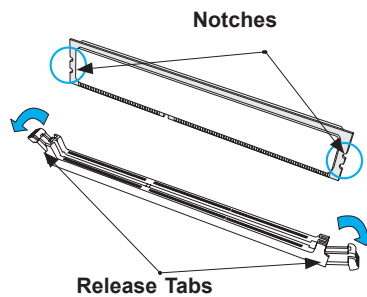

2. Align the key of the DIMM with the receptive point on the memory slot and with your thumbs on both ends of the module, press it straight down into the slot until the module snaps into place.

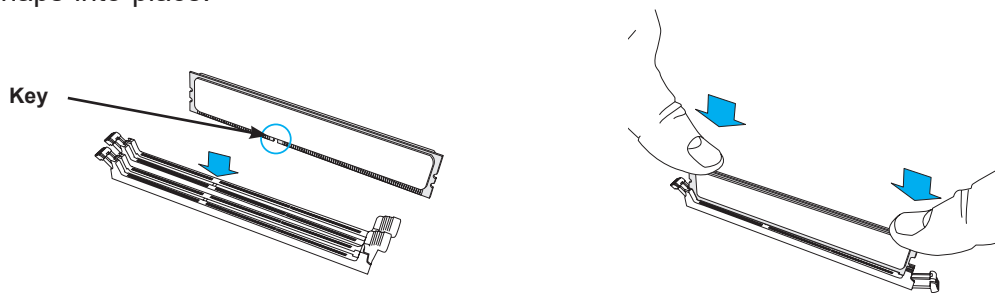

3. Ensure the release tabs are in the locked position to secure the DIMM module into the slot.

Caution: Exercise caution when installing or removing memory modules to prevent damage to the DIMMs or slots.

Removing Memory

To remove a DIMM, unlock the release tabs then pull the DIMM from the memory slot.

2.6 Replacing the Battery

The motherboard uses non-volatile memory to retain system information when system power is removed. This memory is powered by a lithium battery residing on the motherboard.

Replacing the Battery

Begin by [removing power](#) from the system.

1. Push aside the small clamp that covers the edge of the battery. When the battery is released, lift it out of the holder.
2. To insert a new battery, slide one edge under the lip of the holder with the positive (+) side facing up. Then push the other side down until the clamp snaps over it.

Note: Handle used batteries carefully. Do not damage the battery in any way; a damaged battery may release hazardous materials into the environment. Do not discard a used battery in the garbage or a public landfill. Please comply with the regulations set up by your local hazardous waste management agency to dispose of your used battery properly.

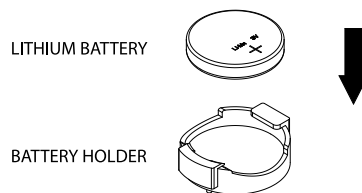

Figure 2-3. Installing the Onboard Battery

Warning: There is a danger of explosion if the onboard battery is installed upside down (which reverses its polarities). This battery must be replaced only with the same or an equivalent type recommended by the manufacturer (CR2032).

2.7 Storage Drives

The blade has two 2.5" internal storage drive bays.

Note: Enterprise level storage drives are recommended for use in Supermicro systems. For information on recommended drives, visit the [system web page](#).

Installing a Drive

1. Remove the small chassis portion covering the drive bracket by removing two screws on the side of the blade.
2. Remove the drive housing bracket by removing locking screw and pulling out the bracket.
3. Insert the drives into the housing bracket and secure them with screws.

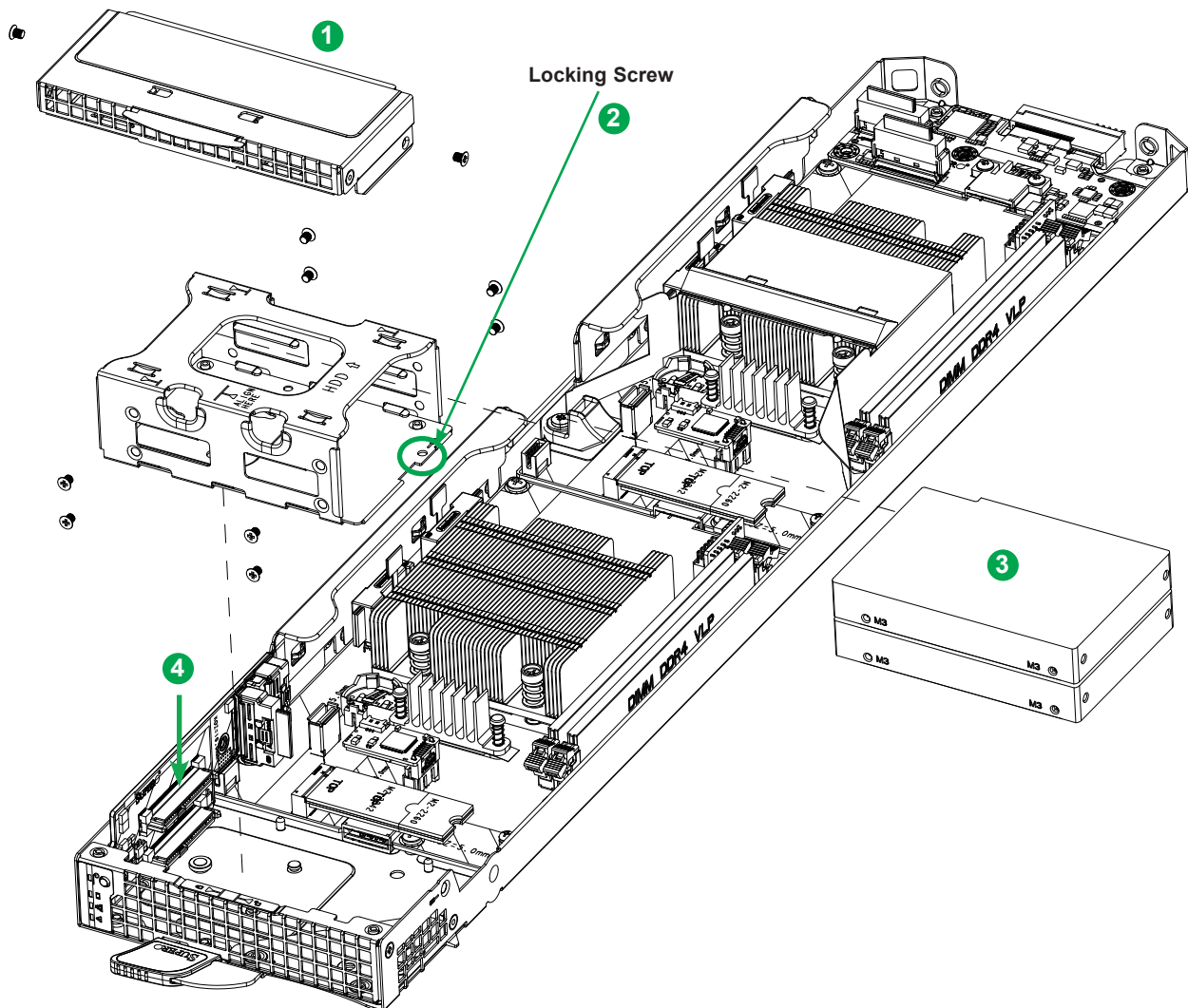

Figure 2-4. Installing Storage Drives

4. Replace the bracket and drives into the blade tray, pushing the drives onto the connectors on the left side wall of the blade chassis.
5. Secure the bracket with the locking screw into the blade chassis.
6. Replace the small chassis portion on the blade chassis.

M.2 SSDs

The motherboard offers a slot for a SATA/NVMe PCIe 4.0 x4 M.2 SSD, form factor 2280, M-Key.

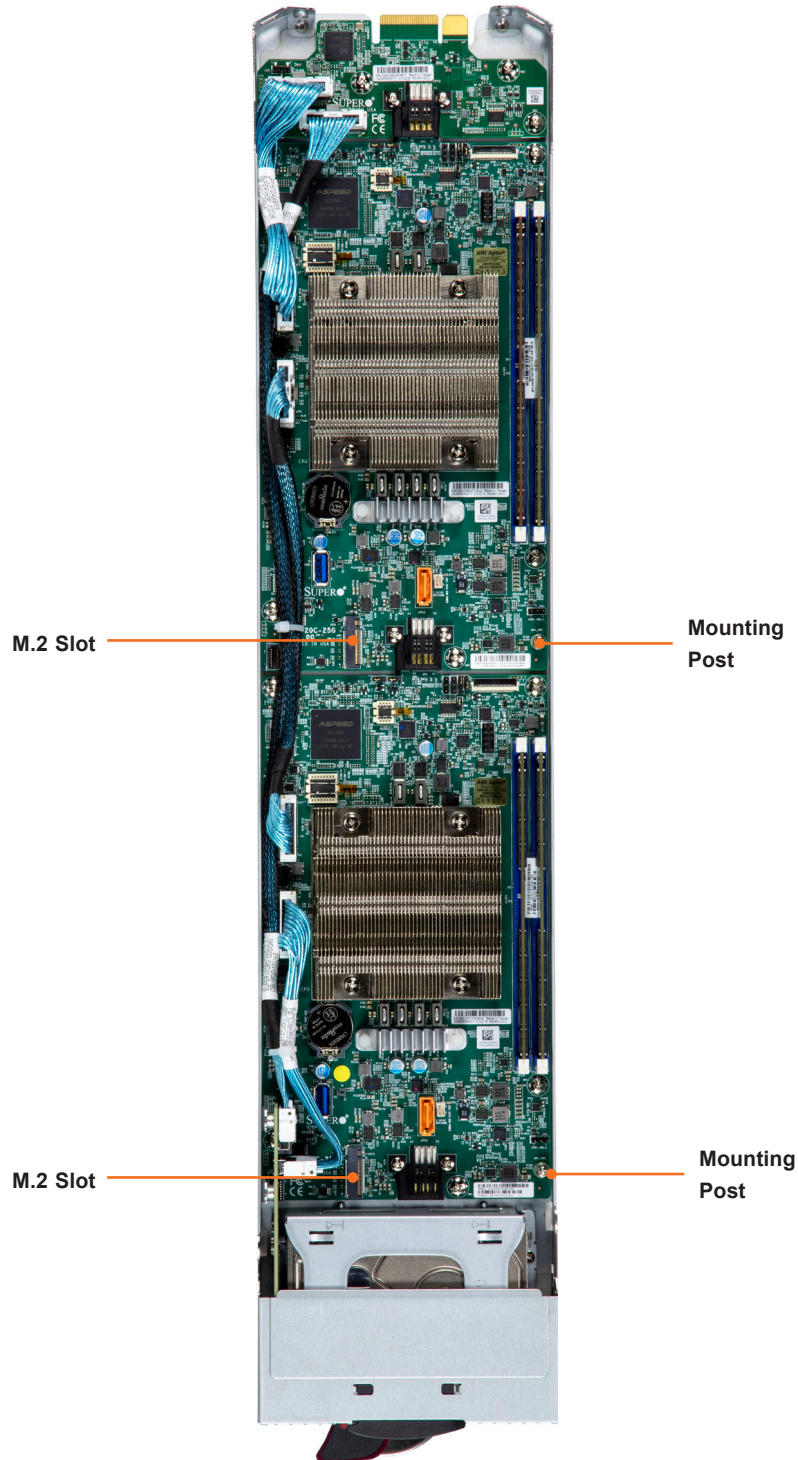

Figure 2-5. M.2 Slots

Installing M.2 Drives

1. Power down the node as described in [Section 2.3](#).
2. Remove the retaining screw from the mounting post.
3. Insert the M.2 SSD sideways into the connector on the motherboard so that it lays flat, then secure it to the mounting post with the screw.
4. Replace the blade and restore the power.

Checking the Temperature of an NVMe Drive

There are two ways to check using the BMC Dashboard.

Checking a Drive

- **BMC Dashboard > Server Health > NVMe SSD** – Shows the temperatures of all NVMe drives.
- **BMC Dashboard > Server Health > Sensor Reading > NVME_SSD** – Shows the single highest temperature among all the NVMe drives.

2.8 System Cooling

Installing the Air Shrouds

Air shrouds concentrate airflow to maximize fan efficiency.

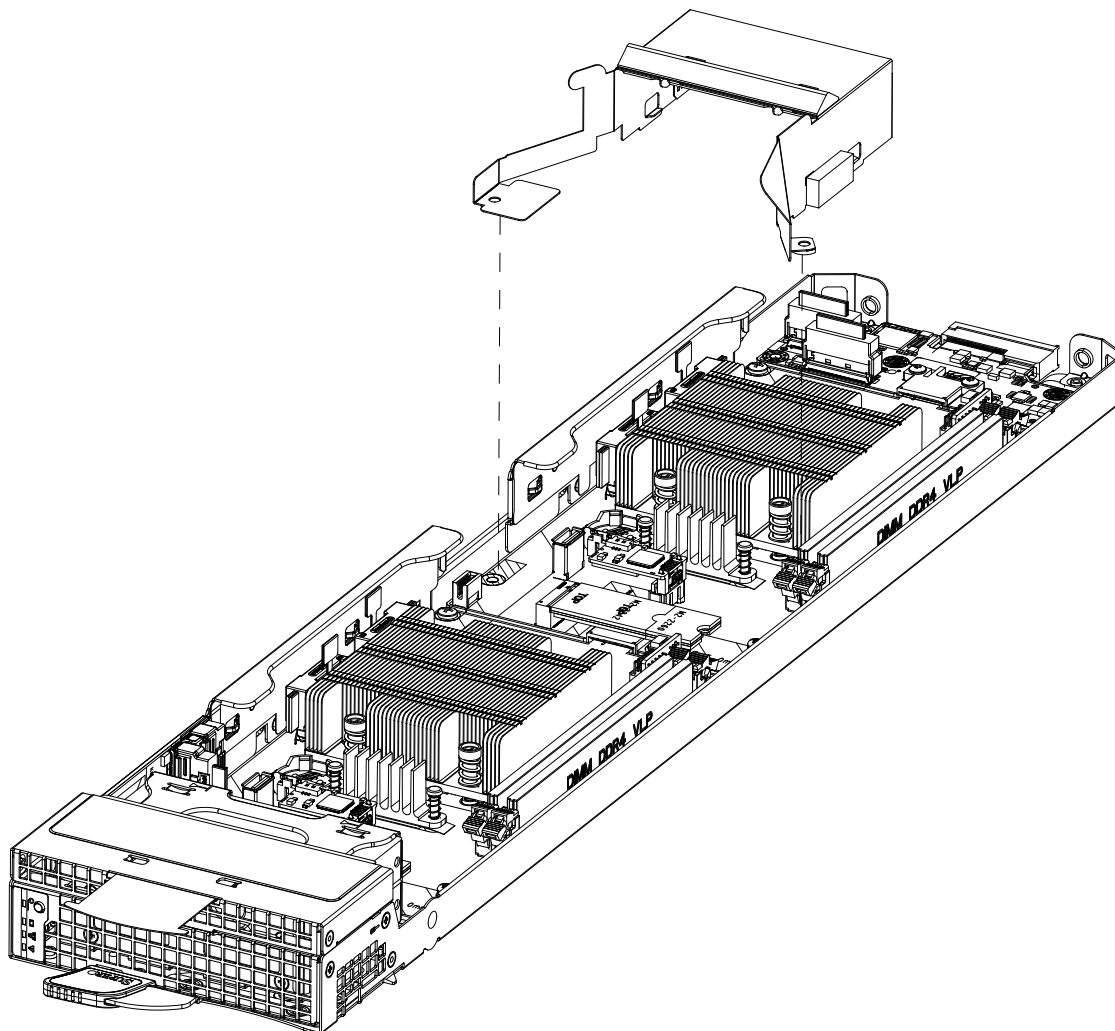

Figure 2-6. Installing the Air Shroud

1. Bend the air shroud along the path shown above, between the DIMMs and the CPU heatsink and curving to the edge of the motherboard.
2. Secure it with the screw.

Overheating

There are several possible responses if the system overheats.

- Make sure there are no objects to obstruct airflow in and out of the server.
- Make sure all fans are operating normally.
- Check the routing of the cables. Pull all excess cabling out of the airflow path or use shorter cables.

Chapter 3

Motherboard Connections

This chapter describes the connections on the motherboard and provides pinout definitions. Note that depending on how the system is configured, not all connections are required. The LEDs on the motherboard are also described here. A motherboard layout indicating component locations may be found in [Chapter 1](#). More detail can be found in the [Motherboard Manual](#). Please review the Safety Precautions in [Appendix B](#) before installing or removing components.

3.1 Headers and Connectors

Main Power Connector

JPV1 is a gold finger to connect to JPV2 of Node 1 or the backplane through the add-on module for power delivery to the motherboard.

12 V Power Straddle Connector to Node 2

JPV2 is a connector to provide 12 V power to Node 2 of the system when connected to JPV1 of Node 2.

Power Connector for Storage Ddrive Backplane

Located at J25 is a power connector for the HDD backplane. Connect J25 of Node 2 to the HDD backplane.

MCIO Connectors

CN1 and CN2 are MCIO connectors. Use CN1 to provide Ethernet and CMM management to the system. Use CN2 to connect to the HDD backplane.

VGA/USB Module Connector

Use JKVM1 to connect to a VGA/USB module.

SATA DOM Port

This motherboard has one SATA DOM port at I-SATA1. I-SATA1 can be used with Supermicro SuperDOMs that are yellow SATA DOM connectors with power pins built in, and do not require external power cables. Supermicro SuperDOMs are backwards compatible with regular SATA HDDs or SATA DOMs that need external power cables.

SATA DOM Power Connector

A SATA Disk-On-Module (DOM) power connector at JSD1 provides 5 V power to a solid-state DOM storage device connected to one of the SATA ports.

DOM Power Pin Definitions	
Pin#	Definition
1	5 V
2	Ground
3	Ground

System Management Bus Header

A System Management Bus (SMBus) header for additional slave devices is located at JSMB1.

SMBus Header Pin Definitions	
Pin#	Definition
1	Data
2	Ground
3	Clock

TPM Header

The JTPM1 header is used to connect a Trusted Platform Module (TPM)/Port 80, which is available from Supermicro. A TPM/Port 80 connector is a security device that supports encryption and authentication in storage drives. It allows the motherboard to deny access if the TPM associated with the storage drive is not installed in the system.

Trusted Platform Module/Port 80 Header Pin Definitions			
Pin#	Definition	Pin#	Definition
1	P3V3	2	SPI_TPM_CS_N
3	PCI-E_RESET_N#	4	SPI_PCH_MISO
5	SPI_PCH_CLK#	6	Ground
7	SPI_PCH_MOSI	8	N/A
9	JTPM1_P3V3A	10	IRQ_TPM_SPIN_N

M.2 M-Key PCIe 4.0 or SATA 3.0 Connector (2280)

This motherboard has one hybrid M.2 slot at M.2-H. M.2-H supports an M-Key PCIe 4.0 x4 or SATA 3.0 device in the 2280 form factor.

3.2 Jumpers

Explanation of Jumpers

To modify the operation of the motherboard, jumpers are used to choose between optional settings. Jumpers create shorts between two pins to change the function associated with it. Pin 1 is identified with a square solder pad on the printed circuit board. See the motherboard layout page for jumper locations.

Note: On a two-pin jumper, "Closed" means the jumper is on both pins and "Open" indicates the jumper is either on only one pin or has been completely removed.

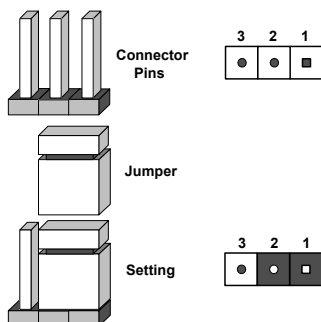

CMOS Clear Contacts

JBT1 is used to clear CMOS. Instead of pins, this jumper consists of contact pads. See the [CMOS Clear section](#) for more information.



JBT1 contact pads

ME Manufacturing Mode

Close pins 2-3 of jumper JPME2 to bypass SPI flash security and force the system to operate in the manufacturing mode, which will allow the user to flash the system firmware from a host server for system setting modifications.

Manufacturing Mode Jumper Settings	
Jumper Setting	Definition
Pins 1-2	Normal (Default)
Pins 2-3	Manufacturing Mode

Onboard TPM2.0 Enable/Disable

Use JPT1 to enable or disable support for the onboard TPM 2.0 module. The default setting is Enabled.

TPM Enable/Disable Jumper Settings	
Jumper Setting	Definition
Pins 1-2	Enabled (Default)
Pins 2-3	Disabled

Watchdog

Watchdog (JWD1) is a system monitor that can reboot the system when a software application hangs. Close pins 1-2 to reset the system if an application hangs. Close pins 2-3 to generate a non-maskable interrupt (NMI) signal for the application that hangs. Refer to the table below for jumper settings. The Watchdog must also be enabled in the BIOS.

Watchdog Jumper Settings	
Jumper Setting	Definition
Pins 1-2	Reset (Default)
Pins 2-3	NMI
Open	Disabled

3.3 LED Indicators

BMC Heartbeat LED

LEDM1 is a BMC Heartbeat indicator. It blinks green when the BMC is working properly.

Chapter 4

Software

After the hardware has been installed, you can install the Operating System (OS), configure RAID settings and install the drivers.

4.1 Microsoft Windows OS Installation

If you will be using RAID, you must configure RAID settings before installing the Windows OS and the RAID driver. Refer to the RAID Configuration User Guides posted on our website at www.supernmicro.com/support/manuals.

Installing the OS

1. Create a method to access the MS Windows installation ISO file. That can be a USB flash or media drive.
2. Retrieve the proper RST/RSTe driver. Go to the Supermicro web page for your motherboard and click on "Download the Latest Drivers and Utilities", select the proper driver, and copy it to a USB flash drive.
3. Boot from a bootable device with Windows OS installation. You can see a bootable device list by pressing **F11** during the system startup.

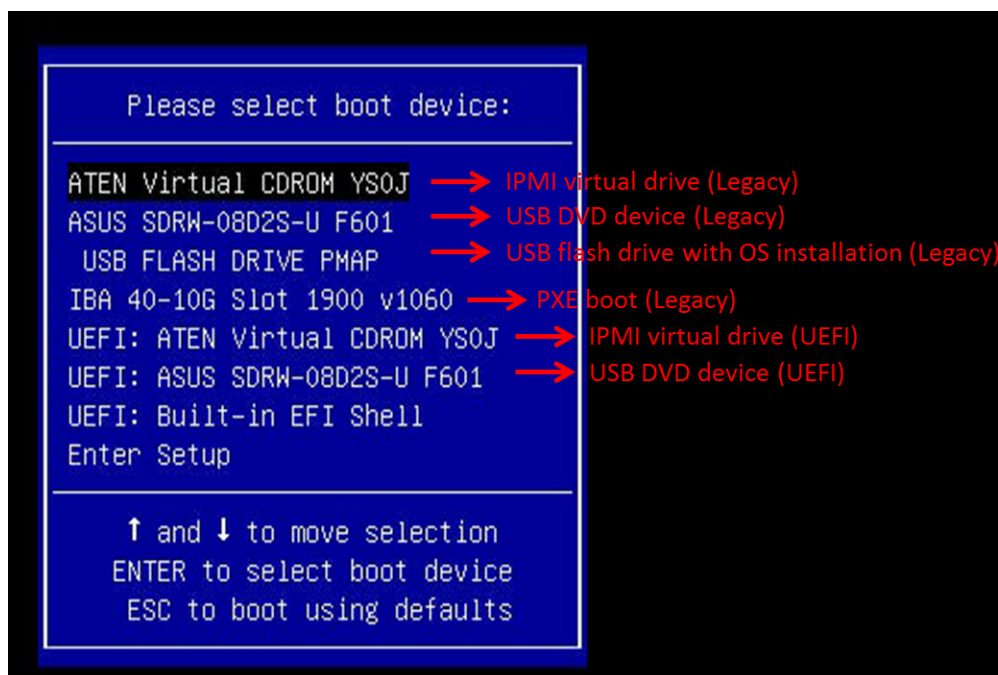

Figure 4-1. Select Boot Device

4. During Windows Setup, continue to the dialog where you select the drives on which to install Windows. If the drive you want to use is not listed, click on “Load driver” link at the bottom left corner.

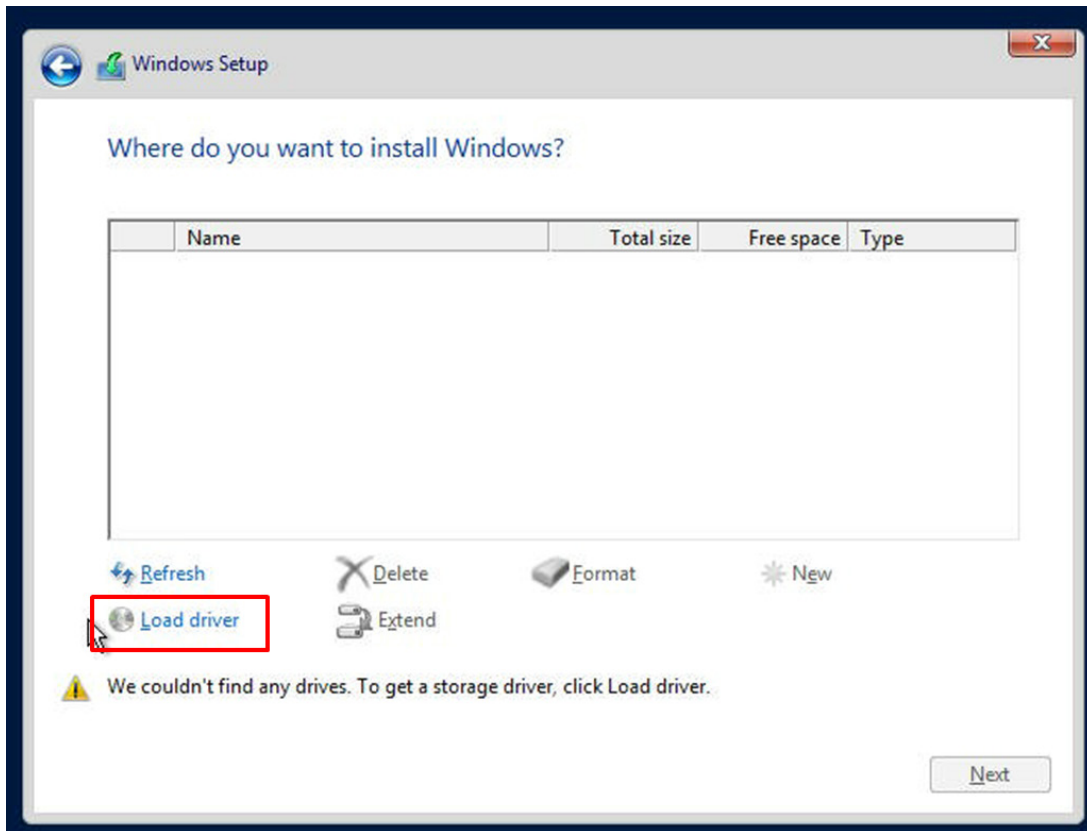

Figure 4-2. Load Driver Link

To load the driver, browse the USB flash drive for the proper driver files.

- For RAID, choose the SATA/sSATA RAID driver indicated then choose the storage drive on which you want to install it.
 - For non-RAID, choose the SATA/sSATA AHCI driver indicated then choose the storage drive on which you want to install it.
5. Once all devices are specified, continue with the installation.
 6. After the Windows OS installation has completed, the system will automatically reboot multiple times.

4.2 Driver Installation

The Supermicro website contains drivers and utilities for your system at <https://www.supermicro.com/wdl/driver>. Some of these must be installed, such as the chipset driver.

After accessing the website, go into the CDR_Images (in the parent directory of the above link) and locate the ISO file for your motherboard. Download this file to to a USB flash drive or media drive. (You may also use a utility to extract the ISO file if preferred.)

Another option is to go to the Supermicro website at <http://www.supermicro.com/products/>. Find the product page for your motherboard, and "Download the Latest Drivers and Utilities".

Insert the flash drive and the screenshot shown below should appear.

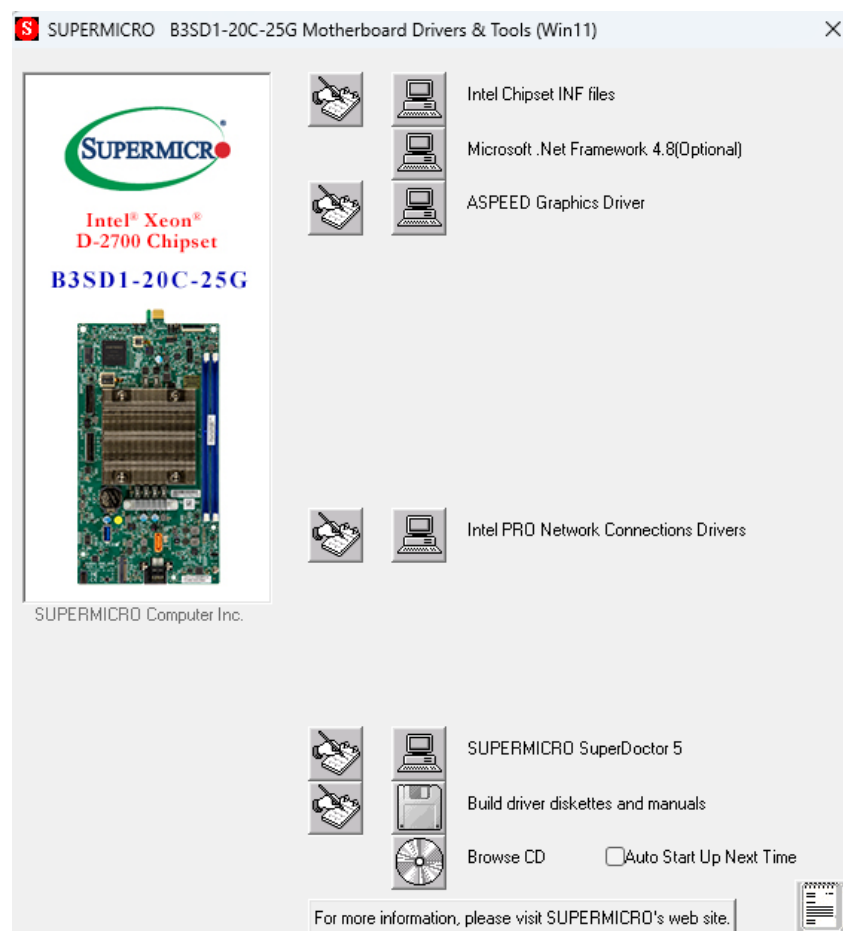

Figure 4-3. Driver & Tool Installation Screen

Note: Click the icons showing a hand writing on paper to view the readme files for each item. Click the computer icons to the right of these items to install each item (from top to the bottom) one at a time. **After installing each item, you must re-boot the system before moving on to the next item on the list.** The bottom icon with a CD on it allows you to view the entire contents.

4.3 BMC

The motherboard provides remote access, monitoring and management through the baseboard management controller (BMC) and other management controllers distributed among different system modules. There are several BIOS settings that are related to BMC. For general documentation and information on BMC, visit our website at:

www.supermicro.com/en/solutions/management-software/bmc-resources

BMC ADMIN User Password

For security, each system is assigned a unique default BMC password for the ADMIN user. This can be found on a sticker on the chassis and a sticker on the motherboard. The sticker also displays the BMC MAC address. If necessary, the password can be reset using the Supermicro IPMICFG tool.

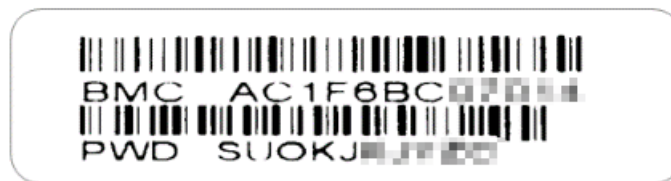

Figure 4-4. BMC Password Label

The sticker can be found on the pull-out service tag at the front of the chassis. See Chapter 1 for the [location](#).

Chapter 6

Troubleshooting and Support

6.1 Information Resources

Website

A great deal of information is available on the Supermicro website, [supermicro.com](https://www.supermicro.com).

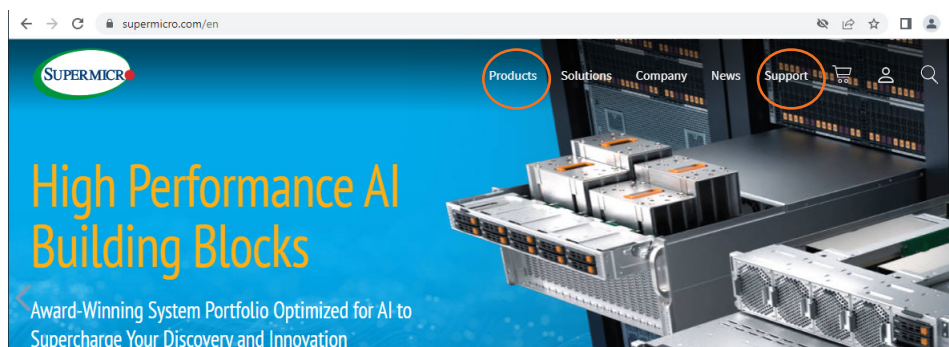

Figure 6-1. Supermicro Website

- Specifications for servers and other hardware are available by clicking the **Products** option.
- The **Support** option offers downloads (manuals, BIOS/BMC, drivers, etc.), FAQs, RMA, warranty, and other service extensions.

Direct Links

Web MBI-310I-1D96N [specifications page](#)

Web B3SD1-20C-25G [motherboard page](#) for links to the Quick Reference Guide, User Manual, validated storage drives, etc.

Direct Links for General Support and Information

[Frequently Asked Questions](#)

[TPM User Guide](#)

[General Memory Configuration Guide](#)

[BMC User Guide](#)

[SuperDoctor5 Large Deployment Guide](#)

For validated memory, use our [Product Resources page](#)

Direct Links (continued)

[Product Matrices](#) page for links to tables summarizing specs for systems, motherboards, power supplies, riser cards, add-on cards, etc.

[Security Center](#) for recent security notices

[Supermicro Phone and Addresses](#)

6.2 BMC Interface

The system supports a Baseboard Management Controller (BMC) interface. It provides remote access, monitoring and management. There are several BIOS settings related to the BMC.

For general documentation and information on the BMC, please visit our website at: www.supermicro.com/manuals/other/BMC_Users_Guide_X13.pdf.

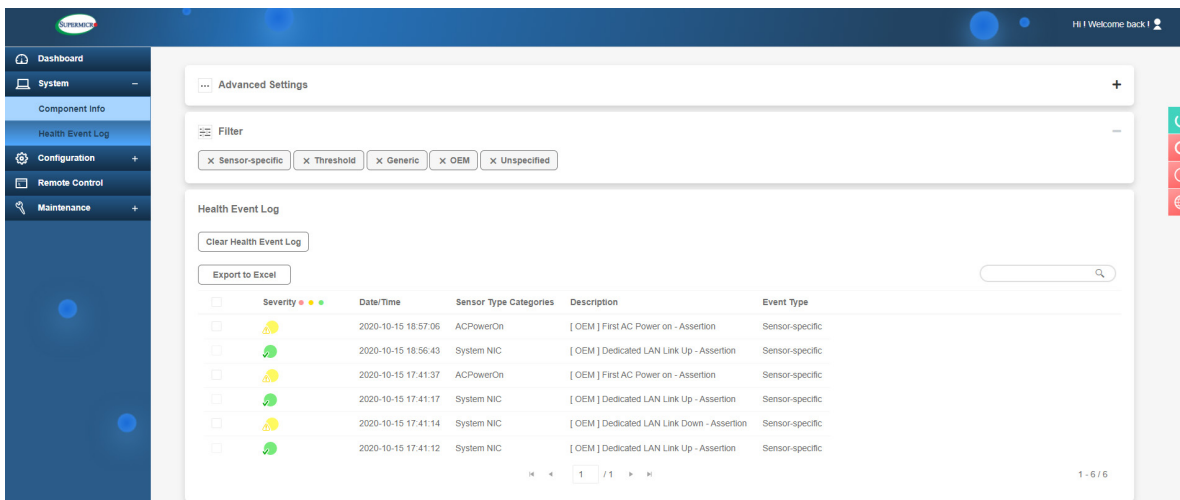

The screenshot displays the BMC Dashboard interface. On the left is a navigation menu with options: Dashboard, System, Component Info, Health Event Log, Configuration, Remote Control, and Maintenance. The main content area is titled 'Advanced Settings' and includes a 'Filter' section with buttons for 'Sensor-specific', 'Threshold', 'Generic', 'OEM', and 'Unspecified'. Below the filter is the 'Health Event Log' section, which contains a 'Clear Health Event Log' button and an 'Export to Excel' button. A table lists the event log entries with columns for Severity, Date/Time, Sensor Type Categories, Description, and Event Type. The table shows six entries, all with a severity of 'Warning' (yellow icon) and an event type of 'Sensor-specific'. The entries are as follows:

Severity	Date/Time	Sensor Type Categories	Description	Event Type
Warning	2020-10-15 18:57:06	ACPowerOn	[OEM] First AC Power on - Assertion	Sensor-specific
Warning	2020-10-15 18:56:43	System NIC	[OEM] Dedicated LAN Link Up - Assertion	Sensor-specific
Warning	2020-10-15 17:41:37	ACPowerOn	[OEM] First AC Power on - Assertion	Sensor-specific
Warning	2020-10-15 17:41:17	System NIC	[OEM] Dedicated LAN Link Up - Assertion	Sensor-specific
Warning	2020-10-15 17:41:14	System NIC	[OEM] Dedicated LAN Link Down - Assertion	Sensor-specific
Warning	2020-10-15 17:41:12	System NIC	[OEM] Dedicated LAN Link Up - Assertion	Sensor-specific

The table also includes a search bar and pagination controls at the bottom, showing '1 / 1' pages.

Figure 6-2. BMC Dashboard Sample

6.3 Troubleshooting Procedures

Use the following procedures to troubleshoot your system. If you have followed all of the procedures below and still need assistance, refer to the [Technical Support Procedures](#) or [Returning Merchandise for Service](#) sections in this chapter. [Power down](#) the system before changing any non hot-swap hardware components.

General Technique

If you experience unstable operation or get no boot response, try:

1. With power off, remove all but one DIMM and other added components, such as add-on cards, from the motherboard. Make sure the motherboard is not shorted to the chassis.
2. Set all jumpers to their default positions.
3. Power up. If the system boots, check for memory errors and add-on card problems.

No Power

- Check that the power LED on the motherboard is on.
- Make sure that the power connector is connected to the power supply.
- Check that the motherboard battery still supplies approximately 3VDC. If it does not, replace it.
- Check that the system input voltage is 100-120v or 180-240v.
- Turn the power switch on and off to test the system

No Video

If the power is on but you have no video, remove all add-on cards and cables.

System Boot Failure

If the system does not display Power-On-Self-Test (POST) or does not respond after the power is turned on, try the following:

- Turn on the system with only one DIMM module installed. If the system boots, check for bad DIMM modules or slots by following the Memory Errors troubleshooting procedure below.

Memory Errors

- Make sure that the DIMM modules are properly and fully installed.

- Confirm that you are using the correct memory. Also, it is recommended that you use the same memory type and speed for all DIMMs in the system. See the [Memory section](#) of this manual for memory details.
- Check for bad DIMM modules or slots by swapping modules between slots and noting the results.

Losing the System Setup Configuration

- Always replace power supplies with the exact same model that came with the system. A poor quality power supply may cause the system to lose the CMOS setup configuration.
- Check that the motherboard battery still supplies approximately 3VDC. If it does not, replace it.

If the above steps do not fix the setup configuration problem, contact your vendor for repairs.

When the System Becomes Unstable

If the system becomes unstable during or after OS installation, check the following:

- CPU/BIOS support: Make sure that your CPU is supported and that you have the latest BIOS installed in your system.
- Memory: Make sure that the memory modules are supported. Refer to the product page on our website at www.supermicro.com. Test the modules using **memtest86** or a similar utility.
- Storage drives: Make sure that all drives work properly. Replace if necessary.
- System cooling: Check that all heatsink fans and system fans work properly. Check the hardware monitoring settings in the BMC to make sure that the CPU and system temperatures are within the normal range. Also check the Control panel Overheat LED.
- Adequate power supply: Make sure that the power supply provides adequate power to the system. Make sure that all power connectors are connected. Refer to the Supermicro website for the minimum power requirements.
- Proper software support: Make sure that the correct drivers are used.

If the system becomes unstable before or during OS installation, check the following:

- Source of installation: Make sure that the devices used for installation are working properly, including boot devices.
- Cable connection: Check to make sure that all cables are connected and working properly.

- Use the minimum configuration for troubleshooting: Remove all unnecessary components (starting with add-on cards first), and use the minimum configuration (but with a CPU and a memory module installed) to identify the trouble areas.
- Identify a bad component by isolating it. Check and change one component at a time.
 - Remove a component in question from the chassis, and test it in isolation. Replace it if necessary.
 - Or swap in a new component for the suspect one.
 - Or install the possibly defective component into a known good system. If the new system works, the component is likely not the cause or the problem.

6.4 Crash Dump Using the BMC Dashboard

In the event of a processor internal error (IERR) that crashes your system, you may want to provide information to support staff. You can download a crash dump of status information using the BMC Dashboard. The BMC manual is available at www.supermicro.com/manuals/other/BMC_Users_Guide_X12_H12.pdf.

Check Error Log

1. Access the BMC web interface.
2. Click the **Server Health** tab, then **Event Log** to verify an IERR error.

Severity	Date/Time	Sensor Type Categories	Description	Event Type
Yellow	2020-10-15 18:57:06	ACPowerOn	[OEM] First AC Power on - Assertion	Sensor-specific
Green	2020-10-15 18:56:43	System NIC	[OEM] Dedicated LAN Link Up - Assertion	Sensor-specific
Yellow	2020-10-15 17:41:37	ACPowerOn	[OEM] First AC Power on - Assertion	Sensor-specific
Green	2020-10-15 17:41:17	System NIC	[OEM] Dedicated LAN Link Up - Assertion	Sensor-specific
Yellow	2020-10-15 17:41:14	System NIC	[OEM] Dedicated LAN Link Down - Assertion	Sensor-specific
Green	2020-10-15 17:41:12	System NIC	[OEM] Dedicated LAN Link Up - Assertion	Sensor-specific

Figure 6-5. BMC Event Log

In the event of an IERR, the BMC executes a crash dump. You must download the crash dump and save it.

6.5 UEFI BIOS Recovery

Warning: Do not upgrade the BIOS unless your system has a BIOS-related issue. Flashing the wrong BIOS can cause irreparable damage to the system. In no event shall Supermicro be liable for direct, indirect, special, incidental, or consequential damages arising from a BIOS update. If you do update the BIOS, do not shut down or reset the system while the BIOS is updating to avoid possible boot failure.

Overview

The Unified Extensible Firmware Interface (UEFI) provides a software-based interface between the operating system and the platform firmware in the pre-boot environment. The UEFI specification supports an architecture-independent mechanism that will allow the UEFI OS loader stored in an add-on card to boot the system. The UEFI offers clean, hands-off management to a computer during system boot.

Recovering the UEFI BIOS Image

A UEFI BIOS flash chip consists of a recovery BIOS block and a main BIOS block (a main BIOS image). The recovery block contains critical BIOS codes, including memory detection and recovery codes for the user to flash a healthy BIOS image if the original main BIOS image is corrupted. When the system power is turned on, the recovery block codes execute first. Once this process is complete, the main BIOS code will continue with system initialization and the remaining POST (Power-On Self-Test) routines.

Note 1: Follow the BIOS recovery instructions below for BIOS recovery when the main BIOS block crashes.

Note 2: When the BIOS recovery block crashes, you will need to follow the procedures to make a Returned Merchandise Authorization (RMA) request. Also, you may use the Supermicro Update Manager (SUM) Out-of-Band (https://www.supermicro.com.tw/products/nfo/SMS_SUM.cfm) to reflash the BIOS.

Recovering the Main BIOS Block with a USB Device

This feature allows the user to recover the main BIOS image using a USB-attached device without additional utilities used. A USB flash device such as a USB Flash Drive, or a USB CD/DVD ROM/RW device can be used for this purpose. However, a USB Hard Disk drive cannot be used for BIOS recovery at this time.

The file system supported by the recovery block is FAT (including FAT12, FAT16, and FAT32) which is installed on a bootable or non-bootable USB-attached device. However, the BIOS might need several minutes to locate the SUPER.ROM file if the media size becomes too large due to the huge volumes of folders and files stored in the device.

To perform UEFI BIOS recovery using a USB-attached device, follow the instructions below.

1. Using a different machine, copy the "Super.ROM" binary image file into the Root "\\" directory of a USB device or a writable CD/DVD.

Note 1: If you cannot locate the "Super.ROM" file in your drive, visit our website at www.supermicro.com to download the BIOS package. Extract the BIOS binary image into a USB flash device and rename it "Super.ROM" for the BIOS recovery use.

Note 2: Before recovering the main BIOS image, confirm that the "Super.ROM" binary image file you download is the same version or a close version meant for your motherboard.

2. Insert the USB device that contains the new BIOS image ("Super.ROM") into your USB drive and reset the system when the following screen appears.
3. After locating the healthy BIOS binary image, the system will enter the BIOS Recovery menu as shown below.



Note: At this point, you may decide if you want to start the BIOS recovery. If you decide to proceed with BIOS recovery, follow the procedures below.

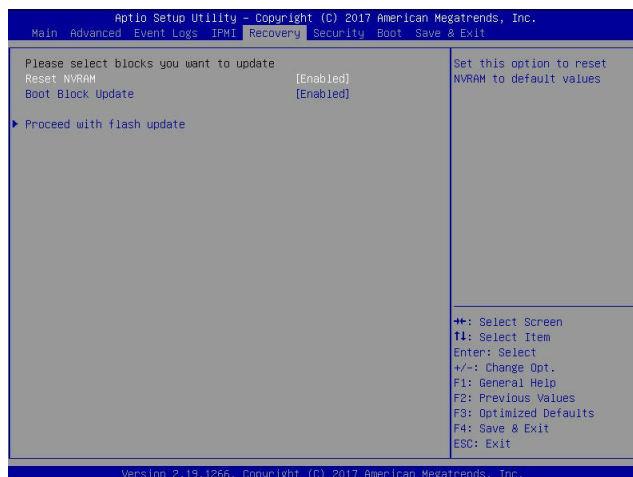

4. When the screen as shown above displays, use the arrow keys to select the item "Proceed with flash update" and press the <Enter> key. You will see the BIOS recovery progress as shown in the screen below.

Note: Do not interrupt the BIOS flashing process until it has completed.

5. After the BIOS recovery process is complete, press any key to reboot the system.
6. Using a different system, extract the BIOS package into a USB flash drive.

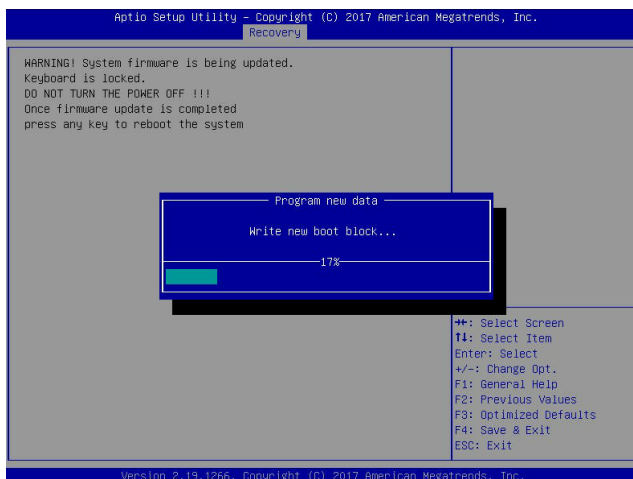

7. Press continuously during system boot to enter the BIOS Setup utility. From the top of the tool bar, select Boot to enter the submenu. From the submenu list, select Boot

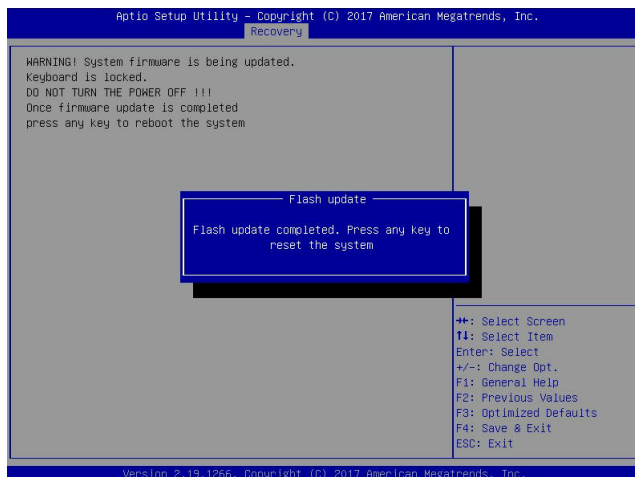

Option #1 as shown below. Then, set Boot Option #1 to [UEFI AP:UEFI: Built-in EFI Shell]. Press <F4> to save the settings and exit the BIOS Setup utility.

8. When the UEFI Shell prompt appears, type fs# to change the device directory path. Go to the directory that contains the BIOS package you extracted earlier from Step 6. Enter flash.nsh BIOSname.### at the prompt to start the BIOS update process.

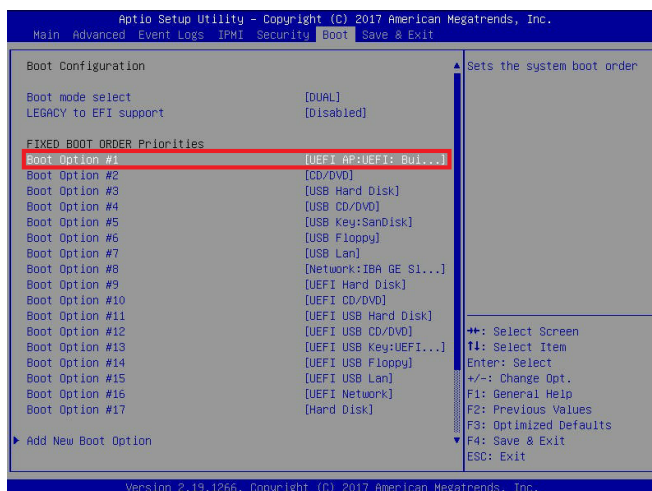

Note: *Do not interrupt this process* until the BIOS flashing is complete.

```

UEFI Interactive Shell v2.1
EDK II
UEFI v2.50 (American Megatrends, 0x0005000C)
Mapping table
  FS0: Alias(s):HD0:0B:BLK1:
        PciRoot(0x0)/Pci(0x14,0x0)/USB(0x11,0x0)/HD(1,MBR,0x37901D72,0x800,0x1
DR9592)
  BLK0: Alias(s):
        PciRoot(0x0)/Pci(0x14,0x0)/USB(0x11,0x0)
Press F8 in 1 seconds to skip startup.nsh or any other key to continue.
Shell> fs0:
FS0:\> cd \AFUDOS
FS0:\AFUDOS> cd SNIJPM2_03162017
FS0:\AFUDOS\SNIJPM2_03162017> flash.nsh X110PU7_314

```

9. The screen above indicates that the BIOS update process is complete. When you see the screen above, unplug the AC power cable from the power supply, clear CMOS, and plug

```

Done.
[ Access Cmos Port Ex ]
<Read>
Index 0x51: 0x10

Done.
*****
*
* Program BIOS and ME (including F0T) regions...
*
*****
| AMT Firmware Update Utility v5.09.01.1917 |
| Copyright (C)2017 American Megatrends Inc. All Rights Reserved. |
*****
CPUID = 50652

Reading flash ..... done
- ME Data Size checking - ok
- FFS checksums ..... ok
- Check RomLayout ..... Ok
Erasing Boot Block ..... done
Updating Boot Block ..... done
Verifying Boot Block ..... done
_Erasing Main Block ..... 0x00132000 (0x)

```

the AC power cable in the power supply again to power on the system.

10. Press continuously to enter the BIOS Setup utility.

```

Verifying NDB Block ..... done
- Update success for FDR
- Update success for IE
- Successful Update Recovery Loader to OPRx11
- Successful Update MFSB11
- Successful Update FPR11
- Successful Update MFS, IVBI and IVB211
- Successful Update FLOG and UTDK11
- ME Entire Image update success !!
WARNING : System must power-off to have the changes take effect!
Moving F80:\AFUDOS\SNIJPM2_03162017\Fdtv64.efi -> F80:\AFUDOS\SNIJPM2_03162017\F
dt1.smc
- [ok]
Moving F80:\AFUDOS\SNIJPM2_03162017\Fuef1x64.efi -> F80:\AFUDOS\SNIJPM2_0316201
7\Fuef1.smc
- [ok]
*****
* Please ignore this 'Shell: Cannot read from file - Device Error'
* warning message due to it does not impact flashing process.
*
*****
Deleting "F:\uef1.smc"
Delete successful.
FS0:\>

```

11. Press <F3> to load the default settings.
12. After loading the default settings, press <F4> to save the settings and exit the BIOS Setup utility.

6.6 CMOS Clear

JBT1 is used to clear CMOS, which will also clear any passwords. Instead of pins, this jumper consists of contact pads to prevent accidentally clearing the contents of CMOS.

To Clear CMOS

1. First [power down](#) the system completely.
2. Remove the blade from the enclosure to access the motherboard.
3. Remove the onboard battery from the motherboard.
4. Short the CMOS pads with a metal object such as a small screwdriver for at least four seconds.
5. Remove the screwdriver or shorting device.
6. Replace the cover, reconnect the power cords and power on the system.



Notes: Clearing CMOS will also clear all passwords.

Do not use the PW_ON connector to clear CMOS.

6.7 BMC Reset

The BMC can be reset using the UID button.

- Reset – Press and hold the button. After six seconds, the LED blinks at 2Hz. The BMC resets and the reset duration is approximately 250 ms. Then the BMC starts to boot.
- Restore factory default configuration – Hold the button for twelve seconds. The LED blinks at 4Hz while defaults are configured. **Note:** All BMC settings including username and password will be removed except the FRU and network settings.

Firmware update – When the BMC firmware is being updated, the UID LED blinks at 10Hz.

BMC Reset Options		
Event	UID LED	BMC Heartbeat LED
Reset	Blue, Blinks at 2Hz	Green, solid
Restore Defaults	Blue, Blinks at 4Hz	Off
Update	Blue, Blinks at 10Hz	

6.8 Where to Get Replacement Components

If you need replacement parts for your system, to ensure the highest level of professional service and technical support, purchase exclusively from our Supermicro Authorized Distributors/System Integrators/Resellers. A list can be found at: <http://www.supermicro.com>. Click the "Where to Buy" tab.

6.9 Reporting an Issue

Technical Support Procedures

Before contacting Technical Support, please take the following steps. If your system was purchased through a distributor or reseller, please contact them for troubleshooting services. They have the best knowledge of your specific system configuration.

1. Please review the [Troubleshooting Procedures](#) in this manual and [Frequently Asked Questions](#) on our website before contacting Technical Support.
2. BIOS upgrades can be downloaded from our website. **Note:** Not all BIOS can be flashed depending on the modifications to the boot block code.
3. If you still cannot resolve the problem, include the following information when contacting us for technical support:
 - System, motherboard, and chassis model numbers and PCB revision number
 - BIOS release date/version (this can be seen on the initial display when your system first boots up)
 - System configuration

An example of a Technical Support form is posted on our [website](#). Distributors: For immediate assistance, please have your account number ready when contacting our technical support department by email.

Returning Merchandise for Service

A receipt or copy of your invoice marked with the date of purchase is required before any warranty service will be rendered. You can obtain service by calling your vendor for a Returned Merchandise Authorization (RMA) number. When returning to the manufacturer, the RMA number should be prominently displayed on the outside of the shipping carton, and mailed prepaid or hand-carried. Shipping and handling charges will be applied for all orders that must be mailed when service is complete.

For faster service, RMA authorizations may be requested online (<http://www.supermicro.com/support/rma/>).

Whenever possible, repack the chassis in the original Supermicro carton, using the original packaging material. If these are no longer available, be sure to pack the chassis securely, using packaging material to surround the chassis so that it does not shift within the carton and become damaged during shipping.

This warranty only covers normal consumer use and does not cover damages incurred in shipping or from failure due to the alteration, misuse, abuse or improper maintenance of products.

During the warranty period, contact your distributor first for any product problems.

Vendor Support Filing System

For issues related to Intel, use the Intel IPS filing system:

<https://www.intel.com/content/www/us/en/design/support/ips/training/welcome.html>

For issues related to Red Hat Enterprise Linux, since it is a subscription based OS, contact your account representative.

6.10 Feedback

Supermicro values your feedback as we strive to improve our customer experience in all facets of our business. To provide feedback on our manuals, please email us at techwriterteam@supermicro.com.

6.11 Contacting Supermicro

Headquarters

Address: Super Micro Computer, Inc.
980 Rock Ave.
San Jose, CA 95131 U.S.A.

Tel: +1 (408) 503-8000

Fax: +1 (408) 503-8008

Email: marketing@supermicro.com (General Information)
Sales-USA@supermicro.com (Sales Inquiries)
Government_Sales-USA@supermicro.com (Gov. Sales Inquiries)
support@supermicro.com (Technical Support)
RMA@supermicro.com (RMA Support)
Webmaster@supermicro.com (Webmaster)

Website: www.supermicro.com

Europe

Address: Super Micro Computer B.V.
Het Sterrenbeeld 28, 5215 ML
's-Hertogenbosch, The Netherlands

Tel: +31 (0) 73-6400390

Fax: +31 (0) 73-6416525

Email: Sales_Europe@supermicro.com (Sales Inquiries)
Support_Europe@supermicro.com (Technical Support)
RMA_Europe@supermicro.com (RMA Support)

Website: www.supermicro.nl

Asia-Pacific

Address: Super Micro Computer, Inc.
3F, No. 150, Jian 1st Rd.
Zhonghe Dist., New Taipei City 235
Taiwan (R.O.C)

Tel: +886-(2) 8226-3990

Fax: +886-(2) 8226-3992

Email: Sales-Asia@supermicro.com.tw (Sales Inquiries)
Support@supermicro.com.tw (Technical Support)
RMA@supermicro.com.tw (RMA Support)

Website: www.supermicro.com.tw

Chapter 5

Optional Components

This chapter describes optional system components and installation procedures.

5.1 TPM Security Module

SPI capable TPM 2.0 (or 1.2) with Infineon 9670 controller, Horizontal form factor

The JTPM1 header is used to connect a Trusted Platform Module (TPM). A TPM is a security device that supports encryption and authentication in storage drives. It enables the motherboard to deny access if the TPM associated with the storage drive is not installed in the system.

Details and installation procedures are at:

<http://www.supermicro.com/manuals/other/TPM.pdf>.

5.2 Intel Virtual RAID on CPU (VROC)

Intel® Virtual RAID on CPU (Intel VROC) is an enterprise RAID solution for NVMe SSDs directly attached to Intel Xeon Scalable processors. Intel Volume Management Device (VMD) is an integrated controller inside the CPU PCIe root complex.

- A single processor supports up to 12 NVMe SSDs and up to 6 RAID arrays.
- A dual processor system supports up to 24 NVMe SSDs and 12 RAID arrays.

Stripe sizes are 4K, 8K, 16K, 32K, 64K, 128K.

Requirements and Restrictions

- **Intel VROC is only available when the system is configured for UEFI boot mode.**
- To enable the **mdadm** command and support for RSTe, install the patch from
 - Linux: <https://downloadcenter.intel.com/download/28158/Intel-Virtual-RAID-on-CPU-Intel-VROC-and-Intel-Rapid-Storage-Technology-enterprise-Intel-RSTe-Driver-for-Linux->
 - Windows: <https://downloadcenter.intel.com/download/28108/Intel-Virtual-RAID-on-CPU-Intel-VROC-and-Intel-Rapid-Storage-Technology-enterprise-Intel-RSTe-Driver-for-Windows->
- To enable Intel VROC, a hardware key must be inserted on the motherboard, and the appropriate processor's Virtual Management Devices must be enabled in the BIOS setup.
- It is possible to enable Intel VROC without a hardware key installed, but only RAID0 will be enabled.
- Intel VROC is not compatible with secure boot. This feature must be disabled.
- When creating bootable OS RAID1 devices, you must have both devices on the same CPU, and a VMD on that CPU.
- Spanning drives when creating RAID devices is not recommended due to performance issues, even though it is supported.

Supported SSDs and Operating Systems

To see the latest support information: <https://www.intel.com/content/www/us/en/support/articles/000030310/memory-and-storage/ssd-software.html>

Additional Information

Additional information is available on the product page for the Supermicro add-on card and the linked manuals.

www.supermicro.com/products/accessories/addon/AOC-VROCxxxMOD.cfm

Hardware Key

The Intel VROC hardware key is a license key that detects the Intel VROC SKU and activates the function accordingly. The key must be plugged into the Supermicro motherboard (connector JRK1). The key options are:

Intel® VROC Keys			
VROC Package	Description	Part Number	Intel MM Number
Standard	RAID 0, 1, 10 Supports 3rd party SSDs	AOC-VROCSTNMOD	951605
Premium	RAID 0, 1, 5, 10 Supports 3rd party SSDs	AOC-VROCPREMOD	951606

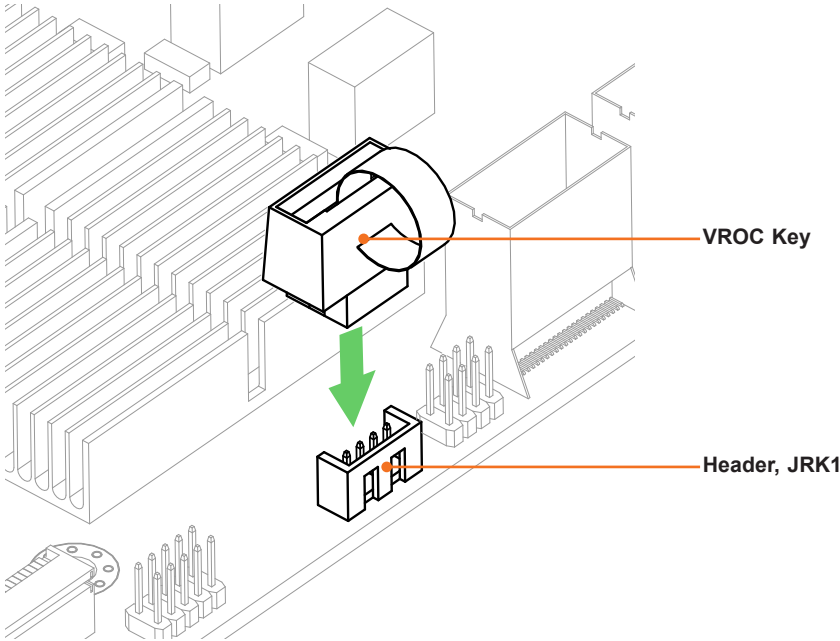

Figure 5-1. Intel VROC RAID Key and Motherboard Connector JRK1

Configuring Intel VMD

VMD must be enabled on PCIe ports which have NVMe drives attached to them in order for those drives to be added to a VROC RAID configuration. The default BIOS setting for the NVMe Mode Switch is **Auto** which automatically enables VMD on all installed NVMe drives.

NVMe Mode Switch :

- **Auto** Enables VMD for all NVMe ports if VROC Key is installed.
- **VMD** Enables VMD for all NVMe ports despite the lack of the VROC Key.
- **Manual** Allows the user to select specific NVMe ports on which to enable VMD.

The NVMe Mode Switch can be viewed or selected at **BIOS > Advanced > Chipset Configuration > North Bridge > IIO Configuration > Intel® VMD Technology**.

Note: Without a VROC Key, there is no RAID support with the **Auto** switch. Only RAID 0 is supported with the **VMD** and **Manual** switches.

Configuring VMD Manually

The steps for manually configuring VMD on specific NVMe ports in UEFI BIOS are shown below. This example shows different but similar system with 12 NVMe. Yours will look different.

1. Reboot the server and press [DEL] key to access the BIOS options.
2. Switch to **Advanced > Chipset Configuration > North Bridge > IIO Configuration > Intel® VMD Technology**.
3. Select **VMD Mode Switch**, then select **Manual**.

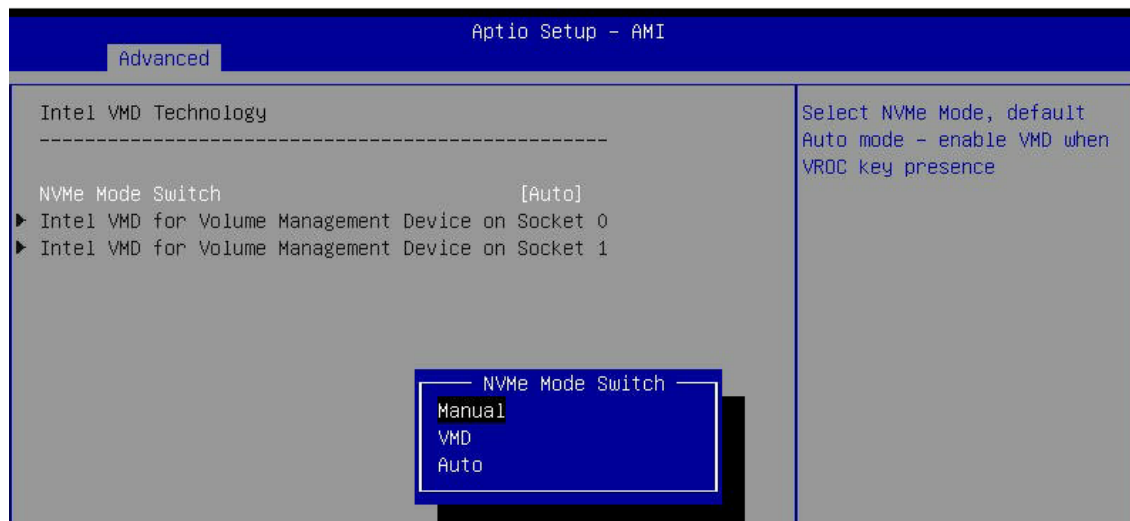

Note that Socket 0 contains CPU1; Socket 1 contains CPU2

Figure 5-2. BIOS, Selecting VMD Mode

Caution: VMD must only be enabled on NVMe port resources. If VMD is enabled on other PCIe ports, the functionality of those ports will be impacted. See the table below.

4. Select “Intel VMD for Volume Management Device on” on Socket 0 (CPU1) or Socket 2 (CPU2) to enable VMD for devices under the respective CPU.

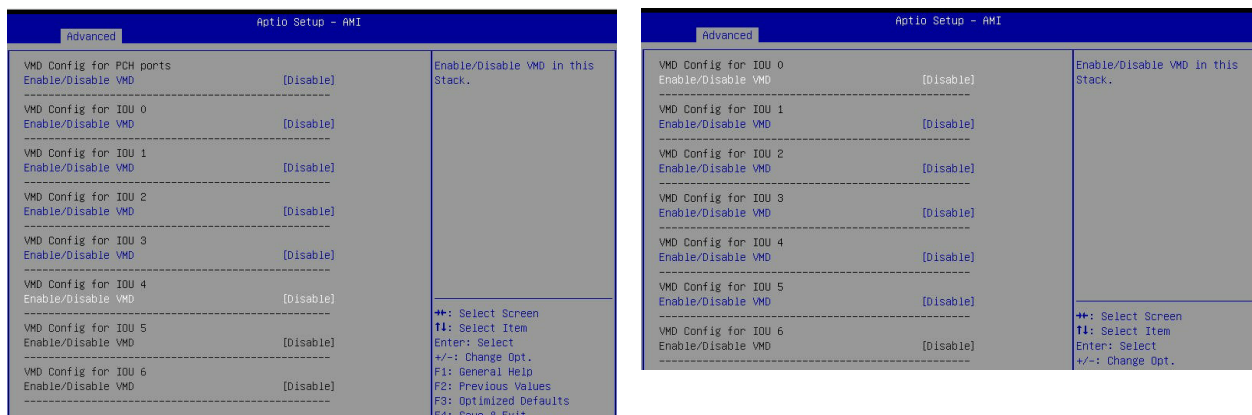

Figure 5-3. Intel VMD for Volume Management Device on Socket 0 and Socket 1

5. Choose Enable for “Enable/Disable VMD” for IOU 3 to list the available devices under IOU 3.

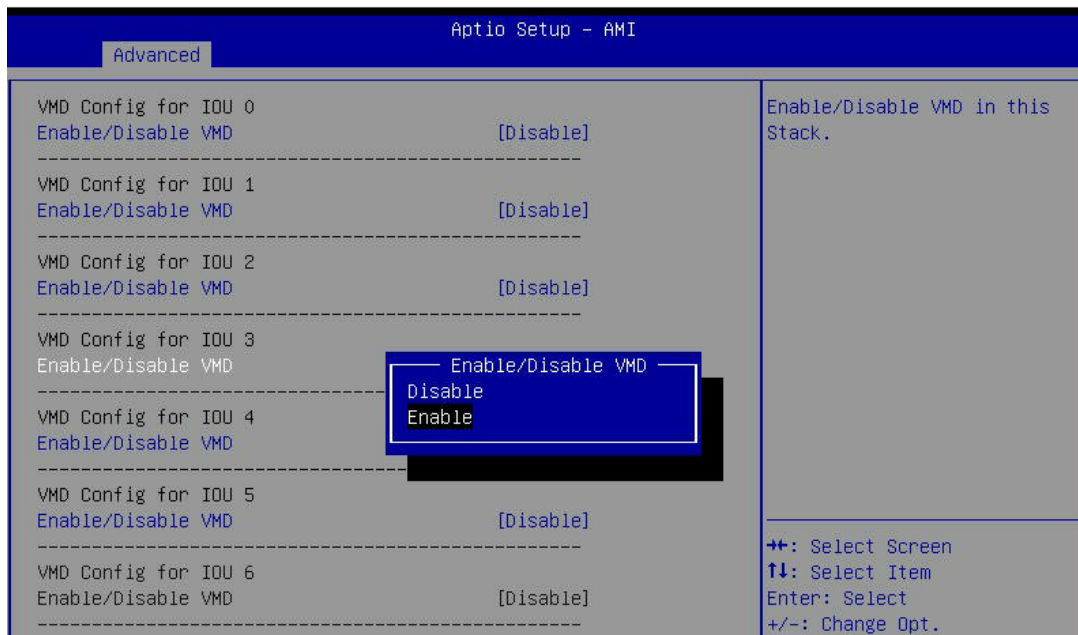

Figure 5-4. BIOS, Enabling VMD on Socket 1 (CPU2) (Example)

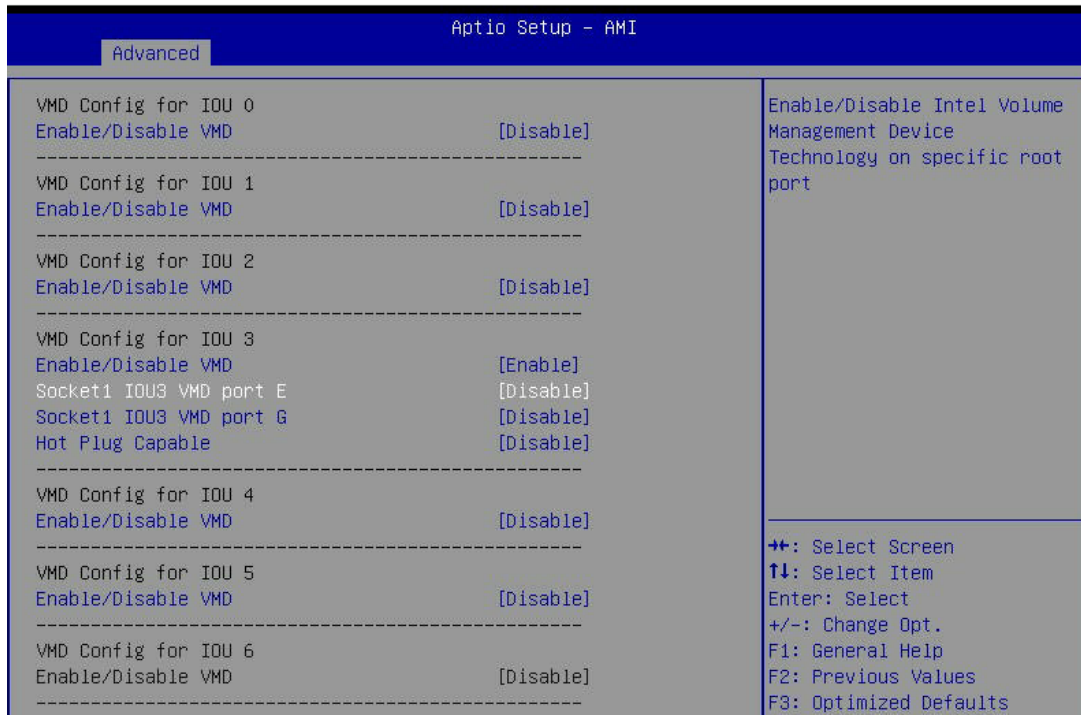

Figure 5-5. BIOS, Enabling VMD on Socket 1 (Example)

6. Enable the NVMe port resource according to table above for the NVMe drives that will be used in a RAID configuration.

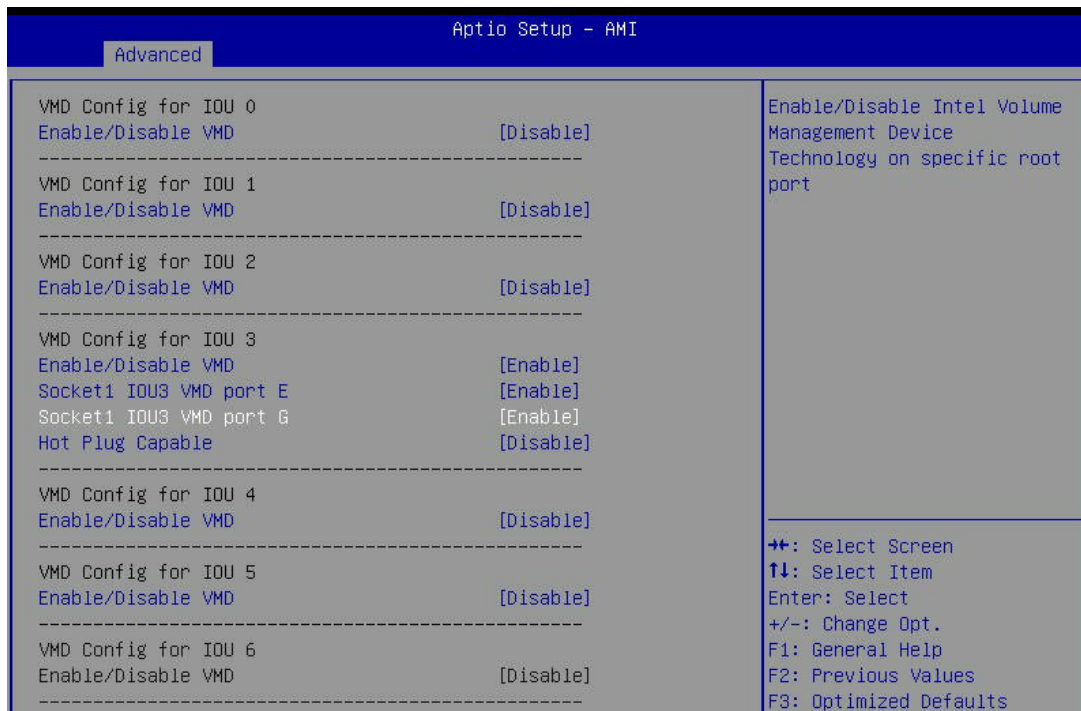

Figure 5-6. BIOS, Enabling Socket 1 (Example)

7. Choose whether to make the NVMe drives in this IOU **Hot Plug Capable** by selecting Enabled or Disabled.
8. Repeat steps 4 through 7 for each IOU # on each CPU to enable VMD on the desired NVMe ports.

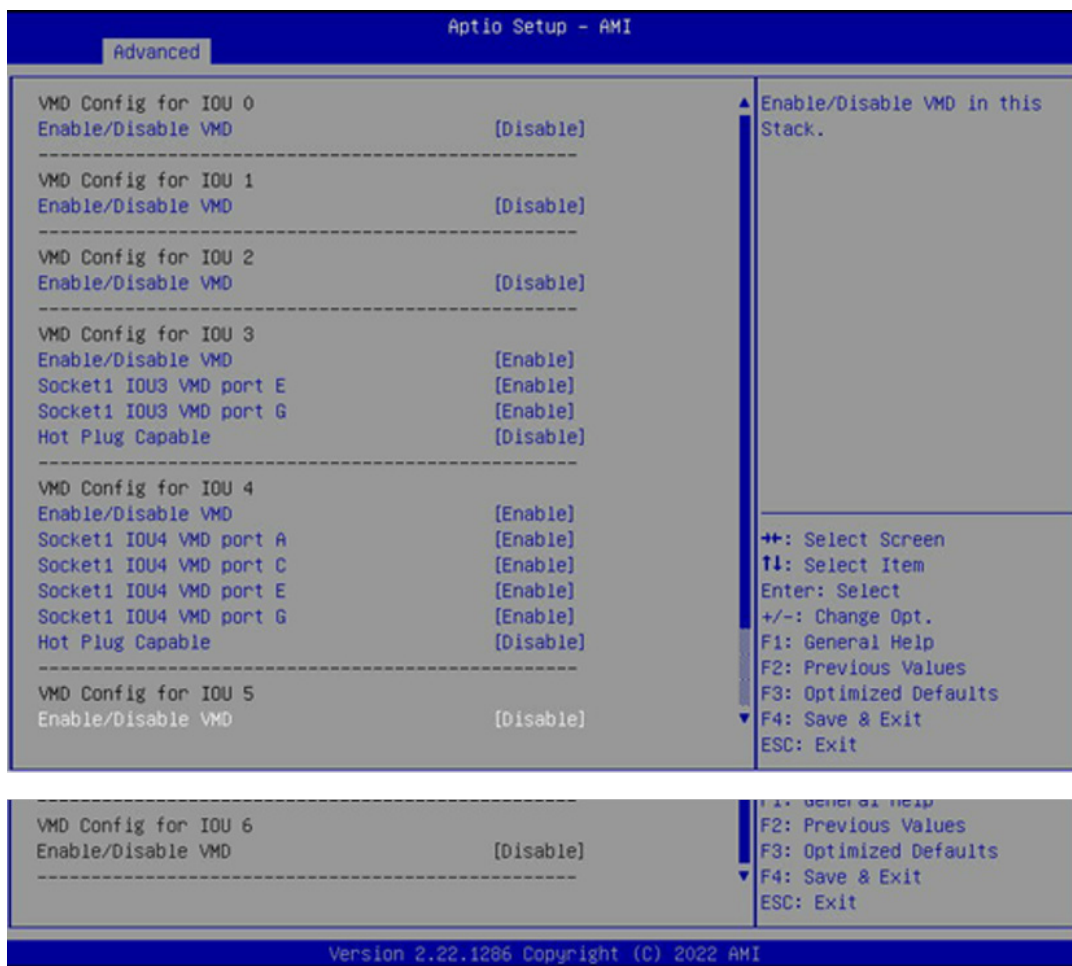

Figure 5-7. BIOS, Enabling Socket 1 Completed (Example)

9. Press [F4] to save the configuration and reboot the system.

Note: If there is an existing RAID configuration, delete the RAID volume associated with the VMD controller before disabling the controller. Failure to do so may lead to unexpected behavior.

Note: The effects of physically changing or swapping a CPU on the VMD controller have not been thoroughly tested or documented.

Creating NVMe RAID Configurations

1. Open **Advanced > Intel(R) Virtual RAID on CPU > All Intel VMD Controllers > Create RAID Volume**.

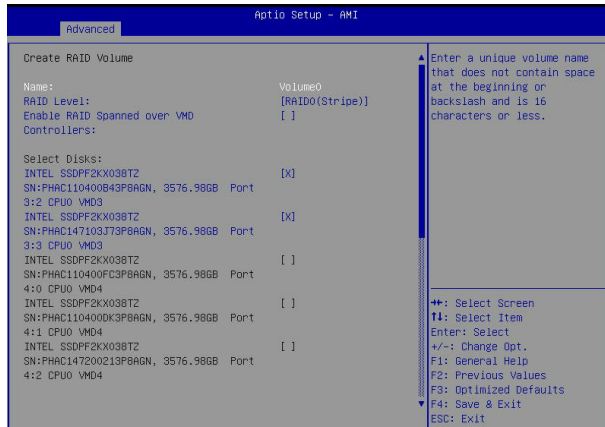

Figure 5-8. Created Volume *without* enabling RAID spanned over VMD controller

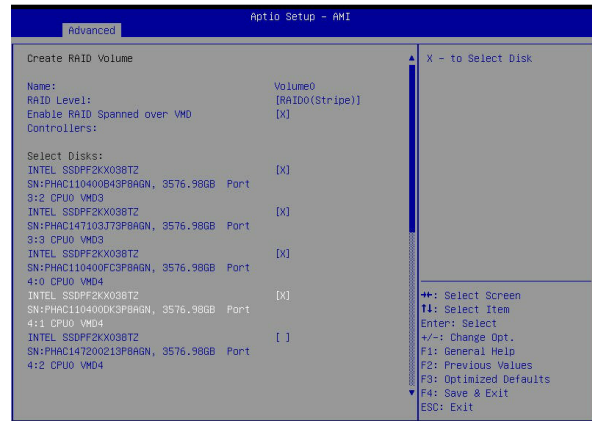

Figure 5-9. Created Volume *with* enabling RAID spanned over VMD controller

2. Set **Name**.
3. Set **RAID Level**.
4. If cross-controller RAID is required, select **Enable RAID spanned over VMD Controller**.
5. Select specific drives for RAID with an [X].
 - RAID0: Select at least two [2 - 24] drives
 - RAID1: Select only two drives
 - RAID5: Select at least three [3 - 24] drives
 - RAID10: Select only four drives
6. Select **Strip Size** (Default 64KB).
7. Select **Create Volume**.
8. If another RAID is needed, start again at step 1.

Status Indications

An LED indicator on the drive carrier shows the RAID status of the drive.

Drive Carrier Status LED Indicator	
Status	State (Red)
Normal function	Off
Locating	4 Hz blinking
Fault	Solid ON
Rebuilding	1 Hz blinking

IBPI SFF 8489 Defined Status LED States

Hot-Swap Drives

Intel VMD enables hot-plug and hot-unplug for NVMe SSDs, whether from Intel or other manufacturers. Under vSphere ESXi, several steps are necessary to avoid potential stability issues. See the information at the link [1] below.

Hot-unplug

1. Prevent devices from being re-detected during rescan:

```
esxcli storage core claiming autoclaim --enabled=false
```

2. Unmount the VMFS volumes on the device. Check [2] for details.
3. Detach the device. Check [3] for details.
4. Physically remove the device.

Hot-plug

- Physically install the device.

ESXi will automatically discover NVMe SSDs, but a manual scan may be required in some cases.

Related Information Links

[1] <https://kb.vmware.com/s/article/2151404>

[2] <https://docs.vmware.com/en/VMware-vSphere/6.5/com.vmware.vsphere.storage.doc/GUID-1B56EF97-F60E-4F21-82A7-8F2A7294604D.html>

[3] <https://docs.vmware.com/en/VMware-vSphere/6.5/com.vmware.vsphere.storage.doc/GUID-F2E75F67-740B-4406-9F0C-A2D99A698F2A.html>

Appendix A

BIOS POST Codes

A.1 BIOS POST Messages

During the Power-On Self-Test (POST), the BIOS will check for problems. If a problem is found, the BIOS will activate an alarm or display a message. The following is a list of such BIOS messages.

BIOS POST Messages	
BIOS Message	Description
Failure Fixed Disk	Fixed disk is not working or not configured properly. Check to see if fixed disk is attached properly. Run Setup. Find out if the fixed-disk type is correctly identified.
Stuck key	Stuck key on keyboard.
Keyboard error	Keyboard not working.
Keyboard Controller Failed	Keyboard controller failed test. May require replacing keyboard controller.
Keyboard locked - Unlock key switch	Unlock the system to proceed.
Monitor type does not match CMOS - Run SETUP	Monitor type not correctly identified in Setup
Shadow Ram Failed at offset: nnnn	Shadow RAM failed at offset nnnn of the 64k block at which the error was detected.
System RAM Failed at offset: nnnn	System RAM failed at offset nnnn of in the 64k block at which the error was detected.
Extended RAM Failed at offset: nnnn	Extended memory not working or not configured properly at offset nnnn.
System battery is dead - Replace and run SETUP	The CMOS clock battery indicator shows the battery is dead. Replace the battery and run Setup to reconfigure the system.
System CMOS checksum bad - Default configuration used	System CMOS has been corrupted or modified incorrectly, perhaps by an application program that changes data stored in CMOS. The BIOS installed Default Setup Values. If you do not want these values, enter Setup and enter your own values. If the error persists, check the system battery or contact your dealer.
System timer error	The timer test failed. Requires repair of system board.
Real time clock error	Real-Time Clock fails BIOS hardware test. May require board repair.
Check date and time settings	BIOS found date or time out of range and reset the Real-Time Clock. May require setting legal date (1991-2099).

BIOS POST Messages	
BIOS Message	Description
Previous boot incomplete - Default configuration used	Previous POST did not complete successfully. POST loads default values and offers to run Setup. If the failure was caused by incorrect values and they are not corrected, the next boot will likely fail. On systems with control of wait states, improper Setup settings can also terminate POST and cause this error on the next boot. Run Setup and verify that the waitstate configuration is correct. This error is cleared the next time the system is booted.
Memory Size found by POST differed from CMOS	Memory size found by POST differed from CMOS.
Diskette drive A error	
Diskette drive B error	Drive A: or B: is present but fails the BIOS POST diskette tests. Check to see that the drive is defined with the proper diskette type in Setup and that the diskette drive is attached correctly.
Incorrect Drive A type - run SETUP	Type of floppy drive A: not correctly identified in Setup.
Incorrect Drive B type - run SETUP	Type of floppy drive B: not correctly identified in Setup.
System cache error - Cache disabled	RAM cache failed and BIOS disabled the cache. On older boards, check the cache jumpers. You may have to replace the cache. See your dealer. A disabled cache slows system performance considerably.
CPU ID:	CPU socket number for Multi-Processor error.
EISA CMOS not writeable	ServerBIOS2 test error: Cannot write to EISA CMOS.
DMA Test Failed	ServerBIOS2 test error: Cannot write to extended DMA (Direct Memory Access) registers.
Software NMI Failed	ServerBIOS2 test error: Cannot generate software NMI (Non-Maskable Interrupt).
Fail-Safe Timer NMI Failed	ServerBIOS2 test error: Fail-Safe Timer takes too long.
device Address Conflict	Address conflict for specified device.
Allocation Error for: device	Run ISA or EISA Configuration Utility to resolve resource conflict for the specified device.
CD ROM Drive	CD ROM Drive identified.
Entering SETUP...	Starting Setup program
Failing Bits: nnnn	The hex number nnnn is a map of the bits at the RAM address which failed the memory test. Each 1 (one) in the map indicates a failed bit. See errors 230, 231, or 232 above for offset address of the failure in System, Extended, or Shadow memory.
Fixed Disk n	Fixed disk n (0-3) identified.
Invalid System Configuration Data	Problem with NVRAM (CMOS) data.
I/O device IRQ conflict	I/O device IRQ conflict error.
PS/2 Mouse Boot Summary Screen:	PS/2 Mouse installed.

BIOS POST Messages	
BIOS Message	Description
nnnn kB Extended RAM Passed	Where nnnn is the amount of RAM in kilobytes successfully tested.
nnnn Cache SRAM Passed	Where nnnn is the amount of system cache in kilobytes successfully tested.
nnnn kB Shadow RAM Passed	Where nnnn is the amount of shadow RAM in kilobytes successfully tested.
nnnn kB System RAM Passed	Where nnnn is the amount of system RAM in kilobytes successfully tested.
One or more I2O Block Storage Devices were excluded from the Setup Boot Menu	There was not enough room in the IPL table to display all installed I2O block-storage devices.
Operating system not found	Operating system cannot be located on either drive A: or drive C:. Enter Setup and see if fixed disk and drive A: are properly identified.
Parity Check 1 nnnn	Parity error found in the system bus. BIOS attempts to locate the address and display it on the screen. If it cannot locate the address, it displays ?????. Parity is a method for checking errors in binary data. A parity error indicates that some data has been corrupted.
Parity Check 2 nnnn	Parity error found in the I/O bus. BIOS attempts to locate the address and display it on the screen. If it cannot locate the address, it displays ?????.
Press <F1> to resume, <F2> to Setup, <F3> for previous	Displayed after any recoverable error message. Press <F1> to start the boot process or <F2> to enter Setup and change the settings. Press <F3> to display the previous screen (usually an initialization error of an Option ROM, i.e., an add-on card). Write down and follow the information shown on the screen.
Press <F2> to enter Setup	Optional message displayed during POST. Can be turned off in Setup.
PS/2 Mouse:	PS/2 mouse identified.
Run the I2O Configuration Utility	One or more unclaimed block storage devices have the Configuration Request bit set in the LCT. Run an I2O Configuration Utility (e.g. the SAC utility).
System BIOS shadowed	System BIOS copied to shadow RAM.
UMB upper limit segment address: nnnn	Displays the address nnnn of the upper limit of Upper Memory Blocks, indicating released segments of the BIOS which can be reclaimed by a virtual memory manager.
Video BIOS shadowed	Video BIOS successfully copied to shadow RAM.

A.2 BIOS POST Codes

This section lists the POST (Power-On Self-Test) codes for the AMI BIOS. POST codes are divided into two categories: recoverable and terminal.

Recoverable POST Errors

When a recoverable type of error occurs during POST, the BIOS will display an POST code that describes the problem. BIOS may also issue one of the following beep codes:

One long and two short beeps – video configuration error

One repetitive long beep – no memory detected

Terminal POST Errors

If a terminal type of error occurs, BIOS will shut down the system. Before doing so, BIOS will write the error to port 80h, attempt to initialize video and write the error in the top left corner of the screen.

The following is a list of codes that may be written to port 80h.

Terminal POST Errors	
Code	Description
02h	Verify Real Mode
03h	Disable Non-Maskable Interrupt (NMI)
04h	Get CPU type
06h	Initialize system hardware
07h	Disable shadow and execute code from the ROM.
08h	Initialize chipset with initial POST values
09h	Set IN POST flag
0Ah	Initialize CPU registers
0Bh	Enable CPU cache
0Ch	Initialize caches to initial POST values
0Eh	Initialize I/O component
0Fh	Initialize the local bus IDE
10h	Initialize Power Management
11h	Load alternate registers with initial POST values
12h	Restore CPU control word during warm boot
13h	Initialize PCI Bus Mastering devices
14h	Initialize keyboard controller
16h	1-2-2-3 BIOS ROM checksum
17h	Initialize cache before memory Auto size
18h	8254 timer initialization
1Ah	8237 DMA controller initialization
1Ch	Reset Programmable Interrupt Controller

Terminal POST Errors	
Code	Description
20h	1-3-1-1 Test DRAM refresh
22h	1-3-1-3 Test 8742 Keyboard Controller
28h	Auto size DRAM
29h	Initialize POST Memory Manager
2Ah	Clear 512 kB base RAM
2Ch	1-3-4-1 RAM failure on address line xxxx*
2Eh	1-3-4-3 RAM failure on data bits xxxx* of low byte of memory bus
2Fh	Enable cache before system BIOS shadow
32h	Test CPU bus-clock frequency
33h	Initialize Phoenix Dispatch Manager
36h	Warm start shut down
38h	Shadow system BIOS ROM
3Ah	Auto size cache
3Ch	Advanced configuration of chipset registers
3Dh	Load alternate registers with CMOS values
41h	Initialize extended memory for RomPilot
42h	Initialize interrupt vectors
45h	POST device initialization
46h	2-1-2-3 Check ROM copyright notice
47h	Initialize I20 support
48h	Check video configuration against CMOS
49h	Initialize PCI bus and devices
4Ah	Initialize all video adapters in system
4Bh	QuietBoot start (optional)
4Ch	Shadow video BIOS ROM
4Eh	Display BIOS copyright notice
4Fh	Initialize MultiBoot
50h	Display CPU type and speed
51h	Initialize EISA board

Terminal POST Errors	
Code	Description
52h	Test keyboard
54h	Set key click if enabled
55h	Enable USB devices
58h	2-2-3-1 Test for unexpected interrupts
59h	Initialize POST display service
5Ah	Display prompt "Press F2 to enter SETUP"
5Bh	Disable CPU cache
5Ch	Test RAM between 512 and 640 kB
60h	Test extended memory
62h	Test extended memory address lines
64h	Jump to UserPatch1
66h	Configure advanced cache registers
67h	Initialize Multi Processor APIC
68h	Enable external and CPU caches
69h	Setup System Management Mode (SMM) area
6Ah	Display external L2 cache size
6Bh	Load custom defaults (optional)
6Ch	Display shadow-area message
6Eh	Display possible high address for UMB recovery
70h	Display error messages
72h	Check for configuration errors
76h	Check for keyboard errors
7Ch	Set up hardware interrupt vectors
7Dh	Initialize Intelligent System Monitoring
7Eh	Initialize coprocessor if present
80h	Disable onboard Super I/O ports and IRQs
81h	Late POST device initialization
82h	Detect and install external RS232 ports
83h	Configure non-MCD IDE controllers

Terminal POST Errors	
Code	Description
84h	Detect and install external parallel ports
85h	Initialize PC-compatible PnP ISA devices
86h	Re-initialize onboard I/O ports.
87h	Configure Motherboard Configurable Devices (optional)
88h	Initialize BIOS Data Area
89h	Enable Non-Maskable Interrupts (NMIs)
8Ah	Initialize Extended BIOS Data Area
8Bh	Test and initialize PS/2 mouse
8Ch	Initialize floppy controller
8Fh	Determine number of ATA drives (optional)
90h	Initialize hard-disk controllers
91h	Initialize local-bus hard-disk controllers
92h	Jump to UserPatch2
93h	Build MPTABLE for multi-processor boards
95h	Install CD ROM for boot
96h	Clear huge ES segment register
98h	1-2 Search for option ROMs. One long, two short beeps on check-sum failure
99h	Check for SMART Drive (optional)
9Ah	Shadow option ROMs
9Ch	Set up Power Management
9Dh	Initialize security engine (optional)
9Eh	Enable hardware interrupts
9Fh	Determine number of ATA and SCSI drives
A0h	Set time of day
A2h	Check key lock
A4h	Initialize typematic rate
A8h	Erase F2 prompt
AAh	Scan for F2 key stroke
ACh	Enter SETUP

Terminal POST Errors	
Code	Description
AEh	Clear Boot flag
B0h	Check for errors
B1h	Inform RomPilot about the end of POST.
B2h	POST done - prepare to boot operating system
B4h	1 One short beep before boot
B5h	Terminate QuietBoot (optional)
B6h	Check password (optional)
B7h	Initialize ACPI BIOS
B9h	Prepare Boot
BAh	Initialize SMBIOS
BBh	Initialize PnP Option ROMs
BCh	Clear parity checkers
BDh	Display MultiBoot menu
BEh	Clear screen (optional)
BFh	Check virus and backup reminders
C0h	Try to boot with INT 19
C1h	Initialize POST Error Manager (PEM)
C2h	Initialize error logging
C3h	Initialize error display function
C4h	Initialize system error handler
C5h	PnPnd dual CMOS (optional)
C6h	Initialize note dock (optional)
C7h	Initialize note dock late
C8h	Force check (optional)
C9h	Extended checksum (optional)
CAh	Redirect Int 15h to enable remote keyboard
CBh	Redirect Int 13h to Memory Technologies Devices such as ROM, RAM, PCMCIA, and serial disk
CCh	Redirect Int 10h to enable remote serial video
CDh	Re-map I/O and memory for PCMCIA

Terminal POST Errors	
Code	Description
CEh	Initialize digitizer and display message
D2h	Unknown interrupt

The following are for the boot block in Flash ROM:

Boot Block Flash ROM Terminal POST Errors	
Code	Description
E0h	Initialize the chipset
E1h	Initialize the bridge
E2h	Initialize the CPU
E3h	Initialize system timer
E4h	Initialize system I/O
E5h	Check force recovery boot
E6h	Checksum BIOS ROM
E7h	Go to BIOS
E8h	Set Huge Segment
E9h	Initialize Multi Processor
EAh	Initialize OEM special code
EBh	Initialize PIC and DMA
ECh	Initialize Memory type
EDh	Initialize Memory size
EEh	Shadow Boot Block
EFh	System memory test

Boot Block Flash ROM Terminal POST Errors	
Code	Description
F0h	Initialize interrupt vectors
F1h	Initialize Run Time Clock
F2h	Initialize video
F3h	Initialize System Management Manager
F4h	Output one beep
F5h	Clear Huge Segment
F6h	Boot to Mini DOS
F7h	Boot to Full DOS

If the BIOS detects error 2C, 2E, or 30 (base 512K RAM error), it displays an additional word-bitmap (xxxx) indicating the address line or bits that failed. For example, "2C 0002" means address line 1 (bit one set) has failed. "2E 1020" means data bits 12 and 5 (bits 12 and 5 set) have failed in the lower 16 bits. The BIOS also sends the bitmap to the port-80 LED display. It first displays the checkpoint code, followed by a delay, the high-order byte, another delay, and then the low order byte of the error. It repeats this sequence continuously.

Appendix B

Standardized Warning Statements for AC Systems

About Standardized Warning Statements

The following statements are industry standard warnings, provided to warn the user of situations which have the potential for bodily injury. Should you have questions or experience difficulty, contact Supermicro's Technical Support department for assistance. Only certified technicians should attempt to install or configure components.

Read this appendix in its entirety before installing or configuring components in the Supermicro chassis.

These warnings may also be found on our website at http://www.supermicro.com/about/policies/safety_information.cfm.

Warning Definition



Warning! This warning symbol means danger. You are in a situation that could cause bodily injury. Before you work on any equipment, be aware of the hazards involved with electrical circuitry and be familiar with standard practices for preventing accidents.

警告の定義

この警告サインは危険を意味します。

人身事故につながる可能性がありますので、いずれの機器でも動作させる前に、電気回路に含まれる危険性に注意して、標準的な事故防止策に精通して下さい。

此警告符号代表危險。

您正处于可能受到严重伤害的工作环境中。在您使用设备开始工作之前，必须充分意识到触电的危险，并熟练掌握防止事故发生的标准工作程序。请根据每项警告结尾的声明号码找到此设备的安全性警告说明的翻译文本。

此警告符號代表危險。

您正處於可能身體可能會受損傷的工作環境中。在您使用任何設備之前，請注意觸電的危險，並且要熟悉預防事故發生的標準工作程序。請依照每一注意事項後的號碼找到相關的翻譯說明內容。

Warnung

WICHTIGE SICHERHEITSHINWEISE

Dieses Warnsymbol bedeutet Gefahr. Sie befinden sich in einer Situation, die zu Verletzungen führen kann. Machen Sie sich vor der Arbeit mit Geräten mit den Gefahren elektrischer Schaltungen und den üblichen Verfahren zur Vorbeugung vor Unfällen vertraut. Suchen Sie mit der am Ende jeder Warnung angegebenen Anweisungsnummer nach der jeweiligen Übersetzung in den übersetzten Sicherheitshinweisen, die zusammen mit diesem Gerät ausgeliefert wurden.

BEWAHREN SIE DIESE HINWEISE GUT AUF.

INSTRUCCIONES IMPORTANTES DE SEGURIDAD

Este símbolo de aviso indica peligro. Existe riesgo para su integridad física. Antes de manipular cualquier equipo, considere los riesgos de la corriente eléctrica y familiarícese con los procedimientos estándar de prevención de accidentes. Al final de cada advertencia encontrará el número que le ayudará a encontrar el texto traducido en el apartado de traducciones que acompaña a este dispositivo.

GUARDE ESTAS INSTRUCCIONES.

IMPORTANTES INFORMATIONS DE SÉCURITÉ

Ce symbole d'avertissement indique un danger. Vous vous trouvez dans une situation pouvant entraîner des blessures ou des dommages corporels. Avant de travailler sur un équipement, soyez conscient des dangers liés aux circuits électriques et familiarisez-vous avec les procédures couramment utilisées pour éviter les accidents. Pour prendre connaissance des traductions des avertissements figurant dans les consignes de sécurité traduites qui accompagnent cet appareil, référez-vous au numéro de l'instruction situé à la fin de chaque avertissement.

CONSERVEZ CES INFORMATIONS.

תקנון הזהרות אזהרה

הזהרות הבאות הן אזהרות על פי תקני התעשייה, על מנת להזהיר את המשתמש מפני חבלה פיזית אפשרית. במידה ויש שאלות או היתקלות בבעיה כלשהי, יש ליצור קשר עם מחלקת תמיכה טכנית של סופרמיקרו. טכנאים מוסמכים בלבד רשאים להתקין או להגדיר את הרכיבים. יש לקרוא את הנספח במלואו לפני התקנת או הגדרת הרכיבים במארזי סופרמיקרו.

اَكْ ف حالة وُكِي اَي تتسبب ف اصابة جسدهُ هذا الزهز عُ خطر! تحذُرُ .
 قبل اَي تعول على اَي هعدات، كي على علن بالوخاطز ال اُجوة عي الذوائر
 الكهزبائِة
 وكي على دراةُ بالووارسات النقاىِة لو عُ وقع اَي حادث
 استخدم رقن الب اى الو صُص ف هاةُ كل تحذُرُ للعشر تزجوتها

안전을 위한 주의사항

경고!

이 경고 기호는 위험이 있음을 알려 줍니다. 작업자의 신체에 부상을 야기 할 수 있는 상태에 있게 됩니다. 모든 장비에 대한 작업을 수행하기 전에 전기회로와 관련된 위험요소들을 확인하시고 사전에 사고를 방지할 수 있도록 표준 작업절차를 준수해 주시기 바랍니다.

해당 번역문을 찾기 위해 각 경고의 마지막 부분에 제공된 경고문 번호를 참조하십시오

BELANGRIJKE VEILIGHEIDSINSTRUCTIES

Dit waarschuwings symbool betekent gevaar. U verkeert in een situatie die lichamelijk letsel kan veroorzaken. Voordat u aan enige apparatuur gaat werken, dient u zich bewust te zijn van de bij een elektrische installatie betrokken risico's en dient u op de hoogte te zijn van de standaard procedures om ongelukken te voorkomen. Gebruik de nummers aan het eind van elke waarschuwing om deze te herleiden naar de desbetreffende locatie.

BEWAAR DEZE INSTRUCTIES

Installation Instructions



Warning! Read the installation instructions before connecting the system to the power source.

設置手順書

システムを電源に接続する前に、設置手順書をお読み下さい。

警告

将此系统连接电源前,请先阅读安装说明。

警告

將系統與電源連接前，請先閱讀安裝說明。

Warnung

Vor dem Anschließen des Systems an die Stromquelle die Installationsanweisungen lesen.

¡Advertencia!

Lea las instrucciones de instalación antes de conectar el sistema a la red de alimentación.

Attention

Avant de brancher le système sur la source d'alimentation, consulter les directives d'installation.

יש לקרוא את הוראות התקנה לפני חיבור המערכת למקור מתח.

اقرأ إرشادات التركيب قبل توصيل النظام إلى مصدر للطاقة

시스템을 전원에 연결하기 전에 설치 안내를 읽어주십시오.

Waarschuwing

Raadpleeg de installatie-instructies voordat u het systeem op de voedingsbron aansluit.

Circuit Breaker

Warning! This product relies on the building's installation for short-circuit (overcurrent) protection. Ensure that the protective device is rated not greater than: 250 V, 20 A.

サーキット・ブレーカー

この製品は、短絡(過電流)保護装置がある建物での設置を前提としています。

保護装置の定格が250 V、20 Aを超えないことを確認下さい。

警告

此产品的短路(过载电流)保护由建筑物的供电系统提供,确保短路保护设备的额定电流不大于250V,20A。

警告

此產品的短路(過載電流)保護由建築物的供電系統提供,確保短路保護設備的額定電流不大於250V,20A。

Warnung

Dieses Produkt ist darauf angewiesen, dass im Gebäude ein Kurzschluss- bzw. Überstromschutz installiert ist. Stellen Sie sicher, dass der Nennwert der Schutzvorrichtung nicht mehr als: 250 V, 20 A beträgt.

¡Advertencia!

Este equipo utiliza el sistema de protección contra cortocircuitos (o sobrecorrientes) del edificio. Asegúrese de que el dispositivo de protección no sea superior a: 250 V, 20 A.

Attention

Pour ce qui est de la protection contre les courts-circuits (surtension), ce produit dépend de l'installation électrique du local. Vérifiez que le courant nominal du dispositif de protection n'est pas supérieur à :250 V, 20 A.

מוצר זה מסתמך על הגנה המותקנת במבנים למניעת קצר חשמלי. יש לוודא כי המכשיר המגן מפני הקצר החשמלי הוא לא יותר מ-250VDC, 20A

هذا المنتج يعتمد على معدات الحماية مه الدوائر القصيرة التي تم تثبيتها في المبنى
تأكد من أن تقييم الجهاز الوقائي ليس أكثر من : 20A, 250V

경고!

이 제품은 전원의 단락(과전류)방지에 대해서 전적으로 건물의 관련 설비에 의존합니다. 보호장치의 정격이 반드시 250V(볼트), 20A(암페어)를 초과하지 않도록 해야 합니다.

Waarschuwing

Dit product is afhankelijk van de kortsluitbeveiliging (overspanning) van uw elektrische installatie. Controleer of het beveiligde apparaat niet groter gedimensioneerd is dan 250V, 20A.

Power Disconnection Warning



Warning! The system must be disconnected from all sources of power and the power cord removed from the power supply module(s) before accessing the chassis interior to install or remove system components (except for hot-swap components).



電源切断の警告

システムコンポーネントの取り付けまたは取り外しのために、シャーシ内部にアクセスするには、システムの電源はすべてのソースから切断され、電源コードは電源モジュールから取り外す必要があります。

警告

在你打开机箱并安装或移除内部器件前,必须将系统完全断电,并移除电源线。

警告

在您打開機殼安裝或移除內部元件前，必須將系統完全斷電，並移除電源線。

Warnung

Das System muss von allen Quellen der Energie und vom Netzanschlusskabel getrennt sein, das von den Spg.Versorgungsteilmodulen entfernt wird, bevor es auf den Chassisinnenraum zurückgreift, um Systemsbestandteile anzubringen oder zu entfernen.

¡Advertencia!

El sistema debe ser disconnected de todas las fuentes de energía y del cable eléctrico quitado de los módulos de fuente de alimentación antes de tener acceso el interior del chasis para instalar o para quitar componentes de sistema.

Attention

Le système doit être débranché de toutes les sources de puissance ainsi que de son cordon d'alimentation secteur avant d'accéder à l'intérieur du chassis pour installer ou enlever des composants de système.

אזהרה מפני ניתוק חשמלי

אזהרה!

יש לנתק את המערכת מכל מקורות החשמל ויש להסיר את כבל החשמלי מהספק לפני גישה לחלק הפנימי של המארז לצורך התקנת או הסרת רכיבים.

يجب فصل انظاؤ من جميع مصادر انطاقت وإزانت سهك انكهرباء من وحدة امداد انطاقت قيم

انصل إلى امناطق انداخييت نههيكم نشييج أو إزانت مكنناث الجهاز

경고!

시스템에 부품들을 장착하거나 제거하기 위해서는 새시 내부에 접근하기 전에 반드시 전원 공급장치로부터 연결되어있는 모든 전원과 전기코드를 분리해주어야 합니다.

Waarschuwing

Voordat u toegang neemt tot het binnenwerk van de behuizing voor het installeren of verwijderen van systeem onderdelen, dient u alle spanningsbronnen en alle stroomkabels aangesloten op de voeding(en) van de behuizing te verwijderen

Equipment Installation



Warning! Only authorized personnel and qualified service persons should be allowed to install, replace, or service this equipment.

機器の設置

トレーニングを受け認定された人だけがこの装置の設置、交換、またはサービスを許可されています。

警告

只有经过培训且具有资格的人员才能进行此设备的安装、更换和维修。

警告

只有經過受訓且具資格人員才可安裝、更換與維修此設備。

Warnung

Nur autorisiertes Personal und qualifizierte Servicetechniker dürfen dieses Gerät installieren, austauschen oder warten..

¡Advertencia!

Sólo el personal autorizado y el personal de servicio calificado deben poder instalar, reemplazar o dar servicio a este equipo.

Attention

Seul le personnel autorisé et le personnel de maintenance qualifié doivent être autorisés à installer, remplacer ou entretenir cet équipement..

אזהרה!

יש לאפשר רק צוות מורשה ואנשי שירות מוסמכים להתקין, להחליף או לטפל בציוד זה.

ينبغي السماح فقط للموظفين المعتمدين وأفراد الخدمة المؤهلين بتركيب هذا الجهاز أو استبداله أو صيانته.

경고!

승인된 직원과 자격을 갖춘 서비스 담당자만이 이 장비를 설치, 교체 또는 서비스할 수 있습니다.

Waarschuwing

Alleen geautoriseerd personeel en gekwalificeerd onderhoudspersoneel mag deze apparatuur installeren, vervangen of onderhouden..

Restricted Area

Warning! This unit is intended for installation in restricted access areas. A restricted access area can be accessed only through the use of a special tool, lock and key, or other means of security. (This warning does not apply to workstations).

アクセス制限区域

このユニットは、アクセス制限区域に設置されることを想定しています。

アクセス制限区域は、特別なツール、鍵と錠前、その他のセキュリティの手段を用いてのみ出入りが可能です。

警告

此部件应安装在限制进出的场所，限制进出的场所指只能通过使用特殊工具、锁和钥匙或其它安全手段进出的场所。

警告

此裝置僅限安裝於進出管制區域，進出管制區域係指僅能以特殊工具、鎖頭及鑰匙或其他安全方式才能進入的區域。

Warnung

Diese Einheit ist zur Installation in Bereichen mit beschränktem Zutritt vorgesehen. Der Zutritt zu derartigen Bereichen ist nur mit einem Spezialwerkzeug, Schloss und Schlüssel oder einer sonstigen Sicherheitsvorkehrung möglich.

¡Advertencia!

Esta unidad ha sido diseñada para instalación en áreas de acceso restringido. Sólo puede obtenerse acceso a una de estas áreas mediante la utilización de una herramienta especial, cerradura con llave u otro medio de seguridad.

Attention

Cet appareil doit être installé dans des zones d'accès réservés. L'accès à une zone d'accès réservé n'est possible qu'en utilisant un outil spécial, un mécanisme de verrouillage et une clé, ou tout autre moyen de sécurité.

אזור עם גישה מוגבלת

אזהרה!

יש להתקין את היחידה באזורים שיש בהם הגבלת גישה. הגישה ניתנת בעזרת 'כלי אבטחה בלבד' (מפתח, מנעול וכד.).

تخصيص هذه انحدة نترك بُها ف مناطق محظورة تم .

،ممكن اننصل إن منطقت محظورة فقط من خلال استخذاو أداة خاصت أو أ وس هُت أخري نلالأمما ققم ومفتاح

경고!

이 장치는 접근이 제한된 구역에 설치하도록 되어있습니다. 특수도구, 잠금 장치 및 키, 또는 기타 보안 수단을 통해서만 접근 제한 구역에 들어갈 수 있습니다.

Waarschuwing

Dit apparaat is bedoeld voor installatie in gebieden met een beperkte toegang. Toegang tot dergelijke gebieden kunnen alleen verkregen worden door gebruik te maken van speciaal gereedschap, slot en sleutel of andere veiligheidsmaatregelen.

Battery Handling



CAUTION: There is risk of explosion if the battery is replaced by an incorrect type. Replace the battery only with the same or equivalent type recommended by the manufacturer. Dispose of used batteries according to the manufacturer's instructions

電池の取り扱い

バッテリーを間違ったタイプに交換すると爆発の危険があります。交換する電池はメーカーが推奨する型、または同等のものを使用下さい。使用済電池は製造元の指示に従って処分して下さい。

警告

如果更换的电池类型不正确，则存在爆炸危险。请只使用同类电池或制造商推荐的功能相当的电池更换原有电池。请按制造商的说明处理废旧电池。

警告

如果更換的電池類型不正確，則有爆炸危險。請使用製造商建議之相同或功能相當的電池更換原有電池。請按照製造商的說明指示處理廢棄舊電池。

WARNUNG

Es besteht Explosionsgefahr, wenn die Batterie durch einen falschen Typ ersetzt wird. Ersetzen Sie die Batterie nur durch den gleichen oder vom Hersteller empfohlenen Batterietyp. Entsorgen Sie die benutzten Batterien nach den Anweisungen des Herstellers.

ATTENTION

Il existe un risque d'explosion si la batterie est remplacée par un type incorrect. Ne la remplacer que par une pile de type semblable ou équivalent, recommandée par le fabricant. Jeter les piles usagées conformément aux instructions du fabricant.

ADVERTENCIA

Existe riesgo de explosión si la batería se reemplaza por un tipo incorrecto. Reemplazar la batería exclusivamente con el mismo tipo o el equivalente recomendado por el fabricante. Desechar las baterías gastadas según las instrucciones del fabricante.

אזהרה!

קיימת סכנת פיצוץ אם הסוללה תוחלף בסוג שגוי. יש להחליף את הסוללה בסוג התואם מחברת יצרן מומלצת. סילוק הסוללות המשומשות יש לבצע לפי הוראות היצרן.

هناك خطر الانفجار إذا تم استبدال البطارية بنوع غير صحيح.
 اسحبذال البطارية
 فقط بنفس النوع أو ما يعادلها مما أوصت به الشركة المصنعة
 جخلص من البطاريات المسحمة وفقا لعمليات الشركة الصانعة

경고!

배터리를 잘못된 종류로 교체하면 폭발의 위험이 있습니다. 기존 배터리와 동일하거나 제조사에서 권장하는 동등한 종류의 배터리로만 교체해야 합니다. 제조사의 안내에 따라 사용된 배터리를 처리하여 주십시오.

WAARSCHUWING

Er bestaat explosiegevaar als de batterij wordt vervangen door een verkeerd type. Vervang de batterij slechts met hetzelfde of een equivalent type die door de fabrikant aanbevolen wordt. Gebruikte batterijen dienen overeenkomstig fabrieksvoorschriften afgevoerd te worden.

Redundant Power Supplies



Warning! This unit might have more than one power supply connection. All connections must be removed to de-energize the unit.

冗長電源装置

このユニットは複数の電源装置が接続されている場合があります。

ユニットの電源を切るためには、すべての接続を取り外さなければなりません。

警告

此部件连接的电源可能不止一个，必须将所有电源断开才能停止给该部件供电。

警告

此装置连接的电源可能不只一个，必须切断所有电源才能停止对该装置的供电。

Warnung

Dieses Gerät kann mehr als eine Stromzufuhr haben. Um sicherzustellen, dass der Einheit kein Strom zugeführt wird, müssen alle Verbindungen entfernt werden.

¡Advertencia!

Puede que esta unidad tenga más de una conexión para fuentes de alimentación. Para cortar por completo el suministro de energía, deben desconectarse todas las conexiones.

Attention

Cette unité peut avoir plus d'une connexion d'alimentation. Pour supprimer toute tension et tout courant électrique de l'unité, toutes les connexions d'alimentation doivent être débranchées.

אם קיים יותר מספק אחד

אזהרה!

ליחידה יש יותר מחיבור אחד של ספק. יש להסיר את כל החיבורים על מנת לרוקן את היחידה.

قد يكون لهذا الجهاز عدة اتصالات بوحدات امداد الطاقة .

يجب إزالة كافة الاتصالات لعسل الوحدة عن الكهرباء

경고!

이 장치에는 한 개 이상의 전원 공급 단자가 연결되어 있을 수 있습니다. 이 장치에 전원을 차단하기 위해서는 모든 연결 단자를 제거해야만 합니다.

Waarschuwing

Deze eenheid kan meer dan één stroomtoevoeraansluiting bevatten. Alle aansluitingen dienen verwijderd te worden om het apparaat stroomloos te maken.

Backplane Voltage



Warning! Hazardous voltage or energy is present on the backplane when the system is operating. Use caution when servicing.

バックプレーンの電圧

システムの稼働中は危険な電圧または電力が、バックプレーン上にかかっています。

修理する際には注意ください。

警告

当系统正在进行时，背板上有很危险的电压或能量，进行维修时务必小心。

警告

當系統正在進行時，背板上有危險的電壓或能量，進行維修時務必小心。

Warnung

Wenn das System in Betrieb ist, treten auf der Rückwandplatine gefährliche Spannungen oder Energien auf. Vorsicht bei der Wartung.

¡Advertencia!

Cuando el sistema está en funcionamiento, el voltaje del plano trasero es peligroso. Tenga cuidado cuando lo revise.

Attention

Lorsque le système est en fonctionnement, des tensions électriques circulent sur le fond de panier. Prendre des précautions lors de la maintenance.

מתח בפנל האחורי

אזהרה!

קיימת סכנת מתח בפנל האחורי בזמן תפעול המערכת. יש להיזהר במהלך העבודה.

هناك خطر من التيار الكهربائي أو الطاقة المتجددة على اللوحة
عندما يكون النظام يعمل كه حذرا عند خدمة هذا الجهاز

경고!

시스템이 동작 중일 때 후면판 (Backplane)에는 위험한 전압이나 에너지가 발생 합니다.
서비스 작업 시 주의하십시오.

Waarschuwing

Een gevaarlijke spanning of energie is aanwezig op de backplane wanneer het systeem in gebruik is. Voorzichtigheid is geboden tijdens het onderhoud.

Comply with Local and National Electrical Codes



Warning! Installation of the equipment must comply with local and national electrical codes.

地方および国の電気規格に準拠

機器の取り付けはその地方および国の電気規格に準拠する必要があります。

警告

设备安装必须符合本地与本国电气法规。

警告

設備安裝必須符合本地與本國電氣法規。

Warnung

Die Installation der Geräte muss den Sicherheitsstandards entsprechen.

¡Advertencia!

La instalación del equipo debe cumplir con las normas de electricidad locales y nacionales.

Attention

L'équipement doit être installé conformément aux normes électriques nationales et locales.

תיאום חוקי החשמל הארצי
אזהרה!
התקנת הציוד חייבת להיות תואמת לחוקי החשמל המקומיים והארציים.

تركيب المعدات الكهربائية يجب أن يمتثل للقوايه المحلية والبطية المتعلقة
بالكهرباء

경고!

현 지역 및 국가의 전기 규정에 따라 장비를 설치해야 합니다.

Waarschuwing

Bij installatie van de apparatuur moet worden voldaan aan de lokale en nationale elektriciteitsvoorschriften.

Product Disposal



Warning! Ultimate disposal of this product should be handled according to all national laws and regulations.

製品の廃棄

この製品を廃棄処分する場合、国の関係する全ての法律・条例に従い処理する必要があります。

警告

本产品的废弃处理应根据所有国家的法律和规章进行。

警告

本產品的廢棄處理應根據所有國家的法律和規章進行。

Warnung

Die Entsorgung dieses Produkts sollte gemäß allen Bestimmungen und Gesetzen des Landes erfolgen.

¡Advertencia!

Al deshacerse por completo de este producto debe seguir todas las leyes y reglamentos nacionales.

Attention

La mise au rebut ou le recyclage de ce produit sont généralement soumis à des lois et/ou directives de respect de l'environnement. Renseignez-vous auprès de l'organisme compétent.

סילוק המוצר

אזהרה!

סילוק סופי של מוצר זה חייב להיות בהתאם להנחיות וחוקי המדינה.

التخلص النهائي من هذا المنتج ينبغي التعامل معه وفقا لجميع القوانين واللوائح الوطنية عند

경고!

이 제품은 해당 국가의 관련 법규 및 규정에 따라 폐기되어야 합니다.

Waarschuwing

De uiteindelijke verwijdering van dit product dient te geschieden in overeenstemming met alle nationale wetten en reglementen.

Fan Warning



Warning! Hazardous moving parts. Keep away from moving fan blades. The fans might still be turning when you remove the fan assembly from the chassis. Keep fingers, screwdrivers, and other objects away from the openings in the fan assembly's housing.

ファンの警告

警告!回転部品に注意。運転中は回転部(羽根)に触れないでください。シャーシから冷却ファン装置を取り外した際、ファンがまだ回転している可能性があります。ファンの開口部に、指、ドライバー、およびその他のものを近づけないで下さい。

警告!

警告! 危險的可移動性零件。請務必與轉動的风扇叶片保持距離。當您從機架移除風扇裝置，風扇可能仍在轉動。小心不要將手指、螺絲起子和其他物品太靠近風扇

警告

危險的可移動性零件。請務必與轉動的风扇叶片保持距離。當您從機架移除風扇裝置，風扇可能仍在轉動。小心不要將手指、螺絲起子和其他物品太靠近風扇。

Warnung

Gefährlich Bewegende Teile. Von den bewegenden Lüfterblätter fern halten. Die Lüfter drehen sich u. U. noch, wenn die Lüfterbaugruppe aus dem Chassis genommen wird. Halten Sie Finger, Schraubendreher und andere Gegenstände von den Öffnungen des Lüftergehäuses entfernt.

¡Advertencia!

Riesgo de piezas móviles. Mantener alejado de las aspas del ventilador. Los ventiladores podran dar vuelta cuando usted quite el montaje del ventilador del chasis. Mantenga los dedos, los destornilladores y todos los objetos lejos de las aberturas del ventilador

Attention

Pieces mobiles dangereuses. Se tenir a l'écart des lames du ventilateur Il est possible que les ventilateurs soient toujours en rotation lorsque vous retirerez le bloc ventilateur du châssis. Prenez garde à ce que doigts, tournevis et autres objets soient éloignés du logement du bloc ventilateur.

אזהרה!

חלקים נעים מסוכנים. התרחק מלהבי המאוורר בפעולה כאשר מסירים את חלקי המאוורר מהמארז, יתכן והמאווררים עדיין עובדים. יש להרחיק למרחק בטוח את האצבעות וכלי עבודה שונים מהפתחים בתוך המאוורר

تحذير! أجزاء متحركة خطيرة. ابتعد عن شفرات المروحة المتحركة. من الممكن أن المراوح لا تزال تدور عند إزالة كتلة المروحة من الهيكل يجب إبقاء الأصابع ومفكات البراغي وغيرها من الأشياء بعيدا عن الفتحات في كتلة المروحة.

경고!

움직이는 위험한 부품. 회전하는 송풍 날개에 접근하지 마세요. 새시로부터 팬 조립품을 제거할 때 팬은 여전히 회전하고 있을 수 있습니다. 팬 조립품 외관의 열려있는 부분들로부터 손가락 및 스크류드라이버, 다른 물체들이 가까이 하지 않도록 배치해 주십시오.

Waarschuwing

Gevaarlijk bewegende onderdelen. Houd voldoende afstand tot de bewegende ventilatorbladen. Het is mogelijk dat de ventilator nog draait tijdens het verwijderen van het ventilatorsamenstel uit het chassis. Houd uw vingers, schroevendraaiers en eventuele andere voorwerpen uit de buurt van de openingen in de ventilatorbehuizing.

Power Cable and AC Adapter



Warning! When installing the product, use the provided or designated connection cables, power cables and AC adapters. Using any other cables and adapters could cause a malfunction or a fire. Electrical Appliance and Material Safety Law prohibits the use of UL or CSA -certified cables (that have UL/CSA shown on the cord) for any other electrical devices than products designated by Supermicro only.

電源コードとACアダプター

製品を設置する場合、提供または指定および購入された接続ケーブル、電源コードとACアダプターを該当する地域の条例や安全基準に適合するコードサイズやプラグと共に使用下さい。他のケーブルやアダプタを使用すると故障や火災の原因になることがあります。

電気用品安全法は、ULまたはCSA認定のケーブル(UL/CSAマークがコードに表記)を Supermicro が指定する製品以外に使用することを禁止しています。

警告

安装此产品时,请使用本身提供的或指定的或采购的连接线,电源线和电源适配器。包含遵照当地法规和安全要求的合规的电源线尺寸和插头。使用其它线材或适配器可能会引起故障或火灾。除了Supermicro所指定的产品,电气用品和材料安全法律规定禁止使用未经UL或CSA认证的线材。(线材上会显示UL/CSA符号)。

警告

安裝此產品時,請使用本身提供的或指定的或採購的連接線,電源線和電源適配器。包含遵照當地法規和安全要求的合規的電源線尺寸和插頭。使用其它線材或適配器可能會引起故障或火災。除了Supermicro所指定的產品,電氣用品和材料安全法律規定禁止使用未經UL或CSA認證的線材。(線材上會顯示UL/CSA符號)。

Warnung

Nutzen Sie beim Installieren des Produkts ausschließlich die von uns zur Verfügung gestellten Verbindungskabeln, Stromkabeln und/oder Adapter, die Ihre örtlichen Sicherheitsstandards einhalten. Der Gebrauch von anderen Kabeln und Adapter können Fehlfunktionen oder Feuer verursachen. Die Richtlinien untersagen das Nutzen von UL oder CAS zertifizierten Kabeln (mit UL/CSA gekennzeichnet), an Geräten oder Produkten die nicht mit Supermicro gekennzeichnet sind.

¡Advertencia!

Cuando instale el producto, utilice la conexión provista o designada o procure cables, Cables de alimentación y adaptadores de CA que cumplan con los códigos locales y los requisitos de seguridad, incluyendo el tamaño adecuado del cable y el enchufe. El uso de otros cables y adaptadores podría causar un mal funcionamiento o un incendio. La Ley de Seguridad de Aparatos Eléctricos y de Materiales prohíbe El uso de cables certificados por UL o CSA (que tienen el certificado UL / CSA en el código) para cualquier otros dispositivos eléctricos que los productos designados únicamente por Supermicro.

Attention

Lors de l'installation du produit, utilisez les cables de connection fournis ou désigné ou achetez des cables, cables de puissance et adaptateurs respectant les normes locales et les conditions de securite y compris les tailles de cables et les prises electriques appropries. L'utilisation d'autres cables et adaptateurs peut provoquer un dysfonctionnement ou un incendie. Appareils électroménagers et la Loi sur la Sécurité Matériel interdit l'utilisation de câbles certifiés- UL ou CSA (qui ont UL ou CSA indiqué sur le code) pour tous les autres appareils électriques sauf les produits désignés par Supermicro seulement.

AC ימאתמו מיילמשח מילבכ

!הרהזא

ךרוצל ומאתוה וא ושכרנ רשא AC מימאתמו מיקפס, מילבכב שמתשהל שי, רצומה תא מיניקתמ רשאכ לכב שומיש . עקתהו לבכה לש הנוכח הדימ ללוכ, תוימוקמה תוחיטבה תושירדל ומאתוה רשאו, הנקתהה למשחה ירישכמב שומישה יקוחל מאתהב. ילמשח רצק וא הלקתל מורגל לולע, רחא גוסמ מאתמ וא לבכ לש דוק מהילע עיפומ רשאכ) UL-ב או CSA-ב-ב מיכמוסומה מילבכב שמתשהל רוסיא מייק, תוחיטבה יקוחו דבלב Supermicro י"ע מאתוה רשא רצומב קר אלא, רחא ילמשח רצומ לכ רובע (UL/CSA)

תאלבאלא אארשב מץ וא עדדחמלא וא ערפוטמלא תאליטוטלא מאדחטסאב מץ, גתנמלא בייקרת דנע לכלז יפ אמב עילחמלא עמאלסלא תאבלטתמו נינאוץב מאזתלאלא עמ דדרתמלא ראיטלא תאלוחמו עיזאברמלא קיירח וא לטע יפ בבסטטי דץ ירזא תאלוחמו תאלבאלא יא מאדחטסא. מילסלא סבאלאו לטוומלא מץח CSA וא UL לביק נמ ענדמתמלא תאלבאלא מאדחטסא תאדעמלא עיזאברמלא עזחאלל עמאלסלא נונאק רזחי Supermicro לביק נמ עדדחמלא עינעמלא תאגתנמלא ריזא ירזא תאדעמ יא עמ (UL/CSA) עמאלע למחתיטלאו

전원 케이블 및 AC 어댑터

경고! 제품을 설치할 때 현지 코드 및 적절한 굵기의 코드와 플러그를 포함한 안전 요구 사항을 준수하여 제공되거나 지정된 연결 혹은 구매 케이블, 전원 케이블 및 AC 어댑터를 사용하십시오.

다른 케이블이나 어댑터를 사용하면 오작동이나 화재가 발생할 수 있습니다. 전기 용품 안전법은 UL 또는 CSA 인증 케이블 (코드에 UL / CSA가 표시된 케이블)을 Supermicro 가 지정한 제품 이외의 전기 장치에 사용하는 것을 금지합니다.

Stroomkabel en AC-Adapter

Waarschuwing! Bij het aansluiten van het Product uitsluitend gebruik maken van de geleverde Kabels of een andere geschikte aan te schaffen Aansluitmethode, deze moet altijd voldoen aan de lokale voorschriften en veiligheidsnormen, inclusief de juiste kabeldikte en stekker. Het gebruik van niet geschikte Kabels en/of Adapters kan een storing of brand veroorzaken. Wetgeving voor Elektrische apparatuur en Materiaalveiligheid verbied het gebruik van UL of CSA -gecertificeerde Kabels (met UL/CSA in de code) voor elke andere toepassing dan de door Supermicro hiervoor beoogde Producten.

Appendix C

Specifications and Compliance

Processor

Single Intel® Xeon® D-2796NT Processor SoC processor in Socket FCBGA 2579 with up to 20 cores and 120 W TDP

Chipset

SoC

Memory

Up to 256 GB of DDR4 ECC LRDIMM memory with speeds of up to 2933 MT/s in two DIMM slots; DIMM Size: Up to 256 GB

BIOS

AMI 32 MB SPI Flash EEPROM

ACPI 6.3, UEFI 2.7, Plug and Play (PnP), SMBIOS 3.3, PCI FW 3.0, Real Time Clock (RTC) Wakeup

Motherboard

B3SD1-20C-25G

Chassis

MCP-680-31002-0N; 3U height; 1.2" x 4.94" x 23.2" (depth) (30.5 x 125.5 x 589.3 mm)

Storage Drives

One fixed internal 2.5" NVMe U.2 drive

One M.2 SATA/NVMe

One SATA DOM

LAN Connections

Two 25 GbE and one dedicated BMC port

Operating Environment

Operating Temperature: 10° to 35° C (50° to 95° F)

Non-operating Temperature: -40° to 70° C (-40° to 158° F)

Operating Relative Humidity: 8% to 90% (non-condensing)

Non-operating Relative Humidity: 5% to 95% (non-condensing)

Regulatory Compliance

FCC, ICES, CE, VCCI, RCM, UKCA, NRTL, CB

Applied Directives, Standards

EMC/EMI: 2014/30/EU (EMC Directive)

Electromagnetic Compatibility Regulations 2016

FCC Part 15

ICES-003

VCCI-CISPR 32

AS/NZS CISPR 32

BS/EN55032

BS/EN55035

CISPR 32

CISPR 35

BS/EN 61000-3-2

BS/EN 61000-3-3

BS/EN 61000-4-2

BS/EN 61000-4-3

BS/EN 61000-4-4

BS/EN 61000-4-5

BS/EN 61000-4-6

BS/EN 61000-4-8

BS/EN 61000-4-11

Environment:

Delegated Directive (EU) 2015/863

Directive 2011/65/EU (RoHS)

REACH Regulation EC 1907/2006

WEEE Directive 2012/19/EU

California Proposition 65

Product Safety: 2014/35/EU (LVD Directive)

UL/CSA 62368-1 (USA and Canada)

Electrical Equipment (Safety) Regulations 2016

IEC/BS/EN 62368-1

Perchlorate Warning

California Best Management Practices Regulations for Perchlorate Materials: This Perchlorate warning applies only to products containing CR (Manganese Dioxide) Lithium coin cells. "Perchlorate Material-special handling may apply. See www.dtsc.ca.gov/hazardouswaste/perchlorate"

この装置は、クラスA機器です。この装置を住宅環境で使用すると電波妨害を引き起こすことがあります。この場合には使用者が適切な対策を講ずるよう要求されることがあります。

VCCI – A

General Data Center Environmental Specifications

Particulate contamination specifications

Air filtration: Data centers must be kept clean to Class 8 of ISO 14644-1 (ISO 2015). The air entering the data center should be filtered with a MERV 11 filter or better. The air within the data center should be continuously filtered with a MERV 8 filter or better.

Conductive dust: Air should be free fo conductive dust, zinc whiskers, or other conductive particles.

Corrosive dust: Air should be free of corrosive dust.

Gaseous* contamination specifications

Copper coupon corrosion rate: <300 Å/month per class G1 as defined by ANSI.ISA71.04-2013, reference by ASHRAE TC 9.9

Silver coupon corrosion rate: <200 Å/month per class G1 as defined by ANSI.ISA71.04-2013, reference by ASHRAE TC 9.9

*If testing with silver or copper coupons results in values less that 200 Å/month or 300 Å/month, respectively, then operating up to 70% relative humidity (RH) is acceptable. If the testing shows corrosion levels exceed these limits, then catalyst-type pollutants are probably present and RH should be driven to 50% or lower.