



A2SAP-H/-E/-L

USER'S MANUAL

Revision 1.0b

The information in this user's manual has been carefully reviewed and is believed to be accurate. The vendor assumes no responsibility for any inaccuracies that may be contained in this document, and makes no commitment to update or to keep current the information in this manual, or to notify any person or organization of the updates. **Please Note: For the most up-to-date version of this manual, please see our website at www.supermicro.com.**

Super Micro Computer, Inc. ("Supermicro") reserves the right to make changes to the product described in this manual at any time and without notice. This product, including software and documentation, is the property of Supermicro and/or its licensors, and is supplied only under a license. Any use or reproduction of this product is not allowed, except as expressly permitted by the terms of said license.

IN NO EVENT WILL Super Micro Computer, Inc. BE LIABLE FOR DIRECT, INDIRECT, SPECIAL, INCIDENTAL, SPECULATIVE OR CONSEQUENTIAL DAMAGES ARISING FROM THE USE OR INABILITY TO USE THIS PRODUCT OR DOCUMENTATION, EVEN IF ADVISED OF THE POSSIBILITY OF SUCH DAMAGES. IN PARTICULAR, SUPER MICRO COMPUTER, INC. SHALL NOT HAVE LIABILITY FOR ANY HARDWARE, SOFTWARE, OR DATA STORED OR USED WITH THE PRODUCT, INCLUDING THE COSTS OF REPAIRING, REPLACING, INTEGRATING, INSTALLING OR RECOVERING SUCH HARDWARE, SOFTWARE, OR DATA.

Any disputes arising between manufacturer and customer shall be governed by the laws of Santa Clara County in the State of California, USA. The State of California, County of Santa Clara shall be the exclusive venue for the resolution of any such disputes. Supermicro's total liability for all claims will not exceed the price paid for the hardware product.

FCC Statement: This equipment has been tested and found to comply with the limits for a Class B digital device pursuant to Part 15 of the FCC Rules. These limits are designed to provide reasonable protection against harmful interference when the equipment is operated in a commercial environment. This equipment generates, uses, and can radiate radio frequency energy and, if not installed and used in accordance with the manufacturer's instruction manual, may cause harmful interference with radio communications. Operation of this equipment in a residential area is likely to cause harmful interference, in which case you will be required to correct the interference at your own expense.

California Best Management Practices Regulations for Perchlorate Materials: This Perchlorate warning applies only to products containing CR (Manganese Dioxide) Lithium coin cells. "Perchlorate Material-special handling may apply. See www.dtsc.ca.gov/hazardouswaste/perchlorate.



WARNING: This product can expose you to chemicals including lead, known to the State of California to cause cancer and birth defects or other reproductive harm. For more information, go to www.P65Warnings.ca.gov.

The products sold by Supermicro are not intended for and will not be used in life support systems, medical equipment, nuclear facilities or systems, aircraft, aircraft devices, aircraft/emergency communication devices or other critical systems whose failure to perform be reasonably expected to result in significant injury or loss of life or catastrophic property damage. Accordingly, Supermicro disclaims any and all liability, and should buyer use or sell such products for use in such ultra-hazardous applications, it does so entirely at its own risk. Furthermore, buyer agrees to fully indemnify, defend and hold Supermicro harmless for and against any and all claims, demands, actions, litigation, and proceedings of any kind arising out of or related to such ultra-hazardous use or sale.

Manual Revision 1.0b

Release Date: June 17, 2020

Unless you request and receive written permission from Super Micro Computer, Inc., you may not copy any part of this document. Information in this document is subject to change without notice. Other products and companies referred to herein are trademarks or registered trademarks of their respective companies or mark holders.

Copyright © 2020 by Super Micro Computer, Inc.
All rights reserved.

Printed in the United States of America

Preface

About This Manual

This manual is written for system integrators, IT technicians and knowledgeable end users. It provides information for the installation and use of the A2SAP-H/-E/-L motherboard.

About This Motherboard

The A2SAP-H/-E/-L motherboard provides powerful graphics and increased media processing performance with multi-frame technology. Paired with the Intel® Atom SoC (System-on-a-Chip) processor, the A2SAP-H/-E/-L delivers more computing power for faster memory speeds and bandwidth while maintaining energy efficiency. Utilizing Intel® TCC (Time Coordinated Computing) Technology, the A2SAP-H/-E/-L resolves latency issues in applications and improves determinism across connected devices. The motherboard features advanced technologies such as Intel® Virtualization to improve security and reliability of systems, and Thermal Monitoring to reduce power consumption. It also comes with more I/O ports and high-speed connectivity.

Please note that this motherboard is intended to be installed and serviced by professional technicians only. For processor/memory updates, please refer to our website at <http://www.supermicro.com/products/>.

Conventions Used in the Manual

Special attention should be given to the following symbols for proper installation and to prevent damage done to the components or injury to yourself:



Warning! Indicates important information given to prevent equipment/property damage or personal injury.



Warning! Indicates high voltage may be encountered when performing a procedure.



Important: Important information given to ensure proper system installation or to relay safety precautions.



Note: Additional Information given to differentiate various models or provides information for correct system setup.

Contacting Supermicro

Headquarters

Address: Super Micro Computer, Inc.
980 Rock Ave.
San Jose, CA 95131 U.S.A.

Tel: +1 (408) 503-8000

Fax: +1 (408) 503-8008

Email: marketing@supermicro.com (General Information)
support@supermicro.com (Technical Support)

Website: www.supermicro.com

Europe

Address: Super Micro Computer B.V.
Het Sterrenbeeld 28, 5215 ML
's-Hertogenbosch, The Netherlands

Tel: +31 (0) 73-6400390

Fax: +31 (0) 73-6416525

Email: sales@supermicro.nl (General Information)
support@supermicro.nl (Technical Support)
rma@supermicro.nl (Customer Support)

Website: www.supermicro.nl

Asia-Pacific

Address: Super Micro Computer, Inc.
3F, No. 150, Jian 1st Rd.
Zhonghe Dist., New Taipei City 235
Taiwan (R.O.C)

Tel: +886-(2) 8226-3990

Fax: +886-(2) 8226-3992

Email: support@supermicro.com.tw

Website: www.supermicro.com.tw

Table of Contents

Chapter 1 Introduction

1.1 Checklist	7
Quick Reference	14
Quick Reference Table	15
Motherboard Features	16
1.2 Processor Overview	19
1.3 Special Features	19
Recovery from AC Power Loss	20
1.4 ACPI Features	20
1.5 Power Supply	20
1.6 Super I/O	21
1.7 Advanced Power Management	21
Management Engine (ME)	21

Chapter 2 Installation

2.1 Static-Sensitive Devices	22
Precautions	22
Unpacking	22
2.2 Motherboard Installation	23
Tools Needed	23
Location of Mounting Holes	23
Installing the Motherboard	24
2.3 Memory Support and Installation	25
Memory Support	25
SO-DIMM Installation	26
SO-DIMM Removal	26
2.4 Rear I/O Ports	27
2.5 Front Control Panel	30
2.6 Connectors	33
Power Connections	33
Headers and Connectors	34
2.7 Jumper Settings	45

How Jumpers Work.....	45
2.8 LED Indicators.....	47
Chapter 3 Troubleshooting	
3.1 Troubleshooting Procedures	48
Before Power On	48
No Power	48
Memory Errors	49
Losing the System's Setup Configuration.....	49
When the System Becomes Unstable	49
3.2 Technical Support Procedures	51
3.3 Frequently Asked Questions	52
3.4 Battery Removal and Installation	53
Battery Removal.....	53
Proper Battery Disposal.....	53
Battery Installation.....	53
3.5 Returning Merchandise for Service.....	54
Chapter 4 UEFI BIOS	
4.1 Introduction.....	55
Starting the Setup Utility	55
4.2 Main Setup	56
4.3 Advanced.....	58
4.4 Security.....	79
4.5 Boot	82
4.6 Save & Exit.....	84
Appendix A Software Installation	
A.1 Installing Software Programs	86
A.2 SuperDoctor® 5.....	87
Appendix B Standardized Warning Statements	
Battery Handling.....	88
Product Disposal	90
Appendix C UEFI BIOS Recovery	
C.1 Overview.....	91
C.2 Recovering the UEFI BIOS Image.....	91

Chapter 1

Introduction

Congratulations on purchasing your computer motherboard from an industry leader. This board is designed to provide you with the highest standards in quality and performance.

In addition to the motherboard, several important parts that are included with the system are listed below. If anything listed is damaged or missing, please contact your retailer.

1.1 Checklist

Main Parts List (Retail Single Package)		
Description	Part Number	Quantity
Motherboard	A2SAP-H/-E/-L	1
Heatsink (A2SAP-H/-E)	SNK-C0115L	1
Heatsink (A2SAP-L)	SNK-C0116L	1
Audio cable (20cm) (A2SAP-E/-L)	CBL-OTHR-0986	1
SATA power cable (20cm) (A2SAP-E/-L)	CBL-PWEX-1030	1
USB 2.0 cable (20cm) (A2SAP-E/-L)	CBL-CUSB-0983	1
COM cable (20cm) (A2SAP-E/-L)	CBL-CUSB-0984	1
SATA data cables (29cm) (A2SAP-E/-L)	CBL-SAST-0538	1
Power input cable (15cm) (A2SAP-E/-L)	CBL-PWEX-1029	1
Screw bag with four M3L4.5 screws and four M4 Standoff 11mm in height (A2SAP-H)	MCP-110-00096-0N	1

Main Parts List (Bulk Package)		
Description	Part Number	Quantity
Motherboard	A2SAP-H/-E/-L	1
Heatsink (A2SAP-E)	SNK-C0115L	1
Heatsink (A2SAP-L)	SNK-C0116L	1
SATA power cable (20cm) (A2SAP-E/-L)	CBL-PWEX-1030	1
SATA data cables (29cm) (A2SAP-E/-L)	CBL-SAST-0538	1
Power input cable (15cm) (A2SAP-E/-L)	CBL-PWEX-1029	1
Screw bag with four M3L4.5 screws and four M4 Standoff 11mm in height (A2SAP-H)	MCP-110-00096-0N	1



Note: The A2SAP-H bulk package does not include thermal solution.

Important Links

For your system to work properly, please follow the links below to download all necessary drivers/utilities and the user's manual for your server.

- Product manuals: <http://www.supermicro.com/support/manuals/>
- Product drivers and utilities: <https://www.supermicro.com/wftp/driver/>
- Product safety info: http://www.supermicro.com/about/policies/safety_information.cfm
- A secure data deletion tool designed to fully erase all data from storage devices can be found at our website: https://www.supermicro.com/wftp/utility/Lot9_Secure_Data_Deletion_Utility/
- If you have any questions, please contact our support team at: support@supermicro.com

This manual may be periodically updated without notice.

Figure 1-1. A2SAP-H Motherboard Image

Motherboard Front side

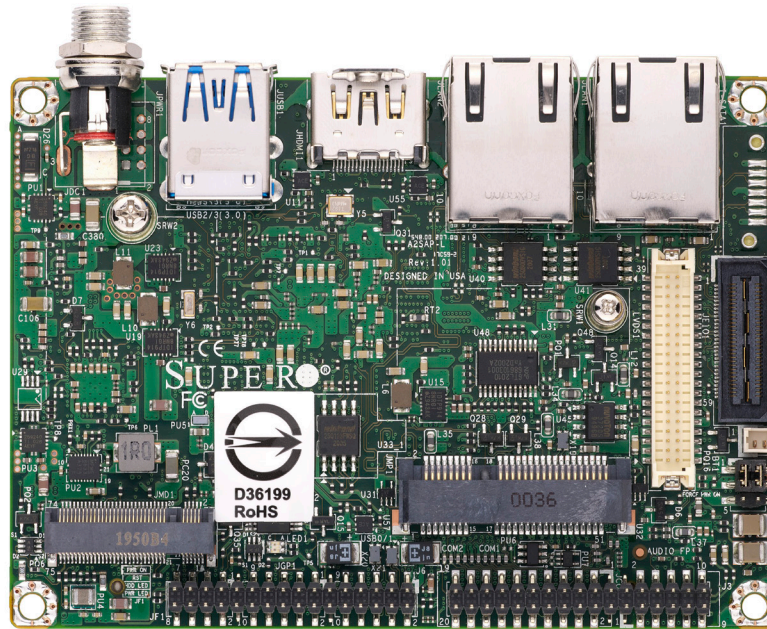

Motherboard Bottom side

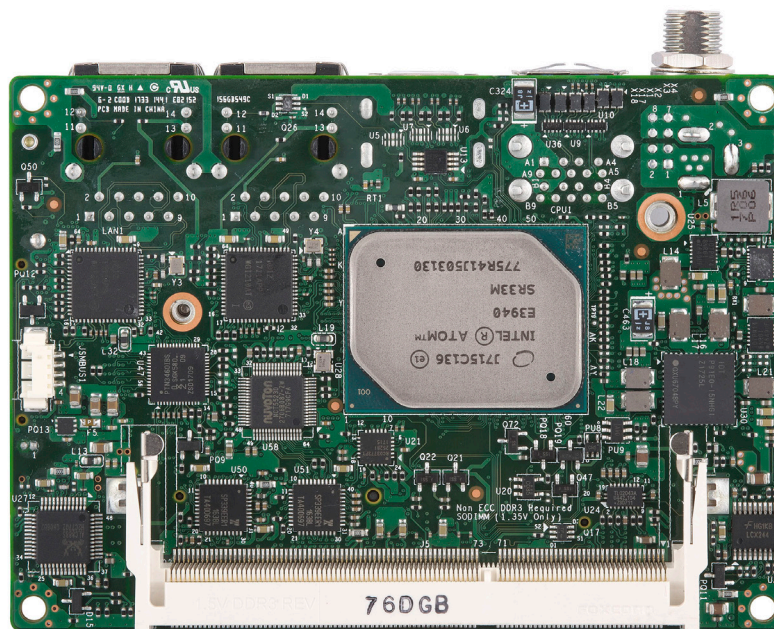

 **Note:** All graphics shown in this manual were based upon the latest PCB revision available at the time of publication of the manual. The motherboard you received may or may not look exactly the same as the graphics shown in this manual.

Figure 1-2. A2SAP-E/-L Motherboard Image

Motherboard Front side

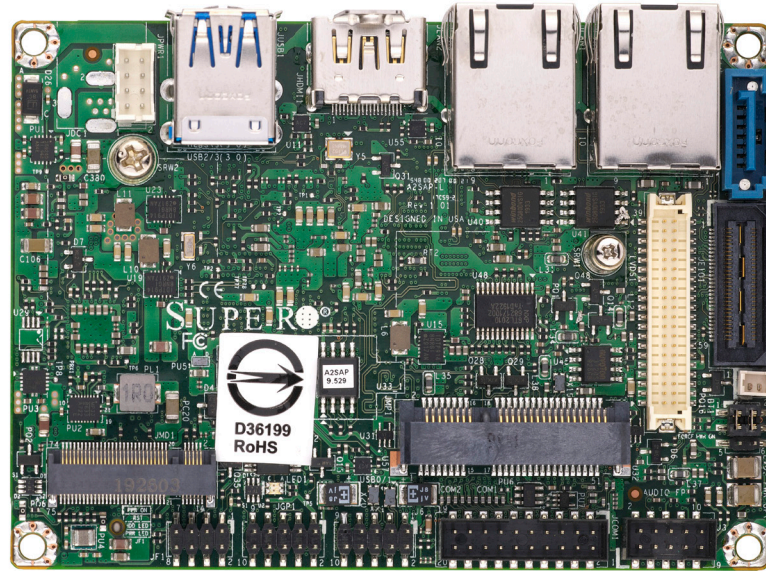

Motherboard Bottom side

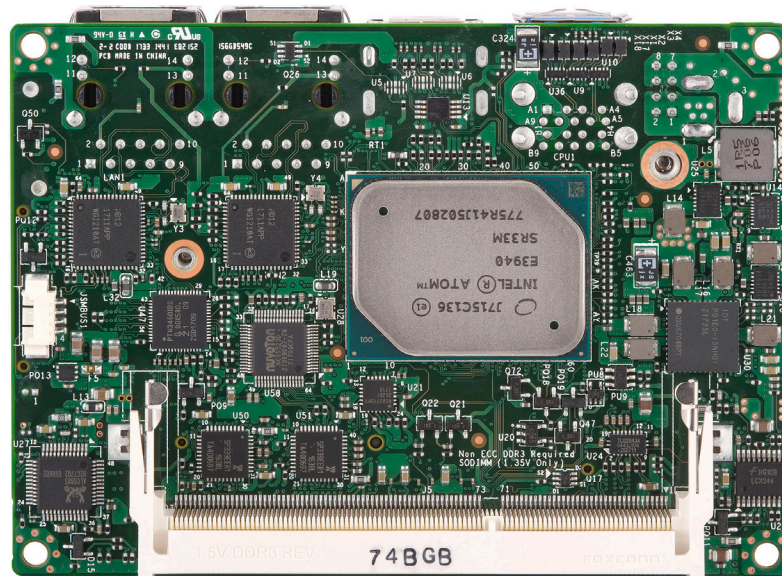
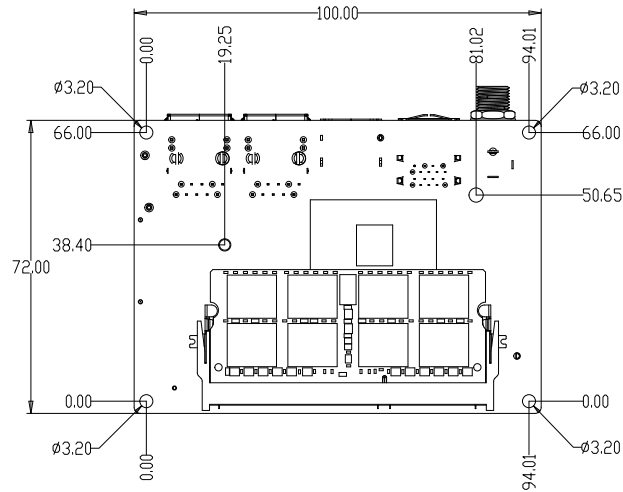
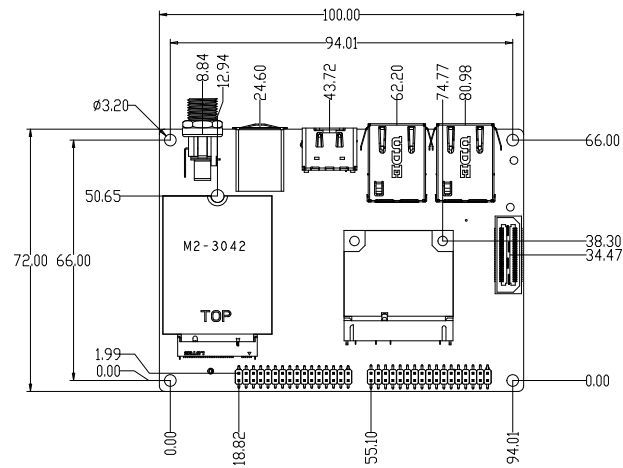

Figure 1-3. Motherboard Mechanical Drawings

A2SAP-H/-E/-L Motherboard Topside



A2SAP-H Motherboard Bottom Side



A2SAP-E/-L Motherboard Bottom Side

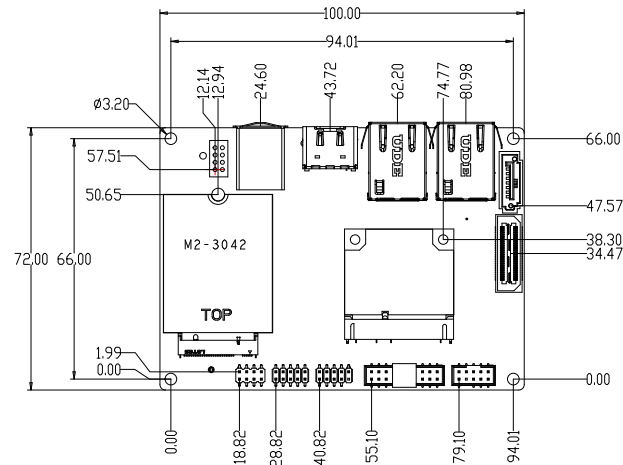
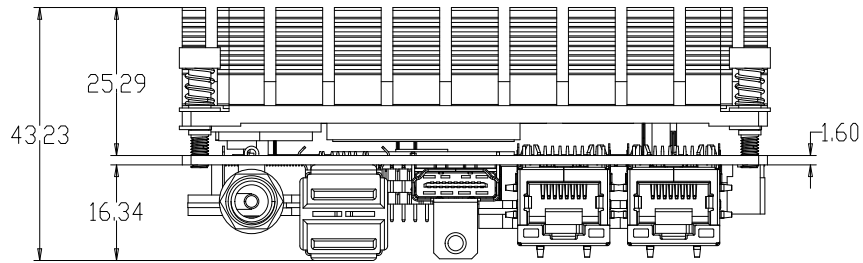
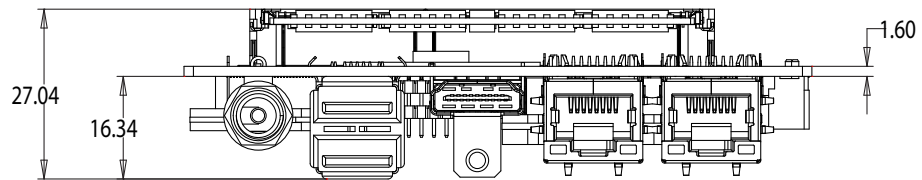

Figure 1-4. A2SAP-H/-E/-L Back Panel Mechanical Drawings

A2SAP-H Back Panel I/O with Heatsink



A2SAP-H Back Panel I/O without Heatsink



A2SAP-E Back Panel I/O with Heatsink

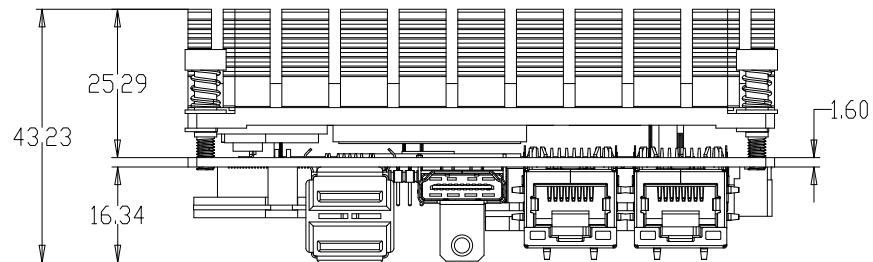

A2SAP-L Back Panel I/O with Heatsink

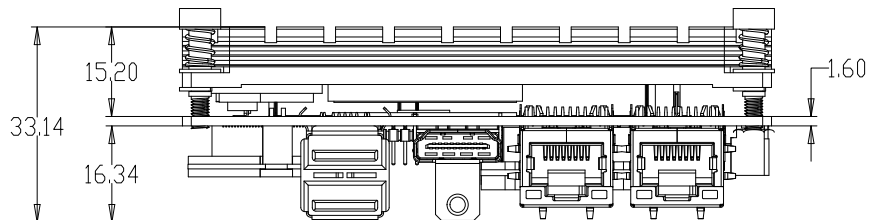
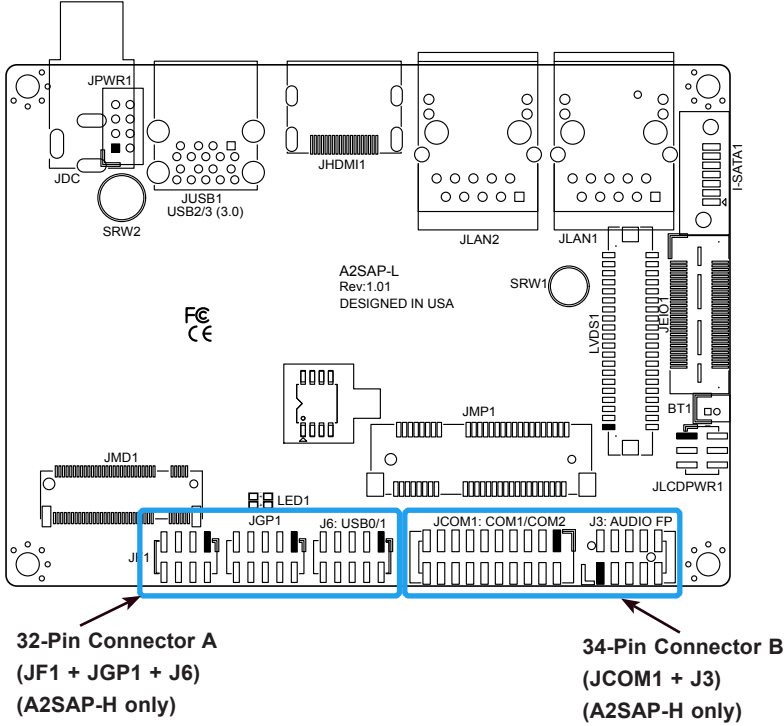
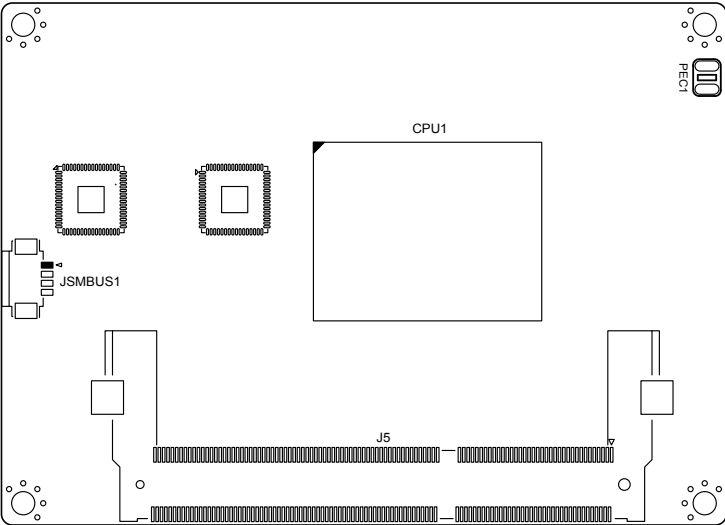

Figure 1-5. Motherboard Layout
(not drawn to scale)

A2SAP-H/-E/-L Bottom Layout



A2SAP-H/-E/-L Topside Layout



Quick Reference

Bottom Layout

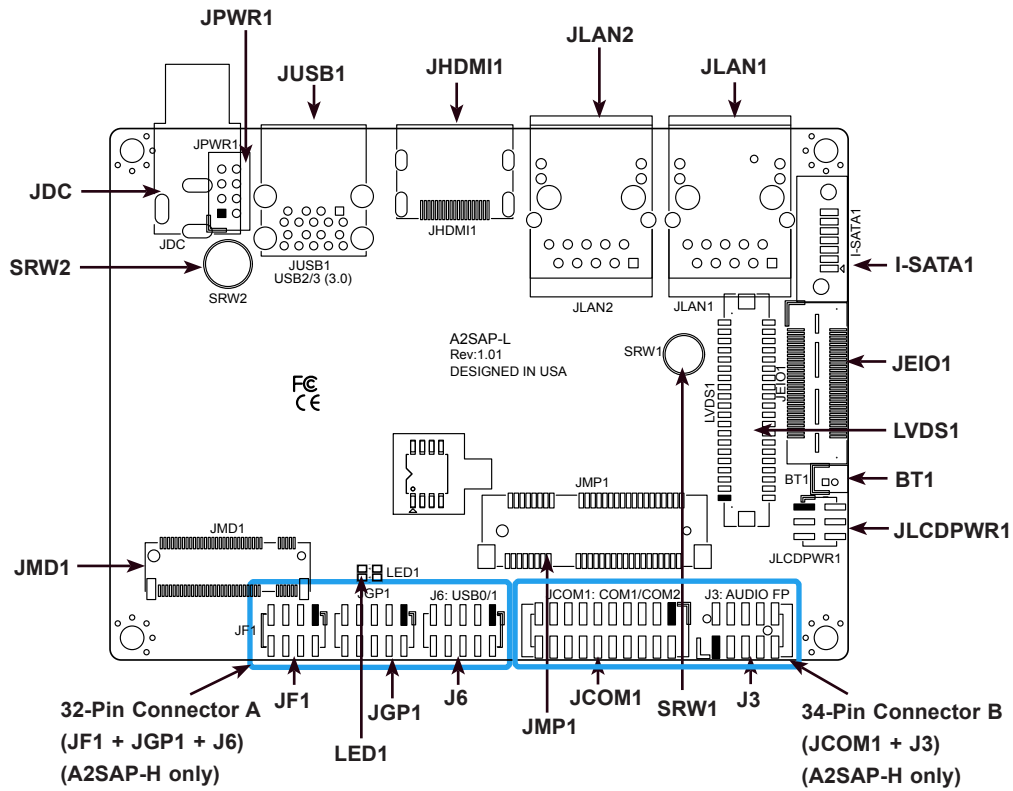

Topside Layout

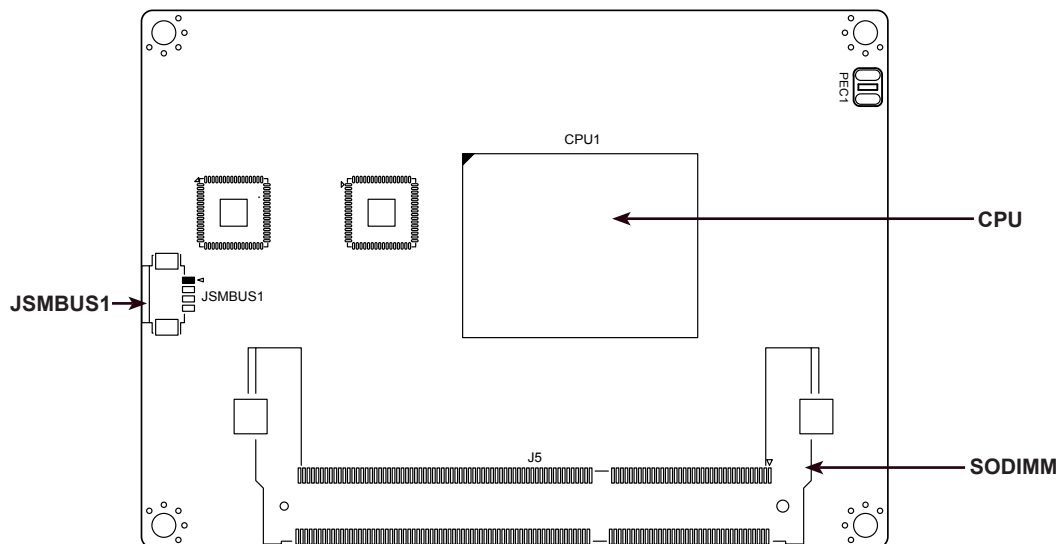

Notes:

- See Chapter 2 for detailed information on jumpers, I/O ports, and JF1 front panel connections. Jumpers and LED indicators not indicated are used for testing only.
- "■" indicates the location of Pin 1.

Quick Reference Table

Jumper	Description	Jumper Setting (Default *)
JLCDPWR1	FORCE POWER ON	Pins 2-4* (FORCE POWER ON) Pins 4-6 (POWER BUTTON ON)
	LVDS Panel Power Source Selection	Pins 1-3* (3.3V) Pins 3-5 (5V)

LED	Description	Status
LED1	Power LED	Solid Green: S0 mode Solid Red: S3/S4/S5 modes

Connector	Description
BT1	Battery Connector (To Clear CMOS, remove the battery, short pins 1-2 for more than 10 seconds and install the battery.)
I-SATA1	Intel® PCH SATA 3.0 Port
J3	Front Panel Audio Header (Mic-In/Headphone-out)
J6	Two USB 2.0 Headers
JCOM1	Two COM Headers (two RS232/422/485)
JDC	12V DC Jack Power Connector (for A2SAP-H)
JEIO1	Extension I/O (DP/HDMI, two PCI-E x1, two USB 2.0, LPC, SATA, SMBus, SMBus, 12Vsb 2A, 5Vsb 2.8A) Notes: A2SAP-E/-L does NOT support SATA signal. The DP signal is supported through a requested BIOS update.
JF1	Front Control Panel Header (Power/HDD LED, Reset, Power button)
JGP1	8-bit General Purpose I/O Header
JHDMI1	High Definition Multimedia Interface (HDMI) Port
JLAN1/JLAN2	LAN1/LAN2 (RJ45 LAN) Ports
JMD1	M.2 Slot (B-KEY 2242/3042) (SATA 3.0 / PCI-E x1 Gen2 / one USB 2.0)
JMP1	Half-Size Mini PCI-E Slot (supports PCI-E x1 Gen2 / one USB 2.0)
JPWR1	One 2x4-Pin 12V Power Connector (For A2SAP-E/L)
JSMBUS1	SMBus and 5V/1A SATA Power Box Header
JUSB1	Two Back Panel USB 3.0 Ports
LVDS1	Dual Channel 48-bit LVDS Connector
SRW1 - SRW2	M.2 and Mini PCI-E Mounting Holes
32-Pin Connector A	Front panel, 8-bit GPIO and USB 2.0 x 2 (JF1 + JGP1 + J6) (A2SAP-H only)
34-Pin Connector B	RS232/422/485 x 2 and Audio (JCOM1 + J3) (A2SAP-H only)



Note: Components not documented are for internal testing only.

Motherboard Features

Motherboard Features	
CPU	
<ul style="list-style-type: none"> A2SAP-H/-E: Intel® Atom™ x5-E3940 Processor, Quad Core, 2 MB L2 Cache, 1.6GHz-1.8GHz, 9.5W A2SAP-L: Intel® Atom™ x5-E3930 Processor, Dual Core, 2 MB L2 Cache, 1.3GHz-1.8GHz, 6.5W 	
Memory	
<ul style="list-style-type: none"> Integrated memory controller supports up to 8GB of DDR3L 1333/1600/1866MHz Non-ECC 204-pin SO-DIMM 	
DIMM Size	
<ul style="list-style-type: none"> Single channel Non-ECC SO-DIMM, DDR3L 1333/1600/1866MHz up to 8GB 	
Expansion Slots	
<ul style="list-style-type: none"> One (1) Half-Size Mini PCI-E Slot (supports PCI-E x1 Gen2 / one USB 2.0) One (1) M.2 Slot (B-KEY 2242/3042) (SATA 3.0 / PCI-E x1 Gen2 / USB 2.0) 	
Network	
<ul style="list-style-type: none"> Dual Intel I210 controller 	
Graphics	
<ul style="list-style-type: none"> Intel® HD Graphics GT Series 	<ul style="list-style-type: none"> Features: OpenGL 5.0, DirectX 12, OpenCL 2.1 Hardware Decode: AVC/H.264, MPEG2, VC1/WMV9, JPEG/MJPEG, HEVC/H.265, VP8, VP9, MVC Hardware Encode: AVC/H.264, JPEG/MJPEG, HEVC/H.265, VP8, VP9, MVC Display: HDMI 1.4 (resolution up to 3840x2160 at 30Hz), LVDS (dual channel 48-bit, resolution up to 1920x1200 at 60Hz)
I/O Devices	
<ul style="list-style-type: none"> COM Header 	<ul style="list-style-type: none"> Two (2) front accessible ports (JCOM1 supports two RS232/RS422/RS485)
<ul style="list-style-type: none"> SATA Port 	<ul style="list-style-type: none"> One (1) SATA 3.0 port (I-SATA1)
<ul style="list-style-type: none"> Audio Port 	<ul style="list-style-type: none"> One (1) HD Audio header with Mic-in/Headphone-out (Realtek ALC888S) (Audio on A2SAP-H/-E/-L only supports 0-60°C)
<ul style="list-style-type: none"> SMBus Header 	<ul style="list-style-type: none"> One (1) SMBus box header
<ul style="list-style-type: none"> SMCI E/I/O 	<ul style="list-style-type: none"> One (1) E/I/O Header (DP/HDMI, two PCI-E x1, two USB 2.0, LPC, SATA, SMBus, SMBus, 12Vsb 2A, 5Vsb 2.8A) <p>Notes: A2SAP-E/-L does NOT support SATA signal. The DP signal is supported through a requested BIOS update.</p>
Peripheral Devices	
<ul style="list-style-type: none"> One (1) USB 3.0 port on the rear I/O panel (JUSB1) One (1) USB 2.0 header (J6) 	
BIOS	
<ul style="list-style-type: none"> 128Mb SPI AMI BIOS® ACPI 6.0, SMBIOS 3.0, PCI F/W 3.0, UEFI 2.5, BIOS rescue hot-key, RTC (Real Time Clock) wakeup 	



Note: The table above is continued on the next page.

Motherboard Features
<p>Power Management</p> <ul style="list-style-type: none"> • ACPI power management • S3, S4, S5 • Power button override mechanism • Power-on mode for AC power recovery • Wake-On-LAN • TXE Management Engine • Force Power On by Jumper • RTC Battery (typical voltage: 3.0V, normal discharge capacity: 220mAh)
<p>System Health Monitoring</p> <ul style="list-style-type: none"> • Onboard voltage monitoring for +3.3V,+3.3V standby, VBAT, Vcore, system temperature, and memory voltage • CPU switching phase voltage regulator • CPU thermal trip support
<p>System Management</p> <ul style="list-style-type: none"> • SuperDoctor® 5, Watch Dog, NMI, RoHs
<p>LED Indicators</p> <ul style="list-style-type: none"> • Power/Suspend State Indicator LED
<p>Dimensions</p> <ul style="list-style-type: none"> • 2.83" (L) x 3.93" (W) (72mm x 100mm) SBCs • Height: A2SAP-H/-E 42.93mm, A2SAP-L 32.94mm
<p>Environment</p> <ul style="list-style-type: none"> • Operating Temperature Range: A2SAP-H/-E support -30°C ~ 75°C (-22°F - 167°F), A2SAP-L supports -30°C ~ 60°C (-22°F - 140°F). Note: The audio function operating temperature is 0~60°C. • Non-Operating Temperature Range: -40°C - 85°C (-40°F - 185°F) • Operating Relative Humidity Range: 8% - 90% (non-condensing) • Non-Operating Relative Humidity Range: 10% - 95% (non-condensing)



Note 1: The CPU maximum thermal design power (TDP) is subject to chassis and heatsink cooling restrictions. For proper thermal management, please check the chassis and heatsink specifications for proper CPU TDP sizing.

Figure 1-6.
System Block Diagram

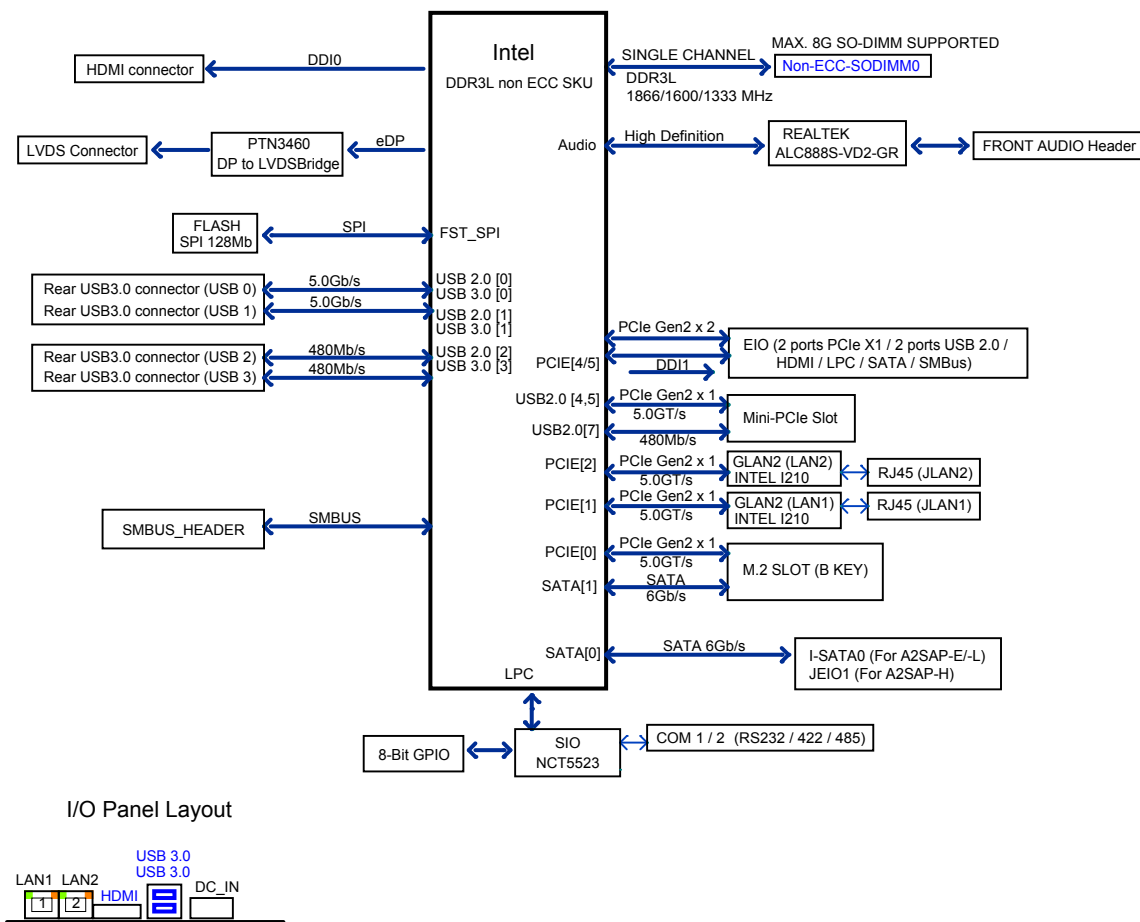

Figure 1-7.
A2SAP Series Specification Chart

Model	CPU	Base Freq.	Turbo Freq.	CPU TDP	GbE	HDMI	LVDS	USB3.0	USB2.0	Front Panel	GPIO	Audio	COM	SATA	E/I/O SATA	Power conn	E/I/O	Temp.	Passive Heatsink
A2SAP-E	E3940	1.66GHz	1.8GHz	9.5W	2	Yes	Yes	2	2	Yes	8-bit	Yes	2	1	N/A	Box header	1	-30°C ~ 75°C	25mm height (SNK-C0115L)
A2SAP-L	E3930	1.3GHz	1.8GHz	6.5W	2	Yes	Yes	2	2	Yes	8-bit	Yes	2	1	N/A	Box header	1	-30°C ~ 60°C	15mm height (SNK-C0116L)
A2SAP-H	E3940	1.66GHz	1.8GHz	9.5W	2	Yes	Yes	2	32-pin connector A			34-pin connector B	N/A	Yes	DC Jack	1	-30°C~ 75°C	25mm height (SNK-C0115L)	



Note 1: Audio function operating temperature is 0~60°C only

Note 2: This is a general block diagram and may not exactly represent the features on your motherboard. See the previous pages for the actual specifications of your motherboard.

1.2 Processor Overview

Built upon the functionality and capability of the Intel® Atom SoC series processor, the A2SAP-H/-E/-L motherboard offers maximum I/O expandability, energy efficiency, and data reliability in a 14-nm process architecture, and is optimized for embedded storage solutions, networking applications, or cloud-computing platforms. The A2SAP-H/-E/-L drastically increases system performance for a multitude of server applications.

The A2SAP-H/-E/-L supports the following features:

- Intel Virtualization Technology for Directed I/O (Intel VT-d)
- Enhanced Intel SpeedStep® Technology
- Video Connectors: HDMI and LVDS
- Adaptive Thermal Management/Monitoring
- Mini-PCI-E slot with PCI-E Gen2 X1 with transfer rates of up to 5Gb/s
- SATA port with SATA Gen3 with transfer rates of up to 6Gb/s
- System Management Bus (SMBus) Specification, Version 2.0
- M.2 slot with B-key 2242/3042 module
- Integrated Sensor Hub (ISH)
- Intel® Identity Protection Technology

1.3 Special Features

This section describes the health monitoring features of the A2SAP-H/-E/-L motherboard. The motherboard has an onboard System Hardware Monitor chip that supports system health monitoring.

Recovery from AC Power Loss

The Basic I/O System (BIOS) provides a setting that determines how the system will respond when AC power is lost and then restored to the system. You can choose for the system to remain powered off (in which case you must press the power switch to turn it back on), or for it to automatically return to the power-on state. See the Advanced BIOS Setup section for this setting. The default setting is Last State.



Note: Before setting the Recovery from AC Power Loss function in the BIOS, please adjust force power on jumper JLCDPWR1 to pins 4-6 to disable the force power-on function.

1.4 ACPI Features

ACPI stands for Advanced Configuration and Power Interface. The ACPI specification defines a flexible and abstract hardware interface that provides a standard way to integrate power management features throughout a computer system including its hardware, operating system and application software. This enables the system to automatically turn on and off peripherals such as network cards, hard disk drives and printers.

In addition to enabling operating system-directed power management, ACPI also provides a generic system event mechanism for Plug and Play and an operating system-independent interface for configuration control. ACPI leverages the Plug and Play BIOS data structures while providing a processor architecture-independent implementation that is compatible with Windows® 10.

1.5 Power Supply

As with all computer products, a stable power source is necessary for proper and reliable operation. It is even more important for processors that have high CPU clock rates. In areas where noisy power transmission is present, you may choose to install a line filter to shield the computer from noise. It is recommended that you also install a power surge protector to help avoid problems caused by power surges.

1.6 Super I/O

The Super I/O (NCT5523 chip) provides two high-speed, 16550 compatible serial communication ports (UARTs), one of which supports serial infrared communication. Each UART includes a 16-byte send/receive FIFO, a programmable baud rate generator, complete modem control capability and a processor interrupt system. Both UARTs provide legacy speed with baud rate of up to 115.2 Kbps as well as an advanced speed with baud rates of 250 K, 500 K, or 1 Mb/s, which support higher speed modems.

The Super I/O provides functions that comply with ACPI (Advanced Configuration and Power Interface), which includes support of legacy and ACPI power management through a SMI or SCI function pin. It also features auto power management to reduce power consumption.

The IRQs, DMAs and I/O space resources of the Super I/O can be flexibly adjusted to meet ISA PnP requirements, which support ACPI and APM (Advanced Power Management).

1.7 Advanced Power Management

The following new advanced power management features are supported by the motherboard.

Management Engine (ME)

Intel Atom SoC only supports the TXE function, also called CSE (Converged Security Engine), which is the lite ME function.

Chapter 2

Installation

2.1 Static-Sensitive Devices

Electrostatic Discharge (ESD) can damage electronic components. To prevent damage to your motherboard, it is important to handle it very carefully. The following measures are generally sufficient to protect your equipment from ESD.

Precautions

- Use a grounded wrist strap designed to prevent static discharge.
- Touch a grounded metal object before removing the board from the antistatic bag.
- Handle the board by its edges only; do not touch its components, peripheral chips, memory modules or gold contacts.
- When handling chips or modules, avoid touching their pins.
- Put the motherboard and peripherals back into their antistatic bags when not in use.
- For grounding purposes, make sure that your chassis provides excellent conductivity between the power supply, the case, the mounting fasteners and the motherboard.
- Use only the correct type of CMOS onboard battery as specified by the manufacturer.

Unpacking

The motherboard is shipped in antistatic packaging to avoid static damage. When unpacking the motherboard, make sure that the person handling it is static protected.

2.2 Motherboard Installation

All motherboards have standard mounting holes to fit different types of chassis. Make sure that the locations of all the mounting holes for both the motherboard and the chassis match. Although a chassis may have both plastic and metal mounting fasteners, metal ones are highly recommended because they ground the motherboard to the chassis. Make sure that the metal standoffs click in or are screwed in tightly.

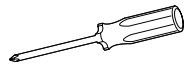

Phillips Screwdriver (1)



Phillips Screws (4)



Standoffs (4)
Only if Needed

Tools Needed

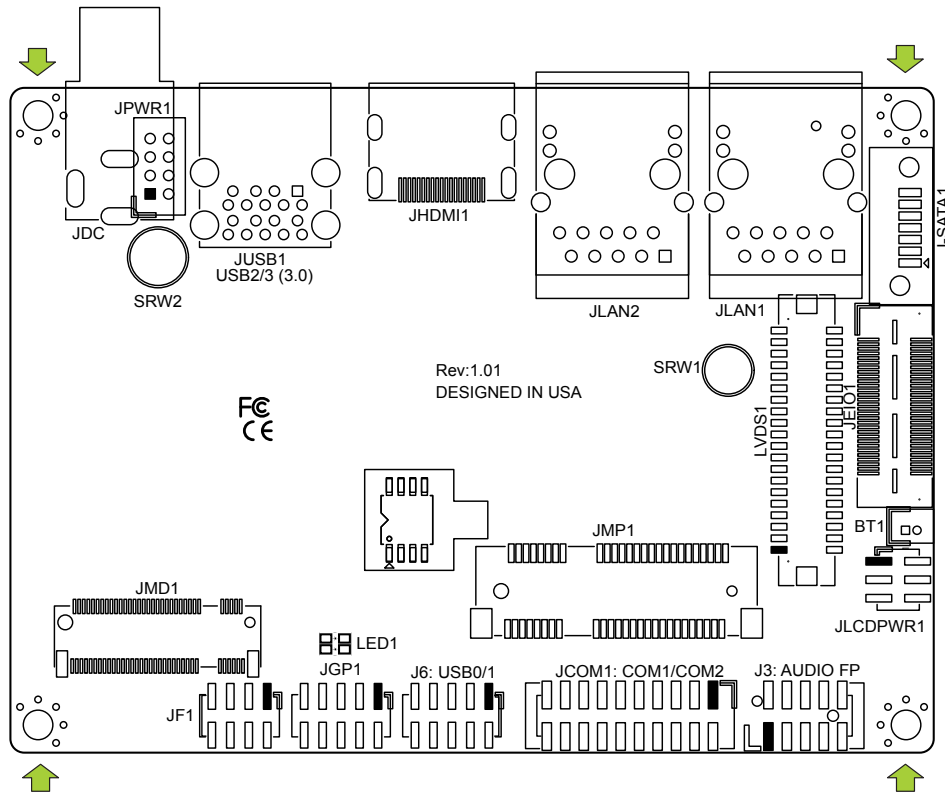

Location of Mounting Holes



Note: 1) To avoid damaging the motherboard and its components, please do not use a force greater than 8 lb/inch on each mounting screw during motherboard installation. 2) Some components are very close to the mounting holes. Please take precautionary measures to avoid damaging these components when installing the motherboard to the chassis.

Installing the Motherboard

1. Locate the mounting holes on the motherboard. See the previous page for the location.

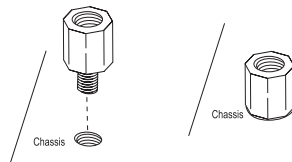

2. Install standoffs in the chassis.
3. Install the memory. Follow section 2.3 - Memory Support and Installation
4. After the memory installation is complete, install the heatsink.
5. The thermal solution kit that comes with the motherboard includes one heatsink with thermal grease and four copper standoffs that are 19mm in height. The copper standoff type is determined by the customer's chassis design. The copper standoffs that are 19mm in height are recommended only.
6. To install the heatsink, remove the plastic cover on the bottom of the heatsink to expose the thermal grease. Then place the heatsink directly on the CPU and make sure the thermal grease is in contact with the CPU.
7. Turn the motherboard over and tighten the standoffs on the chassis with the corresponding screws by using the Phillips screwdriver. Install the motherboard into the chassis carefully to avoid damaging other motherboard components.

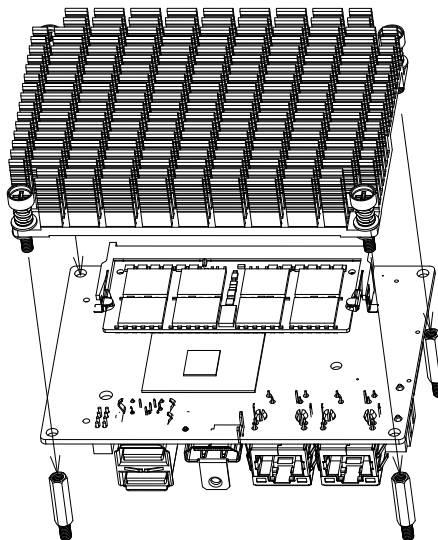

8. Make sure that the motherboard is securely placed in the chassis.

 **Note:** Images displayed are for illustration only. Your chassis or components might look different from those shown in this manual.

2.3 Memory Support and Installation



Note: Check the website for recommended memory modules.



Important: Exercise extreme care when installing or removing DIMM modules to prevent any possible damage.

Memory Support

The A2SAP-H/-E/-L supports up to 8GB of DDR3L Non-ECC SO-DIMM with speeds of 1333/1600/1866MHz in one memory slot on the bottom side of the motherboard.

Bottom Layout

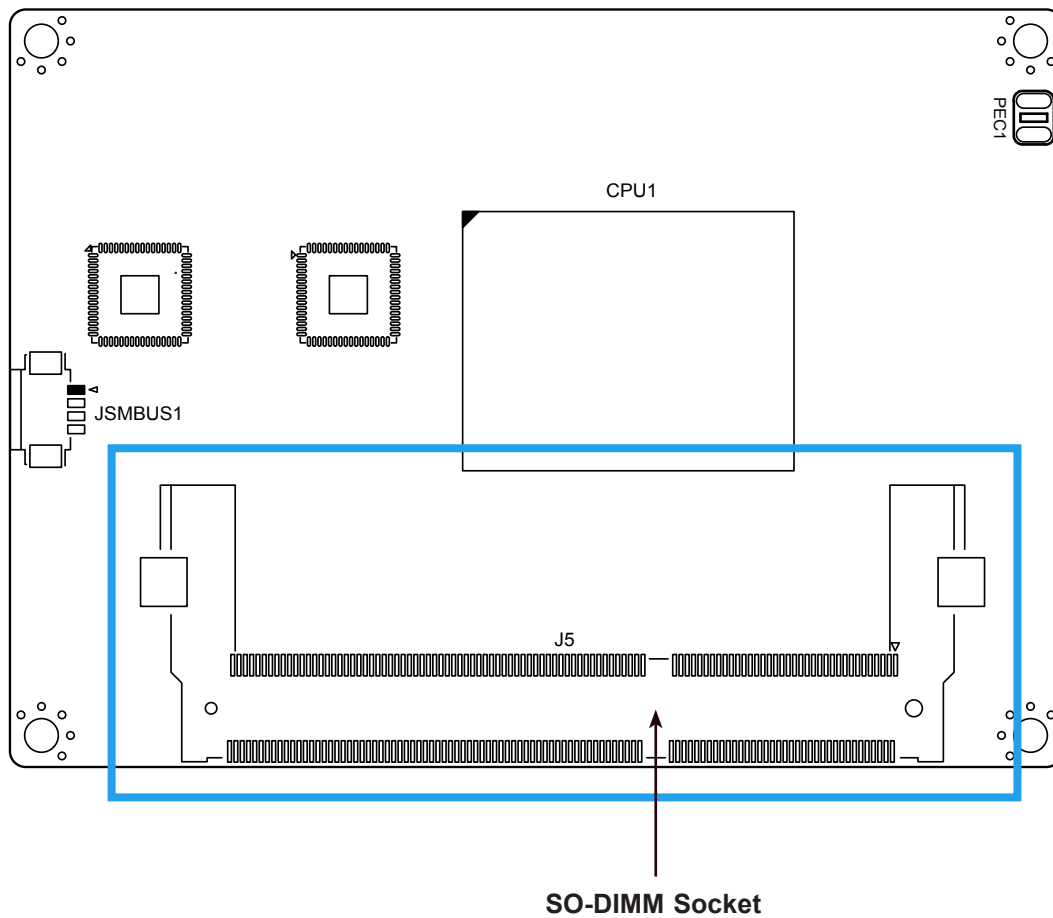

SO-DIMM Installation

1. Position the SO-DIMM module's bottom key so it aligns with the receptive point on the slot.

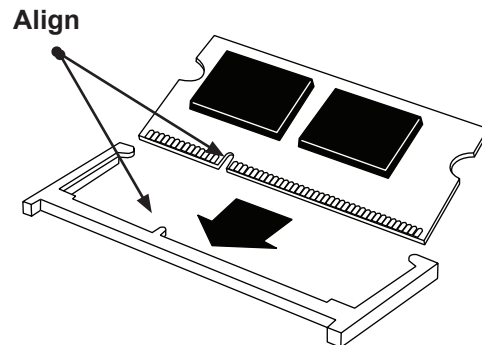

2. Insert the SO-DIMM module vertically at about a 45 degree angle. Press down until the module locks into place.

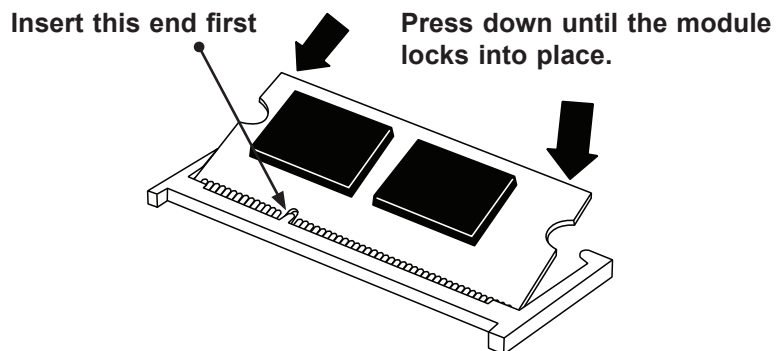

3. The side clips will automatically secure the SO-DIMM module, locking it into place.

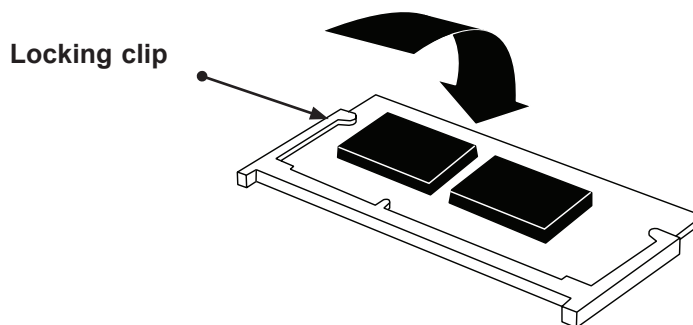

SO-DIMM Removal

1. Push the side clips at the end of the slot to release the SO-DIMM module. Pull the SO-DIMM module up to remove it from the slot.

2.4 Rear I/O Ports

See Figure 2-1 below for the locations and descriptions of the various I/O ports on the rear of the motherboard.

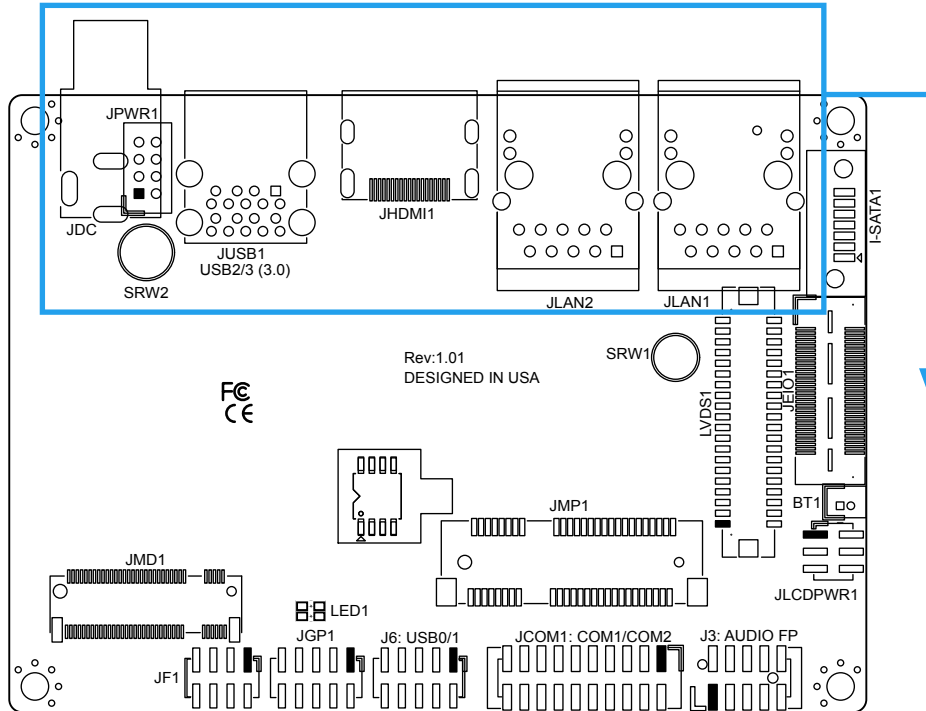
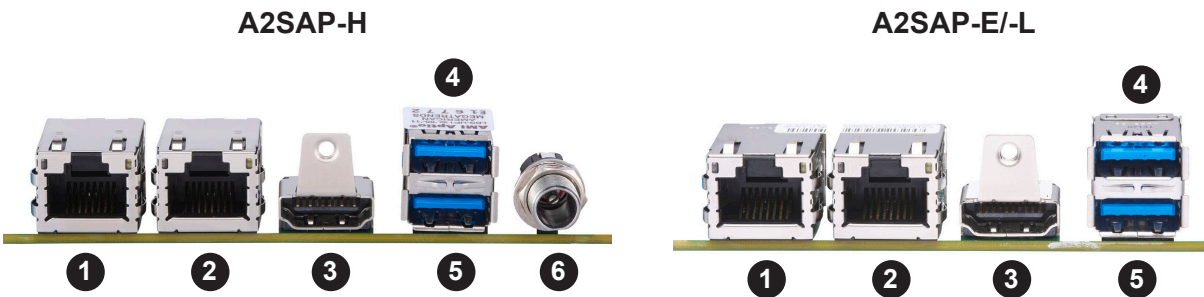

Figure 2-1. I/O Port Locations and Definitions



Rear I/O Ports			
#	Description	#	Description
1.	LAN1	4.	USB2
2.	LAN2	5.	USB1
3.	HDMI	6.	JDC

LAN Ports

Two LAN ports (JLAN1 - JLAN2) are located on the I/O back panel. These ports accept RJ45 type cables. Please refer to the LED Indicator section for LAN LED information. Refer to the table below for pin definitions.

LAN Port Pin Definition			
Pin#	Definition	Pin#	Definition
1	GND	9	TRD1+
2	CT_VCC	10	TRD1-
3	TRD4+	11	GRN+/ORG-
4	TRD4-	12	GRN-/ORG+
5	TRD3+	13	YEL+
6	TRD3-	14	YEL-
7	TRD2+	15	SH1
8	TRD2-	16	SH2

HDMI Port

The HDMI (High-Definition Multimedia Interface) port is used to display both high definition video and digital sound through an HDMI-capable display, using the same cable.

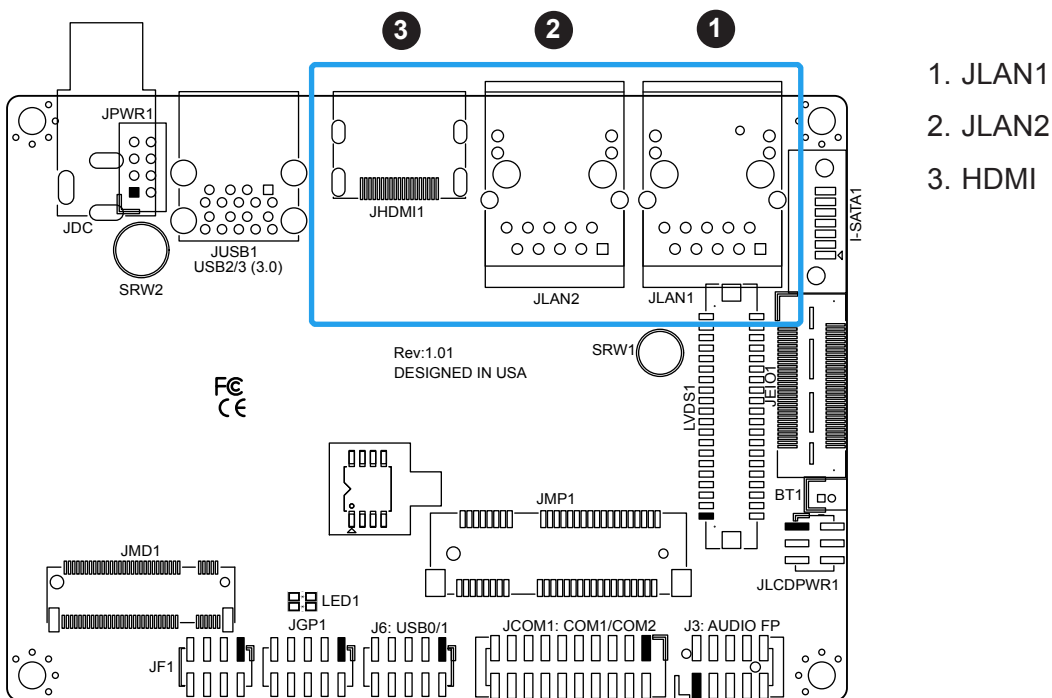

Universal Serial Bus (USB) Ports

There are two USB 3.0 ports (JUSB1) on the I/O back panel. The motherboard has two additional USB 2.0 connections via the JEIO1 header. J6 also provides two front panel USB 2.0 connections. The onboard headers can be used to provide front side USB access with a cable. Two USB 2.0 cables for front panel support are included with the motherboard single retail package.

Back Panel USB 3.0 Pin Definition			
Pin#	Definition	Pin#	Definition
A1	VBUS	B1	VBUS
A2	D1-N	B2	D2-N
A3	D1-P	B3	D2-P
A4	GND	B4	GND
A5	Stda_SSRX1-N	B5	Stda_SSRX2-N
A6	Stda_SSRX1-P	B6	Stda_SSRX2-P
A7	GND_DRAIN	B7	GND_DRAIN
A8	Stda_SSTX1-N	B8	Stda_SSTX2-N
A9	Stda_SSTX1-P	B9	Stda_SSTX2-P

Front Panel USB 2.0 Header Pin Definition			
Pin#	Definition	Pin#	Definition
1	P5V_DUAL_F	2	P5V_DUAL_F
3	USBCON_N0	4	USBCON_N1
5	USBCON_P0	6	USBCON_P1
7	GND	8	GND
9	N/A	10	N/A

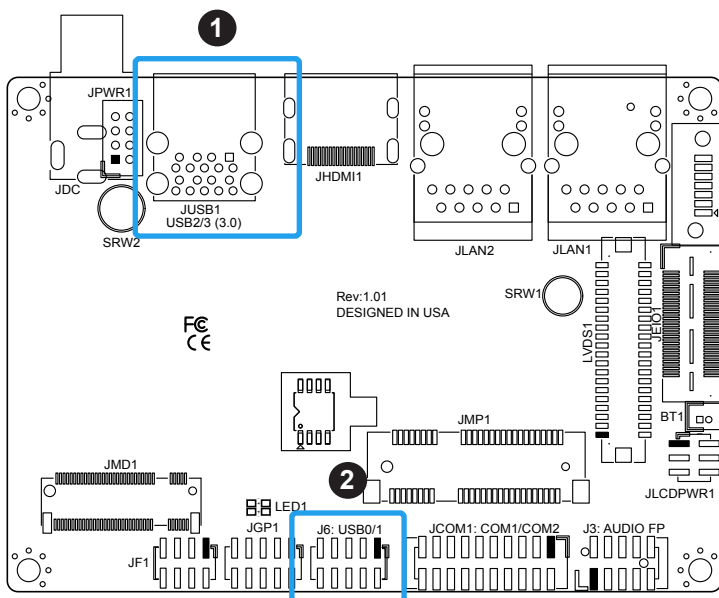

1. JUSB1

2. J6

2.5 Front Control Panel

JF1 contains header pins for various buttons and indicators that are normally located on a control panel at the front of the chassis. These connectors are designed specifically for use with a custom chassis. Refer to the figure below for the descriptions of the front control panel buttons and LED indicators.

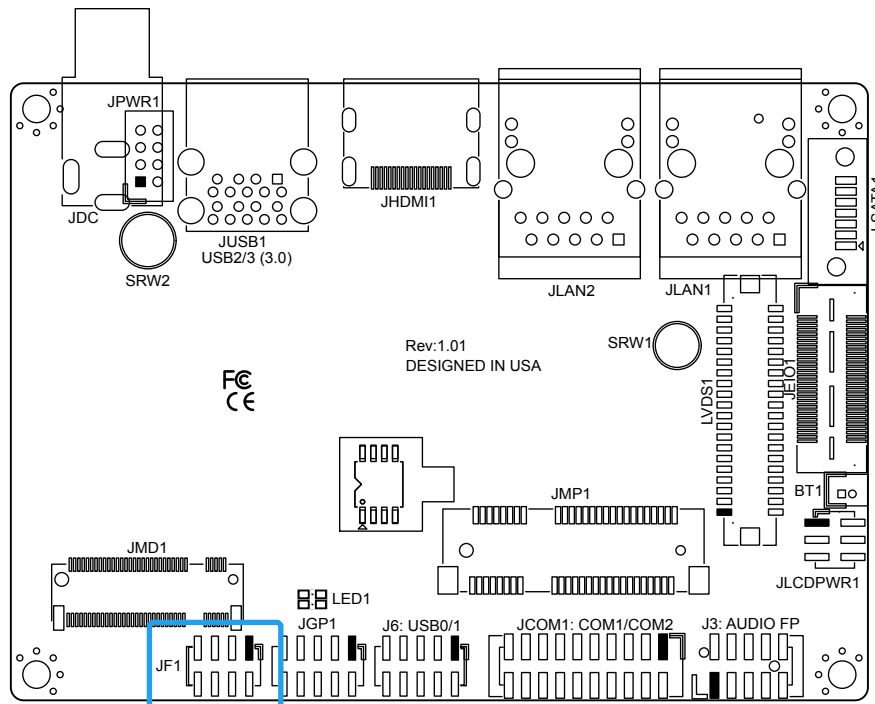
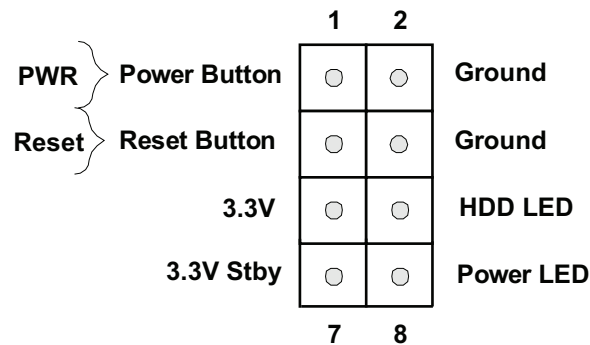

Figure 2-2. JF1 Header Pins



Power Button

The Power Button connection is located on pins 1 and 2 of JF1. Momentarily contacting both pins will power on/off the system. This button can also be configured to function as a suspend button (with a setting in the BIOS - see Chapter 4). To turn off the power in the suspend mode, press the button for at least 4 seconds. Refer to the table below for pin definitions.

Power Button Pin Definition (JF1)	
Pin#	Definition
1	Power Button
2	GND

Reset Button

The Reset Button connection is located on pins 3 and 4 of JF1. Attach it to a hardware reset switch on the computer case to reset the system. Refer to the table below for pin definitions.

Reset Button Pin Definition (JF1)	
Pin#	Definition
3	Reset
4	Ground

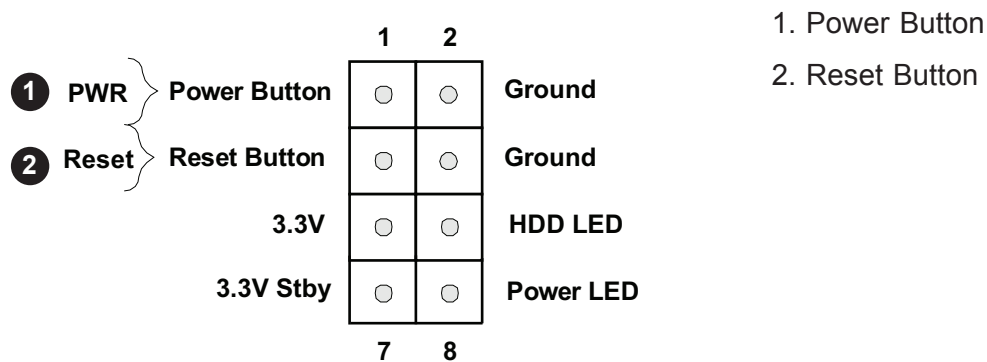

HDD LED

The HDD LED connection is located on pins 5 and 6 of JF1. Attach a cable here to indicate the status of HDD-related activities, including SATA activities. Refer to the table below for pin definitions.

HDD LED Pin Definition (JF1)	
Pin#	Definition
5	+3.3V
6	HDD Active LOW

Power LED

The Power LED connection is located on pins 7 and 8 of JF1. Refer to the table below for pin definitions.

Power LED Pin Definition (JF1)	
Pin#	Definition
7	+3.3VSB
8	Power LED LOW

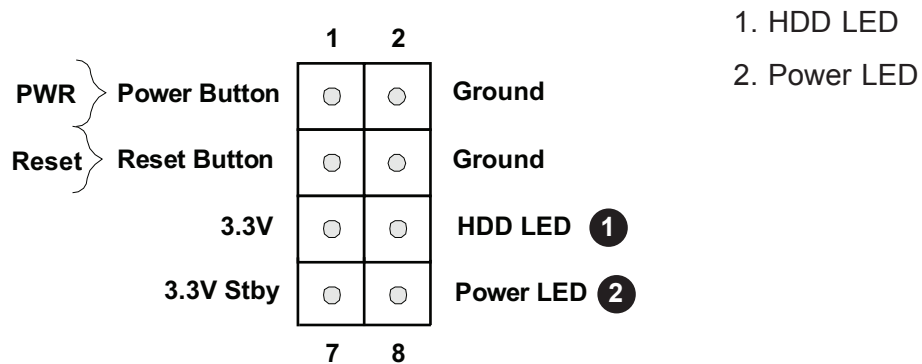

2.6 Connectors

Power Connections

12V DC Power Connector

JPWR1 is only available on the A2SAP-E/-L. It is a 2x4-pin, 2.0mm pitch box header, 12V DC power source for the motherboard. The cable package includes a 2x4-pin to 2x2-pin power cable.

12V DC Power Pin Definition	
Pin#	Definition
1-4	P12VSB
5-8	GND

JDC

JDC, only available on the A2SAP-H, is a lockable DC jack power connector.

12V Stdby Power Pin Definition	
Pin#	Definition
1	P12VSB
2	GND
3	GND

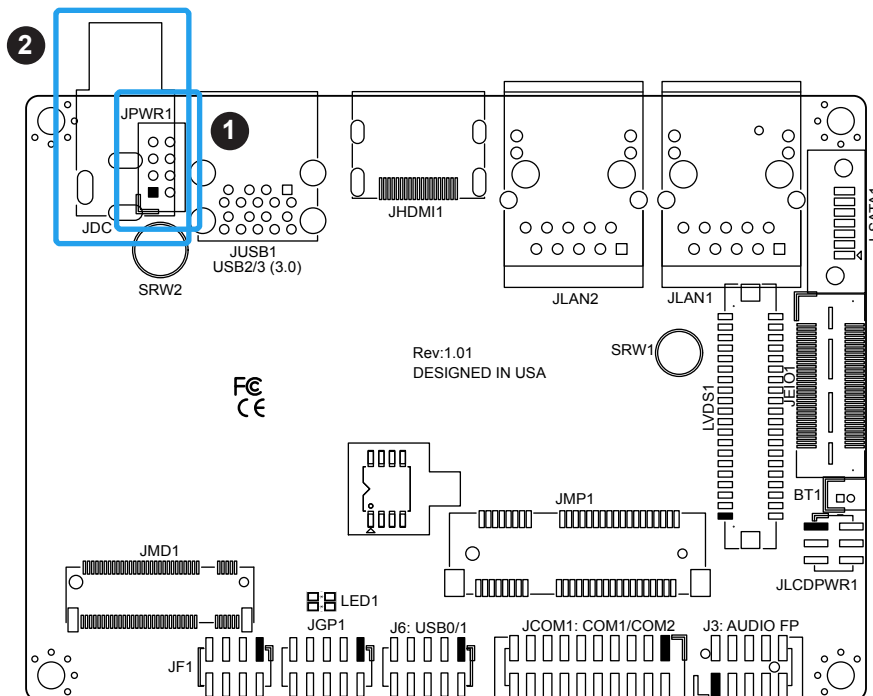

1. 12V DC Power (JPWR1: 2x4 pin box header)
2. 12V DC Jack (JDC: DC Jack)

Headers and Connectors

Front Panel Audio Header

A 10-pin front panel audio header located on the motherboard allows you to use the onboard sound for audio playback. Connect an audio cable to the this header to use this feature. Refer to the table below for pin definitions.

Audio Header Pin Definition			
Pin#	Definition	Pin#	Definition
1	MIC_Left	2	AUDIO_GND
3	MIC_Right	4	AUDIO_Detect
5	LINE2_Right	6	MIC2_JD
7	Front AUDIO_JD	8	NC
9	LINE2_Left	10	LINE2_JD

Battery Connector

BT1 is a two-pin connector for an external CMOS battery. Refer to Chapter 3 for battery installation instructions. This connector is also used to clear the CMOS. To clear the CMOS, remove the battery, short pins 1-2 for more than 10 seconds and then install the battery.

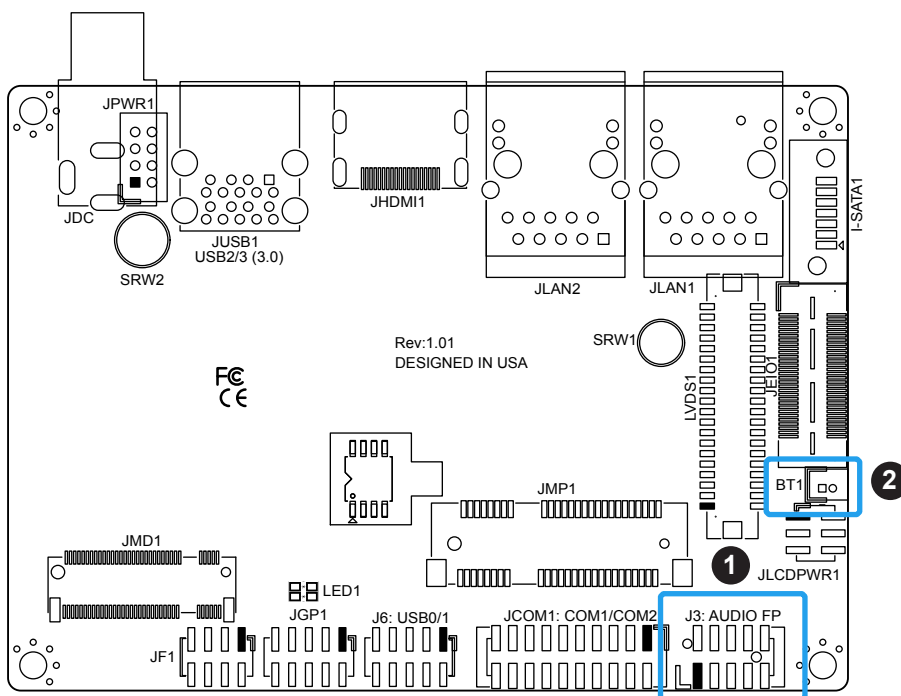

1. Audio Header
2. Battery connector

COM Headers

The JCOM1 header provides two RS232/422/485 COM connections. Refer to the table below for pin definitions. Refer to pins 1 - 10 for COM1 and pins 11 - 20 for COM2.

Serial COM Ports Pin Definition			
Pin#	Definition	Pin#	Definition
1	DCD or RS-485/422_COM1_TX- (Full Duplex) or RS-485_COM1_Data- (Half Duplex)	2	DSR
3	RXD or RS-485/422_COM1_TX+ (Full Duplex) or RS-485_COM1_Data+ (Half Duplex)	4	RTS
5	TXD or RS-485/422_COM1_RX+ (Full Duplex)	6	CTS
7	DTR or RS-485/422_COM1_RX- (Full Duplex)	8	RI_N
9	GND	10	N/A
11	DCD or RS-485/422_COM2_TX- (Full Duplex) or RS-485_COM2_Data- (Half Duplex)	12	DSR
13	RXD or RS-485/422_COM2_TX+ (Full Duplex) or RS-485_COM2_Data+ (Half Duplex)	14	RTS
15	TXD or RS-485/422_COM2_RX+ (Full Duplex)	16	CTS
17	DTR or RS-485/422_COM2_RX- (Full Duplex)	18	RI_N
19	GND	20	N/A

SATA Ports

The A2SAP-E/-L has one SATA 3.0 port (I-SATA1) that is supported by the Intel® Atom SoC. A2SAP-H doesn't have a SATA port (I-SATA1). The A2SAP-H SATA signal passes through the E/I/O (JEIO) connector.

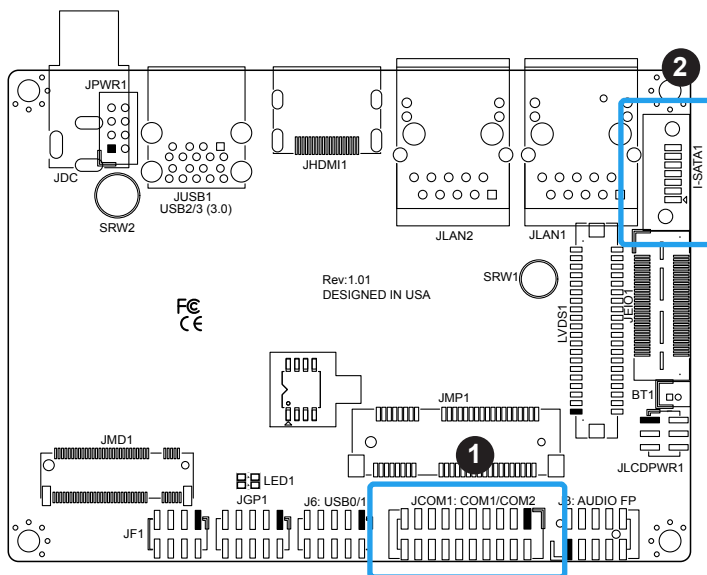

1. JCOM1
2. I-SATA1

LVDS Connector

LVDS1 is the LVDS connector. LVDS (low-voltage differential signaling) is a high-speed digital interface that operates at low power. It is a type of connection that is used with a LVDS LCD panel. The connector combines LCD VCC Power (pins 9-10), LVDS high speed digital interface, backlight power 3.3V (pin 7) and 12V (pins 1-5), backlight enable (pin 15), and dimming control (pin 13). Select the correct LCD VCC power according to the LCD specification by JLCDPWR1 (short pins 1-3 for 3.3V, short pins 3-5 for 5V) before enabling the LVDS panel. To choose the LCD VCC power, short JLCDPWR1 pins 1-3 for 3.3V or short pins 3-5 for 5V. Refer to the tables below for vendor part number, mating, and crimping contact connector information before making the LVDS/backlight cable.

LVDS Connector			
Connector	Vendor	Manufacture P/N	Description
Onboard LVDS Connector	HIROSE	DF13E-40DP-1.25V(51)	BOX HEADER, BOARD TO WIRE, 2X20, PITCH 1.25MM, VERT, 1A/PIN, WHITE, 0.2UM GOLD, PA9T, MATING HEIGHT 5.8MM
Mating Connector	HIROSE	DF13-40DS-1.25C	Headers and Wire Housings 1.25MM RECEPT HSNQ 40P DUAL ROW CRIMP
Crimping Contact Connector	HIROSE	DF13G-2630SCFA	Headers and Wire Housings SOCKET CONTACT/REEL AWG26-30

1. LVDS Connector

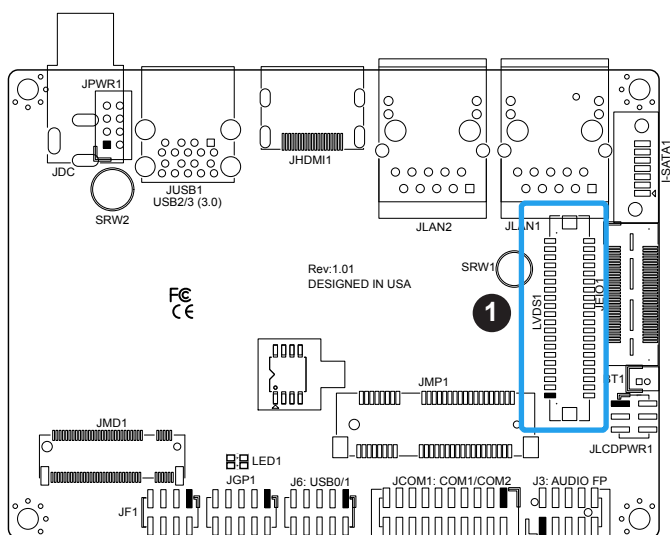

LVDS Connector Pin Definitions			
Pin#	Definition	Pin#	Definition
39	GND	40	GND
37	LVDSB D3N	38	LVDSB D3P
35	LVDSB CLKN	36	LVDSB CLKP
33	LVDSB D2N	34	LVDSB D2P
31	LVDSB D1N	32	LVDSB D1P
29	LVDSB D0N	30	LVDSB D0P
27	GND	28	GND
25	LVDSA D3N	26	LVDSA D3P
23	LVDSA CLKN	24	LVDSA CLKP
21	LVDSA D2N	22	LVDSA D2P
19	LVDSA D1N	20	LVDSA D1P
17	LVDSA D0N	18	LVDSA D0P
15	BKLTEN	16	GND
13	BKLTCTL	14	PVCCEN
11	DDC CLK	12	DDC DATA
9	LCDVCC	10	LCDVCC
7	3.3V	8	GND
5	12V	6	GND
3	12V	4	12V
1	12V	2	12V

General Purpose I/O Header

The JGP1 (General Purpose Input/Output) header is an 8-bit general purpose I/O expander on a pin header via the SMBus. Refer to the table below for pin definitions. The base address is 0xF040.

GPIO Header Pin Definition			
Pin#	Definition	Pin#	Definition
1	P3V3SB	2	GND
3	GP_P3V3_GP0	4	GP_P3V3_GP4
5	GP_P3V3_GP1	6	GP_P3V3_GP5
7	GP_P3V3_GP2	8	GP_P3V3_GP6
9	GP_P3V3_GP3	10	GP_P3V3_GP7

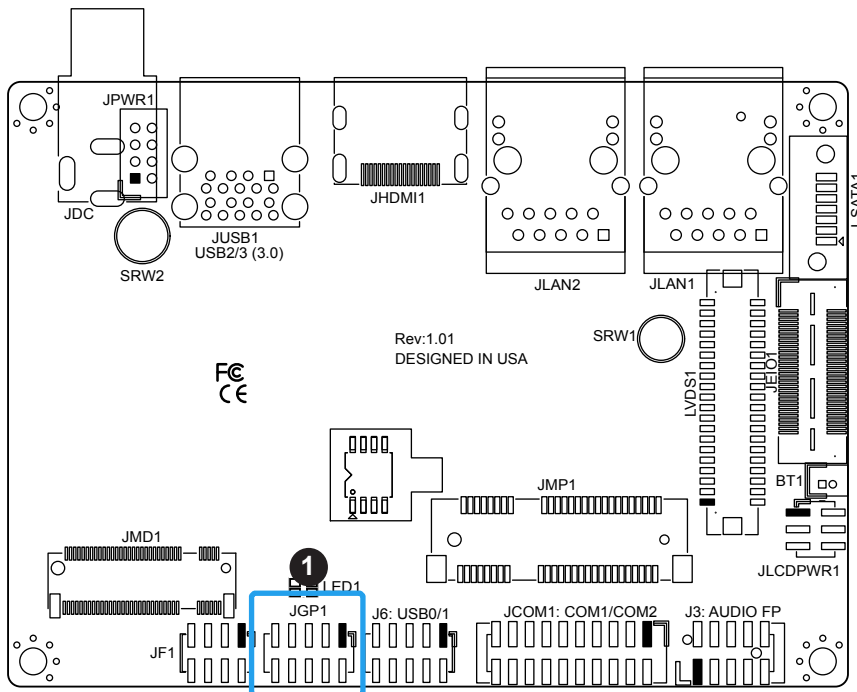

1. General Purpose Header

M.2 Slot

M.2 is formerly known as Next Generation Form Factor (NGFF) and is located at JMD1 on the motherboard. The M.2 slot is designed for internal mounting devices. The A2SAP-H/-E/-L motherboard deploys a B-KEY for SATA/PCI-E SSD devices or USB/PCI-E WWAN or GNSS card. The A2SAP-H/-E/-L deploys a 2242/3042 screw hole location for a 2242/3042 M.2 module.

1. General Purpose Header

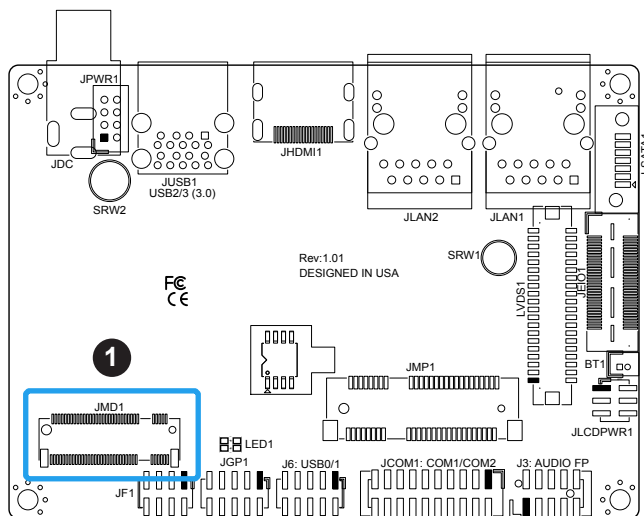

M.2 Slot Pin Definitions			
Pin#	Definition	Pin#	Definition
1	NC	2	P3V3SB
3	GND	4	P3V3SB
5	GND	6	FULL_CARD_POWER_OFF#(PU to P1V8SB only)
7	USB_D+	8	W_DISABLE1#(PU to P3V3SB only)
9	USB_D-	10	NC
11	GND	12	
13		14	
15		16	
17		18	
19		20	NC
21	NC	22	NC
23	WWAN_WAKE_N(PU to P1V8SB only)	24	NC
25	NC	26	RF_KILL_GPS_1P8_N(PU to P1V8SB only)
27	GND	28	NC
29	NC	30	NC
31	NC	32	NC
33	GND	34	NC
35	NC	36	NC
37	NC	38	DEVSLP (reserved)
39	GND	40	SMB_CLK (reserved)
41	PERn0/SATARX+	42	SMB_DATA (reserved)
43	PERp0/SATARX-	44	ALERT(PU to P1V8SB only)
45	GND	46	NC
47	PETn0/SATATX-	48	NC
49	PETn0/SATATX+	50	PERST (PLTRST)
51	GND	52	CLK_REQ_N
53	REFCLK-	54	PE_WAKE_N
55	REFCLK+	56	NC
57	GND	58	NC
59	NC	60	NC
61	NC	62	NC
63	NC	64	NC
65	NC	66	NC
67	NC	68	SYSClk (reserved)
69	PE_DET	70	P3V3SB
71	GND	72	P3V3SB
73	GND	74	P3V3SB
75	NC		

JEIO1

This E/I/O header provides flexibility support for the following functions: DP/HDMI, PCIe x2, two USB 2.0, LPC, SATA, SMBus, and Power, so that it allows customers to make their own I/O module to fit different kinds of vertical market I/O demands.

The A2SAP-E/-L does NOT support the SATA signal through the E/I/O header. The DP signal is supported through a requested BIOS update.

Functions
SATA
PCI Express
USB
LPC
SMBus
DDI
Power
Misc
GND

1. E/I/O Header

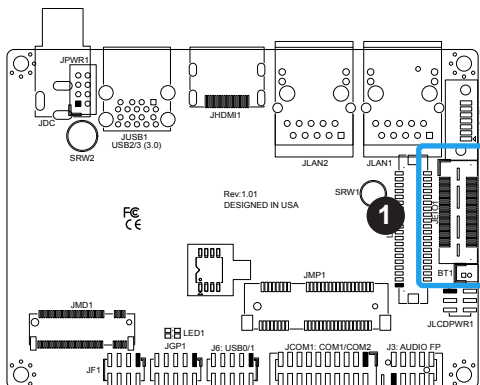

E/I/O Pin Definition					
Pin#	Definition		Pin#	Definition	
1	PCIE_EIO_RX_DP0	61 GND	2	PCIE_EIO_TX_DP0	
3	PCIE_EIO_RX_DN0		4	PCIE_EIO_TX_DN0	
5	GND		6	GND	
7	PCIE_EIO_RX_DP1		8	PCIE_EIO_TX_DP1	
9	PCIE_EIO_RX_DN1		10	PCIE_EIO_TX_DN0	
11	GND		12	GND	
13	CLK_100M_EIO_DP		14	USB_P5_DP	
15	CLK_100M_EIO_DN		16	USB_P5_DN	
17	GND		62 GND	18	USB_P4_DP
19	DDI1_TXP2			20	USB_P4_DN
21	DDI1_TXN2	22		GND	
23	GND	24		DDI1_TXP3	
25	DDI1_TXP1	26		DDI1_TXN3	
27	DDI1_TXN1	28		GND	
29	GND	30		DDI_HPDP	
31	DDI1_TXP0	32		SOC_WAKE_EIO_N	
33	DDI1_TXN0	63 GND		34	DDI1_DDC_P1V8_DAT
35	GND			36	DDI1_DDC_P1V8_CLK
37	DDI1_AUXP		38	SOC_SMB_CLK	
39	DDI1_AUXN		40	SOC_SMB_DAT	
41	P5VSB		42	P3VSB	
43	P5VSB		44	LPC_LFRAME_N	
45	P12VSB		46	LPC_AD3	
47	SOC_LPC_CLKOUT1		64 GND	48	LPC_AD2
49	PLTR_TPM_80PORT_N			50	LPC_AD1
51	LPC_SERIRQ			52	LPC_AD0
53	P3V3	54		P5V	
55	PS_ON_N	56		GND	
57	EIO_SATA_TXP0	58		EIO_SATA_RXN0	
59	EIO_SATA_TXN0	60		EIO_SATA_RXP0	

JEIO1 (continued)

The table below shows the E/I/O connector size, part numbers, and information for board-to-board stackable mating connector for a user's I/O module.

E/I/O Connector		
Connector	Size	Manufacture P/N
E/I/O Connector on A2SAP	0.5mm pitch, 60pin	Samtec P/N: QSH-030-01-L-D-A-K-TR)
Mating connector on I/O module	0.5mm pitch, 60pin 11mm height	Samtec P/N: QTH-030-03-L-D-A-K-TR
Mating connector on I/O module	0.5mm pitch, 60pin 16mm height	Samtec P/N: QTH-030-04-L-D-A-K-TR
Mating connector on I/O module	0.5mm pitch, 60pin 19mm height	Samtec P/N: QTH-030-05-L-D-A-K-TR

 **Note:** Contact the Sales department to obtain the board's 3D drawing to make your own E/I/O I/O module. Make sure the I/O module can be mechanically assembled on the A2SAP.

32-Pin Connector A (JF1 + JGP1 + J6) (A2SAP-H only)

A2SAP-H combines JF1, JGP1 and J6 into a 32-pin, 2.0mm pitch pin header, including the front panel (power/HDD LED, power/reset button), 8-bit GPIO, and two USB 2.0 connections. Refer to the table below for pin definitions and the female mating connector information. The distance between the board-to-board stack is 11mm in height while using the male pin header (PINREX P/N:225-97-16GBEW) to stack onto the female mating connector (PINREX P/N: 620-92-16GB00).

32-Pin Connector A				
Connector	P/N	Vendor	Manufacture P/N	Description
Male Pin Header on A2SAP-H	HDR-0208L-0000-PRX	PINREX	225-97-16GBEW	CNT, PIN/HEADER, 2X16 PIN, PITCH 2MM, VERT, 1A/PIN, BLACK, GF, NY6T, SMD, CM (-30 ~ 75C), ROHS
Female Mating Connector	HDR-0210L-0000-PRX	PINREX	620-92-16GB00	CNT, PIN FEMALE HEADER, 2X16 PIN, PITCH 2MM, VERT,1A/PIN, BLACK, GF, TL2.3MM, NY6T, DIP, EX (-40 ~ 105C), ROHS

32-Pin Connector A Pin Definitions						
Function	Pin#	Silkscreen Pin #	Definition	Pin#	Silkscreen Pin #	Definition
Two USB 2.0 (J6: USB0/1)	1	1	P5V_DUAL_F	2	2	P5V_DUAL_F
	3	3	USBCON_N0	4	4	USBCON_N1
	5	5	USBCON_P0	6	6	USBCON_P1
	7	7	GND	8	8	GND
	9	9	N/A	10	10	N/A
N/A	11	N/A	N/A	12	N/A	N/A
8-bit GPIO (JGP1)	13	1	P3V3SB	14	2	GND
	15	3	GPIO_1	16	4	GPIO_5
	17	5	GPIO_2	18	6	GPIO_6
	19	7	GPIO_3	20	8	GPIO_7
	21	9	GPIO_4	22	10	GPIO_8
N/A	23	N/A	N/A	24	N/A	N/A
Front Panel (JF1)	25	1	Power Button	26	2	GND
	27	3	Reset Button	28	4	GND
	29	5	3.3V	30	6	SATA HDD LED
	31	7	3.3Vstby	32	8	PWR LED

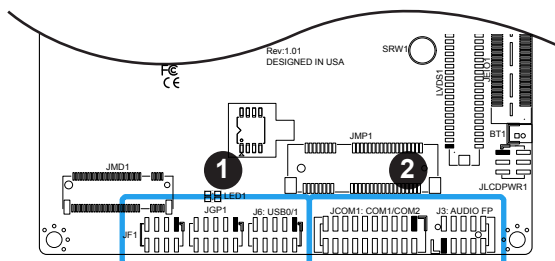

- 32-Pin Connector A
- 34-Pin Connector B (on the next page)

34-Pin Connector B (JCOM1 + J3) (A2SAP-H only)

A2SAP-H combines JCOM1 and J3 into a 34-pin, 2.0mm pitch pin header, including two RS-232/422/485 connections and an audio (Mic-in/Headphone-out) connection. Refer to the table below for pin definitions and the female mating connector information. The distance between board-to-board stack is 11mm in height while using male pin header (PINREX P/N:225-97-17GBEW) to stack onto female mating connector (PINREX P/N:620-92-17GB00).

34-Pin Connector B				
Connector	P/N	Vendor	Manufacture P/N	Description
Male Pin Header on A2SAP-H	HDR-0209L-0000-PRX	PINREX	225-97-17GBEW	CNT, PIN/HEADER, 2X17 PIN, PITCH 2MM, VERT, 1A/PIN, BLACK, GF, NY6T, SMD, CM (-30 ~ 75C), ROHS
Female Mating Connector on I/O Module	HDR-0211L-0000-PRX	PINREX	620-92-17GB00	CNT, PIN FEMALE HEADER, 2X17 PIN, PITCH 2MM, VERT, 1A/PIN, BLACK, GF, TL2.3MM, NY6T, DIP, EX (-40 ~ 105C), ROHS

34-Pin Connector B Pin Definitions						
Function	Pin#	Silkscreen Pin #	Definition	Pin#	Silkscreen Pin #	Definition
AUDIO (J3: Audio FP)	1	10	LINE2_JD	2	9	LINE2_Left
	3	8	NC	4	7	Front AUDIO_JD
	5	6	MIC2_JD	6	5	LINE2_Right
	7	4	AUDIO_Detect	8	3	MIC_Right
	9	2	AUDIO_GND	10	1	MIC_Left
N/A	11	N/A	N/A	12	N/A	N/A
N/A	13	N/A	N/A	14	N/A	N/A
Two RS-232/422/485 (JCOM1: COM1/ COM2)	15	1	DCD or RS-485/422_COM1_TX- (Full Duplex) or RS-485_COM1_Data- (Half Duplex)	16	2	DSR
	17	3	RXD or RS-485/422_COM1_TX- (Full Duplex) or RS-485_COM1_Data- (Half Duplex)	18	4	RTS
	19	5	TXD or RS-485/422_COM1_RX+ (Full Duplex)	20	6	CTS
	21	7	DTR or RS-485/422_COM1_RX- (Full Duplex)	22	8	RI_N
	23	9	GND	24	10	N/A
	25	11	DCD or RS-485/422_COM2_TX- (Full Duplex) or RS-485_COM2_Data- (Half Duplex)	26	12	DSR
	27	13	RXD or RS-485/422_COM2_TX+ (Full Duplex) or RS-485_COM2_Data+ (Half Duplex)	28	14	RTS
	29	15	TXD or RS-485/422_COM2_RX+ (Full Duplex)	30	16	CTS
	31	17	DTR or RS-485/422_COM2_RX- (Full Duplex)	32	18	RI_N
	33	19	GND	34	20	N/A

Mini PCI-E Slot

The Mini PCI-E slot, located at JMP1 on the bottom side of the motherboard, is used to install a compatible Mini PCI-E device. The Mini PCI-E slot supports modules which are USB or PCI-E x1 devices, such as wireless, GNSS, and Bluetooth modules. See the table below for pin definitions.

1. Mini PCI-E

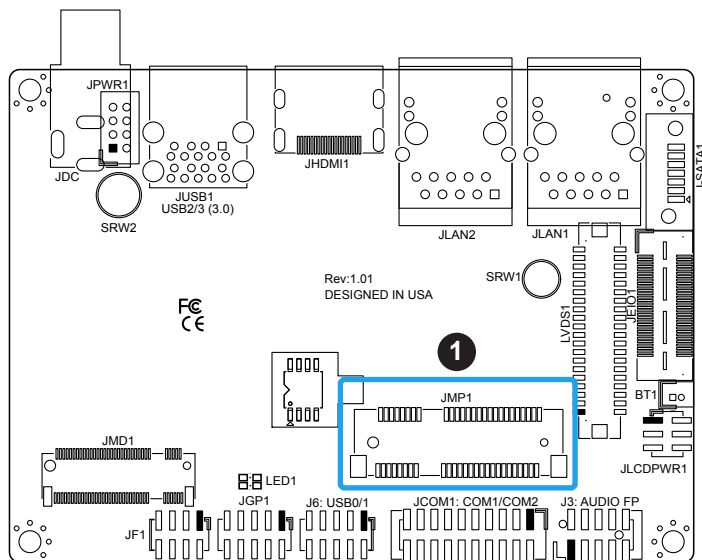

Mini PCI-E Pin Definition			
Pin#	Definition	Pin#	Definition
52	+3.3Vaux	51	NC
50	GND	49	NC
48	+1.5V	47	NC
46	NC	45	NC
44	NC	43	NC
42	NC	41	+3.3Vaux
40	GND	39	NC
38	USB_D+	37	GND
36	USB_D-	35	GND
34	GND	33	PETp0
32	SMB_DATA	31	PETn0
30	SMB_CLK	29	GND
28	+1.5V	27	GND
26	GND	25	PERp0
24	+3.3Vaux	23	PERn0
22	PERST#	21	DET_CARD_PLUG
20	NC	19	NC
18	GND	17	NC
16	NC	15	GND
14	NC	13	REFCLK+
12	NC	11	REFCLK-
10	NC	9	GND
8	NC	7	CLKREQ#
6	1.5V	5	NC
4	GND	3	NC
2	3.3Vaux	1	WAKE#

System Management Bus Header and SATA Power

A System Management Bus header for additional slave devices or sensors is located at JSMBUS1 on the bottom side of the motherboard. This header also serves as a 5V/1A SATA power box header. Refer to the table below for pin definitions.

 **Note:** The SATA power cable is included in the retail and bulk packages. The part number is CBL-PWEX-1030.

SMBus Header Pin Definition	
Pin#	Definition
1	SMB_CLK
2	SMB_DATA
3	GND
4	P5V

Bottom Layout

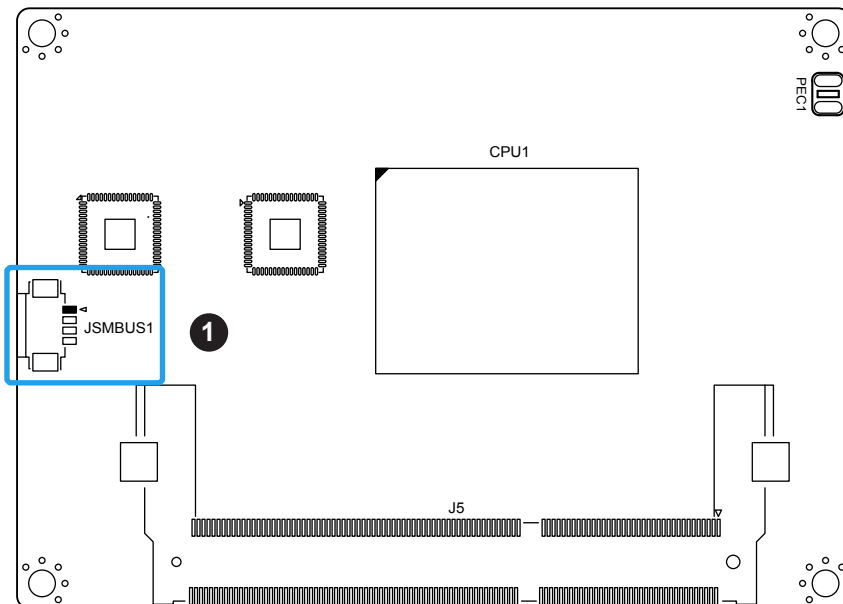

1. SMBus Header

2.7 Jumper Settings

How Jumpers Work

To modify the operation of the motherboard, jumpers can be used to choose between optional settings. Jumpers create shorts between two pins to change the function of the connector. Pin 1 is identified with a square solder pad on the printed circuit board. See the diagram below for an example of jumping pins 1 and 2. Refer to the motherboard layout page for jumper locations.

 **Note:** On two-pin jumpers, Closed means the jumper is on and Open means the jumper is off the pins.

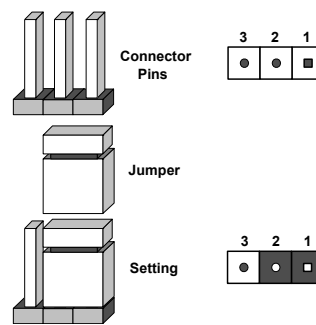

JLCDPWR1

LVDS VCC Power Source Selection

Use this jumper to select the power voltage for the LVDS panel. Make sure that the specifications of the cable is compatible with the panel to prevent damage. See the table below for jumper setting information.

Force power on

Use jumper JLCDPWR1 (Pins 2-4/4-6) to select the FORCE POWER ON function when the AC power cord is plugged in. When enabling force power on and AC power recovery, the system will boot up automatically without pressing the power button. See the table below for jumper setting information.

LVDS VCC Power Source Selection Jumper Settings	
Jumper Setting	Definition
Pins 1-3	3.3V (Default)
Pins 3-5	5V

FORCE POWER ON Jumper Settings	
Jumper Setting	Definition
Pins 2-4	FORCE POWER ON (Default) (when the AC power cord is plugged)
Pins 4-6	POWER BUTTON ON (when the AC power cord is plugged)

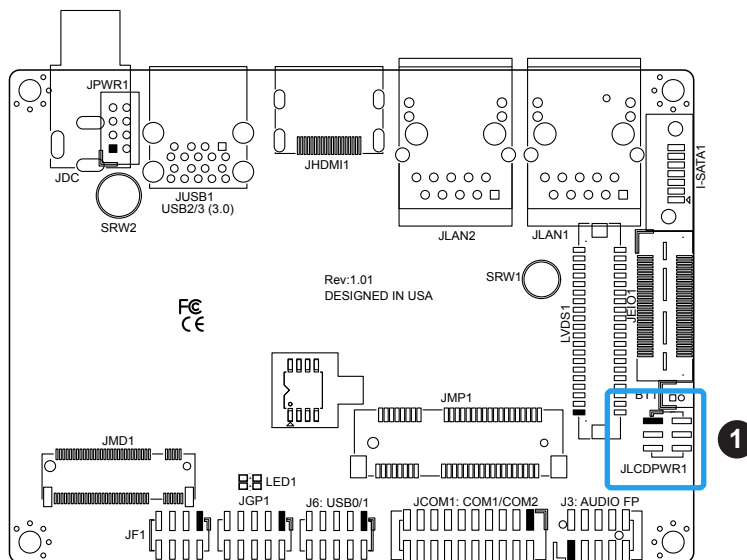

1. JLCDPWR1

2.8 LED Indicators

LAN Port LEDs

There are two LAN ports (JLAN1 and JLAN2) on the I/O back panel of the motherboard. Each Ethernet LAN port has two LEDs. The green LED indicates activity, while the other Link LED may be green, amber, or off to indicate the speed of the connection.

LAN1/2 LED (Connection Speed Indicator)	
LED Color	Definition
Off	10 Mb/s
Green	100 Mb/s
Amber	1 Gb/s

Power LED

LED1 is the Power LED. In S0 mode, this LED will be solid green. In S3/S4/S5 modes, this LED will be solid red.

Onboard Power LED Indicator	
LED Color	Definition
Off	System Off (power cable not connected)
Solid Green	S0 mode
Solid Red	S3/S4/S5 modes

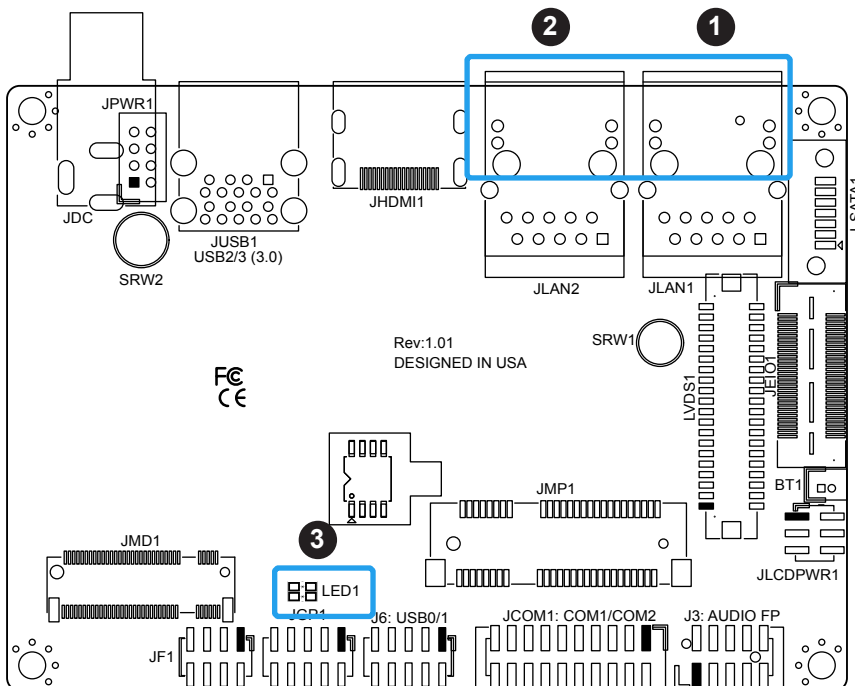

1. JLAN1 Port LED
2. JLAN2 Port LED
3. Power LED

Chapter 3

Troubleshooting

3.1 Troubleshooting Procedures

Use the following procedures to troubleshoot your system. If you have followed all of the procedures below and still need assistance, refer to the 'Technical Support Procedures' and/or 'Returning Merchandise for Service' section(s) in this chapter. Always disconnect the AC power cord before adding, changing or installing any non hot-swap hardware components.

Before Power On

1. Check that the power LED on the motherboard is on.
2. Make sure that the power connector is connected to your power supply.
3. Make sure that no short circuits exist between the motherboard and chassis.
4. Disconnect all cables from the motherboard, including those for the keyboard and mouse.
5. Remove all add-on cards.
6. Install a heatsink and connect the power to the motherboard. Make sure that the heatsink is fully seated. Check all jumper settings as well.
7. Use the correct type of CMOS battery (CR2032) as recommended by the manufacturer.

No Power

1. Make sure that no short circuits exist between the motherboard and the chassis.
2. Verify that all jumpers are set to their default positions.
3. Turn the power switch on and off to test the system.
4. The battery on your motherboard may be old. Check to verify that it still supplies ~3VDC. If it does not, replace it with a new one.

Memory Errors

1. Make sure that the DIMM modules are properly and fully installed.
2. Confirm that you are using the correct memory. Also, it is recommended that you use the same memory type and speed for all DIMMs in the system. [See Section 2.4 for memory details.](#)
3. Check for bad DIMM modules or slots by swapping modules between slots and noting the results.

Losing the System's Setup Configuration

1. Make sure that you are using a high quality power supply. A poor quality power supply may cause the system to lose the CMOS setup information. Refer to Section 1.5 for details on recommended power supplies.
2. The battery on your motherboard may be old. Check to verify that it still supplies ~3VDC. If it does not, replace it with a new one.
3. If the above steps do not fix the setup configuration problem, contact your vendor for repairs.

When the System Becomes Unstable

A. If the system becomes unstable during or after OS installation, check the following:

1. Memory support: Make sure that the memory modules are supported by testing the modules using memtest86 or a similar utility.



Note: Click on the Tested Memory List link on the motherboard product page to see a list of supported memory.

2. HDD support: Make sure that all hard disk drives (HDDs) work properly. Replace the bad HDDs with good ones.
3. Heatsink: Check that the heatsink is installed properly.
4. Adequate power supply: Make sure that the power supply provides adequate power to the system. Make sure that all power connectors are connected. Please refer to our website for more information on the minimum power requirements.
5. Proper software support: Make sure that the correct drivers are used.

B. If the system becomes unstable before or during OS installation, check the following:

1. Source of installation: Make sure that the devices used for installation are working properly, including boot devices such as CD/DVD and CD/DVD-ROM.
2. Cable connection: Check to make sure that all cables are connected and working properly.
3. Using the minimum configuration for troubleshooting: Remove all unnecessary components (starting with add-on cards first), and use the minimum configuration (but with a CPU and a memory module installed) to identify the trouble areas. Refer to the steps listed in Section A above for proper troubleshooting procedures.
4. Identifying bad components by isolating them: If necessary, remove a component in question from the chassis, and test it in isolation to make sure that it works properly. Replace a bad component with a good one.
5. Check and change one component at a time instead of changing several items at the same time. This will help isolate and identify the problem.
6. To find out if a component is good, swap this component with a new one to see if the system will work properly. If so, then the old component is bad. You can also install the component in question in another system. If the new system works, the component is good and the old system has problems.

3.2 Technical Support Procedures

Before contacting Technical Support, please take the following steps. Also, note that as a motherboard manufacturer, we do not sell directly to end-users, so it is best to first check with your distributor or reseller for troubleshooting services. They should know of any possible problem(s) with the specific system configuration that was sold to you.

1. Please review the 'Troubleshooting Procedures' and 'Frequently Asked Questions' (FAQs) sections in this chapter or see the FAQs on our website at <http://www.supermicro.com/FAQ/index.php> before contacting Technical Support.
2. BIOS upgrades can be downloaded from our website at http://www.supermicro.com/ResourceApps/BIOS_IPMI_Intel.html. **Note:** Not all BIOS can be flashed depending on the modifications to the boot block code.
3. If you still cannot resolve the problem, include the following information when contacting us for technical support:
 - Motherboard model and PCB revision number
 - BIOS release date/version (this can be seen on the initial display when your system first boots up)
 - System configuration

An example of a Technical Support form is posted on our website.

Distributors: For immediate assistance, please have your account number ready when contacting our technical support department by e-mail.

3.3 Frequently Asked Questions

Question: What type of memory does my motherboard support?

Answer: The A2SAP-H/-E/-L motherboard supports up to 8GB of DDR3L 1867MHz Non-ECC SO-DIMM. See Section 2.3 for details on installing memory.

Question: How do I update my BIOS?

Answer: It is recommended that you **do not** upgrade your BIOS if you are not experiencing any problems with your system. Updated BIOS files are located on our website at http://www.supermicro.com/ResourceApps/BIOS_IPMI_Intel.html. Please check our BIOS warning message and the information on how to update your BIOS on our website. Select your motherboard model and download the BIOS file to your computer. Also, check the current BIOS revision to make sure that it is newer than your BIOS before downloading.

Follow the steps below to update the BIOS:

1. Save this BIOS update package to your computer.
2. Extract the files to a USB stick. The USB stick doesn't have to be bootable, but it has to be formatted with the FAT/FAT32 file system.
3. Plug the USB stick into a USB port, boot to the Build-In UEFI Shell, and type FLASH.
nsh BIOSname#.### to start the BIOS update:
 - Shell> fs0:
 - fs0:\> flash.nsh A2SAP#.###
4. Do not interrupt the process until the BIOS update is complete.
5. When a message indicates that the BIOS update is complete, do the A/C power cycle.
6. Go to the BIOS setup screen and press F3 to load the default and then press F4 to save and exit.

Question: Why can't I turn off the power using the momentary power on/off switch?

Answer: The instant power off function is controlled in BIOS by the Power Button Mode setting. When the On/Off feature is enabled, the motherboard will have instant off capabilities as long as the BIOS has control of the system. When the Standby or Suspend feature is enabled or when the BIOS is not in control such as during memory count (the first screen that appears when the system is turned on), the momentary on/off switch must be held for more than four seconds to shut down the system. This feature is required to implement the ACPI features on the motherboard.

3.4 Battery Removal and Installation

Battery Removal

To remove the battery, follow the steps below:

1. Power off your system and unplug your power cable.
2. Remove the battery cable at the BT1 connector on the board.
3. Remove the battery.

Proper Battery Disposal

Please handle used batteries carefully. Do not damage the battery in any way; a damaged battery may release hazardous materials into the environment. Do not discard a used battery in the garbage or a public landfill. Please comply with the regulations set up by your local hazardous waste management agency to dispose of your used battery properly.

Battery Installation

1. Unplug the power cord.
2. Connect the battery cable into the battery connector (BT1) and push it down until you hear a click to ensure that the cable is securely locked.
3. Use the foam tape on the back side of the battery to secure the battery to a flat surface on the bottom of the motherboard or a proper location in the system. **DO NOT** place the battery on the heatsink.

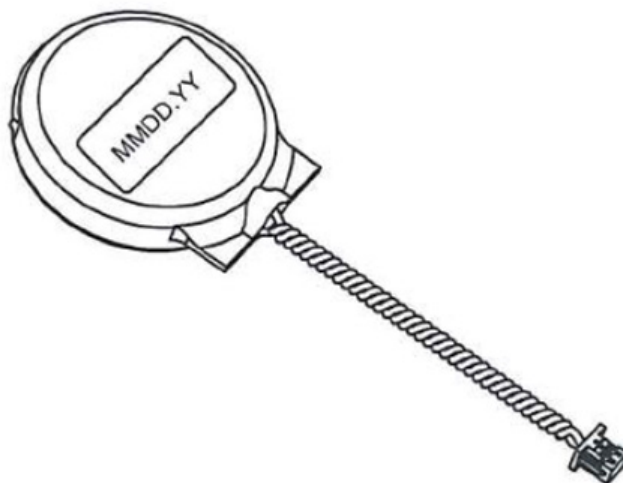

3.5 Returning Merchandise for Service

A receipt or copy of your invoice marked with the date of purchase is required before any warranty service will be rendered. You can obtain service by calling your vendor for a Returned Merchandise Authorization (RMA) number. When returning to the manufacturer, the RMA number should be prominently displayed on the outside of the shipping carton and mailed prepaid or hand-carried. Shipping and handling charges will be applied for all orders that must be mailed when service is complete.

For faster service, RMA authorizations may be requested online (<http://www.supermicro.com/support/rma/>).

This warranty only covers normal consumer use and does not cover damages incurred in shipping or from failure due to the alteration, misuse, abuse or improper maintenance of products.

During the warranty period, contact your distributor first for any product problems.

Chapter 4

UEFI BIOS

4.1 Introduction

This chapter describes the AMIBIOS™ Setup utility for the A2SAP-E motherboard. The BIOS is stored on a chip and can be easily upgraded using a flash program.

 **Note:** Due to periodic changes to the BIOS, some settings may have been added or deleted and might not yet be recorded in this manual. Please refer to the Manual Download area of our website for any changes to the BIOS that may not be reflected in this manual.

Starting the Setup Utility

To enter the BIOS Setup Utility, hit the <Delete> key while the system is booting up. In most cases, the <Delete> key is used to invoke the BIOS setup screen. There are a few cases when other keys are used, such as <F1>, <F2>, etc.) Each main BIOS menu option is described in this manual.

The Main BIOS screen has two main frames. The left frame displays all the options that can be configured. “Grayed-out” options cannot be configured. The right frame displays the key legend. Above the key legend is an area reserved for a text message. When an option is selected in the left frame, it is highlighted in white. Often a text message will accompany it. (Note that BIOS has default text messages built in. We retain the option to include, omit, or change any of these text messages.) Settings printed in **Bold** are the default values.

A " ►" indicates a submenu. Highlighting such an item and pressing the <Enter> key will open the list of settings within that submenu.

The BIOS setup utility uses a key-based navigation system called hot keys. Most of these hot keys (<F1>, <F10>, <Enter>, <ESC>, <Arrow> keys, etc.) can be used at any time during the setup navigation process.

4.2 Main Setup

When you first enter the AMI BIOS setup utility, you will enter the Main setup screen. You can always return to the Main setup screen by selecting the Main tab on the top of the screen. The Main BIOS setup screen is shown below. The following Main menu items will be displayed:



System Date/System Time

Use this option to change the system date and time. Highlight *System Date* or *System Time* using the arrow keys. Enter new values using the keyboard. Press the <Tab> key or the arrow keys to move between fields. The date must be entered in MM/DD/YYYY format. The time is entered in HH:MM:SS format.



Note: The time is in the 24-hour format. For example, 5:30 P.M. appears as 17:30:00.

A2SAP-E

BIOS Version

Build Date

Memory Information

Total Memory: This displays the total size of memory available in the system.

Memory Speed: This displays the memory speed.

MRC Version

TXE FW

GOP

4.3 Advanced

Use this menu to configure Advanced settings.

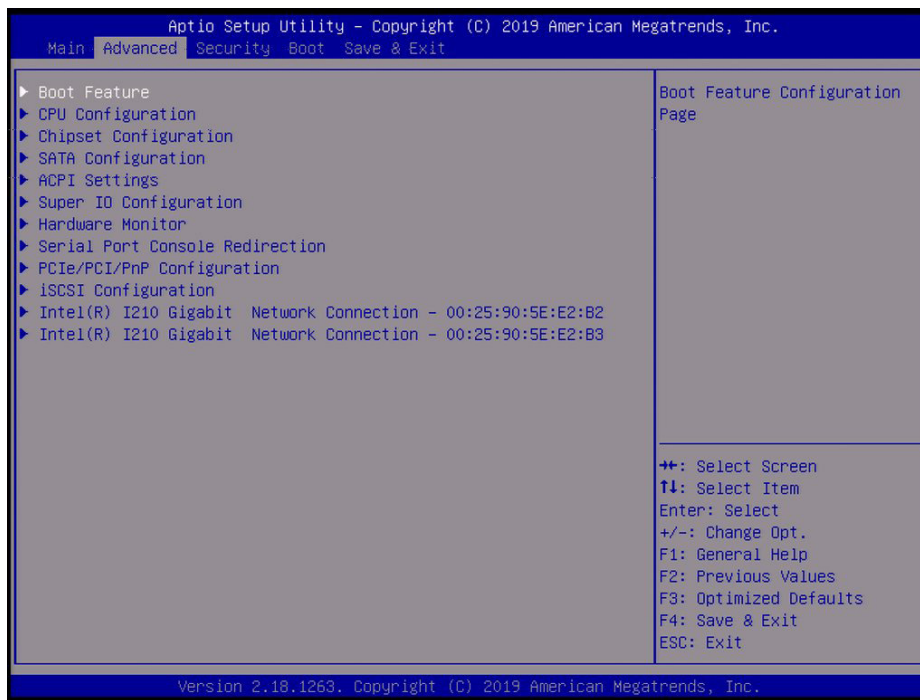

Warning: Take caution when changing the Advanced settings. An incorrect value, a very high DRAM frequency or an incorrect BIOS timing setting may cause the system to malfunction. When this occurs, restore the setting to the manufacture default setting.

► Boot Feature

Quiet Boot

Use this feature to select the screen display between POST messages or the OEM logo at bootup. Select Disabled to display the POST messages. Select Enabled to display the OEM logo instead of the normal POST messages. The options are Disabled and **Enabled**.

AddOn ROM Display Mode

This feature sets the display mode for the Option ROM. Select Keep Current to use the current AddOn ROM display setting. Select Force BIOS to use the Option ROM display mode set by the system BIOS. The options are **Force BIOS** and Keep Current.

Bootup NumLock State

This feature selects the Power-on state for the Numlock key. The options are Off and **On**.

Wait For "F1" If Error

This feature forces the system to wait until the F1 key is pressed if an error occurs. The options are Disabled and **Enabled**.

INT19 Trap Response

Interrupt 19 is the software interrupt that handles the boot disk function. When this item is set to Immediate, the ROM BIOS of the host adaptors will "capture" Interrupt 19 at bootup immediately and allow the drives that are attached to these host adaptors to function as bootable disks. If this item is set to Postponed, the ROM BIOS of the host adaptors will not capture Interrupt 19 immediately and allow the drives attached to these adaptors to function as bootable devices at bootup. The options are **Immediate** and Postponed.

Re-try Boot

If this item is enabled, the BIOS will automatically reboot the system from a specified boot device after its initial boot failure. The options are **Disabled** and EFI Boot.

Power Configuration**Watch Dog Function**

If enabled, the Watch Dog timer will allow the system to reboot when it is inactive for more than 5 minutes. The options are **Disabled** and Enabled.

Power Button Function

This feature controls how the system shuts down when the power button is pressed. Select 4 Seconds Override for the user to power off the system after pressing and holding the power button for 4 seconds or longer. Select Instant Off to instantly power off the system as soon as the user presses the power button. The options are **Instant Off** and 4 Seconds Override.

Restore on AC Power Loss

Use this feature to set the power state after a power outage. Select Power Off for the system power to remain off after a power loss. Select Power On for the system power to be turned on after a power loss. Select Last State to allow the system to resume its last power state before a power loss. The options are Stay Off, Power on, and **Last State**.

► CPU Configuration

The following CPU information will display:

- CPU model
- CPU Signature
- Microcode Patch
- Max CPU Speed
- Min CPU Speed
- Processor Cores
- Intel HT Technology
- Intel VT-x Technology
- L1 Data Cache
- L1 Code Cache
- L2 Cache
- L3 Cache
- Speed
- 64-bit

► CPU Power Management

EIST

EIST (Enhanced Intel SpeedStep Technology) allows the system to automatically adjust processor voltage and core frequency to reduce power consumption and heat dissipation. The options are Disabled and **Enabled**.

Turbo Mode

Select Enabled for processor cores to run faster than the frequency specified by the manufacturer. The options are Disabled and **Enabled**.

Boot performance mode

This feature allows the user to select the performance state that the BIOS will set before the operating system handoff. The options are **Max Performance** and Max Power Saving.

Power Limit 1 Enable

Use this feature to set the power limit for the CPU. The options are Disabled and **Enabled**.

Power Limit 1**Power Limit 1 Clamp Mode**

Use this feature to set the PL1 clamp bit. The options are Disabled and **Enabled**.

Power Limit 1 Power

Use this item to configure the value for Power Limit 1. The value is in milli watts and the step size is 125mW. Use the number keys on your keyboard to enter the value. Enter **Auto** to use the manufacture default setting.

Power Limit 1 Time Window

Use this feature to indicate the time window over which the TDP value should be maintained. The options are **Auto**, 1, 2, 3, 4, 5, 6, 7, 8, 10, 12, 14, 16, 20, 24, 28, 32, 40, 48, 56, 64, 80, 96, 112, and 128.

Active Processor Cores

This feature determines how many CPU cores will be activated for each CPU. When Enabled is selected, all cores in the CPU will be activated. Please refer to Intel's website for more information. The options are **Disabled** and Enabled.

****If Active Processor Cores is set to Enabled, Core 0 - Core 1 will be available for configuration:***

Core 0

This feature is set to Enabled.

Core 1/Core 2/Core 3

Use this feature to enable or disable the CPU core. The options are Disabled and **Enabled**.

Intel® Virtualization Technology

Select Enable to use Intel Virtualization Technology to allow one platform to run multiple operating systems and applications in independent partitions, creating multiple virtual systems in one physical computer. The options are Disabled and **Enabled**.

VT-d

Select Enabled to enable Intel Virtualization Technology support for Direct I/O VT-d by reporting the I/O device assignments to VMM through the DMAR ACPI Tables. This feature offers fully-protected I/O resource-sharing across the Intel platforms, providing the user with greater reliability, security and availability in networking and data-sharing. The options are **Disabled** and Enabled.

Monitor Mwait

Select Enabled to enable the Monitor/Mwait instructions. The Monitor instructions monitors a region of memory for writes, and MWait instructions instruct the CPU to stop until the monitored region begins to write. The options are **Disabled** and Enabled.

P-STATE Coordination

This feature allows the user to change the P-State (Power-Performance State) coordination type. P-State is also known as "SpeedStep" for Intel processors. Select HW_ALL to change the P-State coordination type for hardware components only. Select SW_ALL to change the P-State coordination type for all software installed in the system. Select SW_ANY to change the P-State coordination type for a software program in the system. The options are **HW_All**, SW_ALL, and SW_ANY.

► Chipset

Warning: Setting the wrong values in the following sections may cause the system to malfunction.

► North Bridge

Memory Information

Memory Slot0

► Graphics Configuration

GOP Driver

The Graphics Output Protocol (GOP) driver is a replacement for legacy video BIOS that accesses UEFI protocols. The options are **Enable** and Disable.

LVDS Panel Support

Use this feature to select the supported IGFX graphics device output to the LVDS panel. The options are **Disabled** and Enable.

****If LVDS Panel Support is Enabled, the five features below are available for configuration:***

Panel select

Use this feature to select the panel resolution. The options are **Use EDID in SPI ROM**, 800x600, 1024x768, 1280x1024, 1366x768, 1680x1050, 1920x1080, and OEM Define.

Panel Channel Type

Use this feature to select the Panel Channel Type. The options are **Disabled**, Odd Channel, Even Channel, and Both Channel.

Dual LVDS mode

Use this feature to select a single or dual mode bus for the LVDS display. The options are **Disabled**, Single LVDS Bus Mode, and Dual LVDS Bus Mode.

Panel Color Depth

Use this feature to select the panel color depth. The options are **Disabled**, VESA and JEIDA18 bpp, VESA 24 bpp, and JEIDA 24 bpp.

Backlight Brightness

Use this feature to select the backlight brightness for the panel display. Select a range from 1 to 16.

IGD Configuration**Integrate Graphics Device**

When this feature is enabled, the onboard graphics device will be used as the primary video display. The options are Disable and **Enable**.

Primary Display

Use this feature to select the primary video display. The options are **IGD** and PCIe.

RC6 (Render Standby)

Select Enabled to enable render standby support. This is a power saving feature for the onboard display that reduces power consumption. The options are Disable and **Enable**.

GTT Size

Use this feature to set the memory size to be used by the graphics translation table (GTT). The options are 2MB, 4MB, and **8MB**.

Aperture Size

Use this feature to set the Aperture size, which is the size of system memory reserved by the BIOS for graphics device use. The default option is **256MB**.

DVMT Pre-Allocated

Dynamic Video Memory Technology (DVMT) allows dynamic allocation of system memory to be used for video devices to ensure best use of available system memory based on the DVMT 5.0 platform. The options are **64M**, 96M, 128M, 160M, 192M, 224M, 256M, 288M, 320M, 352M, 384M, 416M, 448M, 480M, and 512M.

DVMT Total Gfx Mem

Use this feature to set the total memory size to be used by internal graphics devices based on the DVMT 5.0 platform. The options are 128MB, **256MB**, and MAX.

GT PM Support

Use this feature to enable the IGFX Power Management function. The options are **Enable** and **Disable**.

PAVP Enable

Protected Audio Video Path (PAVP) decodes Intel integrated graphics encrypted video. The options are **Enable** and **Disable**.

Max TOLUD

This feature sets the maximum TOLUD value, which specifies the "Top of Low Usable DRAM" memory space to be used by internal graphics devices, GTT Stolen Memory, and TSEG, respectively, if these devices are enabled. The options are **2 GB**, 2.25 GB, 2.5 GB, 2.75 GB, and 3 GB.

► South Bridge

► HD Audio Configuration

HD-Audio Configuration

HD-Audio Support

Use this feature to enable high-definition audio support. The options are **Disable** and **Enable**.

► PCI Express Configuration

Advanced Error Reporting

Select **Enabled** to enable the ACPI OS to manage PCI Advanced Error Reporting. The options are **Disable** and **Enable**.

► JMD1 M.2

ASPM

Use this feature to set the Active State Power Management (ASPM) level for a PCI-E device. Select **Auto** for the system BIOS to automatically set the ASPM level based on the system configuration. Select **Disabled** to disable ASPM support. The options are **Disable**, **L0s**, **L1**, **L0sL1**, and **Auto**.

PCIe Speed

Use this feature to select the PCI speed for the device installed in the M.2 slot. The options are **Auto**, Gen1, and Gen2.

►Intel I210 Gigabit LAN**ASPM**

Use this feature to set the Active State Power Management (ASPM) level for a PCI-E device. Select Auto for the system BIOS to automatically set the ASPM level based on the system configuration. Select Disabled to disable ASPM support. The options are Disable, L0s, L1, L0sL1, and **Auto**.

PCIe Speed

Use this feature to select the PCI speed for the device installed in the slot. The options are **Auto**, Gen1, and Gen2.

►Intel I210 Gigabit LAN**ASPM**

Use this feature to set the Active State Power Management (ASPM) level for a PCI-E device. Select Auto for the system BIOS to automatically set the ASPM level based on the system configuration. Select Disabled to disable ASPM support. The options are Disable, L0s, L1, L0sL1, and **Auto**.

PCIe Speed

Use this feature to select the PCI speed for the device installed in the slot. The options are **Auto**, Gen1, and Gen2.

►Mini PCIe**ASPM**

Use this feature to set the Active State Power Management (ASPM) level for a PCI-E device. Select Auto for the system BIOS to automatically set the ASPM level based on the system configuration. Select Disabled to disable ASPM support. The options are **Disable**, L0s, L1, L0sL1, and Auto.

PCIe Speed

Use this feature to select the PCI speed for the device installed in the slot. The options are **Auto**, Gen1, and Gen2.

► USB Configuration

USB3.0 Support

Select Enable for USB 3.0 support. The options are **Enable** and Disable.

XHCI Pre-Boot Driver

Select Enabled to enable XHCI (Extensible Host Controller Interface) support on a pre-boot drive specified by the user. The options are Enable and **Disable**.

XHCI Hand-Off

This is a work-around solution for operating systems that do not support XHCI (Extensible Host Controller Interface) hand-off. The XHCI ownership change should be claimed by the XHCI driver. The settings are **Enabled** and Disabled.

USB Mass Storage Driver Support

Select Enabled for USB mass storage device support. The options are Disabled and **Enabled**.

► SATA Configuration

Chipset SATA

This feature enables or disables the onboard SATA controller supported by the SoC. The options are **Enable** and Disable.

SATA Mode Selection

Use this feature to select the mode for the installed SATA drives. The default is **AHCI**.

Aggressive LPM (Link Power Management) Support

When this feature is set to Enabled, the SATA AHCI controller manages the power usage of the SATA link. The controller will put the link in a low power mode during extended periods of I/O inactivity, and will return the link to an active state when I/O activity resumes. The options are **Enabled** and Disabled.

SATA Frozen

Use this feature to enable the HDD Security Frozen Mode. The options are **Disabled** and Enabled.

I-SATA1

I-SATA1 Hot Plug

This feature designates the SATA port specified for hot plugging. Set this feature to Enabled for hot-plugging support, which will allow the user to replace a SATA drive without shutting down the system. The options are **Enabled** and Disabled.

Spin Up Device

When the value of an edge detect or the value of an image binary (pixel) of a device is from 0 to 1, select Enabled to allow the PCH to start a COMRESET initialization sequence on this device. The options are Enabled and **Disabled**.

SATA Device Type

Use this feature to specify if the SATA port specified by the user is connected to a Solid State drive or a Hard Disk Drive. The options are **Hard Disk Drive** and Solid State Drive.

I-SATA1 DevSlp

DEVSLP is a signal that is sent to a SATA disk drive to tell it to enter a very low power state. The options are **Disabled** and Enabled.

M.2 SATA

M.2 SATA Hot Plug

This feature designates the SATA port specified for hot plugging. Set this feature to Enabled for hot-plugging support, which will allow the user to replace a SATA drive without shutting down the system. The options are **Enabled** and Disabled.

Spin Up Device

When the value of an edge detect or the value of an image binary (pixel) of a device is from 0 to 1, select Enabled to allow the PCH to start a COMRESET initialization sequence on this device. The options are Enabled and **Disabled**.

SATA Device Type

Use this feature to specify if the SATA port specified by the user is connected to a Solid State drive or a Hard Disk Drive. The options are **Hard Disk Drive** and Solid State Drive.

M.2 SATA DevSlp

DEVSLP is a signal that is sent to a SATA disk drive to tell it to enter a very low power state. The options are **Disabled** and Enabled.

►ACPI Settings

ACPI Sleep State

Use this feature to select which sleep state mode the system will enter when the Suspend button is pressed. The options are Suspend Disabled and **S3 (Suspend to RAM)**.

High Precision Timer

Select Enabled to activate the High Performance Event Timer (HPET) that produces periodic interrupts at a much higher frequency than a Real-time Clock (RTC) does in synchronizing multimedia streams, providing smooth playback and reducing the dependency on other timestamp calculation devices, such as an x86 RDTSC Instruction embedded in the CPU. The High Performance Event Timer is used to replace the 8254 Programmable Interval Timer. The options are Disable and **Enable**.

Headless Support

Enable this feature for the system to function without a keyboard, monitor, or mouse attached. The options are **Disabled** and Enabled.

► Super IO Configuration

Super IO Chip NCT5523D

► Serial Port 1 Configuration

Serial Port

Select Enabled to enable the onboard serial port specified by the user. The options are Disabled and **Enabled**.

Device Settings

This feature displays the base I/O port address and the Interrupt Request address of a serial port specified by the user.

Change Settings

This feature specifies the base I/O port address and the Interrupt Request address of Serial Port 1. Select Auto to allow the BIOS to automatically assign the base I/O and IRQ address to a serial port specified. The options are **Auto**, (IO=3F8h; IRQ=4), (IO=3F8h; IRQ=3, 4, 5, 6, 7, 9, 10, 11, 12), (IO=2F8h; IRQ=3, 4, 5, 6, 7, 9, 10, 11, 12), (IO=3E8h; IRQ=3, 4, 5, 6, 7, 9, 10, 11, 12), and (IO=2E8h; IRQ=3, 4, 5, 6, 7, 9, 10, 11, 12).

COM Port Mode

Use this feature to select the COM port mode. The options are **RS232 Mode**, RS422 Mode/RS485 Full Duplex Mode, and RS485 Half Duplex Mode.

Baud Rate from different PRE-DIVIDER

Use this feature to select the Baud rate frequency. The options are **PRE-DIV: 13, 1.8461M Hz**, PRE-DIV: 12, 2M Hz, PRE-DIV: 1, 24M Hz, and PRE-DIV: 1.625, 14.769M Hz.

► Serial Port 2 Configuration

Serial Port

Select Enabled to enable the onboard serial port specified by the user. The options are Disabled and **Enabled**

Device Settings

This feature displays the base I/O port address and the Interrupt Request address of a serial port specified by the user.

Change Port Settings

This feature specifies the base I/O port address and the Interrupt Request address of Serial Port 2. Select Auto to allow the BIOS to automatically assign the base I/O and IRQ address to a serial port specified. The options are **Auto**, (IO=2F8h; IRQ=3), (IO=3F8h; IRQ=3, 4, 5, 6, 7, 9, 10, 11, 12), (IO=2F8h; IRQ=3, 4, 5, 6, 7, 9, 10, 11, 12), (IO=3E8h; IRQ=3, 4, 5, 6, 7, 9, 10, 11, 12), and (IO=2E8h; IRQ=3, 4, 5, 6, 7, 9, 10, 11, 12).

COM Port Mode

Use this item to select the COM port mode. The options are **RS232 Mode**, RS422 Mode/RS485 Full Duplex Mode, and RS485 Half Duplex Mode.

Baud Rate from different PRE-DIVIDER

Use this feature to select the Baud rate frequency. The options are **PRE-DIV: 13, 1.8461M Hz**, PRE-DIV: 12, 2M Hz, PRE-DIV: 1, 24M Hz, and PRE-DIV: 1.625, 14.769M Hz.

► Hardware Monitor

PC Health Status

- Peripheral temperature
- System temperature
- VCORE
- VDIMM
- 3VCC
- 3VSB
- VBAT
- AVSB

► Serial Port Console Redirection

COM1 Console Redirection

Select Enabled to enable console redirection support for a serial port specified by the user. The options are **Enabled** and Disabled.

**If the feature above is Enabled, the following items will be available for configuration:*

► COM1 Console Redirection Settings

This feature allows the user to specify how the host computer will exchange data with the client computer, which is the remote computer used by the user.

COM1 Terminal Type

This feature allows the user to select the target terminal emulation type for Console Redirection. Select VT100 to use the ASCII Character set. Select VT100+ to add color and function key support. Select ANSI to use the Extended ASCII Character Set. Select VT-UTF8 to use UTF8 encoding to map Unicode characters into one or more bytes. The options are VT100, **VT100+**, VT-UTF8, and ANSI.

COM1 Bits per second

Use this feature to set the transmission speed for a serial port used in Console Redirection. Make sure that the same speed is used in the host computer and the client computer. A lower transmission speed may be required for long and busy lines. The options are 9600, 19200, 38400, 57600, and **115200** (bits per second).

COM1 Data Bits

Use this feature to set the data transmission size for Console Redirection. The options are 7 and **8**.

COM1 Parity

A parity bit can be sent along with regular data bits to detect data transmission errors. Select Even if the parity bit is set to 0, and the number of 1's in data bits is even. Select Odd if the parity bit is set to 0, and the number of 1's in data bits is odd. Select None if you do not want to send a parity bit with your data bits in transmission. Select Mark to add a mark as a parity bit to be sent along with the data bits. Select Space to add a Space as a parity bit to be sent with your data bits. The options are **None**, Even, Odd, Mark, and Space.

COM1 Stop Bits

A stop bit indicates the end of a serial data packet. Select 1 Stop Bit for standard serial data communication. Select 2 Stop Bits if slower devices are used. The options are **1** and 2.

COM1 Flow Control

Use this feature to set the flow control for Console Redirection to prevent data loss caused by buffer overflow. Send a Stop signal to stop sending data when the receiving buffer is full. Send a Start signal to start sending data when the receiving buffer is empty. The options are **None** and Hardware RTS/CTS.

COM1 VT-UTF8 Combo Key Support

Select Enabled to enable VT-UTF8 Combination Key support for ANSI/VT100 terminals. The options are Disabled and **Enabled**.

COM1 Recorder Mode

Select Enabled to capture the data displayed on a terminal and send it as text messages to a remote server. The options are **Disabled** and Enabled.

COM1 Resolution 100x31

Select Enabled for extended-terminal resolution support. The options are Disabled and **Enabled**.

COM1 Legacy OS Redirection Resolution

Use this feature to select the number of rows and columns used in Console Redirection for legacy OS support. The options are 80x24 and **80x25**.

COM1 Putty KeyPad

This feature selects the settings for Function Keys and KeyPad used for Putty, which is a terminal emulator designed for the Windows OS. The options are **VT100**, LINUX, XTERMR6, SC0, ESCN, and VT400.

COM1 Redirection After BIOS POST

Use this feature to enable or disable legacy console redirection after BIOS POST. When set to Bootloader, legacy console redirection is disabled before booting the OS. When set to Always Enable, legacy console redirection remains enabled when booting the OS. The options are **Always Enable** and Bootloader.

COM2 Console Redirection

Select Enabled to use the SOL port for Console Redirection. The options are Disabled and **Enabled**.

****If the feature above is Enabled, the following features will be available for configuration:***

► COM2 Console Redirection Settings

Use this feature to specify how the host computer will exchange data with the client computer, which is the remote computer used by the user. The options are Enabled and **Disabled**.

COM2 Terminal Type

Use this feature to select the target terminal emulation type for Console Redirection. Select VT100 to use the ASCII Character set. Select VT100+ to add color and function key support. Select ANSI to use the Extended ASCII Character Set. Select VT-UTF8 to use UTF8 encoding to map Unicode characters into one or more bytes. The options are VT100, **VT100+**, VT-UTF8, and ANSI.

COM2 Bits per second

Use this feature to set the transmission speed for a serial port used in Console Redirection. Make sure that the same speed is used in the host computer and the client computer. A lower transmission speed may be required for long and busy lines. The options are 9600, 19200, 38400, 57600, and **115200** (bits per second).

COM2 Data Bits

Use this feature to set the data transmission size for Console Redirection. The options are 7 and **8**.

COM2 Parity

A parity bit can be sent along with regular data bits to detect data transmission errors. Select Even if the parity bit is set to 0, and the number of 1's in data bits is even. Select Odd if the parity bit is set to 0, and the number of 1's in data bits is odd. Select None if you do not want to send a parity bit with your data bits in transmission. Select Mark to add a mark as a parity bit to be sent along with the data bits. Select Space to add a Space as a parity bit to be sent with your data bits. The options are **None**, Even, Odd, Mark, and Space.

COM2 Stop Bits

A stop bit indicates the end of a serial data packet. Select 1 Stop Bit for standard serial data communication. Select 2 Stop Bits if slower devices are used. The options are **1** and **2**.

COM2 Flow Control

Use this feature to set the flow control for Console Redirection to prevent data loss caused by buffer overflow. Send a Stop signal to stop sending data when the receiving buffer is full. Send a Start signal to start sending data when the receiving buffer is empty. The options are **None** and Hardware RTS/CTS.

COM2 VT-UTF8 Combo Key Support

Select Enabled to enable VT-UTF8 Combination Key support for ANSI/VT100 terminals. The options are Disabled and **Enabled**.

COM2 Recorder Mode

Select Enabled to capture the data displayed on a terminal and send it as text messages to a remote server. The options are **Disabled** and Enabled.

COM2 Resolution 100x31

Select Enabled for extended-terminal resolution support. The options are Disabled and **Enabled**.

COM2 Legacy OS Redirection Resolution

Use this feature to select the number of rows and columns used in Console Redirection for legacy OS support. The options are 80x24 and **80x25**.

COM2 Putty KeyPad

This feature selects Function Keys and KeyPad settings for Putty, which is a terminal emulator designed for the Windows OS. The options are **VT100**, LINUX, XTERMR6, SCO, ESCN, and VT400.

COM2 Redirection After BIOS POST

Use this feature to enable or disable legacy Console Redirection after BIOS POST. When set to Bootloader, legacy Console Redirection is disabled before booting the OS. When set to Always Enable, legacy Console Redirection remains enabled when booting the OS. The options are **Always Enable** and Bootloader.

►EMS Console Redirection Settings

This feature allows the user to specify how the host computer will exchange data with the client computer, which is the remote computer used by the user.

Out-of-Band Mgmt Port

The feature selects a serial port in a client server to be used by the Microsoft Windows Emergency Management Services (EMS) to communicate with a remote host server. The options are **COM1** and COM2.

Terminal Type

Use this feature to select the target terminal emulation type for Console Redirection. Select VT100 to use the ASCII character set. Select VT100+ to add color and function key support. Select ANSI to use the extended ASCII character set. Select VT-UTF8 to use UTF8 encoding to map Unicode characters into one or more bytes. The options are VT100, VT100+, **VT-UTF8**, and ANSI.

Bits per second

This item sets the transmission speed for a serial port used in Console Redirection. Make sure that the same speed is used in the host computer and the client computer. A lower transmission speed may be required for long and busy lines. The options are 9600, 19200, 57600, and **115200** (bits per second).

Flow Control

Use this item to set the flow control for Console Redirection to prevent data loss caused by buffer overflow. Send a "Stop" signal to stop sending data when the receiving buffer is full. Send a "Start" signal to start sending data when the receiving buffer is empty. The options are **None**, Hardware RTS/CTS, and Software Xon/Xoff.

Data Bits

Parity

Stop Bits

► PCIe/PCI/PnP Configuration

PCI Bus Driver Version A5.01.08

PCI Devices Common Settings:

Above 4G Decoding

Select Enabled for 64-bit devices to be decoded above the 4GB address space, if 64bit PCI decoding is supported by the system. The options are **Disabled** and Enabled.

NVMe Firmware Source

Use this feature to select which firmware type to be loaded for the add-on card in this slot. The options are **Vendor Defined Firmware** and AMI Native Support.

Mini PCIe OPROM

Use this feature to select which firmware type to be loaded for the add-on card in this slot. The options are Disabled and **EFI**.

JMD1 M.2 OPROM

Use this feature to select which firmware type to be loaded for the add-on card in this slot. The options are Disabled and **EFI**.

Onboard LAN Option ROM Type

Use this feature to select which firmware type to be loaded for the add-on card in this slot. The options are Disabled and **EFI**.

****If Onboard LAN Option ROM Type is set to Legacy, Onboard LAN1/LAN2 Option ROM will become available for configuration:***

Onboard LAN1 Option ROM

Use this feature to select which LAN1 firmware type to be loaded. The options are **Disabled**, PXE, and iSCSI.

Onboard LAN2 Option ROM

Use this feature to select which LAN2 firmware type to be loaded. The options are **Disabled**, PXE, and iSCSI.

Onboard Video Option ROM

Use this feature to select which onboard video firmware type to be loaded. The options are Disabled and **EFI**.

Network Stack

Select Enabled to enable PXE (Preboot Execution Environment) or UEFI (Unified Extensible Firmware Interface) for network stack support. The options are Disabled and **Enabled**.

****If Network Stack is Enabled, the following four items will be available for configuration:***

Ipv4 PXE Support

Select Enabled to enable Ipv4 PXE (Preboot Execution Environment) for boot support. If this feature is set to Disabled, Ipv4 PXE boot option will not be supported. The options are Disabled and **Enabled**.

Ipv6 PXE Support

Select Enabled to enable Ipv6 PXE (Preboot Execution Environment) for boot support. If this feature is set to Disabled, Ipv6 PXE boot option will not be supported. The options are **Disabled** and Enabled.

PXE boot wait time

Use this option to specify the wait time to press the ESC key to abort the PXE boot. Press "+" or "-" on your keyboard to change the value. The default setting is **0**.

Media detect count

Use this option to specify the number of times media will be checked. Press "+" or "-" on your keyboard to change the value. The default setting is **1**.

► iSCSI Configuration

iSCSI Initiator Name

This feature allows the user to enter the unique name of the iSCSI Initiator in IQN format. Once the name of the iSCSI Initiator is entered into the system, configure the proper settings for the following items.

▶ **Add an Attempt**

▶ **Delete Attempts**

▶ **Change Attempt order**

▶ **Intel® I210 Gigabit Network Connection - 00:25:90:5E:E2:B2**

▶ **NIC Configuration**

Link Speed

This feature allows the user to specify the port speed used for the selected boot protocol. The options are **Auto Negotiated**, 10 Mbps Half, 10 Mbps Full, 100 Mbps Half, and 100 Mbps Full.

Wake On LAN

Select Enabled for Wake On LAN support, which will allow the system to wake up when an onboard device receives an incoming signal. The options are Disabled and **Enabled**.

Blink LEDs

Use this feature to identify the physical network port by blinking the associated LED. Use the keyboard to select a value. **0** is the default.

UEFI Driver

This feature displays the UEFI driver version.

Adapter PBA

This feature displays the Processor Bus Adapter (PBA) model number. The PBA number is a nine digit number (i.e., 010B00-000) located near the serial number.

Device Name

This feature displays the adapter device name.

Chip Type

This item displays the network adapter chipset name.

PCI Device ID

This feature displays the device ID number.

PCI Address

This feature displays the PCI address for this computer. PCI addresses are three two-digit hexadecimal numbers.

Link Status

This feature displays the connection status.

MAC Address

This feature displays the MAC address for this computer. Mac addresses are six two-digit hexadecimal numbers.

Virtual MAC Address

This feature displays the Virtual MAC address for this computer. Mac addresses are six two-digit hexadecimal numbers.

► Intel® I210 Gigabit Network Connection - 00:25:90:5E:E2:B3**► NIC Configuration****Link Speed**

This feature allows the user to specify the port speed used for the selected boot protocol. The options are **Auto Negotiated**, 10 Mbps Half, 10 Mbps Full, 100 Mbps Half, and 100 Mbps Full.

Wake On LAN

Select Enabled for Wake On LAN support, which will allow the system to wake up when an onboard device receives an incoming signal. The options are Disabled and **Enabled**.

Blink LEDs

Use this feature to identify the physical network port by blinking the associated LED. Use the keyboard to select a value. **0** is the default.

UEFI Driver

This feature displays the UEFI driver version.

Adapter PBA

This feature displays the Processor Bus Adapter (PBA) model number. The PBA number is a nine digit number (i.e., 010B00-000) located near the serial number.

Device Name

This feature displays the adapter device name.

Chip Type

This feature displays the network adapter chipset name.

PCI Device ID

This feature displays the device ID number.

PCI Address

This feature displays the PCI address for this computer. PCI addresses are three two-digit hexadecimal numbers.

Link Status

This feature displays the connection status.

MAC Address

This feature displays the MAC address for this computer. Mac addresses are six two-digit hexadecimal numbers.

Virtual MAC Address

This feature displays the Virtual MAC address for this computer. Mac addresses are six two-digit hexadecimal numbers.

4.4 Security

Use this menu to configure Security settings.

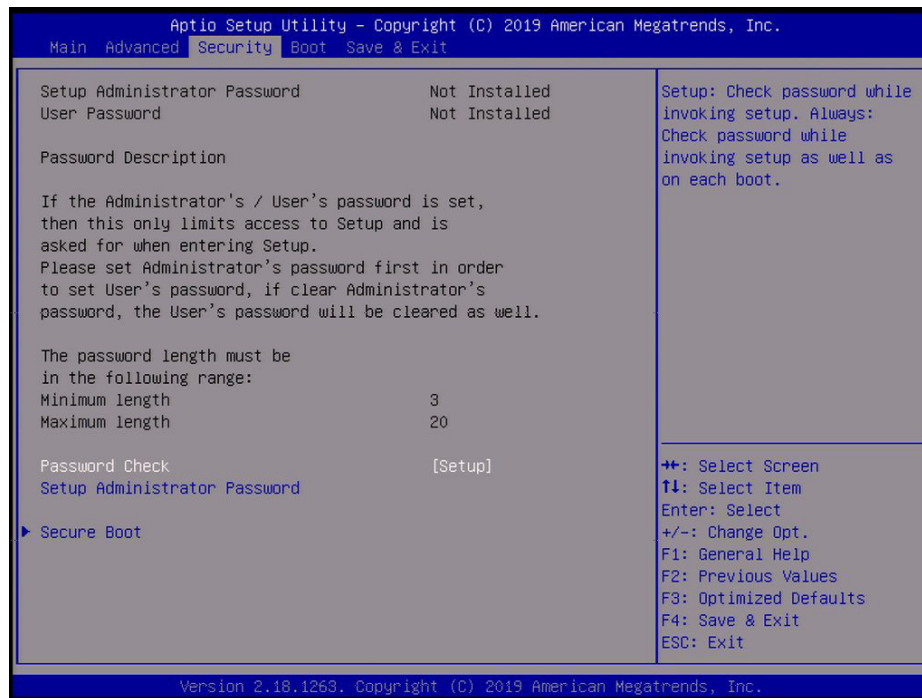

Password Check

Use this feature to determine when a password entry is required. Select Setup to require the password only when entering setup. Select Always to require the password when entering setup and at each bootup. The options are **Setup** and Always.

Setup Administrator Password

Use this feature to set the administrator password which is required to enter the BIOS setup utility. The length of the password should be from three to 20 characters long.

► Secure Boot

Secure Boot Support

Select Enable for secure boot support to ensure system security at bootup. The options are **Disabled** and Enabled.

Secure Boot Mode

This feature allows the user to select the desired secure boot mode for the system. The options are Standard and **Custom**.

If Secure Boot Mode is set to Custom, Key Management features will be available for configuration:

CSM Support

Select Enabled for manufacturing or debugging purposes for the EFI Compatibility Support Module (CSM), which provides compatibility support for traditional legacy BIOS for system boot with limited support. The options are **Disabled** and Enabled. This feature is for manufacture debugging purposes.

► Key Management

This submenu allows the user to configure the following Key Management settings.

Provision Factory Default Keys

Select Enabled to install the default Secure Boot keys set by the manufacturer. The options are **Disabled** and Enabled.

► Install Factory Default keys

Select Yes to install the default settings for all keys. The options are Yes and No.

► Enroll Efi Image

The feature allows the image to run in Secure Boot mode.

► Save All Secure Boot Variables

This feature allows the user to decide if all secure boot variables should be saved.

► Platform Key (PK)

This feature allows the user to configure the settings of the platform keys.

Set New Var

Select Yes to load the new PK from the manufacturer's defaults. Select No to load the platform keys from a file. The options are **Yes** and No.

► Key Exchange Keys (KEK)

Set New Var

Select Yes to load the KEK from the manufacturer's defaults. Select No to load the KEK from a file. The options are Yes and No.

Append Key

Select Yes to add the KEK from the manufacturer's defaults to the existing KEK. Select No to load the KEK from a file. The options are Yes and No.

▶ Authorized Signatures**Set New Var**

Select Yes to load the db from the manufacturer's defaults. Select No to load the db from a file. The options are Yes and No.

Append Key

Select Yes to add the db from the manufacturer's defaults to the existing db. Select No to load the DB from a file. The options are Yes and No.

▶ Forbidden Signatures**Set New Var**

Select Yes to load the dbx from the manufacturer's defaults. Select No to load the dbx from a file. The options are Yes and No.

Append Key

Select Yes to add the dbx from the manufacturer's defaults to the existing dbx. Select No to load the dbx from a file. The options are Yes and No.

▶ Authorized TimeStamps**Set New Var**

Select Yes to load the dbt from the manufacturer's defaults. Select No to load the dbt from a file. The options are Yes and No.

Append Key

Select Yes to add the dbt from the manufacturer's defaults list to the existing dbt. Select No to load the dbt from a file. The options are Yes and No.

▶ OsRecovery Signature**Set New Var**

Select Yes to load the dbr from the manufacturer's defaults. Select No to load the dbr from a file. The options are Yes and No.

Append Key

Select Yes to add the dbr from the manufacturer's defaults list to the existing dbr. Select No to load the dbr from a file. The options are Yes and No.

4.5 Boot

Use this menu to configure Boot Settings:

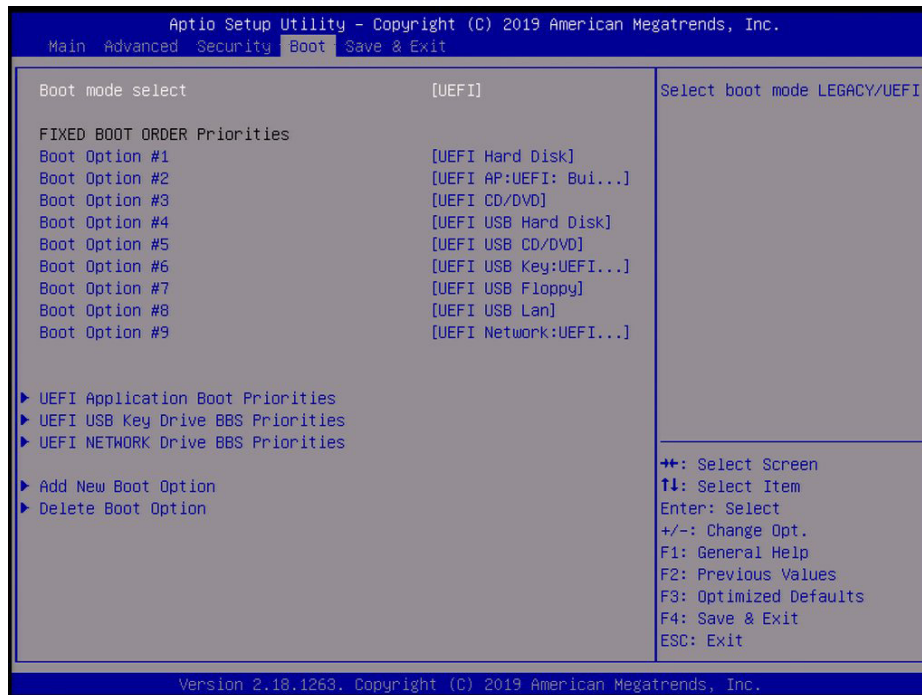

Boot mode select

Use this feature to select the boot mode. The options are LEGACY, **UEFI**, and DUAL.

Fixed Boot Order Priorities

This option prioritizes the order of bootable devices that the system can boot from. Press <Enter> on each entry from top to bottom to select devices.

- Boot Option #1
- Boot Option #2
- Boot Option #3
- Boot Option #4
- Boot Option #5
- Boot Option #6
- Boot Option #7
- Boot Option #8

- Boot Option #9

▶UEFI Application Boot Priorities

This feature allows the user to specify which UEFI devices are boot devices.

- Boot Option #1

▶UEFI USB Key Drive BBS Priorities

This feature allows the user to specify which UEFI USB Key drive devices are boot devices. This feature is displayed when a storage device is detected.

- UEFI Boot Option #1
- UEFI Boot Option #2

▶UEFI NETWORK Drive BBS Priorities

This feature allows the user to specify which UEFI network drive devices are boot devices.

- Boot Option #1
- Boot Option #2

▶Add New Boot Option

Use this feature to select a new boot device to add to the boot priority list. This feature is displayed when a storage device is detected.

Add boot option

Use this feature to specify the name for the new boot option.

Path for boot option

Use this feature to set the path to the boot option in the following format: fsx:\path\filename.efi.

Create

Use this feature to create the new boot option.

▶Delete Boot Option

Use this feature to remove a pre-defined boot device from which the system will boot during startup.

- Delete Boot Option

4.6 Save & Exit

Use this menu to save settings and exit the BIOS.

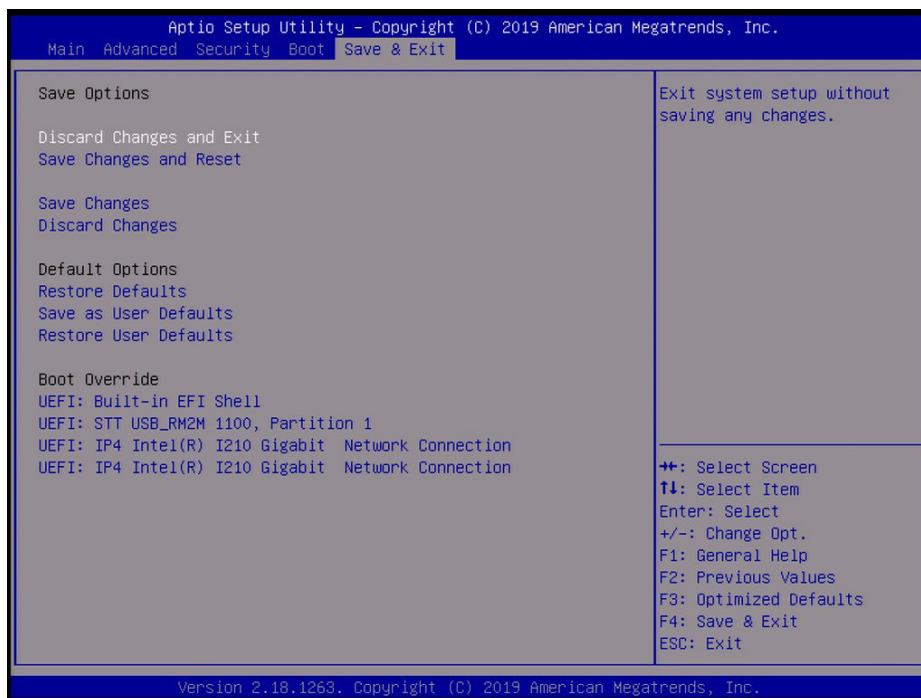

Save Options

Discard Changes and Exit

Select this option to quit the BIOS Setup without making any permanent changes to the system configuration, and reboot the computer. Select Discard Changes and Exit from the Exit menu and press <Enter>.

Save Changes and Reset

When you have completed the system configuration changes, select this option to save all changes made and reset the system.

Save Changes

When you have completed the system configuration changes, select this option to save all changes made. This will not reset (reboot) the system.

Discard Changes

Select this option and press <Enter> to discard all the changes and return to the AMI BIOS Utility Program.

Default Options**Restore Defaults**

To set this feature, select Restore Defaults from the Exit menu and press <Enter>. These are factory settings designed for maximum system performance but not for maximum stability.

Save as User Defaults

To set this feature, select Save as User Defaults from the Exit menu and press <Enter>. This enables the user to save any changes to the BIOS setup for future use.

Restore User Defaults

To set this feature, select Restore User Defaults from the Exit menu and press <Enter>. Use this feature to retrieve user-defined settings that were saved previously.

Boot Override

This feature allows the user to override the Boot Option Priorities sequence in the Boot menu, and immediately boot the system with another device specified by the user. This is a one-time override.

UEFI: Built-in EFI Shell**UEFI: IP4 Intel® I210 Gigabit Network Connection****UEFI: IP4 Intel® I210 Gigabit Network Connection**

Appendix A

Software Installation

A.1 Installing Software Programs

The Supermicro website that contains drivers and utilities for your system at <https://www.supermicro.com/wftp/driver/>. Some of these must be installed, such as the chipset driver.

After accessing the website, go into the CDR_Images directory and locate the ISO file for your motherboard. Download this file to create a CD/DVD of the drivers and utilities it contains. (You may also use a utility to extract the ISO file if preferred.)

After creating a CD/DVD with the ISO files, insert the disk into the CD/DVD drive on your system and the display shown in Figure A-1 should appear.

Another option is to go to the Supermicro website at <http://www.supermicro.com/products/>. Find the product page for your motherboard here, where you may download individual drivers and utilities to your hard drive or a USB flash drive and install from there.

 **Note:** To install the Windows OS, please refer to the instructions posted on our website at <http://www.supermicro.com/support/manuals/>.

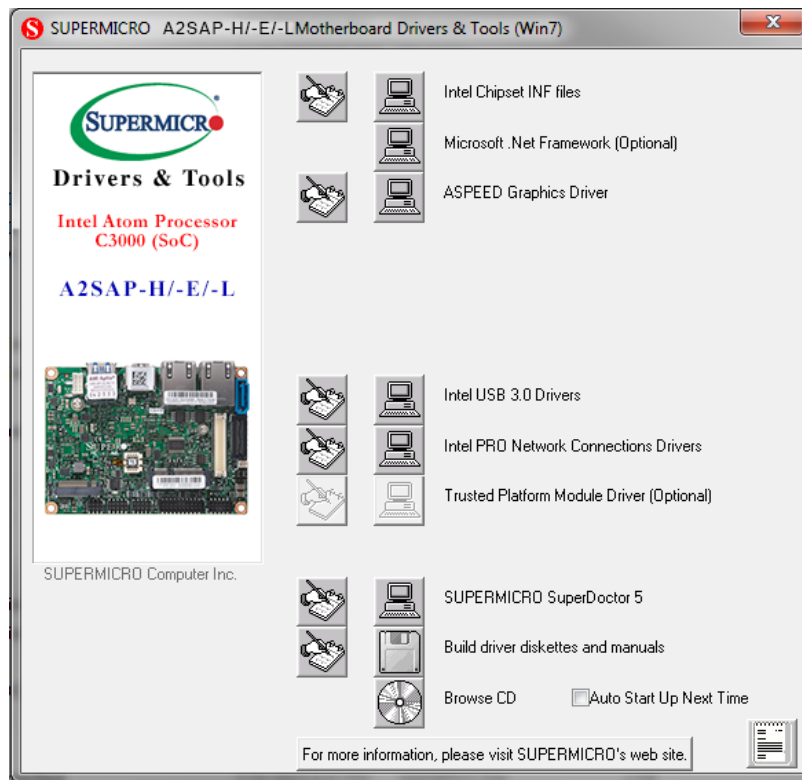

Figure A-1. Driver/Tool Installation Display Screen

Click the icons showing a hand writing on the paper to view the readme files for each item. Click a computer icon to the right of an item to install an item (from top to bottom) one at a time. After installing each item, you must reboot the system before proceeding with the next item on the list. The bottom icon with a CD on it allows you to view the entire contents of the CD.

When making a storage driver disk by booting into a driver CD, please set the SATA Configuration to "Compatible Mode" and configure SATA as IDE in the BIOS Setup. After making the driver disk, be sure to change the SATA settings back to your original settings.

A.2 SuperDoctor® 5

The Supermicro SuperDoctor 5 is a hardware monitoring program that functions in a command-line or web-based interface in Windows and Linux operating systems. The program monitors system health information such as CPU temperature, system voltages, system power consumption, fan speed, and provides alerts via email or Simple Network Management Protocol (SNMP).

SuperDoctor 5 comes in local and remote management versions and can be used with Nagios to maximize your system monitoring needs. With SuperDoctor 5 Management Server (SSM Server), you can remotely control power on/off and reset chassis intrusion for multiple systems with SuperDoctor 5 or IPMI. SD5 Management Server monitors HTTP, FTP, and SMTP services to optimize the efficiency of your operation.



Note: The default Username and Password for SuperDoctor 5 is ADMIN / ADMIN.

Figure A-2. SuperDoctor 5 Interface Display Screen (Health Information)

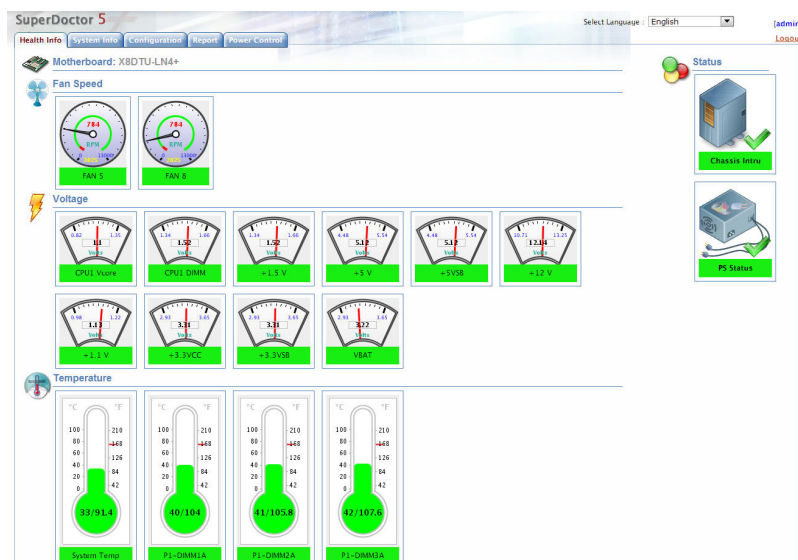

Note: The SuperDoctor 5 program and user's manual can be downloaded from the Supermicro website at http://www.supermicro.com/products/info/sms_sd5.cfm.

Appendix B

Standardized Warning Statements

The following statements are industry standard warnings, provided to warn the user of situations which have the potential for bodily injury. Should you have questions or experience difficulty, contact Supermicro's Technical Support department for assistance. Only certified technicians should attempt to install or configure components.

Read this section in its entirety before installing or configuring components.

These warnings may also be found on our website at http://www.supermicro.com/about/policies/safety_information.cfm.

Battery Handling



Warning! There is the danger of explosion if the battery is replaced incorrectly. Replace the battery only with the same or equivalent type recommended by the manufacturer. Dispose of used batteries according to the manufacturer's instructions

電池の取り扱い

電池交換が正しく行われなかった場合、破裂の危険性があります。交換する電池はメーカーが推奨する型、または同等のものを使用下さい。使用済電池は製造元の指示に従って処分して下さい。

警告

電池更換不當會有爆炸危險。請只使用同類電池或制造商推薦的功能相當的電池更換原有電池。請按製造商的說明處理廢舊電池。

警告

電池更換不當會有爆炸危險。請使用製造商建議之相同或功能相當的電池更換原有電池。請按照製造商的說明指示處理廢棄舊電池。

Warnung

Bei Einsetzen einer falschen Batterie besteht Explosionsgefahr. Ersetzen Sie die Batterie nur durch den gleichen oder vom Hersteller empfohlenen Batterietyp. Entsorgen Sie die benutzten Batterien nach den Anweisungen des Herstellers.

Attention

Danger d'explosion si la pile n'est pas remplacée correctement. Ne la remplacer que par une pile de type semblable ou équivalent, recommandée par le fabricant. Jeter les piles usagées conformément aux instructions du fabricant.

¡Advertencia!

Existe peligro de explosión si la batería se reemplaza de manera incorrecta. Reemplazar la batería exclusivamente con el mismo tipo o el equivalente recomendado por el fabricante. Desechar las baterías gastadas según las instrucciones del fabricante.

אזהרה!

קיימת סכנת פיצוץ של הסוללה במידה והוחלפה בדרך לא תקינה. יש להחליף את הסוללה בסוג התואם מחברת יצרן מומלצת. סילוק הסוללות המשומשות יש לבצע לפי הוראות היצרן.

هناك خطر من انفجار في حالة اسبدال البطارية بطريقة غير صحيحة فعلي
اسبدال البطارية فقط بنفس النوع أو ما يعادلها مما أوصت به الشركة المصنعة
جخلص من البطاريات المسحمة وفقا لعمليات الشركة الصانعة

경고!

배터리가 올바르게 교체되지 않으면 폭발의 위험이 있습니다. 기존 배터리와 동일하거나 제조사에서 권장하는 동등한 종류의 배터리로만 교체해야 합니다. 제조사의 안내에 따라 사용된 배터리를 처리하여 주십시오.

Waarschuwing

Er is ontploffingsgevaar indien de batterij verkeerd vervangen wordt. Vervang de batterij slechts met hetzelfde of een equivalent type die door de fabrikant aanbevolen wordt. Gebruikte batterijen dienen overeenkomstig fabrieksvoorschriften afgevoerd te worden.

Product Disposal



Warning! Ultimate disposal of this product should be handled according to all national laws and regulations.

製品の廃棄

この製品を廃棄処分する場合、国の関係する全ての法律・条例に従い処理する必要があります。

警告

本产品的废弃处理应根据所有国家的法律和规章进行。

警告

本產品的廢棄處理應根據所有國家的法律和規章進行。

Warnung

Die Entsorgung dieses Produkts sollte gemäß allen Bestimmungen und Gesetzen des Landes erfolgen.

¡Advertencia!

Al deshacerse por completo de este producto debe seguir todas las leyes y reglamentos nacionales.

Attention

La mise au rebut ou le recyclage de ce produit sont généralement soumis à des lois et/ou directives de respect de l'environnement. Renseignez-vous auprès de l'organisme compétent.

סילוק המוצר

אזהרה!

סילוק סופי של מוצר זה חייב להיות בהתאם להנחיות וחוקי המדינה.

عند التخلص النهائي من هذا المنتج ينبغي التعامل معه وفقا لجميع القوانين واللوائح الوطنية

경고!

이 제품은 해당 국가의 관련 법규 및 규정에 따라 폐기되어야 합니다.

Waarschuwing

De uiteindelijke verwijdering van dit product dient te geschieden in overeenstemming met alle nationale wetten en reglementen.

Appendix C

UEFI BIOS Recovery

Warning: Do not upgrade the BIOS unless your system has a BIOS-related issue. Flashing the wrong BIOS can cause irreparable damage to the system. In no event shall Supermicro be liable for direct, indirect, special, incidental, or consequential damages arising from a BIOS update. If you need to update the BIOS, do not shut down or reset the system while the BIOS is updating to avoid possible boot failure.

C.1 Overview

The Unified Extensible Firmware Interface (UEFI) provides a software-based interface between the operating system and the platform firmware in the pre-boot environment. The UEFI specification supports an architecture-independent mechanism that will allow the UEFI OS loader stored in an add-on card to boot the system. The UEFI offers clean, hands-off management to a computer during system boot.

C.2 Recovering the UEFI BIOS Image

A UEFI BIOS flash chip consists of a recovery BIOS block and a main BIOS block (a main BIOS image). The boot block contains critical BIOS codes, including memory detection and recovery codes for the user to flash a new BIOS image if the original main BIOS image is corrupted. When the system power is first turned on, the boot block codes execute first. Once this process is completed, the main BIOS code will continue with system initialization and the remaining POST (Power-On Self-Test) routines.