



A2SDV-4C-LN8F  
A2SDV-8C-LN8F  
A2SDV-4C-LN10PF  
A2SDV-8C-LN10PF

USER MANUAL

Revision 1.0

The information in this User's Manual has been carefully reviewed and is believed to be accurate. The vendor assumes no responsibility for any inaccuracies that may be contained in this document, and makes no commitment to update or to keep current the information in this manual, or to notify any person or organization of the updates. **Please Note: For the most up-to-date version of this manual, please see our website at [www.supermicro.com](http://www.supermicro.com).**

Super Micro Computer, Inc. ("Supermicro") reserves the right to make changes to the product described in this manual at any time and without notice. This product, including software and documentation, is the property of Supermicro and/or its licensors, and is supplied only under a license. Any use or reproduction of this product is not allowed, except as expressly permitted by the terms of said license.

IN NO EVENT WILL Super Micro Computer, Inc. BE LIABLE FOR DIRECT, INDIRECT, SPECIAL, INCIDENTAL, SPECULATIVE OR CONSEQUENTIAL DAMAGES ARISING FROM THE USE OR INABILITY TO USE THIS PRODUCT OR DOCUMENTATION, EVEN IF ADVISED OF THE POSSIBILITY OF SUCH DAMAGES. IN PARTICULAR, SUPER MICRO COMPUTER, INC. SHALL NOT HAVE LIABILITY FOR ANY HARDWARE, SOFTWARE, OR DATA STORED OR USED WITH THE PRODUCT, INCLUDING THE COSTS OF REPAIRING, REPLACING, INTEGRATING, INSTALLING OR RECOVERING SUCH HARDWARE, SOFTWARE, OR DATA.

Any disputes arising between manufacturer and customer shall be governed by the laws of Santa Clara County in the State of California, USA. The State of California, County of Santa Clara shall be the exclusive venue for the resolution of any such disputes. Supermicro's total liability for all claims will not exceed the price paid for the hardware product.

FCC Statement: This equipment has been tested and found to comply with the limits for a Class B digital device pursuant to Part 15 of the FCC Rules. These limits are designed to provide reasonable protection against harmful interference when the equipment is operated in a commercial environment. This equipment generates, uses, and can radiate radio frequency energy and, if not installed and used in accordance with the manufacturer's instruction manual, may cause harmful interference with radio communications. Operation of this equipment in a residential area is likely to cause harmful interference, in which case you will be required to correct the interference at your own expense.

California Best Management Practices Regulations for Perchlorate Materials: This Perchlorate warning applies only to products containing CR (Manganese Dioxide) Lithium coin cells. "Perchlorate Material-special handling may apply. See [www.dtsc.ca.gov/hazardouswaste/perchlorate](http://www.dtsc.ca.gov/hazardouswaste/perchlorate)".



WARNING: This product can expose you to chemicals including lead, known to the State of California to cause cancer and birth defects or other reproductive harm. For more information, go to [www.P65Warnings.ca.gov](http://www.P65Warnings.ca.gov).

The products sold by Supermicro are not intended for and will not be used in life support systems, medical equipment, nuclear facilities or systems, aircraft, aircraft devices, aircraft/emergency communication devices or other critical systems whose failure to perform be reasonably expected to result in significant injury or loss of life or catastrophic property damage. Accordingly, Supermicro disclaims any and all liability, and should buyer use or sell such products for use in such ultra-hazardous applications, it does so entirely at its own risk. Furthermore, buyer agrees to fully indemnify, defend and hold Supermicro harmless for and against any and all claims, demands, actions, litigation, and proceedings of any kind arising out of or related to such ultra-hazardous use or sale.

Manual Revision 1.0

Release Date: August 24, 2018

Unless you request and receive written permission from Super Micro Computer, Inc., you may not copy any part of this document. Information in this document is subject to change without notice. Other products and companies referred to herein are trademarks or registered trademarks of their respective companies or mark holders.

Copyright © 2018 by Super Micro Computer, Inc.  
All rights reserved.

**Printed in the United States of America**

# Preface

## About This Manual

This manual is written for system integrators, IT technicians and knowledgeable end users. It provides information for the installation and use of the A2SDV-4C/8C-LN8F/LN10PF motherboard.

## About This Motherboard

The Supermicro A2SDV-4C/8C-LN8F/LN10PF motherboard comes with an integrated Intel® Atom C3000 System-on-Chip (FCBGA1310) supporting up to 8 cores with a 25W TDP. This Flex-ATX form factor motherboard is optimized for various networking applications requiring great performance while minimizing power consumption. Some of the available features on this model are one M.2 M-Key for storage, one M.2 B-Key for storage/PCI-E devices, eight Gigabit RJ45 LAN ports, two Gigabit SFP LAN ports, expandability via either slot6 or slot7, and the reliability/dependability of a Supermicro product. Please note that this motherboard is intended to be installed and serviced by professional technicians only. For processor/memory updates, please refer to our website at <http://www.supermicro.com/products/>.

## Conventions Used in the Manual

Special attention should be given to the following symbols for proper installation and to prevent damage done to the components or injury to yourself:



**Warning!** Indicates important information given to prevent equipment/property damage or personal injury.



**Warning!** Indicates high voltage may be encountered when performing a procedure.



**Important:** Important information given to ensure proper system installation or to relay safety precautions.



**Note:** Additional Information given to differentiate various models or to provide information for correct system setup.

## Contacting Supermicro

### Headquarters

Address: Super Micro Computer, Inc.  
980 Rock Ave.  
San Jose, CA 95131 U.S.A.

Tel: +1 (408) 503-8000

Fax: +1 (408) 503-8008

Email: [marketing@supermicro.com](mailto:marketing@supermicro.com) (General Information)  
[support@supermicro.com](mailto:support@supermicro.com) (Technical Support)

Website: [www.supermicro.com](http://www.supermicro.com)

### Europe

Address: Super Micro Computer B.V.  
Het Sterrenbeeld 28, 5215 ML  
's-Hertogenbosch, The Netherlands

Tel: +31 (0) 73-6400390

Fax: +31 (0) 73-6416525

Email: [sales@supermicro.nl](mailto:sales@supermicro.nl) (General Information)  
[support@supermicro.nl](mailto:support@supermicro.nl) (Technical Support)  
[rma@supermicro.nl](mailto:rma@supermicro.nl) (Customer Support)

Website: [www.supermicro.nl](http://www.supermicro.nl)

### Asia-Pacific

Address: Super Micro Computer, Inc.  
3F, No. 150, Jian 1st Rd.  
Zhonghe Dist., New Taipei City 235  
Taiwan (R.O.C)

Tel: +886-(2) 8226-3990

Fax: +886-(2) 8226-3992

Email: [support@supermicro.com.tw](mailto:support@supermicro.com.tw)

Website: [www.supermicro.com.tw](http://www.supermicro.com.tw)

# Table of Contents

## **Chapter 1 Introduction**

1.1 Checklist .....	8
Quick Reference .....	13
Quick Reference Table .....	15
Motherboard Features .....	17
1.2 Processor Overview .....	20
1.3 Special Features .....	20
Recovery from AC Power Loss .....	20
1.4 System Health Monitoring .....	21
Onboard Voltage Monitors .....	21
Fan Status Monitor with Firmware Control .....	21
Environmental Temperature Control .....	21
System Resource Alert .....	21
1.5 ACPI Features .....	22
1.6 Power Supply .....	22
1.7 Super I/O .....	22

## **Chapter 2 Installation**

2.1 Static-Sensitive Devices .....	23
Precautions .....	23
Unpacking .....	23
2.2 Motherboard Installation .....	24
Tools Needed .....	24
Location of Mounting Holes .....	24
Installing the Motherboard .....	25
2.3 Memory Support and Installation .....	26
Memory Support .....	26
DIMM Module Population Configuration .....	26
DIMM Module Population Sequence .....	27
DIMM Installation .....	28
DIMM Removal .....	28
2.4 Rear I/O Ports .....	29

2.5 Front Control Panel .....	34
2.6 Connectors .....	39
Power Connections .....	39
Headers .....	41
2.7 Jumper Settings .....	49
How Jumpers Work .....	49
2.8 LED Indicators .....	54

**Chapter 3 Troubleshooting**

3.1 Troubleshooting Procedures .....	56
Before Power On .....	56
No Power .....	56
No Video .....	56
System Boot Failure .....	57
Memory Errors .....	57
Losing the System's Setup Configuration .....	58
When the System Becomes Unstable .....	58
3.2 Technical Support Procedures .....	60
3.3 Frequently Asked Questions .....	61
3.4 Battery Removal and Installation .....	62
Battery Removal .....	62
Proper Battery Disposal .....	62
Battery Installation .....	62
3.5 Returning Merchandise for Service .....	63

**Chapter 4 BIOS**

4.1 Introduction .....	64
Starting the Setup Utility .....	64
4.2 Main Setup .....	65
4.3 Advanced .....	67
4.4 Event Logs .....	89
4.5 IPMI .....	91
4.6 Security .....	94
4.7 Boot .....	98
4.8 Save & Exit .....	100

**Appendix A BIOS Codes****Appendix B Software Installation**

B.1 Installing Software Programs .....	104
--	-----

**Appendix C Standardized Warning Statements**

Battery Handling.....	106
-----------------------	-----

Product Disposal .....	108
------------------------	-----

**Appendix D UEFI BIOS Recovery****Appendix E Dual Boot Block**

BIOS Boot Block .....	114
-----------------------	-----

BIOS Boot Block Corruption Occurrence .....	114
---	-----

# Chapter 1

## Introduction

Congratulations on purchasing your computer motherboard from an acknowledged leader in the industry. Supermicro boards are designed with the utmost attention to detail to provide you with the highest standards in quality and performance.

Please check that the following items have all been included with your motherboard. If anything listed here is damaged or missing, contact your retailer. The following items are included in the retail box:

### 1.1 Checklist

Main Parts List (included in the retail box)		
Description	Part Number	Quantity
Supermicro Motherboard	A2SDV-4C/8C-LN8F/LN10PF	1
SATA Cables (-4C SKUs)	CBL-0044L	3
SATA Cables (-8C SKUs)	CBL-0044L	5
Quick Reference Guide	MNL-2113-QRG	1
I/O Shield	MCP-260-00133-0N	1
Plastic Standoff	FST-SCRW-0010	1

### Important Links

For your system to work properly, please follow the links below to download all necessary drivers/utilities and the user's manual for your server.

- Supermicro product manuals: <http://www.supermicro.com/support/manuals/>
- Product drivers and utilities: <https://www.supermicro.com/wftp/driver/>
- Product safety info: [http://www.supermicro.com/about/policies/safety\\_information.cfm](http://www.supermicro.com/about/policies/safety_information.cfm)
- If you have any questions, please contact our support team at: [support@supermicro.com](mailto:support@supermicro.com)

This manual may be periodically updated without notice. Please check the Supermicro website for possible updates to the manual revision level.

Figure 1-1. A2SDV-4C-LN8F Motherboard Image

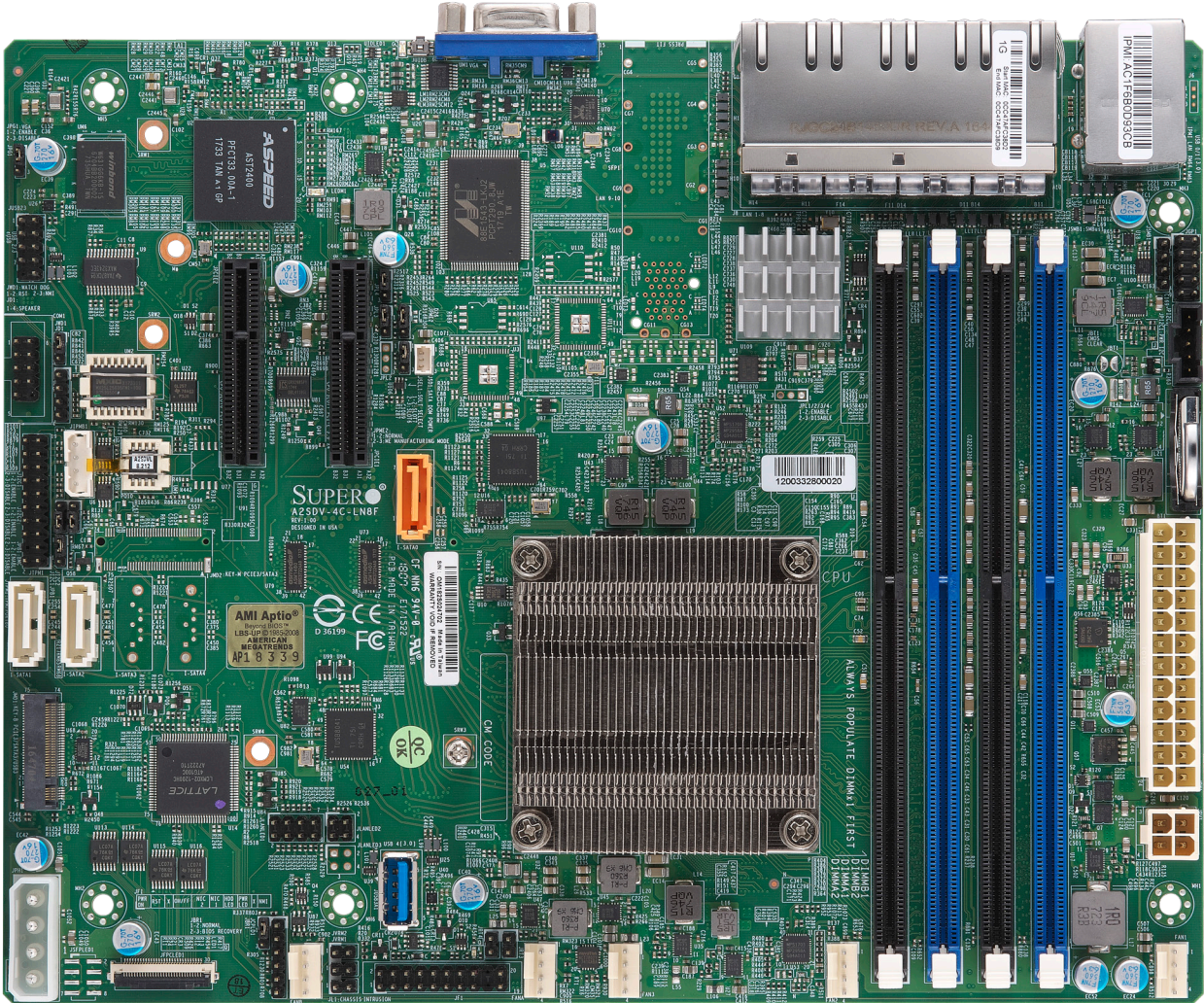

Figure 1-2. A2SDV-4C-LN10PF Motherboard Image

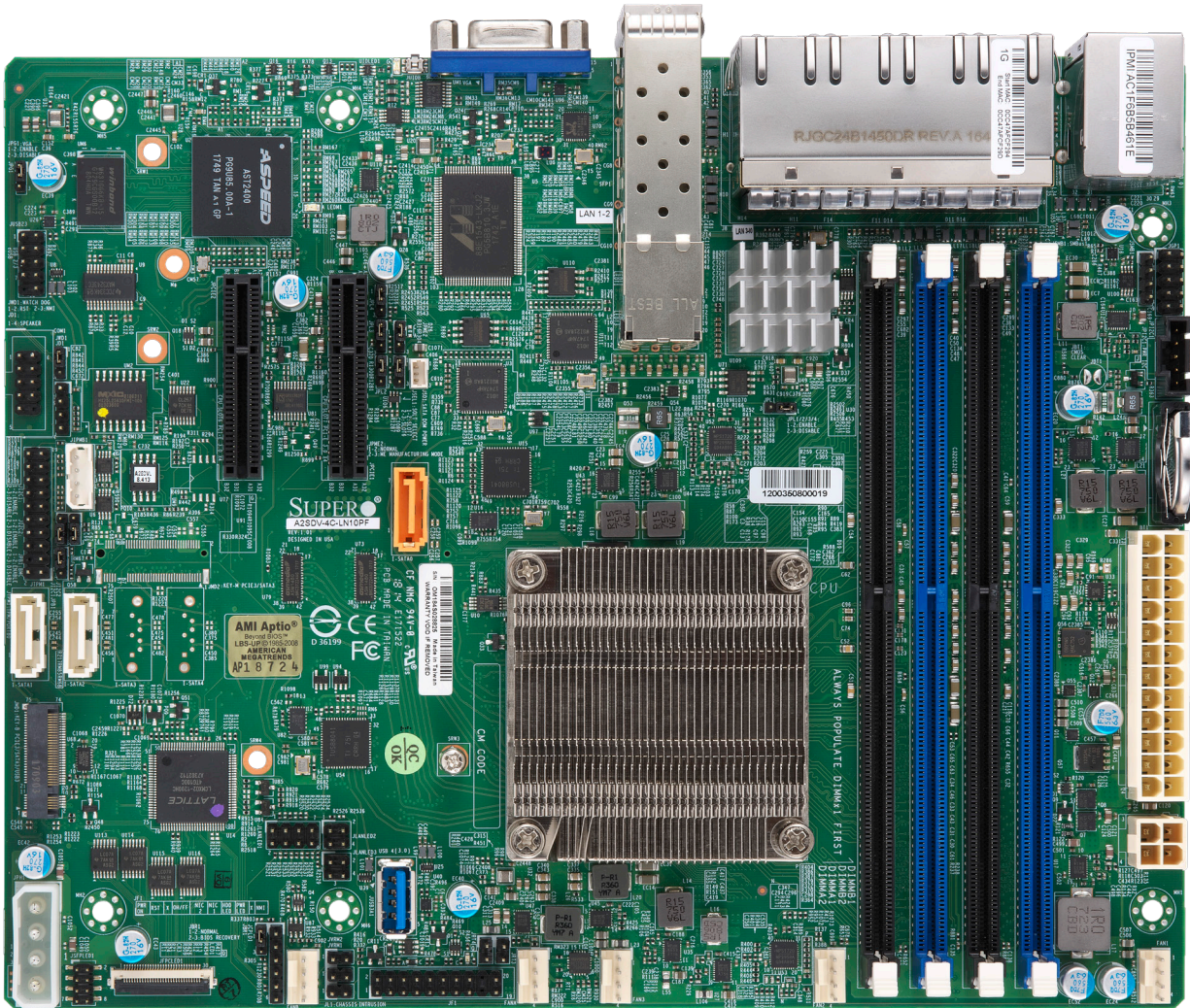
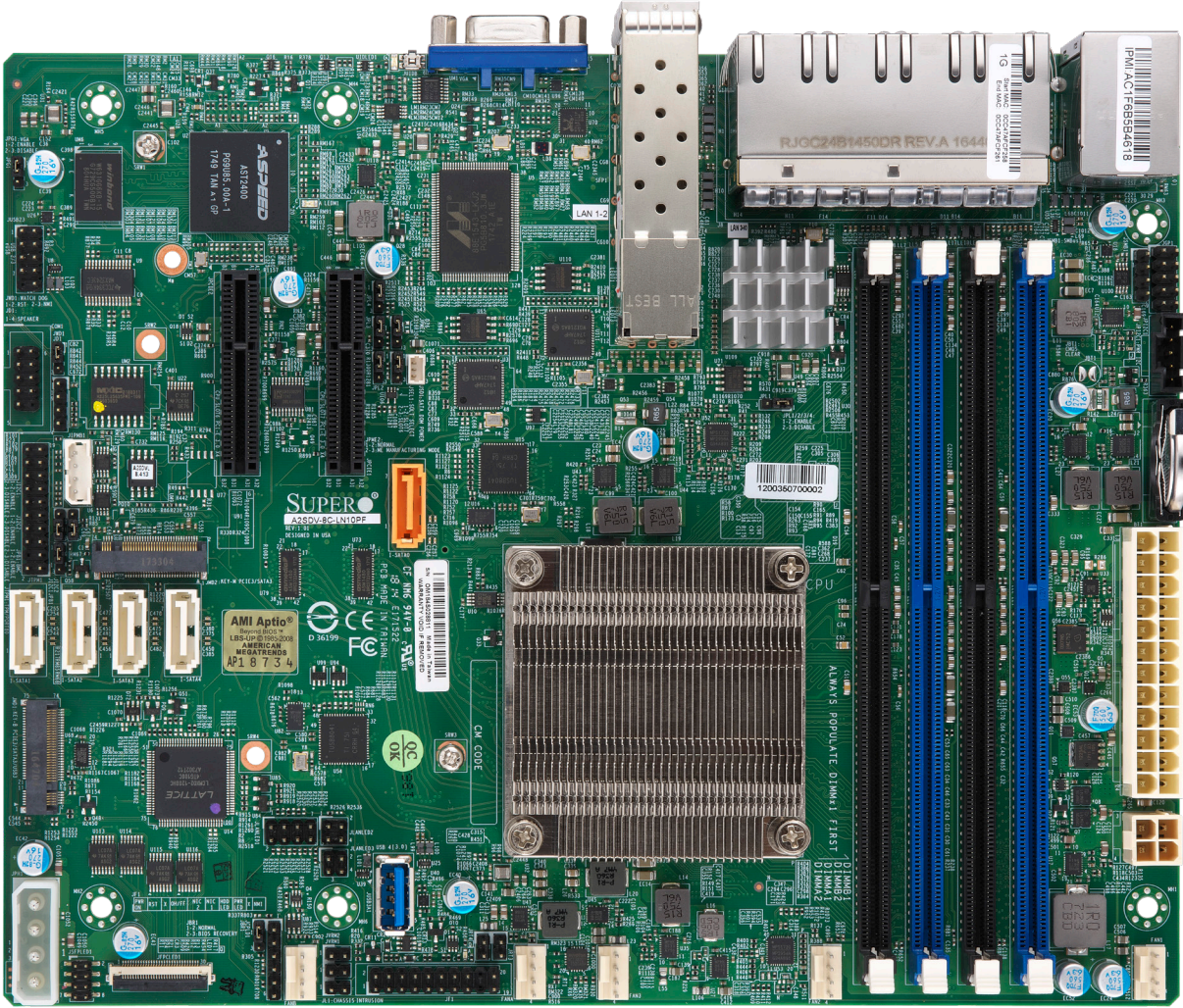
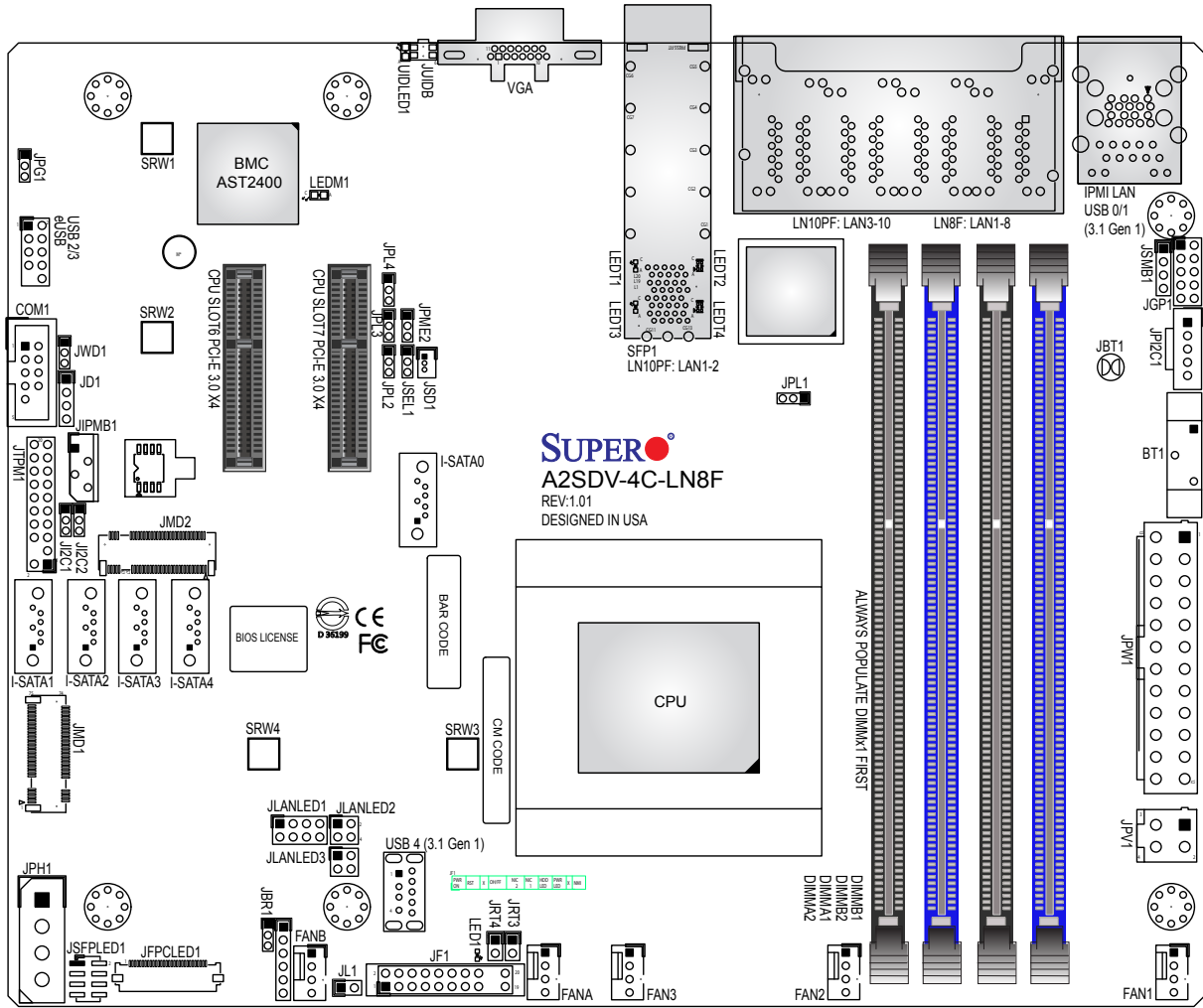



Figure 1-3. A2SDV-8C-LN10F Motherboard Image

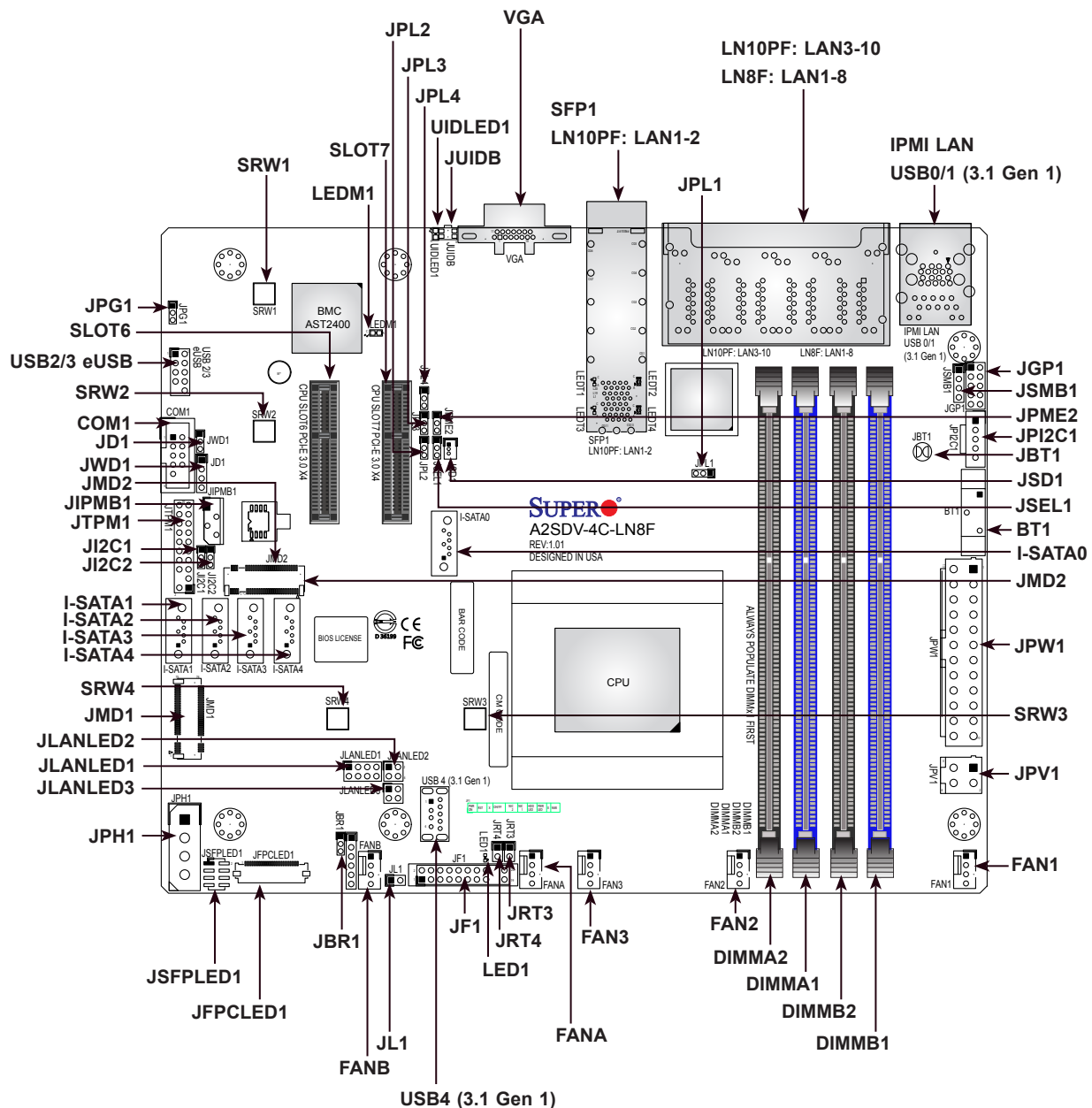

**Figure 1-4. A2SDV-LN8F/LN10PF Motherboard Layout**  
(not drawn to scale)



 **Note:** Components not documented are for internal testing only.

## Quick Reference



## Notes:

- USB 3.1 Gen 1 is also referred to as USB 3.0.
- See Chapter 2 for detailed information on jumpers, I/O ports, and JF1 front panel connections. Jumpers/LED indicators not indicated are used for testing only.
- "■" indicates the location of Pin 1.
- When JLED1 (Onboard Power LED indicator) is on, system power is on. Unplug the power cable before installing or removing any components.

**Figure 1-5. A2SDV-4C/8C-LN8F/LN10PF Model Variation Table**

Motherboard Model Name	A2SDV-4C-LN8F	A2SDV-8C-LN8F	A2SDV-4C-LN-10PF	A2SDV-8C-LN10PF
Processor Name	C3558	C3758	C3558	C3758
Number of Cores	4	8	4	8
Number of Threads	4	8	4	8
Cache	8MB	16MB	8MB	16MB
Processor Base Frequency	2.2GHz	2.2GHz	2.2GHz	2.2GHz
Intel® Turbo Boost Frequency	2.2GHz	2.2GHz	2.2GHz	2.2GHz
SoC TDP	16W	25W	16W	25W
SATA3 Ports	3	5	1~3	5
Expansion (Slot6 or Slot7)	PCI-E 3.0 x2	PCI-E 3.0 x4	PCI-E 3.0 x2 or Disabled	PCI-E 3.0 x4
M.2 M Key	No	Yes	No	Yes
M.2 B Key	Yes	Yes	Yes	Yes
Quad GbE LAN from SoC	Yes	Yes	Yes	Yes
Quad GbE LAN from I350 Controller	Yes	Yes	Yes	Yes
Dual 1GbE SFP LAN from i210 Controller	No	No	Yes	Yes

## Quick Reference Table

Jumper	Description	Default Setting
JBR1	BIOS Recovery	Pins 1-2 (Normal)
JBT1	CMOS Clear	Open (Normal)
JI <sup>2</sup> C1, JI <sup>2</sup> C2	SMB to PCI-E Slots Enable/Disable	Pins 2-3 (Disabled)
JPG1	Onboard VGA Enable/Disable	Pins 1-2 (Enabled)
JPL1	LAN1 SFP Port Enable/Disable (LN10PF only)	Pins 1-2 (Enabled)
JPL2	LAN2 SFP Port Enable/Disable (LN10PF only)	Pins 1-2 (Enabled)
JPL3	LN8F: LAN1-4 Ports Enable/Disable LN10PF: LAN3-6 Ports Enable/Disable	Pins 1-2 (Enabled)
JPL4	LN8F: LAN5-8 Ports Enable/Disable LN10PF: LAN7-10 Ports Enable/Disable	Pins 1-2 (Enabled)
JPME2	ME Manufacturing Mode	Pins 1-2 (Normal)
JSEL1	PCI-E Slot 6/7 Selection	Pins 1-2: Slot 7
JWD1	Watch Dog Timer	Pins 1-2 (Reset)

LED	Description	Status
LED1	Power LED	Solid Green: Power On
LEDM1	BMC Heartbeat	Blinking Green: BMC Normal
UIDLED1	UID LED	Solid Blue: Unit Identified

Connector	Description
BT1	Onboard Battery
COM1	COM Header
FAN1 - FAN3, FANA, FANB	CPU/System Fan Headers
IPMI LAN	IPMI LAN Port
I-SATA0-4	SATA 3.0 Ports (SATA3/4 on -8C-LN8F/LN10PF SKUs Only) (-4C-LN10PF: SATA1/2 are disabled when SLOT6/SLOT7 set to PCI-E 3.0 x2 in the BIOS.)
JD1	Speaker (Pins 1-4)
JF1	Front Control Panel Header
JFPCLED1	RJ45 LAN LED Board Cable Connector for FPB-FPE300-LED10
JGP1	General Purpose I/O Header
JIPMB1	System Management Bus Header (for IPMI card)
JL1	Chassis Intrusion Header
JLANLED1	LAN3-6 Activity LED
JLANLED2	LAN7-8 Activity LED
JLANLED3	LAN9-10 Activity LED (-LN10PF SKUs Only)
JMD1	M.2 B-Key PCI-E3.0/SATA3.0/USB3.0 Slot



**Note:** Table is continued on the next page.

<b>Connector</b>	<b>Description</b>
JMD2	M.2 M-Key PCI-E3.0/SATA3 Slot (8C-LN8F/LN10PF SKUs Only)
JPI <sup>2</sup> C1	Power Supply SMBus I <sup>2</sup> C Header
JPH1	4-pin Power Connector for HDD use
JPW1	24-pin ATX Power Connector
JPV1	4-pin 12V DC Power Connector (To provide alternative power for a special enclosure when the 24-pin ATX power is not in use.)
JRT3	Thermal Diode 1
JRT4	Thermal Diode 2
JSD1	SATA DOM Power Connector
JSFPLED1	SFP LAN LED Board Cable Connector for FPB-FPE300-LED10 (-LN10PF SKUs Only)
JSMB1	System Management Bus Header
JTPM1	Trusted Platform Module (TPM)
JUIDB	Unit ID Button
LAN1 - LAN10	LN8F: LAN1-8 Gigabit Ethernet RJ45 Port LN10PF: LAN1-2 Gigabit Ethernet SFP Port, LAN3-10 Gigabit Ethernet RJ45 Port
SLOT6, SLOT7	Single PCI-E Expansion Slot (Slot6 or Slot7 selectable with JSEL1) (8C-LN8F/LN10PF: PCI-E 3.0 x4) (4C-LN8F: PCE-E 3.0 x2) (4C-LN10PF: PCI-E 3.0 x2 or Disabled - Selectable in BIOS Setup)
SRW1 - SRW4	M.2 Holding Screws
USB0/1	Back Panel USB 3.1 Gen 1 Ports
USB2/3	Front Accessible USB 2.0 Header
USB4	USB 3.1 Gen 1 Type A Header
VGA	VGA Port

## Motherboard Features

<b>Motherboard Features</b>	
<b>CPU</b>	
<ul style="list-style-type: none"> <li>Intel® Atom SoC C3000 Series (FCBGA1310) Processor</li> </ul>	
<b>Memory</b>	
<ul style="list-style-type: none"> <li>Supports up to 256GB of RDIMM or 64GB of Non-ECC/ECC UDIMM DDR4 memory in four slots. On select SKUs, 2400MHz modules can be used but will operate at a lower speed.</li> </ul>	
<b>DIMM Size</b>	
<ul style="list-style-type: none"> <li>4GB, 8GB, 16GB, and 32GB</li> </ul>	
<b>Expansion Slots</b>	
<ul style="list-style-type: none"> <li>Two (2) PCI-E 3.0 x4 slots option (SLOT6 or SLOT 7 only) (-4C SKUs only supports PCI-E 3.0 x2)</li> <li>One (1) M.2 PCI-E 3.0/ SATA 3.0 slot (M-Key 2242/2280) (-8C-LN8F/LN10PF only)</li> <li>One (1) M.2 PCI-E 3.0/ SATA 3.0/ USB 3.0 slot (B-Key 3042/2280)</li> </ul>	
<b>Network</b>	
<ul style="list-style-type: none"> <li>Quad RJ45 LAN with Intel C3000 SoC</li> <li>Quad RJ45 LAN with Intel i350-AM4</li> <li>Dual SFP LAN with Intel i210-IS (-LN10PF SKUs only)</li> </ul>	
<b>Baseboard Management Controller (BMC)</b>	
<ul style="list-style-type: none"> <li>ASpeed AST2400 Baseboard Controller</li> </ul>	
<b>Graphics</b>	
<ul style="list-style-type: none"> <li>VGA Graphics via ASpeed AST2400</li> </ul>	
<b>I/O Devices</b>	
<ul style="list-style-type: none"> <li>Serial (COM) Header</li> </ul>	<ul style="list-style-type: none"> <li>One (1) serial header (COM1)</li> </ul>
<ul style="list-style-type: none"> <li>SATA 3.0</li> </ul>	<ul style="list-style-type: none"> <li>8C-LN8F/LN10PF: Five (5) SATA 3.0 ports</li> <li>4C-LN8F: Three (3) SATA 3.0 ports</li> <li>4C-LN10PF: One (1) or Three (3) SATA 3.0 ports, selectable in BIOS setup</li> </ul>
<b>Peripheral Devices</b>	
<ul style="list-style-type: none"> <li>Three (3) USB 3.1 Gen 1 ports: two Type-A on I/O back panel (USB0/1) and one Type-A (USB4)</li> <li>Two (2) USB 2.0 ports: one internal header (USB2/3)</li> </ul> <p>*USB 3.1 Gen 1 is also referred to as USB 3.0</p>	
<b>BIOS</b>	
<ul style="list-style-type: none"> <li>128Mb AMI BIOS® SPI Flash BIOS</li> <li>Plug and Play (PnP), SPI dual/quad speed support, rise card auto detection support, ACPI 6.1, SMBIOS 3.0, PCI FW 3.2, UEFI 2.6</li> </ul>	



**Note:** The table above is continued on the next page.

<b>Motherboard Features</b>	
<b>Power Management</b>	
	<ul style="list-style-type: none"> <li>• ACPI power management</li> <li>• CPU fan auto-off in sleep mode</li> <li>• Power button override mechanism</li> <li>• Power-on mode for AC power recovery</li> </ul>
<b>System Health Monitoring</b>	
	<ul style="list-style-type: none"> <li>• Onboard voltage monitors for CPU cores, +3.3V, +5V, +12V, +3.3V Stby, +5V Stby, VBAT, HT, Memory, system temperature, and memory temperature</li> <li>• Status monitor for on/off control</li> <li>• CPU switching phase voltage regulator</li> <li>• CPU thermal trip support</li> </ul>
<b>Fan Control</b>	
	<ul style="list-style-type: none"> <li>• Five 4-pin proprietary fan headers</li> <li>• Fan status monitoring via IPMI connections</li> <li>• Dual cooling zone</li> </ul>
<b>System Management</b>	
	<ul style="list-style-type: none"> <li>• PECCI (Platform Environment Control Interface) 3.2 support</li> <li>• IPMI 2.0</li> <li>• System resource alert via SuperDoctor® 5, Watch Dog, NMI</li> <li>• Chassis Intrusion header and detection</li> <li>• Power supply monitoring</li> </ul>
<b>LED Indicators</b>	
	<ul style="list-style-type: none"> <li>• CPU system overheat</li> <li>• Power / suspend-state indicator LED</li> <li>• Fan fail LED</li> <li>• UID / Remote UID</li> <li>• HDD activity LED</li> <li>• LAN activity LED</li> </ul>
<b>Other</b>	
	<ul style="list-style-type: none"> <li>• RoHS</li> </ul>
<b>Dimensions</b>	
	<ul style="list-style-type: none"> <li>• FlexATX form factor (9" x 7.25") (228.6 mm x 184.15 mm)</li> </ul>



**Note 1:** The CPU maximum thermal design power (TDP) is subject to chassis and heatsink cooling restrictions. For proper thermal management, please check the chassis and heatsink specifications for proper CPU TDP sizing.

**Note 2:** For IPMI configuration instructions, please refer to the Embedded IPMI Configuration User's Guide available at <http://www.supermicro.com/support/manuals/>.

**Figure 1-6.**  
**Chipset Block Diagram**

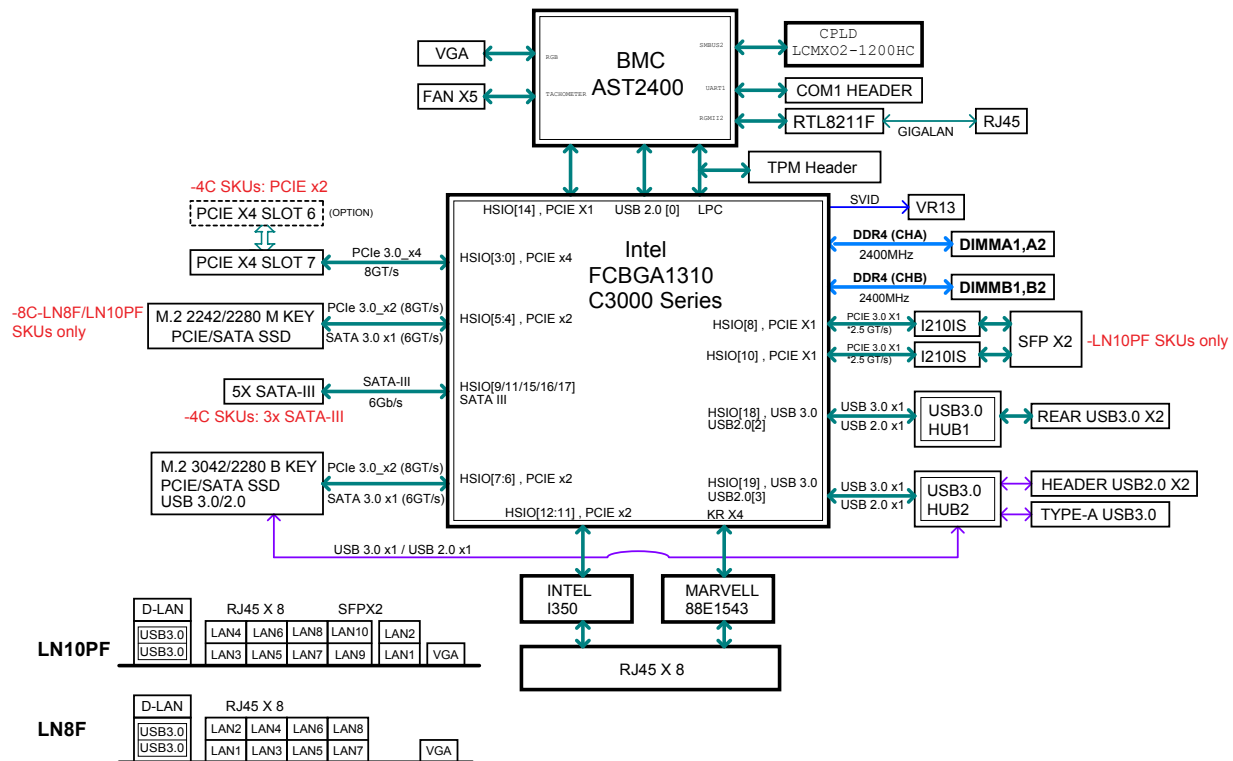

**Note 1:** This is a general block diagram and may not exactly represent the features on your motherboard. See the previous pages for the actual specifications of your motherboard.

**Note 2:** USB 3.1 Gen 1 is also referred to as USB 3.0.

## 1.2 Processor Overview

The Intel Atom C3000 series processor, with up to 8 cores at a 25W TDP on the A2SDV-LN8F/LN10PF series, offers performance, reliability, and high intelligence. As a low-power system-on-a-chip motherboard, the A2SDV-4C/8C-LN8F/LN10PF is optimized for a wide variety of networking workloads and applications.

- ACPI Power Management Logic Support Rev. 6.1
- Intel QuickAssist Technology
- Adaptive Thermal Management/Monitoring
- PCI-E 3.0, SATA 3.0 and M.2 (B-Key and M-Key) slots
- System Management Bus (SMBus) Specification Version 3.0
- Intel VT-x with Extended Page Tables (EPT)
- Intel Virtualization Technology (VT-x)
- Intel Virtualization Technology for Directed I/O (Intel VT-d)
- Intel Trusted Execution Technology (Intel TXT)
- Intel Rapid Storage Technology
- GbE Ethernet with RJ45 and SFP connectors

## 1.3 Special Features

This section describes the health monitoring features of the A2SDV-4C/8C-LN8F/LN10PF motherboard. The motherboard has an onboard System Hardware Monitor chip that supports system health monitoring.

### Recovery from AC Power Loss

The Basic I/O System (BIOS) provides a setting that determines how the system will respond when AC power is lost and then restored to the system. You can choose for the system to remain powered off (in which case you must press the power switch to turn it back on), or for it to automatically return to the power-on state. See the Advanced BIOS Setup section for this setting. The default setting is **Last State**.

## 1.4 System Health Monitoring

This section describes the health monitoring features of the A2SDV-4C/8C-LN8F/LN10PF motherboard. The motherboard has an onboard Baseboard Management Controller (BMC) chip that supports system health monitoring. Once a voltage becomes unstable, a warning is given or an error message is sent to the screen.

### Onboard Voltage Monitors

The onboard voltage monitor will continuously scan crucial voltage levels. Once a voltage becomes unstable, it will give a warning or send an error message to the screen. Users can adjust the voltage thresholds to define the sensitivity of the voltage monitor. Real time readings of these voltage levels are all displayed in BIOS.

### Fan Status Monitor with Firmware Control

The system health monitor embedded in the BMC chip can check the RPM status of the cooling fans. The CPU and chassis fans are controlled via IPMI. Refer to the below table for available fan modes to choose the most appropriate one for nominal operation.

### Environmental Temperature Control

System Health sensors monitor temperatures and voltage settings of onboard processors and the system in real time via the IPMI interface. Whenever the temperature of the CPU or the system exceeds a user-defined threshold, system/CPU cooling fans will be turned on to prevent the CPU or the system from overheating



**Note:** To avoid possible system overheating, please provide adequate airflow to your system.

### System Resource Alert

This feature is available when used with SuperDoctor 5® in the Windows OS or in the Linux environment. SuperDoctor is used to notify the user of certain system events. For example, you can configure SuperDoctor to provide you with warnings when the system temperature, CPU temperatures, voltages and fan speeds go beyond a predefined range.

**Figure 1-7. Fan Speed Modes**

Fan Mode	Description
Full Speed	Use this mode to set fan speed at full speed for maximum system cooling
Standard	Use this mode to set fan speed for normal system cooling
Heavy I/O	Use this mode to set fan speed for higher PCI-E add-on card area cooling
Optimal	Use this mode to set fan speed for normal PCI-E add-on card area cooling
PUE2	Use this mode to set fan speed for best power efficiency and maximum noise reduction

## 1.5 ACPI Features

ACPI stands for Advanced Configuration and Power Interface. The ACPI specification defines a flexible and abstract hardware interface that provides a standard way to integrate power management features throughout a computer system, including its hardware, operating system and application software. This enables the system to automatically turn on and off peripherals such as CD-ROMs, network cards, hard disk drives and printers.

In addition to enabling operating system-directed power management, ACPI also provides a generic system event mechanism for Plug and Play, and an operating system-independent interface for configuration control. ACPI leverages the Plug and Play BIOS data structures, while providing a processor architecture-independent implementation that is compatible with Windows® 2012.

## 1.6 Power Supply

As with all computer products, a stable power source is necessary for proper and reliable operation. It is even more important for processors that have high CPU clock rates. In areas where noisy power transmission is present, you may choose to install a line filter to shield the computer from noise. It is recommended that you also install a power surge protector to help avoid problems caused by power surges.

## 1.7 Super I/O

The Super I/O (Aspeed AST2400 chip) includes a data separator, write pre-compensation circuitry, decode logic, data rate selection, a clock generator, drive interface control logic and interrupt and DMA logic. The wide range of functions integrated onto the Super I/O greatly reduces the number of components required for interfacing with floppy disk drives.

The Super I/O provides one high-speed, 16550 compatible serial communication port (UART), which supports serial infrared communication. The UART includes a 16-byte send/receive FIFO, a programmable baud rate generator, complete modem control capability and a processor interrupt system. The UART provides legacy speed with baud rate of up to 115.2 Kbps as well as an advanced speed with baud rates of 250 K, 500 K, or 1 Mb/s, which supports higher speed modems.

The Super I/O provides functions that comply with ACPI (Advanced Configuration and Power Interface), which includes support of legacy and ACPI power management through a SMI or SCI function pin. It also features auto power management to reduce power consumption.

The IRQs, DMAs and I/O space resources of the Super I/O can be flexibly adjusted to meet ISA PnP requirements, which support ACPI and APM (Advanced Power Management).

# Chapter 2

## Installation

### 2.1 Static-Sensitive Devices

Electrostatic Discharge (ESD) can damage electronic components. To prevent damage to your motherboard, it is important to handle it very carefully. The following measures are generally sufficient to protect your equipment from ESD.

#### Precautions

- Use a grounded wrist strap designed to prevent static discharge.
- Touch a grounded metal object before removing the board from the antistatic bag.
- Handle the board by its edges only; do not touch its components, peripheral chips, memory modules or gold contacts.
- When handling chips or modules, avoid touching their pins.
- Put the motherboard and peripherals back into their antistatic bags when not in use.
- For grounding purposes, make sure your computer chassis provides excellent conductivity between the power supply, the case, the mounting fasteners and the motherboard.
- Use only the correct type of onboard CMOS battery. Do not install the onboard battery upside down to avoid possible explosion.

#### Unpacking

The motherboard is shipped in antistatic packaging to avoid static damage. When unpacking the motherboard, make sure that the person handling it is static protected.

## 2.2 Motherboard Installation

All motherboards have standard mounting holes to fit different types of chassis. Make sure that the locations of all the mounting holes for both the motherboard and the chassis match. Although a chassis may have both plastic and metal mounting fasteners, metal ones are highly recommended because they ground the motherboard to the chassis. Make sure that the metal standoffs click in or are screwed in tightly.

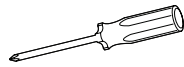

Phillips Screwdriver (1)



Phillips Screws (6)



Standoffs (6)  
Only if Needed

### Tools Needed

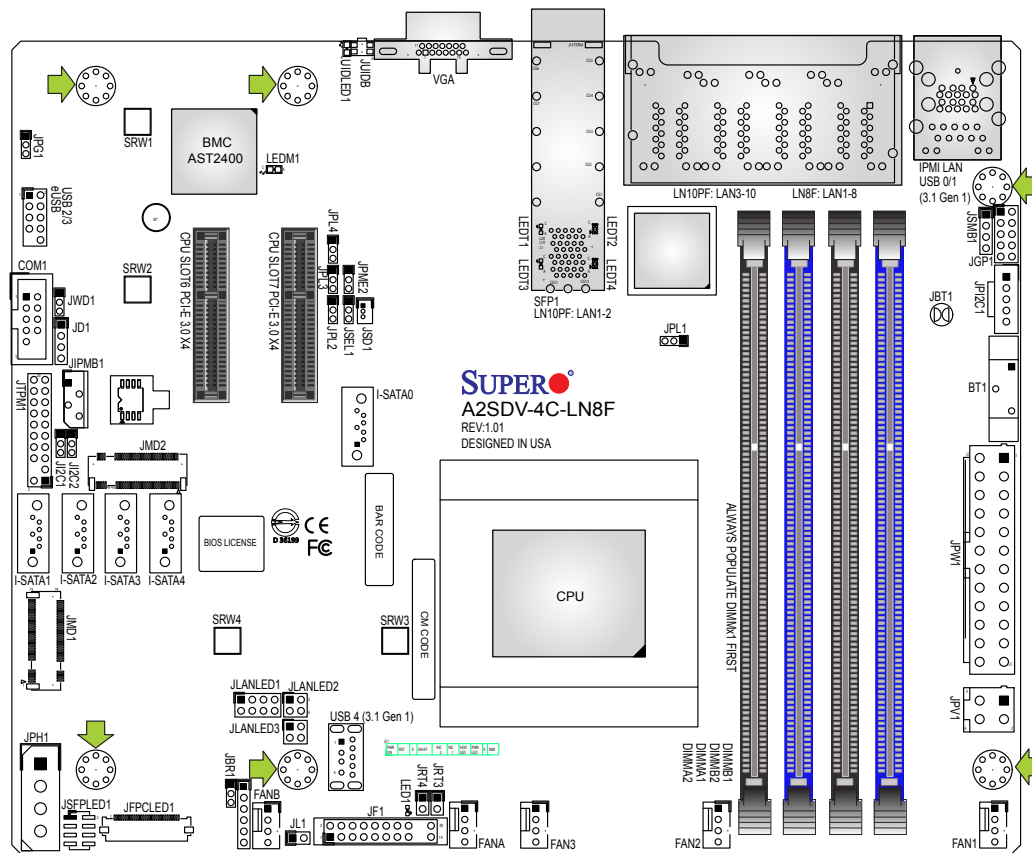

### Location of Mounting Holes



**Note:** 1) To avoid damaging the motherboard and its components, please do not use a force greater than 8 lb/inch on each mounting screw during motherboard installation. 2) Some components are very close to the mounting holes. Please take precautionary measures to avoid damaging these components when installing the motherboard to the chassis.

## Installing the Motherboard

1. Locate the mounting holes on the motherboard. See the previous page for the location.

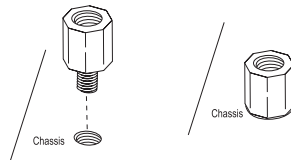

2. Locate the matching mounting holes on the chassis. Align the mounting holes on the motherboard against the mounting holes on the chassis.

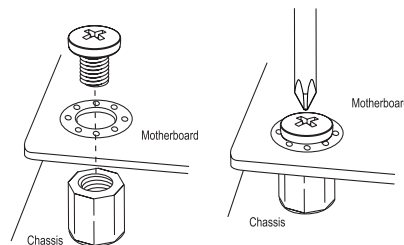

3. Install standoffs in the chassis as needed.
4. Install the motherboard into the chassis carefully to avoid damaging other motherboard components.
5. Using the Phillips screwdriver, insert a Phillips head #6 screw into a mounting hole on the motherboard and its matching mounting hole on the chassis.
6. Repeat Step 5 to insert #6 screws into all mounting holes.
7. Make sure that the motherboard is securely placed in the chassis.

 **Note:** Images displayed are for illustration only. Your chassis or components might look different from those shown in this manual.

## 2.3 Memory Support and Installation



**Note:** Refer to the motherboard product page for the list of supported memory.



**Important:** Exercise extreme care when installing or removing DIMM modules to prevent any possible damage.

### Memory Support

The A2SDV-4C/8C-LN8F/LN10PF motherboard supports up to 256GB of ECC RDIMM or 64GB of Non-EC/ECC UDIMM DDR4 memory in four memory slots. Populating these DIMM slots with memory modules of the same type and size will result in interleaved memory, which will improve memory performance.

### DIMM Module Population Configuration

For optimal memory performance, follow the table below when populating memory.

Memory Population (Balanced)				
DIMMA1	DIMMB1	DIMMA2	DIMMB2	Total System Memory
4GB	4GB			8GB
4GB	4GB	4GB	4GB	16GB
8GB	8GB			16GB
8GB	8GB	8GB	8GB	32GB
16GB	16GB			32GB
16GB	16GB	16GB	16GB	64GB
32GB	32GB			64GB
32GB	32GB	32GB	32GB	128GB
64GB	64GB			128GB
64GB	64GB	64GB	64GB	256GB

## DIMM Module Population Sequence

When installing memory modules, the DIMM slots should be populated in the following order: DIMMA1, DIMMB1, DIMMA2, DIMMB2.

- Always use DDR4 DIMM modules of the same type, size and speed.
- Mixed DIMM speeds can be installed. However, all DIMMs will run at the speed of the slowest DIMM.
- The motherboard will support odd-numbered modules (one or three modules installed). However, for best memory performance, install DIMM modules in pairs to activate memory interleaving.

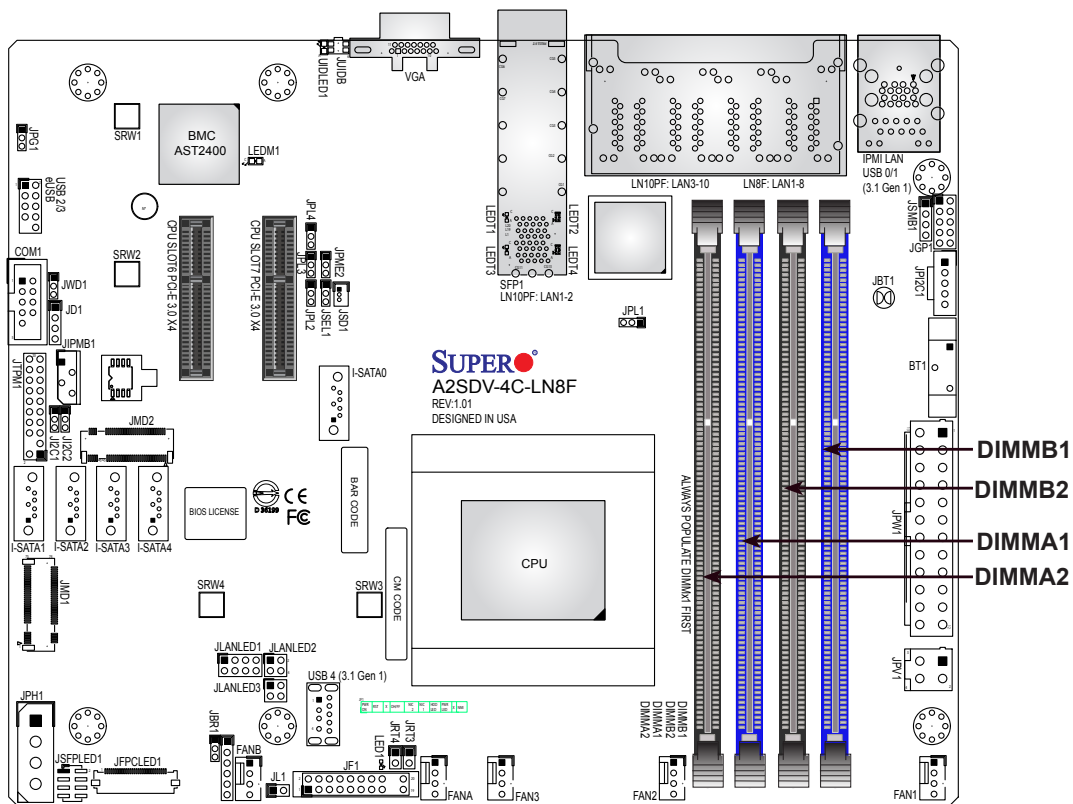

## DIMM Installation

1. Insert the desired number of DIMMs into the memory slots, starting with DIMMA1, DIMMB1, DIMMA2, DIMMB2. For best performance, please use the memory modules of the same type and speed.
2. Push the release tabs outwards on both ends of the DIMM slot to unlock it.
3. Align the key of the DIMM module with the receptive point on the memory slot.
4. Align the notches on both ends of the module against the receptive points on the ends of the slot.
5. Press both ends of the module straight down into the slot until the module snaps into place.
6. Press the release tabs to the lock positions to secure the DIMM module into the slot.

## DIMM Removal

Press both release tabs on the ends of the DIMM module to unlock it. Once the DIMM module is loosened, remove it from the memory slot.

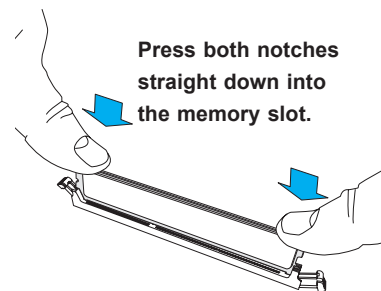
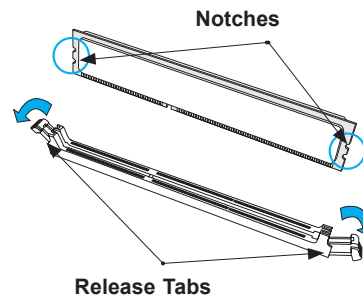
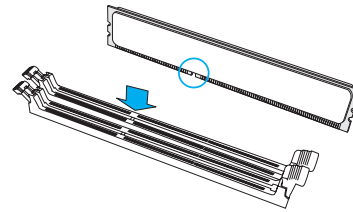
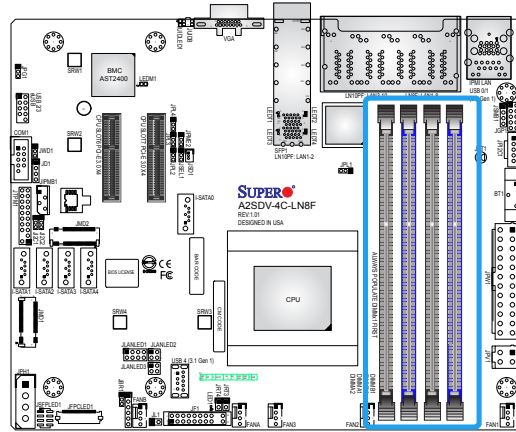

## 2.4 Rear I/O Ports

See Figure 2-1 below for the locations and descriptions of the various I/O ports on the rear of the motherboard.

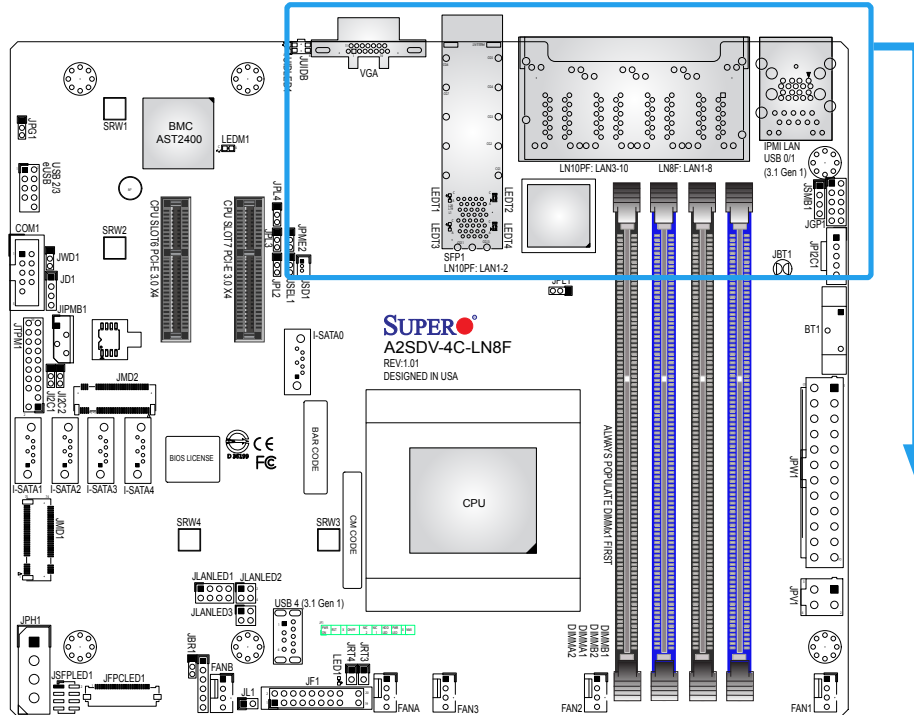
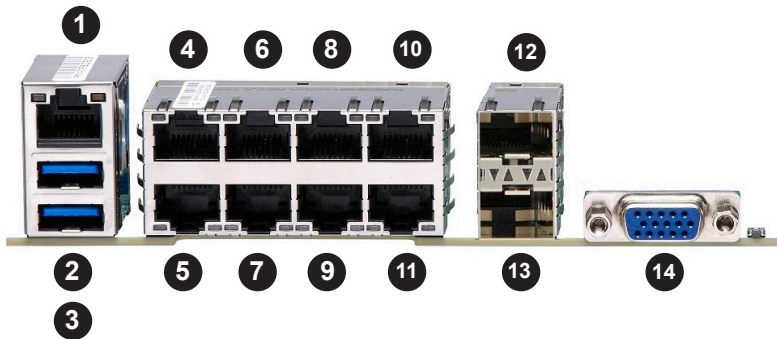

Figure 2-1. I/O Port Locations and Definitions



#	-LN8F Description	-LN10PF Description
1	IPMI LAN	IPMI LAN
2	USB1	USB1
3	USB0	USB0
4	LAN2	LAN4
5	LAN1	LAN3
6	LAN4	LAN6
7	LAN3	LAN5
8	LAN6	LAN8
9	LAN5	LAN7
10	LAN8	LAN10
11	LAN7	LAN9
12	N/A	LAN2
13	N/A	LAN1
14	VGA	VGA

### VGA Port

A VGA port is located on the I/O back panel. Use this port to connect to a compatible VGA display.

### LAN Ports

There are eight LAN ports on the -LN8F motherboard and 10 LAN ports on the -LN10PF motherboard. The LN10PF supports two SFP connectors on LAN1~2 and eight RJ45 connectors on LAN3~10. The LN8F supports eight RJ45 GbE LAN on LAN1~8. The motherboard also offers one IPMI LAN port.

- **LN8F SKUs:** LAN1~8 (RJ45)
- **LN10PF SKUs:** LAN1~2 (SFP) + LAN3~10 (RJ45)

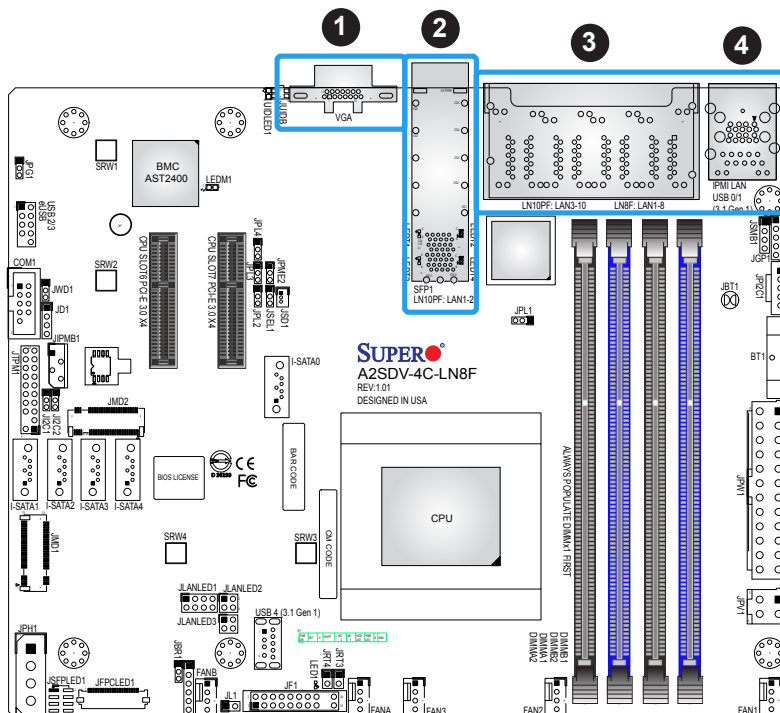

1. VGA Port
2. LAN1-2 (LN10PF)
3. LAN1-8 (LN8F)  
LAN3-10 (LN10PF)
4. IPMI LAN

## COM Header

The motherboard has one COM header for front access to provide a serial connection.

COM Header Pin Definitions			
Pin#	Definition	Pin#	Definition
1	DCD	6	DSR
2	RXD	7	RTS
3	TXD	8	CTS
4	DTR	9	RI
5	Ground	10	N/A

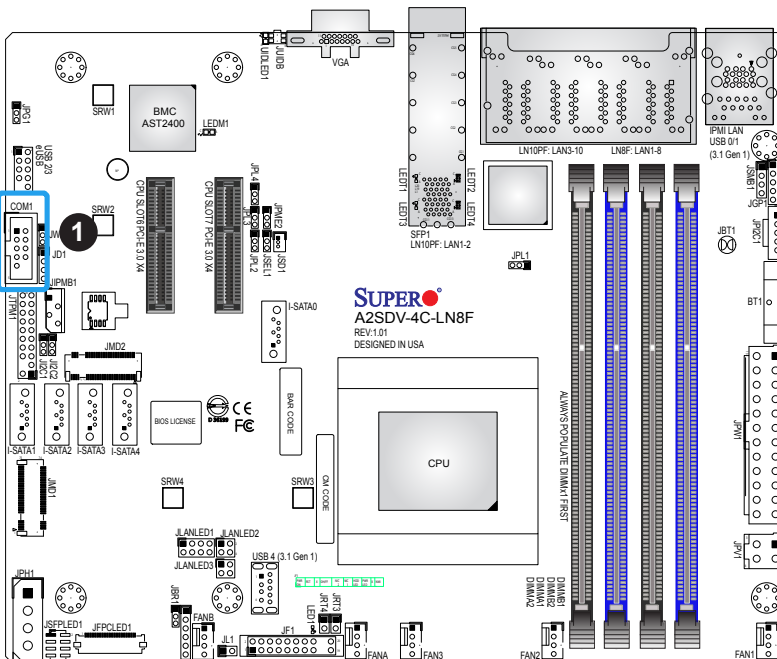

1. COM1

### Universal Serial Bus (USB) Ports

There are three USB 3.1 Gen 1 Type-A (USB0/1 rear and USB4 header) and one USB 2.0 header (USB2/3). The onboard header can be used to provide front side USB access with a cable (not included). USB 3.1 Gen 1 is also referred to as USB 3.0

Type A USB 3.1 Gen 1 Pin Definitions	
Pin#	Definition
1	VBUS
2	D-
3	D+
4	Ground
5	StdA_SSRX-
6	StdA_SSRX+
7	GND_DRAIN
8	StdA_SSTX-
9	StdA_SSTX+

USB 2.0 Header (USB2/3) Pin Definitions			
Pin#	Definition	Pin#	Definition
1	+5V	2	+5V
3	USB_N	4	USB_N
5	USB_P	6	USB_P
7	Ground	8	Ground
9	Key	10	NC

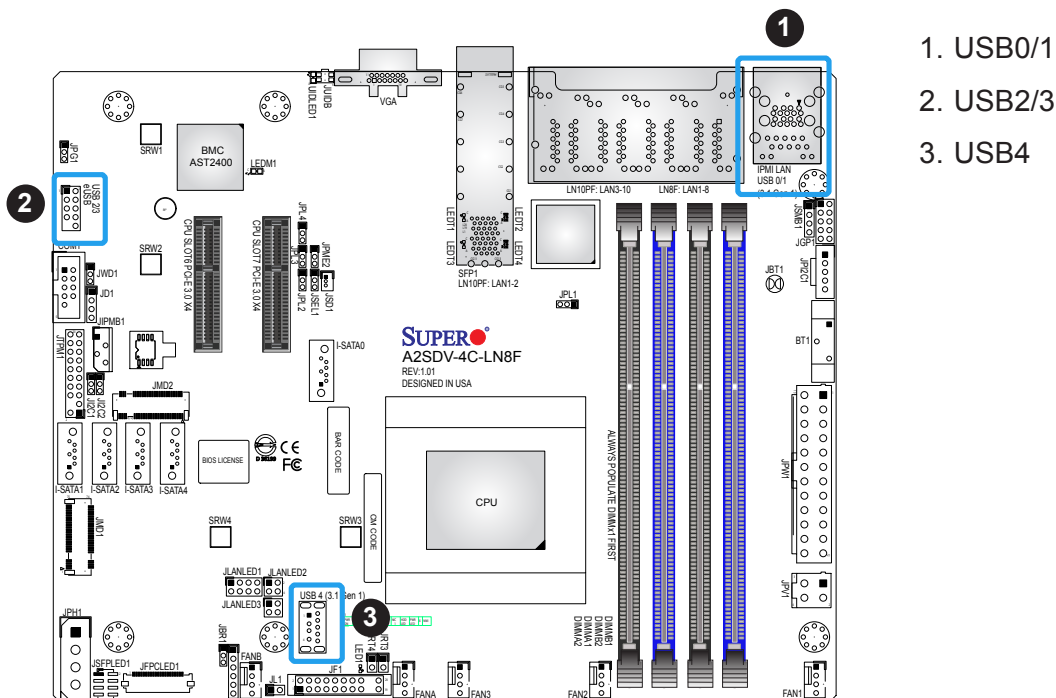

## Unit Identifier Button/UID LED Indicator

A Unit Identifier button and an LED indicator are located on the motherboard. The UID button (JUIDB) is located next to the VGA port on the back panel. The UID LED is located at UIDLED1, next to the UID button. When you press the UID button, the UID LED will be turned on. Press the UID button again to turn off the LED indicator. The LED indicator provides easy identification of a system unit that may be in need of service.

 **Note:** UID can also be triggered via IPMI on the motherboard. For more information on IPMI, please refer to the IPMI User's Guide posted on our website at <https://www.supermicro.com/support/manuals/>.

UID Button Pin Definitions	
Pin#	Definition
1	Ground
2	Ground
3	Button In
4	Button In

UID LED Pin Definitions	
Color	Status
Blue: On	Unit Identified

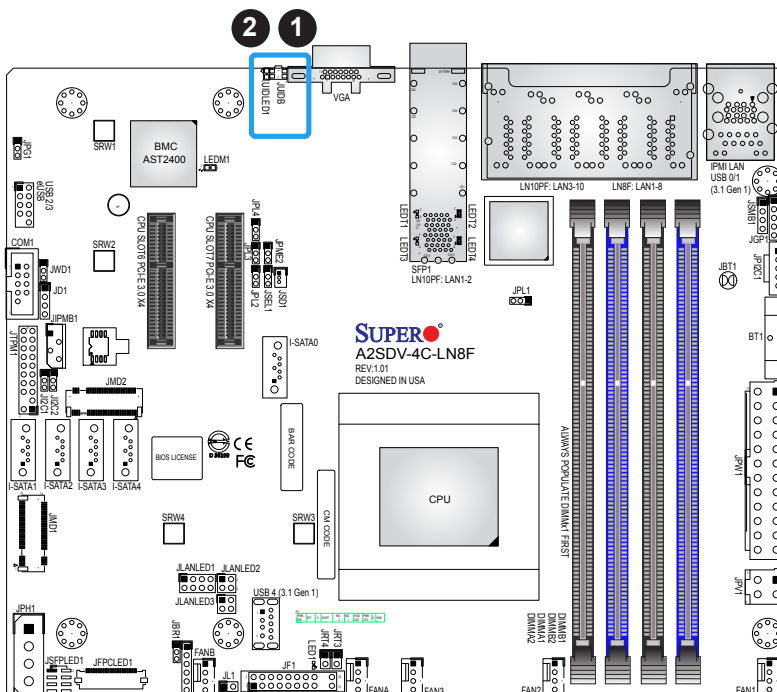

1. UID Button
2. UID LED

## 2.5 Front Control Panel

JF1 contains header pins for various buttons and indicators that are normally located on a control panel at the front of the chassis. These connectors are designed specifically for use with Supermicro chassis. See the figure below for the descriptions of the front control panel buttons and LED indicators.

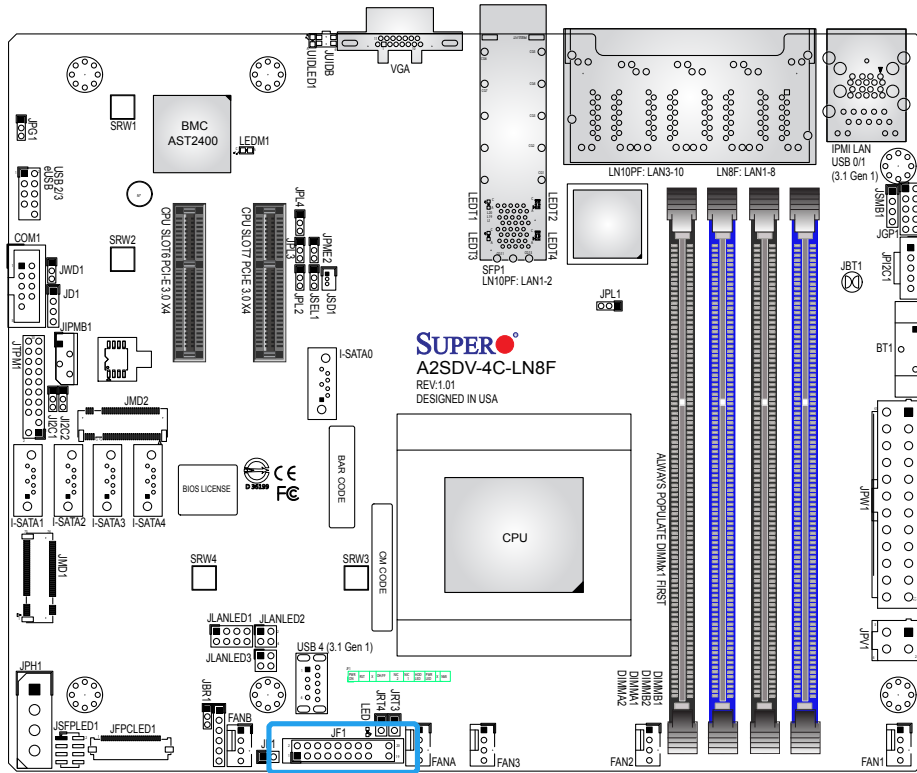

Figure 2-2. JF1 Header Pins

	1	2	
<b>PWR</b> } Power Button	○	○	Ground
<b>Reset</b> } Reset Button	○	○	Ground
3.3V	○	○	Power Fail LED
UID LED	○	○	OH/Fan Fail LED
3.3V Stby	○	○	LAN2 Activity LED
3.3V Stby	○	○	LAN1 Activity LED
3.3V Stby	○	○	HDD LED
3.3V	○	○	PWR LED
X	○	○	X
NMI	○	○	Ground
	19	20	

## Power Button

The Power Button connection is located on pins 1 and 2 of JF1. Momentarily contacting both pins will power on/off the system. This button can also be configured to function as a suspend button (with a setting in the BIOS - see Chapter 4). To turn off the power when the system is in suspend mode, press the button for 4 seconds or longer. Refer to the table below for pin definitions.

Power Button Pin Definitions (JF1)	
Pin#	Definition
1	Signal
2	Ground

## Reset Button

The Reset Button connection is located on pins 3 and 4 of JF1. Attach it to a hardware reset switch on the computer case. Refer the table below for pin definitions.

Reset Button Pin Definitions (JF1)	
Pin#	Definition
3	Reset
4	Ground

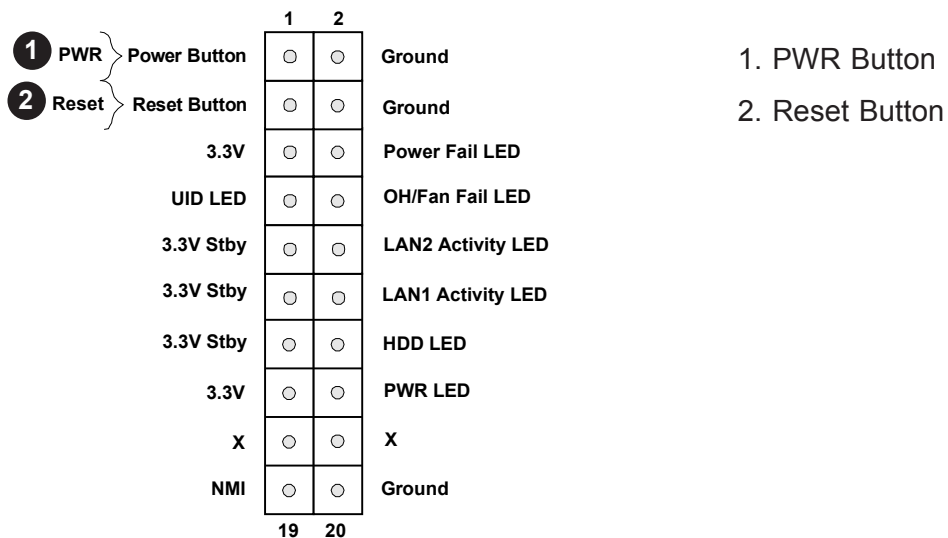

### Overheat (OH)/Fan Fail

Connect an LED cable to pins 7 and 8 to use the Overheat/Fan Fail LED connections. The LED on pin 8 provides warnings of overheat or fan failure. Refer to the tables below for pin definitions.

OH/Fan Fail Indicator Status	
State	Definition
Off	Normal
On	Overheat
Flashing	Fan Fail

OH/Fan Fail LED Pin Definitions (JF1)	
Pin#	Definition
7	UID LED
8	OH/Fan Fail LED

### LAN1/LAN2 Activity LED

The LAN LED connection for LAN port 1 is located on pins 11 and 12 of JF1, and the LED connection for LAN port 2 is on pins 9 and 10. Attach the NIC LED cables here to display network activity. Refer to the table below for pin definitions.

LAN1/LAN2 LED Pin Definitions (JF1)	
Pin#	Definition
9	3.3V Stby
10	LAN2 Active LED
11	3.3V Stby
12	LAN1 Active LED

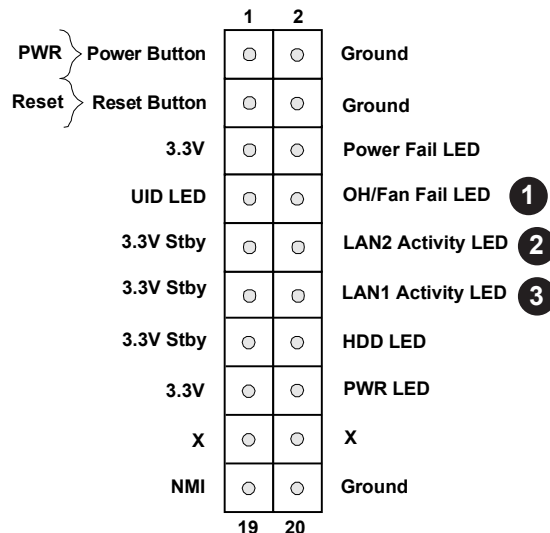

1. OH/Fan Fail LED
2. LAN2 Activity LED
3. LAN1 Activity LED

## HDD LED

The HDD LED connection is located on pins 13 and 14 of JF1. Attach a cable to show hard drive activity status. Refer to the table below for pin definitions.

HDD LED Pin Definitions (JF1)	
Pin#	Definition
13	3.3V
14	HDD LED

## Power LED

The Power LED connection is located on pins 15 and 16 of JF1. Refer to the table below for pin definitions.

Power LED Pin Definitions (JF1)	
Pin#	Definition
15	3.3V
16	PWR LED

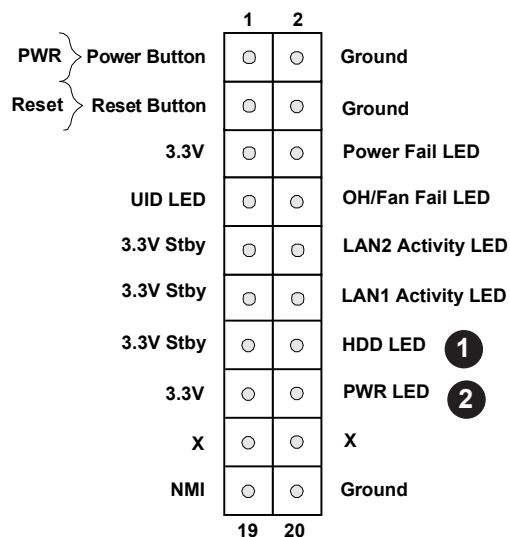

1. HDD LED
2. PWR LED

### NMI Button

The non-maskable interrupt button header is located on pins 19 and 20 of JF1. Refer to the table below for pin definitions.

NMI Button Pin Definitions (JF1)	
Pins	Definition
19	NMI
20	Ground

### Power Fail LED

Connect an LED cable to Power Fail connections on pins 5 and 6 of JF1 to provide warnings for a power failure. Refer to the table below for pin definitions.

OH/Fan Fail Indicator Status	
Pin #	Definition
5	3.3V
6	PWR Fail

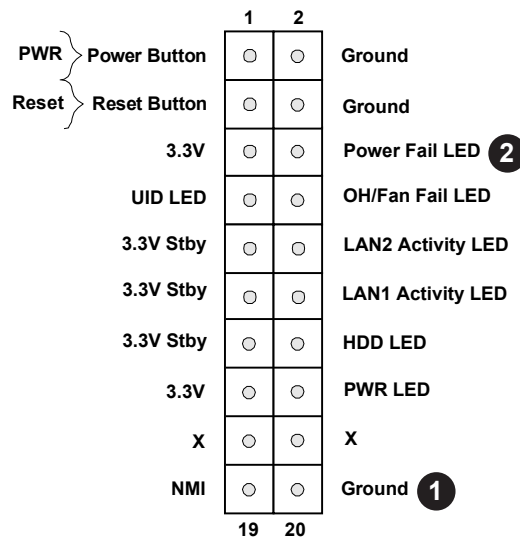

1. NMI
2. Power Fail LED

## 2.6 Connectors

### Power Connections

#### Main ATX Power Supply Connector

The primary power supply connector (JPW1) meets the ATX SSI EPS 12V specification.

ATX Power 24-pin Connector Pin Definitions			
Pin#	Definition	Pin#	Definition
13	+3.3V	1	+3.3V
14	-12V	2	+3.3V
15	Ground	3	Ground
16	PS_ON	4	+5V
17	Ground	5	Ground
18	Ground	6	+5V
19	Ground	7	Ground
20	Res (NC)	8	PWR_OK
21	+5V	9	5VSB
22	+5V	10	+12V
23	+5V	11	+12V
24	Ground	12	+3.3V

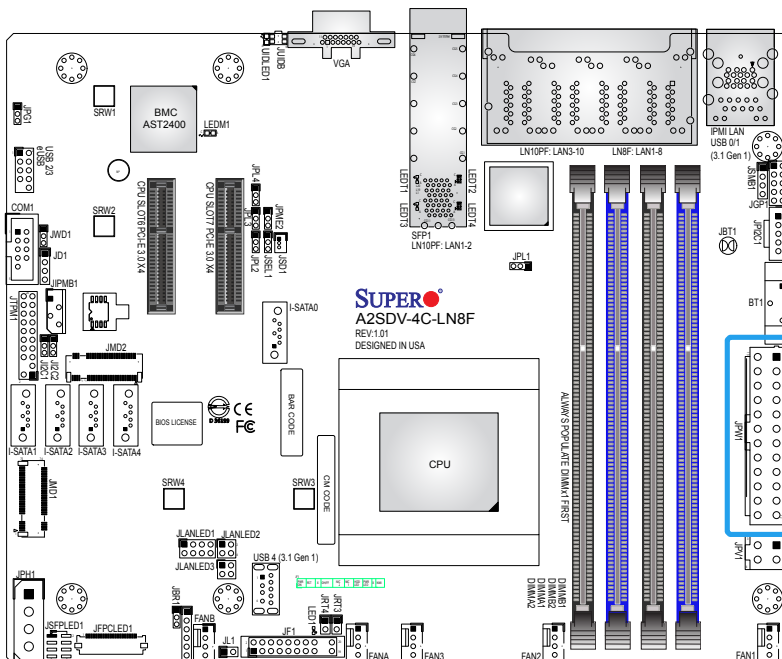

1. 24-Pin ATX Main PWR

### 12V DC Power Connector

The 4-pin (JPV1) connector is used to provide alternative power for a special enclosure when the 24-pin ATX power is not in use.

+12V 4-pin Power Pin Definitions	
Pin#	Definition
1 - 2	Ground
3 - 4	+12V

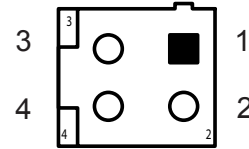

### HDD Power Connector

JPH1 is a 4-pin power connector for HDD use. It provides power from the motherboard to the onboard HDD.

4-pin HDD Power Pin Definitions	
Pin#	Definition
1	12V
2-3	GND
4	5V

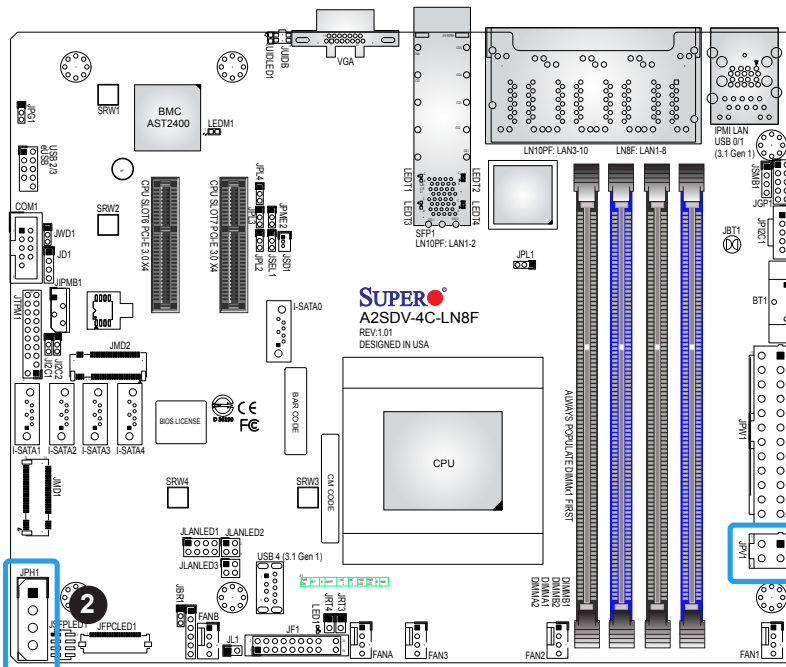
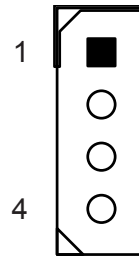

1. 12V DC Power Input
2. HDD Power Connector

## Headers

### Fan Headers

The A2SDV-4C/8C-LN8F/LN10PF has five 4-pin fan headers (FAN1 ~ FAN4, FANA, FANB). These headers are backwards-compatible with the traditional 3-pin fans. However, fan speed control is available for 4-pin fans only by Thermal Management via the IPMI 2.0 interface. Refer to the table below for pin definitions.

Fan Header Pin Definitions	
Pin#	Definition
1	Ground (Black)
2	2.5A/+12V (Red)
3	Tachometer
4	PWM_Control

### Speaker Header

JD1 is the speaker header. Connect the cable of the external speaker to pins 1-4.

Speaker Connector Pin Definitions	
Pin Setting	Definition
Pins 1-4	Speaker

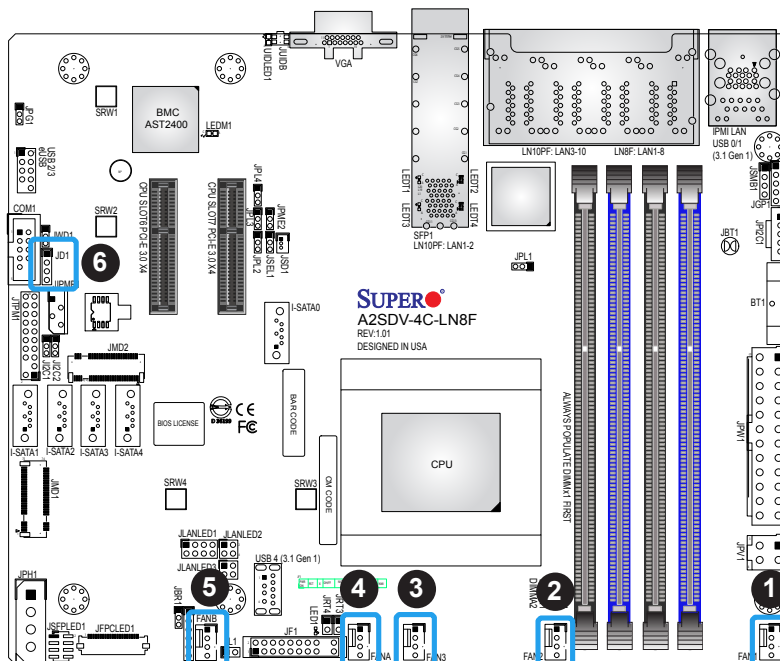

1. FAN1
2. FAN2
3. FAN3
4. FANA
5. FANB
6. Speaker Header

### Chassis Intrusion

A Chassis Intrusion header is located at JL1 on the motherboard. Attach the appropriate cable from the chassis to inform you of a chassis intrusion when the chassis is opened. Refer to the table below for pin definitions.

Chassis Intrusion Pin Definitions	
Pin#	Definition
1	Intrusion Input
2	Ground

### General Purpose I/O Header

JGP1 is a 10-pin general purpose I/O header. Each pin can be configured to be an input or output pin. The GPIO is controlled via the PCA9554 8-bit GPIO expansion. The base address is 0xF040(D31:F4).

JGP1 Header Pin Definitions		
Pin#	Definition	
1	+5V	+5V
2	Ground	Ground
3	GP0	GPP_E0
4	GP1	GPP_F1
5	GP2	GPP_E1
6	GP3	GPP_F2
7	GP4	GPP_E2
8	GP5	GPP_F3
9	GP6	GPP_F0
10	GP7	GPP_F4

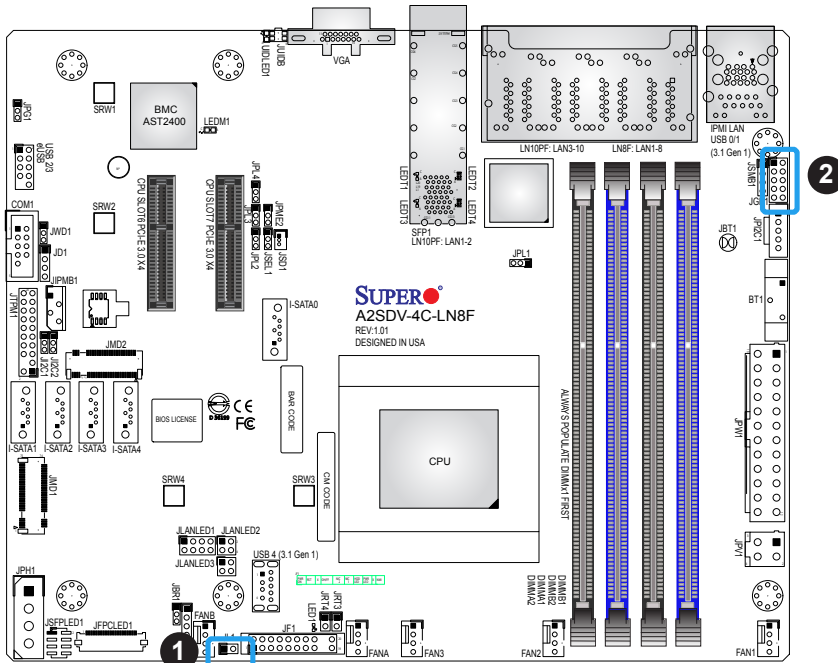

1. Chassis Intrusion
2. General Purpose I/O

## Disk On Module Power Connector

The Disk-On-Module (DOM) power connector at JSD1 provides 5V power to a solid-state DOM storage device connected to one of the SATA ports. Refer the table below for pin definitions.

DOM Power Pin Definitions	
Pin#	Definition
1	5V
2	Ground
3	Ground

## System Management Bus Header

A System Management Bus header for additional slave devices or sensors is located at JSMB1. See the table below for pin definitions.

SMBus Header Pin Definitions	
Pin#	Definition
1	Data
2	Ground
3	Clock
4	NC

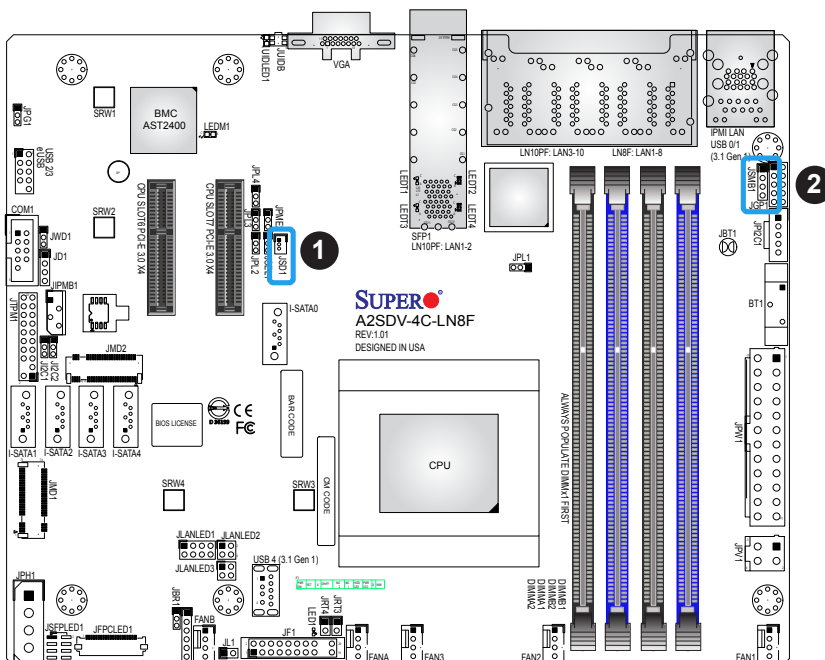

1. SATA DOM PWR
2. SMBus Header

### BMC External I2C Header

A System Management Bus header for IPMI 2.0 is located at JIPMB1. Connect the appropriate cable here to use the IPMB I<sup>2</sup>C connection on your system. Refer to the table below for pin definitions.

External I <sup>2</sup> C Header Pin Definitions	
Pin#	Definition
1	Data
2	GND
3	Clock
4	NC

### Power SMB (I<sup>2</sup>C) Header

The Power System Management Bus (I<sup>2</sup>C) connector (JPI<sup>2</sup>C1) monitors the power supply, fan, and system temperatures. Refer to the table below for pin definitions.

Power SMB Header Pin Definitions	
Pin#	Definition
1	Clock
2	Data
3	PMBUS_Alert
4	Ground
5	NC

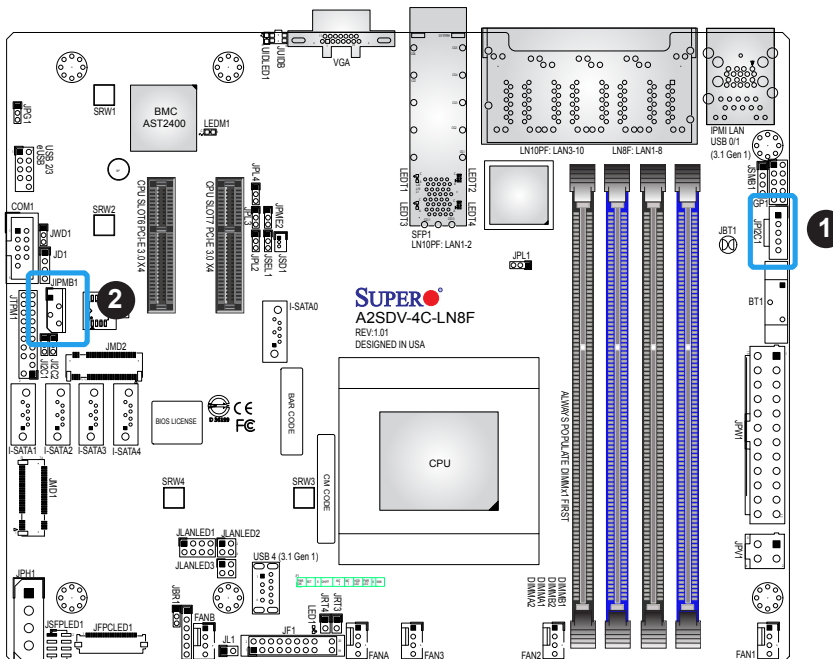

1. Power SMB Header
2. BMC External Header

## TPM/Port 80 Header

A Trusted Platform Module (TPM)/Port 80 header is located at JTPM1 to provide TPM support and a Port 80 connection. Use this header to enhance system performance and data security. Refer to the table below for pin definitions.

Trusted Platform Module Header Pin Definitions			
Pin#	Definition	Pin#	Definition
1	LCLK	2	GND
3	LFRAME#	4	No Pin
5	LRESET#	6	+5V (X)
7	LAD3	8	LAD2
9	3.3V	10	LAD1
11	LAD0	12	GND
13	SMB_CLK (X)	14	SMB_DAT (X)
15	P3V3_STBY	16	SERIRQ
17	GND	18	LPC_CLKRUN (X)
19	SUS_STAT_N	20	LDRQ# (X)

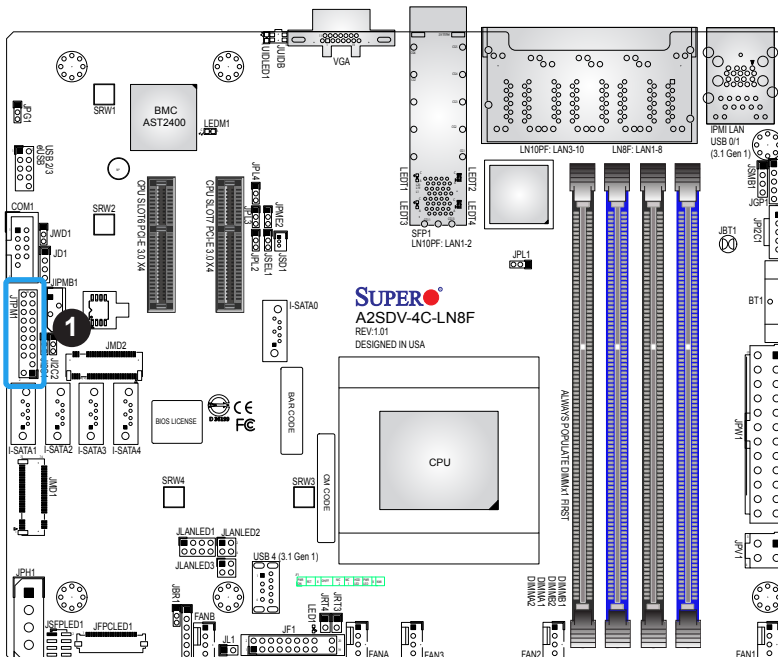
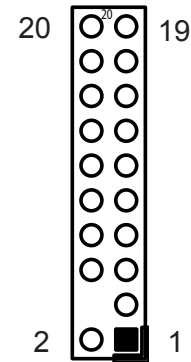

### 1. TPM Header

**SATA Ports**

**A2SDV-8C-LN8F/LN10PF:** Five SATA 3.0 ports (I-SATA0/1/2/3/4) are available.

**A2SDV-4C-LN8F:** Three SATA 3.0 ports (I-SATA0/1/2) are available.

**A2SDV-4C-LN10PF:** Up to three SATA 3.0 ports (I-SATA0/1/2) are available. I-SATA1/2 are disabled when PCI-E x2 expansion slot6 or slot7 is enabled in the BIOS setup.

SATA 3.0 Port Pin Definitions	
Pin#	Signal
1	Ground
2	SATA_TXP
3	SATA_TXN
4	Ground
5	SATA_RXN
6	SATA_RXP
7	Ground

**M.2 B-Key**

JMD1 is a B-key connector supporting a PCI-E 3.0 x2/SATA/USB device in 3042 or 2280 lengths.

**M.2 M-Key (A2SDV-8C-LN8F/LN10PF only)**

JMD2 is a M-key connector supporting a PCI-E 3.0 x2/SATA device in 2042 or 2280 lengths.

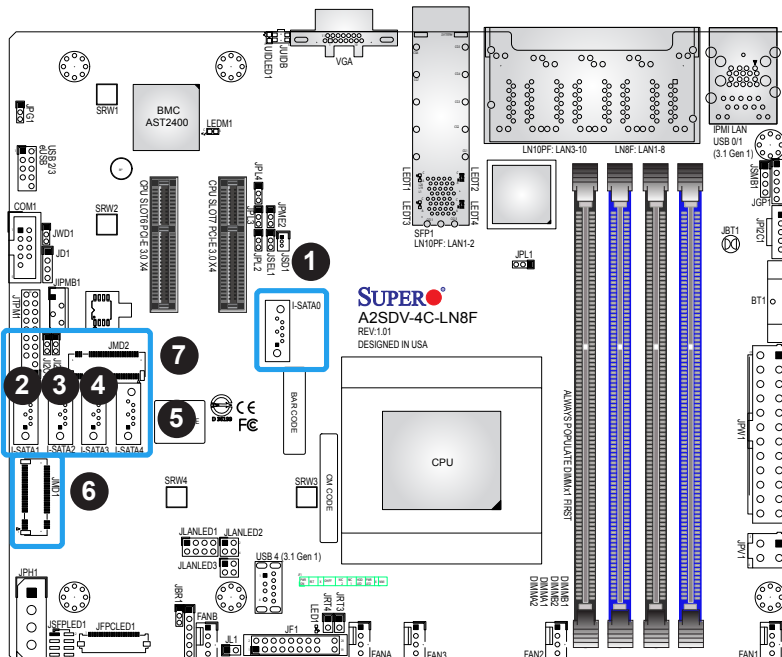

1. I-SATA0
2. I-SATA1
3. I-SATA2
4. I-SATA3
5. I-SATA4
6. JMD1 (M.2 B-Key)
7. JMD2 (M.2 M-Key)

## Thermal Diode Headers

JRT3 is the thermal diode 1 header, and JRT4 is the thermal diode 2 header. They are thermal sensor headers that provide additional system temperature monitoring.

Thermal Diode 1 Pin Definitions	
Pin#	Definition
1	TD1_P
2	TD1_N

Thermal Diode 2 Pin Definitions	
Pin#	Definition
1	TD1_P
2	TD1_N

## LAN Port Activity LED

### JLANLED1

Activity LED for LAN ports 3/4/5/6.

### JLANLED2

Activity LED for LAN ports 7/8.

### JLANLED3 (-LN10PF SKUs only)

Activity LED for LAN ports 9/10

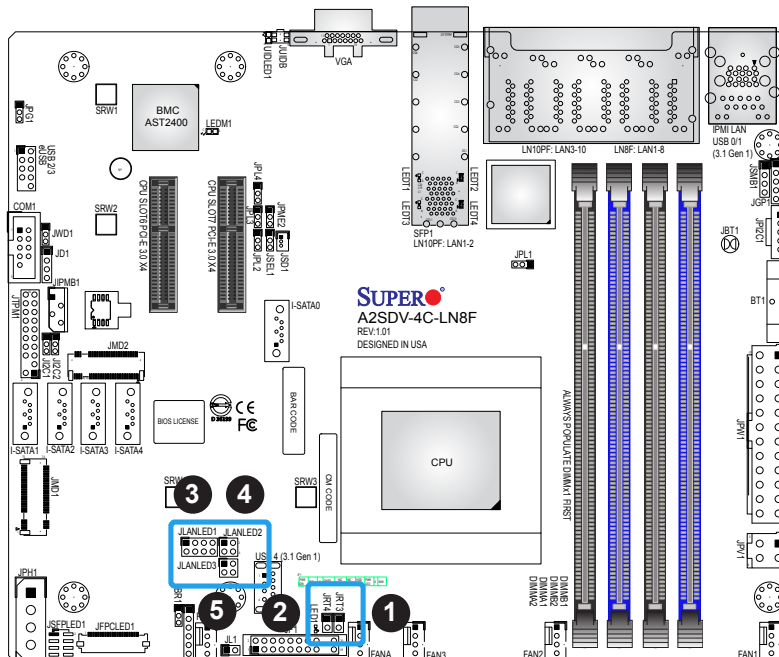

1. Thermal Diode 1
2. Thermal Diode 2
3. JLANLED1
4. JLANLED2
5. JLANLED3

### Front RJ45 Link and Activity LED Header

JFPCLED1 is the 1GbE RJ45 link and activity LED header. Attach a cable from this header to the Supermicro LED board (Part Number: FPB-FPE300-LED10) to display the status of the RJ45 LAN link and activity LED.

### Front SFP Link and Activity LED Header (-LN10PF SKUs only)

JSPFLED1 is the 1GbE SFP link and activity LED header. Attach a cable from this header to the Supermicro LED board (Part Number: FPB-FPE300-LED10) to display the status of the SFP link and activity LED.

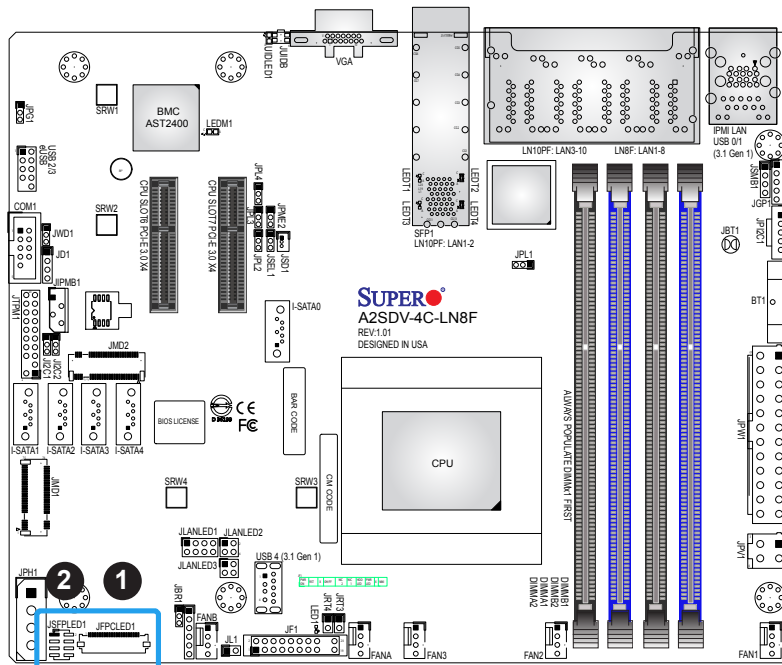

1. RJ45 LED Header
2. SFP LED Header

## 2.7 Jumper Settings

### How Jumpers Work

To modify the operation of the motherboard, jumpers can be used to choose between optional settings. Jumpers create shorts between two pins to change the function of the connector. Pin 1 is identified with a square solder pad on the printed circuit board. See the diagram below for an example of jumping pins 1 and 2. Refer to the motherboard layout page for jumper locations.

 **Note:** On two-pin jumpers, Closed means the jumper is on and Open means the jumper is off the pins.

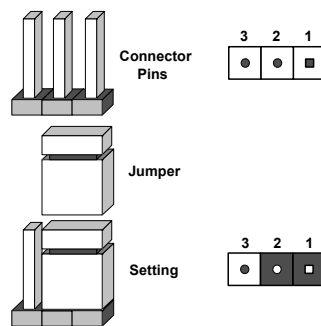

### CMOS Clear

JBT1 is used to clear the CMOS. Instead of pins, this jumper consists of contact pads to prevent accidental clearing of the CMOS. To clear the CMOS, use a metal object such as a small screwdriver to touch both pads at the same time to short the connection.



**Note:** Shut down the system and then short JBT1 to clear the CMOS.

### LAN Port Enable/Disable

#### JPL1 (-LN10PF SKUs only)

Use JPL1 to enable/disable LAN1 SFP port.

#### JPL2 (-LN10PF SKUs only)

Use JPL1 to enable/disable LAN2 SFP port.

#### JPL3

Use JPL3 to enable/disable LAN1-4 RJ45 ports on -LN8F SKUs and LAN3-6 RJ45 sports on -LN10PFS SKUs.

#### JPL4

Use JPL4 to enable/disable LAN5-8 RJ45 ports on -LN8F SKUs and LAN7-10 RJ45 sports on -LN10PFS SKUs.

LAN Enable/Disable Jumper Settings	
Jumper Setting	Definition
Pins 1-2	Enabled (Default)
Pins 2-3	Disabled

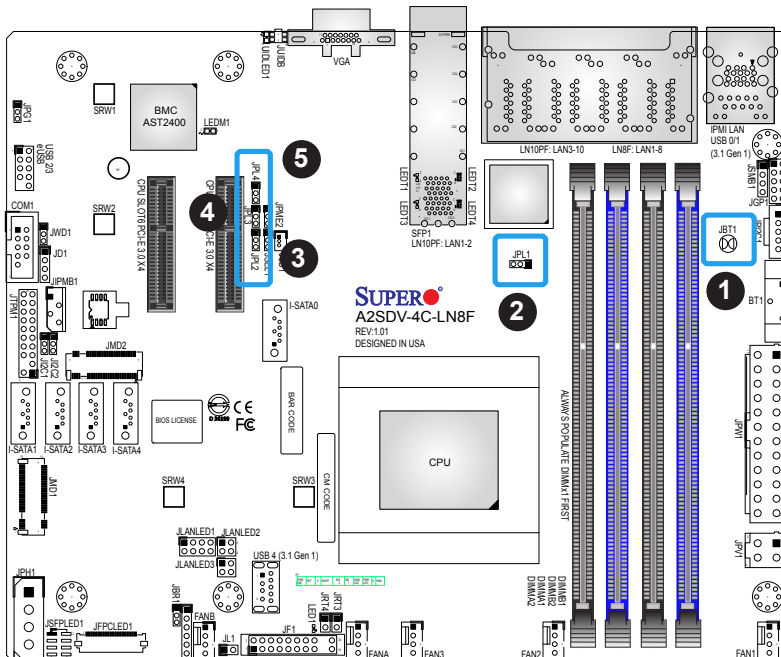

1. CMOS Clear
2. JPL1
3. JPL2
4. JPL3
5. JPL4

## Watch Dog

JWD1 controls the Watch Dog function. Watch Dog is a monitor that can reboot the system when a software application hangs. Jumping pins 1-2 will cause Watch Dog to reset the system if an application hangs. Jumping pins 2-3 will generate a non-maskable interrupt signal for the application that hangs. Watch Dog must also be enabled in BIOS. The default setting is Reset.

 **Note:** When Watch Dog is enabled, users need to write their own application software to disable it.

Watch Dog Jumper Settings	
Jumper Setting	Definition
Pins 1-2	Reset (Default)
Pins 2-3	NMI
Open	Disabled

## SMBus to PCI Slots

Jumpers JI<sup>2</sup>C1 and JI<sup>2</sup>C2 allow you to connect the System Management Bus (I<sup>2</sup>C) to the PCI-E slots. Both jumpers must be set to the same setting (JI<sup>2</sup>C1 controls the clock and JI<sup>2</sup>C2 controls the data).

SMBus to PCI Slots Jumper Settings		
JI <sup>2</sup> C1 Setting	JI <sup>2</sup> C2 Setting	Definition
JI <sup>2</sup> C1: Pins 1-2	JI <sup>2</sup> C2: Pins 1-2	Enabled
JI <sup>2</sup> C1: Pins 2-3	JI <sup>2</sup> C2: Pins 2-3	Disabled (Default)

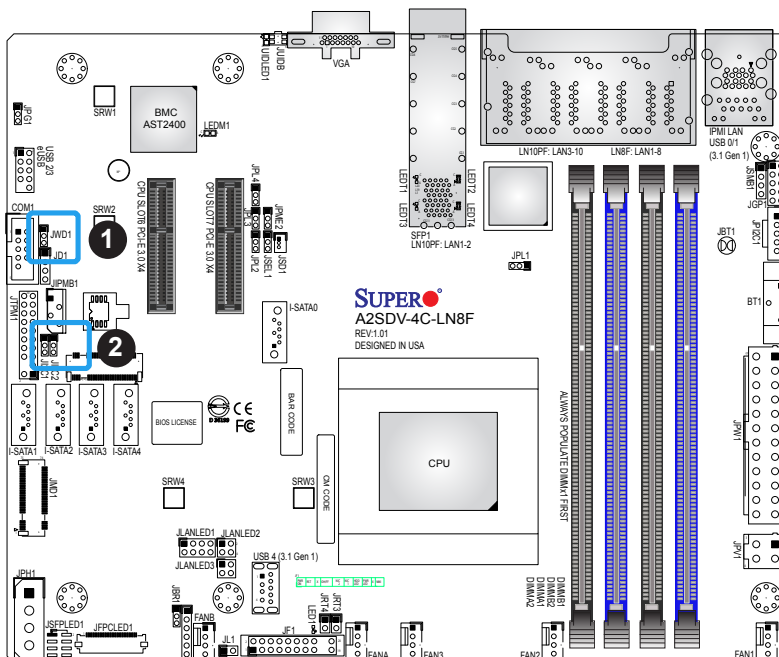

1. Watch Dog
2. SMBus to PCI-E Slots

### Manufacturing Mode Select

Close pins 2-3 of jumper JPME2 to bypass SPI flash security and force the system to operate in the manufacturing mode, which will allow the user to flash the system firmware from a host server for system setting modifications. Refer to the table below for jumper settings.

Manufacturing Mode Jumper Settings	
Jumper Setting	Definition
Pins 1-2	Normal (Default)
Pins 2-3	Manufacturing Mode

### VGA Enable/Disable

Use jumper JPG1 to enable or disable the onboard VGA connector. Refer to the table below for jumper settings.

VGA Enable/Disable Jumper Settings	
Jumper Setting	Definition
Pins 1-2	Enabled (Default)
Pins 2-3	Disabled

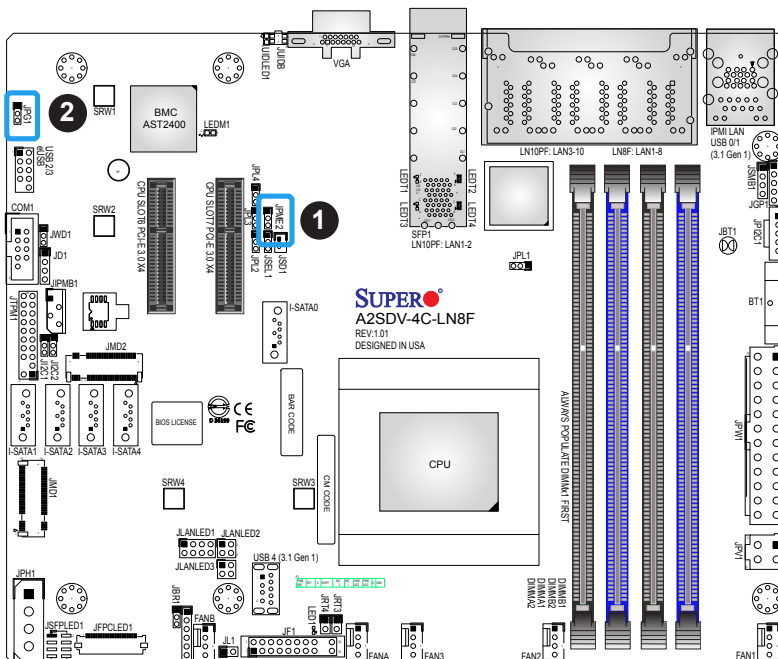

1. Manufacturing Mode
2. VGA Enable

## BIOS Recovery

Close pins 2-3 of jumper JBR1 for BIOS recovery. The default setting is on pins 1 and 2 for normal operation. Refer to the table below for jumper settings. The default setting is Normal.

BIOS Recovery Jumper Settings	
Jumper Setting	Definition
Pins 1-2	Normal
Pins 2-3	BIOS Recovery

## PCI-E Slot Selection

Use jumper JSEL1 to select between PCI-E slot 6 or slot 7. Only one PCI-E slot can be used at a time.

- **8C-LN8F/LN10PF**: PCI-E 3.0 x4
- **4C-LN8F**: PCI-E 3.0 x2
- **4C-LN10PF**: PCI-E 3.0 x2. Slot will be disabled if I-SATA1/2 ports are enabled in the BIOS setup.

PCI-E Slot Selection Jumper Settings	
Jumper Setting	Definition
Pins 1-2	Slot 7 (Default)
Pins 2-3	Slot 6

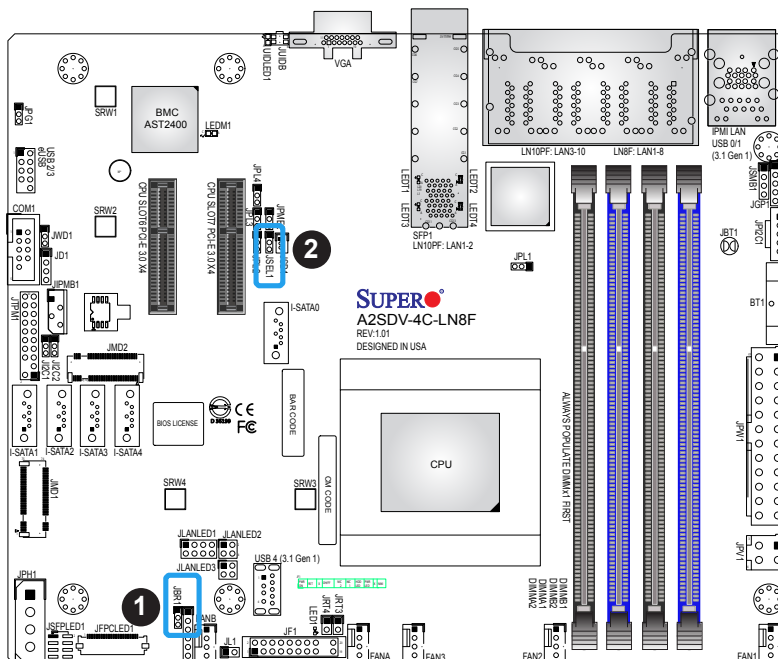

1. BIOS Recovery
2. PCI-E Slot Selection

## 2.8 LED Indicators

### LAN LEDs

Eight RJ45 LAN ports and two SFP LAN ports are located on the I/O back panel. Each Ethernet LAN port has two LEDs. One LED indicates activity, while the other Link LED may be green, amber, or off to indicate the speed of the connection. Refer to the tables below for more information. When the system is in the S1/S3/S4/S5 states, the LAN Link LED will be in the solid on state.

Activity Indicator		
Color	Status	Definition
Off	No Connection	
Yellow	Flashing	Active

1G RJ45 LAN Link	
LED Color	Definition
Off	No Connection or 10 Mb/s
Green	100 Mb/s
Amber	1 Gb/s

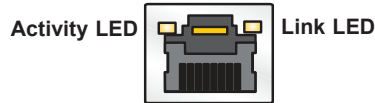

1G SFP LAN Link LED (LAN9 - LAN10)	
LED Color	Definition
Off	No Connection
Amber	1G



Activity Indicator		
Color	Status	Definition
Off	No Connection	
Yellow	Flashing	Active

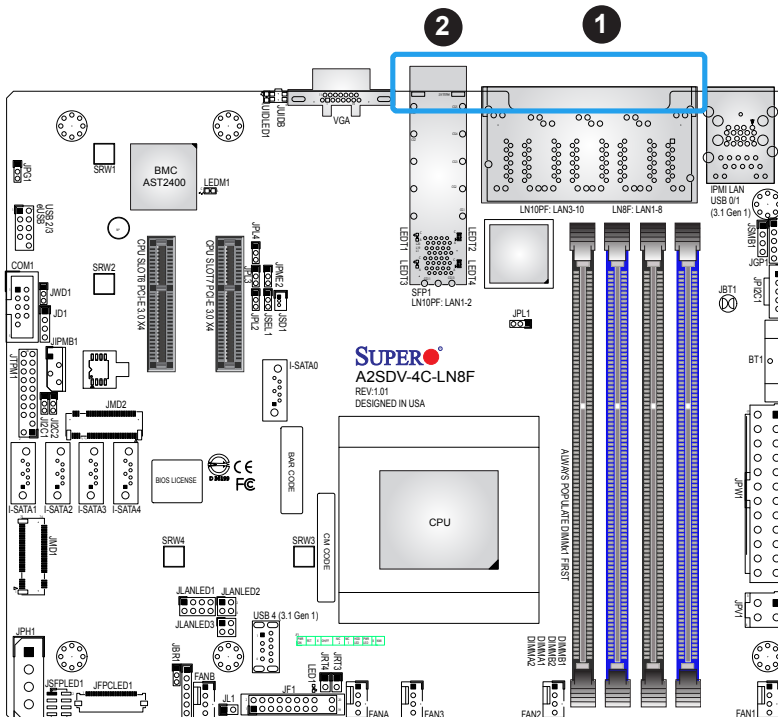

1. RJ45 LAN LED
2. SFP LAN LED (-LN10PF only)

## Power LED

LED1 is an onboard power LED. When this LED is lit, it means power is present on the motherboard. In suspend mode, this LED will blink on and off. Be sure to turn off the system and unplug the power cord(s) before removing or installing components.

Onboard Power LED Indicator	
LED Color	Definition
Off	System Off (power cable not connected)
Green	System On

## BMC Heartbeat LED

LED1 is the BMC heartbeat LED. When the LED is blinking green, BMC is working. Refer to the table below for the LED status.

BMC Heartbeat LED Indicator	
LED Color	Definition
Blinking	BMC Normal
Green	

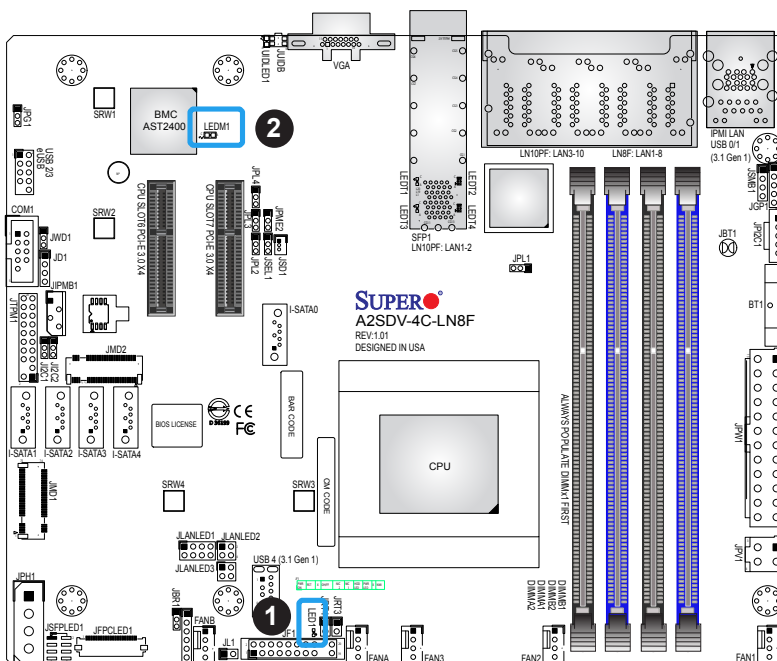

1. Onboard PWR LED
2. BMC Heartbeat LED

## Chapter 3

# Troubleshooting

### 3.1 Troubleshooting Procedures

Use the following procedures to troubleshoot your system. If you have followed all of the procedures below and still need assistance, refer to the 'Technical Support Procedures' and/or 'Returning Merchandise for Service' section(s) in this chapter. Always disconnect the AC power cord before adding, changing or installing any non hot-swap hardware components.

#### **Before Power On**

1. Make sure that there are no short circuits between the motherboard and chassis.
2. Disconnect all ribbon/wire cables from the motherboard, including those for the keyboard and mouse.
3. Remove all add-on cards.
4. Install the CPU (making sure it is fully seated) and connect the front panel connectors to the motherboard.

#### **No Power**

1. Make sure that there are no short circuits between the motherboard and the chassis.
2. Make sure that the ATX power connectors are properly connected.
3. Check that the 115V/230V switch, if available, on the power supply is properly set.
4. Turn the power switch on and off to test the system, if applicable.
5. The battery on your motherboard may be old. Check to verify that it still supplies ~3VDC. If it does not, replace it with a new one.

#### **No Video**

1. If the power is on but you have no video, remove all add-on cards and cables.
2. Use the speaker to determine if any beep codes are present. Refer to Appendix A for details on beep codes.

3. Remove all memory modules and turn on the system (if the alarm is on, check the specs of memory modules, reset the memory or try a different one).

## System Boot Failure

If the system does not display POST or does not respond after the power is turned on, check the following:

1. Check for any error beep from the motherboard speaker.
  - If there is no error beep, try to turn on the system without DIMM modules installed. If there is still no error beep, replace the motherboard.
  - If there are error beeps, clear the CMOS settings by unplugging the power cord and contacting both pads on the CMOS clear jumper (JBT1). (Refer to Section 2-8 in Chapter 2.)
2. Remove all components from the motherboard, especially the DIMM modules. Make sure that system power is on and that memory error beeps are activated.
3. Turn on the system with only one DIMM module installed. If the system boots, check for bad DIMM modules or slots by following the Memory Errors Troubleshooting procedure in this chapter.

## Memory Errors

When a no-memory beep code is issued by the system, check the following:

1. Make sure that the memory modules are compatible with the system and that the DIMMs are properly and fully installed. Click on the Tested Memory List link on the motherboard product page to see a list of supported memory.
2. Check if different speeds of DIMMs have been installed. It is strongly recommended that you use the same RAM type and speed for all DIMMs in the system.
3. Make sure that you are using the correct type of DIMM modules recommended by the manufacturer.
4. Check for bad DIMM modules or slots by swapping a single module among all memory slots and check the results.
5. Make sure that all memory modules are fully seated in their slots. Follow the instructions given in Section 2-4 in Chapter 2.
6. Please follow the instructions given in the DIMM population tables listed in Section 2-4 to install your memory modules.

## Losing the System's Setup Configuration

1. Make sure that you are using a high-quality power supply. A poor-quality power supply may cause the system to lose the CMOS setup information. Refer to Section 2-7 for details on recommended power supplies.
2. The battery on your motherboard may be old. Check to verify that it still supplies ~3VDC. If it does not, replace it with a new one. If the above steps do not fix the setup configuration problem, contact your vendor for repairs.

## When the System Becomes Unstable

### ***A. If the system becomes unstable during or after OS installation, check the following:***

1. CPU/BIOS support: Make sure that your CPU is supported and that you have the latest BIOS installed in your system.
2. Memory support: Make sure that the memory modules are supported by testing the modules using memtest86 or a similar utility.



**Note:** Click on the Tested Memory List link on the motherboard product page to see a list of supported memory.

3. HDD support: Make sure that all hard disk drives (HDDs) work properly. Replace the bad HDDs with good ones.
4. System cooling: Check the system cooling to make sure that all heatsink fans and CPU/system fans, etc., work properly. Check the hardware monitoring settings in the IPMI to make sure that the CPU and system temperatures are within the normal range. Also check the front panel Overheat LED and make sure that it is not on.
5. Adequate power supply: Make sure that the power supply provides adequate power to the system. Make sure that all appropriate power connectors are connected. Please refer to our website for more information on the minimum power requirements.
6. Proper software support: Make sure that the correct drivers are used.

### ***B. If the system becomes unstable before or during OS installation, check the following:***

1. Source of installation: Make sure that the devices used for installation are working properly, including boot devices such as CD/DVD.
2. Cable connection: Check to make sure that all cables are connected and working properly.

3. Using the minimum configuration for troubleshooting: Remove all unnecessary components (starting with add-on cards first), and use the minimum configuration (but with the CPU and a memory module installed) to identify the trouble areas. Refer to the steps listed in Section A above for proper troubleshooting procedures.
4. Identifying bad components by isolating them: If necessary, remove a component in question from the chassis, and test it in isolation to make sure that it works properly. Replace a bad component with a good one.
5. Check and change one component at a time instead of changing several items at the same time. This will help isolate and identify the problem.
6. To find out if a component is good, swap this component with a new one to see if the system will work properly. If so, then the old component is bad. You can also install the component in question in another system. If the new system works, the component is good and the old system has problems.

## 3.2 Technical Support Procedures

Before contacting Technical Support, please take the following steps. Also, please note that as a motherboard manufacturer, Supermicro also sells motherboards through its channels, so it is best to first check with your distributor or reseller for troubleshooting services. They should know of any possible problems with the specific system configuration that was sold to you.

1. Please go through the Troubleshooting Procedures and Frequently Asked Questions (FAQ) sections in this chapter or see the FAQs on our website (<http://www.supermicro.com/FAQ/index.php>) before contacting Technical Support.
2. BIOS upgrades can be downloaded from our website ([http://www.supermicro.com/ResourceApps/BIOS\\_IPMI\\_Intel.html](http://www.supermicro.com/ResourceApps/BIOS_IPMI_Intel.html)).
3. If you still cannot resolve the problem, include the following information when contacting Supermicro for technical support:
  - Motherboard model and PCB revision number
  - BIOS release date/version (This can be seen on the initial display when your system first boots up.)
  - System configuration
4. An example of a Technical Support form is on our website at <http://www.supermicro.com/RmaForm/>.
  - Distributors: For immediate assistance, please have your account number ready when placing a call to our Technical Support department. We can be reached by email at [support@supermicro.com](mailto:support@supermicro.com).

### 3.3 Frequently Asked Questions

**Question: What type of memory does my motherboard support?**

**Answer:** The motherboard supports up to 256GB of RDIMM or 64GB of Non-ECC/ECC UDIMM DDR4 memory. To enhance memory performance, do not mix memory modules of different speeds and sizes. Please follow all memory installation instructions given on Section 2-3 in Chapter 2.

**Question: How do I update my BIOS?**

**Answer:** It is recommended that you **do not** upgrade your BIOS if you are not experiencing any problems with your system. Updated BIOS files are located on our website at [http://www.supermicro.com/ResourceApps/BIOS\\_IPMI\\_Intel.html](http://www.supermicro.com/ResourceApps/BIOS_IPMI_Intel.html). Please check our BIOS warning message and the information on how to update your BIOS on our website. Select your motherboard model and download the BIOS file to your computer. Also, check the current BIOS revision to make sure that it is newer than your BIOS before downloading. You can choose from the zip file and the .exe file. If you choose the zip BIOS file, please unzip the BIOS file onto a bootable USB device. Run the batch file using the format FLASH.BAT filename.rom from your bootable USB device to flash the BIOS. Then, your system will automatically reboot.

**Warning:** Do not shut down or reset the system while updating the BIOS to prevent possible system boot failure!)



**Note:** The SPI BIOS chip used on this motherboard cannot be removed. Send your motherboard back to our RMA Department at Supermicro for repair. For BIOS Recovery instructions, please refer to the AMI BIOS Recovery Instructions posted at <http://www.supermicro.com/support/manuals/>.

## 3.4 Battery Removal and Installation

### Battery Removal

To remove the onboard battery, follow the steps below:

1. Power off your system and unplug your power cable.
2. Locate the onboard battery as shown below.
3. Using a tool such as a pen or a small screwdriver, push the battery lock outwards to unlock it. Once unlocked, the battery will pop out from the holder.
4. Remove the battery.

### Proper Battery Disposal

Please handle used batteries carefully. Do not damage the battery in any way; a damaged battery may release hazardous materials into the environment. Do not discard a used battery in the garbage or a public landfill. Please comply with the regulations set up by your local hazardous waste management agency to dispose of your used battery properly.

### Battery Installation

1. To install an onboard battery, follow steps 1 and 2 above and continue below:
2. Identify the battery's polarity. The positive (+) side should be facing up.
3. Insert the battery into the battery holder and push it down until you hear a click to ensure that the battery is securely locked.



**Important:** When replacing a battery, be sure to only replace it with the same type.

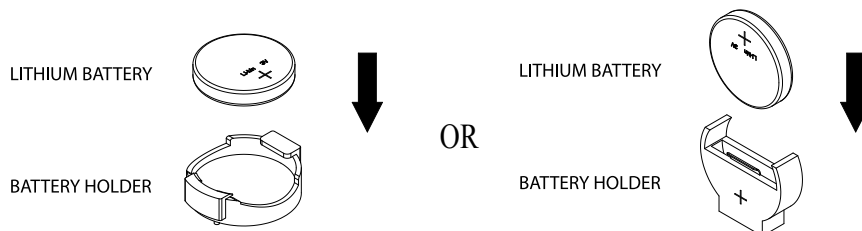

## 3.5 Returning Merchandise for Service

A receipt or copy of your invoice marked with the date of purchase is required before any warranty service will be rendered. You can obtain service by calling your vendor for a Returned Merchandise Authorization (RMA) number. When returning to the manufacturer, the RMA number should be prominently displayed on the outside of the shipping carton and mailed prepaid or hand-carried. Shipping and handling charges will be applied for all orders that must be mailed when service is complete.

For faster service, RMA authorizations may be requested online (<http://www.supermicro.com/support/rma/>).

This warranty only covers normal consumer use and does not cover damages incurred in shipping or from failure due to the alteration, misuse, abuse or improper maintenance of products.

During the warranty period, contact your distributor first for any product problems.

## Chapter 4

# BIOS

### 4.1 Introduction

This chapter describes the AMIBIOS™ Setup utility for the A2SDV-LN8F/LN10PF series motherboard. The BIOS is stored on a chip and can be easily upgraded using a flash program.



**Note:** Due to periodic changes to the BIOS, some settings may have been added or deleted and might not yet be recorded in this manual. Please refer to the Manual Download area of our website for any changes to the BIOS that may not be reflected in this manual.

#### Starting the Setup Utility

To enter the BIOS Setup Utility, hit the <Delete> key while the system is booting up. (In most cases, the <Delete> key is used to invoke the BIOS setup screen. There are a few cases when other keys are used, such as <F1>, <F2>, etc.) Each main BIOS menu option is described in this manual.

The Main BIOS screen has two main frames. The left frame displays all the options that can be configured. “Grayed-out” options cannot be configured. The right frame displays the key legend. Above the key legend is an area reserved for a text message. When an option is selected in the left frame, it is highlighted in white. Often a text message will accompany it. (Note that BIOS has default text messages built in. We retain the option to include, omit, or change any of these text messages.) Settings printed in **Bold** are the default values.

A " ►" indicates a submenu. Highlighting such an item and pressing the <Enter> key will open the list of settings within that submenu.

The BIOS setup utility uses a key-based navigation system called hot keys. Most of these hot keys (<F1>, <Enter>, <ESC>, <Arrow> keys, etc.) can be used at any time during the setup navigation process.

## 4.2 Main Setup

When you first enter the AMI BIOS setup utility, you will enter the Main setup screen. You can always return to the Main setup screen by selecting the Main tab on the top of the screen. The Main BIOS setup screen is shown below and the following features will be displayed:

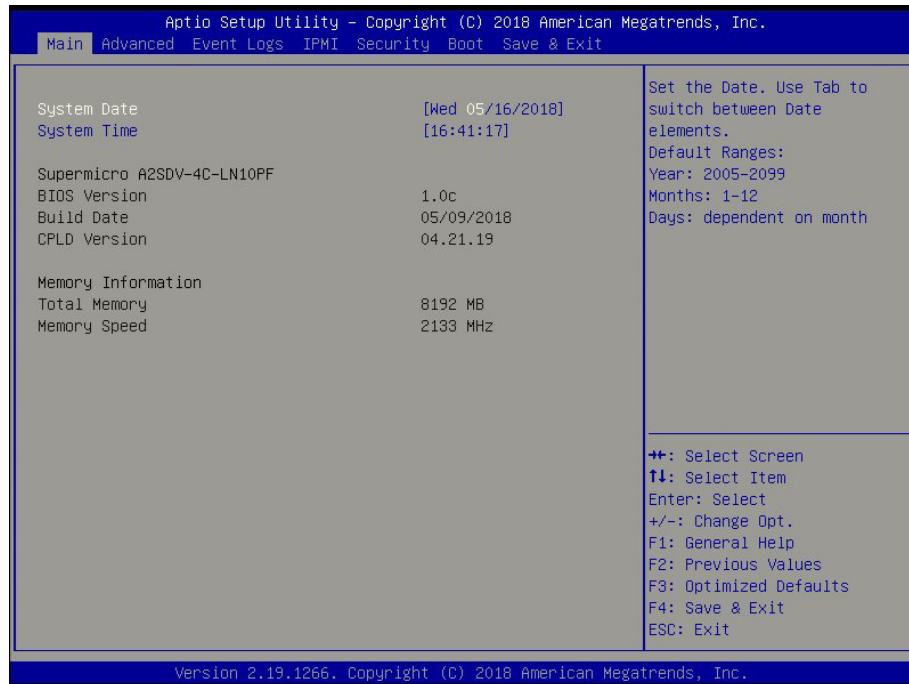

### System Date/System Time

Use this feature to change the system date and time. Highlight *System Date* or *System Time* using the arrow keys. Enter new values using the keyboard. Press the <Tab> key or the arrow keys to move between fields. The date must be entered in MM/DD/YYYY format. The time is entered in HH:MM:SS format.

 **Note:** The time is in the 24-hour format. For example, 5:30 P.M. appears as 17:30:00. The date's default value is the BIOS build date after RTC reset.

### Supermicro A2SDV-4C-LN10PF

#### BIOS Version

This feature displays the version of the BIOS ROM used in the system.

#### Build Date

This feature displays the date when the version of the BIOS ROM used in the system was built.

#### CPLD Version

This feature displays the Complex Programmable Logic Device (CPLD) version.

## **Memory Information**

### **Total Memory**

This feature displays the total size of memory available in the system.

### **Memory Speed**

This feature displays the default speed of the memory modules installed in the system.

## 4.3 Advanced

Use this menu to configure Advanced settings.

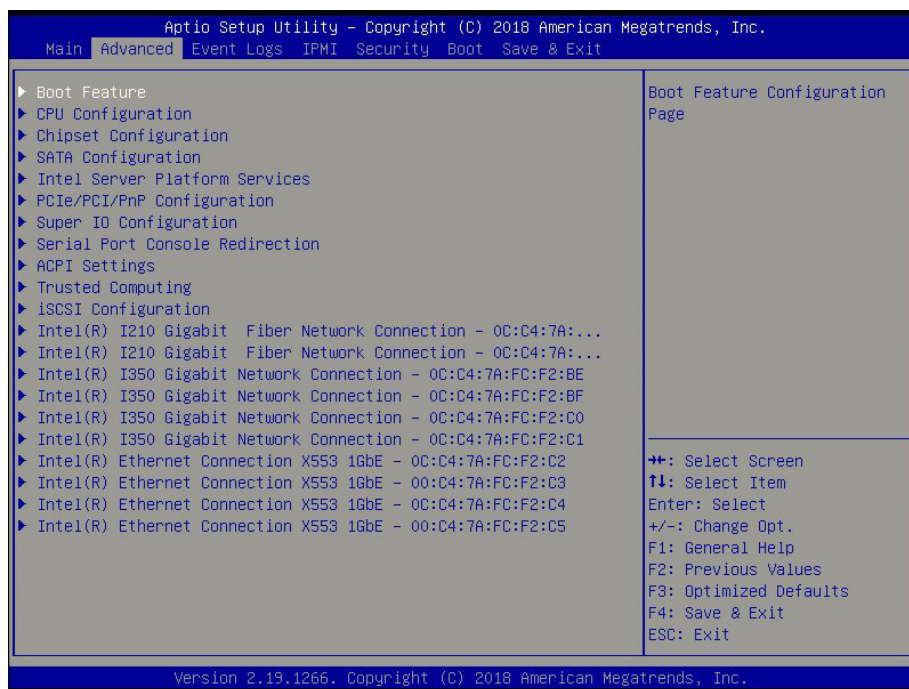

**Warning:** Take caution when changing the Advanced settings. An incorrect value, a very high DRAM frequency or an incorrect BIOS timing setting may cause the system to malfunction. When this occurs, restore to default manufacturer settings.

### ► Boot Feature

#### Quiet Boot

Use this feature to select the screen display between POST messages or the OEM logo at bootup. Select Disabled to display the POST messages. Select Enabled to display the OEM logo instead of the normal POST messages. The options are Disabled and **Enabled**.

#### Bootup NumLock State

Use this feature to set the Power-on state for the Numlock key. The options are Off and **On**.

#### Wait For "F1" If Error

This feature forces the system to wait until the F1 key is pressed if an error occurs. The options are Disabled and **Enabled**.

## Power Configuration

### Watch Dog Function

If enabled, the Watch Dog timer will allow the system to reboot when it is inactive for more than five minutes. The options are **Disabled** and **Enabled**.

### Power Button Function

This feature controls how the system shuts down when the power button is pressed. Select **4 Seconds Override** for the user to power off the system after pressing and holding the power button for four seconds or longer. Select **Instant Off** to instantly power off the system as soon as the user presses the power button. The options are **4 Seconds Override** and **Instant Off**.

### Restore on AC Power Loss

Use this feature to set the power state after a power outage. Select **Power Off** for the system power to remain off after a power loss. Select **Power On** for the system power to be turned on after a power loss. Select **Last State** to allow the system to resume its last power state before a power loss. The options are **Stay Off**, **Power On**, and **Last State**.

## ► CPU Configuration

The following CPU information will display:

- Displays the CPU model
- Processor ID
- Microcode Revision
- Processor Frequency
- CPU BCLK Frequency
- L1 Cache RAM
- L2 Cache RAM

### EIST (GV3)

EIST (Enhanced Intel SpeedStep Technology) allows the system to automatically adjust processor voltage and core frequency to reduce power consumption and heat dissipation. The options are **Disable** and **Enable**.

### BIOS Request Frequency

Use this feature to instruct how much frequency will be delivered to the processor. The options are **Disable** and **Enable**.

**TM1**

Select Enable to activate TM1 support for system thermal monitoring. TM1 allows the CPU to regulate its power consumption based upon the modulation of the CPU Internal clock when the CPU temperature reaches a pre-defined overheating threshold. The options are Disable and **Enable**.

**TM2 Mode**

Use this feature to select the throttling mode for TM2. The options are LFM Throttling and **Adaptive Throttling**.

*\*The feature above is not available when EIST (GV3) or TM1 is disabled.*

**Dynamic Self Refresh**

Select Enable to support Dynamic Self-Refreshing for the onboard memory controller. The options are **Disable** and Enable.

**CPU C State**

Select Enabled to enhance the Cx state of the CPU. Reboot the system for this feature to take effect. The options are Disable and **Enable**.

**Package C State limit**

Use this item to set the limit on the C-State package register. The options are No Pkg C-State, No S0ix, and **No Limit**. This feature is not available when CPU C State is disabled.

**Max Core C-State**

Use this feature to select the CPU C-state. The options are C1 and **C6**. This feature is not available when CPU C State is disabled.

**Enhanced Halt State (C1E)**

Select Enable to enable Enhanced Halt State support, which will significantly reduce the CPU's power consumption by minimizing its clock cycles and voltage use during a Halt State. The options are Disable and **Enable**. This feature is not available when CPU C State is disabled.

**Monitor/Mwait**

Select Enable to enable the Monitor/Mwait instructions. The Monitor instructions monitors a region of memory for writes, and MWait instructions instruct the CPU to stop until the monitored region begins to write. The options are Disable and **Enable**. This feature is not available when CPU C State is disabled.

**L1 Prefetcher**

If enabled, the hardware prefetcher will prefetch streams of data and instructions from the main memory to the L1 cache to improve CPU performance. The options are **Enable** and Disable.

## L2 Prefetcher

If enabled, the hardware prefetcher will prefetch streams of data and instructions from the main memory to the L2 cache to improve CPU performance. The options are **Enable** and Disable.

## ACPI 3.0 T-States

Select Enable to support ACPI (Advanced Configuration and Power Interface) 3.0 T-States to determine how the processor will report to the operating system during CPU-Throttling states. The options are **Disable** and Enable.

***\*If the feature above is enabled, T-State Throttle will be available for configuration:***

## T-State Throttle

Use this feature to select the On-Die thermal throttling. The options are **default**, 12.5%, 25.0%, 37.5%, 50.0%, 62.5%, 75.0%, and 87.5%.

## Max CPUID Value Limit

Use this feature to set the maximum CPU ID value. Enable this feature to boot the legacy operating systems that cannot support processors with extended CPUID functions. The options are **Disable** and Enable.

## Execute Disable Bit

Set to Enable for Execute Disable Bit support, which will allow the processor to designate areas in the system memory where an application code can execute and where it cannot, thus preventing a worm or a virus from flooding illegal codes to overwhelm the processor or damaging the system during a virus attack. The options are Disable and **Enable**. (Refer to the Intel and Microsoft websites for more information.)

## Virtualization Technology

Select Enable to use Intel Virtualization Technology to allow one platform to run multiple operating systems and applications in independent partitions, creating multiple virtual systems in one physical computer. The options are Disable and **Enable**.

## Extended APIC (Advanced Programmable Interrupt Controller)

Based on the Intel Hyper-Threading technology, each logical processor (thread) is assigned 256 APIC IDs (APIDs) in 8-bit bandwidth. When this item is set to Enable, the APIC ID will be expanded from 8 bits to 16 bits to provide 512 APIDs to each thread to enhance CPU performance. The options are **Disable** and Enable.

## AES-NI

Select Enable to use the Intel Advanced Encryption Standard (AES) New Instructions (NI) to ensure data security. The options are Disable and **Enable**.

**Lock PACKAGE\_RAPL\_LIMIT**

Use this feature to lock the MSR 0x610 bit. The options are **Disable** and **Enable**.

***\*If the feature above is set to Disable, the next three features will be available for configuration:***

**PL1 Time Window**

Use this feature to define the Running Average Power Limit (RAPL) time window 1 in milliseconds. The default setting is **45**. Use the "+" or "-" keys to define the setting.

**PL1 Power Level (This feature is dependent on the CPU)**

Use this feature to define the Running Average Power Limit (RAPL) power limit 1 in Watts. The default setting is **31**. Use the "+" or "-" keys to define the setting.

**PL2 Power Level (This feature is dependent on the CPU)**

Use this feature to define the Running Average Power Limit (RAPL) power limit 2 in Watts. The default setting is **37**. Use the "+" or "-" keys to define the setting.

**Active Processor Cores**

Use this feature to set the number of processor cores that will be activated for each CPU. Select **0** to activate all processor cores.

**► Chipset Configuration**

**Warning:** Setting the wrong values in the following sections may cause the system to malfunction.

**► North Bridge Configuration****North Bridge Configuration****Memory Information**

- MRC Version
- Total Memory
- Memory Frequency

**VT-d**

Select **Enabled** to enable Intel Virtualization Technology support for Direct I/O VT-d by reporting the I/O device assignments to VMM through the DMAR ACPI Tables. This feature offers fully-protected I/O resource-sharing across the Intel platforms, providing the user with greater reliability, security and availability in networking and data-sharing. The options are **Disabled** and **Enabled**.

**VT-d Interrupt remapping**

Use this feature to enable Interrupt Remapping support, which detects and controls external interrupt requests. The options are Disabled and **Enabled**.

**Fast Boot**

Use this feature to enable or disable fast path through the memory reference code. The options are Disabled and **Enabled**.

**Command Address Parity**

Use this feature to address the DDR4 command parity. The options are **Disabled** and Enabled.

**Memory Frequency**

Use this feature to set the maximum memory frequency for onboard memory modules. The options are DDR-1600, DDR-1867, DDR-2133, and **DDR-2400**.

**MMIO Size / BMBOUND Base**

Use this feature to select the memory mapped IO size and BMBOUND base setting. The low for the two settings will always be 4GB. The options are **Auto**, 1024M/3072M, and 3072M/1024M.

**TCL performance**

Use this feature to enable the CAS Latency (tCL) to increase memory performance. The options are Disabled and **Enabled**.

**Memory Preservation**

Enable this feature for the memory content to be preserved through a warm reset. The options are **Disabled** and Enabled.

**Patrol Scrub Enable**

Patrol Scrubbing is a process that allows the CPU to correct correctable memory errors detected in a memory module and send the correction to the requestor (the original source). When this item is set to Enable, the IO hub will read and write back one cache line every 16K cycles if there is no delay caused by internal processing. By using this method, roughly 64GB of memory behind the IO hub will be scrubbed every day. The options are **Enabled** and Disabled.

**Patrol Scrub Period**

Use this feature to select the Patrol Scrub period. The options are **24 hours**, 10 hours, 4 hours, and 1 hour.

**Demand Scrub Enable**

Demand Scrubbing is a process that allows the CPU to correct correctable memory errors found in a memory module. When the CPU or I/O issues a demand-read command, and the read data from memory turns out to be a correctable error, the error is corrected and sent to the requestor (the original source). Memory is corrected as well. Select **Enabled** to use Demand Scrubbing for ECC memory correction. The options are **Disabled** and **Enabled**.

**Write Data Early Enable**

Use this feature to enable or disable write data early. The options are **Disabled** and **Enabled**.

**Select Refresh Rate**

Use this feature to select the memory refresh rate. The options are **1x/2x** and **1x/2x/4x**.

**CKE Power Down**

Clock enable (CKE) Power Down controls the low power down for the memory. The options are **Disabled**, **Active Power Down**, and **Precharge Power Down**.

**Memory Thermal Throttling**

Memory thermal throttling is a power management feature that monitors read and write activities to control power consumption. The options are **Auto** and **Disabled**.

***\*If the feature above is set to Auto, CLTT Mode and MEMTRIP will be available for configuration:***

**CLTT Mode**

Use this feature to select the Closed Loop Thermal Throttling (CLTT) mode. The default option is **Passthru**.

**MEMTRIP**

Use this feature to enable or disable MEMTRIP. The options are **Disabled** and **Enabled**.

**Scrambler**

This feature scrambles data in the memory and makes it inaccessible. The options are **Disabled** and **Enabled**.

**Slow Power Down Exit**

Use this feature to enable or disable the slow power down exit from pre-charge. The options are **Disabled** and **Enabled**.

## ► South Bridge Configuration

### South Bridge Configuration

- USB Module Version
- USB Controllers:
- USB Devices:

### Legacy USB Support

Select Enabled to support onboard legacy USB devices. Select Auto to disable legacy support if there are no legacy USB devices present. Select Disable to have all USB devices available for EFI applications only. The options are **Enabled**, Disabled, and Auto.

### XHCI Hand-Off

This is a work-around solution for operating systems that do not support XHCI (Extensible Host Controller Interface) hand-off. The XHCI ownership change should be claimed by the XHCI driver. The settings are **Enabled** and Disabled.

### Port 60/64 Emulation

Select Enabled for I/O port 60h/64h emulation support, which in turn, will provide complete legacy USB keyboard support for the operating systems that do not support legacy USB devices. The options are Disabled and **Enabled**.

## ► IQAT Configuration

### IQAT

Select Enabled to hide IQAT devices from the operating system. The options are Disabled and **Enabled**.

### Set 64B MRR/MPL

Use this feature to enable setting for the 64B MRR/MPL in IQAT DevCTL register. The options are Disabled and **Enabled**.

*\*The following feature is displayed if an M.2 device is detected by the system:*

### M.2 (B-Key) I/O Selection

Use this feature to select the type of M.2 interface. The options are **SATA**, PCIe, PCIe/USB, and SATA/USB.

### Flexible I/O Selection

Use this feature to configure the port to be PCI-E or SATA. The options are **PCIe x2** and SATA [2:1].

## ► SATA Configuration

### ► SATA0

#### SATA 0 Enable controller

This item enables or disables the onboard SATA controller supported by the processor. The options are **Enabled** and Disabled.

#### SATA 0 ALPM

When this feature is set to Enabled, the SATA AHCI controller manages the power usage of the SATA link. The controller will put the link in a low power mode during extended periods of I/O inactivity and will return the link to an active state when I/O activity resumes. The options are Enabled and **Disabled**.

***\*If the feature above is set to Enabled, SATA 0 ALPM will be available for configuration:***

#### SATA 0 LPM

Use this feature to enable or disable Aggressive Link Power Management. The options are **Enabled** and Disabled.

#### SATA 0 SGPIO/LED

Use this feature to select SATA SGPIO or SATA LED. The options are SATA SGPIO and **SATA LED**.

### ► I-SATA (M.2 - B Key)

This following information is displayed for each M.2 drive entry:

- Device Information:
- Device Size:

#### I-SATA (M.2 - B Key) Enable/disable port

Use this feature to disable or enable the SATA port number. The options are **Enabled** and Disabled.

#### I-SATA (M.2 - B Key) Spin up

When the value of an edge detect or the value of an image binary (pixel) of a device is from 0 to 1, select Enabled to allow the PCH to start a COMRESET initialization sequence on this device. The options are Enabled and **Disabled**.

## ► SATA1

### SATA 1 Enable controller

This item enables or disables the onboard SATA controller supported by the processor. The options are **Enabled** and Disabled.

### SATA 1 ALPM

When this feature is set to Enabled, the SATA AHCI controller manages the power usage of the SATA link. The controller will put the link in a low power mode during extended periods of I/O inactivity and will return the link to an active state when I/O activity resumes. The options are Enabled and **Disabled**.

*\*If the feature above is set to Enabled, SATA 1 ALPM will be available for configuration:*

### SATA 1 ALPM

Use this feature to enable or disable Aggressive Link Power Management. The options are **Enabled** and Disabled.

### SATA 1 SGPIO/LED

Use this feature to select SATA SGPIO or SATA LED. The options are SATA SGPIO and **SATA LED**.

## ► I-SATA0 ~ I-SATA2

This following information is displayed for each SATA drive entry:

- Device Information
- Device Size

### Enable/disable port

Use this feature to disable or enable the SATA port number. The options are **Enabled** and Disabled.

### Spin up

When the value of an edge detect or the value of an image binary (pixel) of a device is from 0 to 1, select Enabled to allow the PCH to start a COMRESET initialization sequence on this device. The options are Enabled and **Disabled**.

## ► Intel Server Platform Services

### General ME Configuration

- Operational Firmware Version
- ME Firmware Type
- Backup Firmware Version
- Recovery Firmware Version
- ME Firmware Features
- ME Firmware Status #1
- ME Firmware Status #2
  - Current State
  - Error Code

## ► PCIe/PCI/PnP Configuration

**Platform Mode** - A5.01.12

### PCI Devices Common Settings:

#### Above 4G Decoding

Select Enabled to decode a PCI device that supports 64-bit in the space above 4G Address. The options are **Disabled** and Enabled.

#### SR-IOV Support

Select Enabled for Single-Root IO Virtualization (SR-IOV) support. SR-IOV is an extension of the PCI Express interface and consists of two functions: physical functions (PF) and virtual functions (VF). PF is the primary function and is used to control and configure PCI Express devices, whereas VF is the lightweight function that offers limited configuration. The options are **Disabled** and Enabled.

**Maximum Payload**

Select Auto for the system BIOS to automatically set the maximum payload value for a PCI-E device to enhance system performance. The options are **Auto**, 128 Bytes, 256 Bytes, 512 Bytes, 1024 Bytes, 2048 Bytes, and 4096 Bytes.

**Maximum Read Request**

Select Auto for the system BIOS to automatically set the maximum size for a read request for a PCI-E device to enhance system performance. The options are **Auto**, 128 Bytes, 256 Bytes, 512 Bytes, 1024 Bytes, 2048 Bytes, and 4096 Bytes.

**ASPM Support**

Use this item to set the Active State Power Management (ASPM) level for a PCI-E device. Select Auto for the system BIOS to automatically set the ASPM level based on the system configuration. Select Disabled to disable ASPM support. Select Force L0s to force all links to L0s state. The options are **Disabled**, Auto, and Force L0s.

**Warning:** Enabling ASPM support may cause some PCI-E devices to fail!

**ARI Forwarding**

Select Enabled to lift a traditional Device Number restriction when turning a Type1 Configuration request into a Type0 Configuration request to permit access to extended functions in an ARI Device immediately below the port. The options are **Disabled** and Enabled.

**CPU SLOT7 PCI-E 3.0 X4 OPROM**

Use this item to select the firmware type for the add-on card for this slot. The options are Disabled, Legacy, and **EFI**.

**KEY-B SATA3/USB3 OPROM**

Use this item to select the firmware type for the add-on card for this slot. The options are Disabled, Legacy, and **EFI**.

**Onboard LAN OPROM Type**

Use this feature to select the Onboard LAN Option ROM type. The options are Disabled, Legacy, and **EFI**.

**Onboard Video OPROM**

Use this feature to select the Onboard Video Option ROM type. The options are Disabled, Legacy, and **EFI**.

**VGA Priority**

Use this feature to select the active video type. The options are **Onboard** and Offboard.

## Network Stack

Select Enabled to enable PXE (Preboot Execution Environment) or UEFI (Unified Extensible Firmware Interface) for network stack support. The options are **Enabled** and Disabled.

***\*If "Network Stack" is set to Enabled, the next four features will be available for configuration:***

### Ipv4 PXE Support

Use this feature to enable Ipv4 PXE Boot Support. If this feature is disabled, it will not create the Ipv4 PXE Boot option. The options are Disabled and **Enabled**.

### Ipv6 PXE Support

Use this feature to enable Ipv6 PXE Boot Support. If this feature is disabled, it will not create the Ipv6 PXE Boot option. The options are **Disabled** and Enabled.

### PXE boot wait time

Use this feature to select the wait time to press the ESC key to abort the PXE boot. The default is **0**.

### Media Detect Count

Use this feature to select the wait time in seconds to detect LAN media. The default is **1**.

## ► Super IO Configuration

### Super IO Configuration

#### Super IO Chip AST2400

### ► Serial Port 1 Configuration

#### Serial Port 1 Configuration

##### Serial Port 1

Select Enabled to enable the onboard serial port specified by the user. The options are Disabled and **Enabled**.

##### Device Settings

This feature displays the base I/O port address and the Interrupt Request address of a serial port specified by the user. This feature is hidden when Serial Port 1 is disabled.

### Serial Port 1 Change Settings

This feature specifies the base I/O port address and the Interrupt Request address of Serial Port 1. Select **Auto** for the BIOS to automatically assign the base I/O and IRQ address to a serial port specified. The options are **Auto**, (IO=3F8h; IRQ=4), (IO=3F8h; IRQ=3, 4, 5, 6, 7, 9, 10, 11, 12), (IO=2F8h; IRQ=3, 4, 5, 6, 7, 9, 10, 11, 12); (IO=3E8h; IRQ=3, 4, 5, 6, 7, 9, 10, 11, 12), and (IO=2E8h; IRQ=3, 4, 5, 6, 7, 9, 10, 11, 12).

## ►Serial Port Console Redirection

### COM 1 Console Redirection

Select Enabled to enable COM Port 1 for Console Redirection, which will allow a client machine to be connected to a host machine at a remote site for networking. The options are Enabled and **Disabled**.

*\*If the feature above is set to Enabled, the following items will become available for configuration:*

### ►COM1 Console Redirection Settings

#### COM1 Terminal Type

This feature allows the user to select the target terminal emulation type for Console Redirection. Select VT100 to use the ASCII Character set. Select VT100+ to add color and function key support. Select ANSI to use the Extended ASCII Character Set. Select VT-UTF8 to use UTF8 encoding to map Unicode characters into one or more bytes. The options are VT100, **VT100+**, VT-UTF8, and ANSI.

#### COM1 Bits per second

Use this item to set the transmission speed for a serial port used in Console Redirection. Make sure that the same speed is used in the host computer and the client computer. A lower transmission speed may be required for long and busy lines. The options are 9600, 19200, 38400, 57600, and **115200** (bits per second).

#### COM1 Data Bits

Use this feature to set the data transmission size for Console Redirection. The options are 7 and **8**.

#### COM1 Parity

A parity bit can be sent along with regular data bits to detect data transmission errors. Select Even if the parity bit is set to 0, and the number of 1's in data bits is even. Select Odd if the parity bit is set to 0, and the number of 1's in data bits is odd. Select None if you do not want to send a parity bit with your data bits in transmission. Select Mark to add a mark as a parity bit to be sent along with the data bits. Select Space to add a Space as a parity bit to be sent with your data bits. The options are **None**, Even, Odd, Mark, and Space.

**COM1 Stop Bits**

A stop bit indicates the end of a serial data packet. Select 1 Stop Bit for standard serial data communication. Select 2 Stop Bits if slower devices are used. The options are **1** and **2**.

**COM1 Flow Control**

Use this item to set the flow control for Console Redirection to prevent data loss caused by buffer overflow. Send a "Stop" signal to stop sending data when the receiving buffer is full. Send a "Start" signal to start sending data when the receiving buffer is empty. The options are **None** and Hardware RTS/CTS.

**COM1 VT-UTF8 Combo Key Support**

Select Enabled to enable VT-UTF8 Combination Key support for ANSI/VT100 terminals. The options are Disabled and **Enabled**.

**COM1 Recorder Mode**

Select Enabled to capture the data displayed on a terminal and send it as text messages to a remote server. The options are **Disabled** and Enabled.

**COM1 Resolution 100x31**

Select Enabled for extended-terminal resolution support. The options are Disabled and **Enabled**.

**COM1 Putty KeyPad**

This feature selects Function Keys and KeyPad settings for Putty, which is a terminal emulator designed for the Windows OS. The options are **VT100**, LINUX, XTERMR6, SCO, ESCN, and VT400.

**SOL****SOL Console Redirection**

Select Enabled to use the SOL port for Console Redirection. The options are Disabled and **Enabled**.

***\*If the feature above is set to Enabled, the following items will become available for configuration:***

**► SOL Console Redirection Settings**

Use the features in this submenu to specify how the host computer will exchange data with the client computer, which is the remote computer used by the user.

**SOL Terminal Type**

Use this feature to select the target terminal emulation type for Console Redirection. Select VT100 to use the ASCII Character set. Select VT100+ to add color and function key support. Select ANSI to use the Extended ASCII Character Set. Select VT-UTF8 to use UTF8 encoding to map Unicode characters into one or more bytes. The options are VT100, **VT100+**, VT-UTF8, and ANSI.

**SOL Bits per second**

Use this feature to set the transmission speed for a serial port used in Console Redirection. Make sure that the same speed is used in the host computer and the client computer. A lower transmission speed may be required for long and busy lines. The options are 9600, 19200, 38400, 57600, and **115200** (bits per second).

**SOL Data Bits**

Use this feature to set the data transmission size for Console Redirection. The options are 7 and 8.

**SOL Parity**

A parity bit can be sent along with regular data bits to detect data transmission errors. Select Even if the parity bit is set to 0, and the number of 1's in data bits is even. Select Odd if the parity bit is set to 0, and the number of 1's in data bits is odd. Select None if you do not want to send a parity bit with your data bits in transmission. Select Mark to add a mark as a parity bit to be sent along with the data bits. Select Space to add a Space as a parity bit to be sent with your data bits. The options are **None**, Even, Odd, Mark, and Space.

**SOL Stop Bits**

A stop bit indicates the end of a serial data packet. Select 1 Stop Bit for standard serial data communication. Select 2 Stop Bits if slower devices are used. The options are 1 and 2.

**SOL Flow Control**

Use this feature to set the flow control for Console Redirection to prevent data loss caused by buffer overflow. Send a "Stop" signal to stop sending data when the receiving buffer is full. Send a "Start" signal to start sending data when the receiving buffer is empty. The options are **None** and Hardware RTS/CTS.

**SOL VT-UTF8 Combo Key Support**

Select Enabled to enable VT-UTF8 Combination Key support for ANSI/VT100 terminals. The options are Disabled and **Enabled**.

**SOL Recorder Mode**

Select Enabled to capture the data displayed on a terminal and send it as text messages to a remote server. The options are **Disabled** and Enabled.

### **SOL Resolution 100x31**

Select Enabled for extended-terminal resolution support. The options are Disabled and Enabled.

### **SOL Putty KeyPad**

This feature selects Function Keys and KeyPad settings for Putty, which is a terminal emulator designed for the Windows OS. The options are **VT100**, LINUX, XTERMR6, SCO, ESCN, and VT400.

## **Serial Port for Out-of-Band Management/Windows Emergency Management Services (EMS)**

Use the features in this submenu to configure Console Redirection settings to support Out-of-Band Serial Port management.

### **EMS (Emergency Management Services) Console Redirection**

Select Enabled to use a COM port selected by the user for EMS Console Redirection. The options are **Disabled** and Enabled.

***\*If the feature above is set to Enabled, the following items will become available for configuration:***

#### **►EMS Console Redirection Settings**

This feature allows the user to specify how the host computer will exchange data with the client computer, which is the remote computer used by the user.

#### **Out-of-Band Mgmt Port**

The feature selects a serial port in a client server to be used by the Microsoft Windows Emergency Management Services (EMS) to communicate with a remote host server. The options are COM1 and **SOL**.

#### **Terminal Type**

Use this feature to select the target terminal emulation type for Console Redirection. Select VT100 to use the ASCII character set. Select VT100+ to add color and function key support. Select ANSI to use the extended ASCII character set. Select VT-UTF8 to use UTF8 encoding to map Unicode characters into one or more bytes. The options are VT100, VT100+, **VT-UTF8**, and ANSI.

#### **Bits per second**

This item sets the transmission speed for a serial port used in Console Redirection. Make sure that the same speed is used in the host computer and the client computer. A lower transmission speed may be required for long and busy lines. The options are 9600, 19200, 57600, and **115200** (bits per second).

**Flow Control**

Use this feature to set the flow control for Console Redirection to prevent data loss caused by buffer overflow. Send a "Stop" signal to stop sending data when the receiving buffer is full. Send a "Start" signal to start sending data when the receiving buffer is empty. The options are **None**, Hardware RTS/CTS, and Software Xon/Xoff.

**Data Bits****Parity****Stop Bits****►ACPI Settings****ACPI Settings****WHEA Support**

Select Enabled to support the Windows Hardware Error Architecture (WHEA) platform and provide a common infrastructure for the system to handle hardware errors within the Windows OS environment to reduce system crashes and to enhance system recovery and health monitoring. The options are Disabled and **Enabled**.

**Headless Support**

Select Enabled for the system to function without a keyboard, mouse, or monitor. The options are **Disabled** and Enabled.

**►Trusted Computing (Available when a TPM device is installed and detected by the BIOS)**

*\*The features from here to Current Status Information are displayed if a TPM 1.2 module is detected:*

**Security Device Support**

If this feature and the TPM jumper on the motherboard are both set to Enabled, onboard security devices will be enabled for TPM support to enhance data integrity and network security. Reboot the system for a change on this setting to take effect. The options are Disable and **Enable**.

**TPM State**

Select Enabled to use TPM (Trusted Platform Module) settings to enhance system data security. Reboot your system for any change on the TPM state to take effect. The options are **Disable** and Enable.

### Pending operation

Use this item to schedule a TPM-related operation to be performed by a security device for system data integrity. Your system will reboot to carry out a pending TPM operation. The options are **None** and TPM Clear.



**Note:** Reboot the computer to change the state of the security device.

### Device Select

Use this feature to select the TPM version. TPM 1.2 will restrict support to TPM 1.2 devices. TPM 2.0 will restrict support for TPM 2.0 devices. Select Auto to enable support for both versions. The default setting is **Auto**.

### Current Status Information

This item displays the status of the TPM support on this motherboard.

- TPM Enabled Status
- TPM Active Status
- TPM Owner Status

*\*The features from here to Device Select on the next page are displayed if a TPM 2.0 module is detected:*

### TPM20 Device Found

**Vendor: IFX**

**Firmware Version: 5.51**

### Configuration

#### Security Device Support

If this feature and the TPM jumper on the motherboard are both set to Enabled, onboard security devices will be enabled for TPM support to enhance data integrity and network security. Reboot the system for a change on this setting to take effect. The options are Disable and **Enable**.

The following TPM information will be displayed:

- Active PCR banks
- Available PCR banks

*\*If the feature "Security Device Support" is set to Enable, the following features will become available for configuration:*

#### SHA-1 PCR Bank

Use this item to disable or enable the SHA-1 Platform Configuration Register (PCR) bank for the installed TPM device. The options are Disabled and **Enabled**.

### **SHA256 PCR Bank**

Use this item to disable or enable the SHA256 Platform Configuration Register (PCR) bank for the installed TPM device. The options are Disabled and **Enabled**.

### **Pending operation**

Use this item to schedule a TPM-related operation to be performed by a security device for system data integrity. Your system will reboot to carry out a pending TPM operation. The options are **None** and TPM Clear.

### **Platform Hierarchy**

Use this item to disable or enable platform hierarchy for platform protection. The options are Disabled and **Enabled**.

### **Storage Hierarchy**

Use this item to disable or enable storage hierarchy for cryptographic protection. The options are Disabled and **Enabled**.

### **Endorsement Hierarchy**

Use this item to disable or enable endorsement hierarchy for privacy control. The options are Disabled and **Enabled**.

### **TPM2.0 UEFI Spec Version**

Use this feature to specify the TPM UEFI spec version. TCG 1.2 has support for Windows® 2012, Windows 8, and Windows 10. TCG 2 has support for Windows 10 or later. The options are TCG\_1\_2 and **TCG\_2**.

### **Physical Presence Spec Version**

Use this feature to select the PPI spec version. The options are 1.2 and **1.3**.

### **Device Select**

Use this feature to select the TPM version. TPM 1.2 will restrict support to TPM 1.2 devices. TPM 2.0 will restrict support for TPM 2.0 devices. Select Auto to enable support for both versions. The default setting is **Auto**.

## ► iSCSI Configuration

### iSCSI Initiator Name

This feature allows the user to enter the unique name of the iSCSI Initiator in IQN format. Once the name of the iSCSI Initiator is entered into the system, configure the proper settings for the following items.

► Add an Attempt

► Delete Attempts

► Change Attempt Order

- Intel® I210 Gigabit Fiber Network Connection - 0C:C4:7A:...
- Intel® I210 Gigabit Fiber Network Connection - 0C:C4:7A:...
- Intel® I350 Gigabit Network Connection - 0C:C4:7A:XX:XX:XX
- Intel® I350 Gigabit Network Connection - 0C:C4:7A:XX:XX:XX
- Intel® I350 Gigabit Network Connection - 0C:C4:7A:XX:XX:XX
- Intel® I350 Gigabit Network Connection - 0C:C4:7A:XX:XX:XX
- Intel® Ethernet Connection X553 1GbE - 0C:C4:7A:XX:XX:XX
- Intel® Ethernet Connection X553 1GbE - 0C:C4:7A:XX:XX:XX
- Intel® Ethernet Connection X553 1GbE - 0C:C4:7A:XX:XX:XX
- Intel® Ethernet Connection X553 1GbE - 0C:C4:7A:XX:XX:XX

These features display the following information:

### ► NIC Configuration (Dependent on the LAN chipset)

#### Link Speed

Use this feature to change the link speed and duplex for the current port. The options are **Auto Negotiated**, 10Mbps Half, 10Mbps Full, 100Mbps Half, and 100Mbps full.

#### SFP LAN

This feature is grayed out and cannot be selected.

#### Wake On LAN

Select enabled to wake the system with a magic packet. The options are **Enabled** and Disabled.

#### Blink LEDs

This feature allows the user to specify the duration for LEDs to blink. The range is from 0 ~ 15 seconds. The default setting is **0**.

### **UEFI Driver**

This feature displays the UEFI driver version.

### **Adapter PBA**

This feature displays the Processor Bus Adapter (PBA) model number. The PBA number is a nine digit number (i.e., 010B00-000) located near the serial number.

### **Device Name**

This feature displays the adapter device name.

### **Chip Type**

This feature displays the network adapter chipset name.

### **PCI Device ID**

This feature displays the device ID number.

### **PCI Address**

This feature displays the PCI address for this computer. PCI addresses are three two-digit hexadecimal numbers.

### **Link Status**

This feature displays the connection status.

### **MAC Address**

This feature displays the MAC address for this computer. Mac addresses are six two-digit hexadecimal numbers.

### **Virtual MAC Address**

This feature displays the Virtual MAC address for this computer. Mac addresses are six two-digit hexadecimal numbers.

## 4.4 Event Logs

Use this menu to configure Event Log settings.

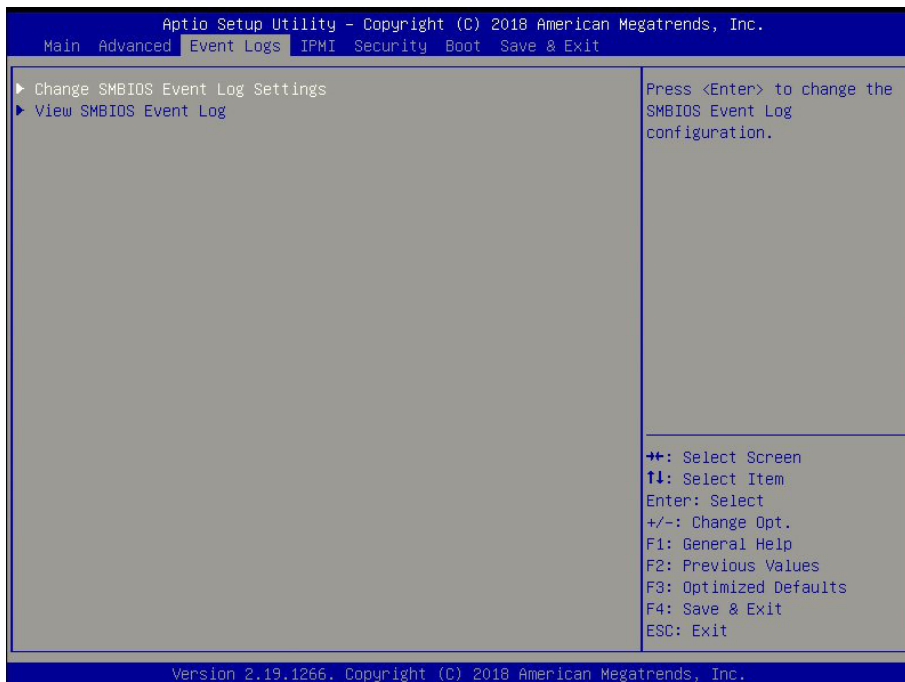

### ► Change SMBIOS Event Log Settings

#### Enabling/Disabling Options

##### PCIe ELog Support

Use this feature to enable or disable PCIe error logging support. The options are Disabled and **Enabled**.

##### Memory ELog Support

Use this feature to enable or disable memory error logging support. The options are Disabled and **Enabled**.

##### Error Threshold

Use this feature to modify the MCI error threshold from one to 32768. The default is **100**.

##### SMBIOS Event Log

Change this feature to enable or disable all features of the SMBIOS Event Logging during system boot. The options are Disabled and **Enabled**.

## Erasing Settings

### Erase Event Log

Select Enabled to erase all error events in the SMBIOS (System Management BIOS) log before an event logging is initialized at bootup. The options are **No**, Yes, Next reset, and Yes, Every reset.

### When Log is Full

Select Erase Immediately to immediately erase all errors in the SMBIOS event log when the event log is full. Select Do Nothing for the system to do nothing when the SMBIOS event log is full. The options are **Do Nothing** and Erase Immediately.

## SMBIOS Event Log Standard Settings

### Log System Boot Event

Select Enabled to log system boot events. The options are Enabled and **Disabled**.

### MECI (Multiple Event Count Increment)

Enter the increment value for the multiple event counter. Enter a number between 1 to 255. The default setting is **1**.

### METW (Multiple Event Count Time Window)

This feature is used to determine how long (in minutes) should the multiple event counter wait before generating a new event log. Enter a number between 0 to 99. The default setting is **60**.



**Note:** All values here that have been changed do not take effect until the computer is restarted.

## ►View SMBIOS Event Log

This item allows the user to view the event in the SMBIOS event log. The following categories are displayed:

**DATE/TIME/ERROR CODE/SEVERITY**

## 4.5 IPMI

Use this menu to configure Intelligent Platform Management Interface (IPMI) settings.

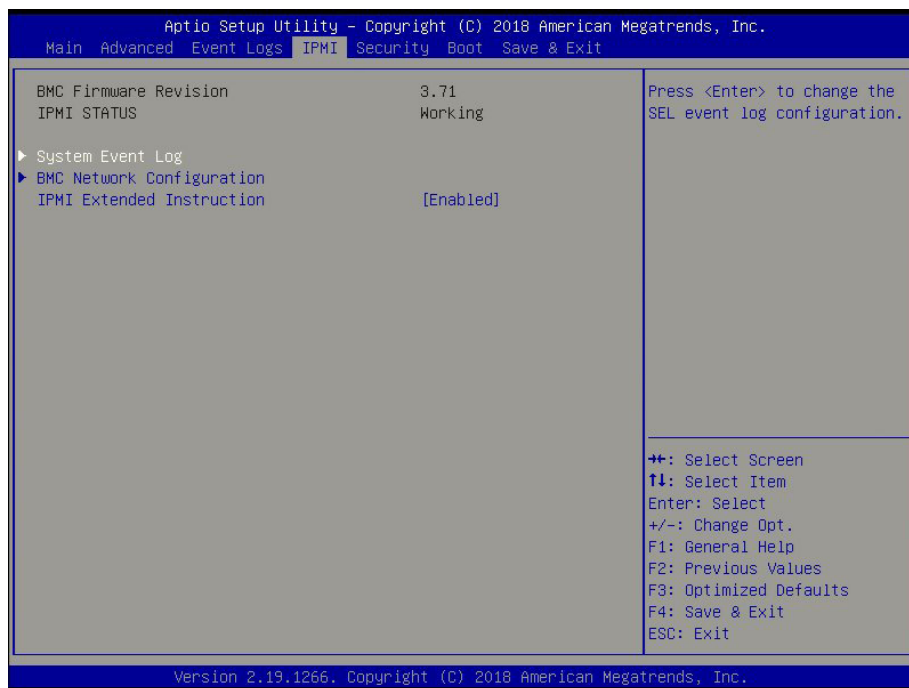

### BMC Firmware Revision

This feature indicates the IPMI firmware revision used in your system.

### IPMI Status

This feature indicates the status of the IPMI firmware installed in your system.

### ▶ System Event Log

#### Enabling/Disabling Options

#### SEL Components

Select Enabled for all system event logging at bootup. The options are Disabled and Enabled.

#### Erasing Settings

#### Erase SEL

Select Yes, On next reset to erase all system event logs upon next system reboot. Select Yes, On every reset to erase all system event logs upon each system reboot. Select No to keep all system event logs after each system reboot. The options are **No**, Yes, On next reset, and Yes, On every reset.

### When SEL is Full

This feature allows the user to determine what the BIOS should do when the system event log is full. Select Erase Immediately to erase all events in the log when the system event log is full. The options are **Do Nothing** and Erase Immediately.



**Note:** All values here that have been changed do not take effect until the computer is restarted in the BIOS setup menu.

## ► BMC Network Configuration

The following features will be displayed:

### IPMI LAN Selection

This feature displays the IPMI LAN setting. The default setting is **Failover**.

### IPMI Network Link Status:

This feature displays the IPMI Network Link status. The default setting is **Shared LAN**.

### Update IPMI LAN Configuration

Select Yes for the BIOS to implement all IP/MAC address changes at the next system boot. The options are **No** and Yes.

***\*If the feature above is set to Yes, Configuration Address Source and VLAN will become available for configuration:***

### Configuration Address Source

Use this feature to select the source of the IP address for this computer. If Static is selected, you will need to know the IP address of this computer and enter it to the system manually in the field. If DHCP is selected, the BIOS will search for a DHCP (Dynamic Host Configuration Protocol) server in the network that is attached to and request the next available IP address for this computer. The options are **DHCP** and Static.

The following features are assigned IP addresses automatically if DHCP is selected, or they can be configured manually if Static is selected.

### Station IP Address

This feature displays the Station IP address for this computer. This should be in decimal and in dotted quad form (i.e., 192.168.10.253).

### Subnet Mask

This feature displays the sub-network that this computer belongs to. The value of each three-digit number separated by dots should not exceed 255.

**Station MAC Address**

This feature displays the Station MAC address for this computer. Mac addresses are 6 two-digit hexadecimal numbers.

**Gateway IP Address**

This feature displays the Gateway IP address for this computer. This should be in decimal and in dotted quad form (i.e., 192.168.10.253).

**VLAN**

This feature is configurable if the Update IPMI LAN Configuration feature is set to Yes. Use this feature to enable or disable the IPMI VLAN function. The options are **Disable** and **Enable**.

**IPMI Extended Instruction**

Use this feature to enable IPMI extended function support. The options are **Enabled** and **Disabled**. When Disabled, the system powers on quickly by removing BIOS support for extended IPMI features. The Disable option is for applications that require faster power on time without using Supermicro Update Manager (SUM) or extended IPMI features. The BMC network configuration in the BIOS setup will also be invalid when IPMI Extended Instruction is disabled. The general BMC function and motherboard health monitor such as fan control will still function even when this option is disabled.

## 4.6 Security

Use this menu to configure Security settings.

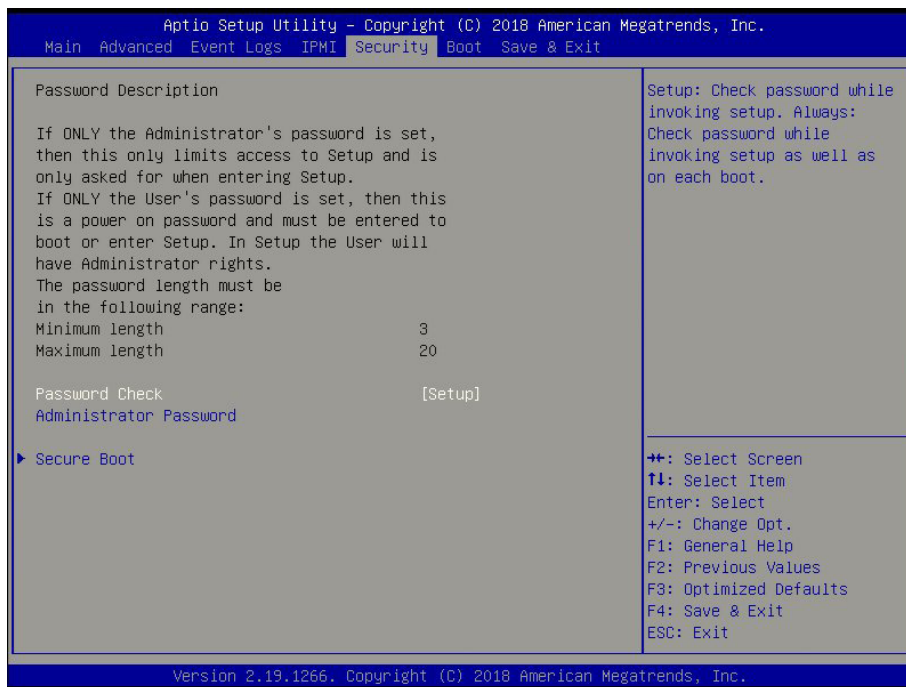

### Password Check

Select Setup for the system to check for a password at Setup. Select Always for the system to check for a password at bootup or upon entering the BIOS Setup utility. The options are **Setup** and **Always**.

### Administrator Password

Use this feature to set the administrator password, which is required to enter the BIOS setup utility. The length of the password should be from 3 characters to 20 characters long.

***\*The feature below is displayed if an Administrator Password is set:***

### User Password

Use this feature to set a user password.

#### ► Secure Boot

**Platform Mode** - Setup

**Secure Boot** - Not Active

**Vendor Keys** - Not Active

**Enable Secure Boot**

Select Enable for secure boot support to ensure system security at bootup. The options are **Disabled** and Enabled.

**Secure Boot Mode**

This feature allows the user to select the desired secure boot mode for the system. The options are Standard and **Custom**.

***\*If Secure Boot Mode is set to Custom, Key Management features will be available for configuration:***

**CSM Support**

This feature is for manufacturing debug purposes.

**▶Reset to Setup Mode**

Select Yes to delete all Secure Boot key databases and force the system to Setup Mode. The options are Yes and No.

**▶Restore Factory Keys**

Select Yes to restore all factory keys to the default settings. The options are Yes and No.

**▶Key Management**

This submenu allows the user to configure the following Key Management settings.

**Provision Factory Defaults**

Select Enabled to install the default Secure Boot keys set by the manufacturer. The options are **Disabled** and Enabled.

**▶Enroll Efi Image**

This feature allows the image to run in Secure Boot mode.

**▶Save All Secure Boot Variables**

This feature allows the user to decide if all secure boot variables should be saved.

**▶Platform Key (PK)****Save to File**

Select Yes to save the PK to a storage device.

**Set New**

Select Yes to load the new PK from the manufacturer's defaults. Select No to load the platform keys from a file. The options are **Yes** and No.

### **Erase**

Select Yes to delete the PK from NVRAM. The options are Yes and No.

### **► Key Exchange Keys**

#### **Save to File**

Select Yes to save the KEK to a storage device.

#### **Set New**

Select Yes to load the KEK from the manufacturer's defaults. Select No to load the KEK from a file. The options are Yes and No.

#### **Append**

Select Yes to add the KEK from the manufacturer's defaults list to the existing KEK. Select No to load the KEK from a file. The options are Yes and No.

### **Erase**

Select Yes to delete the KEK from NVRAM. The options are Yes and No.

### **► Authorized Signatures**

#### **Save to File**

Select Yes to save the db to a storage device.

#### **Set New**

Select Yes to load the db from the manufacturer's defaults. Select No to load the db from a file. The options are Yes and No.

#### **Append**

Select Yes to add the database from the manufacturer's defaults to the existing db. Select No to load the db from a file. The options are Yes and No.

### **Erase**

Select Yes to delete the db from NVRAM. The options are Yes and No.

### **► Forbidden Signatures**

#### **Save to File**

Select Yes to save the dbx to a storage device.

#### **Set New**

Select Yes to load the dbx from the manufacturer's defaults. Select No to load the dbx from a file. The options are Yes and No.

**Append**

Select Yes to add the dbx from the manufacturer's defaults to the existing dbx. Select No to load the dbx from a file. The options are Yes and No.

**Erase**

Select Yes to delete the dbx from NVRAM. The options are Yes and No.

**► Authorized TimeStamps****Set New**

Select Yes to load the dbt from the manufacturer's defaults. Select No to load the dbt from a file. The options are Yes and No.

**Append**

Select Yes to add the dbt from the manufacturer's defaults list to the existing dbt. Select No to load the dbt from a file. The options are Yes and No.

**► OsRecovery Signatures****Set New**

Select Yes to load the dbr from the manufacturer's defaults. Select No to load the dbr from a file. The options are Yes and No.

**Append**

Select Yes to add the dbr from the manufacturer's defaults list to the existing dbr. Select No to load the dbr from a file. The options are Yes and No.

## 4.7 Boot

Use this menu to configure Boot settings:

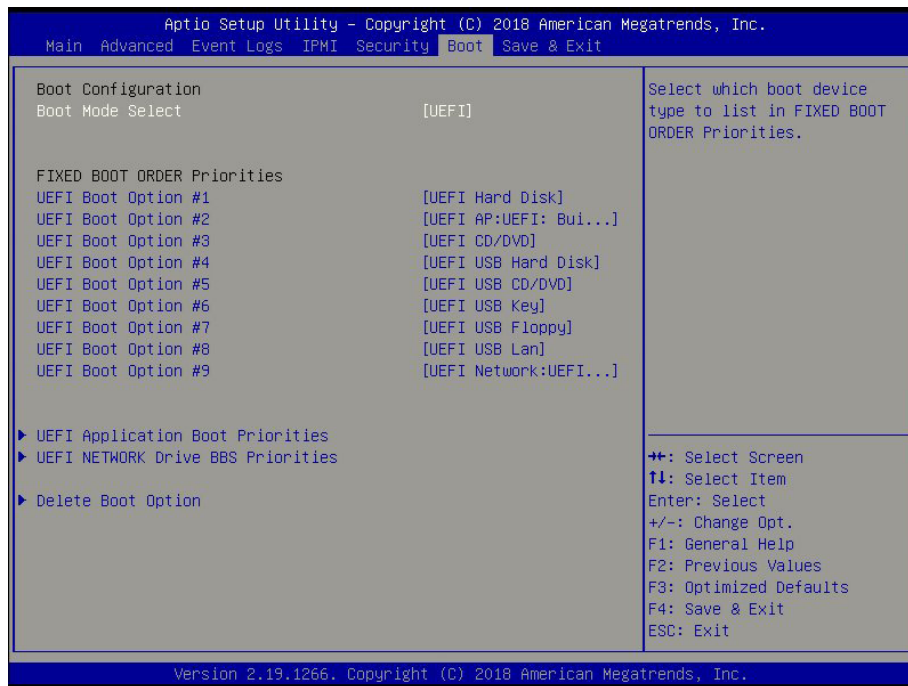

### Boot mode select

Use this feature to select the boot mode for bootable devices in the system. The options are LEGACY, **UEFI**, and DUAL.

### Fixed Boot Order Priorities

This option prioritizes the order of bootable devices that the system boots from. Press <Enter> on each entry from top to bottom to select devices.

- LEGACY/UEFI/DUAL Boot Option #1
- LEGACY/UEFI/DUAL Boot Option #2
- LEGACY/UEFI/DUAL Boot Option #3
- LEGACY/UEFI/DUAL Boot Option #4
- LEGACY/UEFI/DUAL Boot Option #5
- LEGACY/UEFI/DUAL Boot Option #6
- LEGACY/UEFI/DUAL Boot Option #7

- LEGACY/UEFI/DUAL Boot Option #8
- LEGACY/UEFI/DUAL Boot Option #9

▶ **UEFI Application Boot Priorities**

- Boot Option # - This feature sets the system boot order of detected devices. The options are **[the list of detected boot device(s)]** and Disable.

▶ **UEFI Network Drive BBS Priorities**

- Boot Option # - This feature sets the system boot order of detected devices. The options are **[the list of detected boot device(s)]** and Disable.

▶ **Delete Boot Option**

Use this feature to select a boot device to delete from the boot priority list.

## 4.8 Save & Exit

Use this menu to save settings and exit the BIOS.

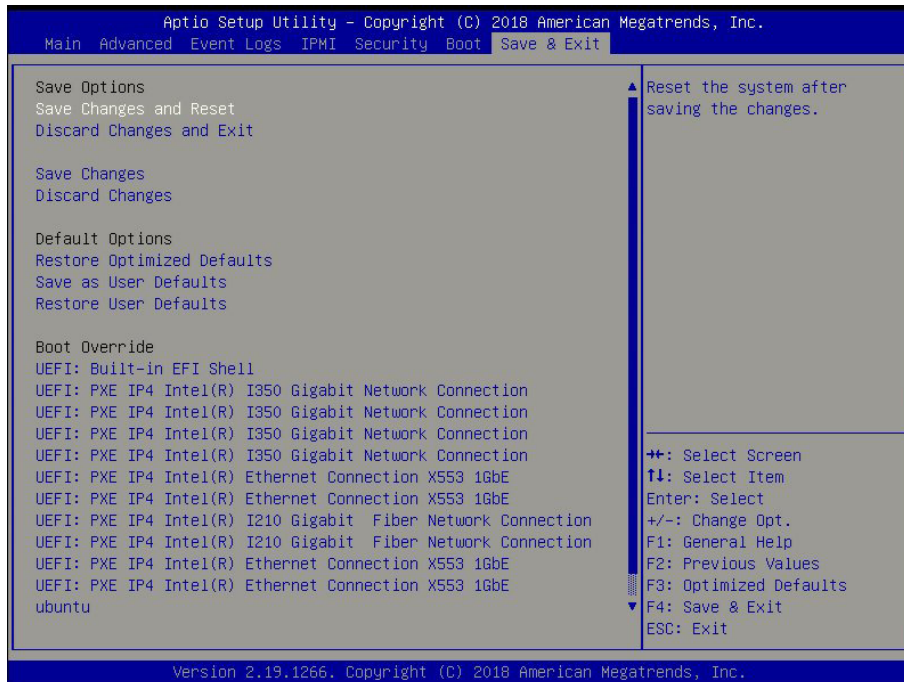

### Save Options

#### Save Changes and Reset

When you have completed the system configuration changes, select this option to save all changes made and reset the system.

#### Discard Changes and Exit

Select this option to quit the BIOS Setup without making any permanent changes to the system configuration and reboot the computer. Select Discard Changes and Exit from the Exit menu and press <Enter>.

#### Save Changes

When you have completed the system configuration changes, select this option to save all changes made. This will not reset (reboot) the system.

#### Discard Changes

Select this option and press <Enter> to discard all the changes and return to the AMI BIOS Utility Program.

## **Default Options**

### **Restore Optimized Defaults**

To set this feature, select Restore Optimized Defaults and press <Enter>. These are factory settings designed for maximum system performance but not for maximum stability.

### **Save as User Defaults**

To set this feature, select Save as User Defaults from the Exit menu and press <Enter>. This enables the user to save any changes to the BIOS setup for future use.

### **Restore User Defaults**

To set this feature, select Restore User Defaults from the Exit menu and press <Enter>. Use this feature to retrieve user-defined settings that were saved previously.

## **Boot Override**

Other boot options are listed in this section. The system will boot to the selected boot option.

### **UEFI: Built-in EFI Shell**

**UEFI: PXE IP4 Intel® I210 Gigabit Fiber Network Connection**

**UEFI: PXE IP4 Intel® I210 Gigabit Fiber Network Connection**

**UEFI: PXE IP4 Intel® I350 Gigabit Network Connection**

**UEFI: PXE IP4 Intel® I350 Gigabit Network Connection**

**UEFI: PXE IP4 Intel® I350 Gigabit Network Connection**

**UEFI: PXE IP4 Intel® I350 Gigabit Network Connection**

**UEFI: PXE IP4 Intel® Ethernet Connection X553 1GbE**

**UEFI: PXE IP4 Intel® Ethernet Connection X553 1GbE**

**UEFI: PXE IP4 Intel® Ethernet Connection X553 1GbE**

**UEFI: PXE IP4 Intel® Ethernet Connection X553 1GbE**

**ubuntu**

**Windows Boot Manager**

## Appendix A

### BIOS Codes

#### BIOS Error POST (Beep) Codes

During the POST (Power-On Self-Test) routines, which are performed upon each system boot, errors may occur.

**Non-fatal errors** are those which, in most cases, allow the system to continue to boot. These error messages normally appear on the screen.

**Fatal errors** will not allow the system to continue with bootup. If a fatal error occurs, you should consult with your system manufacturer for possible repairs.

These fatal errors are usually communicated through a series of audible beeps. The table below lists some common errors and their corresponding beep codes encountered by users.

BIOS Beep (POST) Codes		
Beep Code	Error Message	Description
1 beep	Refresh	Circuits have been reset (Ready to power up)
5 short, 1 long	Memory error	No memory detected in system
5 long, 2 short	Display memory read/write error	Video adapter missing or with faulty memory
1 long continuous	System OH	System overheat condition

## A.2 Additional BIOS POST Codes

The AMI BIOS supplies additional checkpoint codes, which are documented online at <http://www.supermicro.com/support/manuals/> ("AMI BIOS POST Codes User's Guide").

When BIOS performs the Power On Self Test, it writes checkpoint codes to I/O port 0080h. If the computer cannot complete the boot process, a diagnostic card can be attached to the computer to read I/O port 0080h (Supermicro p/n AOM-SPI80-V).

For information on AMI updates, please refer to <http://www.ami.com/products/>.

## Appendix B

### Software Installation

#### B.1 Installing Software Programs

The Supermicro website contains drivers and utilities for your system at <https://www.supermicro.com/wftp/driver>. Some of these must be installed, such as the chipset driver.

After accessing the website, go into the CDR\_Images (in the parent directory of the above link) and locate the ISO file for your motherboard. Download this file to create a DVD of the drivers and utilities it contains. (You may also use a utility to extract the ISO file if preferred.)

After creating a DVD with the ISO files, insert the disk into the DVD drive on your system and the display shown in Figure B-1 should appear.

Another option is to go to the Supermicro website at <http://www.supermicro.com/products/>. Find the product page for your motherboard here, where you may download individual drivers and utilities to your hard drive or a USB flash drive and install from there.

 **Note 1:** Click the icons showing a hand writing on paper to view the readme files for each item. Click the computer icons to the right of these items to install each item (from top to the bottom) one at a time. **After installing each item, you must reboot the system before moving on to the next item on the list.** The bottom icon with a CD on it allows you to view the entire contents.

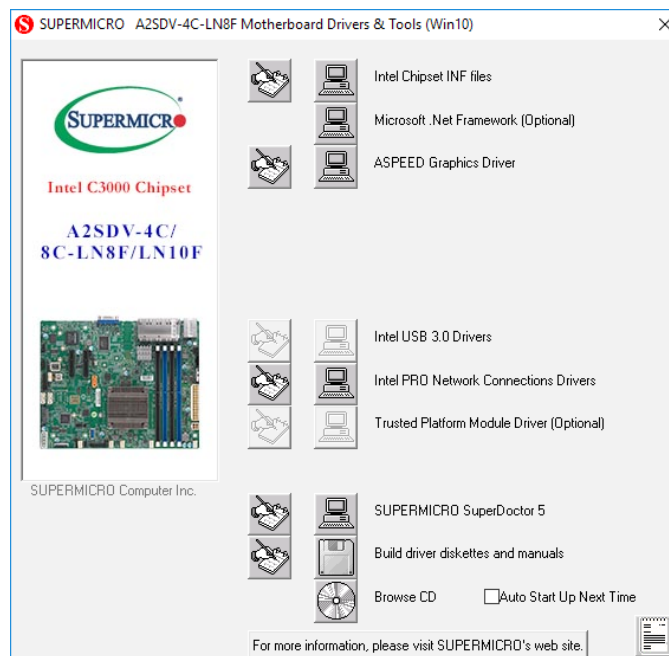

Figure B-1. Driver/Tool Installation Display Screen

**Note 2:** When making a storage driver diskette by booting into a driver CD, please set the SATA configuration to *Compatible Mode*, and configure the SATA as IDE in the BIOS setup. After making the driver diskette, be sure to change the SATA settings back to your original settings.

The Supermicro SuperDoctor 5 is a hardware monitoring program that functions in a command-line or web-based interface in Windows and Linux operating systems. The program monitors system health information, such as CPU temperature, system voltages, system power consumption, and fan speed, and provides alerts via email or the Simple Network Management Protocol (SNMP).

SuperDoctor 5 comes in local and remote management versions and can be used with Nagios to maximize your system monitoring needs. With the SuperDoctor 5 Management Server (SSM Server), you can remotely control the power status and reset chassis intrusion for multiple systems with SuperDoctor 5 or IPMI. SD5 Management Server monitors HTTP, FTP, and SMTP services to optimize the efficiency of your operation.

**Note:** The default username and password for SuperDoctor 5 is ADMIN/ADMIN.

**Figure B-2. SuperDoctor 5 Interface Display Screen (Health Information)**

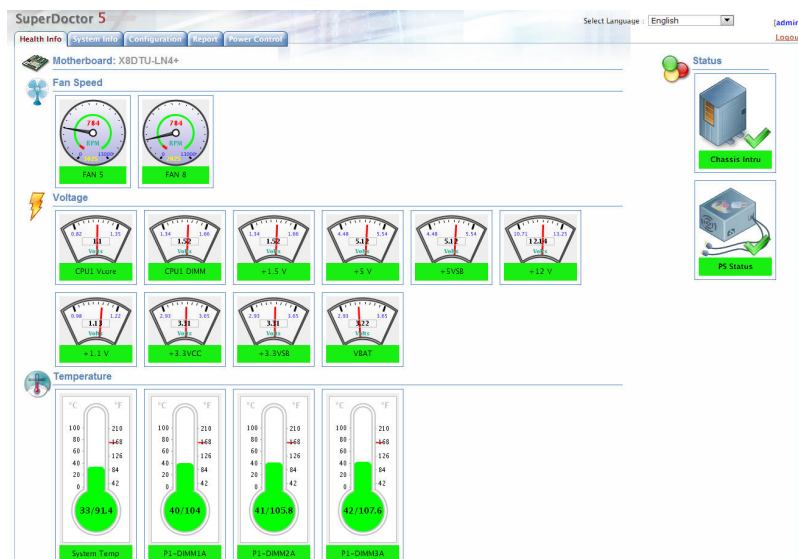

**Note:** The SuperDoctor 5 program and user's manual can be downloaded from the Supermicro website at [http://www.supermicro.com/products/nfo/sms\\_sd5.cfm](http://www.supermicro.com/products/nfo/sms_sd5.cfm).

## Appendix C

### Standardized Warning Statements

The following statements are industry standard warnings, provided to warn the user of situations which have the potential for bodily injury. Should you have questions or experience difficulty, contact Supermicro's Technical Support department for assistance. Only certified technicians should attempt to install or configure components.

Read this section in its entirety before installing or configuring components.

These warnings may also be found on our website at [http://www.supermicro.com/about/policies/safety\\_information.cfm](http://www.supermicro.com/about/policies/safety_information.cfm).

#### Battery Handling



**Warning!** There is the danger of explosion if the battery is replaced incorrectly. Replace the battery only with the same or equivalent type recommended by the manufacturer. Dispose of used batteries according to the manufacturer's instructions

#### 電池の取り扱い

電池交換が正しく行われなかった場合、破裂の危険性があります。交換する電池はメーカーが推奨する型、または同等のものを使用下さい。使用済電池は製造元の指示に従って処分して下さい。

#### 警告

電池更換不當會有爆炸危險。請只使用同類電池或製造商推薦的功能相當的電池更換原有電池。請按製造商的說明處理廢舊電池。

#### 警告

電池更換不當會有爆炸危險。請使用製造商建議之相同或功能相當的電池更換原有電池。請按照製造商的說明指示處理廢棄舊電池。

#### Warnung

Bei Einsetzen einer falschen Batterie besteht Explosionsgefahr. Ersetzen Sie die Batterie nur durch den gleichen oder vom Hersteller empfohlenen Batterietyp. Entsorgen Sie die benutzten Batterien nach den Anweisungen des Herstellers.

**Attention**

Danger d'explosion si la pile n'est pas remplacée correctement. Ne la remplacer que par une pile de type semblable ou équivalent, recommandée par le fabricant. Jeter les piles usagées conformément aux instructions du fabricant.

**¡Advertencia!**

Existe peligro de explosión si la batería se reemplaza de manera incorrecta. Reemplazar la batería exclusivamente con el mismo tipo o el equivalente recomendado por el fabricante. Desechar las baterías gastadas según las instrucciones del fabricante.

**אזהרה!**

קיימת סכנת פיצוץ של הסוללה במידה והוחלפה בדרך לא תקינה. יש להחליף את הסוללה בסוג התואם מחברת יצרן מומלצת. סילוק הסוללות המשומשות יש לבצע לפי הוראות היצרן.

هناك خطر من انفجار في حالة اسبدال البطارية بطريقة غير صحيحة فعلي  
اسبدال البطارية فقط بنفس النوع أو ما يعادلها مما أوصت به الشركة المصنعة  
جخلص من البطاريات المسحمة وفقا لعمليات الشركة الصانعة

**경고!**

배터리가 올바르게 교체되지 않으면 폭발의 위험이 있습니다. 기존 배터리와 동일하거나 제조사에서 권장하는 동등한 종류의 배터리로만 교체해야 합니다. 제조사의 안내에 따라 사용된 배터리를 처리하여 주십시오.

**Waarschuwing**

Er is ontploffingsgevaar indien de batterij verkeerd vervangen wordt. Vervang de batterij slechts met hetzelfde of een equivalent type die door de fabrikant aanbevolen wordt. Gebruikte batterijen dienen overeenkomstig fabrieksvoorschriften afgevoerd te worden.

## Product Disposal



**Warning!** Ultimate disposal of this product should be handled according to all national laws and regulations.

### 製品の廃棄

この製品を廃棄処分する場合、国の関係する全ての法律・条例に従い処理する必要があります。

### 警告

本产品的废弃处理应根据所有国家的法律和规章进行。

### 警告

本產品的廢棄處理應根據所有國家的法律和規章進行。

### Warnung

Die Entsorgung dieses Produkts sollte gemäß allen Bestimmungen und Gesetzen des Landes erfolgen.

### ¡Advertencia!

Al deshacerse por completo de este producto debe seguir todas las leyes y reglamentos nacionales.

### Attention

La mise au rebut ou le recyclage de ce produit sont généralement soumis à des lois et/ou directives de respect de l'environnement. Renseignez-vous auprès de l'organisme compétent.

סילוק המוצר

אזהרה!

סילוק סופי של מוצר זה חייב להיות בהתאם להנחיות וחוקי המדינה.

عند التخلص النهائي من هذا المنتج ينبغي التعامل معه وفقا لجميع القوانين واللوائح الوطنية

### 경고!

이 제품은 해당 국가의 관련 법규 및 규정에 따라 폐기되어야 합니다.

### Waarschuwing

De uiteindelijke verwijdering van dit product dient te geschieden in overeenstemming met alle nationale wetten en reglementen.

## Appendix D

### UEFI BIOS Recovery

**Warning:** Do not upgrade the BIOS unless your system has a BIOS-related issue. Flashing the wrong BIOS can cause irreparable damage to the system. In no event shall Supermicro be liable for direct, indirect, special, incidental, or consequential damages arising from a BIOS update. If you need to update the BIOS, do not shut down or reset the system while the BIOS is updating to avoid possible boot failure. The UEFI BIOS recovery doesn't support the Ctrl+home function.

#### D.1 Overview

The Unified Extensible Firmware Interface (UEFI) provides a software-based interface between the operating system and the platform firmware in the pre-boot environment. The UEFI specification supports an architecture-independent mechanism for add-on card initialization to allow the UEFI OS loader, which is stored in the add-on card, to boot the system. The UEFI offers a clean, hands-off control to a computer system at bootup.

#### D.2 Recovering the UEFI BIOS Image

A UEFI BIOS flash chip consists of a recovery BIOS block and a main BIOS block (a main BIOS image). The boot block contains critical BIOS codes, including memory detection and recovery codes for the user to flash a new BIOS image if the original main BIOS image is corrupted. When the system power is on, the boot block codes execute first. Once it is completed, the main BIOS code will continue with system initialization and bootup.

 **Note 1:** Follow the BIOS recovery instructions below for BIOS recovery when the main BIOS boot crashes.

 **Note 2:** When the BIOS boot block crashes, you will need to follow the procedures to make a Returned Merchandise Authorization (RMA) request (see section 3.5 for more information). Also, you may use the Supermicro Update Manager (SUM) Out-of-Band (OOB) ([https://www.supermicro.com.tw/products/nfo/SMS\\_SUM.cfm](https://www.supermicro.com.tw/products/nfo/SMS_SUM.cfm)) to reflash the BIOS.

#### D.3 Recovering the BIOS Block with a USB Device

This feature allows the user to recover a BIOS image using a USB-attached device without additional utilities used. A USB flash device such as a USB Flash Drive, or a USB CD/DVD ROM/RW device can be used for this purpose. However, a USB Hard Disk drive cannot be used for BIOS recovery at this time.

The file system supported by UEFI is FAT (including FAT12, FAT16, and FAT32) installed on a bootable or non-bootable USB-attached device. However, the BIOS might need several minutes to locate the SUPER.ROM file if the media size becomes too large because it contains too many folders and files.

To perform UEFI BIOS recovery using a USB-attached device, follow the instructions below.

1. Using a different machine, copy the "Super.ROM" binary image file into the disc Root "\\" Directory of a USB device or a writeable CD/DVD.

 **Note:** If you cannot locate the "Super.ROM" file in your driver disk, visit our website at [www.supermicro.com](http://www.supermicro.com) to download the BIOS image into a USB flash device and rename it "Super.ROM" for BIOS recovery use.

2. Insert the USB device that contains the new BIOS image ("Super.ROM") into your USB drive and power on the system
3. While powering on the system, please keep pressing <Ctrl> and <Home> simultaneously on your keyboard *until the following screen (or a screen similar to the one below) displays.*

**Warning:** Please **stop** pressing the <Ctrl> and <Home> keys immediately when you see the screen (or a similar screen) below; otherwise, it will trigger a system reboot.



 **Note:** On the other hand, if the following screen displays, please load the "Super.ROM" file to the root folder and connect this folder to the system. (You can do so by inserting a USB device that contains the new "Super.ROM" image to your machine for BIOS recovery.)

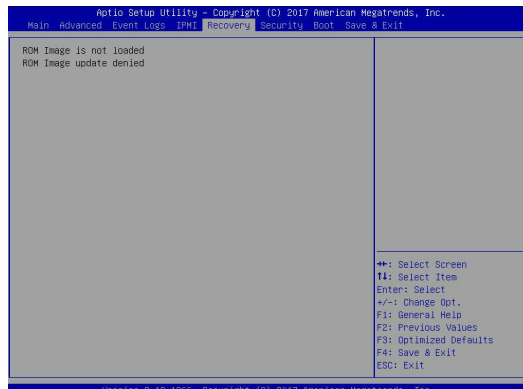

4. After locating the new BIOS binary image, the system will enter the BIOS Recovery menu as shown below.

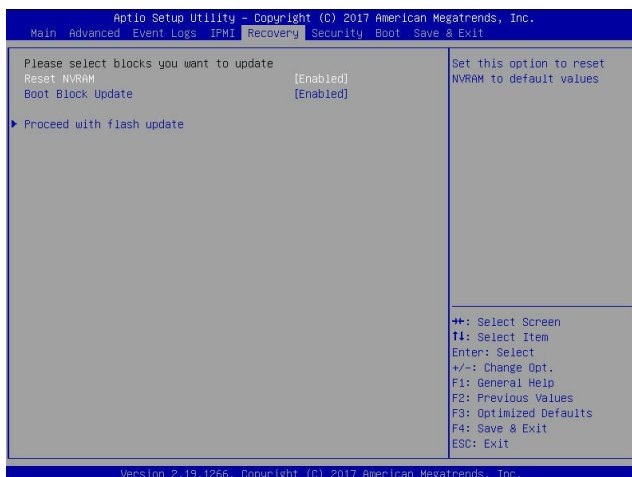

 **Note:** At this point, you may decide if you want to start the BIOS recovery. If you decide to proceed with BIOS recovery, follow the procedures below.

5. When the screen as shown above displays, use the arrow keys to select the item "Proceed with flash update" and press the <Enter> key. You will see the BIOS recovery progress as shown in the screen below.

 **Note:** Do not interrupt the BIOS flashing process until it has completed.

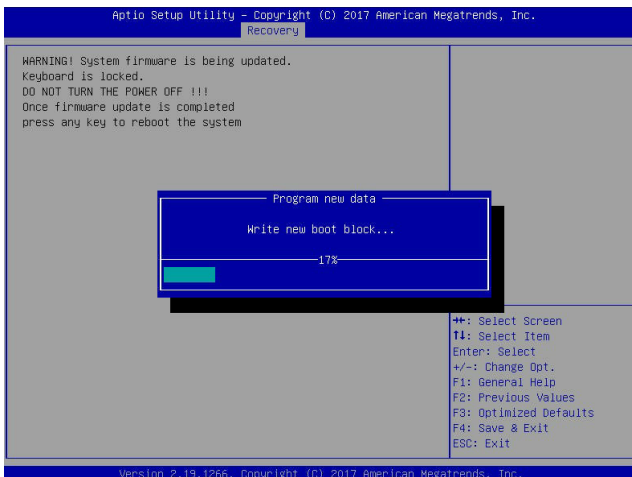

- After the BIOS recovery process is completed, press any key to reboot the system.

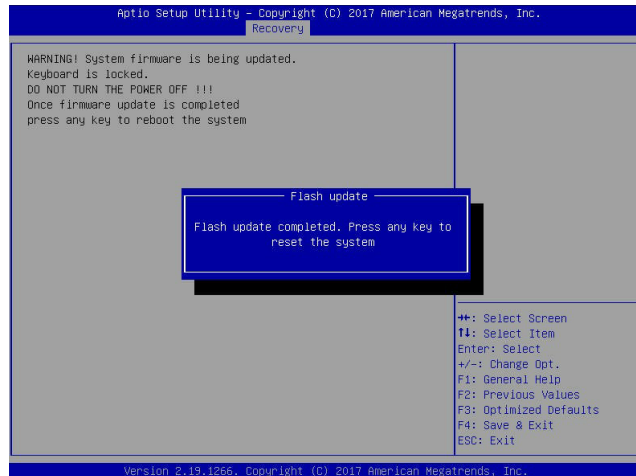

- Using a different system, extract the BIOS package into a USB flash drive.
- Press <Del> continuously to enter the BIOS setup utility. Set the item, Boot Option #1, to [UEFI AP:UEFI: Built-in EFI Shell]. Press <F4> to save the settings and exit the BIOS setup utility.

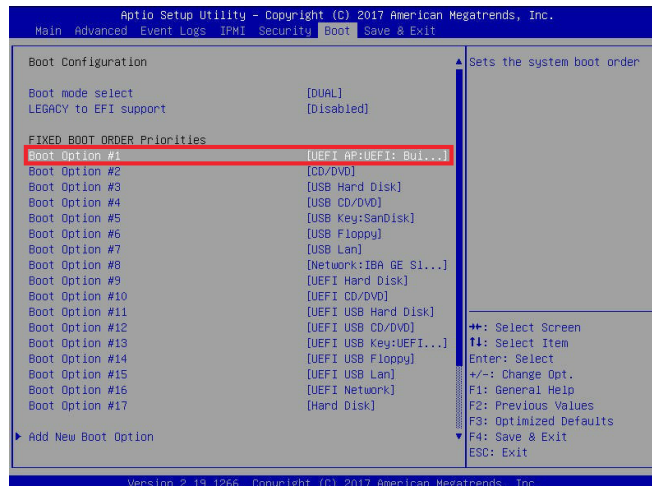

9. When the UEFI Shell prompt appears, type `fs#` to change the device directory path. Go to the directory which contains the BIOS package extracted earlier from Step 7. Enter `flash.nsh BIOSname.###` at the prompt to start the BIOS update process.

```

UEFI Interactive Shell v2.1
EDK II
UEFI v2.50 (American Megatrends, 0x0005000C)
Mapping table
  FS0: Alias(s):HD(0):MBR:BLK1:
      PciRoot(0x0)/Pci(0x14,0x0)/USB(0x11,0x0)/HD(1,MBR,0x37901072,0x800,0x1
CR3592)
  BLK0: Alias(s):
      PciRoot(0x0)/Pci(0x14,0x0)/USB(0x11,0x0)
Press F8 in 1 seconds to skip startup.nsh or any other key to continue.
Shell> fs0:
FS0:\> cd AFUDOS
FS0:\AFUDOS> cd SKIPME2_03162017
FS0:\AFUDOS\SKIPME2_03162017> flash.nsh X110PU7_314

```



**Note:** Do not interrupt this process until the BIOS flashing is complete.

```

Done.
[ Access Cmos Port Ex ]
<read>
Index 0x51: 0x18
Done.
*****
*
* Program BIOS and ME (including FDT) regions...
*
*****
| AMI Firmware Update Utility v5.09.01.1917
| Copyright (C)2017 American Megatrends Inc. All Rights Reserved.
|-----|
CPUID = 50652
Reading flash ..... done
- ME Data Size checking . ok
- FFS checksums ..... ok
- Check RomLayout ..... Ok
Erasing Boot Block ..... done
Updating Boot Block ..... done
Verifying Boot Block ..... done
Erasing Main Block ..... 0x00132000 (0x)

```

10. The screen below indicates that the BIOS update process is complete. Unplug the AC power cable from the power supply, clear the CMOS, and plug the AC power cable in the power supply again to power on the system.

```

Verifying Boot Block ..... done
Erasing Main Block ..... done
Updating Main Block ..... done
Verifying Main Block ..... done
Erasing NVRAM Block ..... done
Updating NVRAM Block ..... done
Verifying NVRAM Block ..... done
Erasing NCB Block ..... done
Updating NCB Block ..... done
Verifying NCB Block ..... done
- FDR is locked, skip updating.
- GBEB is locked, skip updating.
- GBEB is locked, skip updating.
- Successful Update Recovery Loader to OPRx!!
- Successful Update MFSB!!
- Successful Update FTFR!!
- Successful Update factory data partitions!!
- ME Entire Image update success !!
WARNING : System must power-off to have the changes take effect!
flash.nsh> mv AFUEFIx64.efi AFUEFIx64.smc
mv: moving fs0:\AFUEFIx64.efi -> \AFUEFIx64.smc
- [ok]
fs0:\>

```

11. Press `<Del>` continuously to enter the BIOS setup utility.
12. Press `<F3>` to load the default settings.
13. After loading the default settings, press `<F4>` to save the settings and exit the BIOS setup utility.

## Appendix E

### Dual Boot Block

#### E.1 Introduction

This motherboard supports the Dual Boot Block feature, which is the last-ditch mechanism to recover the BIOS boot block. This section provides an introduction to the feature.

##### BIOS Boot Block

A BIOS boot block is the minimum BIOS loader required to enable necessary hardware components for the BIOS crisis recovery flash that will update the main BIOS block. An on-call BIOS boot-block corruption may occur due to a software tool issue (see image below) or an unexpected power outage during BIOS updates.

```
-----  
                AMI Firmware Update Utility vX.XX.XX  
        Copyright (C)XXXX American Megatrends Inc. All Rights Reserved.  
-----  
Reading flash . . . . . done  
-- ME Data Size checking . ok  
-- FFS checksums . . . . . ok  
Erasing Boot Block . . . . . done  
__ Updating Boot Block . . . . . 0x00A91000 (13%)
```

##### BIOS Boot Block Corruption Occurrence

When a BIOS boot block is corrupted due to an unexpected power outage or a software tool malfunctioning during BIOS updates, you can still reboot the system by closing pins 2 and 3 using a cap on jumper JBR1. When JBR1 is set to pins 2 and 3, the system will boot from a backup boot block pre-loaded in the BIOS by the manufacturer.

## **E.2 Steps to Reboot the System by Using Jumper JBR1**

1. Power down the system.
2. Close pins 2-3 on jumper JBR1 and power on the system.
3. Follow the BIOS recovery SOP listed in the previous chapter (Appendix D).
4. After completing the steps above, power down the system.
5. Close pins 1-2 on jumper JBR1 and power on the system.