



X11SAT  
X11SAT-F

USER'S MANUAL

Revision 1.1a

The information in this user's manual has been carefully reviewed and is believed to be accurate. The vendor assumes no responsibility for any inaccuracies that may be contained in this document, and makes no commitment to update or to keep current the information in this manual, or to notify any person or organization of the updates. **Please Note: For the most up-to-date version of this manual, please see our website at [www.supermicro.com](http://www.supermicro.com).**

Super Micro Computer, Inc. ("Supermicro") reserves the right to make changes to the product described in this manual at any time and without notice. This product, including software and documentation, is the property of Supermicro and/or its licensors, and is supplied only under a license. Any use or reproduction of this product is not allowed, except as expressly permitted by the terms of said license.

IN NO EVENT WILL Super Micro Computer, Inc. BE LIABLE FOR DIRECT, INDIRECT, SPECIAL, INCIDENTAL, SPECULATIVE OR CONSEQUENTIAL DAMAGES ARISING FROM THE USE OR INABILITY TO USE THIS PRODUCT OR DOCUMENTATION, EVEN IF ADVISED OF THE POSSIBILITY OF SUCH DAMAGES. IN PARTICULAR, SUPER MICRO COMPUTER, INC. SHALL NOT HAVE LIABILITY FOR ANY HARDWARE, SOFTWARE, OR DATA STORED OR USED WITH THE PRODUCT, INCLUDING THE COSTS OF REPAIRING, REPLACING, INTEGRATING, INSTALLING OR RECOVERING SUCH HARDWARE, SOFTWARE, OR DATA.

Any disputes arising between manufacturer and customer shall be governed by the laws of Santa Clara County in the State of California, USA. The State of California, County of Santa Clara shall be the exclusive venue for the resolution of any such disputes. Supermicro's total liability for all claims will not exceed the price paid for the hardware product.

FCC Statement: This equipment has been tested and found to comply with the limits for a Class B digital device pursuant to Part 15 of the FCC Rules. These limits are designed to provide reasonable protection against harmful interference when the equipment is operated in a consumer environment or residential installation. This equipment generates, uses, and can radiate radio frequency energy and, if not installed and used in accordance with the manufacturer's instruction manual, may cause harmful interference with radio communications. Operation of this equipment in a residential area is likely to cause harmful interference, in which case you will be required to correct the interference at your own expense.

California Best Management Practices Regulations for Perchlorate Materials: This Perchlorate warning applies only to products containing CR (Manganese Dioxide) Lithium coin cells. "Perchlorate Material-special handling may apply. See [www.dtsc.ca.gov/hazardouswaste/perchlorate](http://www.dtsc.ca.gov/hazardouswaste/perchlorate).



WARNING: This product can expose you to chemicals including lead, known to the State of California to cause cancer and birth defects or other reproductive harm. For more information, go to [www.P65Warnings.ca.gov](http://www.P65Warnings.ca.gov).

The products sold by Supermicro are not intended for and will not be used in life support systems, medical equipment, nuclear facilities or systems, aircraft, aircraft devices, aircraft/emergency communication devices or other critical systems whose failure to perform be reasonably expected to result in significant injury or loss of life or catastrophic property damage. Accordingly, Supermicro disclaims any and all liability, and should buyer use or sell such products for use in such ultra-hazardous applications, it does so entirely at its own risk. Furthermore, buyer agrees to fully indemnify, defend and hold Supermicro harmless for and against any and all claims, demands, actions, litigation, and proceedings of any kind arising out of or related to such ultra-hazardous use or sale.

Manual Revision 1.1a

Release Date: June 21, 2021

Unless you request and receive written permission from Super Micro Computer, Inc., you may not copy any part of this document. Information in this document is subject to change without notice. Other products and companies referred to herein are trademarks or registered trademarks of their respective companies or mark holders.

Copyright © 2021 by Super Micro Computer, Inc.  
All rights reserved.

**Printed in the United States of America**

# Preface

## About This Manual

This manual is written for system integrators, IT technicians and knowledgeable end users. It provides information for the installation and use of the X11SAT/X11SAT-F motherboard.

## About This Motherboard

The Supermicro X11SAT/X11SAT-F motherboard supports an Intel® Xeon® E3-12xx v5, 6th-Gen Core™ i3/i5/i7, Celeron®, or Pentium® series processor in an LGA 1151 (H4) socket. With support of the Intel C236 chipset, DDR4 memory, SATA 3.0, and Trusted Platform Module (TPM), this motherboard is ideal for high-end workstations. Please note that this motherboard is intended to be installed and serviced by professional technicians only. For processor/memory updates, please refer to our website at <http://www.supermicro.com/products/>.

## Conventions Used in the Manual

Special attention should be given to the following symbols for proper installation and to prevent damage done to the components or injury to yourself:



**Warning!** Indicates important information given to prevent equipment/property damage or personal injury.



**Warning!** Indicates high voltage may be encountered while performing a procedure.



**Important:** Important information given to ensure proper system installation or to relay safety precautions.



**Note:** Additional Information given to differentiate various models or provides information for proper system setup.

## Contacting Supermicro

### Headquarters

Address: Super Micro Computer, Inc.  
980 Rock Ave.  
San Jose, CA 95131 U.S.A.

Tel: +1 (408) 503-8000

Fax: +1 (408) 503-8008

Email: [marketing@supermicro.com](mailto:marketing@supermicro.com) (General Information)  
[support@supermicro.com](mailto:support@supermicro.com) (Technical Support)

Website: [www.supermicro.com](http://www.supermicro.com)

### Europe

Address: Super Micro Computer B.V.  
Het Sterrenbeeld 28, 5215 ML  
's-Hertogenbosch, The Netherlands

Tel: +31 (0) 73-6400390

Fax: +31 (0) 73-6416525

Email: [sales@supermicro.nl](mailto:sales@supermicro.nl) (General Information)  
[support@supermicro.nl](mailto:support@supermicro.nl) (Technical Support)  
[rma@supermicro.nl](mailto:rma@supermicro.nl) (Customer Support)

Website: [www.supermicro.nl](http://www.supermicro.nl)

### Asia-Pacific

Address: Super Micro Computer, Inc.  
3F, No. 150, Jian 1st Rd.  
Zhonghe Dist., New Taipei City 235  
Taiwan (R.O.C)

Tel: +886-(2) 8226-3990

Fax: +886-(2) 8226-3992

Email: [support@supermicro.com.tw](mailto:support@supermicro.com.tw)

Website: [www.supermicro.com.tw](http://www.supermicro.com.tw)

---

---

# Table of Contents

## **Chapter 1 Introduction**

1.1 Checklist.....	8
Quick Reference .....	12
Quick Reference Table.....	13
Motherboard Features.....	15
1.2 Processor and Chipset Overview.....	19
1.3 Special Features .....	19
Recovery from AC Power Loss.....	19
1.4 System Health Monitoring.....	20
Onboard Voltage Monitors .....	20
Fan Status Monitor with Firmware Control .....	20
Environmental Temperature Control .....	20
System Resource Alert.....	20
1.5 ACPI Features.....	20
1.6 Power Supply .....	21
1.7 Super I/O .....	21
1.8 Advanced Power Management.....	21
Intel Intelligent Power Node Manager (IPNM).....	21
Management Engine (ME).....	22

## **Chapter 2 Installation**

2.1 Static-Sensitive Devices.....	23
Precautions .....	23
Unpacking .....	23
2.2 Motherboard Installation.....	24
Tools Needed .....	24
Location of Mounting Holes .....	24
Installing the Motherboard.....	25
2.3 Processor and Heatsink Installation.....	26
Installing the LGA1151 Processor.....	26
Installing an Active CPU Heatsink with Fan .....	29
Removing the Heatsink.....	31

2.4	Memory Support and Installation .....	32
	Memory Support.....	32
	DIMM Module Population Configuration .....	32
	DIMM Module Population Sequence .....	32
	DIMM Installation .....	33
	DIMM Removal .....	33
2.5	Rear I/O Ports .....	34
2.6	Front Control Panel .....	39
2.7	Connectors .....	43
	Power Connections .....	43
	Headers.....	45
2.8	Jumper Settings .....	55
	How Jumpers Work.....	55
2.9	LED Indicators.....	60
<b>Chapter 3 Troubleshooting</b>		
3.1	Troubleshooting Procedures .....	62
	Before Power On .....	62
	No Power .....	62
	No Video .....	63
	System Boot Failure .....	63
	Memory Errors .....	63
	Losing the System's Setup Configuration.....	64
	When the System Becomes Unstable .....	64
3.2	Technical Support Procedures .....	66
3.3	Frequently Asked Questions .....	67
3.4	Battery Removal and Installation .....	68
	Battery Removal.....	68
	Proper Battery Disposal .....	68
	Battery Installation.....	68
3.5	Returning Merchandise for Service.....	69

---

---

**Chapter 4 UEFI BIOS**

4.1 Introduction .....	70
4.2 Main Setup .....	71
4.3 Advanced Setup Configurations .....	73
4.4 Event Logs .....	95
4.5 Security .....	97
4.6 Boot .....	100
4.7 Save & Exit .....	102

**Appendix A BIOS Codes****Appendix B Software**

B.1 Driver Installation .....	106
B.2 SuperDoctor 5 .....	107
B.3 IPMI .....	108
B.4 Logging into the BMC (Baseboard Management Controller) .....	108

**Appendix C Standardized Warning Statements****Appendix D UEFI BIOS Recovery**

# Chapter 1

## Introduction

Congratulations on purchasing your computer motherboard from an industry leader. Supermicro motherboards are designed to provide you with the highest standards in quality and performance.

In addition to the motherboard and chassis, several important parts that are included with the system are listed below. If anything listed is damaged or missing, please contact your retailer.

### 1.1 Checklist

Main Parts List		
Description	Part Number	Quantity
Supermicro Motherboard	X11SAT/X11SAT-F	1
SATA Cables	CBL-0044L	6

### Important Links

For your system to work properly, please follow the links below to download all necessary drivers/utilities and the user's manual for your server.

- Supermicro product manuals: <http://www.supermicro.com/support/manuals/>
- Product drivers and utilities: <https://www.supermicro.com/wdl/driver/>
- Product safety info: [http://www.supermicro.com/about/policies/safety\\_information.cfm](http://www.supermicro.com/about/policies/safety_information.cfm)
- A secure data deletion tool designed to fully erase all data from storage devices can be found at our website: [https://www.supermicro.com/about/policies/disclaimer.cfm?url=/wdl/utility/Lot9\\_Secure\\_Data\\_Deletion\\_Utility/](https://www.supermicro.com/about/policies/disclaimer.cfm?url=/wdl/utility/Lot9_Secure_Data_Deletion_Utility/)
- If you have any questions, please contact our support team at: [support@supermicro.com](mailto:support@supermicro.com)

This manual may be periodically updated without notice. Please check the Supermicro website for possible updates to the manual revision level.

Figure 1-1. X11SAT Motherboard Image

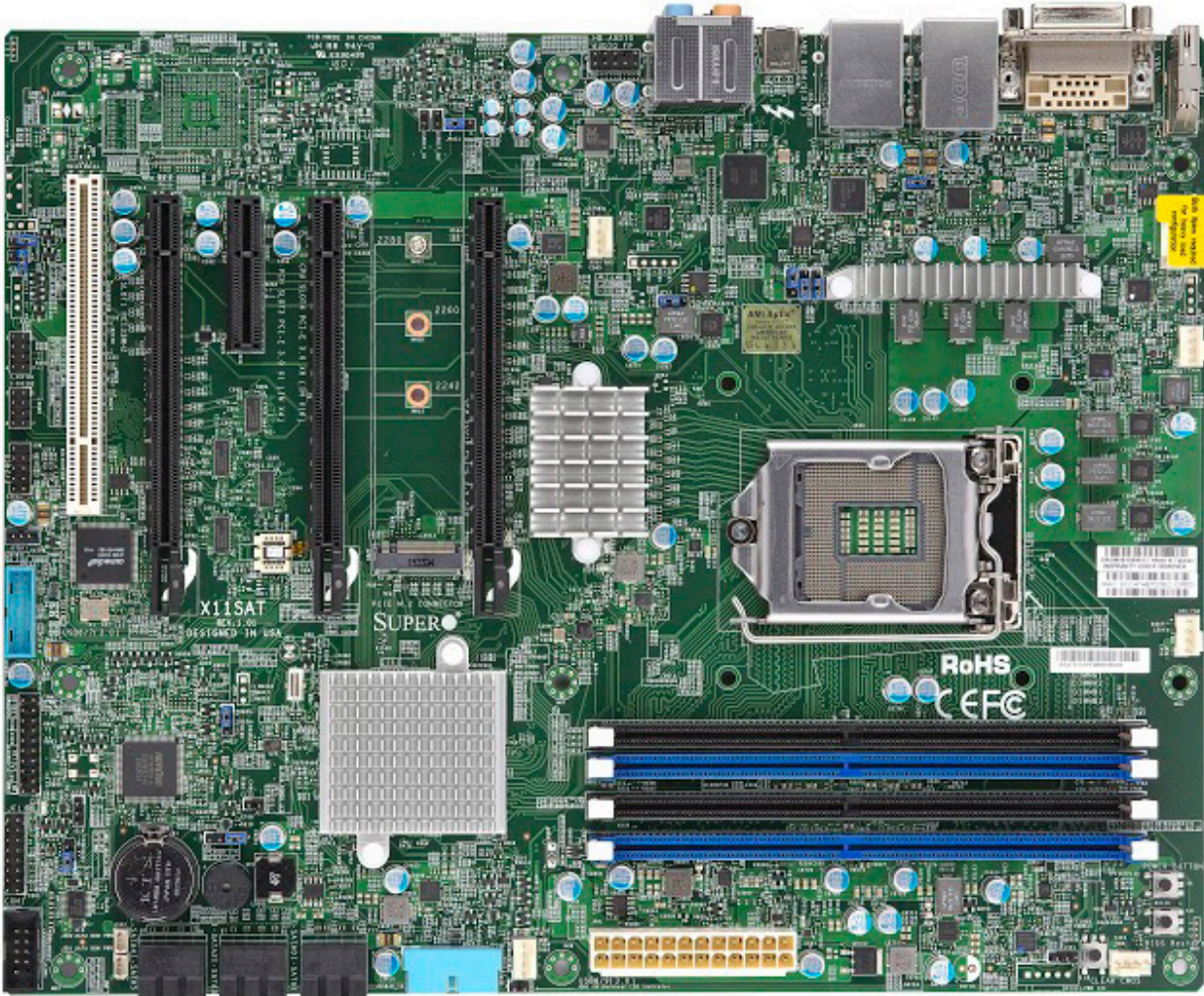

**Note:** All graphics shown in this manual were based upon the latest PCB revision available at the time of publication of the manual. The motherboard you received may or may not look exactly the same as the graphics shown in this manual.

Figure 1-2. X11SAT-F Motherboard Image

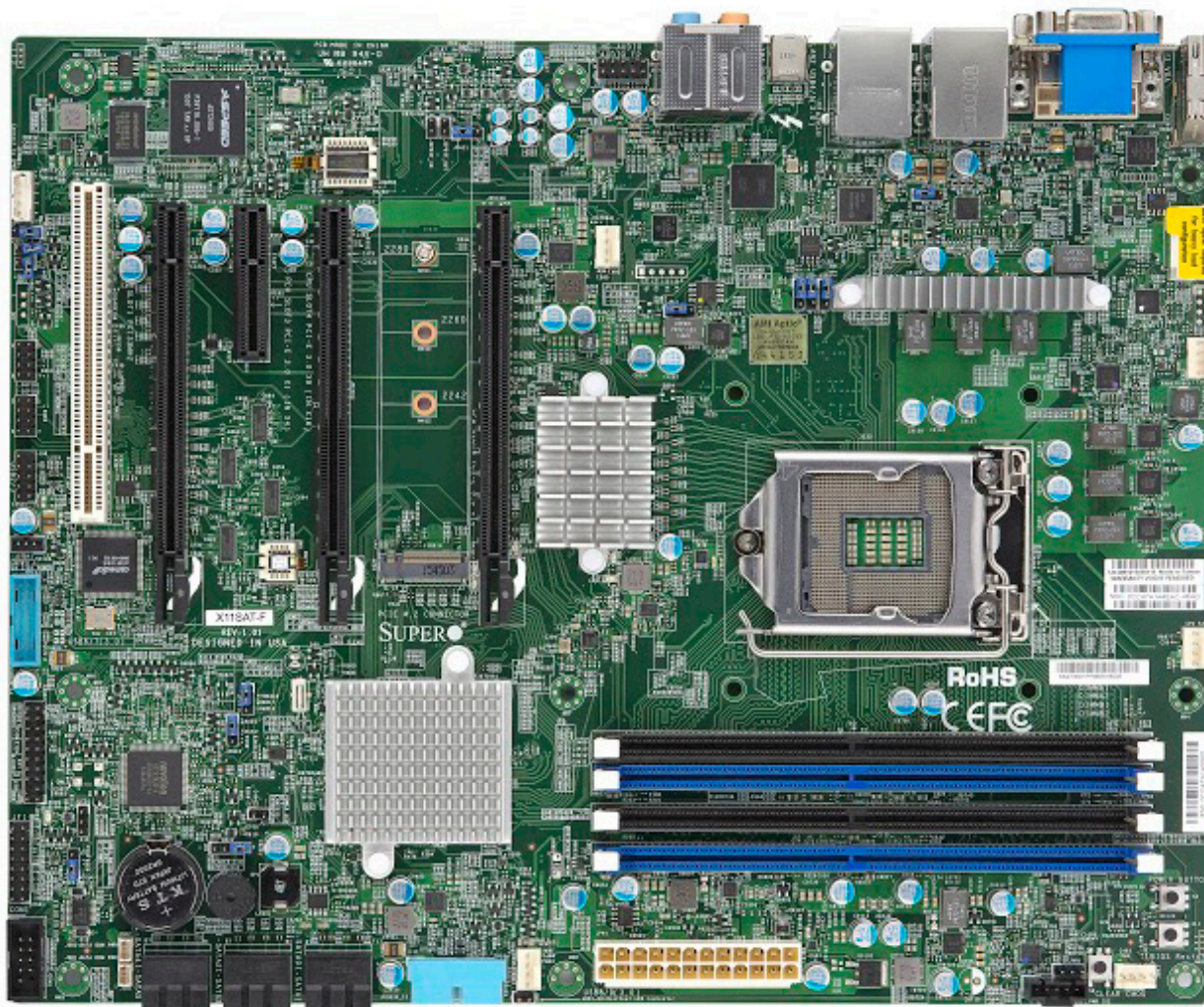

 **Note:** All graphics shown in this manual were based upon the latest PCB revision available at the time of publication of the manual. The motherboard you received may or may not look exactly the same as the graphics shown in this manual.

**Figure 1-3. X11SAT/X11SAT-F Motherboard Layout**  
(not drawn to scale)

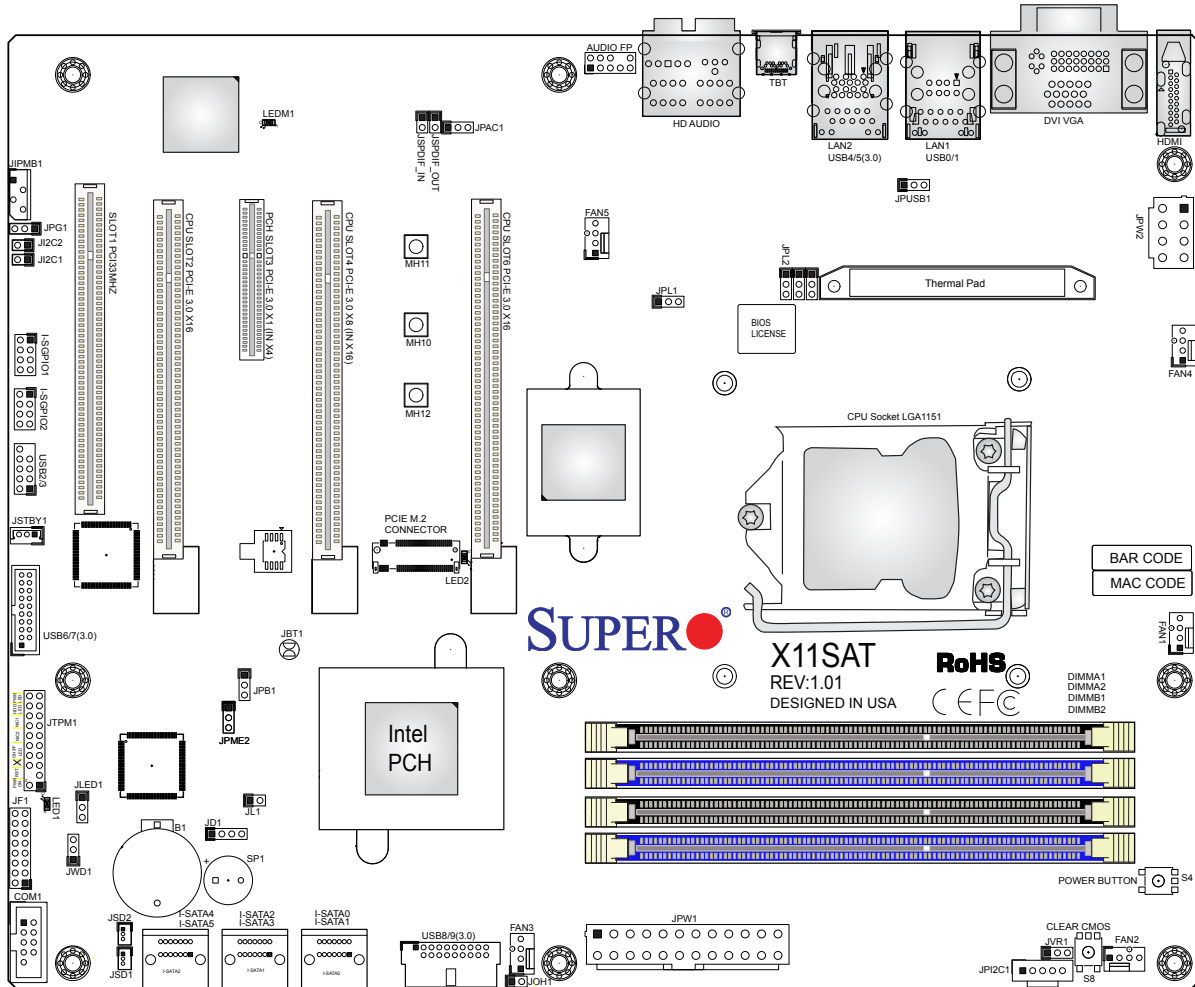

 **Note:** Components not documented are for internal testing only.

## Quick Reference

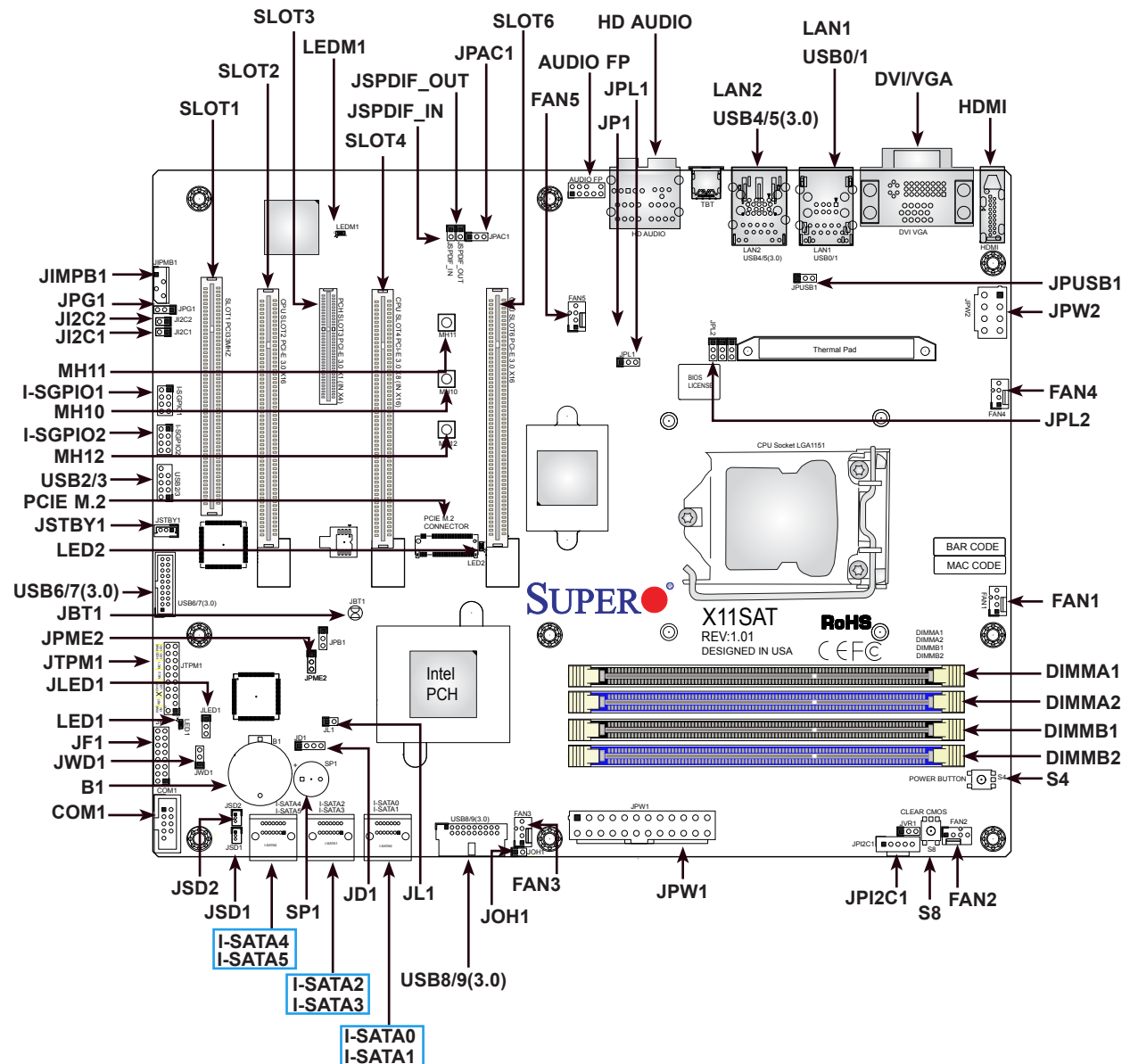

### Notes:

- See [Chapter 2](#) for detailed information on jumpers, I/O ports, and JF1 front panel connections.
- " ■ " indicates the location of Pin 1.
- Jumpers/LED indicators not indicated are used for testing only.
- Use only the correct type of onboard CMOS battery as specified by the manufacturer. Do not install the onboard battery upside down to avoid possible explosion.

## Quick Reference Table

Jumper	Description	Default Setting
JBT1	CMOS Clear	Open (Normal)
J <sup>I</sup> C1/J <sup>I</sup> C2	SMB to PCIe Slots Enable/Disable	Both Open (Disabled)
JPAC1	Audio Enable	Pins 1-2 (Enabled)
JPB1	BMC Enable/Disable	Pins 1-2 (Enabled)
JPG1	VGA Enable/Disable	Pins 1-2 (Enabled)
JPL1/JPL2	LAN1/LAN2 Enable/Disable	Pins 1-2 (Enabled)
JPME2	Manufacturing Mode	Pins 1-2 (Normal)
JPUSB1	USB0/1 Wake up	Pins 1-2 (Enabled)
JWD1	Watch Dog	Pins 1-2 (Reset)

LED	Description	Status
LED1	Power LED	Green: Power On
LED2	M.2 LED	On: M.2 onboard
LEDM1	BMC Heartbeat LED	Blinking Green: BMC Normal



Connector	Description
AUDIO FP	Front Panel Audio Header
B1	Onboard Battery
COM1	COM Header
DVI/VGA	Digital Video Interface/VGA Connectors (VGA on X11SAT-F only)
FAN1 ~ FAN5	System/CPU Fan Headers (FAN1: CPU Fan)
HD Audio	High Definition Audio Connector
HDMI	High Definition Multimedia Interface Connector
I-SATA0 ~ I-SATA5	Intel PCH SATA 3.0 Ports
I-SGPIO1/I-SGPIO2	General Purpose I/O Headers
JD1	Speaker/Buzzer (Pins 1-4: Speaker, Pins 3-4: Buzzer)
JF1	Front Control Panel Header
JIPMB1	4-pin BMC External I <sup>2</sup> C Header
JL1	Chassis Intrusion Header
JLED1	3-Pin Power LED Indicator Header
JOH1	Overheat LED Header
JPI <sup>2</sup> C1	Power SMBus I <sup>2</sup> C Header
JPW1	24-pin ATX Power Connector
JPW2	8-pin 12V Processor Power Connector
JSD1/JSD2	SATA DOM Power Connectors
JSPDIF_IN	Sony/Phillips Digital Interconnect Format Audio In Header



**Note:** Table is continued on the next page.

<b>Connector</b>	<b>Description</b>
JSPDIF_OUT	Sony/Phillips Digital Interconnect Format Audio Output Header
JSTBY1	Standby Power Header
JTPM1	Trusted Platform Module/Port 80 Connector
JVR1	SMB Programming Header (for debugging only)
LAN1/LAN2	LAN (RJ45) Ports (LAN2 is shared with the IPMI port on X11SAT-F)
MH10 ~ MH12	M.2 Mounting Holes
PCIE M.2	PCIe M.2 Socket
S4	Power Button
S8	Clear CMOS
SLOT1	PCI 33MHz Slot
SLOT2/SLOT6	CPU PCIe 3.0 x16 Slots
SLOT3	PCH PCIe 3.0 x1 (IN x4) Slot
SLOT4	CPU PCIe 3.0 x8 (IN x16) Slot
SP1	Internal Speaker/Buzzer
USB0/1	Back panel Universal Serial Bus (USB) 2.0 Ports
USB2/3	Front Accessible USB 2.0 Header
USB4/5	Back panel USB 3.0 Ports
USB6/7, USB8/9	Front Accessible USB 3.0 Headers

## Motherboard Features

Motherboard Features	
<b>CPU</b>	
<ul style="list-style-type: none"> <li>Intel E3-12XX v5 series, 6th Gen. Core i3/i5/i7, Pentium, and Celeron series processors</li> </ul>	
<b>Memory</b>	
<ul style="list-style-type: none"> <li>Integrated memory controller supports up to 64 GB of DDR4 ECC/Non-ECC UDIMM memory with speeds of up to 2133MHz</li> </ul>	
<b>DIMM Size</b>	
<ul style="list-style-type: none"> <li>Up to 16GB at 1.2V</li> </ul>	
 <b>Note 1:</b> Memory speed support depends on the processors used in the system.	
 <b>Note 2:</b> For the latest CPU/memory updates, please refer to our website at <a href="http://www.supermicro.com/products/motherboard">http://www.supermicro.com/products/motherboard</a> .	
<b>Chipset</b>	
<ul style="list-style-type: none"> <li>Intel PCH C236</li> </ul>	
<b>Expansion Slots</b>	
<ul style="list-style-type: none"> <li>One PCIe 3.0 x1 (IN x4) (PCH SLOT3)</li> <li>One PCIe 3.0 x8 (IN x16) (CPU SLOT4)</li> <li>Two PCIe 3.0 x16 (CPU SLOT2/SLOT6)</li> <li>One PCI 33MHz (SLOT1)</li> <li>One M.2 PCIe (M.2 SOCKET)</li> </ul>	
<b>Network</b>	
<ul style="list-style-type: none"> <li>Intel I219LM Gigabit Network Controller (vPro support)</li> <li>Intel I210AT Gigabit Network Controller (LAN2, shared with IPMI)</li> </ul>	
<b>Graphics</b>	
<ul style="list-style-type: none"> <li>Intel IGD</li> </ul>	
<b>I/O Devices</b>	
<ul style="list-style-type: none"> <li>Serial (COM) Port</li> </ul>	<ul style="list-style-type: none"> <li>One COM header</li> </ul>
<ul style="list-style-type: none"> <li>SATA 3.0</li> </ul>	<ul style="list-style-type: none"> <li>Six SATA 3.0 ports supported by Intel PCH (I-SATA 0-5)</li> </ul>



**Note:** The table above is continued on the next page.

## Motherboard Features

### Peripheral Devices

- Two USB 2.0 ports on the rear I/O panel (USB0/1)
- One front access USB 2.0 header with two USB connections (USB2/3)
- Two USB 3.0 ports on the rear I/O panel (USB4/5)
- Two front access USB 3.0 headers with four USB connections (USB6/7, USB8/9)

### BIOS

- 128 Mb SPI AMI BIOS® SM Flash UEFI BIOS
- ACPI3.0, SMBIOS 2.7, Plug-and-Play (PnP), BIOS Rescue Hot-key, PCI F/W 3.0, SPI dual/quad speed support, RTC wakeup

### Power Management

- Power button override mechanism
- Power-on mode for AC power recovery
- Intel Intelligent Power Node Manager 3.0 (available when the Supermicro Power Manager [SPM] is installed and a special power supply is used. See the note on [page 21](#)).
- ACPI Management
- Wake-On-LAN
- Management Engine (ME) (with Client Platform Service)

### System Health Monitoring

- Onboard voltage monitoring for +1.0V, +3.3V, 3.3V standby, +5V, +12V, VBAT, CPU, Memory, PCH Temp., System Temp., Memory Temp.
- CPU/system overheat LED and control
- CPU Thermal Trip support
- CPU Thermal Design Power (TDP) support of up to 95W (See [Note 1](#) on next page.)

### Fan Control

- Fan status monitoring via IPMI connections
- Dual cooling zone
- Low-noise fan speed control
- Pulse Width Modulation (PWM) fan control

### System Management

- Trusted Platform Module (TPM) support
- Platform Environment Control Interface (PECI) 3.1 support
- System resource alert via SuperDoctor® 5
- SuperDoctor 5, Watch Dog, NMI
- Chassis intrusion header and detection
- Supermicro Update Manager (SUM) InBand, SUM-OOB



**Note:** The table above is continued on the next page.

Motherboard Features
<b>LED Indicators</b>
<ul style="list-style-type: none"><li>• CPU/Overheating</li><li>• Fan Failure</li><li>• Power/Suspend state indicator.</li><li>• HDD activity</li><li>• LAN activity</li></ul>
<b>Dimensions</b>
<ul style="list-style-type: none"><li>• 9.6" (L) x 12" (W) (240.84 mm x 304.8 mm)</li></ul>

 **Note 1:** The CPU maximum thermal design power (TDP) is subject to chassis and heatsink cooling restrictions. For proper thermal management, please check the chassis and heatsink specifications for proper CPU TDP sizing.

**Note 2:** For IPMI configuration instructions, please refer to the Embedded IPMI Configuration User's Guide available at <http://www.supermicro.com/support/manuals/>.

**Note 3:** For proper BMC configuration, please refer to [https://www.supermicro.com/products/nfo/files/IPMI/Best\\_Practices\\_BMC\\_Security.pdf](https://www.supermicro.com/products/nfo/files/IPMI/Best_Practices_BMC_Security.pdf).

**Figure 1-4.**  
**System Block Diagram**

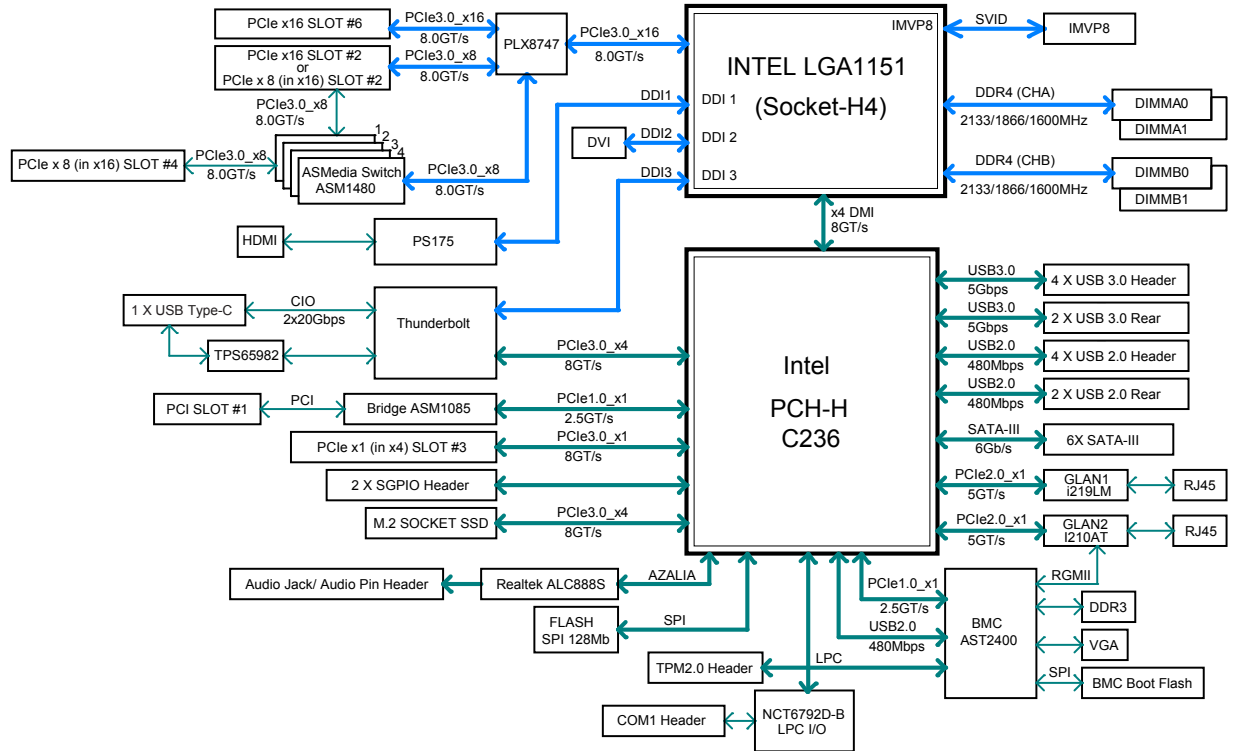

**Note:** This is a general block diagram and may not exactly represent the features on your motherboard. See the previous pages for the actual specifications of your motherboard.

## 1.2 Processor and Chipset Overview

Built upon the functionality and capability of the Intel E3-12xx v5 series processors (Socket LGA 1151) and the Intel C236 PCH, the X11SAT/X11SAT-F motherboard offers maximum I/O expendability, energy efficiency, and data reliability in a 14-nm process architecture, and is optimized for embedded storage solutions, networking applications, or cloud-computing platforms.

The Intel E3-12xx V5 and PCH C236 platform supports the following features:

- ACPI Power Management Logic Support, Rev. 4.0a
- Intel Turbo Boost Technology 2.0 Power Monitoring/Power Control, Turbo Time Parameter (TAU), and Platform Power Control
- Configurable TDP (cTDP) and Lower-Power Mode
- Adaptive Thermal Management/Monitoring
- PCIe 3.0, SATA 3.0 w/transfer rates of up to 6 Gb/s, xHCI USB w/SuperSpeed 3.0
- System Management Bus (SMBus) Specification, Version 2.0
- Integrated Sensor Hub (ISH)The BMC supports remote management, virtualization, and the security package for enterprise platforms
- Intel Trusted Execution Technology (Intel TXT)
- Intel Rapid Storage Technology
- Intel Virtualization Technology for Directed I/O (Intel VT-d)

## 1.3 Special Features

This section describes the health monitoring features of the X11SAT/X11SAT-F motherboard. The motherboard has an onboard System Hardware Monitor chip that supports system health monitoring.

### Recovery from AC Power Loss

The Basic I/O System (BIOS) provides a setting that determines how the system will respond when AC power is lost and then restored to the system. You can choose for the system to remain powered off (in which case you must press the power switch to turn it back on), or for it to automatically return to the power-on state. See the [Advanced BIOS Setup](#) section for this setting. The default setting is Last State.

## 1.4 System Health Monitoring

This section describes the health monitoring features of the X11SAT/X11SAT-F motherboard. The motherboard has an onboard Baseboard Management Controller (BMC) chip that supports system health monitoring. Once a voltage becomes unstable, a warning is given or an error message is sent to the screen. The user can adjust the voltage thresholds to define the sensitivity of the voltage monitor.

### Onboard Voltage Monitors

The onboard voltage monitor will continuously scan crucial voltage levels. Once a voltage becomes unstable, it will give a warning or send an error message to the screen. Users can adjust the voltage thresholds to define the sensitivity of the voltage monitor. Real time readings of these voltage levels are all displayed in BIOS.

### Fan Status Monitor with Firmware Control

The system health monitor embedded in the BMC chip can check the RPM status of the cooling fans. The CPU and chassis fans are controlled via IPMI.

### Environmental Temperature Control

System Health sensors in the BMC monitor the temperatures and voltage settings of onboard processors and the system in real time via the IPMI interface. Whenever the temperature of the CPU or the system exceeds a user-defined threshold, system/CPU cooling fans will be turned on to prevent the CPU or the system from overheating.



**Note:** To avoid possible system overheating, please be sure to provide adequate air-flow to your system.

### System Resource Alert

This feature is available when used with SuperDoctor 5. SuperDoctor 5 is used to notify the user of certain system events. For example, you can configure SuperDoctor 5 to provide you with warnings when the system temperature, CPU temperatures, voltages and fan speeds go beyond a predefined range.

## 1.5 ACPI Features

ACPI stands for Advanced Configuration and Power Interface. The ACPI specification defines a flexible and abstract hardware interface that provides a standard way to integrate power management features throughout a computer system including its hardware, operating system and application software. This enables the system to automatically turn on and off peripherals such as network cards, hard disk drives and printers.

In addition to enabling operating system-directed power management, ACPI also provides a generic system event mechanism for Plug and Play and an operating system-independent interface for configuration control. ACPI leverages the Plug and Play BIOS data structures while providing a processor architecture-independent implementation that is compatible with Windows 8/R2, and Windows 2012/R2 operating systems.

## 1.6 Power Supply

As with all computer products, a stable power source is necessary for proper and reliable operation. It is even more important for processors that have high CPU clock rates. In areas where noisy power transmission is present, you may choose to install a line filter to shield the computer from noise. It is recommended that you also install a power surge protector to help avoid problems caused by power surges.

## 1.7 Super I/O

The Super I/O provides two high-speed, 16550 compatible serial communication ports (UARTs). Each UART includes a 16-byte send/receive FIFO, a programmable baud rate generator, complete modem control capability and a processor interrupt system. Both UARTs provide legacy speed with baud rate of up to 115.2 Kbps as well as an advanced speed with baud rates of 250 K, 500 K, or 1 Mb/s, which support higher speed modems.

The Super I/O provides functions that comply with ACPI (Advanced Configuration and Power Interface), which includes support of legacy and ACPI power management through a SMI or SCI function pin. It also features auto power management to reduce power consumption.

## 1.8 Advanced Power Management

The following new advanced power management features are supported by the motherboard.

### **Intel Intelligent Power Node Manager (IPNM)**

Available when the Supermicro Power Manager (SPM) is installed, Intel's Intelligent Power Node Manager (IPNM) provides your system with real-time thermal control and power management for maximum energy efficiency. Although IPNM Specification Version 2.0/3.0 is supported by the BMC (Baseboard Management Controller), your system must also have IPNM-compatible Management Engine (ME) firmware installed to use this feature.



**Note:** Support for IPNM 2.0/3.0 support is dependent on the power supply used in the system.

## **Management Engine (ME)**

The Management Engine, which is an ARC controller embedded in the IOH (I/O Hub), provides Server Platform Services (SPS) to your system. The services provided by SPS are different from those provided by the ME on client platforms.

# Chapter 2

## Installation

### 2.1 Static-Sensitive Devices

Electrostatic Discharge (ESD) can damage electronic components. To prevent damage to your motherboard, it is important to handle it very carefully. The following measures are generally sufficient to protect your equipment from ESD.

#### Precautions

- Use a grounded wrist strap designed to prevent static discharge.
- Touch a grounded metal object before removing the motherboard from the antistatic bag.
- Handle the motherboard by its edges only; do not touch its components, peripheral chips, memory modules or gold contacts.
- When handling chips or modules, avoid touching their pins.
- Put the motherboard and peripherals back into their antistatic bags when not in use.
- For grounding purposes, make sure that your chassis provides excellent conductivity between the power supply, the case, the mounting fasteners and the motherboard.
- Use only the correct type of CMOS onboard battery as specified by the manufacturer. Do not install the CMOS battery upside down, which may result in a possible explosion.

#### Unpacking

The motherboard is shipped in antistatic packaging to avoid static damage. When unpacking the motherboard, make sure that the person handling it is static protected.

## 2.2 Motherboard Installation

All motherboards have standard mounting holes to fit different types of chassis. Make sure that the locations of all the mounting holes for both the motherboard and the chassis match. Although a chassis may have both plastic and metal mounting fasteners, metal ones are highly recommended because they ground the motherboard to the chassis. Make sure that the metal standoffs click in or are screwed in tightly.

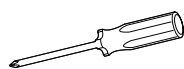

**Philips  
Screwdriver  
(1)**



**Philips Screws  
(9)**



**Standoffs (9)  
Only if Needed**

### Tools Needed

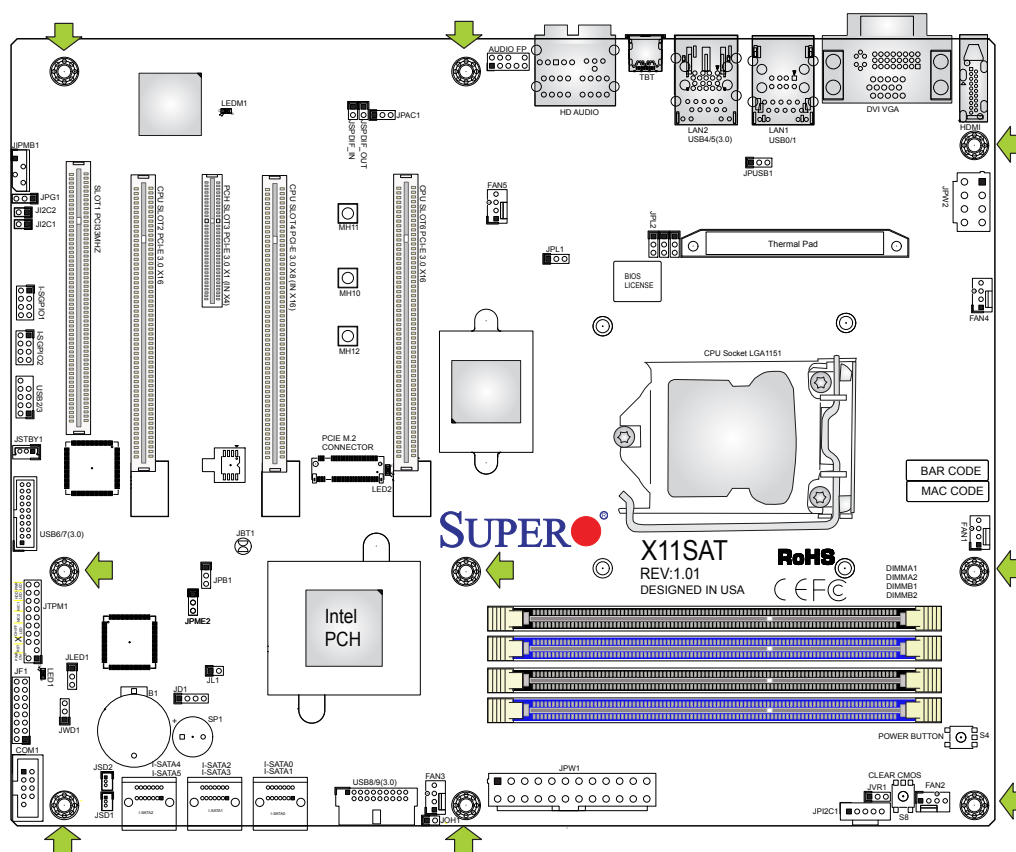

### Location of Mounting Holes



- Notes:** 1) To avoid damaging the motherboard and its components, please do not use a force greater than 8 lb/inch on each mounting screw during motherboard installation. 2) Some components are very close to the mounting holes. Please take precautionary measures to avoid damaging these components when installing the motherboard to the chassis.

## Installing the Motherboard

1. Install the I/O shield into the back of the chassis.

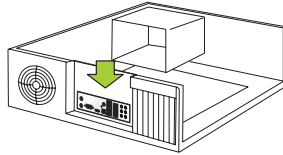

2. Locate the mounting holes on the motherboard. Refer to the previous page for the location.

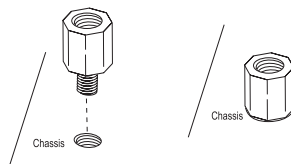

3. Locate the matching mounting holes on the chassis. Align the mounting holes on the motherboard against the mounting holes on the chassis.

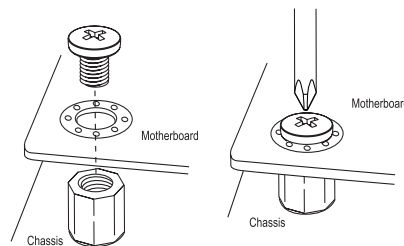

4. Install standoffs in the chassis as needed.
5. Install the motherboard into the chassis carefully to avoid damaging other motherboard components.
6. Using the Phillips screwdriver, insert a Phillips head #6 screw into a mounting hole on the motherboard and its matching mounting hole on the chassis.
7. Repeat Step 6 to insert #6 screws into all mounting holes.
8. Make sure that the motherboard is securely placed in the chassis.

 **Note:** Images displayed are for illustration only. Your chassis or components might look different from those shown in this manual.

## 2.3 Processor and Heatsink Installation

**Warning:** When handling the processor package, avoid placing direct pressure on the label area of the fan.



### Important:

- Always connect the power cord last, and always remove it before adding, removing or changing any hardware components. Make sure that you install the processor into the CPU socket before you install the CPU heatsink.
- If you buy a CPU separately, make sure that you use an Intel-certified multi-directional heatsink only.
- Make sure to install the motherboard into the chassis before you install the CPU heatsink.
- When receiving a motherboard without a processor pre-installed, make sure that the plastic CPU socket cap is in place and none of the socket pins are bent; otherwise, contact your retailer immediately.
- Refer to the Supermicro website for updates on CPU support.

### Installing the LGA1151 Processor

1. Press the load lever to release the load plate, which covers the CPU socket, from its locking position.

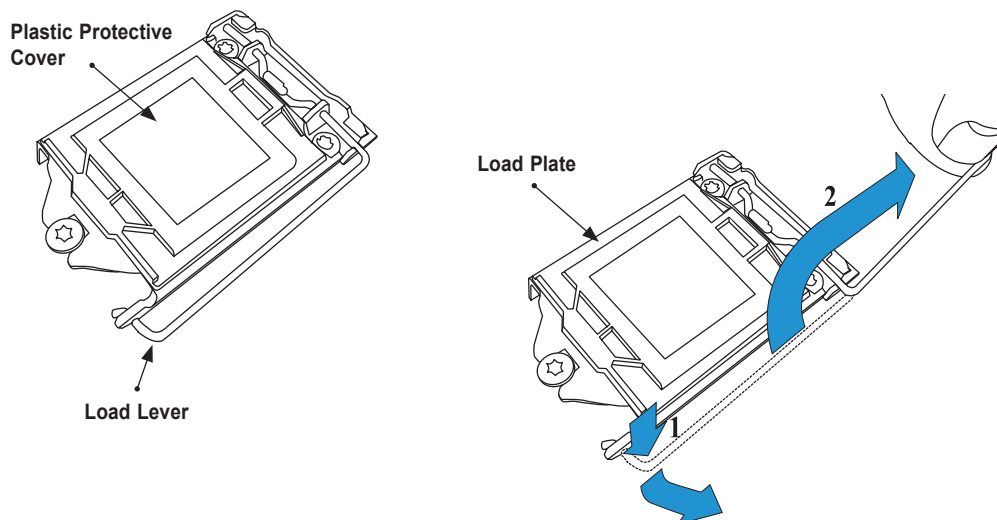

2. Gently lift the load lever to open the load plate. Remove the plastic cap.

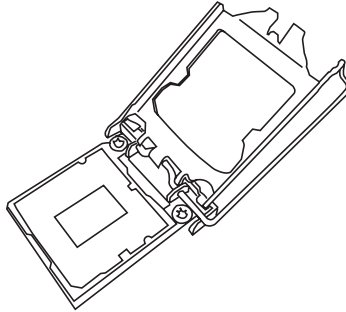

3. Use your thumb and your index finger to hold the CPU at the north center edge and the South center edge of the CPU.

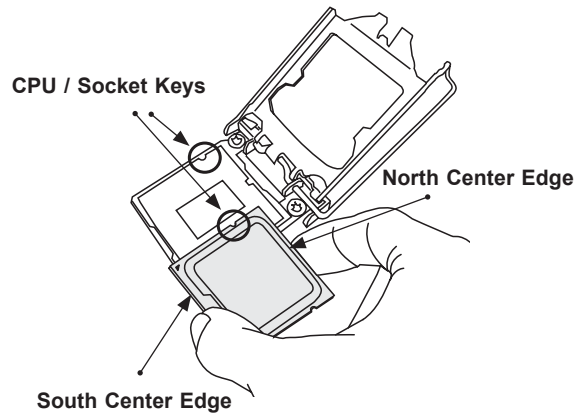

4. Align the CPU key that is the semi-circle cutouts against the socket keys. Once it is aligned, carefully lower the CPU straight down into the socket. (Do not drop the CPU on the socket. Do not move the CPU horizontally or vertically.)

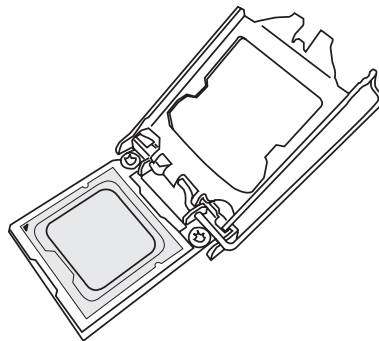

5. Do not rub the CPU against the surface or against any pins of the socket to avoid damaging the CPU or the socket.

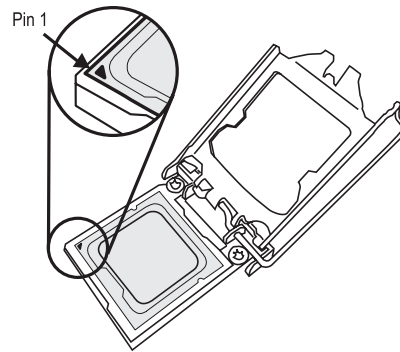

6. With the CPU inside the socket, inspect the four corners of the CPU to make sure that the CPU is properly installed.
7. Use your thumb to gently push the load lever down to the lever lock.

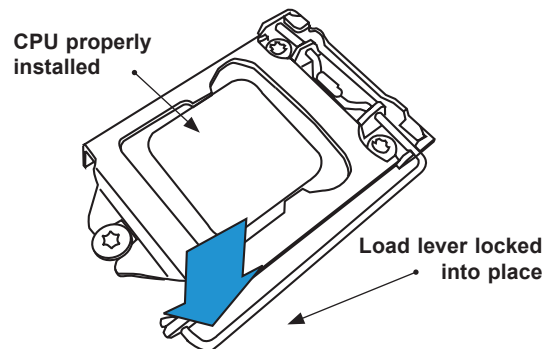

 **Note:** You can only install the CPU inside the socket in one direction. Make sure that it is properly inserted into the CPU socket before closing the load plate. If it doesn't close properly, do not force it as it may damage your CPU. Instead, open the load plate again and double-check that the CPU is aligned properly.

## Installing an Active CPU Heatsink with Fan

1. Locate the CPU fan power connector on the motherboard (FAN1: CPU Fan).
2. Position the heatsink so that the heatsink fan wires are closest to the CPU fan power connector and are not interfered with other components.
3. Inspect the CPU fan wires to make sure that the wires are routed through the bottom of the heatsink.
4. Remove the thin layer of the protective film from the heatsink.



**Important:** CPU overheating may occur if the protective film is not removed from the heatsink.

5. Apply the proper amount of thermal grease on the CPU.



**Note:** If your heatsink came with a thermal pad, please ignore this step.

6. If necessary, rearrange the wires to make sure that the wires are not pinched between the heatsink and the CPU. Also make sure to keep clearance between the fan wires and the fins of the heatsink.

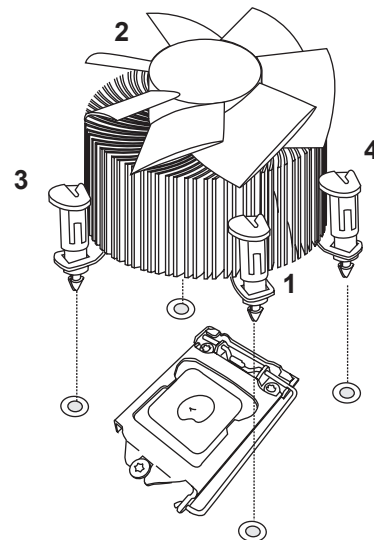
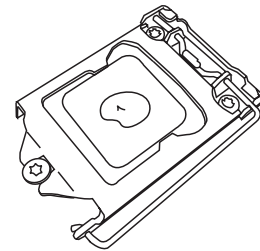
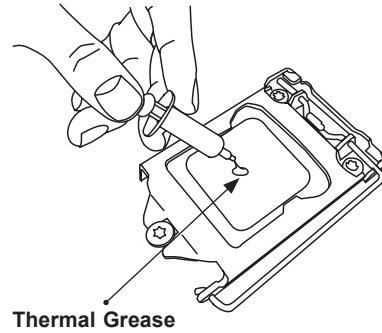

7. Align the four heatsink fasteners with the mounting holes on the motherboard. Gently push the pairs of diagonal fasteners (#1 & #2, and #3 & #4) into the mounting holes until you hear a click. Also, make sure to orient each fastener so that the narrow end of the groove is pointing outward.
8. Repeat step 7 to insert all four heatsink fasteners into the mounting holes.
9. Once all four fasteners are securely inserted into the mounting holes, and the heatsink is properly installed on the motherboard, connect the heatsink fan wires to the CPU fan connector.

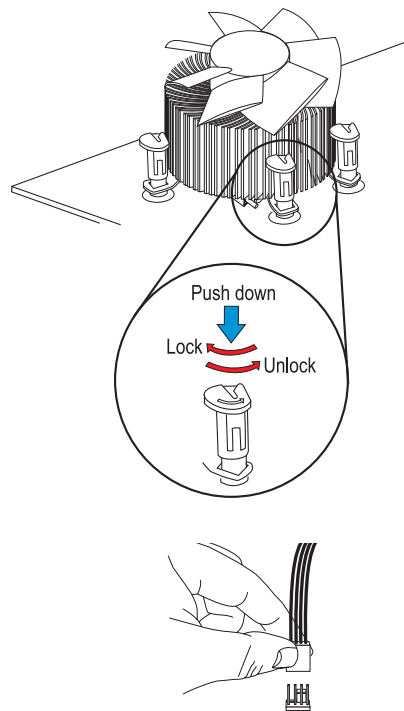

## Removing the Heatsink

 **Note:** We do not recommend that the CPU or the heatsink be removed. However, if you do need to remove the heatsink, please follow the instructions below to remove the heatsink and to prevent damage done to the CPU or other components.

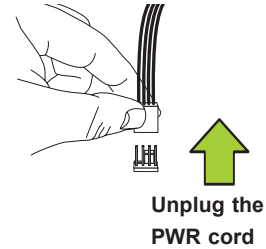

### *Active Heatsink Removal*

1. Unplug the power cord from the power supply.
2. Disconnect the heatsink fan wires from the CPU fan header.
3. Use your finger tips to gently press on the fastener cap and turn it counterclockwise to make a 1/4 (90°) turn, and pull the fastener upward to loosen it.
4. Repeat step 3 to loosen all fasteners from the mounting holes.
5. With all fasteners loosened, remove the heatsink from the CPU.

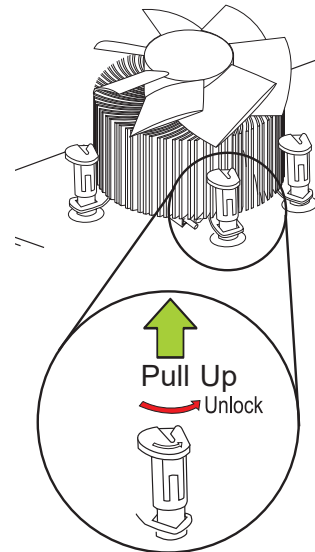

## 2.4 Memory Support and Installation



**Note:** Check the Supermicro website for recommended memory modules.



**Important:** Exercise extreme care when installing or removing DIMM modules to prevent any possible damage.

### Memory Support

The X11SAT/X11SAT-F supports up to 64 GB of DDR4 ECC/Non-ECC UDIMM memory up to 2133MHz in four memory slots. Populating these DIMM modules with a pair of memory modules of the same type and size will result in interleaved memory, which will improve memory performance.

### DIMM Module Population Configuration

For optimal memory performance, follow the table below when populating memory.

Recommended Population (Balanced)				
DIMMA1	DIMMB1	DIMMA2	DIMMB2	Total System Memory
		2GB	2GB	4GB
2GB	2GB	2GB	2GB	8GB
		4GB	4GB	8GB
4GB	4GB	4GB	4GB	16GB
		8GB	8GB	16GB
8GB	8GB	8GB	8GB	32GB
		16GB	16GB	32GB
16GB	16GB	16GB	16GB	64GB

### DIMM Module Population Sequence

When installing memory modules, the DIMM slots must be populated in the following order: DIMMB2, DIMMA2, then DIMMB1, DIMMA1. The blue slots must be populated first.

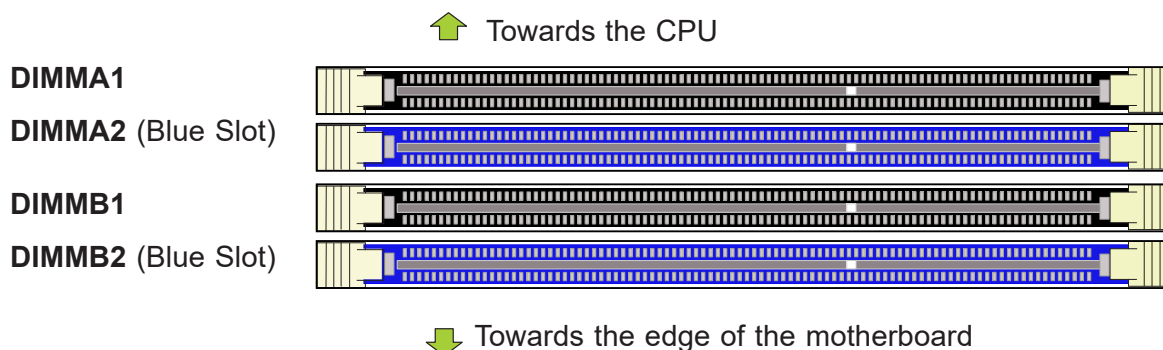

**Note:** Be sure to use memory modules of the same type and speed on the motherboard. Mixing of memory modules of different types and speeds is not allowed.

## DIMM Installation

1. Insert DIMM modules in the following order: DIMMB2, DIMMA2, then DIMMB1, DIMMA1. For the system to work properly, please use memory modules of the same type and speed on the motherboard.
2. Push the release tabs outwards on both ends of the DIMM slot to unlock it.
3. Align the key of the DIMM module with the receptive point on the memory slot.
4. Use two thumbs together to press the notches on both ends of the module straight down into the slot until the module snaps into place.
5. Press the release tabs to the lock positions to secure the DIMM module into the slot.

## DIMM Removal

Reverse the steps above to remove the DIMM modules from the motherboard.

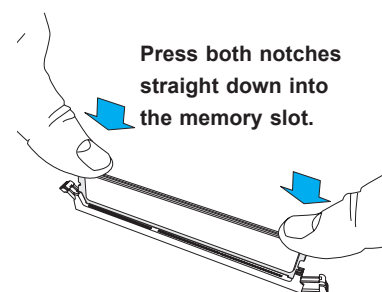
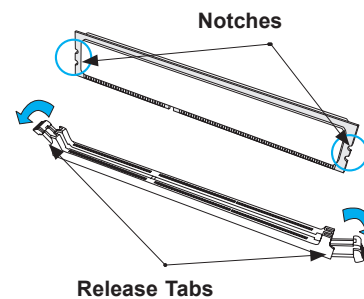
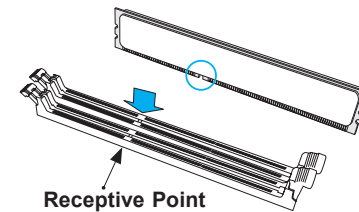
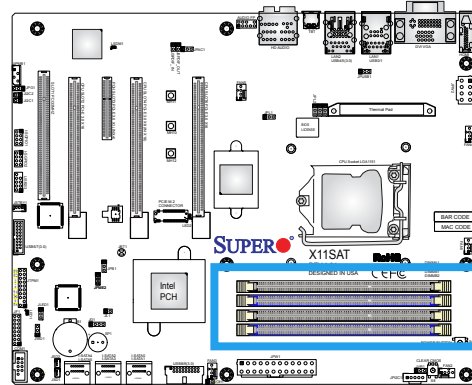

## 2.5 Rear I/O Ports

Refer to Figure 2-1 below for the locations and descriptions of the various I/O ports on the rear of the motherboard.

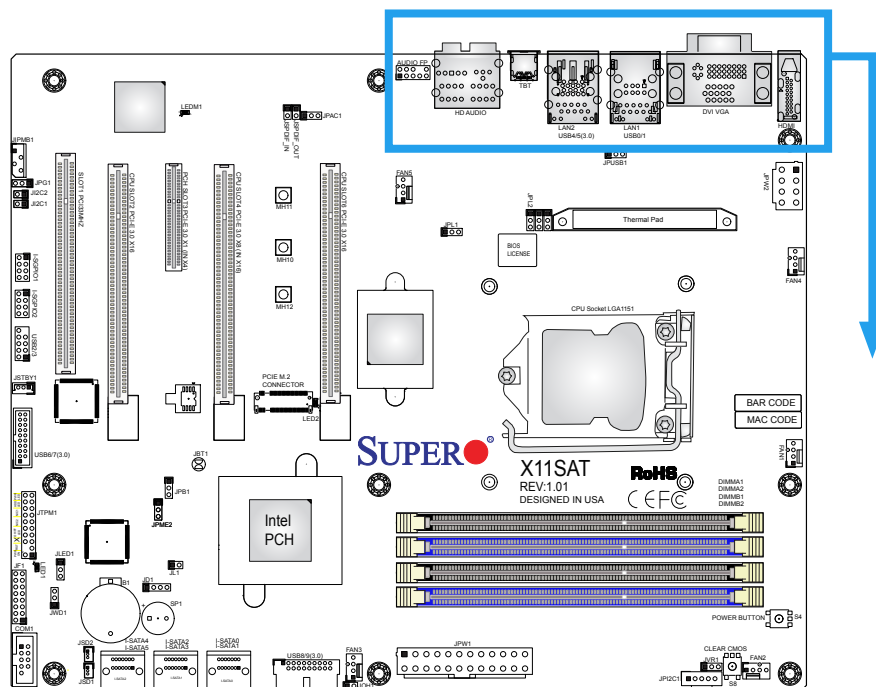
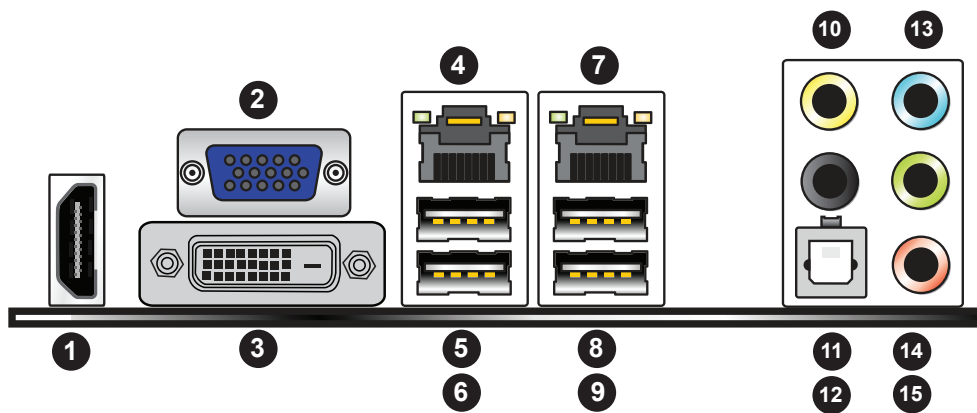

Figure 2-1. I/O Port Locations and Definitions



1. HDMI	6. USB0	11-16: HD Audio Jacks	10. CEN/LFE Out
2. VGA Port (X11SAT-F only)	7. LAN2 (shared with the IPMI port on X11SAT-F)		11. Surround Out
3. DVI Port	8. USB5 (3.0)		12. SPDIF Out
4. LAN1	9. USB4 (3.0)		13. Line In
5. USB1			14. Line Out
			15. Mic In

## LAN Ports

Two LAN ports (LAN1 and LAN2) are located on the I/O back panel. LAN2 is shared with the IPMI port on the X11SAT-F. These ports accept RJ45 type cables. Refer to the table below for the pin definitions.

LAN Port Pin Definitions			
Pin#	Definition	Pin#	Definition
1	TD0+	5	TD2+
2	TD0-	6	TD2-
3	TD1+	7	TD3+
4	TD1-	8	TD3-

## COM Port Header

There is one COM header (COM1) on the motherboard. Refer to the table below for pin definitions.

COM Port Pin Definitions			
Pin#	Definition	Pin#	Definition
1	DCD	6	DSR
2	RXD	7	RTS
3	TXD	8	CTS
4	DTR	9	RI
5	Ground	10	N/A

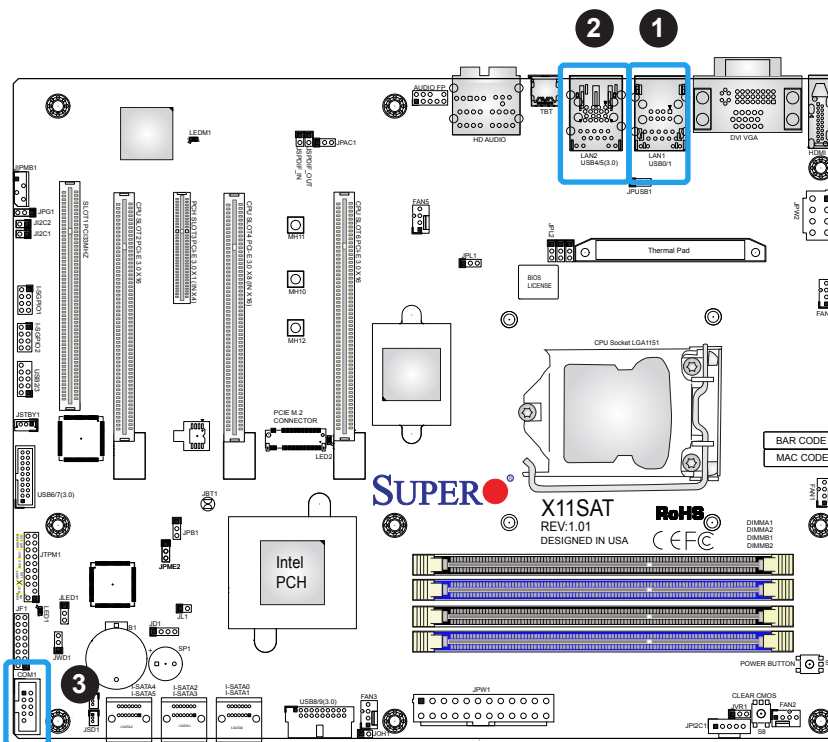

1. LAN1
2. LAN2 (shared with the IPMI port on X11SAT-F)
3. COM1

### Universal Serial Bus (USB) Ports

There is two USB 2.0 ports (USB0/1) and two USB 3.0 ports (USB4/5) on the I/O back panel. The motherboard also has one front access USB 2.0 header (USB2/3) and two front access USB 3.0 headers (USB 6/7 and USB8/9). The onboard headers can provide front side USB access with a cable (not included).

Front Panel USB 3.0 Header Pin Definitions			
Pin#	Definition	Pin#	Definition
1	VBUS	10	Power
2	D-	11	USB 2.0 Differential Pair
3	D+	12	
4	Ground	13	Ground of PWR Return
5	StdA_SSRX-	14	SuperSpeed Receiver
6	StdA_SSRX+	15	Differential Pair
7	GND_DRAIN	16	Ground for Signal Return
8	StdA_SSTX-	17	SuperSpeed Transmitter
9	StdA_SSTX+	18	Differential Pair

Front Panel USB 2.0 Header Pin Definitions			
Pin#	Definition	Pin#	Definition
1	+5V	2	+5V
3	USB_PN2	4	USB_PN3
5	USB_PP2	6	USB_PP3
7	Ground	8	Ground
9	Key	10	Ground

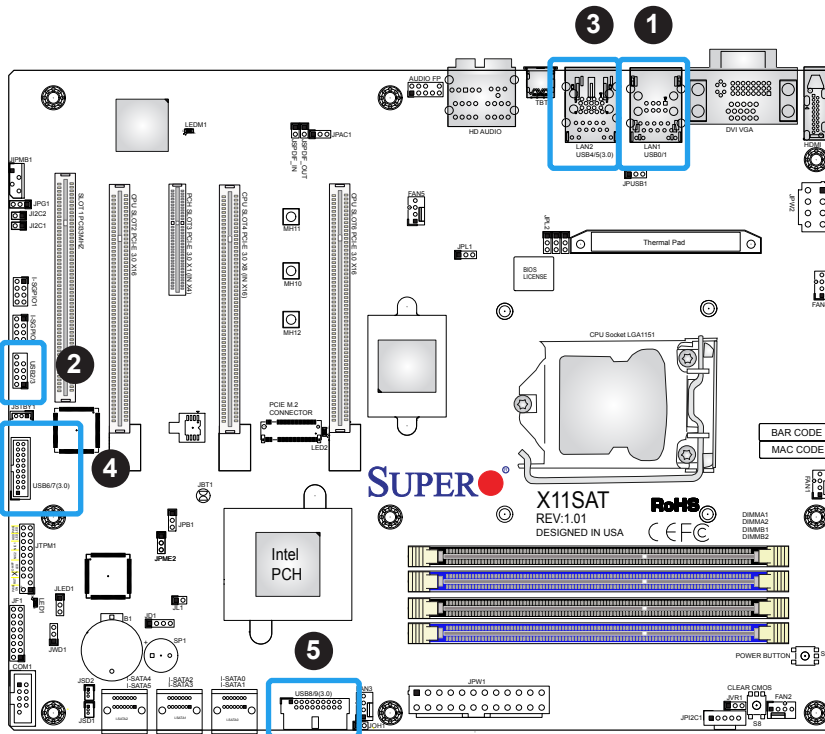

1. USB0/1
2. USB2/3
3. USB4/5 (3.0)
4. USB6/7 (3.0)
5. USB8/9 (3.0)

## HDMI

One HDMI (High-Definition Multimedia Interface) port is located next to the VGA port on the I/O back panel. This connector is used to display both high definition video and digital sound through an HDMI-capable display, using a single HDMI cable (not included).

## VGA Port (On X11SAT-F only)

A VGA port is located next to the USB ports 0/1 on the I/O back panel. Use this port to connect to a compatible VGA display.

## DVI Port

A DVI port is located just under the VGA port on the I/O back panel. Use this port to connect to a compatible DVI (Digital Visual Interface) display.

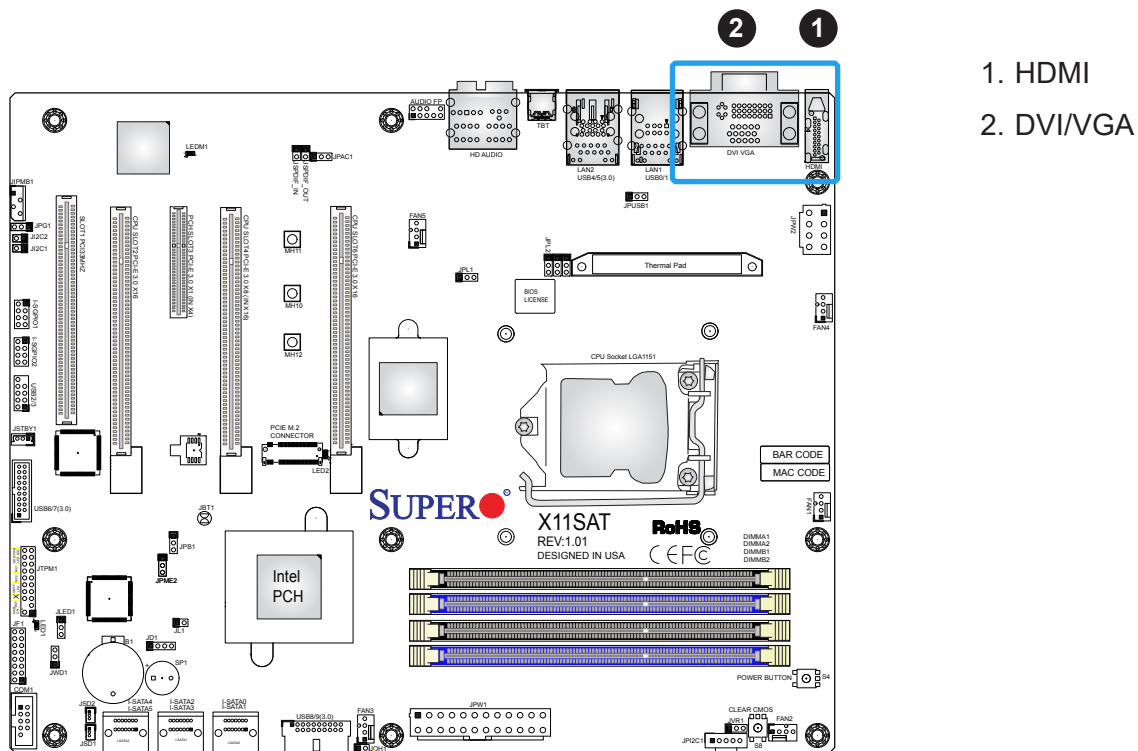

### 5.1 High Definition Audio

This motherboard features a 5.1 Channel High Definition Audio (HDA) codec that provides 8 DAC channels. The HD audio supports multiple-streaming 5.1 sound playback through the front panel stereo output via the subwoofer speakers. Download the software from our website to enable this feature.

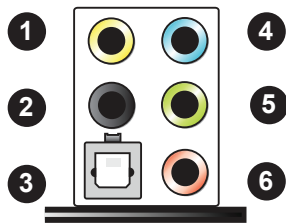

5.1 HD Audio	
Con#	Definition
1	CEN/LFE Out
2	Surround Out
3	SPDIF Out
4	Line In
5	Line Out
6	Mic In

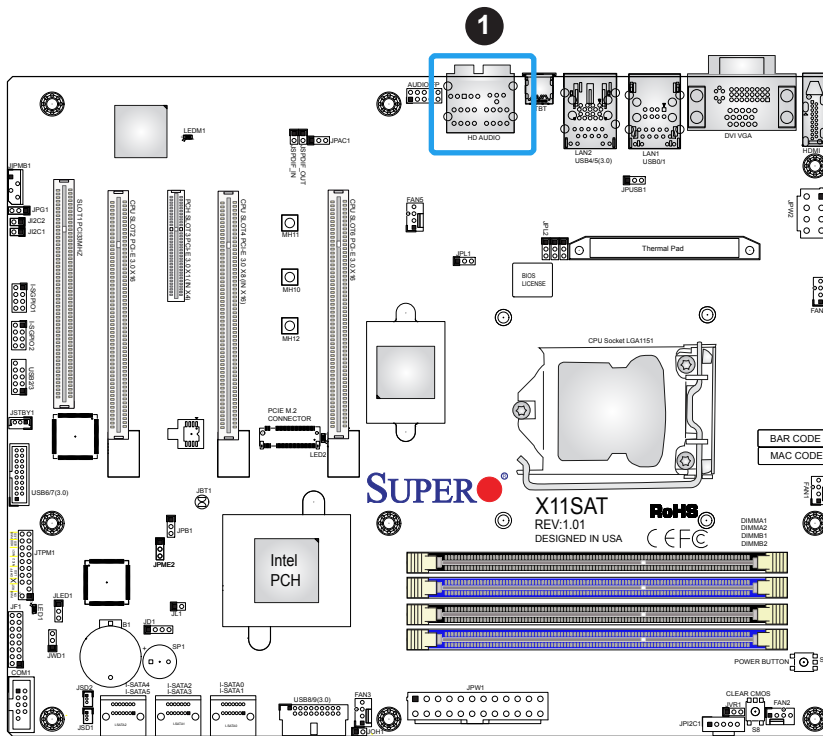

1. HD Audio

## 2.6 Front Control Panel

JF1 contains header pins for various buttons and indicators that are normally located on a control panel at the front of the chassis. These connectors are designed specifically for use with Supermicro chassis. Refer to the figure below for the descriptions of the front control panel buttons and LED indicators.

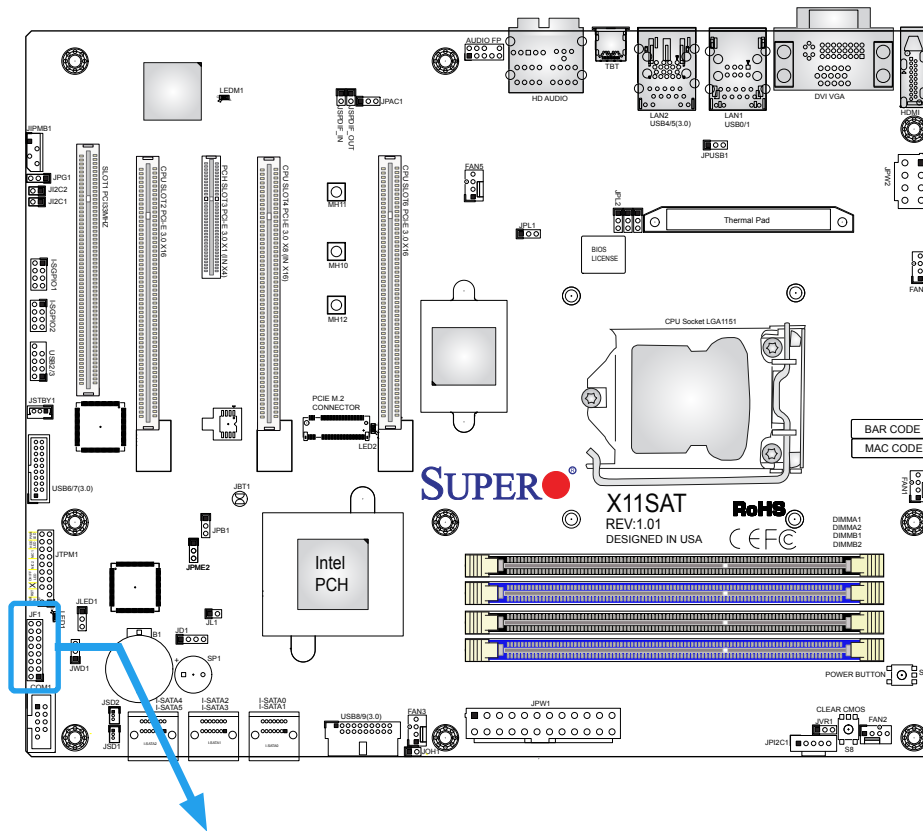

Figure 2-2. JF1 Header Pins

	16	15	
PWR LED	○	○	3.3 V
HDD LED	○	○	3.3V Stby
NIC1 Link LED	○	○	NIC1 Activity LED
NIC2 Link LED	○	○	NIC2 Activity LED
OH/Fan Fail LED	○	○	3.3V Stby
Power Fail LED	○	○	3.3V
Ground	○	○	Reset } Reset Button
Ground	○	○	PWR } Power Button
	2	1	

### Power LED

The Power LED connection is located on pins 15 and 16 of JF1. Refer to the table below for pin definitions.

Power LED Pin Definitions (JF1)	
Pins	Definition
15	+5V
16	Ground

### HDD LED

The HDD LED connection is located on pins 13 and 14 of JF1. Attach a cable here to indicate the status of HDD-related activities, including IDE, SATA activities. Refer to the table below for pin definitions.

HDD LED Pin Definitions (JF1)	
Pins	Definition
13	+5V
14	HD Active

### NIC1/NIC2 (LAN1/LAN2)

The NIC (Network Interface Controller) LED connection for LAN port 1 is located on pins 11 and 12 of JF1, and the LED connection for LAN Port 2 is on Pins 9 and 10. NIC1 LED and NIC2 LED are 2-pin NIC LED headers. Attach NIC LED cables to NIC1 and NIC2 LED indicators to display network activities. Refer to the table below for pin definitions.

LAN1/LAN2 LED Pin Definitions (JF1)	
Pins	Definition
9/11	Vcc
10/12	Ground

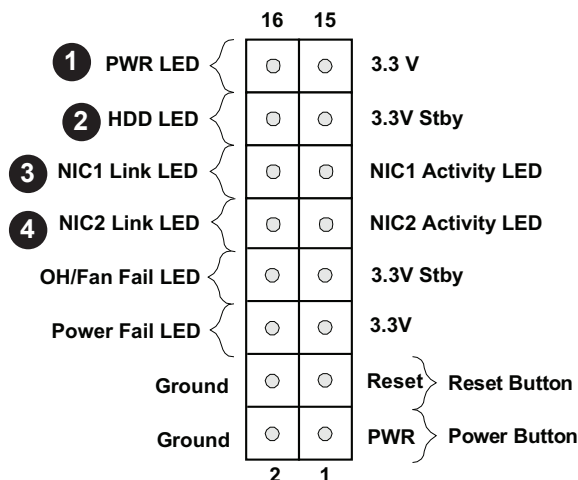

1. PWR LED
2. HDD LED
3. NIC1 LED
4. NIC2 LED

## Reset Button

The Reset Button connection is located on pins 3 and 4 of JF1. Attach it to a hardware reset switch on the computer case to reset the system. Refer to the table below for pin definitions.

Reset Button Pin Definitions (JF1)	
Pins	Definition
3	Reset
4	Ground

## Power Button

The Power Button connection is located on pins 1 and 2 of JF1. Momentarily contacting both pins will power on/off the system. This button can also be configured to function as a suspend button (with a setting in the BIOS - refer to [Chapter 4](#)). To turn off the power in the suspend mode, press the button for at least 4 seconds. Refer to the table below for pin definitions.

Power Button Pin Definitions (JF1)	
Pins	Definition
1	Signal
2	+3V Standby

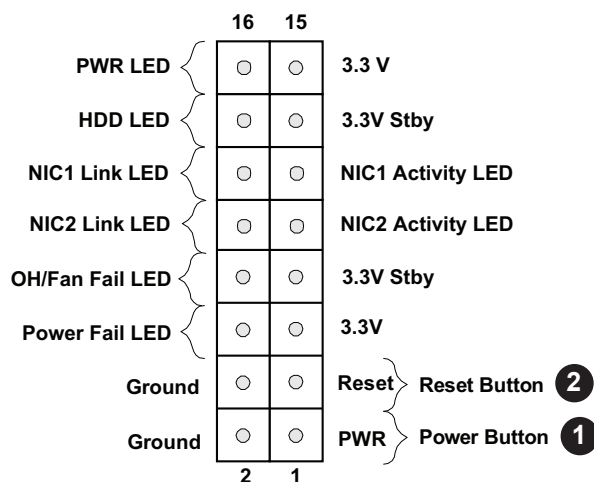

1. Reset Button
2. PWR Button

### Overheat (OH)/Fan Fail

Connect an LED cable to OH/Fan Fail connections on pins 7 and 8 of JF1 to provide warnings for chassis overheat/fan failure. Refer to the table below for pin definitions.

OH/Fan Fail Indicator Status	
State	Definition
Off	Normal
On	Overheat
Flashing	Fan Fail

OH/Fan Fail LED Pin Definitions (JF1)	
Pins	Definition
7	Vcc
8	OH/Fan Fail LED

### Power Fail LED

The Power Fail LED connection is located on pins 5 and 6. Refer to the table below for pin definitions.

Power Fail LED Pin Definitions (JF1)	
Pins	Definition
5	3.3V
6	Power Fail

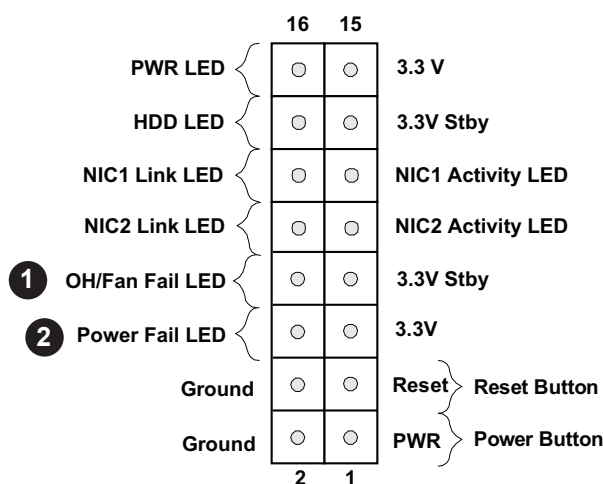

1. Overheat/Fan Fail
2. Power Fail

## 2.7 Connectors

### Power Connections

#### Main ATX Power Supply Connector

The primary power supply connector (JPW1) meets the ATX SSI EPS 24-pin specification. You must also connect the 8-pin (JPW2) processor power connector to your power supply.

Main ATX Power Supply Connector Pin Definitions			
Pin#	Definition	Pin#	Definition
13	+3.3V	1	+3.3V
14	-12V	2	+3.3V
15	COM	3	COM
16	PS_ON	4	+5V
17	COM	5	COM
18	COM	6	+5V
19	COM	7	COM
20	Res (NC)	8	PWR_OK
21	+5V	9	5VSB
22	+5V	10	+12V
23	+5V	11	+12V
24	COM	12	+3.3V

#### Required Connection

#### 1. 24-Pin Main ATX PWR

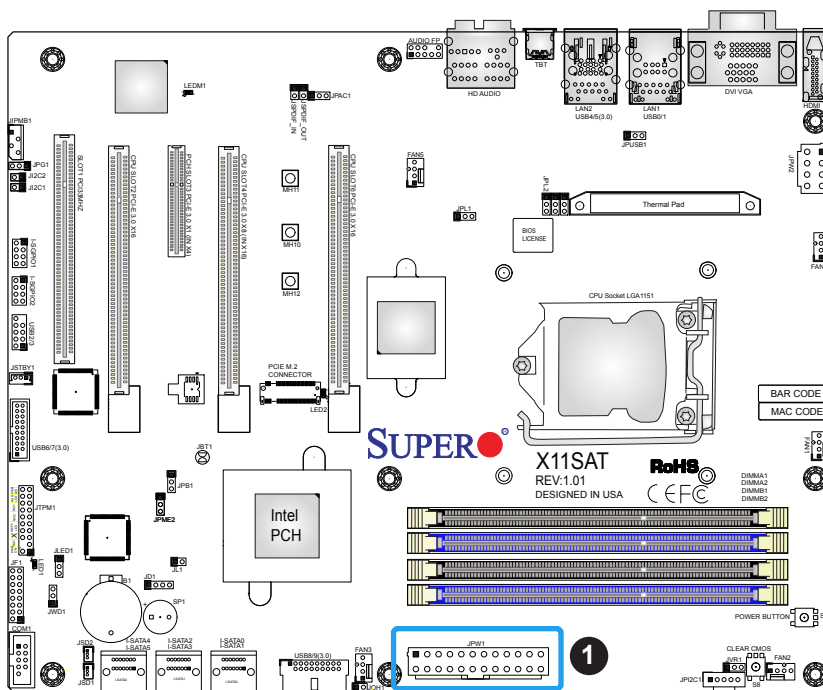

### 8-pin Power Connector

JPW2 must also be connected to the power supply. This connector is used to power the processor.

8-pin Power Connector Pin Definitions	
Pin#	Definition
1 - 4	Ground
5 - 8	+12V

#### Required Connection

### 1. 8-Pin PWR

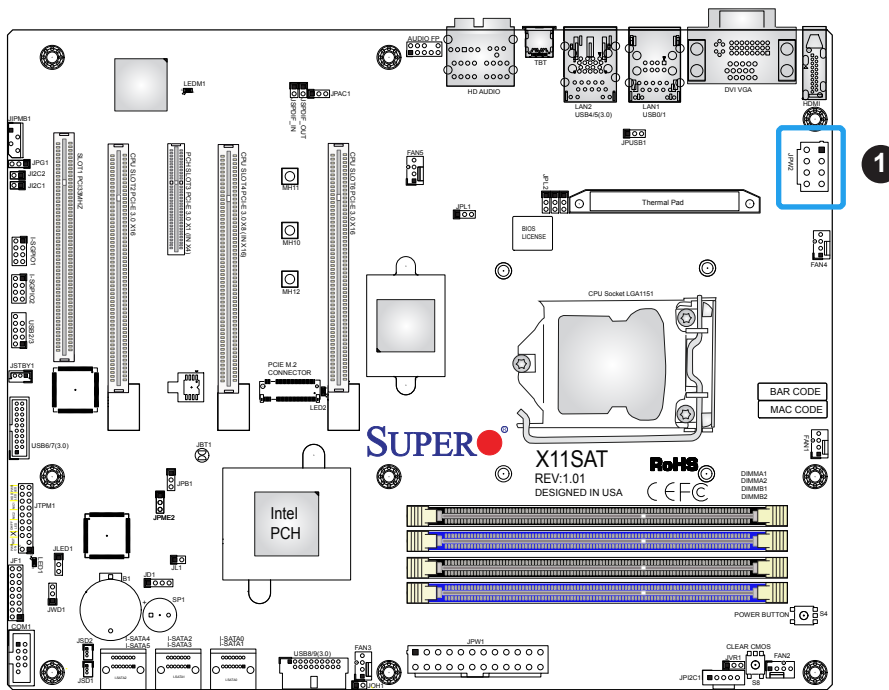

## Headers

### Fan Headers

There are five 4-pin fan headers on the motherboard. Pins 1-3 are backward compatible with traditional 3-pin fans. The onboard fan speeds are controlled by Thermal Management (via Hardware Monitoring) in the BIOS. When using Thermal Management setting, please use all 3-pin fans or all 4-pin fans.

Fan Header Pin Definitions	
Pin#	Definition
1	Ground (Black)
2	+12V (Red)
3	Tachometer
4	PWM Control

### Speaker/Buzzer

On the JD1 header, pins 1-4 are for the speaker and pins 3-4 are for the buzzer. If you wish to use an external speaker, connect its cable to pins 1-4.

Speaker/Buzzer Connector Pin Definitions	
Pin Setting	Definition
Pins 1-4	Speaker
Pins 3-4	Buzzer

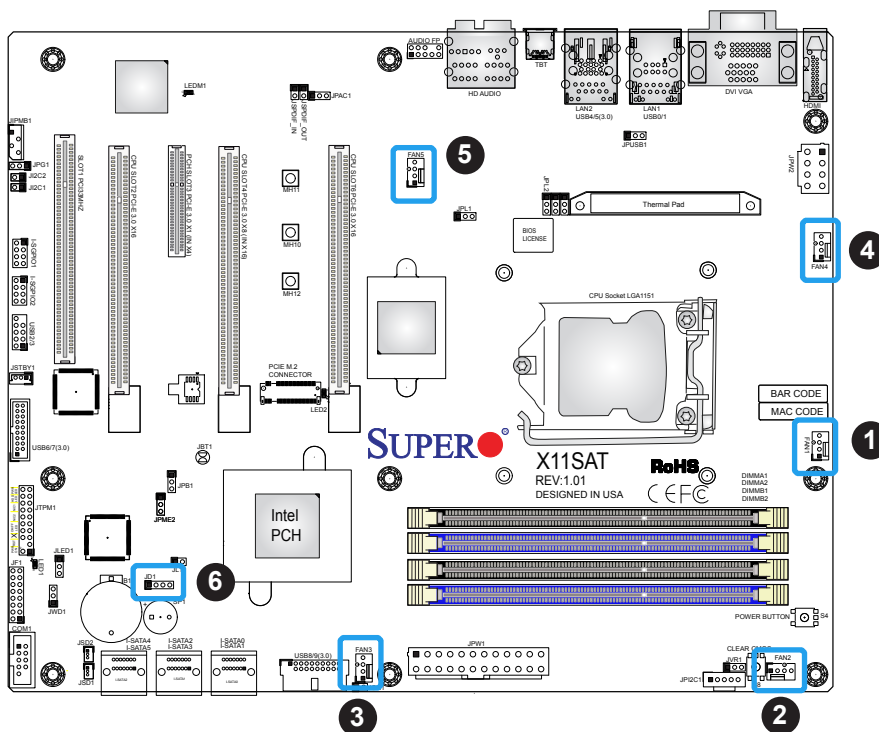

1. FAN1
2. FAN2
3. FAN3
4. FAN4
5. FAN5
6. Speaker/Buzzer

### SPDIF OUT/SPDIF IN Headers

The SPDIF Out (Sony/Phillips Digital Interconnect Format) is used for digital audio output, and the SPDIF In is for digital audio input. You will also need the appropriate cable to use these features.

SPDIF_OUT Header Pin Definitions	
Pin#	Definition
1	S/PDIF_Out
2	Ground

SPDIF_IN Header Pin Definitions	
Pin#	Definition
1	S/PDIF_IN
2	Ground

### Disk-On-Module Power Connector

The Disk-On-Module (DOM) power connectors at JSD1 and JSD2 provide 5V power to a solid state DOM storage device connected to one of the SATA ports. Refer to the table below for pin definitions.

DOM Power Connector Pin Definitions	
Pin#	Definition
1	5V
2	Ground
3	Ground

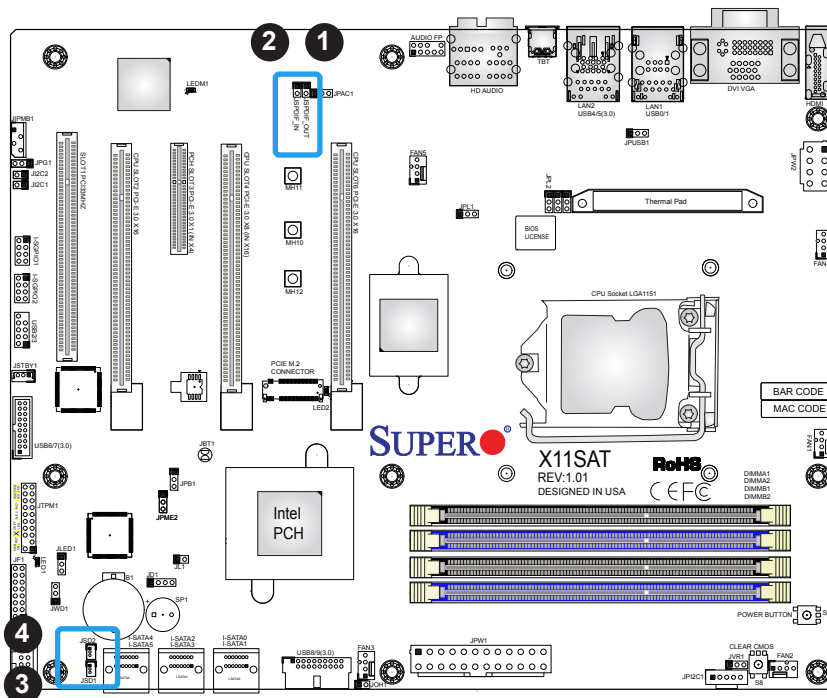

1. SPDIF Out
2. SPDIF In
3. JSD1
4. JSD2

## TPM Header

The JTPM1 header is used to connect a Trusted Platform Module (TPM), which is available from a third-party vendor. A TPM is a security device that supports encryption and authentication in hard drives. It enables the motherboard to deny access if the TPM associated with the hard drive is not installed in the system. Refer to the table below for pin definitions.

 **Note:** Please go to the following link for information on TPM: <http://www.supermicro.com/manuals/other/TPM.pdf>

Trusted Platform Module Header Pin Definitions			
Pin#	Definition	Pin#	Definition
1	LCLK	2	GND
3	LFRAME#	4	No Pin
5	LRESET#	6	+5V (X)
7	LAD3	8	LAD2
9	3.3V	10	LAD1
11	LAD0	12	GND
13	SMB_CLK4 (X)	14	SMB_DAT4 (X)
15	P3V3_STBY	16	SERIRQ
17	GND	18	GND
19	P3V3_STBY	20	LDRQ# (X)

### 1. TPM Header

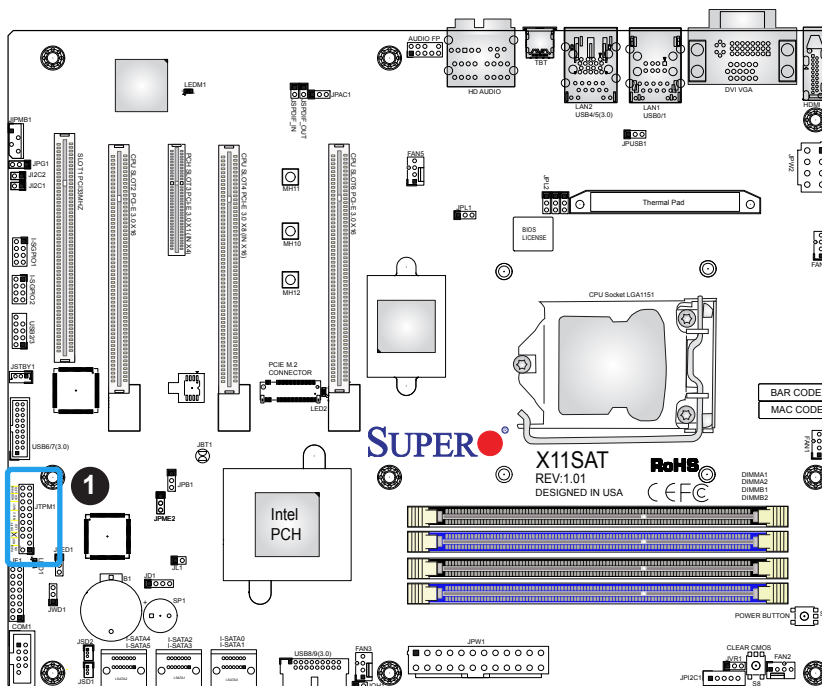

### Front Accessible Audio Header

A 10-pin Audio header allows you to use the onboard sound for audio playback. Connect an audio cable to the audio header to use this feature. Refer to the table below for pin definitions for the header.

Front Accessible Audio Header Pin Definitions	
Pin#	Definition
1	Microphone_Left
2	Audio_Ground
3	Microphone_Right
4	Audio_Detect
5	Line_2_Right
6	Ground
7	Jack_Detect
8	Key
9	Line_2_Left
10	Ground

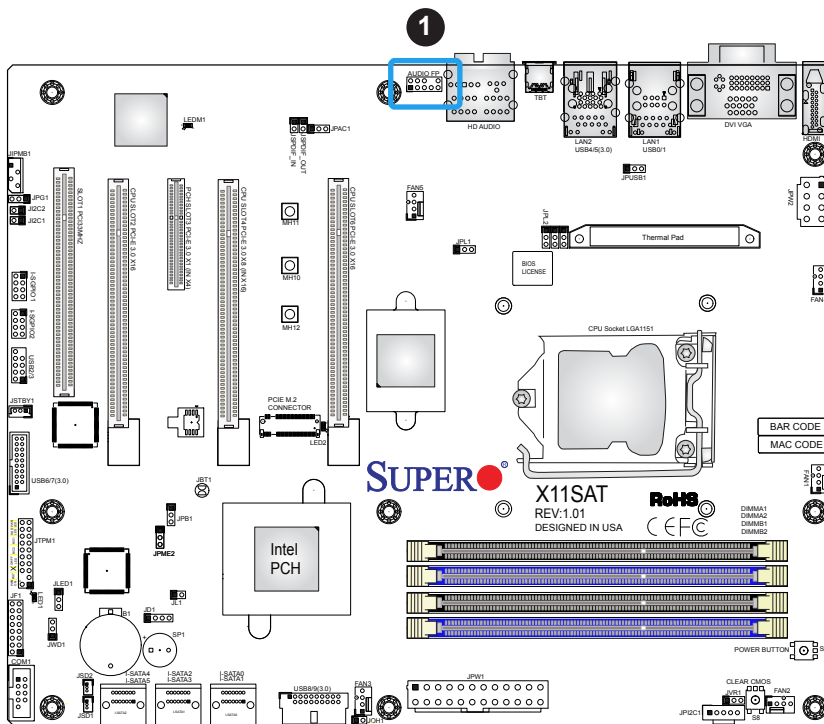

1. Audio FP

## Standby Power

The Standby Power header is located at JSTBY1 on the motherboard. Refer to the table below for pin definitions.

Standby Power Pin Definitions	
Pin#	Definition
1	+5V Standby
2	Ground
3	No Connection

## Internal Speaker/Buzzer

The Internal Speaker/Buzzer at SP1 is used to provide audible indications for various beep codes. Refer to the table below for pin definitions.

Internal Speaker/Buzzer Pin Definitions		
Pin#	Definition	
1	Pos (+)	Beep In
2	Neg (-)	Alarm Speaker

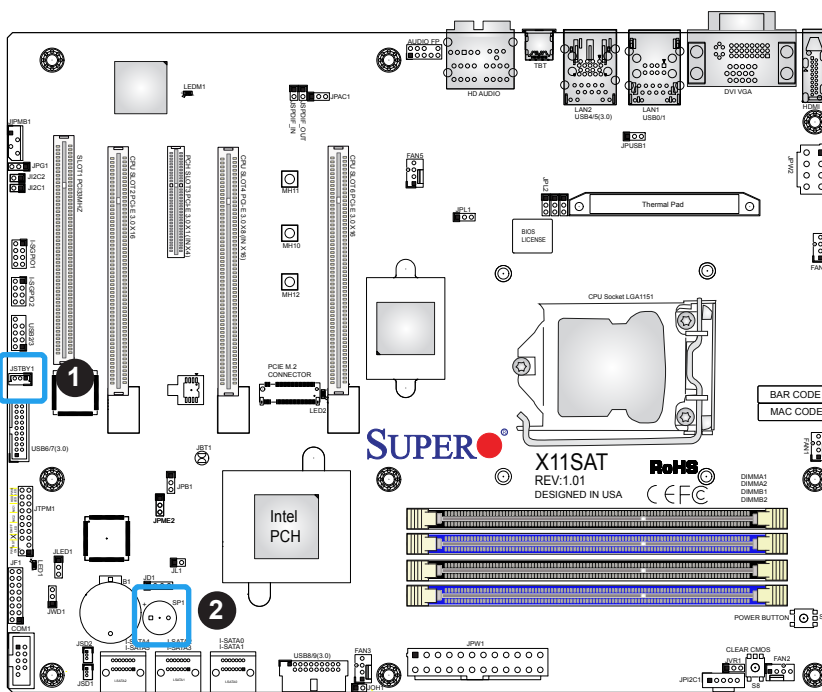

1. Standby Power
2. Internal Speaker/Buzzer

### 4-pin BMC External I<sup>2</sup>C Header

A System Management Bus header for IPMI 2.0 is located at JIPMB1. Connect the appropriate cable here to use the IPMB I<sup>2</sup>C connection on your system. Refer to the table below for pin definitions.

BMC External I <sup>2</sup> C Header Pin Definitions	
Pin#	Definition
1	Data
2	GND
3	Clock
4	NC

### Power SMB I<sup>2</sup>C Header

Power System Management Bus (I<sup>2</sup>C) header at JPI<sup>2</sup>C1 monitors the power supply, fan, and system temperatures. Refer to the table below for pin definitions.

Power SMB I <sup>2</sup> C Header Pin Definitions	
Pin#	Definition
1	Clock
2	Data
3	PMBUS_Alert
4	Ground
5	+3.3V

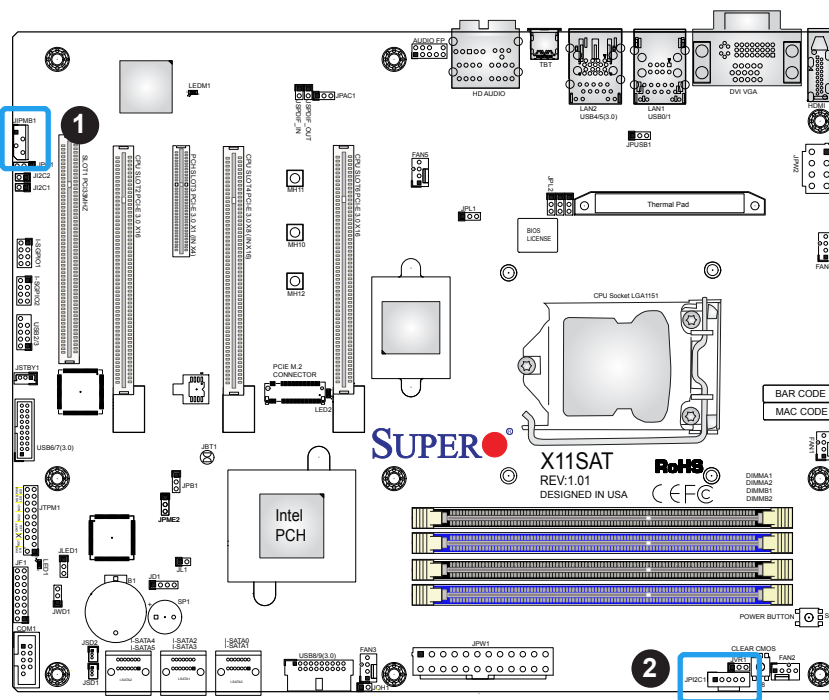

1. JIPMB1
2. JPI<sup>2</sup>C1

## Power Button

In addition to the soft power switch provided in JF1, this motherboard is equipped with a soft power button at S4 on the motherboard. This button works the same way as the soft power switch on JF1.

## Clear CMOS

Use the push-button hardware switch at S8 to clear the CMOS memory back to its default value and reset the system. There is also a similar component on the motherboard (JBT1), but is made of two contact pads that need to be shorted with a metallic object (i.e., screwdriver, etc.).

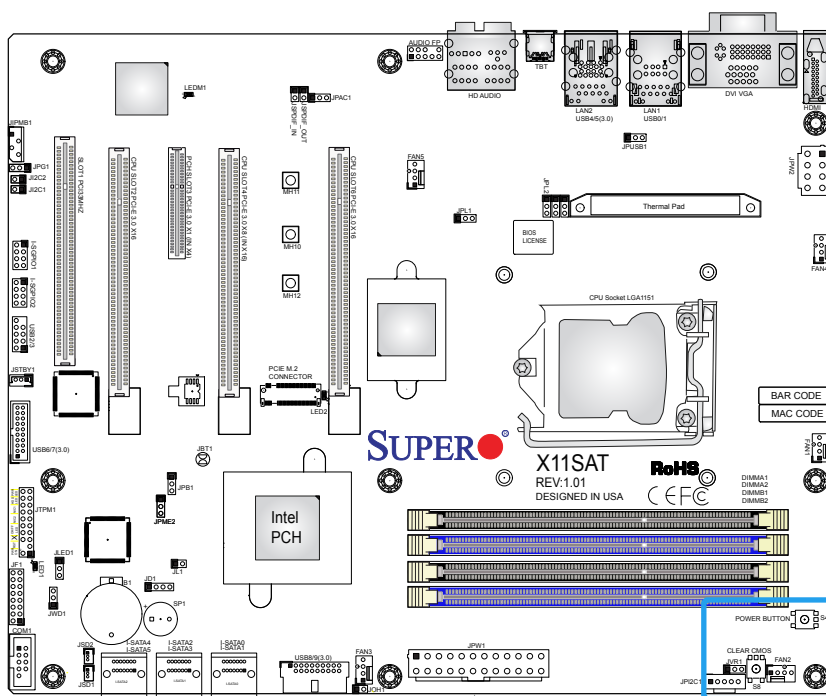

1. Power Button
2. Clear CMOS

### Chassis Intrusion

A Chassis Intrusion header is located at JL1 on the motherboard. Attach the appropriate cable from the chassis to the header to inform you when the chassis is opened.

Chassis Intrusion Pin Definitions	
Pins	Definition
1	Intrusion Input
2	Ground

### Onboard Power LED Header

An onboard Power LED header is located at JLED1. This Power LED header is connected to Front Control Panel located at JF1 to indicate the status of system power. Refer to the table below for pin definitions.

Onboard Power LED Header Pin Definitions	
Pins	Definition
1	VCC
2	No Connection
3	Connection to PWR LED on JF1

1. Chassis Intrusion
2. Onboard Power LED

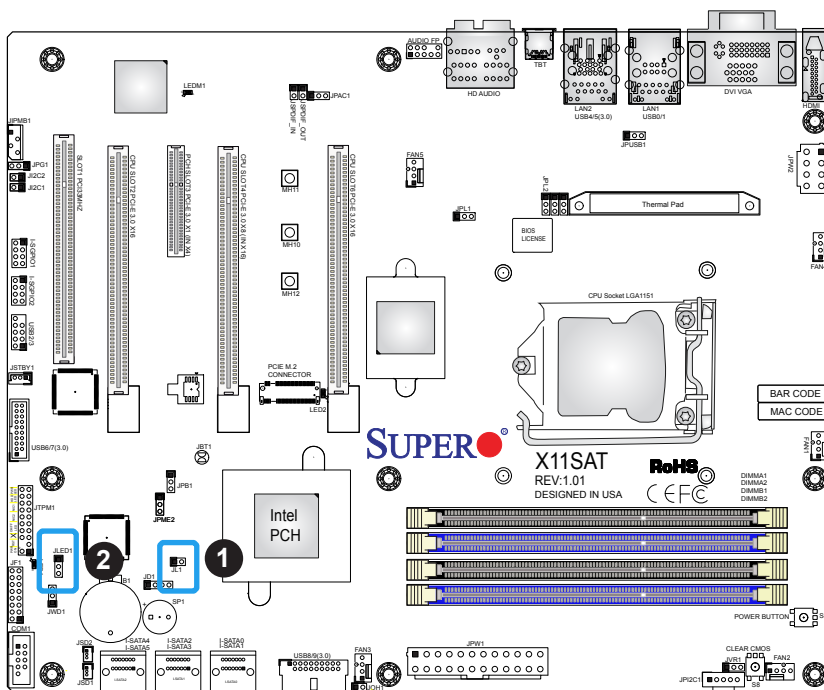

## SATA and SAS Ports

The X11SAT/X11SAT-F has six SATA 3.0 ports that are supported by the Intel PCH C236 chipset.

SATA 3.0 Port Pin Definitions	
Pin#	Signal
1	Ground
2	SATA_TXP
3	SATA_TXN
4	Ground
5	SATA_RXN
6	SATA_RXP
7	Ground

## M.2 Socket

M.2 is formerly known as Next Generation Form Factor (NGFF). The M.2 socket is designed for internal mounting devices. The X11SAT/X11SAT-F motherboard deploys an M key only dedicated for SSD devices with the ultimate performance capability.

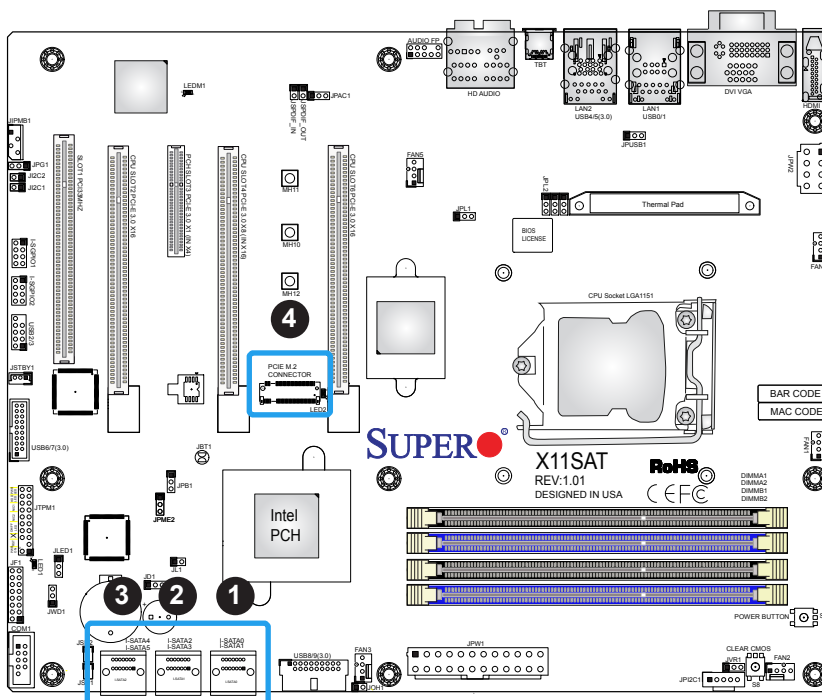

1. I-SATA0/1
2. I-SATA2/3
3. I-SATA4/5
4. M.2 Socket

### SGPIO Header

The I-SGPIO1 and I-SGPIO2 (Serial General Purpose Input/Output) headers are used to communicate with the enclosure management chip on the backplane via the PCH SATA controller.

SGPIO Header Pin Definitions			
Pin#	Definition	Pin#	Definition
1	NC	2	NC
3	Ground	4	DATA Out
5	Load	6	Ground
7	Clock	8	NC

NC = No Connection

### Overheat/Fan Fail LED Header

Connect an LED indicator to JOH1 to display warnings of chassis overheating and fan failure. Refer to the table below for the LED status.

Overheat LED Pin Definitions	
Pins	Definition
1	3.3V
2	OH Active

OH Status Red LED	
State	Definition
Off	Normal
Solid	Overheat

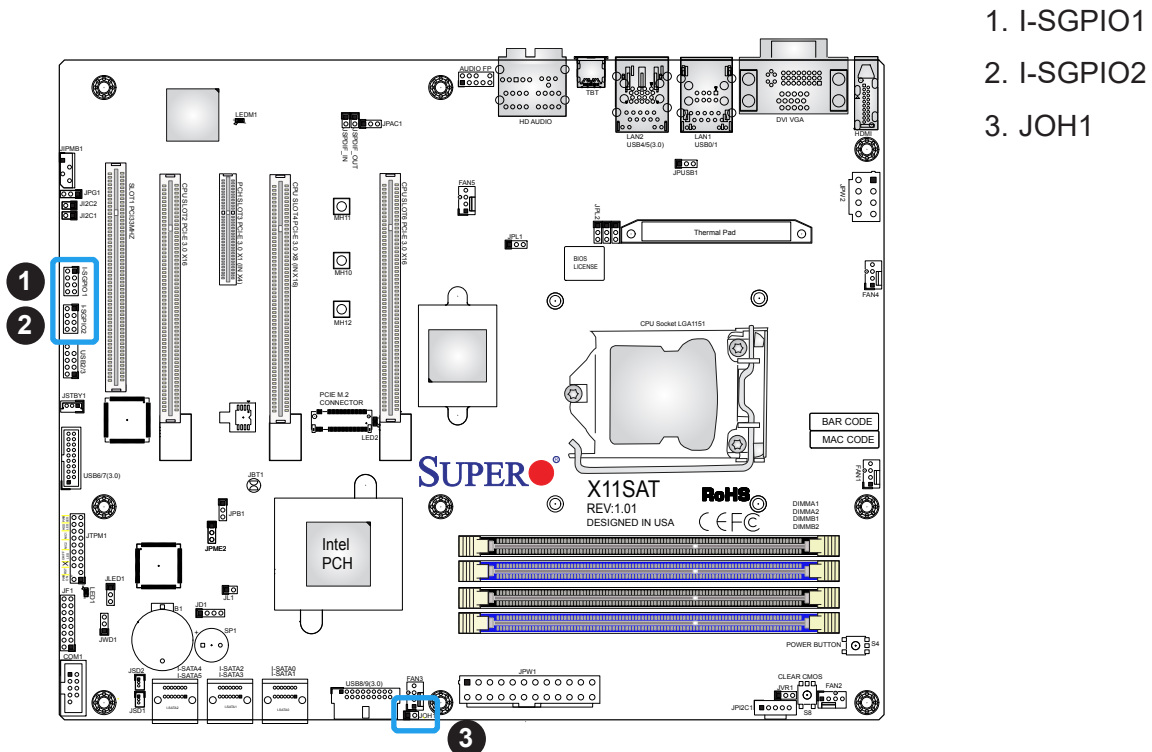

- 1. I-SGPIO1
- 2. I-SGPIO2
- 3. JOH1

## 2.8 Jumper Settings

### How Jumpers Work

To modify the operation of the motherboard, jumpers can be used to choose between optional settings. Jumpers create shorts between two pins to change the function of the connector. Pin 1 is identified with a square solder pad on the printed circuit board. Refer to the diagram below for an example of jumping pins 1 and 2. Refer to the [motherboard layout](#) page for jumper locations.

 **Note:** On two-pin jumpers, "Closed" means the jumper is on and "Open" means the jumper is off the pins.

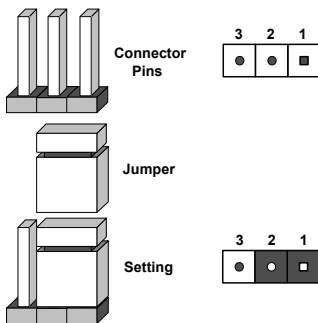

### CMOS Clear

JBT1 is used to clear CMOS, which will also clear any passwords. Instead of pins, this jumper consists of contact pads to prevent accidentally clearing the contents of CMOS.

#### To Clear CMOS

1. First power down the system and unplug the power cord(s).
2. Remove the cover of the chassis to access the motherboard.
3. Remove the onboard battery from the motherboard.
4. Short the CMOS pads with a metal object such as a small screwdriver for at least four seconds.
5. Remove the screwdriver (or shorting device).
6. Replace the cover, reconnect the power cord(s), and power on the system.

 **Note:** Clearing CMOS will also clear all passwords.

Do not use the PW\_ON connector to clear CMOS.



### LAN Port Enable/Disable

Change the setting of jumper JPL1 and JPL2 to enable or disable the LAN1 and LAN2 LAN ports, respectively. The default setting is Enabled.

LAN Port Enable/Disable Jumper Settings	
Jumper Setting	Definition
Pins 1-2	Enabled
Pins 2-3	Disabled

### Front Panel Audio Enable

JPAC1 allows you to enable or disable front panel audio support. The default position is on pins 1 and 2 to enable onboard audio connections. Refer to the table on the right for jumper settings.

Front Panel Audio Enable/Disable Jumper Settings	
Jumper Setting	Definition
Pins 1-2	Enabled
Pins 2-3	Disabled

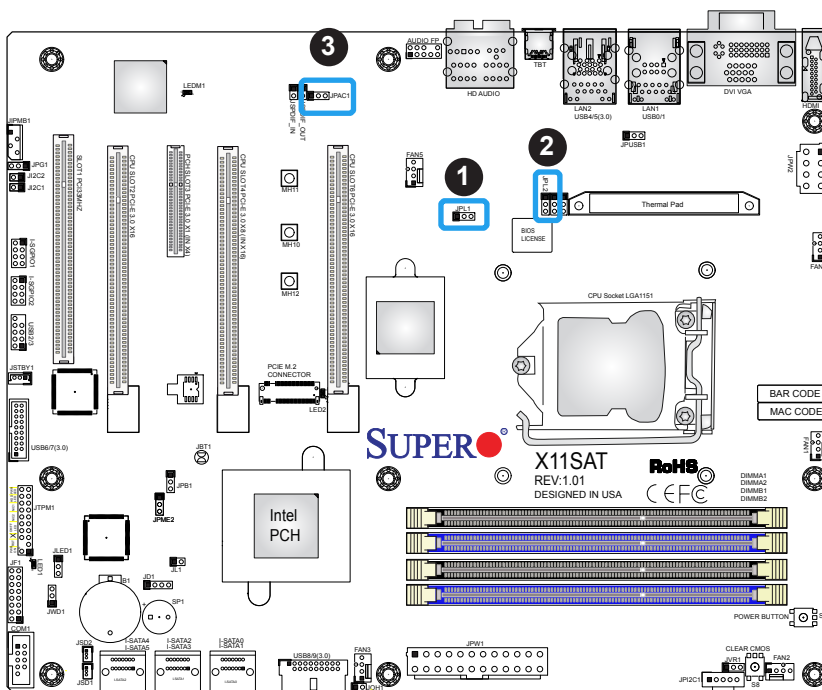

1. LAN1 Enable/Disable
2. LAN2 Enable/Disable
3. Audio Enable

## SMBus to PCI Slots

Jumpers JI<sup>2</sup>C1 and JI<sup>2</sup>C2 allow you to connect the System Management Bus (I<sup>2</sup>C) to the PCIe/PCI slots. The default setting is Open (Disabled). Both jumpers must be set to the same setting (JI<sup>2</sup>C1 controls the clock and JI<sup>2</sup>C2 controls the data). The default setting is Enabled.

SMBus to PCI Slots Jumper Settings		
JI <sup>2</sup> C1 Setting	JI <sup>2</sup> C2 Setting	Definition
JI <sup>2</sup> C1: Pins 1-2	JI <sup>2</sup> C2: Pins 1-2	Enabled
JI <sup>2</sup> C1: Pins 2-3	JI <sup>2</sup> C2: Pins 2-3	Disabled

## Manufacturing Mode Select

Close JPME2 to bypass SPI flash security and force the system to use the Manufacturing Mode, which will allow you to flash the system firmware from a host server to modify system settings. Refer to the table below for jumper settings.

Manufacturing Mode Jumper Settings	
Jumper Setting	Definition
Pins 1-2	Normal (Default)
Pins 2-3	Manufacturing Mode

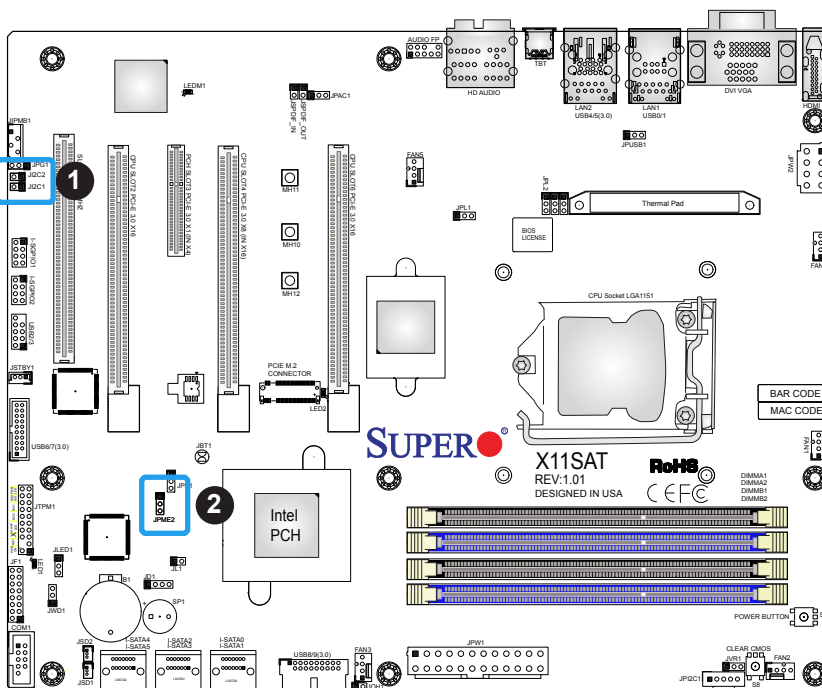

1. SMBus to PCI Slots
2. Manufacturing Mode

### VGA Enable/Disable (X11SAT-F only)

Close pins 2 and 3 of jumper JPG1 to disable the onboard graphics device. Refer to the table below for jumper settings.

VGA Enable/Disable Jumper Settings	
Jumper Setting	Definition
Pins 1-2	Normal (Default)
Pins 2-3	VGA Disable

### USB Wake-Up

Use jumper JUSB1 to activate the "wake-up" function of the USB ports by pressing a key on an attached USB keyboard or clicking the USB mouse. This jumper is used together with a USB Wake-Up feature in the BIOS. Enable this jumper and the USB support in the BIOS to wake up your system via USB devices.

 **Note:** Use JUSB1 for USB ports 0/1 on the back panel.

USB Wake-Up Jumper Settings	
Jumper Setting	Definition
Pins 1-2	Enabled
Pins 2-3	Disabled (Default)

1. VGA Enable
2. USB Wake-Up

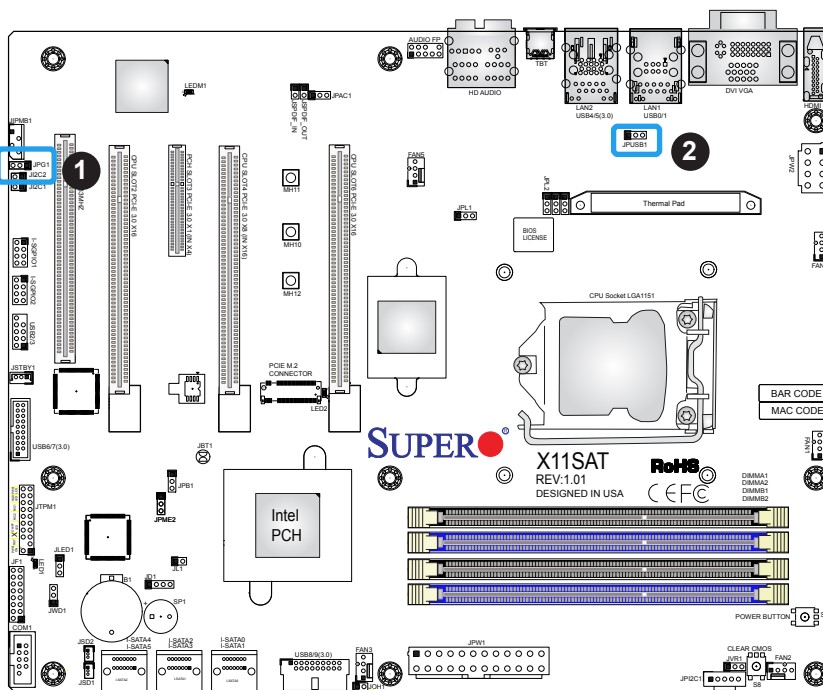

## Watch Dog

JWD1 controls the Watch Dog function. Watch Dog is a monitor that can reboot the system when a software application hangs. Jumping pins 1-2 will cause Watch Dog to reset the system if an application hangs. Jumping pins 2-3 will generate a non-maskable interrupt signal for the application that hangs. Watch Dog must also be enabled in BIOS. The default setting is Reset.

 **Note:** When Watch Dog is enabled, users need to write their own application software to disable it.

Watch Dog Jumper Settings	
Jumper Setting	Definition
Pins 1-2	Reset
Pins 2-3	NMI
Open	Disabled

## BMC Enabled

JPB1 allows you to enable or disable the BMC (Baseboard Management Control) chip and the onboard IPMI connection for debugging purpose only. This jumper is used together with the IPMI settings in the BIOS. After the BMC is disabled, IPMI health monitoring and remote management functions are no longer supported.

 **Note:** Please always keep BMC enabled to make sure the platform operates reliably with the health monitor.

BMC Enable Jumper Settings	
Jumper Setting	Definition
Pins 1-2	Enabled (Default)
Pins 2-3	Disabled

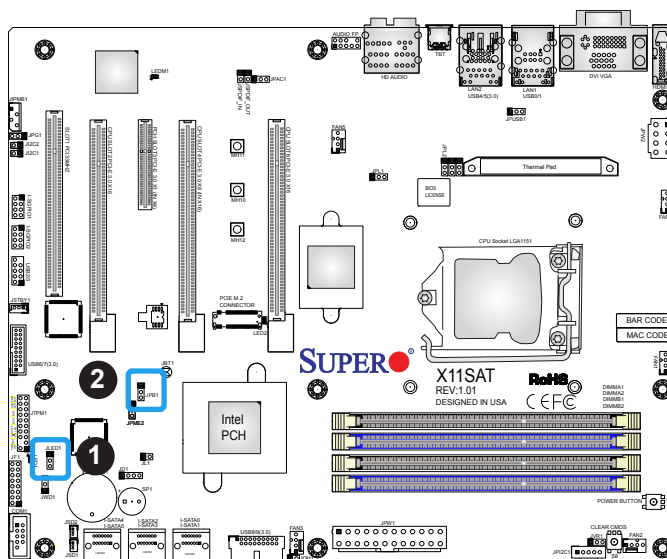

1. Watch Dog
2. BMC Enabled

## 2.9 LED Indicators

### LAN1/2 LEDs

The Ethernet ports have two LEDs. On each port, one LED indicates activity when flashing while the other LED may be green, amber or off to indicate the speed of the connection.

LAN1/2 LED (Connection Speed Indicator)	
LED Color	Definition
Off	10 Mb/s
Green	100 Mb/s
Amber	1 Gb/s

### BMC Heartbeat LED

LEDM1 is the BMC heartbeat LED. When the LED is blining green, BMC is functioning normally. Refer to the table below for the LED status.

BMC Heartbeat LED Indicator	
LED Color	Definition
Green:	BMC Normal
Blinking	

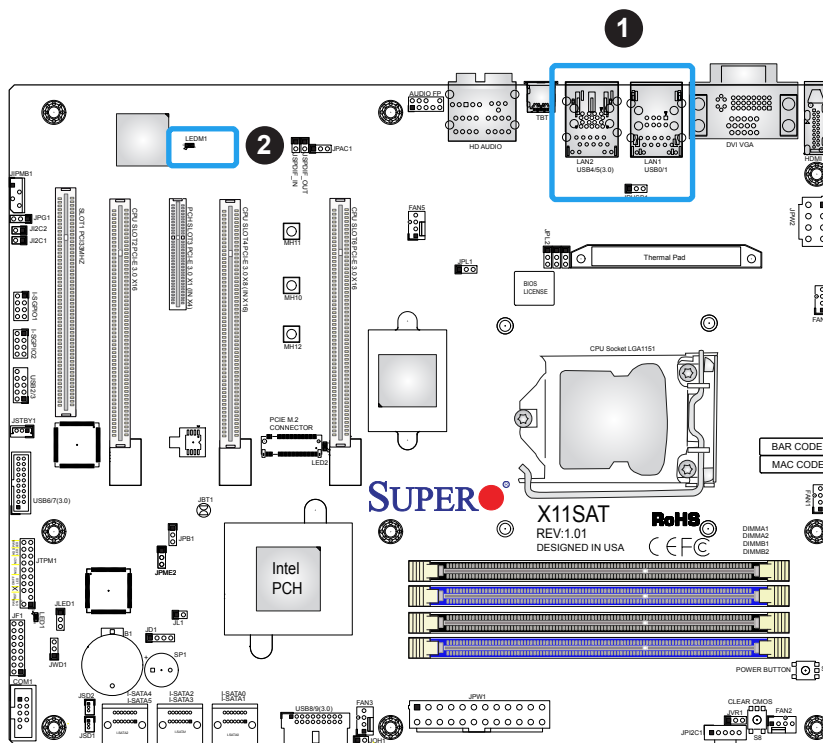

1. LAN 1/2 LEDs
2. BMC Heartbeat LED

## Onboard Power LED

LED1 is an Onboard Power LED indicator. When this LED is lit, it means power is present on the motherboard. In suspend mode, this LED will blink on and off. Be sure to turn off the system and unplug the power cord(s) before removing or installing components.

Onboard Power LED Indicator	
LED Color	Definition
Off	System Off (power cable not connected)
Green	System On

## M.2 LED

The M.2 LED is located at LED2. When this LED is on, a device is connected to the M.2 slot. Refer to the table below for the LED status.

M.2 LED Indicator	
LED Color	Definition
Off	No M.2 device connected
On	M.2 device connected

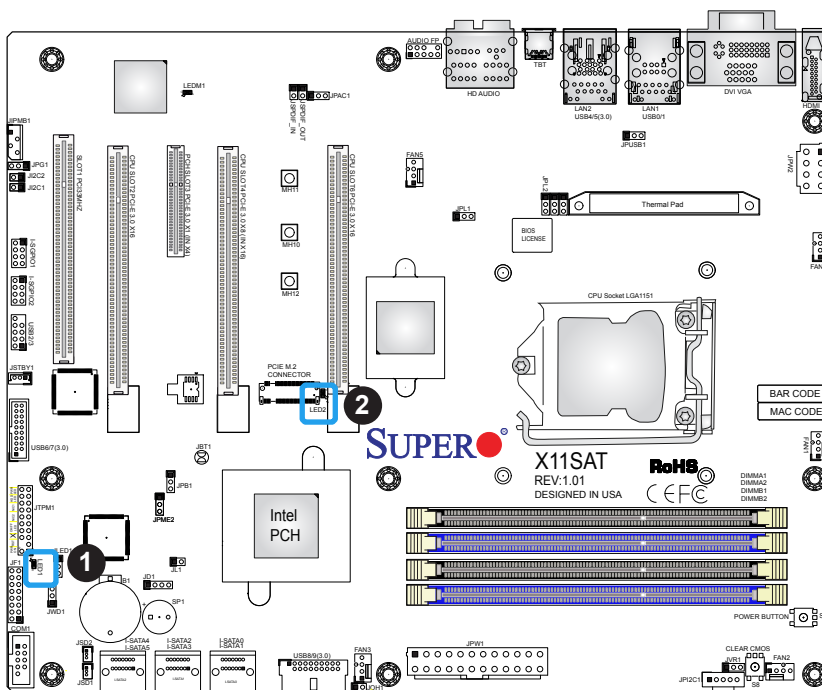

1. Onboard Power LED
2. M.2 LED

# Chapter 3

## Troubleshooting

### 3.1 Troubleshooting Procedures

Use the following procedures to troubleshoot your system. If you have followed all of the procedures below and still need assistance, refer to the 'Technical Support Procedures' and/or 'Returning Merchandise for Service' section(s) in this chapter. Always disconnect the AC power cord before adding, changing or installing any non hot-swap hardware components.

#### Before Power On

1. Check that the power LED on the motherboard is on.
2. Make sure that the power connector is connected to your power supply.
3. Make sure that no short circuits exist between the motherboard and chassis.
4. Disconnect all cables from the motherboard, including those for the keyboard and mouse.
5. Remove all add-on cards.
6. Install a CPU, a heatsink\*, and connect the internal speaker and the power LED to the motherboard. Check all jumper settings as well. (Make sure that the heatsink is fully seated.)
7. Use the correct type of onboard CMOS battery (CR2032) as recommended by the manufacturer. To avoid possible explosion, do not install the CMOS battery upside down.

#### No Power

1. Make sure that no short circuits exist between the motherboard and the chassis.
2. Verify that all jumpers are set to their default positions.
3. Check that the 115V/230V switch on the power supply is properly set.
4. Turn the power switch on and off to test the system.
5. The battery on your motherboard may be old. Check to verify that it still supplies ~3VDC. If it does not, replace it with a new one.

## No Video

1. If the power is on but you have no video, remove all the add-on cards and cables.
2. Use the speaker to determine if any beep codes exist. Refer to [Appendix A](#) for details on beep codes.



**Note:** If you are a system integrator, VAR or OEM, a POST diagnostics card is recommended. For I/O port 80h codes, refer to [Appendix B](#).

## System Boot Failure

If the system does not display POST (Power-On-Self-Test) or does not respond after the power is turned on, check the following:

1. Check for any error beep from the motherboard speaker.
  - If there is no error beep, try to turn on the system without DIMM modules installed. If there is still no error beep, replace the motherboard.
  - If there are error beeps, clear the CMOS settings by unplugging the power cord and contacting both pads on the CMOS Clear Jumper (JBT1). Refer to [Chapter 2](#).
2. Remove all components from the motherboard, especially the DIMM modules. Make sure that system power is on and that memory error beeps are activated.
3. Turn on the system with only one DIMM module installed. If the system boots, check for bad DIMM modules or slots by following the Memory Errors Troubleshooting procedure in this Chapter.

## Memory Errors

1. Make sure that the DIMM modules are properly and fully installed.
2. Confirm that you are using the correct memory. Also, it is recommended that you use the same memory type and speed for all DIMMs in the system. See [Section 2.4](#) for memory details.
3. Check for bad DIMM modules or slots by swapping modules between slots and noting the results.
4. Check the power supply voltage 115V/230V switch.

## Losing the System's Setup Configuration

1. Make sure that you are using a high quality power supply. A poor quality power supply may cause the system to lose the CMOS setup information. Refer to [Section 1.5](#) for details on recommended power supplies.
2. The battery on your motherboard may be old. Check to verify that it still supplies ~3VDC. If it does not, replace it with a new one.
3. If the above steps do not fix the setup configuration problem, contact your vendor for repairs.

## When the System Becomes Unstable

### ***A. If the system becomes unstable during or after OS installation, check the following:***

1. CPU/BIOS support: Make sure that your CPU is supported and that you have the latest BIOS installed in your system.
2. Memory support: Make sure that the memory modules are supported by testing the modules using memtest86 or a similar utility.



**Note:** Refer to the product webpage on our website at <https://www.supermicro.com> for memory and CPU support and updates.

3. HDD support: Make sure that all hard disk drives (HDDs) work properly. Replace the bad HDDs with good ones.
4. System cooling: Check the system cooling to make sure that all heatsink fans and CPU/system fans, etc., work properly. Check the hardware monitoring settings in the IPMI to make sure that the CPU and system temperatures are within the normal range. Also check the front panel Overheat LED and make sure that it is not on.
5. Adequate power supply: Make sure that the power supply provides adequate power to the system. Make sure that all power connectors are connected. Please refer to our website for more information on the minimum power requirements.
6. Proper software support: Make sure that the correct drivers are used.

### ***B. If the system becomes unstable before or during OS installation, check the following:***

1. Source of installation: Make sure that the devices used for installation are working properly, including boot devices such as CD/DVD and CD/DVD-ROM.
2. Cable connection: Check to make sure that all cables are connected and working properly.

3. Using the minimum configuration for troubleshooting: Remove all unnecessary components (starting with add-on cards first), and use the minimum configuration (but with a CPU and a memory module installed) to identify the trouble areas. Refer to the steps listed in [Section A](#) above for proper troubleshooting procedures.
4. Identifying bad components by isolating them: If necessary, remove a component in question from the chassis, and test it in isolation to make sure that it works properly. Replace a bad component with a good one.
5. Check and change one component at a time instead of changing several items at the same time. This will help isolate and identify the problem.
6. To find out if a component is good, swap this component with a new one to see if the system will work properly. If so, then the old component is bad. You can also install the component in question in another system. If the new system works, the component is good and the old system has problems.

## 3.2 Technical Support Procedures

Before contacting Technical Support, please take the following steps. Also, note that as a motherboard manufacturer, we do not sell directly to end-users, so it is best to first check with your distributor or reseller for troubleshooting services. They should know of any possible problem(s) with the specific system configuration that was sold to you.

1. Please review the 'Troubleshooting Procedures' and 'Frequently Asked Questions' (FAQs) sections in this chapter or see the FAQs on our website before contacting Technical Support.
2. BIOS upgrades can be downloaded from our website. **Note:** Not all BIOS can be flashed depending on the modifications to the boot block code.
3. If you still cannot resolve the problem, include the following information when contacting us for technical support:
  - Motherboard model and PCB revision number
  - BIOS release date/version (this can be seen on the initial display when your system first boots up)
  - System configuration

An example of a Technical Support form is posted on our website.

Distributors: For immediate assistance, please have your account number ready when contacting our technical support department by e-mail.

### 3.3 Frequently Asked Questions

**Question: What type of memory does my motherboard support?**

**Answer:** The X11SAT/X11SAT-F motherboard supports up to 64 GB of DDR4 ECC/Non-ECC UDIMM memory with speeds of up to 2133MHz. See [Section 2.4](#) for details on installing memory.

**Question: How do I update my BIOS?**

**Answer:** It is recommended that you do not upgrade your BIOS if you are not experiencing any problems with your system. Updated BIOS files are located on our website at [http://www.supernmicro.com/ResourceApps/BIOS\\_IPMI\\_Intel.html](http://www.supernmicro.com/ResourceApps/BIOS_IPMI_Intel.html). Please check our BIOS warning message and the information on how to update your BIOS on our website. Select your motherboard model and download the BIOS file to your computer. Also, check the current BIOS revision to make sure that it is newer than your BIOS before downloading. To update the BIOS under Disk Operating System (DOS), please unzip the BIOS file onto a DOS bootable device. Run the batch file by entering `flash.bat BIOSname#.###` when the DOS prompt appears. After seeing the message that BIOS update has completed, reboot the system. Refer to the readme file and/or [Appendix D](#) UEFI BIOS Recovery for more information.

**Question: Why can't I turn off the power using the momentary power on/off switch?**

**Answer:** The instant power off function is controlled in BIOS by the Power Button Mode setting. When the On/Off feature is enabled, the motherboard will have instant off capabilities as long as the BIOS has control of the system. When the Standby or Suspend feature is enabled or when the BIOS is not in control such as during memory count (the first screen that appears when the system is turned on), the momentary on/off switch must be held for more than four seconds to shut down the system. This feature is required to implement the ACPI features on the motherboard.

## 3.4 Battery Removal and Installation

### Battery Removal

To remove the onboard battery, follow the steps below:

1. Power off your system and unplug your power cable.
2. Locate the onboard battery as shown below.
3. Using a tool such as a pen or a small screwdriver, push the battery lock outwards to unlock it. Once unlocked, the battery will pop out from the holder.
4. Remove the battery.

### Proper Battery Disposal

Please handle used batteries carefully. Do not damage the battery in any way; a damaged battery may release hazardous materials into the environment. Do not discard a used battery in the garbage or a public landfill. Please comply with the regulations set up by your local hazardous waste management agency to dispose of your used battery properly.

### Battery Installation

1. To install an onboard battery, follow the steps 1 and 2 above and continue below:
2. Identify the battery's polarity. The positive (+) side should be facing up.
3. Insert the battery into the battery holder and push it down until you hear a click to ensure that the battery is securely locked.



**Important:** When replacing a battery, be sure to only replace it with the same type.

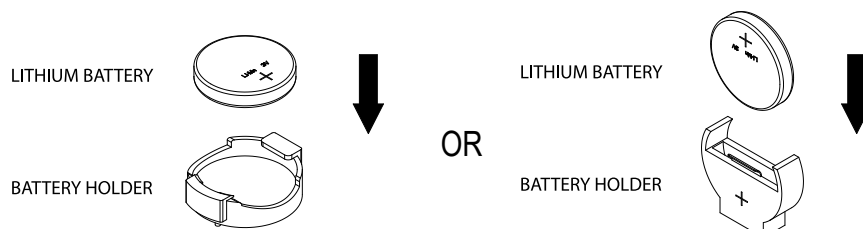

### 3.5 Returning Merchandise for Service

A receipt or copy of your invoice marked with the date of purchase is required before any warranty service will be rendered. You can obtain service by calling your vendor for a Returned Merchandise Authorization (RMA) number. When returning to the manufacturer, the RMA number should be prominently displayed on the outside of the shipping carton and mailed prepaid or hand-carried. Shipping and handling charges will be applied for all orders that must be mailed when service is complete.

For faster service, RMA authorizations may be requested online (<http://www.supermicro.com/support/rma/>).

This warranty only covers normal consumer use and does not cover damages incurred in shipping or from failure due to the alteration, misuse, abuse or improper maintenance of products.

During the warranty period, contact your distributor first for any product problems.

## Chapter 4

# UEFI BIOS

### 4.1 Introduction

This chapter describes the AMIBIOS™ Setup utility for the X11SAT/X11SAT-F motherboard. The BIOS is stored on a chip and can be easily upgraded using a flash program.



**Note:** Due to periodic changes to the BIOS, some settings may have been added or deleted and might not yet be recorded in this manual. Please refer to the Manual Download area of our website for any changes to BIOS that may not be reflected in this manual.

#### Starting the Setup Utility

To enter the BIOS Setup Utility, hit the <Delete> key while the system is booting-up. (In most cases, the <Delete> key is used to invoke the BIOS setup screen. There are a few cases when other keys are used, such as <F1>, <F2>, etc.) Each main BIOS menu option is described in this manual.

The Main BIOS screen has two main frames. The left frame displays all the options that can be configured. “Grayed-out” options cannot be configured. The right frame displays the key legend. Above the key legend is an area reserved for a text message. When an option is selected in the left frame, it is highlighted in white. Often a text message will accompany it. (Note that BIOS has default text messages built in. We retain the option to include, omit, or change any of these text messages.) Settings printed in **Bold** are the default values.

A " ►" indicates a submenu. Highlighting such an item and pressing the <Enter> key will open the list of settings within that submenu.

The BIOS setup utility uses a key-based navigation system called hot keys. Most of these hot keys (<F1>, <F2>, <F3>, <F4>, <Enter>, <ESC>, <Arrow> keys, etc.) can be used at any time during the setup navigation process.

## 4.2 Main Setup

When you first enter the AMI BIOS setup utility, you will enter the Main setup screen. You can always return to the Main setup screen by selecting the Main tab on the top of the screen. The Main BIOS setup screen is shown below. The following Main menu items will be displayed:



### System Date/System Time

Use this option to change the system date and time. Highlight *System Date* or *System Time* using the arrow keys. Enter new values using the keyboard. Press the <Tab> key or the arrow keys to move between fields. The date must be entered in MM/DD/YYYY format. The time is entered in HH:MM:SS format.

 **Note:** The time is in the 24-hour format. For example, 5:30 P.M. appears as 17:30:00. The date's default value is 01/01/2015 after RTC reset.

### Supermicro X11SAT

#### BIOS Version

This item displays the version of the BIOS ROM used in the system.

#### Build Date

This item displays the date when the version of the BIOS ROM used in the system was built.

## **Memory Information**

### **Total Memory**

This item displays the total size of memory available in the system.

## 4.3 Advanced Setup Configurations

Use the arrow keys to select Boot Setup and press <Enter> to access the submenu items.

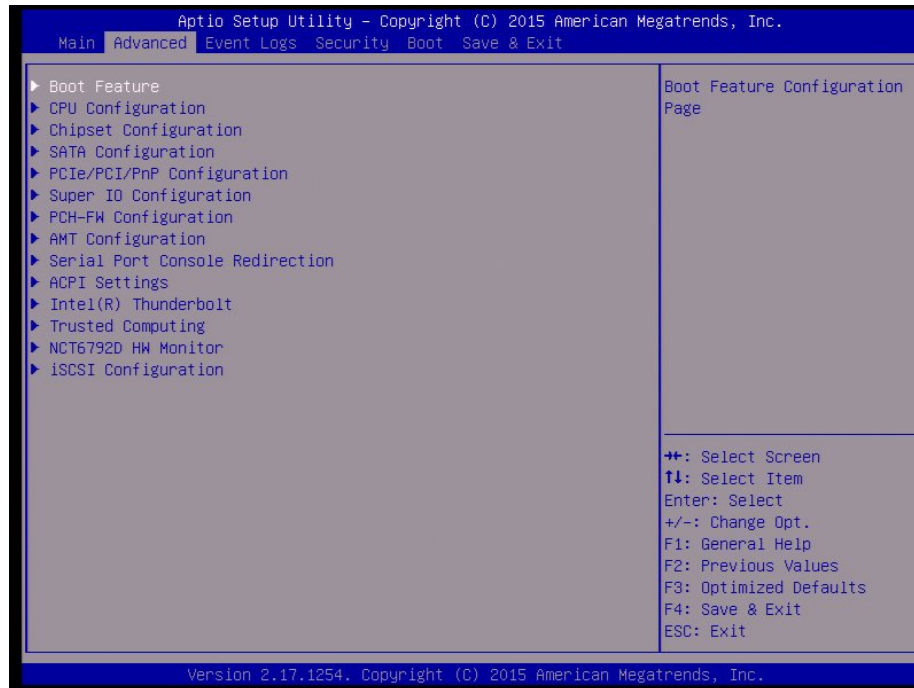

**Warning:** Take caution when changing the Advanced settings. An incorrect value, a very high DRAM frequency, or an incorrect DRAM timing setting may make the system unstable. When this occurs, revert to the default to the manufacture default settings.

### ► Boot Feature

#### Quiet Boot

Use this feature to select the screen display between the POST messages and the OEM logo upon bootup. Select Disabled to display the POST messages. Select Enabled to display the OEM logo instead of the normal POST messages. The options are Disabled and **Enabled**.

#### AddOn ROM Display Mode

Use this feature to set the display mode for the Option ROM. Select Keep Current to display the current AddOn ROM setting. Select Force BIOS to use the Option ROM display set by the system BIOS. The options are **Force BIOS** and Keep Current.

#### Bootup NumLock State

Use this feature to set the Power-on state for the <Numlock> key. The options are Off and **On**.

### **Wait For 'F1' If Error**

Use this feature to force the system to wait until the 'F1' key is pressed if an error occurs. The options are Disabled and **Enabled**.

### **INT19 (Interrupt 19) Trap Response**

Interrupt 19 is the software interrupt that handles the boot disk function. When this item is set to Immediate, the ROM BIOS of the host adaptors will "capture" Interrupt 19 at bootup immediately and allow the drives that are attached to these host adaptors to function as bootable disks. If this item is set to Postponed, the ROM BIOS of the host adaptors will not capture Interrupt 19 immediately and allow the drives attached to these adaptors to function as bootable devices at bootup. The options are **Immediate** and Postponed.

### **Re-try Boot**

If this item is enabled, the BIOS will automatically reboot the system from a specified boot device after its initial boot failure. The options are **Disabled**, Legacy Boot, and EFI Boot.

### **Install Windows 7 USB support**

Enable this feature to use the USB keyboard and mouse during the Windows 7 installation, since the native XHCI driver support is unavailable. Use a SATA optical drive as a USB drive, and USB CD/DVD drives are not supported. Disable this feature after the XHCI driver has been installed in Windows. The options are Disabled and **Enabled**.

## **►Power Configuration**

### **DeepSx Power Policies**

Use this item to configure the Advanced Configuration and Power Interface (ACPI) settings for the system. Enable S3 to use Standby Mode (Suspend-to-RAM) and maintain power supply to the system RAM when the system is in the sleep mode. Enable S4 to use Hibernation mode (Suspend to Disk) so that all data stored in of the main memory can be saved in a non-volatile memory area such as in a hard drive and then power down the system. Enable S5 to power off the whole system except the power supply unit (PSU) and keep the power button "alive" so that the user can "wake-up" the system by using an USB keyboard or mouse. The options are **Disabled** and Enabled

### **Watch Dog Function**

If enabled, the Watch Dog Timer will allow the system to reset or generate NMI based on jumper settings when it is expired for more than five minutes. The options are **Disabled** and Enabled.

### **Power Button Function**

This feature controls how the system shuts down when the power button is pressed. Select `4_Seconds_Override` for the user to power off the system after pressing and holding the power button for 4 seconds or longer. Select `Instant Off` to instantly power off the system as soon as the user presses the power button. The options are `4 Seconds Override` and **Instant Off**.

### **Restore on AC Power Loss**

Use this feature to set the power state after a power outage. Select `Stay-Off` for the system power to remain off after a power loss. Select `Power-On` for the system power to be turned on after a power loss. Select `Last State` to allow the system to resume its last power state before a power loss. The options are `Power On`, `Stay Off`, and **Last State**.

## **►CPU Configuration**

The following CPU information will display:

- Type of CPU
- CPU Signature
- Microcode Patch
- Max CPU Speed
- Min CPU Speed
- CPU Speed
- Processor Cores
- Hyper Threading Technology
- Intel VT-x Technology
- Intel SMX Technology
- 64-bit
- EIST Technology
- CPU C3 State
- CPU C6 State
- CPU C7 State
- L1 Data Cache

- L1 Code Cache
- L2 Cache
- L3 Cache
- L4 Cache

#### **Hyper-threading (Available when supported by the CPU)**

Select Enabled to support Intel Hyper-threading Technology to enhance CPU performance. The options are Disabled and **Enabled**.

#### **Active Processor Cores**

This feature determines how many CPU cores will be activated for each CPU. When all is selected, all cores in the CPU will be activated. (Please refer to Intel's web site for more information.) The options are **All** and 1.

#### **Intel® Virtualization Technology**

Select Enable to use Intel Virtualization Technology so that I/O device assignments will be reported directly to the VMM (Virtual Memory Management) through the DMAR ACPI Tables. This feature offers fully-protected I/O resource-sharing across the Intel platforms, providing the user with greater reliability, security and availability in networking and data-sharing. The settings are Disabled and **Enabled**.

#### **Hardware Prefetcher (Available when supported by the CPU)**

If set to Enabled, the hardware prefetcher will prefetch streams of data and instructions from the main memory to the L2 cache to improve CPU performance. The options are Disabled and **Enabled**.

#### **Adjacent Cache Line Prefetch (Available when supported by the CPU)**

The CPU prefetches the cache line for 64 bytes if this feature is set to Disabled. The CPU prefetches both cache lines for 128 bytes as comprised if this feature is set to **Enabled**.

#### **CPU AES**

Select Enabled to enable Intel CPU Advanced Encryption Standard (AES) Instructions for CPU to enhance data integrity. The options are Disabled and **Enabled**.

#### **Boot Performance Mode**

This feature allows the user to select the performance state that the BIOS will set before the operating system handoff. The options are Power Saving, **Max Non-Turbo Performance**, and Turbo Performance.

#### **HardWare P-States (HWP)**

Use this feature to enable or disable hardware P-States support. The options are **Disabled** and Enabled.

### **Intel® SpeedStep™**

Intel SpeedStep Technology allows the system to automatically adjust processor voltage and core frequency to reduce power consumption and heat dissipation. The options are Disabled and **Enabled**.

### **Power Limit 1 Override**

Select Enabled to support average power limit (PL1) override. The default setting is **Disabled**.

### **Power Limit 2 Override**

Select Enabled to support rapid power limit (PL2) override. The default setting is **Enabled**.

### **Power Limit 2**

Use this item to configure the value for Power Limit 2. The value is in milli watts and the step size is 125mW. Use the number keys on your keyboard to enter the value. Enter 0 to use the manufacture default setting. If the value is 0, the BIOS will set PL2 as 1.25\* TDP.

### **1-Core Ratio Limit Override**

This increases (multiplies) 1 clock speed in the CPU core in relation to the bus speed when one CPU core is active. Press "+" or "-" on your keyboard to change the value. Enter 0 to use the manufacture default setting.

### **2-Core Ratio Limit Override**

This increases (multiplies) 2 clock speeds in the CPU core in relation to the bus speed when two CPU cores are active. Press "+" or "-" on your keyboard to change the value. Enter 0 to use the manufacture default setting.

### **CPU C-States**

Use this feature to enable the C-State of the CPU. The options are Disabled and **Enabled**.

### **Enhanced C-States**

Use this feature to enable the enhanced C-State of the CPU. The options are Disabled and **Enabled**.

### **C-State Auto Demotion**

Use this feature to prevent unnecessary excursions into the C-states to improve latency. The options are Disabled, C1, C3, and **C1 and C3**.

### **C-State Un-Demotion**

This feature allows the user to enable or disable the un-demotion of C-State. The options are Disabled, C1, C3, and **C1 and C3**.

### **Package C-State Demotion**

Use this feature to enable or disable the Package C-State demotion. The options are **Disabled** and Enabled.

### **Package C-State Un-Demotion**

Use this feature to enable or disable the Package C-State un-demotion. The options are **Disabled** and **Enabled**.

### **C-State Pre-Wake**

This feature allows the user to enable or disable the C-State Pre-Wake. The options are **Disabled** and **Enabled**.

### **Package C-State Limit**

Use this feature to set the Package C-State limit. The options are C0/C1, C2, C3, C6, C7, C7s, C8, and **AUTO**.

## **► CPU Thermal Configuration**

### **CPU DTS**

Select **Enabled** for the ACPI thermal management to use the DTS SMM mechanism to obtain CPU temperature values. Select **Disabled** for EC to report the CPU temperature values. The options are **Disabled** and **Enabled**.

### **ACPI 3.0 T-States**

Select **Enabled** to support CPU throttling by the operating system to reduce power consumption. The options are **Enabled** and **Disabled**.

## **► Chipset Configuration**

**Warning:** Setting the wrong values in the following features may cause the system to malfunction.

## **► System Agent (SA) Configuration**

The following System Agent information will display:

- System Agent Bridge Name
- SA PCIe Code Version
- VT-d

### **VT-d**

Select **Enabled** to enable Intel Virtualization Technology support for Direct I/O VT-d by reporting the I/O device assignments to VMM through the DMAR ACPI Tables. This feature offers fully-protected I/O resource-sharing across the Intel platforms, providing the user with greater reliability, security and availability in networking and data-sharing. The options are **Disabled** and **Enabled**.

### **SW Guard Extensions (SGX)**

Use this feature to enable or disable the Intel Software Guard Extensions (SGX). SGX is a set of CPU instructions that increases software security. The options are Disabled, **Enabled**, and Software Controlled.

### **PRMRR Size**

The BIOS must reserve a contiguous region of Processor Reserved Memory (PRM) in the Processor Reserved Memory Range Register (PRMRR). This feature appears if SW Guard Extensions is set to Enabled. The options are **Auto**, 32MB, 64MB, and 128MB.

## **► Graphics Configuration**

### **Primary Display**

Use this feature to select the graphics device to be used as the primary display. The options are **Auto**, IGFX, PEG, and PCIE.

### **Primary PEG**

This feature allows the user to select the primary PCI Express Graphics (PEG) slot. The default setting is **CPU SLOT6 PCI-E 3.0 X16** and CPU SLOT4 PCI-E 3.0 X8 (IN X16).

### **Primary PCIE (PCI-Express Graphics)**

This feature allows the user to specify which graphics card to be used as the primary graphics card. The options are **PCIE1**, PCIE2, PCIE3, PCIE4, PCH SLOT6 PCIE 3.0 X1, PCIE6, PCH SLOT3 PCI-E X1, PCH SLOT7 PCI-E 3.0 X1, PCIE9, PCIE10, PCIE11, PCIE12, PCIE13, PCIE14, PCIE15, PCIE16, PCIE17, PCIE18, and PCIE19.

### **Internal Graphics**

Select Auto to keep an internal graphics device installed on an expansion slot supported by the CPU to be automatically enabled. The options are **Auto**, Disabled, and Enabled.

## **► DMI/OPI Configuration**

The following DMI information will display:

- DMI

### **DMI VC1 Control**

Use this feature to enable or disable DMI Virtual Channel 1. The options are Enabled and **Disabled**.

### **DMI VCm Control**

Use this feature to enable or disable the DMI Virtual Channel map. The options are **Enabled** and Disabled.

### **CPU DMI Link ASPM Control**

Use this feature to set the ASPM (Active State Power Management) state on the SA (System Agent) side of the DMI Link. The options are Disabled and **L1**.

### **DMI Extended Sync Control**

Use this feature to enable or disable the DMI extended synchronization. The options are **Disabled** and Enabled.

### **DMI De-Emphasis Control**

Use this feature to configure the De-emphasis control on DMI. The options are -6dB and **-3.5dB**.

## **► PEG Port Configuration**

### **CPU SLOT6 PCI-E 3.0 X16**

#### **SLOT6 Max Link Speed**

This feature allows the user to select PCIe support for the device installed on SLOT6. The options are **Auto**, Gen 1, Gen 2, and Gen 3.

#### **SLOT6 Max Payload Size**

Use this feature to select the PEG0 maximum payload size. The options are **Auto**, 128 TLP, and 256 TLP.

#### **SLOT6 Power Limit Value**

Use this feature to set the upper limit on the power supplied by the PCIe slot. Press "+" or "-" on your keyboard to change this value. The default setting is **75**.

#### **SLOT6 Power Limit Scale**

Use this feature to select the scale used for the slot power limit value. The options are **1.0x**, 0.1x, 0.01x, and 0.001x.

### **CPU SLOT4 PCI-E 3.0 X8 (IN X16)**

#### **PEG1 Enable Root Port**

Use this feature to enable or disable the PCI Express Graphics (PEG) device in the port specified by the user. The options are Disabled, Enabled, and **Auto**.

#### **SLOT4 Max Link Speed**

This feature allows the user to select PCIe support for the device installed on SLOT4. The options are **Auto**, Gen 1, Gen 2, and Gen 3.

#### **SLOT4 Max Payload Size**

Use this feature to select the PEG0 maximum payload size. The options are **Auto**, 128 TLP, and 256 TLP.

**SLOT4 Power Limit Value**

Use this feature to set the upper limit on the power supplied by the PCIe slot. Press "+" or "-" on your keyboard to change this value. The default setting is **75**.

**SLOT4 Power Limit Scale**

Use this feature to select the scale used for the slot power limit value. The options are **1.0x**, 0.1x, 0.01x, and 0.001x.

**PEG 0:1:2****PEG2 Enable Root Port**

Use this feature to enable or disable the PCI Express Graphics (PEG) device in the port specified by the user. The options are Disabled, Enabled, and **Auto**.

**PEG2 Max Link Speed**

Use this item to configure the link speed of a PCIe port specified by the user. The options are **Auto**, Gen1, Gen2, and Gen3.

**PEG2 Max Payload Size**

Select Auto for the system BIOS to automatically set the maximum payload value for a PCIe device to enhance system performance. The options are **Auto**, 128 TLP and 256 TLP.

**PEG2 Slot Power Limit Value**

Use this feature to set the upper limit on the power supplied by the PCIe slot. Press "+" or "-" on your keyboard to change this value. The default setting is **75**.

**PEG2 Slot Power Limit Scale**

Use this feature to select the scale used for the slot power limit value. The options are **1.0x**, 0.1x, 0.01x, and 0.001x.

**Program PCIe ASPM After OPROM**

PCIe ASPM, the Active State Power Management for PCIe slots, is a power management protocol used to manage power consumption of serial-link devices installed on PCIe slots during a prolonged off-peak time. If this item is set to Enabled, PCIe ASMP will be programmed after OPROM. If this item is set to Disabled, the PCIe ASPM will be programmed before OPROM. The options are **Disabled** and Enabled.

**► Memory Configuration**

The following memory information will display:

- Memory RC Version
- Memory Frequency

- Total Memory
- VDD
- DIMMA1
- DIMMA2
- DIMMB1
- DIMMB2
- Memory Timings (tCL-tRCD-tRP-tRAS)

### **Maximum Memory Frequency**

Use this feature to set the maximum memory frequency for onboard memory modules. The options are **Auto**, 1067, 1200, 1333, 1400, 1600, 1800, 1867, 2000, 2133, 2200, and 2400.

### **Max TOLUD**

This feature sets the maximum TOLUD value, which specifies the "Top of Low Usable DRAM" memory space to be used by internal graphics devices, GTT Stolen Memory, and TSEG, respectively, if these devices are enabled. The options are **Dynamic**, 1 GB, 1.25 GB, 1.5 GB, 1.75 GB, 2 GB, 2.25 GB, 2.5 GB, 2.75 GB, 3 GB, 3.25 GB, and 3.5 GB.

### **Energy Performance Gain**

Use this feature to enable or disable the energy performance gain. The options are **Disabled** and Enabled.

### **Memory Scrambler**

Select Enabled to enable memory scrambler support. The options are Disabled and **Enabled**.

### **Fast Boot**

Use this feature to enable or disable fast path through the memory reference code. The options are **Enabled** and Disabled.

### **REFRESH\_2X\_MODE**

Use this feature to select the refresh mode. The options are **Disabled**, 1-Enabled for WARM or HOT, and 2-Enabled HOT only.

### **Closed Loop Thermal Management**

Use this feature to monitor the power consumption and temperature of the system to predict a thermal trend. The options are Disabled and **Enabled**.

## ▶GT - Power Management Control

The following GT - Power Management Control information will display:

- GT Info

### RC6 (Render Standby)

Select Enabled to enable render standby support. The options are Disabled and **Enabled**.

## ▶PCH-IO Configuration

The following PCH-IO information will display:

- Intel PCH RC Version
- Intel PCH SKU Name
- Intel PCH Rev ID

## ▶PCI Express Configuration

### PCH DMI Link ASPM Control

Use this feature to set the ASPM (Active State Power Management) state on the SA (System Agent) side of the DMI Link. The options are Disabled and **Enabled**.

### Peer Memory Write Enable

Use this feature to enable or disable peer memory write. The options are **Disabled** or Enabled.

## ▶PCH SLOT6 PCI-E 3.0 X16

### Port 6 PCIe Speed

Use this feature to select the PCIe port speed. The options are **Auto**, Gen1, Gen2, and Gen3.

### Port 6 Detect Non-Compliance

Select Enabled for the AMI BIOS to automatically detect a PCIe device that is not compliant with the PCIe standards. The options are **Disabled** and Enabled.

## ► PCH SLOT3 PCI-E 3.0 X1

### Port 7 PCIe Speed

Use this feature to select the PCIe port speed. The options are **Auto**, Gen1, Gen2, and Gen3.

### Port 7 Detect Non-Compliance

Select Enabled for the AMI BIOS to automatically detect a PCIe device that is not compliant with the PCIe standards. The options are **Disabled** and Enabled.

## ► PCH SLOT7 PCI-E 3.0 X4

### Port 8 PCIe Speed

Use this feature to select the PCIe port speed. The options are **Auto**, Gen1, Gen2, and Gen3.

### Port 8 Detect Non-Compliance

Select Enabled for the AMI BIOS to automatically detect a PCIe device that is not compliant with the PCIe standards. The options are **Disabled** and Enabled.

### Port 61h bit-4 Emulation

Select Enabled to enable the emulation of Port 61h bit-4 toggling in SMM (System Management Mode). The options are Disabled and **Enabled**.

### PCIe PLL SSC

Enable this feature to reduce EMI interference by down spreading the clock 0.5%. Disable this feature to centralize the clock without spreading. The options are **Disabled** and Enabled.

### USB 3.1 Device

Use this feature to enable or disable support for USB 3.1. The options are Disabled and **Enabled**.

## ► SATA Configuration

When this submenu is selected, the AMI BIOS automatically detects the presence of the SATA devices that are supported by the Intel PCH chip and displays the following items:

### SATA Controller(s)

This item enables or disables the onboard SATA controller supported by the Intel PCH chip. The options are **Enabled** and Disabled.

### SATA Mode Selection

Use this item to select the mode for the installed SATA drives. The options are **AHCI** and RAID.

### **SATA Frozen**

Use this item to enable the HDD Security Frozen Mode. The options are Enabled and **Disabled**.

***\*If the item above "SATA Mode Selection" is set to RAID, the following items will display:***

#### **SATA RAID Option ROM/UEFI Driver**

Select UEFI to load the EFI driver for system boot. Select Legacy to load a legacy driver for system boot. The options are **Legacy ROM** and UEFI Driver.

#### **SATA Port 0~ Port 5**

This item displays the information detected on the installed SATA drive on the particular SATA port.

- Model number of drive and capacity
- Software Preserve Support

#### **Port 0 ~ Port 5 Spin Up Device**

On an edge detect from 0 to 1, set this item to allow the PCH to initialize the device. The options are Enabled and **Disabled**.

#### **Port 0 ~ Port 5 SATA Device Type**

Use this item to specify if the SATA port specified by the user should be connected to a Solid State drive or a Hard Disk Drive. The options are **Hard Disk Drive** and Solid State Drive.

## **►PCI/PCI/PnP Configuration**

The following information will display:

- PCI Bus Driver Version
- PCI Devices Common Settings:

### **PCI Latency Timer**

Use this feature to set the latency Timer of each PCI device installed on a PCI bus. Select 32 to set the PCI latency to 32 PCI clock cycles. The options are **32 PCI Bus Clocks**, 64 PCI Bus Clocks, 96 PCI Bus Clocks, 128 PCI Bus Clocks, 160 PCI Bus Clocks, 192 PCI Bus Clocks, 224 PCI Bus Clocks, and 248 PCI Bus Clocks.

### **PCI PERR/SERR Support**

Select Enabled to allow a PCI device to generate a PERR/SERR number for a PCI Bus Signal Error Event. The options are Enabled and **Disabled**.

### **Above 4G Decoding (Available if the system supports 64-bit PCI decoding)**

Select Enabled to decode a PCI device that supports 64-bit in the space above 4G Address. The options are Enabled and **Disabled**.

### **SLOT1 PCI33MHz OPROM**

Use this feature to select which firmware type to be loaded for the add-on card in this slot. The options are Disabled, **Legacy**, and EFI.

### **CPU SLOT2 PCI-E X16 OPROM**

Use this feature to select which firmware type to be loaded for the add-on card in this slot. The options are Disabled, **Legacy**, and EFI.

### **PCH SLOT3 PCI-E 3.0 X4 OPROM**

Use this feature to select which firmware type to be loaded for the add-on card in this slot. The options are Disabled, **Legacy**, and EFI.

### **CPU SLOT4 PCI-E 3.0 X8 (IN X16) OPROM**

Use this feature to select which firmware type to be loaded for the add-on card in this slot. The options are Disabled, **Legacy**, and EFI.

### **PCH SLOT6 PCI-E 3.0 X16 OPROM**

Use this feature to select which firmware type to be loaded for the add-on card in this slot. The options are Disabled, **Legacy**, and EFI.

### **Onboard LAN Option ROM Type**

Select Enabled to enable Option ROM support to boot the computer using a network device specified by the user. The options are **Legacy** and EFI.

### **Onboard LAN1 Option ROM**

Use this option to select the type of device installed in LAN Port1 used for system boot. The default setting for LAN1 Option ROM is **PXE**.

### **Onboard LAN2 Option ROM**

Use this option to select the type of device installed in LAN Port2 used for system boot. The default setting for LAN2 Option ROM is **Disabled**.

### **Onboard Video Option ROM**

Use this item to select the Onboard Video Option ROM type. The options are Disabled, **Legacy**, and EFI.

### **Network Stack**

Select Enabled to enable PXE (Preboot Execution Environment) or UEFI (Unified Extensible Firmware Interface) for network stack support. The options are **Enabled** and Disabled.

**IPv4 PXE Support**

Select Enabled to enable IPv4 PXE boot support. The options are **Enabled** and Disabled.

**IPv6 PXE Support**

Select Enabled to enable IPv6 PXE boot support. The options are Enabled and **Disabled**.

**PXE boot wait time**

Use this option to specify the wait time to press the ESC key to abort the PXE boot. Press "+" or "-" on your keyboard to change the value. The default setting is **0**.

**Media detect count**

Use this option to specify the number of times media will be checked. Press "+" or "-" on your keyboard to change the value. The default setting is **1**.

**► Super IO Configuration****Super IO Configuration****► Serial Port 1****Serial Port 1 Configuration**

This submenu allows the user the configure settings of Serial Port 1.

**Serial Port 1**

Select Enabled to enable the selected onboard serial port. The options are **Enabled** and Disabled.

**Logical Device Settings**

This item displays the status of a serial part specified by the user.

**Serial Port 1 Change Settings**

This feature specifies the base I/O port address and the Interrupt Request address of a serial port specified by the user. Select Auto to allow the BIOS to automatically assign the base I/O and IRQ address.

The options for Serial Port 1 are **Auto**, (IO=3F8h; IRQ=4;), (IO=3F8h; IRQ=3, 4, 5, 6, 7, 9, 10, 11, 12;), (IO=2F8h; IRQ=3, 4, 5, 6, 7, 9, 10, 11, 12;), (IO=3E8h; IRQ=3, 4, 5, 6, 7, 9, 10, 11, 12;), and (IO=2E8h; IRQ=3, 4, 5, 6, 7, 9, 10, 11, 12;).

## ► PCH-FW Configuration

The following firmware information will display:

- ME FW Version
- ME Firmware Mode
- ME Firmware Type
- ME Firmware SKU

### ME FW Image Re-Flash

Use this feature to update the Management Engine firmware. The options are Enabled and Disabled.

## ► AMT Configuration

### Intel AMT

Select Enabled to use Intel AMT (Active Management Technology) to enhance system performance. The options are Disabled and **Enabled**.

### BIOS Hotkey Pressed

Select Enabled to use the BIOS Hotkey feature. The options are **Disabled** and Enabled.

### Watch Dog

Select Enabled to allow AMT to reset or power down the system if the operating system or BIOS hangs or crashes. The options are **Disabled** and Enabled.

### OS Timer / BIOS Timer

These options appear if Watch Dog Timer (above) is enabled. This is a timed delay in seconds, before a system power down or reset after a BIOS or operating system failure is detected. Directly enter the value in seconds.

## ► Serial Port Console Redirection

### COM1 Console Redirection

Select Enabled to enable console redirection support for a serial port specified by the user. The options are Enabled and **Disabled**.

***\*If the item above is set to Enabled, the following items will become available for user's configuration:***

## ►COM1 Console Redirection Settings

This feature allows the user to specify how the host computer will exchange data with the client computer, which is the remote computer used by the user.

### COM1 Terminal Type

This feature allows the user to select the target terminal emulation type for Console Redirection. Select VT100 to use the ASCII Character set. Select VT100+ to add color and function key support. Select ANSI to use the Extended ASCII Character Set. Select VT-UTF8 to use UTF8 encoding to map Unicode characters into one or more bytes. The options are ANSI, VT100, **VT100+**, and VT-UTF8.

### COM1 Bits Per second

Use this feature to set the transmission speed for a serial port used in Console Redirection. Make sure that the same speed is used in the host computer and the client computer. A lower transmission speed may be required for long and busy lines. The options are 9600, 19200, 38400, 57600 and **115200** (bits per second).

### COM1 Data Bits

Use this feature to set the data transmission size for Console Redirection. The options are 7 and 8.

### COM1 Parity

A parity bit can be sent along with regular data bits to detect data transmission errors. Select Even if the parity bit is set to 0, and the number of 1's in data bits is even. Select Odd if the parity bit is set to 0, and the number of 1's in data bits is odd. Select None if you do not want to send a parity bit with your data bits in transmission. Select Mark to add a mark as a parity bit to be sent along with the data bits. Select Space to add a Space as a parity bit to be sent with your data bits. The options are **None**, Even, Odd, Mark and Space.

### COM1 Stop Bits

A stop bit indicates the end of a serial data packet. Select 1 Stop Bit for standard serial data communication. Select 2 Stop Bits if slower devices are used. The options are **1** and 2.

### COM1 Flow Control

Use this feature to set the flow control for Console Redirection to prevent data loss caused by buffer overflow. Send a "Stop" signal to stop sending data when the receiving buffer is full. Send a "Start" signal to start sending data when the receiving buffer is empty. The options are **None** and Hardware RTS/CTS.

### COM1 VT-UTF8 Combo Key Support

Select Enabled to enable VT-UTF8 Combination Key support for ANSI/VT100 terminals. The options are **Enabled** and Disabled.

### **COM1 Recorder Mode**

Select Enabled to capture the data displayed on a terminal and send it as text messages to a remote server. The options are **Disabled** and Enabled.

### **COM1 Resolution 100x31**

Select Enabled for extended-terminal resolution support. The options are Disabled and **Enabled**.

### **COM1 Legacy OS Redirection Resolution**

Use this feature to select the number of rows and columns used in Console Redirection for legacy OS support. The options are 80x24 and **80x25**.

### **COM1 Putty KeyPad**

This feature selects the settings for Function Keys and KeyPad used for Putty, which is a terminal emulator designed for the Windows OS. The options are **VT100**, LINUX, XTERMR6, SC0, ESCN, and VT400.

### **COM1 Redirection After BIOS POST**

Use this feature to enable or disable legacy console redirection after BIOS POST. When set to Bootloader, legacy console redirection is disabled before booting the OS. When set to Always Enable, legacy console redirection remains enabled when booting the OS. The options are **Always Enable** and Bootloader.

### **SOL Console Redirection**

#### **Serial Port for Out-of-Band Management/Windows Emergency Management Services (EMS)**

The submenu allows the user to configure Console Redirection settings to support Out-of-Band Serial Port management.

#### **EMS (Emergency Management Services) Console Redirection**

Select Enabled to use a COM port selected by the user for EMS Console Redirection. The options are Enabled and **Disabled**.

***\*If the item above is set to Enabled, the following items will become available for user's configuration:***

#### **► EMS Console Redirection Settings**

This feature allows the user to specify how the host computer will exchange data with the client computer, which is the remote computer used by the user.

### **Out-of-Band Mgmt Port**

The feature selects a serial port in a client server to be used by the Microsoft Windows Emergency Management Services (EMS) to communicate with a remote host server. The options are **COM1**, COM2, COM3, and AMT SOL.

### **Terminal Type**

Use this feature to select the target terminal emulation type for Console Redirection. Select VT100 to use the ASCII character set. Select VT100+ to add color and function key support. Select ANSI to use the extended ASCII character set. Select VT-UTF8 to use UTF8 encoding to map Unicode characters into one or more bytes. The options are ANSI, VT100, VT100+, and **VT-UTF8**.

### **Bits Per Second**

This item sets the transmission speed for a serial port used in Console Redirection. Make sure that the same speed is used in the host computer and the client computer. A lower transmission speed may be required for long and busy lines. The options are 9600, 19200, 57600, and **115200** (bits per second).

### **Flow Control**

Use this item to set the flow control for Console Redirection to prevent data loss caused by buffer overflow. Send a "Stop" signal to stop sending data when the receiving buffer is full. Send a "Start" signal to start sending data when the receiving buffer is empty. The options are **None**, Hardware RTS/CTS, and Software Xon/Xoff.

### **Data Bits**

### **Parity**

### **Stop Bits**

## **▶ACPI Settings**

### **ACPI Sleep State**

This feature selects the ACPI Sleep State that the system will enter into when the suspend button is activated. The options are Suspend Disabled and **S3 (Suspend to RAM)**.

### **High Precision Event Timer**

Select Enabled to activate the High Performance Event Timer (HPET) that produces periodic interrupts at a much higher frequency than a Real-time Clock (RTC) does in synchronizing multimedia streams, providing smooth playback and reducing the dependency on other timestamp calculation devices, such as an x86 RDTSC Instruction embedded in the CPU. The High Performance Event Timer is used to replace the 8254 Programmable Interval Timer. The options are Disabled and **Enabled**.

## **WHEA Support**

This feature Enables the Windows Hardware Error Architecture (WHEA) support for the Windows 2008 (or a later version) operating system. The options are Disabled and **Enabled**.

## **► Trusted Computing**

### **Security Device Support**

If this feature and the TPM jumper on the motherboard are both set to Enabled, onboard security devices will be enabled for TPM (Trusted Platform Module) support to enhance data integrity and network security. Please reboot the system for a change on this setting to take effect. The options are Disabled and **Enabled**.

### **TPM State**

This feature changes the TPM State. The options are **Disabled** and Enabled. Note: The system will restart to change the TPM State.

### **Pending operation**

Use this item to schedule a TPM-related operation to be performed by a security device for system data integrity. Your system will reboot to carry out a pending TPM operation. The options are **None** and TPM Clear.

### **Device Select**

Use this feature to select the TPM version. TPM 1.2 will restrict support to TPM 1.2 devices. TPM 2.0 will restrict support for TPM 2.0 devices. Select Auto to enable support for both versions. The default setting is **Auto**.

The following are informational status messages that indicate the current TPM State:

#### **TPM Enabled Status**

#### **TPM Active Status**

#### **TPM Owner Status**

### **TXT Support**

Intel TXT (Trusted Execution Technology) helps protect against software-based attacks and ensures protection, confidentiality and integrity of data stored or created on the system. Use this feature to enable or disable TXT Support. The options are **Disabled** and Enabled.

## **► HW Monitor**

The following PC health status information will be displayed:

- CPU Temperature
- System Temperature

- Peripheral Temperature
- PCH Temperature

### **Fan Speed Control Mode**

Use this feature to select the fan speed control mode. The options are **Standard** and Full Speed.

- FAN1 Speed
- FAN2 Speed
- FAN3 Speed
- FAN4 Speed
- FAN5 Speed
- VCPU
- 12V
- VCPU\_SA
- 5VCC
- VDIMM
- VCPU\_IO
- VCPU\_GT
- VDIMM\_2.5
- PCH 1.0V
- 3.3V\_DL
- AVCC
- VSB3
- 3.3VCC
- VBAT

## ► iSCSI Configuration

### iSCSI Initiator Name

This feature allows the user to enter the unique name of the iSCSI Initiator in IQN format. Once the name of the iSCSI Initiator is entered into the system, configure the proper settings for the following items.

#### ► Add an Attempt

#### ► Delete Attempts

#### ► Change Attempt Order

## 4.4 Event Logs

Use this feature to configure Event Log settings.

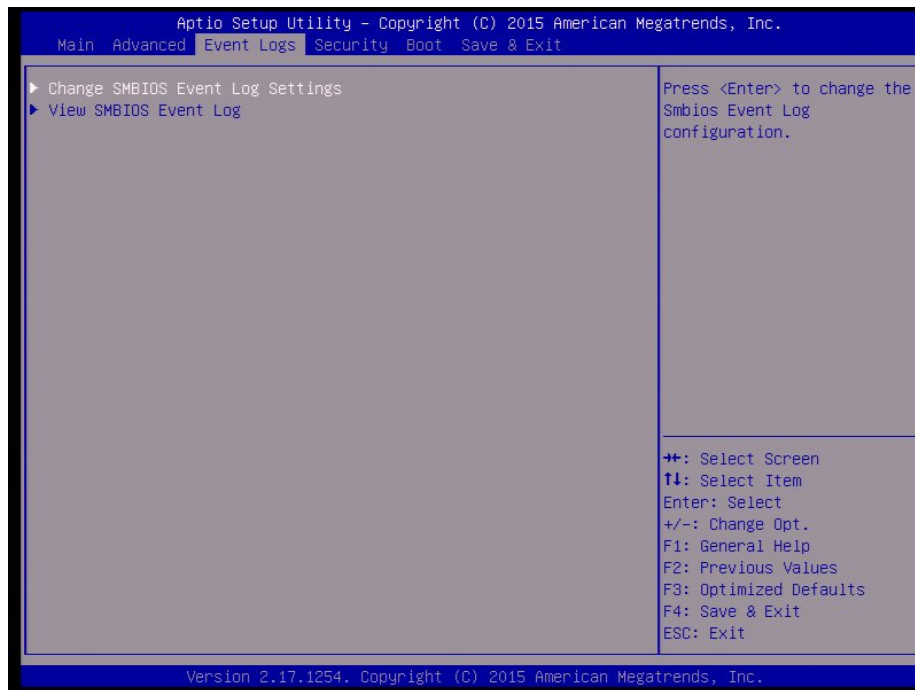

### ► Change SMBIOS Event Log Settings

#### Enabling/Disabling Options

#### SMBIOS Event Log

Change this item to enable or disable all features of the SMBIOS Event Logging during system boot. The options are **Enabled** and Disabled.

#### Erasing Settings

#### Erase Event Log

If No is selected, data stored in the event log will not be erased. Select Yes, Next Reset, data in the event log will be erased upon next system reboot. Select Yes, Every Reset, data in the event log will be erased upon every system reboot. The options are **No**, Yes, Next reset, and Yes, Every reset.

#### When Log is Full

Select Erase Immediately for all messages to be automatically erased from the event log when the event log memory is full. The options are **Do Nothing** and Erase Immediately.

## **SMBIOS Event Long Standard Settings**

### **Log System Boot Event**

This option toggles the System Boot Event logging to enabled or disabled. The options are **Disabled** and **Enabled**.

### **MECI**

The Multiple Event Count Increment (MECI) counter counts the number of occurrences that a duplicate event must happen before the MECI counter is incremented. This is a numeric value. The default value is **1**.

### **METW**

The Multiple Event Time Window (METW) defines number of minutes must pass between duplicate log events before MECI is incremented. This is in minutes, from 0 to 99. The default value is **60**.



**Note:** After making changes on a setting, be sure to reboot the system for the changes to take effect.

### **►View SMBIOS Event Log**

This section displays the contents of the SMBIOS Event Log.

## 4.5 Security

This menu allows the user to configure the following security settings for the system.

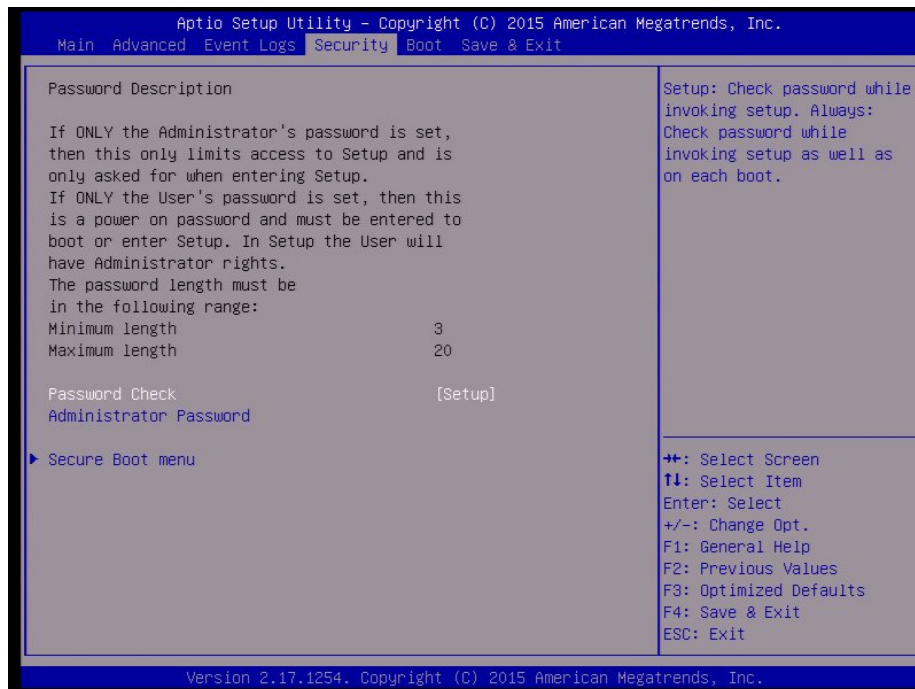

### Password Check

Select Setup for the system to check for a password at Setup. Select Always for the system to check for a password at bootup or upon entering the BIOS Setup utility. The options are **Setup** and Always.

### Administrator Password

Press Enter to create a new, or change an existing Administrator password.

### ► Secure Boot Menu

This section displays the contents of the following secure boot features:

- System Mode
- Secure Boot
- Vendor Keys

### Secure Boot

Use this item to enable secure boot. The options are **Disabled** and Enabled.

### **Secure Boot Mode**

Use this item to select the secure boot mode. The options are Standard and **Custom**.

### **CSM Support**

Select Enabled to support the EFI Compatibility Support Module (CSM), which provides compatibility support for traditional legacy BIOS for system boot. The options are **Enabled** and Disabled.

### **► Key Management**

This submenu allows the user to configure the following Key Management settings.

#### **Provision Factory Default Keys**

Select Enabled to install the default Secure-Boot keys set by the manufacturer. The options are **Disabled** and Enabled.

#### **► Enroll All Factory Default Keys**

Select Yes to install all default secure keys set by the manufacturer. The options are **Yes** and No.

#### **Save All Secure Boot Variables**

This feature allows the user to decide if all secure boot variables should be saved.

#### **► Platform Key (PK)**

This feature allows the user to configure the settings of the platform keys.

#### **Set New Key**

Select Yes to load the new platform keys (PK) from the manufacturer's defaults. Select No to load the platform keys from a file. The options are **Yes** and No.

#### **► Key Exchange Keys**

#### **Set New Key**

Select Yes to load the KEK from the manufacturer's defaults. Select No to load the KEK from a file. The options are Yes and No.

#### **Append Key**

Select Yes to add the KEK from the manufacturer's defaults list to the existing KEK. Select No to load the KEK from a file. The options are Yes and No.

#### **► Authorized Signatures**

#### **Set New Key**

Select Yes to load the database from the manufacturer's defaults. Select No to load the DB from a file. The options are Yes and No.

**Append Key**

Select Yes to add the database from the manufacturer's defaults to the existing DB. Select No to load the DB from a file. The options are Yes and No.

**► Forbidden Signatures****Set New Key**

Select Yes to load the DBX from the manufacturer's defaults. Select No to load the DBX from a file. The options are Yes and No.

**Append Key**

Select Yes to add the DBX from the manufacturer's defaults to the existing DBX. Select No to load the DBX from a file. The options are Yes and No.

**► Authorized TimeStamps****Set New Key**

Select Yes to load the DBT from the manufacturer's defaults. Select No to load the DBT from a file. The options are Yes and No.

**Append Key**

Select Yes to add the DBT from the manufacturer's defaults list to the existing DBT. Select No to load the DBT from a file. The options are Yes and No.

## 4.6 Boot

Use this feature to configure Boot Settings:

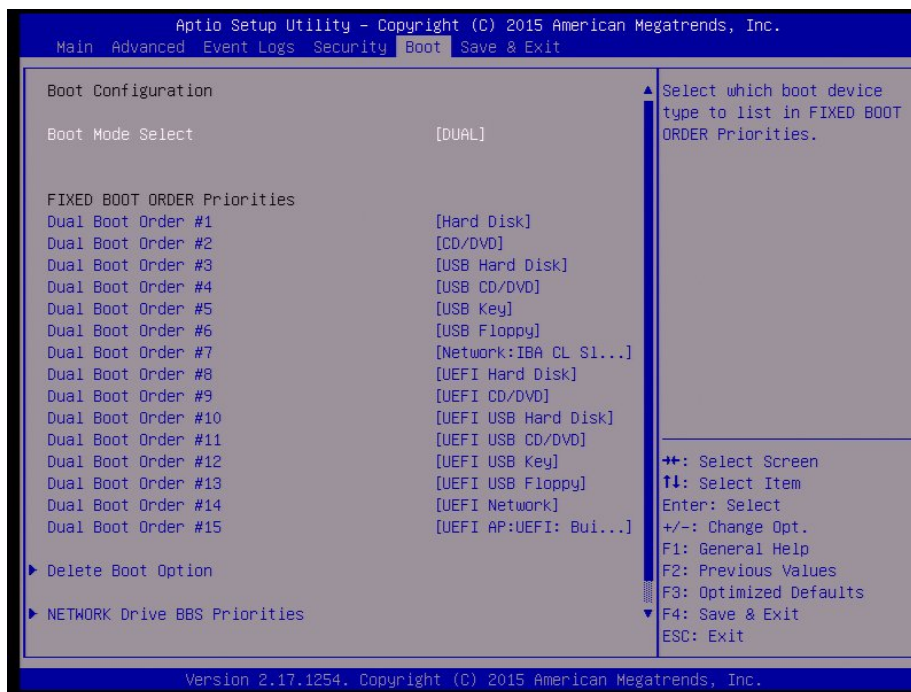

### Boot Mode Select

Use this item to select the type of device that the system is going to boot from. The options are Legacy, UEFI, and **Dual**. The default setting is Dual.

### Fixed Boot Order Priorities

This option prioritizes the order of bootable devices that the system to boot from. Press <Enter> on each entry from top to bottom to select devices.

***\*If the item above is set to Legacy, UEFI/Dual the following items will be displayed:***

- Legacy/UEFI/Dual/Boot Order #1
- Legacy/UEFI/Dual/Boot Order #2
- Legacy/UEFI/Dual/Boot Order #3
- Legacy/UEFI/Dual/Boot Order #4
- Legacy/UEFI/Dual/Boot Order #5
- Legacy/UEFI/Dual/Boot Order #6
- Legacy/UEFI/Dual/Boot Order #7

- Legacy/UEFI/Dual/Boot Order #8
- Legacy/UEFI/Dual/Boot Order #9
- Legacy/UEFI/Dual/Boot Order #10
- Legacy/UEFI/Dual/Boot Order #11
- Legacy/UEFI/Dual/Boot Order #12
- Legacy/UEFI/Dual/Boot Order #13
- Legacy/UEFI/Dual/Boot Order #14
- Legacy/UEFI/Dual/Boot Order #15

► **Add New Boot Option**

Use this item to select a new boot device to add to the boot priority list.

► **Delete Boot Option**

Use this feature to remove a pre-defined boot device from which the system will boot during startup.

The settings are [any pre-defined boot device].

► **NETWORK Drive BBS Priorities**

This feature allows the user to specify which Network devices are boot devices.

- Legacy Boot Order #1

► **UEFI Application Boot Priorities**

This feature allows the user to specify which UEFI devices are boot devices.

- UEFI Boot Order #1

## 4.7 Save & Exit

Select the Exit tab from the BIOS setup utility screen to enter the Exit BIOS Setup screen.

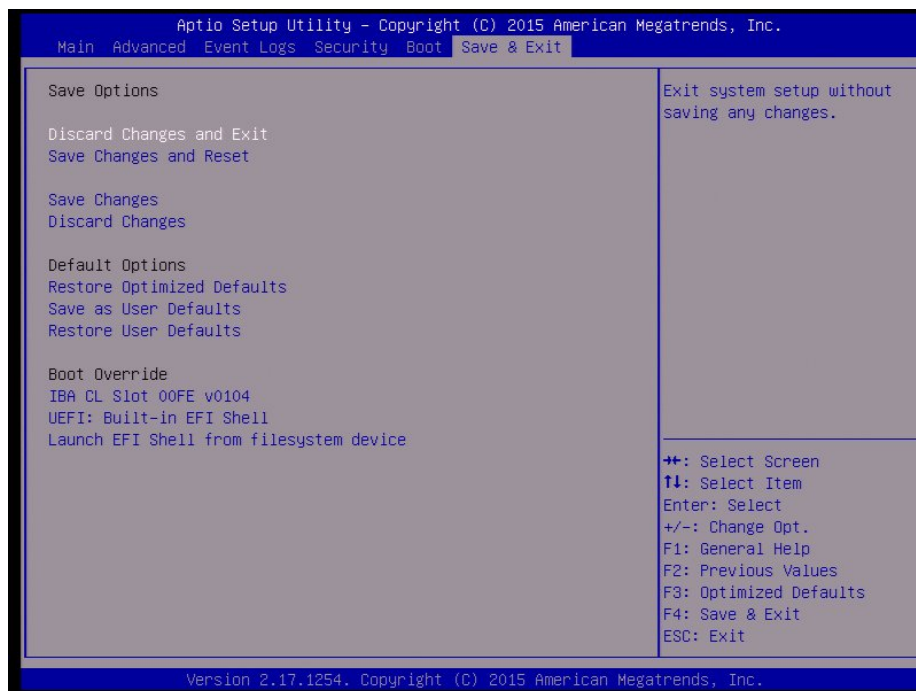

### Discard Changes and Exit

Select this option to quit the BIOS Setup without making any permanent changes to the system configuration, and reboot the computer. Select Discard Changes and Exit from the Exit menu and press <Enter>.

### Save Changes and Reset

When you have completed the system configuration changes, select this option to leave the BIOS setup utility and reboot the computer, so the new system configuration parameters can take effect. Select Save Changes and Exit from the Exit menu and press <Enter>.

### Save Changes

After completing the system configuration changes, select this option to save the changes you have made. This will not reset (reboot) the system.

### Discard Changes

Select this option and press <Enter> to discard all the changes and return to the AMI BIOS utility Program.

## **Default Options**

### **Restore Optimized Defaults**

To set this feature, select Restore Optimized Defaults from the Save & Exit menu and press <Enter>. These are factory settings designed for maximum system stability, but not for maximum performance.

### **Save As User Defaults**

To set this feature, select Save as User Defaults from the Exit menu and press <Enter>. This enables the user to save any changes to the BIOS setup for future use.

### **Restore User Defaults**

To set this feature, select Restore User Defaults from the Exit menu and press <Enter>. Use this feature to retrieve user-defined settings that were saved previously.

### **Boot Override**

Listed on this section are other boot options for the system (i.e., Built-in EFI shell). Select an option and press <Enter>. Your system will boot to the selected boot option.

## Appendix A

### BIOS Codes

#### A.1 BIOS Error POST (Beep) Codes

During the POST (Power-On Self-Test) routines, which are performed each time the system is powered on, errors may occur.

**Non-fatal errors** are those which, in most cases, allow the system to continue the boot-up process. The error messages normally appear on the screen.

**Fatal errors** are those which will not allow the system to continue the boot-up procedure. If a fatal error occurs, you should consult with your system manufacturer for possible repairs.

These fatal errors are usually communicated through a series of audible beeps. The numbers on the fatal error list (on the following page) correspond to the number of beeps for the corresponding error. All errors listed, with the exception of Beep Code 8, are fatal errors.

BIOS Beep (POST) Codes		
Beep Code	Error Message	Description
1 beep	Refresh	Circuits have been reset (Ready to power up)
5 short, 1 long	Memory error	No memory detected in system
5 long, 2 short	Display memory read/write error	Video adapter missing or with faulty memory
1 long continuous	System OH	System overheat condition

## A.2 Additional BIOS POST Codes

The AMI BIOS supplies additional checkpoint codes, which are documented online at <http://www.supermicro.com/support/manuals/> ("AMI BIOS POST Codes User's Guide").

When BIOS performs the Power On Self Test, it writes checkpoint codes to I/O port 0080h. If the computer cannot complete the boot process, a diagnostic card can be attached to the computer to read I/O port 0080h (Supermicro p/n AOC-LPC80-20).

For information on AMI updates, please refer to <http://www.ami.com/products/>.

## Appendix B

### Software

#### B.1 Driver Installation

The Supermicro website that contains drivers and utilities for your system is at <https://www.supermicro.com/wdl/driver/>. Some of these must be installed, such as the chipset driver.

After accessing the website, go into the CDR\_Images (in the parent directory of the above link) and locate the ISO file for your motherboard. Download this file to a USB flash drive or a DVD. (You may also use a utility to extract the ISO file if preferred.)

Another option is to go to the Supermicro website at <http://www.supermicro.com/products/>. Find the product page for your motherboard, and "Download the Latest Drivers and Utilities". Insert the flash drive or disk and the screenshot shown below should appear.

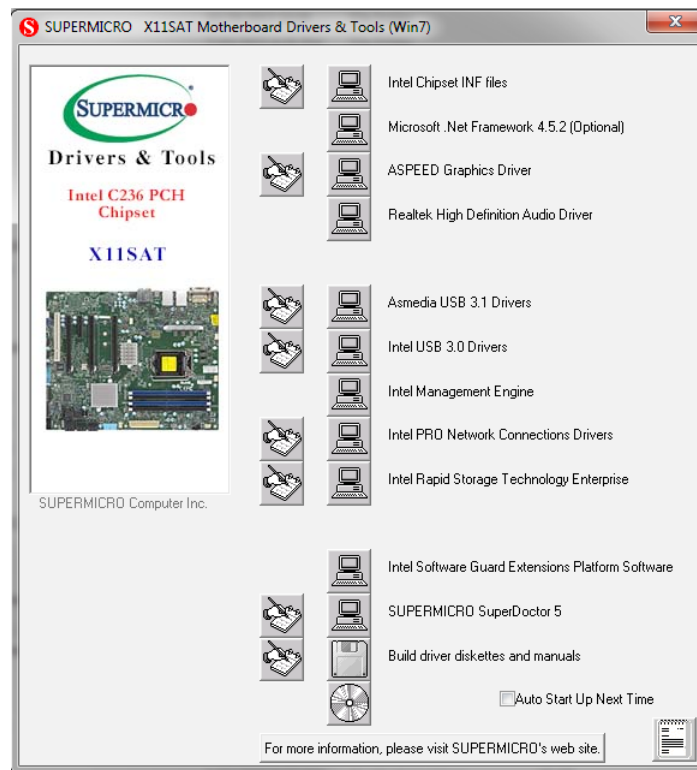

Figure B-1. Driver/Tool Installation Display Screen

**Note:** Click the icons showing a hand writing on paper to view the readme files for each item. Click the computer icons to the right of these items to install each item (from top to bottom) one at a time. **After installing each item, you must reboot the system before moving on to the next item on the list.** The bottom icon with a CD on it allows you to view the entire contents.

## B.2 SuperDoctor 5

The Supermicro SuperDoctor 5 is a program that functions in a command-line or web-based interface for Windows and Linux operating systems. The program monitors such system health information as CPU temperature, system voltages, system power consumption, fan speed, and provides alerts via email or Simple Network Management Protocol (SNMP).

SuperDoctor 5 comes in local and remote management versions and can be used with Nagios to maximize your system monitoring needs. With SuperDoctor 5 Management Server (SSM Server), you can remotely control power on/off and reset chassis intrusion for multiple systems with SuperDoctor 5 or IPMI. SuperDoctor 5 Management Server monitors HTTP and SMTP services to optimize the efficiency of your operation.

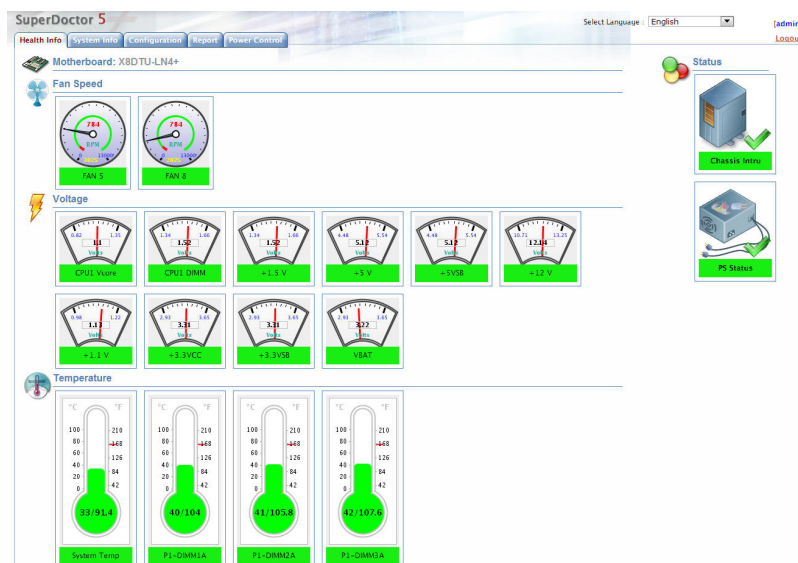

Figure B-2. SuperDoctor 5 Interface Display Screen (Health Information)

## B.3 IPMI

The X11SAT-F supports the Intelligent Platform Management Interface (IPMI). IPMI is used to provide remote access, monitoring and management. There are several BIOS settings that are related to IPMI.

For general documentation and information on IPMI, please visit our website at: <http://www.supermicro.com/products/nfo/IPMI.cfm>.

## B.4 Logging into the BMC (Baseboard Management Controller)

Supermicro ships standard products with a unique password for the BMC user. This password can be found on a label on the motherboard.

When logging in to the BMC for the first time, please use the unique password provided by Supermicro to log in. You can change the unique password to a user name and password of your choice for subsequent logins.

For more information regarding BMC passwords, please visit our website at <http://www.supermicro.com/bmcpassword>.



**Note:** This function is supported by X11SAT-F only.

## Appendix C

### Standardized Warning Statements

The following statements are industry standard warnings, provided to warn the user of situations which have the potential for bodily injury. Should you have questions or experience difficulty, contact Supermicro's Technical Support department for assistance. Only certified technicians should attempt to install or configure components.

Read this section in its entirety before installing or configuring components.

These warnings may also be found on our website at [http://www.supermicro.com/about/policies/safety\\_information.cfm](http://www.supermicro.com/about/policies/safety_information.cfm).

#### Battery Handling



**Warning!** There is the danger of explosion if the battery is replaced incorrectly. Replace the battery only with the same or equivalent type recommended by the manufacturer. Dispose of used batteries according to the manufacturer's instructions

#### 電池の取り扱い

電池交換が正しく行われなかった場合、破裂の危険性があります。交換する電池はメーカーが推奨する型、または同等のものを使用下さい。使用済電池は製造元の指示に従って処分して下さい。

#### 警告

電池更換不當會有爆炸危險。請只使用同類電池或制造商推薦的功能相當的電池更換原有電池。請按製造商的說明處理廢舊電池。

#### 警告

電池更換不當會有爆炸危險。請使用製造商建議之相同或功能相當的電池更換原有電池。請按照製造商的說明指示處理廢棄舊電池。

#### Warnung

Bei Einsetzen einer falschen Batterie besteht Explosionsgefahr. Ersetzen Sie die Batterie nur durch den gleichen oder vom Hersteller empfohlenen Batterietyp. Entsorgen Sie die benutzten Batterien nach den Anweisungen des Herstellers.

#### Attention

Danger d'explosion si la pile n'est pas remplacée correctement. Ne la remplacer que par une pile de type semblable ou équivalent, recommandée par le fabricant. Jeter les piles usagées conformément aux instructions du fabricant.

#### ¡Advertencia!

Existe peligro de explosión si la batería se reemplaza de manera incorrecta. Reemplazar la batería exclusivamente con el mismo tipo o el equivalente recomendado por el fabricante. Desechar las baterías gastadas según las instrucciones del fabricante.

#### אזהרה!

קיימת סכנת פיצוץ של הסוללה במידה והוחלפה בדרך לא תקינה. יש להחליף את הסוללה בסוג התואם מחברת יצרן מומלצת.

סילוק הסוללות המשומשות יש לבצע לפי הוראות היצרן.

هناك خطر من انفجار في حالة استبدال البطارية بطريقة غير صحيحة فعليك استبدال البطارية فقط بنفس النوع أو ما يعادلها كما أوصت به الشركة المصنعة تخلص من البطاريات المستعملة وفقا لتعليمات الشركة الصانعة

#### 경고!

배터리가 올바르게 교체되지 않으면 폭발의 위험이 있습니다. 기존 배터리와 동일하거나 제조사에서 권장하는 동등한 종류의 배터리로만 교체해야 합니다. 제조사의 안내에 따라 사용된 배터리를 처리하여 주십시오.

#### Waarschuwing

Er is ontploffingsgevaar indien de batterij verkeerd vervangen wordt. Vervang de batterij slechts met hetzelfde of een equivalent type die door de fabrikant aanbevolen wordt. Gebruikte batterijen dienen overeenkomstig fabrieksvoorschriften afgevoerd te worden.

## Product Disposal



**Warning!** Ultimate disposal of this product should be handled according to all national laws and regulations.

### 製品の廃棄

この製品を廃棄処分する場合、国の関係する全ての法律・条例に従い処理する必要があります。

### 警告

本产品的废弃处理应根据所有国家的法律和规章进行。

### 警告

本產品的廢棄處理應根據所有國家的法律和規章進行。

### Warnung

Die Entsorgung dieses Produkts sollte gemäß allen Bestimmungen und Gesetzen des Landes erfolgen.

### ¡Advertencia!

Al deshacerse por completo de este producto debe seguir todas las leyes y reglamentos nacionales.

### Attention

La mise au rebut ou le recyclage de ce produit sont généralement soumis à des lois et/ou directives de respect de l'environnement. Renseignez-vous auprès de l'organisme compétent.

### סילוק המוצר

אזהרה!

סילוק סופי של מוצר זה חייב להיות בהתאם להנחיות וחוקי המדינה.

عند التخلص النهائي من هذا المنتج ينبغي التعامل معه وفقا لجميع القوانين واللوائح الوطنية

### 경고!

이 제품은 해당 국가의 관련 법규 및 규정에 따라 폐기되어야 합니다.

### Waarschuwing

De uiteindelijke verwijdering van dit product dient te geschieden in overeenstemming met alle nationale wetten en reglementen.

## Appendix D

### UEFI BIOS Recovery

**Warning:** Do not upgrade the BIOS unless your system has a BIOS-related issue. Flashing the wrong BIOS can cause irreparable damage to the system. In no event shall Supermicro be liable for direct, indirect, special, incidental, or consequential damages arising from a BIOS update. If you need to update the BIOS, do not shut down or reset the system while the BIOS is updating. Doing so may cause a boot failure.

#### D.1 Overview

The Unified Extensible Firmware Interface (UEFI) provides a software-based interface between the operating system and the platform firmware in the pre-boot environment. The UEFI specification supports an architecture-independent mechanism for an external storage device initialization to allow the UEFI OS loader, which is stored in the external storage device, to boot the system. The UEFI offers clean, hands-off control to a computer system at bootup.

#### D.2 Recovering the UEFI BIOS Image

A UEFI BIOS flash chip consists of a recovery BIOS block and a main BIOS block (a main BIOS image). The boot block contains critical BIOS codes, including memory detection and recovery codes for the user to flash a new BIOS image if the original main BIOS image is corrupted. When the system power is on, the boot block codes execute first. Once it is completed, the main BIOS code will continue with system initialization and bootup.

 **Note:** Follow the BIOS recovery instructions below for BIOS recovery when the main BIOS boot crashes. However, if the BIOS boot block crashes, you will need to follow the procedures below for BIOS recovery.

#### D.3 Recovering the BIOS Block with a USB Device

This feature allows the user to recover a BIOS image using a USB-attached device without the need for additional utilities. A USB flash device such as a USB flash drive or a USB CD/DVD device can be used for this purpose. A USB hard disk drive cannot be used for BIOS recovery at this time. The file system supported by UEFI is FAT (including FAT12, FAT16, and FAT32) installed on a bootable or non-bootable USB-attached device.

To perform UEFI BIOS recovery using a USB-attached device, follow the instructions below.

1. If you have the SUPER.ROM file in your drive disk, the BIOS might need several minutes to locate the SUPER.ROM file if the media size becomes too large due to the huge volumes of folders and files stored in the device. You can also use a different machine and visit our website at [www.supermicro.com](http://www.supermicro.com) to download the BIOS package. Extract the BIOS package to a DOS bootable device. Use the same or another USB-attached device to make a copy of the standard BIOS binary image file and rename it to SUPER.ROM (not case sensitive) for the BIOS recovery use. Copy the SUPER.ROM file into the Root "\" directory of a USB device or a writable CD/DVD.



**Note:** Before recovering the main BIOS image, confirm that the SUPER.ROM file you have is the same version or a close version meant for your motherboard.

2. Insert the USB device that contains the SUPER.ROM file and power on the system.
3. While powering on the system, please keep pressing <Ctrl> and <Home> simultaneously until you hear the beep sound.

**Warning:** Please stop pressing the <Ctrl> and <Home> keys immediately when you hear the beep sound; otherwise, it will trigger a system reboot.

4. After locating the SUPER.ROM file, the system will enter the BIOS Recovery menu as shown below.



 **Note:** At this point, you may decide if you want to start the BIOS recovery. If you decide to proceed with BIOS recovery, follow the procedures below.

5. When the screen as shown above displays, use the arrow keys to select the item "Proceed with flash update" and press the <Enter> key. You will see the BIOS recovery progress as shown in the screen below.

 **Note:** Do not interrupt the BIOS flashing process until it has completed.

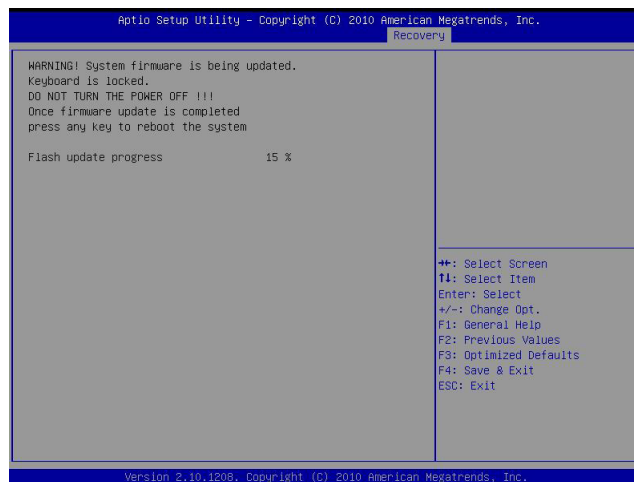

6. After the BIOS recovery process has completed, press any key to reboot the system.

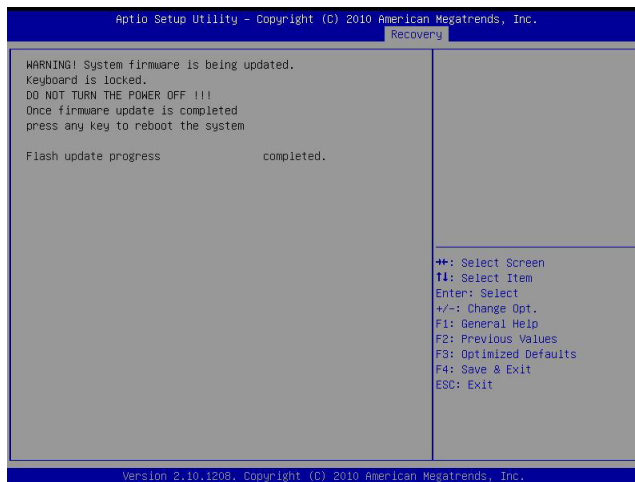

 **Note:** Before rebooting the system, be sure to insert the DOS bootable device that contains the BIOS package you extracted earlier from Step 1.

7. When the DOS prompt appears, enter `flash.bat BIOSname#.###` at the prompt.

 **Note:** Do not interrupt this process until the BIOS flashing is complete.

8. After seeing the message that BIOS update has completed (refer to the screen below), reboot the system.

```

AMI Firmware Update Utility v5.06.00
Copyright (C)2014 American Megatrends Inc. All Rights Reserved.
-----
Reading Flash ..... done
- ME Data Size checking . ok
- FFS checksums ..... ok
Erasing Boot Block ..... done
Updating Boot Block ..... done
Verifying Boot Block ..... done
Erasing Main Block ..... done
Updating Main Block ..... done
Verifying Main Block ..... done
Erasing NVRAM Block ..... done
Updating NVRAM Block ..... done
Verifying NVRAM Block ..... done
Erasing MCB Block ..... done
Updating MCB Block ..... done
Verifying MCB Block ..... done
- FDT won't be updated when ME is not in Manufacturing mode!!
  BIOS upgrade continues...
- Successful Update Recovery Loader to DPRx!!
- Successful Update FPT, MFSB, FTPR and MFS!!
- ME Entire Image update success !!
WARNING : System must power-off to have the changes take effect!
C:\X10DR1\NDOS>

```