



X11DPS-RE

USER'S MANUAL

Revision 1.1b

The information in this user's manual has been carefully reviewed and is believed to be accurate. The vendor assumes no responsibility for any inaccuracies that may be contained in this document, and makes no commitment to update or to keep current the information in this manual, or to notify any person or organization of the updates. **Please Note: For the most up-to-date version of this manual, please see our website at www.supermicro.com.**

Super Micro Computer, Inc. ("Supermicro") reserves the right to make changes to the product described in this manual at any time and without notice. This product, including software and documentation, is the property of Supermicro and/or its licensors, and is supplied only under a license. Any use or reproduction of this product is not allowed, except as expressly permitted by the terms of said license.

IN NO EVENT WILL SUPER MICRO COMPUTER, INC. BE LIABLE FOR DIRECT, INDIRECT, SPECIAL, INCIDENTAL, SPECULATIVE OR CONSEQUENTIAL DAMAGES ARISING FROM THE USE OR INABILITY TO USE THIS PRODUCT OR DOCUMENTATION, EVEN IF ADVISED OF THE POSSIBILITY OF SUCH DAMAGES. IN PARTICULAR, SUPER MICRO COMPUTER, INC. SHALL NOT HAVE LIABILITY FOR ANY HARDWARE, SOFTWARE, OR DATA STORED OR USED WITH THE PRODUCT, INCLUDING THE COSTS OF REPAIRING, REPLACING, INTEGRATING, INSTALLING OR RECOVERING SUCH HARDWARE, SOFTWARE, OR DATA.

Any disputes arising between manufacturer and customer shall be governed by the laws of Santa Clara County in the State of California, USA. The State of California, County of Santa Clara shall be the exclusive venue for the resolution of any such disputes. Supermicro's total liability for all claims will not exceed the price paid for the hardware product.

FCC Statement: This equipment has been tested and found to comply with the limits for a Class A digital device pursuant to Part 15 of the FCC Rules. These limits are designed to provide reasonable protection against harmful interference when the equipment is operated in an industrial environment. This equipment generates, uses, and can radiate radio frequency energy and, if not installed and used in accordance with the manufacturer's instruction manual, may cause harmful interference with radio communications. Operation of this equipment in a residential area is likely to cause harmful interference, in which case you will be required to correct the interference at your own expense.

California Best Management Practices Regulations for Perchlorate Materials: This Perchlorate warning applies only to products containing CR (Manganese Dioxide) Lithium coin cells. "Perchlorate Material-special handling may apply. See www.dtsc.ca.gov/hazardouswaste/perchlorate".



WARNING: This product can expose you to chemicals including lead, known to the State of California to cause cancer and birth defects or other reproductive harm. For more information, go to www.P65Warnings.ca.gov.

The products sold by Supermicro are not intended for and will not be used in life support systems, medical equipment, nuclear facilities or systems, aircraft, aircraft devices, aircraft/emergency communication devices or other critical systems whose failure to perform be reasonably expected to result in significant injury or loss of life or catastrophic property damage. Accordingly, Supermicro disclaims any and all liability, and should buyer use or sell such products for use in such ultra-hazardous applications, it does so entirely at its own risk. Furthermore, buyer agrees to fully indemnify, defend and hold Supermicro harmless for and against any and all claims, demands, actions, litigation, and proceedings of any kind arising out of or related to such ultra-hazardous use or sale.

Manual Revision 1.1b

Release Date: September 18, 2020

Unless you request and receive written permission from Super Micro Computer, Inc., you may not copy any part of this document. Information in this document is subject to change without notice. Other products and companies referred to herein are trademarks or registered trademarks of their respective companies or mark holders.

Copyright © 2020 by Super Micro Computer, Inc.
All rights reserved.

Printed in the United States of America

Preface

About This Manual

This manual is written for system integrators, IT technicians, and knowledgeable end users. It provides information for the installation and use of the X11DPS-RE motherboard.

About This Motherboard

The X11DPS-RE motherboard supports dual Intel® Xeon Scalable-SP and 2nd Generation Intel® Xeon Scalable-SP processors (Socket P) with a TDP (Thermal Design Power) of up to 205W, and 3 UPIs (UltraPath Interconnects) of up to 10.4 GT/s. With the Intel C627 chipset built-in, this motherboard supports up to 6TB of LRDIMM/RDIMM/NVDIMM DDR4 ECC 2933*/2666/2400/2133 MHz memory in 24 DIMM slots (***Note 2** below), and it comes with four SATA 3.0 ports, two SATA DOM ports, and two PCIe/SATA Hybrid M.2 ports. The cutting-edge X11DPS-RE offers highly versatile NVMe options with an array of flexible PCIe solutions. It also supports up to 9TB memory with DCPMM modules installed. This motherboard is optimized for storage-intensive and high-performance systems with demanding workloads. Please note that this motherboard is intended to be installed and serviced by professional technicians only. For processor/memory updates, please refer to our website at <http://www.supermicro.com/products/>.



Notes: 1. UPI/memory speeds are dependent on the processors installed in your system. 2. Support for 2933MHz memory is dependent on the CPU SKU.

Manual Organization

Chapter 1 describes the features, specifications and performance of the motherboard, and provides detailed information on the Intel C627 chipset.

Chapter 2 provides hardware installation instructions. Read this chapter when installing the processor, memory modules, and other hardware components into the system.

Chapter 3 describes troubleshooting procedures for video, memory, and system setup stored in the CMOS.

Chapter 4 includes an introduction to the BIOS, and provides detailed information on running the CMOS Setup utility.

Appendix A provides BIOS Error Beep Codes information.

Appendix B lists software program installation instructions.

Appendix C lists standardized warning statements in various languages.

Appendix D provides UEFI BIOS Recovery instructions.

Appendix E provides information on how to configure secure boot settings.

Appendix F provides information on how to configure VROC RAID settings.

Appendix G provides information on how to configure Network Interface Card (NIC) settings.

Appendix H provides information on how to configure iSCSI settings.

Contacting Supermicro

Headquarters

Address: Super Micro Computer, Inc.
980 Rock Ave.
San Jose, CA 95131 U.S.A.

Tel: +1 (408) 503-8000

Fax: +1 (408) 503-8008

Email: marketing@supermicro.com (General Information)
support@supermicro.com (Technical Support)

Website: www.supermicro.com

Europe

Address: Super Micro Computer B.V.
Het Sterrenbeeld 28, 5215 ML
's-Hertogenbosch, The Netherlands

Tel: +31 (0) 73-6400390

Fax: +31 (0) 73-6416525

Email: sales@supermicro.nl (General Information)
support@supermicro.nl (Technical Support)
rma@supermicro.nl (Customer Support)

Website: www.supermicro.nl

Asia-Pacific

Address: Super Micro Computer, Inc.
3F, No. 150, Jian 1st Rd.
Zhonghe Dist., New Taipei City 235
Taiwan (R.O.C)

Tel: +886-(2) 8226-3990

Fax: +886-(2) 8226-3992

Email: support@supermicro.com.tw

Website: www.supermicro.com.tw

Table of Contents

Chapter 1 Introduction

| | |
|---|----|
| 1.1 Check List..... | 8 |
| 1.2 Processor and Chipset Overview..... | 18 |
| 1.3 Special Features | 19 |
| 1.4 System Health Monitoring | 19 |
| 1.5 ACPI Features..... | 20 |
| 1.6 Power Supply | 20 |
| 1.7 Advanced Power Management | 20 |
| Intel® Intelligent Power Node Manager (IPNM)..... | 20 |
| Management Engine (ME) | 21 |
| Intel® QuickAssist Technology..... | 21 |
| 1.8 Intel® Optane DC Persistent Memory Overview | 21 |

Chapter 2 Installation

| | |
|--|----|
| 2.1 Static-Sensitive Devices..... | 22 |
| 2.2 Motherboard Installation..... | 23 |
| 2.3 Processor and Heatsink Installation..... | 25 |
| 2.4 Memory Support and Installation | 33 |
| 2.5 Rear I/O Ports | 41 |
| 2.6 Front Control Panel..... | 45 |
| 2.7 Connectors | 51 |
| 2.8 Jumper Settings | 60 |
| 2.9 LED Indicators..... | 66 |

Chapter 3 Troubleshooting

| | |
|--|-----|
| 3.1 Troubleshooting Procedures | 69 |
| 3.2 Technical Support Procedures | 73 |
| 3.3 Frequently Asked Questions | 74 |
| 3.4 Battery Removal and Installation | 76 |
| 3.5 Returning Merchandise for Service..... | 77 |
| 4.1 Introduction..... | 78 |
| 4.2 Main Setup | 79 |
| 4.3 Advanced Setup Configurations..... | 81 |
| 4.4 Event Logs | 128 |
| 4.5 IPMI | 130 |

| | |
|---|-----|
| 4.6 Security Settings | 133 |
| 4.7 Boot Settings | 137 |
| 4.8 Save & Exit..... | 140 |
| Appendix A BIOS Codes | |
| A.1 BIOS Error POST (Beep) Codes | 142 |
| Appendix B Software | |
| B.1 Microsoft Windows OS Installation | 144 |
| B.2 Driver Installation..... | 146 |
| B.3 SuperDoctor® 5..... | 147 |
| B.4 IPMI | 148 |
| B.5 Logging into the BMC (Baseboard Management Controller)..... | 148 |
| Appendix C Standardized Warning Statements | |
| Appendix D UEFI BIOS Recovery | |
| D.1 Overview..... | 152 |
| D.2 Recovering the UEFI BIOS Image | 152 |
| D.3 Recovering the Main BIOS Block with a USB Device | 153 |
| E.1 All Intel VMD Controllers Menu..... | 157 |
| E.2 Configuring RAID Settings | 161 |
| E.3 Use of Journaling Drive..... | 177 |
| Appendix F Secure Boot Settings | |
| F.1 Boot mode select Feature | 181 |
| F.2 Secure Boot/ Secure Boot Mode/ CSM Support Features | 182 |
| F.3 Secure Boot Settings | 183 |
| F.4 Key Management Settings | 186 |
| Appendix G Configuring iSCSI Settings | |
| G.1 PCIe/PCI/PnP Features..... | 203 |
| G.2 Configuring iSCSI Settings..... | 206 |
| Appendix H Configuring Network Interface Card (NIC) Settings | |
| H.1 Network Interface Card (NIC) Settings | 225 |

Chapter 1

Introduction

Congratulations on purchasing your computer motherboard from an industry leader. Supermicro motherboards are designed to provide you with the highest standards in quality and performance.

1.1 Check List

This motherboard was designed to be used in an SMCI-proprietary chassis only as a part of an integrated, complete system solution. It is not to be sold as an independent, standalone product; therefore, no shipping package will be included in the shipment.

Important Links

For your system to work properly, please follow the links below to download all necessary drivers/utilities and the user's manual for your motherboard.

- Supermicro product manuals: <http://www.supermicro.com/support/manuals/>
- Product drivers and utilities: <http://www.supermicro.com/wftp>
- Product safety info: http://www.supermicro.com/about/policies/safety_information.cfm
- If you have any questions, please contact our support team at: support@supermicro.com
- A secure data deletion tool designed to fully erase all data from storage devices can be found at our website: https://www.supermicro.com/about/policies/disclaimer.cfm?url=/wftp/utility/Lot9_Secure_Data_Deletion_Utility/

This manual may be periodically updated without notice. Please check the Supermicro website for possible updates to the manual revision level.

X11DPS-RE Motherboard Image

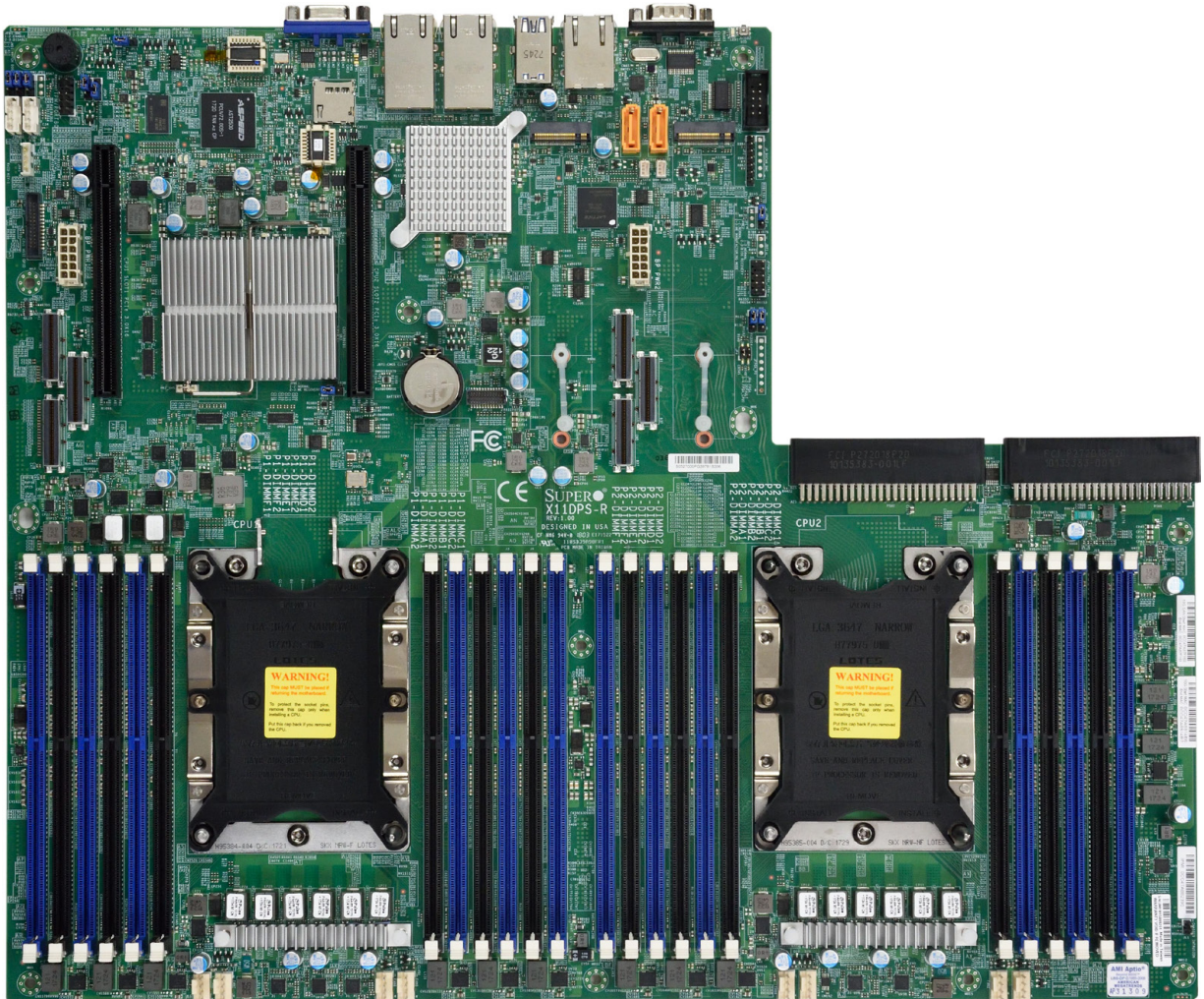

 **Note:** All graphics shown in this manual were based upon the latest PCB revision available at the time of publication of the manual. The components in the motherboard you received may or may not look exactly the same as the graphics shown in this manual.

X11DPS-RE Motherboard Layout (not drawn to scale)

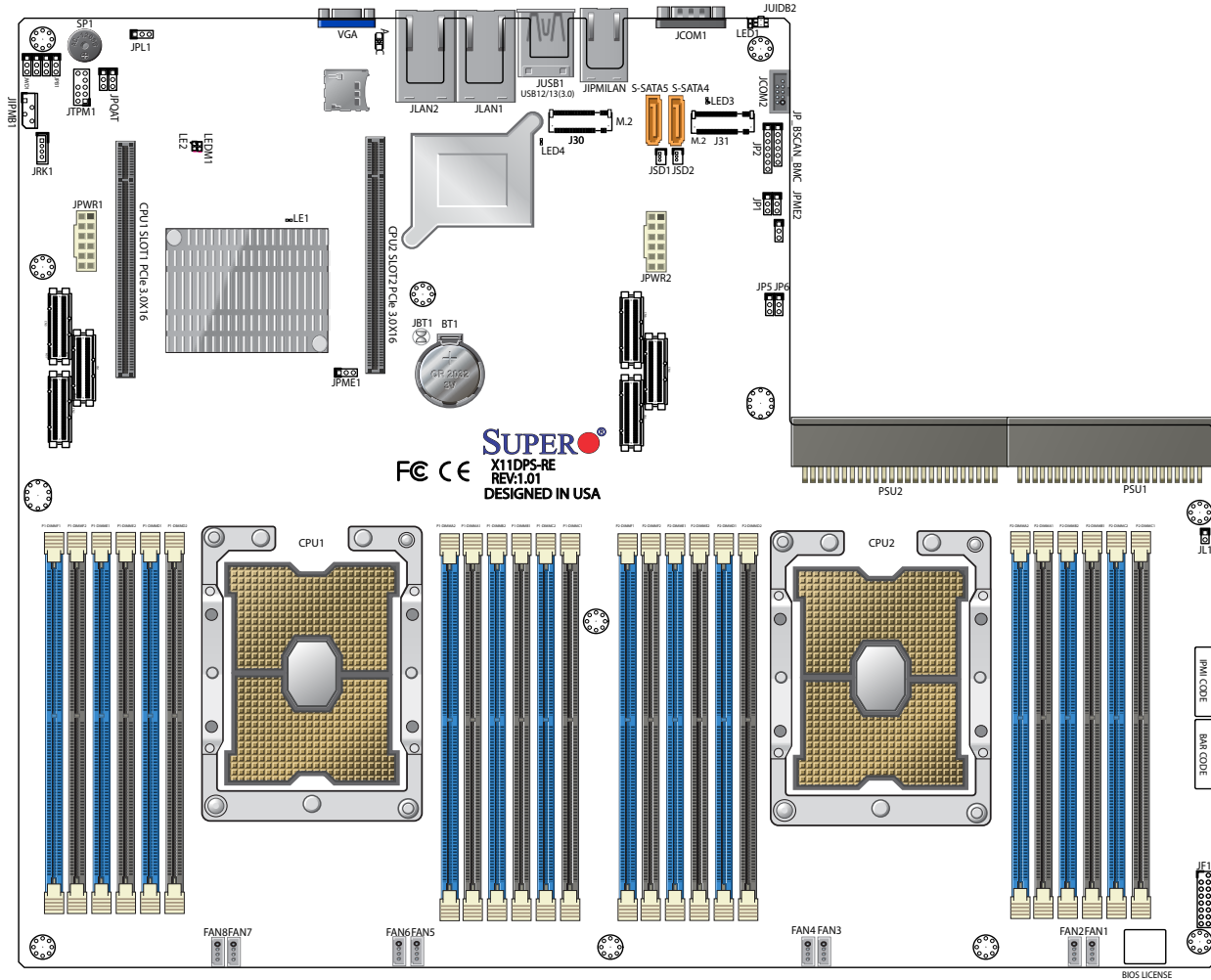

Note: Components not documented are for internal testing only.

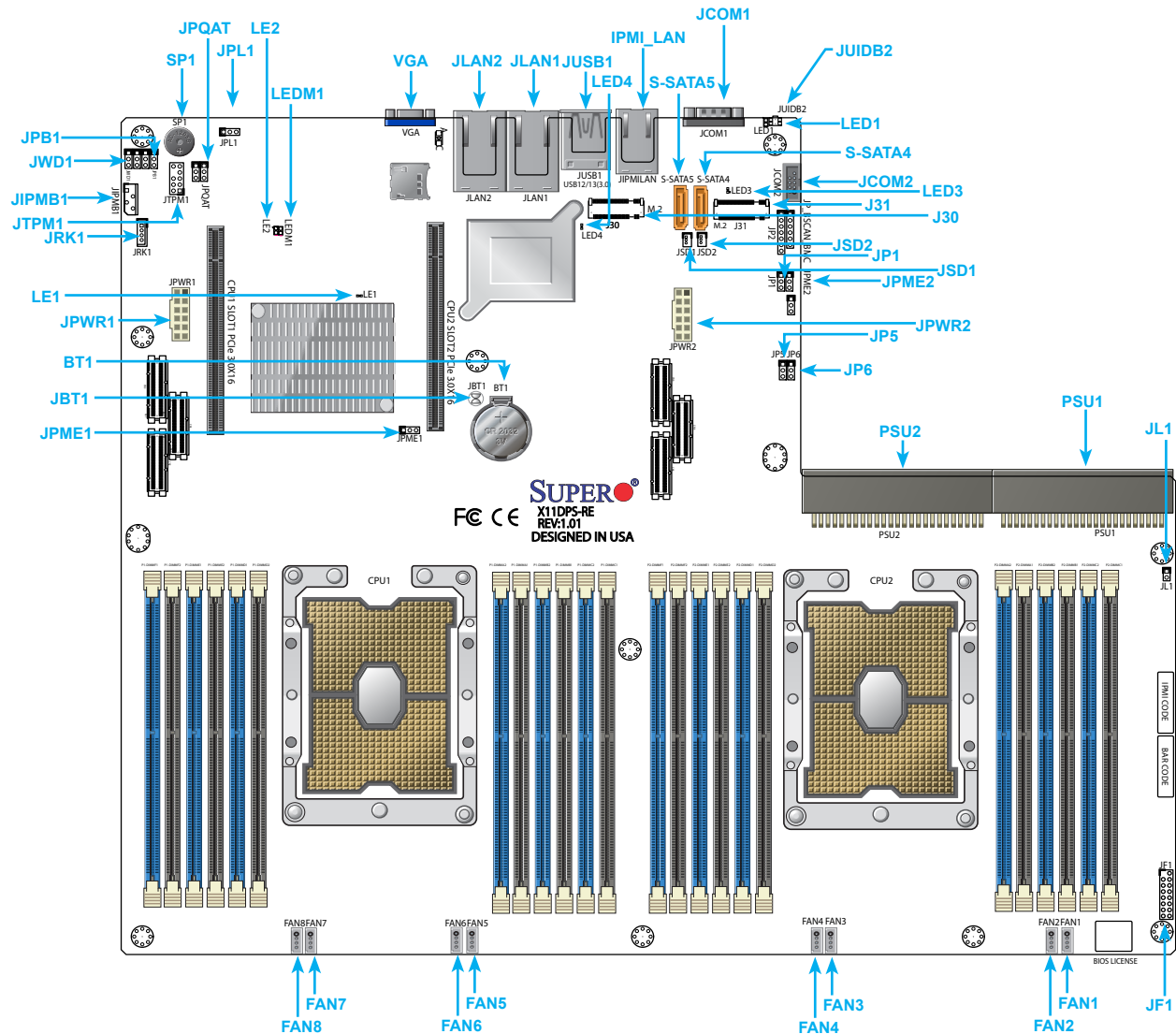

Notes:

- See Chapter 2 for detailed information on jumpers, I/O ports, and JF1 front panel connections.
- "■" indicates the location of Pin 1.
- Jumpers/LED indicators not indicated are used for testing only.
- To avoid causing interference with other components, please be sure to use an add-on card that is fully compliant with the PCI-standard on a PCI slot.
- Use only the correct type of onboard CMOS battery as specified by the manufacturer. Do not install the onboard battery upside down to avoid possible explosion.

Quick Reference Table

| Jumper | Description | Default Setting |
|--------|---|--------------------|
| JBT1 | CMOS Clear | Open (Normal) |
| JP1 | BIOS Advance Function | Pins 2-3 (Normal) |
| JP5 | BMC Power Button Ready Test Header | Pins 1-2 (Normal) |
| JPB1 | BMC Enable/Disable | Pins 1-2 (Enabled) |
| JPL1 | GLAN Enable/Disable | Pins 1-2 (Enabled) |
| JPME1 | ME Recovery | Pins 1-2 (Normal) |
| JPME2 | Manufacturing Mode | Pins 1-2 (Normal) |
| JPQAT | QAT (QuickAssist Technology) Enable/Disable | Pins 1-2 (Enabled) |
| JWD1 | Watch Dog Timer Enable | Pins 1-2 (Reset) |



| LED | Description | Status |
|-------|---------------------------------|-----------------------------|
| LE1 | CPLD Heartbeat LED | Blinking Green: Normal |
| LE2 | Onboard Power LED | Solid Green: Power on |
| LED1 | UID LED | Solid Blue: Unit Identified |
| LED3 | PCIe/SATA Hybrid M.2 SLOT 1 LED | Blinking Green: M.2 Active |
| LED4 | PCIe/SATA Hybrid M.2 SLOT 2 LED | Blinking Green: M.2 Active |
| LEDM1 | BMC Heartbeat LED | Blinking Green: Normal |

| Connector | Description |
|------------------|---|
| BT1 | Onboard CMOS battery |
| FAN1 ~ FAN8 | System/CPU fan headers (FAN1: CPU Fan) |
| J30 | PCIe/SATA Hybrid M.2 Slot 1 |
| J31 | PCIe/SATA Hybrid M.2 Slot 2 |
| JCOM1/JCOM2 | COM ports |
| JF1 | Front control panel header |
| JIPMB1 | 4-pin external I ² C header (for an IPMI card) |
| JIPMILAN | IPMI-Dedicated LAN port |
| JL1 | Chassis intrusion header (Note: Please connect a cable from the Chassis Intrusion header at JL1 to the chassis to receive an alert via IPMI.) |
| JLAN1/JLAN2 | 10G LAN ports 1 and 2 |
| JPWR1/JPWR2 | Backplane power connectors |
| JRK1 | Intel VROC RAID key header for NVMe Solid State Devices (SSD) |
| JSD1 - JSD2 | SATA Disk-On-Module (DOM) power connectors |
| JTPM1 TPM/PORT80 | Port 80 connector for Trusted Platform Module (TPM) |
| JUIDB2 | Unit Identifier (UID) switch |
| JUSB1 (3.0) | USB 3.0 rear ports (USB12/13) |

| Connector | Description |
|-----------|--|
| PSU1 | Power Supply Unit 1 |
| PSU2 | Power Supply Unit 2 |
| S-SATA4~5 | (Powered) SATA connectors with power-pins built-in with support of SuperDOMs |
| VGA | VGA port |

 **Note:** To avoid causing interference with other components, please be sure to use an add-on card that is fully compliant with the PCI-standard on a PCI slot.

Motherboard Features

| Motherboard Features | |
|---|---|
| CPU | |
| <ul style="list-style-type: none"> Dual Intel Xeon Scalable-SP or 2nd Gen Intel Xeon Scalable-SP processors (Socket P) with support of 3 Intel UltraPath Interconnects (UPIs) links of up to 10.4 GT/s  Note: Both CPUs need to be installed for full access to the PCIe slots, DIMM slots, and onboard controllers. Refer to the block diagram on page 18 to determine which slots or devices may be affected. | |
| Memory | |
| <ul style="list-style-type: none"> The X11DPS-RE supports up to 6TB of LRDIMM/RDIMM/NVDIMM DDR4 ECC 2933*/2666/2400/2133 MHz memory in 24 memory slots. (*Notes: 1. 2933 MHz memory is supported by the 82xx/62xx series processors only. 2. Up to 9TB memory is supported with DCPMM modules installed.) | |
| DIMM Size | |
| <ul style="list-style-type: none"> Up to 128GB at 1.2V  Note 1: Memory speed support depends on the processors used in the system.  Note 2: For the latest CPU/memory updates, please refer to our website at http://www.supermicro.com/products/motherboard . | |
| Chipset | |
| <ul style="list-style-type: none"> Intel C627 | |
| Expansion Slots | |
| <ul style="list-style-type: none"> 2 PCIe 3.0 x32 Tray cable connector interface 2 PCIe 3.0 x16 slots with riser card support | |
| Network | |
| <ul style="list-style-type: none"> Dual RJ45 10G LAN ports | |
| BaseBoard Management Controller (BMC) | |
| <ul style="list-style-type: none"> ASPEED AST 2500 Baseboard Management Controller (BMC) supports IPMI 2.0 One (1) dedicated IPMI_LAN located on the rear IO backpanel | |
| Graphics | |
| <ul style="list-style-type: none"> Graphics controller via ASPEED AST2500 | |
| I/O Devices | |
| <ul style="list-style-type: none"> Serial (COM) Port | <ul style="list-style-type: none"> Two (2) serial-port header |
| <ul style="list-style-type: none"> SATA 3.0 | <ul style="list-style-type: none"> Total of 4 SATA 3 ports: Two (2) SATA DOM connectors (S-SATA4, S-SATA5) Two (2) PCIe/SATA Hybrid M.2 connections |



Note: The table above is continued on the next page.

| Motherboard Features |
|--|
| <p>Peripheral Devices</p> <ul style="list-style-type: none"> Two (2) USB 3.0 ports on the rear I/O panel (USB 12/13) |
| <p>BIOS</p> <ul style="list-style-type: none"> 32 Mb SPI AMI BIOS® SM Flash UEFI BIOS ACPI 3.0 or later, PCI F/W 3.0, SMBIOS 2.7 or later |
| <p>Power Management</p> <ul style="list-style-type: none"> ACPI power management (S4, S5) Power-on mode for AC power recovery Power button override mechanism |
| <p>System Health Monitoring</p> <ul style="list-style-type: none"> Onboard voltage monitoring for +1.8V, +3.3V, +5V, +/-12V, +3.3V Stdbby, +5V Stdbby, HT, Memory, PCH Temp, System Temp, Memory Temp 5 CPU (# of switching-phase voltage regulator) CPU/system overheat LED and control CPU Thermal Trip support PECI / TSI CPU Thermal Design Power (TDP) support of up to 165W |
| <p>Fan Control</p> <ul style="list-style-type: none"> Eight 4-pin fan headers Multi-speed fan control via onboard BMC |
| <p>System Management</p> <ul style="list-style-type: none"> Trusted Platform Module (TPM) support Watch Dog / Non-maskable interrupt RoHS BMC SD Card Slot Chassis intrusion header and detection (JL1) (Note: Please connect a cable from the Chassis Intrusion header at JL1 to the chassis to receive an alert via IPMI.) |
| <p>LED Indicators</p> <ul style="list-style-type: none"> CPU/Overheating Power/Suspend-state indicator Fan Failure UID/Remote UID HDD Activity LAN Activity |
| <p>Dimensions</p> <ul style="list-style-type: none"> 13.5" (L) x 16.73" (W) (342.9 mm x 424.94 mm) |

 **Note 1:** The CPU maximum thermal design power (TDP) is subject to chassis and heatsink cooling restrictions. For proper thermal management, please check the chassis and heatsink specifications for proper CPU TDP sizing.

Note 2: For IPMI configuration instructions, please refer to the Embedded IPMI Configuration User's Guide available at <http://www.supermicro.com/support/manuals/>.

Note 3: It is strongly recommended that you change BMC login information upon initial system power-on. The manufacturer default username is ADMIN and the password is ADMIN. For proper BMC configuration, please refer to http://www.supermicro.com/products/info/files/IPMI/Best_Practices_BMC_Security.pdf

**Figure 1-3.
System Block Diagram**

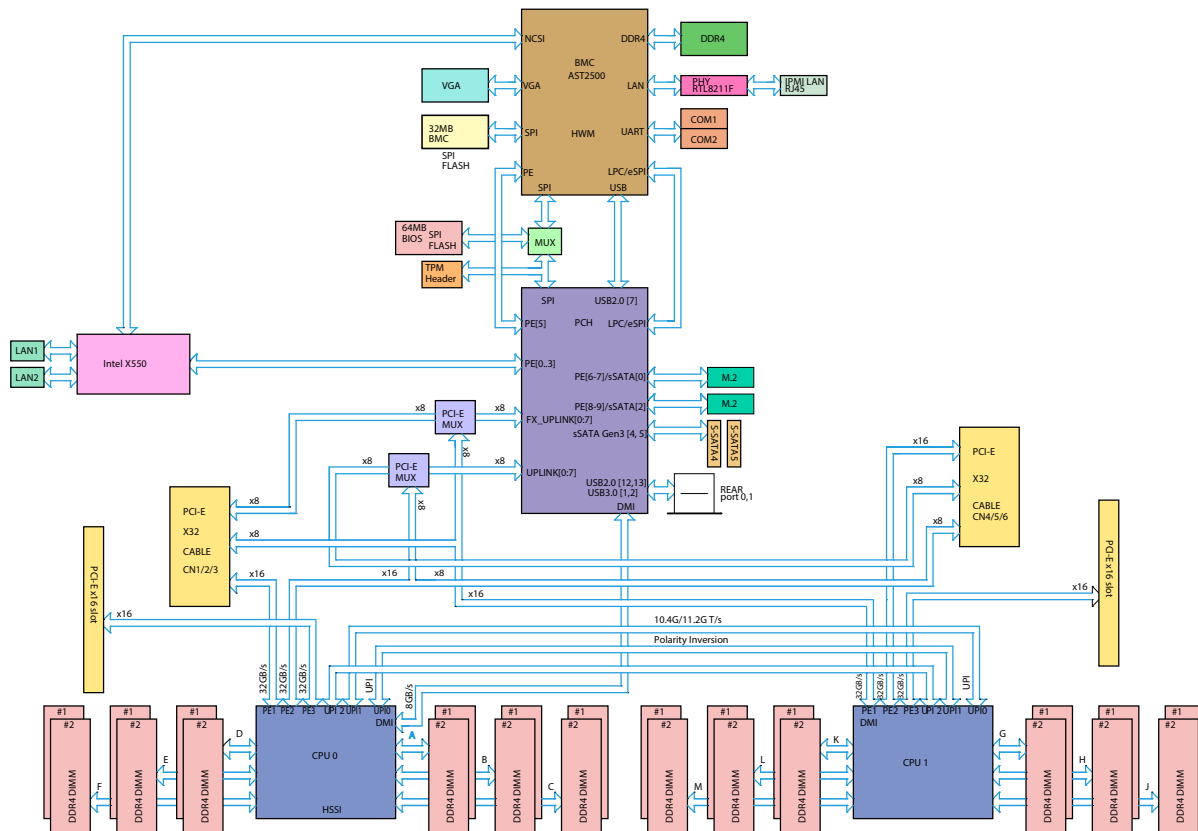

 **Note:** This is a general block diagram and may not exactly represent the features on your motherboard. See the previous pages for the actual specifications of your motherboard.

1.2 Processor and Chipset Overview

Built upon the functionality and capability of Intel Xeon Scalable-SP and 2nd Generation Intel Xeon Scalable-SP processors (Socket P) and the Intel C627 chipset, the X11DPS-RE motherboard provides advanced storage solutions and a rich feature set based on cutting edge technology to address the needs of next-generation computer users. With the support of 3 UPIs (Intel® UltraPath Interconnects) of up to 10.4 GT/s, new Intel® AVX-512 instructions, and Intel® QuickAssist Technology, this motherboard offers maximum NVMe storage capabilities in a 1U form factor, and excellent system performance to meet the ongoing demands of High Performance Computing (HPC) platforms. This motherboard is optimized for big data platforms and Intel storage systems.

Features Supported by Intel Xeon Scalable-SP Processors

Intel Xeon Scalable-SP processors support the following features:

- Intel AVX-512 instruction support to handle complex workloads
- 1.5x memory bandwidth increased to 6 channels
- Hot plug and enclosure management with Intel Volume Management Device (Intel VMD)
- Rich set of available IOs with increased PCIe lanes (48 lanes)
- Integrated Intel Ethernet Connection X722 with iWARP RDM

New features supported by 2nd Gen Intel Xeon Scalable-SP Processors

2nd Gen Intel Xeon Scalable-SP processors support the following features:

- Higher performance for a wider range of workloads with per-core performance increase
- Support of Optane DC Persistent Memory (DCPMM) with affordable, persistent, and large capacity
- Up to 2993 MHz memory supported (Refer to **Section 1.8** for details.)
- Vector Neural Network Instruction (VNNI) support for Accelerate Deep Learning & Artificial Intelligence (AI) workloads
- Speed Select Technology provides multiple CPU profiles that can be set in the BIOS. (This feature is available on select CPU SKUs)
- Seamless hardware security mitigations & performance/frequency flexibility



Note: DCPMM memory and 2933 MHz memory are supported by 2nd Gen Intel Xeon Scalable-SP processors only.

1.3 Special Features

This section describes the health monitoring features of the X11DPS-RE motherboard. The motherboard has an onboard System Hardware Monitor chip that supports system health monitoring.

Recovery from AC Power Loss

The Basic I/O System (BIOS) provides a setting that determines how the system will respond when AC power is lost and then restored to the system. You can choose for the system to remain powered off (in which case you must press the power switch to turn it back on), or for it to automatically return to the power-on state. See the Advanced BIOS Setup section for this setting. The default setting is Last State.

1.4 System Health Monitoring

This section describes the health monitoring features of the X11DPS-RE motherboard. The motherboard has an onboard ASPEED AST2500 Baseboard Management Controller (BMC) that supports system health monitoring.

Onboard Voltage Monitors

The onboard voltage monitor will continuously scan crucial voltage levels. Once a voltage becomes unstable, it will give a warning or send an error message to the IPMI WebGPI and IPMIView. The user can adjust the voltage thresholds to define the sensitivity of the voltage monitor. Real time readings of these voltage levels are all displayed in IPMI.

Fan Status Monitor with Firmware Control

The system health monitor embedded in the BMC chip can check the RPM status of the cooling fans. The CPU and chassis fans are controlled via IPMI.

Environmental Temperature Control

System Health sensors in the BMC monitor the temperatures and voltage settings of onboard processors and the system in real time via the IPMI interface. Whenever the temperature of the CPU or the system exceeds the manufacturer-defined threshold, system/CPU cooling fans will be turned on to prevent the CPU or the system from overheating.



Note: To avoid possible system overheating, please be sure to provide adequate air-flow to your system.

System Resource Alert

This feature is available when used with SuperDoctor 5® which is used to notify the user of certain system events. For example, you can configure SuperDoctor 5 to provide you with warnings when the system temperature, CPU temperatures, voltages and fan speeds go beyond a predefined range.

1.5 ACPI Features

ACPI stands for Advanced Configuration and Power Interface. The ACPI specification defines a flexible and abstract hardware interface that provides a standard way to integrate power management features throughout a computer system including its hardware, operating system and application software. This enables the system to automatically turn on and off peripherals such as network cards, hard disk drives and printers.

In addition to enabling operating system-directed power management, ACPI also provides a generic system event mechanism for Plug and Play and an operating system-independent interface for configuration control. ACPI leverages the Plug and Play BIOS data structures while providing a processor architecture-independent implementation that is compatible with the appropriate Windows operating systems. For detailed information on OS support, please refer to our website at www.supermicro.com.

1.6 Power Supply

As with all computer products, a stable power source is necessary for proper and reliable operation, especially for processors that have high CPU clock rates.

1.7 Advanced Power Management

The following new advanced power management features are supported by the motherboard.

Intel® Intelligent Power Node Manager (IPNM)

Intel's Intelligent Power Node Manager (IPNM) provides your system with real-time thermal control and power management for maximum energy efficiency. Although IPNM Specification Version 2.0/3.0 is supported by the BMC (Baseboard Management Controller), your system must also have IPNM-compatible Management Engine (ME) firmware installed to use this feature.



Note: Support for IPNM 2.0/3.0 support is dependent on the power supply used in the system.

Management Engine (ME)

The Management Engine, which is an ARC controller embedded in the IOH (I/O Hub), provides Server Platform Services (SPS) to your system. The services provided by SPS are different from those provided by the ME on client platforms.

Intel® QuickAssist Technology

Built upon Intel's cutting-edge processor technology and the Intel C627 chipset, the X11DPS-RE supports Intel® QuickAssist Technology (Intel QAT), which offers high-profile security and compression acceleration to standard server platforms in a software-defined infrastructure.

By eliminating unneeded roadblocks, Intel QAT accelerates computation-intensive operations; provides software-enabled foundation for security, authentication and compression; and significantly increases the performance and efficiency across applications and platforms, including cryptography, symmetric encryption and authentication, asymmetric encryption, digital signature, pattern matching, and lossless data compression.

With Intel QuickAssist Technology built in, the X11DPS-RE is optimized for the use and deployment of integrated accelerators in networking and security applications, and efficiently meets the complex demands of High-Performance Computing (HPC), Virtualization, storage, and big data platforms.

1.8 Intel® Optane DC Persistent Memory Overview

2nd Generation Intel Xeon Scalable-SP processors support new DCPMM (Optane™ DC Persistent Memory Modules) technology that offers data persistence with higher capacity than existing memory modules and lower latency than NVMe SSDs. DCPMM memory provides hyper-speed storage capability for high performance computing platforms with flexible configuration options.

Chapter 2

Installation

2.1 Static-Sensitive Devices

Electrostatic Discharge (ESD) can damage electronic components. To avoid damaging your motherboard and your system, it is important to handle them very carefully. The following measures are generally sufficient to protect your equipment from ESD.

Precautions

- Use a grounded wrist strap designed to prevent static discharge.
- Touch a grounded metal object before removing the board from the antistatic bag.
- Handle the board by its edges only; do not touch its components, peripheral chips, memory modules, or gold contacts.
- When handling chips or modules avoid touching their pins.
- Put the motherboard and peripherals back into their antistatic bags when not in use.
- For grounding purposes, make sure that your chassis provides excellent conductivity between the power supply, the case, the mounting fasteners, and the motherboard.
- Use only the correct type of CMOS onboard battery as specified by the manufacturer. Do not install the CMOS battery upside down as it may result in a possible explosion.

Unpacking

The motherboard is shipped in antistatic packaging to avoid static damage. When unpacking the motherboard, make sure that the person handling it is static protected.

2.2 Motherboard Installation

All motherboards have standard mounting holes to fit different types of chassis. Make sure that the locations of all the mounting holes for both the motherboard and the chassis match. Although a chassis may have both plastic and metal mounting fasteners, metal ones are highly recommended because they ground the motherboard to the chassis. Make sure that the metal standoffs click in or are screwed in tightly.

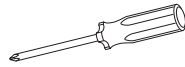

Phillips Screwdriver (1)



Phillips Screws (12)



Standoffs (12)
Only if Needed

Tools Needed

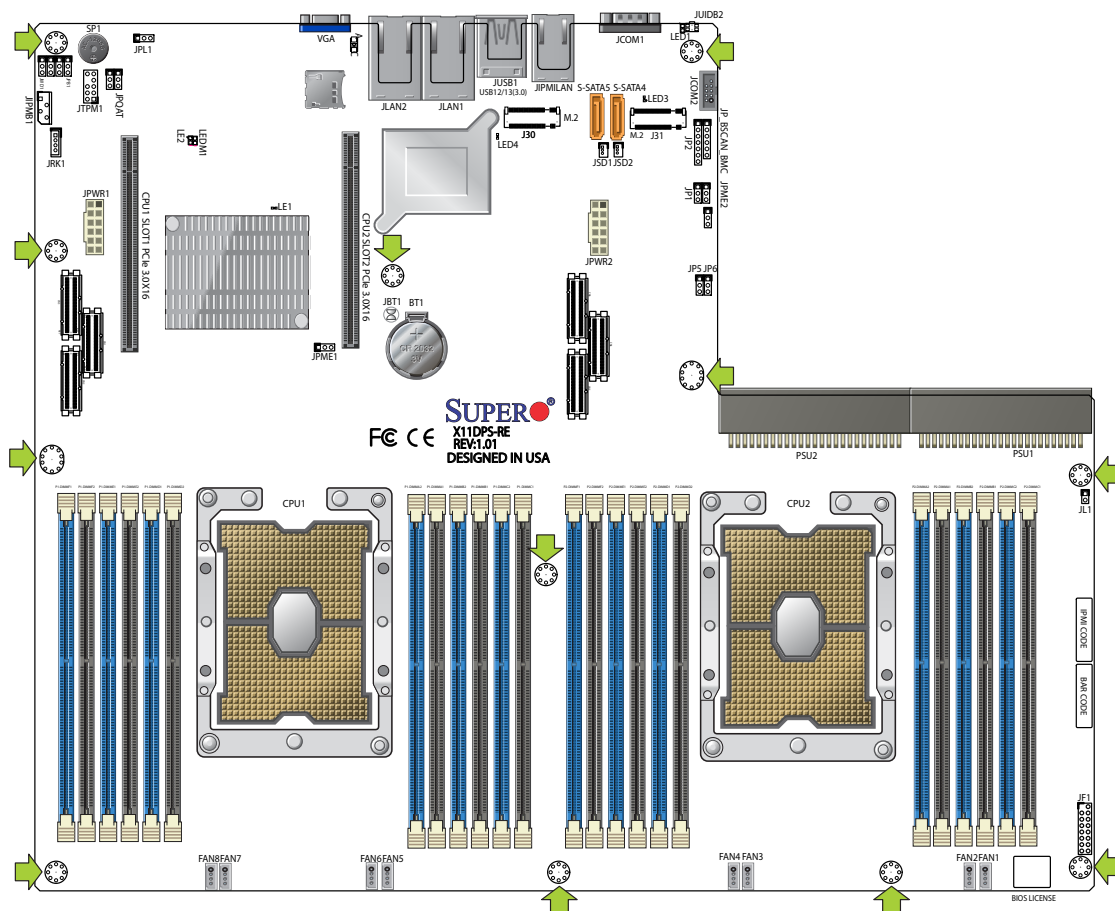

Location of Mounting Holes



- Notes:**
1. To avoid damaging the motherboard and its components, please do not use a force greater than 8 lb/inch on each mounting screw during motherboard installation.
 2. Some components are very close to the mounting holes. Please take precautionary measures to avoid damaging these components when installing the motherboard to the chassis.

Installing the Motherboard

1. Install the I/O shield into the back of the chassis if needed.
2. Locate the mounting holes on the motherboard. See the previous page for the location.

3. Locate the matching mounting holes on the chassis. Align the mounting holes on the motherboard against the mounting holes on the chassis.

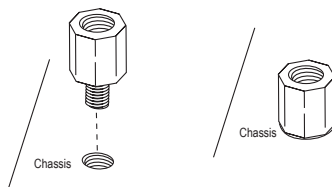

4. Install standoffs in the chassis as needed.

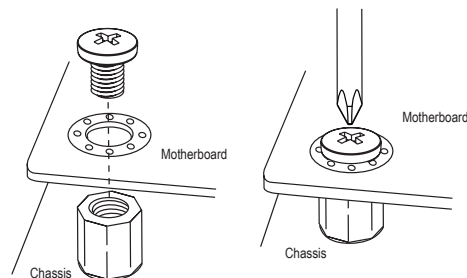

5. Install the motherboard into the chassis carefully to avoid damaging other motherboard components.
6. Using the Phillips screwdriver, insert a Phillips head #6 screw into a mounting hole on the motherboard and its matching mounting hole on the chassis.
7. Repeat Step 5 to insert #6 screws into all mounting holes.
8. Make sure that the motherboard is securely placed in the chassis.

 **Note:** Images displayed in this manual are for illustration only. Your chassis or components might look different from those shown in this manual.

2.3 Processor and Heatsink Installation

Warning: When handling the processor package, avoid placing direct pressure on the label area of the CPU or CPU socket. Also, improper CPU installation or socket misalignment can cause serious damage to the CPU or motherboard which may result in RMA repairs. Please read and follow all instructions thoroughly before installing your CPU and heatsink.

 **Notes:**

- Always connect the power cord last and always remove it before adding, removing, or changing any hardware components. Please note that the processor and heatsink should be assembled together first to form the Processor Heatsink Module (PHM), and then install the entire PHM into the CPU socket.
- When you receive a motherboard without a processor pre-installed, make sure that the plastic CPU socket cap is in place and that none of the socket pins are bent. Otherwise, please contact your retailer immediately.
- Refer to the Supermicro website for updates on CPU support.
- Please follow the instructions given in the ESD Warning section on the first page of this chapter before handling, installing, or removing system components.

Intel Xeon Scalable-SP and 2nd Gen Intel Xeon Scalable-SP Processors

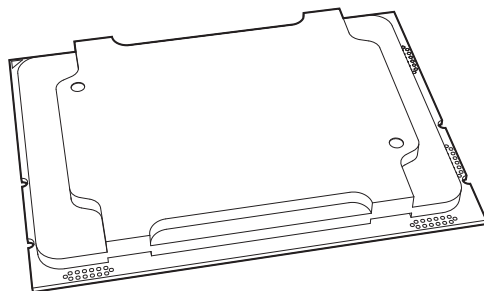

Intel Xeon Scalable-SP and 2nd Gen Intel Xeon Scalable-SP Processor

 **Note:** All graphics, drawings, and pictures shown in this manual are for illustration only. The components that came with your machine may or may not look exactly the same as those shown in this manual.

Overview of the Processor Socket Assembly

The processor socket assembly contains 1) Intel Xeon Scalable-SP or 2nd Gen Intel Xeon Scalable-SP Processor, 2) the narrow processor clip, 3) the dust cover, and 4) the CPU socket.

1. Intel Processor

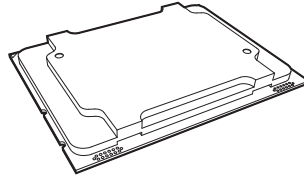

2. Narrow processor clip (the plastic processor package carrier used for the CPU)

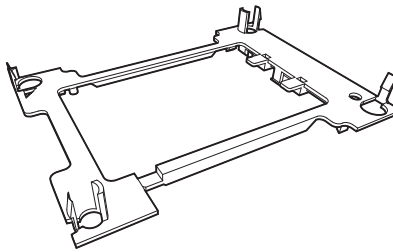

3. Dust Cover

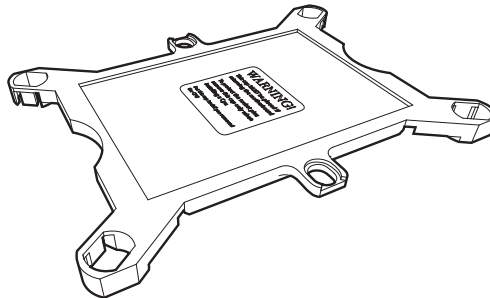

4. CPU Socket

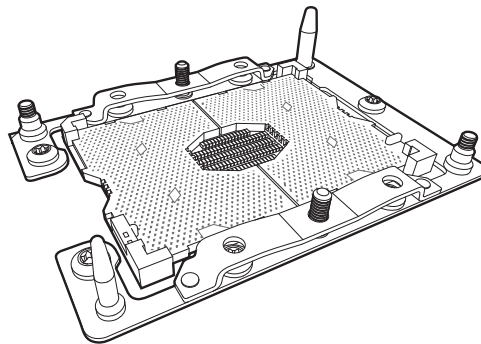

 **Note:** Be sure to cover the CPU socket with the dust cover when the CPU is not installed.

Overview of the Processor Heatsink Module (PHM)

The Processor Heatsink Module (PHM) contains 1) a heatsink, 2) a narrow processor clip, and 3) Intel Xeon Scalable-SP or 2nd Gen Intel Xeon Scalable-SP processor.

1. Heatsink

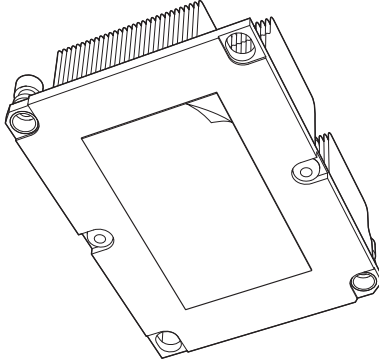

2. Narrow processor clip

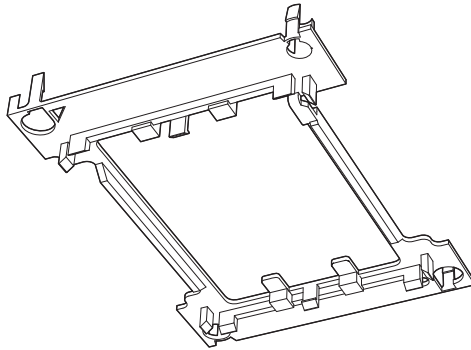

3. Intel Processor

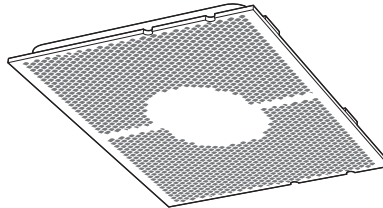

Processor Heatsink Module (PHM)

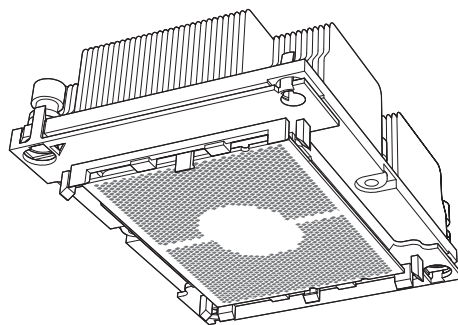

Bottom View

Attaching the Processor to the Narrow Processor Clip to Create the Processor Package Assembly

To properly install the CPU into the narrow processor clip, please follow the steps below.

1. Locate pin 1 (notch A), which is the triangle located on the top of the narrow processor clip. Also locate notch B and notch C on the processor clip.
2. Locate pin 1 (notch A), which is the triangle on the substrate of the CPU. Also, locate notch B and notch C on the CPU as shown below.
3. Align pin 1 (the triangle on the substrate) of the CPU with pin 1 (the triangle) of the narrow processor clip. Once they are aligned, carefully insert the CPU into the processor clip by sliding notch B of the CPU into notch B of the processor clip, and sliding notch C of the CPU into notch C of the processor clip.
4. Examine all corners of the CPU to ensure that it is properly seated on the processor clip. Once the CPU is securely attached to the processor clip, the processor package assembly is created.

 **Note:** Please exercise extreme caution when handling the CPU. Do not touch the CPU LGA-lands to avoid damaging the LGA-lands or the CPU. Be sure to wear ESD gloves when handling components.

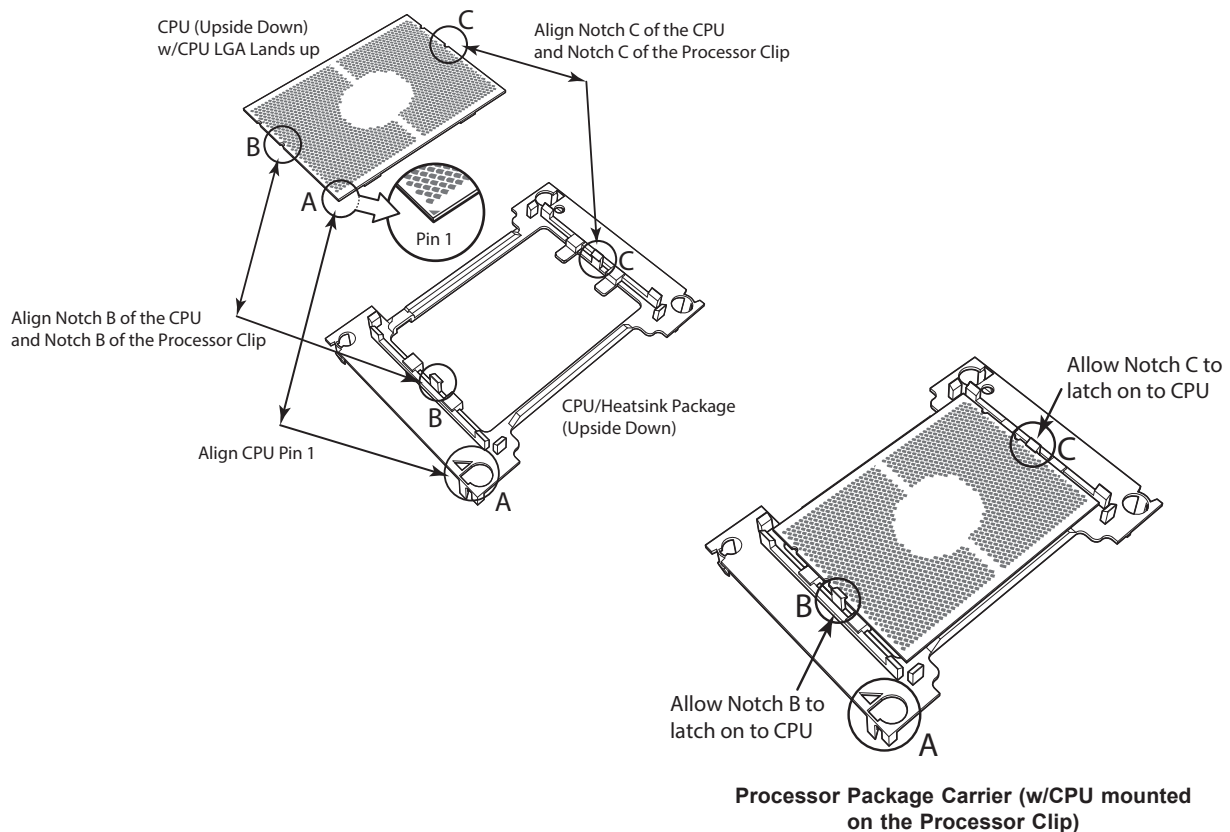

Attaching the Processor Package Assembly to the Heatsink to Form the Processor Heatsink Module (PHM)

After you have made a processor package assembly by following the instructions on the previous page, please follow the steps below to mount the processor package assembly onto the heatsink to create the Processor Heatsink Module (PHM).

1. Locate "1" on the heatsink label and the triangular corner next to it on the heatsink. With your index finger pressing against the screw at this triangular corner, carefully hold and turn the heatsink upside down with the thermal-grease side facing up. Remove the protective thermal film if present, and apply the proper amount of the thermal grease as needed. (Skip this step if you have a new heatsink because the necessary thermal grease is pre-applied in the factory.)
2. Holding the processor package assembly at the center edge, turn it upside down. With the thermal-grease side facing up, locate the hollow triangle located at the corner of the processor carrier assembly ("a" in the graphic). Note the larger hole and plastic mounting clicks located next to the hollow triangle. Locate another set of mounting clicks and a larger hole at the diagonal corner of the same (reverse) side of the processor carrier assembly ("b" in the graphic).
3. With the back of heatsink and the reverse side of the processor package assembly facing up, align the triangular corner on the heatsink ("A" in the graphic) against the mounting clips next to the hollow triangle ("a") on the processor package assembly.
4. Align the triangular corner ("B") at the diagonal side of the heatsink with the corresponding clips on the processor package assembly ("b").
5. Once the mounting clips on the processor package assembly are properly aligned with the corresponding holes on the back of heatsink, securely attach the heatsink to the processor package assembly by snapping the mounting clips at the proper places on the heatsink to create the Processor / Heatsink Module (PHM).

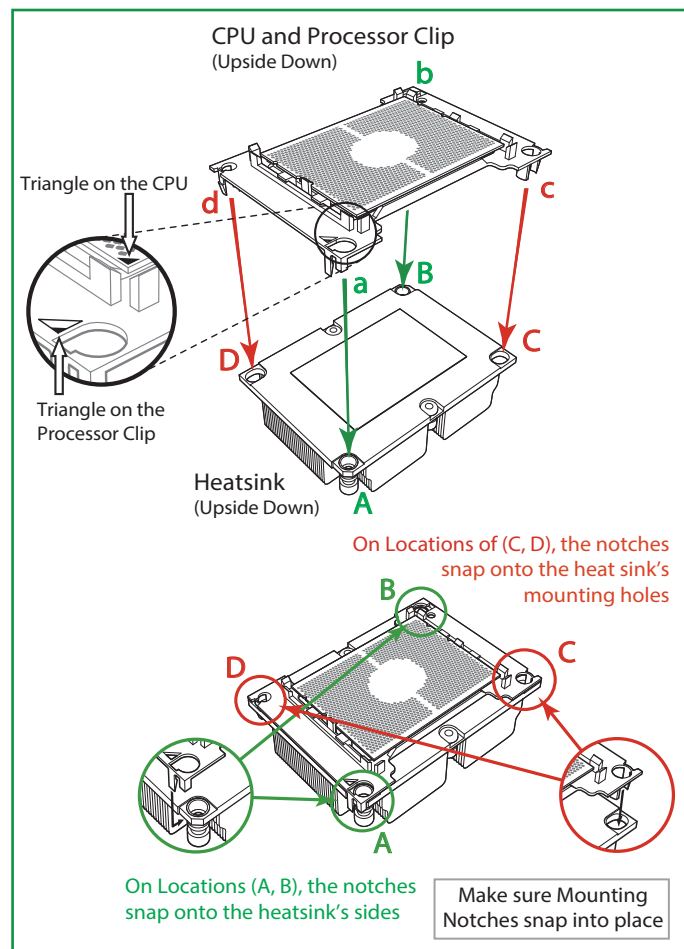

Preparing the CPU Socket for Installation

This motherboard comes with the CPU socket pre-assembled in the factory. The CPU socket contains 1) a dust cover, 2) a socket bracket, 3) the CPU (P0) socket, and 4) a back plate. These components are pre-installed on the motherboard before shipping.

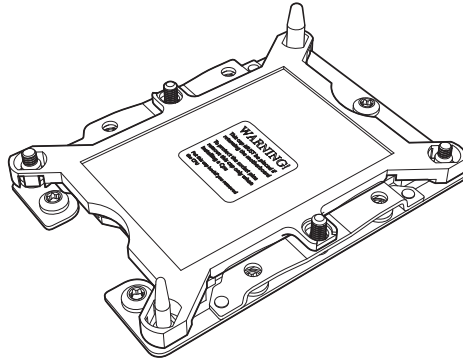

CPU Socket w/Dust Cover On

Removing the Dust Cover from the CPU Socket

Remove the dust cover from the CPU socket, exposing the CPU socket and socket pins as shown on the illustration below.

 **Note:** Do not touch the socket pins to avoid damaging them, causing the CPU to malfunction.

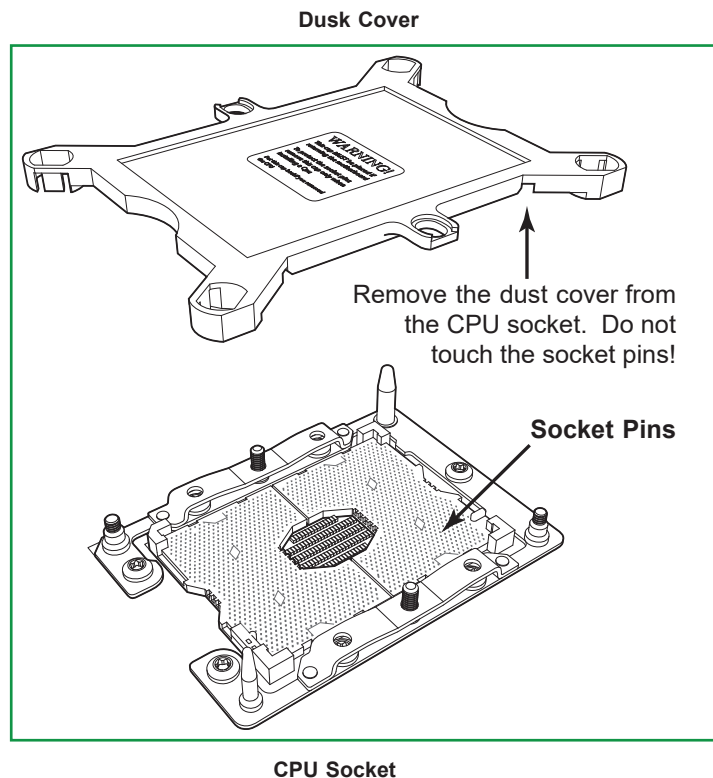

CPU Socket

Installing the Processor Heatsink Module (PHM)

1. Once you have assembled the Processor Heatsink Module (PHM) by following the instructions listed on page 29, you are ready to install the module into the CPU socket on the motherboard. To install the PHM into the CPU socket, follow the instructions below.
2. Locate the triangle (pin 1) on the CPU socket, and locate the triangle (pin 1) at the corner of the PHM that is closest to "1." (If you have difficulty locating pin 1 of the PHM, turn the PHM upside down. With the LGA-lands side facing up, you will note the hollow triangle located next to a screw at the corner. Turn the PHM right side up, and you will see a triangle marked on the processor clip at the same corner of hollow triangle.)
3. Carefully align pin 1 (the triangle) on the the PHM against pin 1 (the triangle) on the CPU socket.
4. Once they are properly aligned, insert the two diagonal oval holes on the heatsink into the guiding posts.
5. Using a T30 Torx-bit screwdriver, install four screws into the mounting holes on the socket to securely attach the PHM onto the motherboard starting with the screw marked "1" (in the sequence of 1, 2, 3, and 4).

 **Note:** To avoid damaging the LGA-lands and the processor, do not use excessive force when tightening the screws.

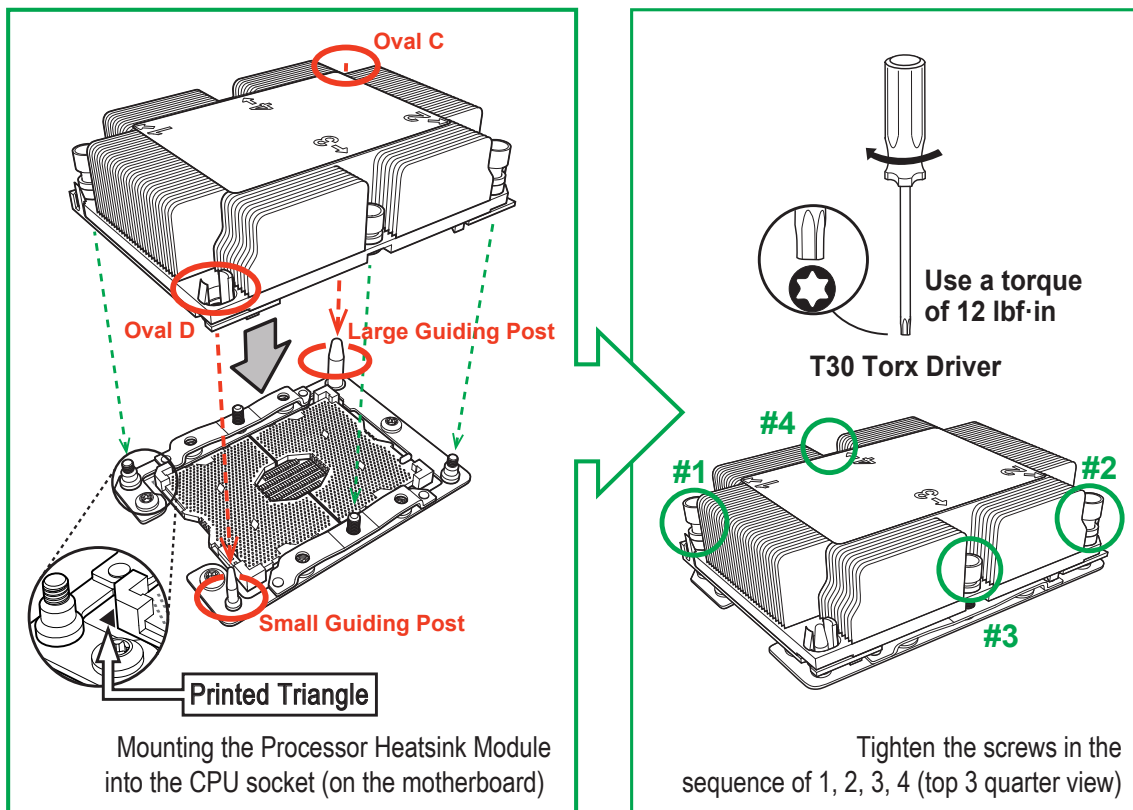

Removing the Processor Heatsink Module (PHM) from the Motherboard

Before removing the Processor Heatsink Module (PHM), unplug power cord from the power outlet.

1. Using a T30 Torx-bit screwdriver, turn the screws on the PHM counterclockwise to loosen them from the socket, starting with screw marked #4 (in the sequence of 4, 3, 2, 1).
2. After all four screws are removed, wiggle the PHM gently and pull it up to remove it from the socket.

 **Note:** To properly remove the processor heatsink module, be sure to loosen and remove the screws on the PHM in the sequence of 4, 3, 2, 1 as shown below.

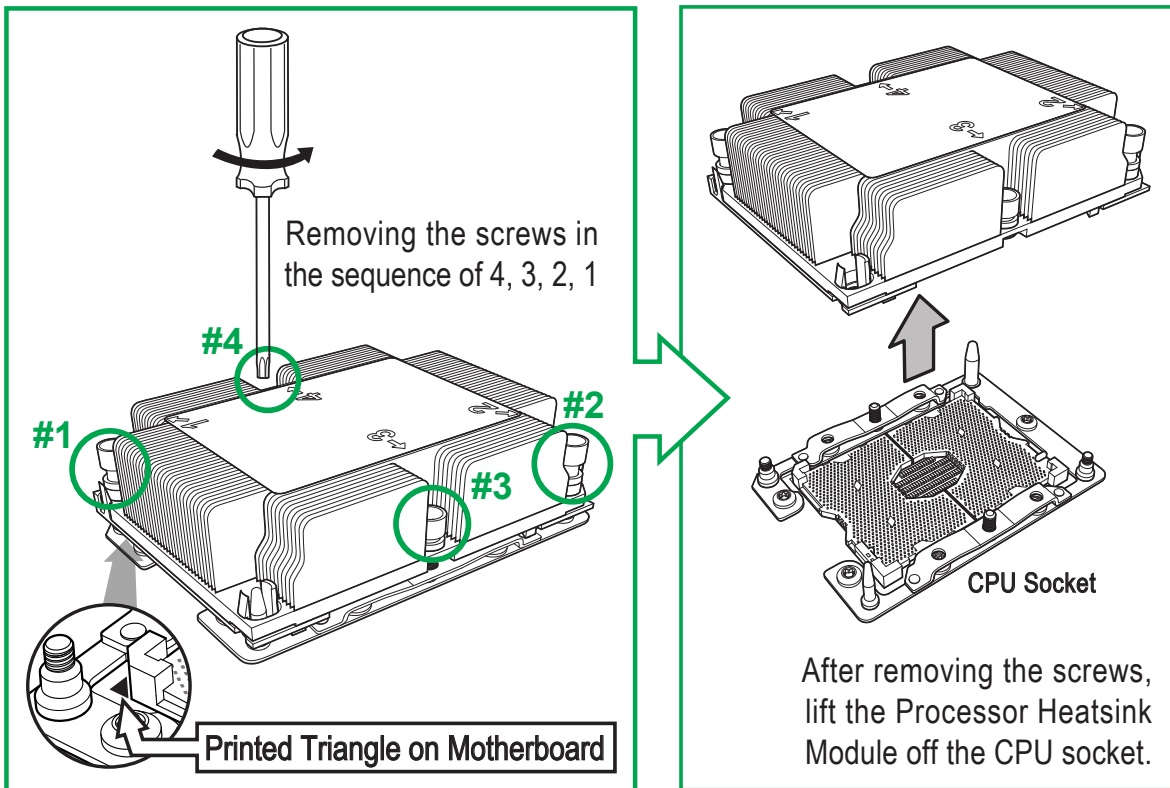

2.4 Memory Support and Installation

 **Note:** Check the Supermicro website for recommended memory. Exercise extreme care when installing or removing DIMM modules to prevent any damage.

Memory Support

The X11DPS-RE motherboard supports up to 6TB of LRDIMM/RDIMM/NVDIMM DDR4 ECC 2933*/2666/2400/2133 MHz memory in 24 memory slots (***Note below**). It also supports up to 9TB memory with DCPMM modules installed based on the DCPMM population table on page 38.

 **Notes:** **1.** 2933 MHz memory is supported by 2nd Generation Intel Xeon Scalable-SP (82xx/62xx series) processors only. **2.** 16Gb-based memory modules are supported by 2nd Gen Intel Xeon Scalable-SP processors only.

Memory Installation Sequence

Memory modules for this motherboards are populated using the "Fill First" method. The blue memory slot of each channel is considered the "first DIMM module" of the channel, and the black slot, the second module of the channel. When installing memory modules, be sure to populate the blue memory slots first and then populate the black slots. To maximize memory capacity, please populate all DIMM slots on the motherboard, including all blue slots and black slots.

General Memory Population Requirements

1. Be sure to use the memory modules of the same type and speed on the motherboard. Mixing of memory modules of different types and speeds is not allowed.
2. Using unbalanced memory topology such as populating two DIMMs in one channel while populating one DIMM in another channel on the same motherboard will result in reduced memory performance.
3. Populating memory slots with a pair of DIMM modules of the same type and size will result in interleaved memory, which will improve memory performance.

A. DDR4 Memory Support for Intel Xeon Scalable-SP Processors

| DDR4 Memory Support | | | | | | | |
|---------------------|-----------------------------|--------------------|----------|--|--|---------------------------|---------------------------|
| Type | Ranks Per DIMM & Data Width | DIMM Capacity (GB) | | | Speed (MT/s); Voltage (V); Slots Per Channel (SPC) and DIMMs Per Channel (DPC) | | |
| | | DRAM Density | | | 1 Slot Per Channel | 2 Slots Per Channel | |
| | | 4Gb* | 8Gb | | 1DPC (1-DIMM Per Channel) | 1DPC (1-DIMM Per Channel) | 2DPC (2-DIMM Per Channel) |
| | | 4GB | 8GB | | 1.2 V | 1.2 V | 1.2 V |
| RDIMM | SRx4 | 4GB | 8GB | | 2666 | 2666 | 2666 |
| RDIMM | SRx8 | 8GB | 16GB | | 2666 | 2666 | 2666 |
| RDIMM | DRx8 | 8GB | 16GB | | 2666 | 2666 | 2666 |
| RDIMM | DRx4 | 16GB | 32GB | | 2666 | 2666 | 2666 |
| RDIMM 3Ds | QRX4 | N/A | 2H-64GB | | 2666 | 2666 | 2666 |
| RDIMM 3Ds | 8RX4 | N/A | 4H-128GB | | 2666 | 2666 | 2666 |
| LRDIMM | QRx4 | 32GB | 64GB | | 2666 | 2666 | 2666 |
| LRDIMM 3Ds | QRX4 | N/A | 2H-64GB | | 2666 | 2666 | 2666 |
| LRDIMM 3Ds | 8Rx4 | N/A | 4H-128GB | | 2666 | 2666 | 2666 |

B. DDR4 Memory Support for 2nd Gen Intel Xeon Scalable-SP Processors

| DDR4 Memory Support | | | | | | | |
|---------------------|-----------------------------|--------------------|----------|----------|--|---------------------------|---------------------------|
| Type | Ranks Per DIMM & Data Width | DIMM Capacity (GB) | | | Speed (MT/s); Voltage (V); Slots Per Channel (SPC) and DIMMs Per Channel (DPC) | | |
| | | DRAM Density | | | 1 Slot Per Channel | 2 Slots Per Channel | |
| | | 4Gb* | 8Gb | 16Gb | 1DPC (1-DIMM Per Channel) | 1DPC (1-DIMM Per Channel) | 2DPC (2-DIMM Per Channel) |
| | | 4GB | 8GB | 16GB | 1.2 V | 1.2 V | 1.2 V |
| RDIMM | SRx4 | 4GB | 8GB | 16GB | 2933 | 2933 | 2933 |
| RDIMM | SRx8 | 8GB | 16GB | 32GB | 2933 | 2933 | 2933 |
| RDIMM | DRx8 | 8GB | 16GB | 32GB | 2933 | 2933 | 2933 |
| RDIMM | DRx4 | 16GB | 32GB | 64GB | 2933 | 2933 | 2933 |
| RDIMM 3Ds | QRX4 | N/A | 2H-64GB | 2H-128GB | 2933 | 2933 | 2933 |
| RDIMM 3Ds | 8RX4 | N/A | 4H-128GB | 4H-256GB | 2933 | 2933 | 2933 |
| LRDIMM | QRx4 | 32GB | 64GB | 128GB | 2933 | 2933 | 2933 |
| LRDIMM 3Ds | QRX4 | N/A | 2H-64GB | 2H-128GB | 2933 | 2933 | 2933 |
| LRDIMM 3Ds | 8Rx4 | N/A | 4H-128GB | 4H-256GB | 2933 | 2933 | 2933 |



Notes: **1.** 2933 MHz memory support in two-DIMMs per-channel (2DPC) configuration can be achieved by using memory purchased from Supermicro. **2.** 2933 MHz memory is supported by 2nd Gen Intel Xeon Scalable-SP (82xx/62xx series) processors only. **3.** 6Gb-based memory modules are supported by 2nd Gen Intel Xeon Scalable-SP processors only.

DIMM Population Guidelines for Optimal Performance

For optimal memory performance, follow the instructions listed in the tables below when populating memory modules.

Key Parameters for DIMM Configuration

| Key Parameters for DIMM Configurations | |
|--|--|
| Parameters | Possible Values |
| Number of Channels | 1, 2, 3, 4, 5, or 6 |
| Number of DIMMs per Channel | 1DPC (1 DIMM Per Channel) or 2DPC (2 DIMMs Per Channel) |
| DIMM Type | RDIMM (w/ECC), 3DS RDIMM, LRDIMM, 3DS LRDIMM |
| DIMM Construction | <ul style="list-style-type: none"> non-3DS RDIMM Raw Cards: A/B (2Rx4), C (1Rx4), D (1Rx8), E (2Rx8) 3DS RDIMM Raw Cards: A/B (4Rx4) non-3DS LRDIMM Raw Cards: D/E (4Rx4) 3DS LRDIMM Raw Cards: A/B (8Rx4) |

DIMM Mixing Guidelines

| General DIMM Mixing Guidelines | | | |
|--|-------------|-------------|-------------|
| DIMM Mixing Rules | | | |
| <ul style="list-style-type: none"> All DIMMs must be all DDR4 DIMMs. x4 and x8 DIMMs can be mixed in the same channel. Mixing of LRDIMMs and RDIMMs is not allowed in the same channel, across different channels, and across different sockets. Mixing of non-3DS and 3DS LRDIMM is not allowed in the same channel, across different channels, and across different sockets. | | | |
| Mixing of DIMM Types within a Channel | | | |
| DIMM Types | RDIMM | LRDIMM | 3DS LRDIMM |
| RDIMM | Allowed | Not Allowed | Not Allowed |
| LRDIMM | Not Allowed | Allowed | Not Allowed |
| 3DS LRDIMM | Not Allowed | Not Allowed | Allowed |

DIMM Population Table



Note: Unbalanced memory configuration decreases memory performance and is not recommended for Supermicro motherboards.

Memory Population for the the Motherboard (w/24 Slots) based on Intel Xeon Scalable-SP and 2nd Gen Intel Xeon Scalable-SP Processors

| Memory Population Table for the X11DP Motherboard w/24 DIMM Slots Onboard | |
|---|--|
| When 1 CPU is used: | Memory Population Sequence |
| 1 CPU & 1 DIMM | CPU1: P1-DIMMA1 |
| 1 CPU & 2 DIMMs | CPU1: P1-DIMMA1/P1-DIMMD1 |
| 1 CPU & 3 DIMMs | CPU1: P1-DIMMC1/P1-DIMMB1/P1-DIMMA1 |
| 1 CPU & 4 DIMMs | CPU1: P1-DIMMB1/P1-DIMMA1/P1-DIMMD1/P1-DIMME1 |
| 1 CPU & 5 DIMMs (Unbalanced: not recommended) | CPU1: P1-DIMMC1/P1-DIMMB1/P1-DIMMA1/P1-DIMMD1/P1-DIMME1 |
| 1 CPU & 6 DIMM | CPU1: P1-DIMMC1/P1-DIMMB1/P1-DIMMA1/P1-DIMMD1/P1-DIMME1/P1-DIMMF1 |
| 1 CPU & 7 DIMMs (Unbalanced: not recommended) | CPU1: P1-DIMMB1/P1-DIMMB2/P1-DIMMA1/P1-DIMMA2/P1-DIMMD1/P1-DIMME1/P1-DIMMF1 |
| 1 CPU & 8 DIMMs | CPU1: P1-DIMMB1/P1-DIMMB2/P1-DIMMA1/P1-DIMMA2/P1-DIMMD2/P1-DIMMD1/P1-DIMME2/P1-DIMME1 |
| 1 CPU & 9 DIMMs (Unbalanced: not recommended) | CPU1: P1-DIMMC1/P1-DIMMC2/P1-DIMMB1/P1-DIMMB2/P1-DIMMA1/P1-DIMMA2/ P1-DIMMD1/P1-DIMME1/P1-DIMMF1 |
| 1 CPU & 10 DIMMs (Unbalanced: not recommended) | CPU1: P1-DIMMC1/P1-DIMMB1/P1-DIMMB2/P1-DIMMA1/P1-DIMMA2/ P1-DIMMD2/P1-DIMMD1/P1-DIMME2/P1-DIMME1/P1-DIMMF1 |
| 1 CPU & 11 DIMMs (Unbalanced: not recommended) | CPU1: P1-DIMMC1/P1-DIMMC2/P1-DIMMB1/P1-DIMMB2/P1-DIMMA1/P1-DIMMA2/ P1-DIMMD2/P1-DIMMD1/P1-DIMME2/P1-DIMME1/P1-DIMMF1 |
| 1 CPU & 12 DIMMs | CPU1: P1-DIMMC1/P1-DIMMC2/P1-DIMMB1/P1-DIMMB2/P1-DIMMA1/P1-DIMMA2/ P1-DIMMD2/P1-DIMMD1/P1-DIMME2/P1-DIMME1/P1-DIMMF2/P1-DIMMF1 |
| When 2 CPUs are used: | Memory Population Sequence |
| 2 CPUs & 2 DIMMs | CPU1: P1-DIMMA1 CPU2: P2-DIMMA1 |
| 2 CPUs & 4 DIMMs | CPU1: P1-DIMMA1/P1-DIMMD1 CPU2: P2-DIMMA1/P2-DIMMD1 |
| 2 CPUs & 6 DIMMs | CPU1: P1-DIMMC1/P1-DIMMB1/P1-DIMMA1 CPU2: P2-DIMMC1/P2-DIMMB1/P2-DIMMA1 |
| 2 CPUs & 8 DIMMs | CPU1: P1-DIMMB1/P1-DIMMA1/P1-DIMMD1/P1-DIMME1 CPU2: P2-DIMMB1/P2-DIMMA1/P2-DIMMD1/P2-DIMME1 |
| 2 CPUs & 10 DIMMs | CPU1: P1-DIMMC1/P1-DIMMB1/P1-DIMMA1/P1-DIMMD1/P1-DIMME1/P1-DIMMF1 CPU2: P2-DIMMB1/P2-DIMMA1/P2-DIMMD1/P2-DIMME1 |
| 2 CPUs & 12 DIMMs | CPU1: P1-DIMMC1/P1-DIMMB1/P1-DIMMA1/P1-DIMMD1/P1-DIMME1/P1-DIMMF1 CPU2: P2-DIMMC1/P2-DIMMB1/P2-DIMMA1/P2-DIMMD1/P2-DIMME1/P2-DIMMF1 |
| 2 CPUs & 14 DIMMs | CPU1: P1-DIMMB1/P1-DIMMB2/P1-DIMMA1/P1-DIMMA2/P1-DIMMD2/P1-DIMMD1/P1-DIMME2/P1-DIMME1 CPU2: P2-DIMMC1/P2-DIMMB1/P2-DIMMA1/P2-DIMMD1/P2-DIMME1/P2-DIMMF1 |
| 2 CPUs & 16 DIMMs | CPU1: P1-DIMMB1/P1-DIMMB2/P1-DIMMA1/P1-DIMMA2/P1-DIMMD2/P1-DIMMD1/P1-DIMME2/P1-DIMME1 CPU2: P2-DIMMB1/P2-DIMMB2/P2-DIMMA1/P2-DIMMA2/P2-DIMMD2/P2-DIMMD1/P2-DIMME2/P2-DIMME1 |
| 2 CPUs & 18 DIMMs | CPU1: P1-DIMMC1/P1-DIMMC2/P1-DIMMB1/P1-DIMMB2/P1-DIMMA1/P1-DIMMA2/P1-DIMMD2/P1-DIMMD1/P1-DIMME2/P1-DIMME1/P1-DIMMF2/P1-DIMMF1 CPU2: P2-DIMMC1/P2-DIMMB1/P2-DIMMA1/P2-DIMMD1/P2-DIMME1/P2-DIMMF1 |
| 2 CPUs & 20 DIMMs | CPU1: P1-DIMMC1/P1-DIMMC2/P1-DIMMB1/P1-DIMMB2/P1-DIMMA1/P1-DIMMA2/P1-DIMMD2/P1-DIMMD1/P1-DIMME2/P1-DIMME1/P1-DIMMF2/P1-DIMMF1 CPU2: P2-DIMMB1/P2-DIMMB2/P2-DIMMA1/P2-DIMMA2/P2-DIMMD2/P2-DIMMD1/P2-DIMME2/P2-DIMME1 |
| 2 CPUs & 22 DIMMs (Unbalanced: not recommended) | CPU1: P1-DIMMC1/P1-DIMMC2/P1-DIMMB1/P1-DIMMB2/P1-DIMMA1/P1-DIMMA2/ P1-DIMMD2/P1-DIMMD1/P1-DIMME2/P1-DIMME1/P1-DIMMF1 CPU2: P2-DIMMC1/P2-DIMMC2/P2-DIMMB1/P2-DIMMB2/P2-DIMMA1/P2-DIMMA2/ P2-DIMMD2/P2-DIMMD1/P2-DIMME2/P2-DIMME1/P2-DIMMF1 |
| 2 CPUs & 24 DIMMs | CPU1: P1-DIMMC1/P1-DIMMC2/P1-DIMMB1/P1-DIMMB2/P1-DIMMA1/P1-DIMMA2/ P1-DIMMD2/P1-DIMMD1/P1-DIMME2/P1-DIMME1/P1-DIMMF2/P1-DIMMF1 CPU2: P2-DIMMC1/P2-DIMMC2/P2-DIMMB1/P2-DIMMB2/P2-DIMMA1/P2-DIMMA2/ P2-DIMMD2/P2-DIMMD1/P2-DIMME2/P2-DIMME1/P2-DIMMF2/P2-DIMMF1 |



Note: Please refer to the Memory Configuration User Guide for the X11 UP/DP/MP Motherboards that is posted on our website for detailed information on memory support for this motherboard.

Memory Rank Sparing Tables for the X11DPS-RE (w/24Slots)

| Dual Rank Memory Rank Sparing (16GB DIMM) | | |
|---|------------------------|------------------------|
| Memory Population | Total RAM Detected | |
| | One Rank Configuration | Two Rank Configuration |
| A1 | 8GB | 8GB |
| A1+B1 | 16GB | 16GB |
| A1+B1+C1 | 24GB | 24GB |
| A1+B1+C1+D1 | 32GB | 32GB |
| A1+B1+C1+D1+E1 | 40GB | 40GB |
| A1+B1+C1+D1+E1+F1 | 49GB | 49GB |
| | | |
| A1+A2 | 24GB | 16GB |
| A1+A2+B1+B2 | 48GB | 32GB |
| A1+A2+B1+B2+C1+C2 | 72GB | 48GB |
| A1+A2+B1+B2+C1+C2+D1+D2 | 96GB | 64GB |
| A1+A2+B1+B2+C1+C2+D1+D2+E1+E2 | 120GB | 80GB |
| A1+A2+B1+B2+C1+C2+D1+D2+E1+E2+F1+F2 | 144GB | 96GB |

| Quad Rank Memory Rank Sparing (64GB DIMM) | | |
|---|------------------------|------------------------|
| Memory Population | Total RAM Detected | |
| | One Rank Configuration | Two Rank Configuration |
| A1 | 48GB | 32GB |
| A1+B1 | 96GB | 64GB |
| A1+B1+C1 | 144GB | 96GB |
| A1+B1+C1+D1 | 192GB | 128GB |
| A1+B1+C1+D1+E1 | 240GB | 160GB |
| A1+B1+C1+D1+E1+F1 | 288GB | 192GB |
| | | |
| A1+A2 | 112GB | 96GB |
| A1+A2+B1+B2 | 224GB | 192GB |
| A1+A2+B1+B2+C1+C2 | 336GB | 288GB |
| A1+A2+B1+B2+C1+C2+D1+D2 | 448GB | 384GB |
| A1+A2+B1+B2+C1+C2+D1+D2+E1+E2 | 560GB | 480GB |
| A1+A2+B1+B2+C1+C2+D1+D2+E1+E2+F1+F2 | 672GB | 576GB |

DCPMM Memory Population Table for the X11DP Motherboards (w/24 Slots) based on 2nd Gen Intel Xeon Scalable-SP Processors

 **Note:** Only 2nd Gen Intel Xeon Scalable-SP (82xx/62xx/52xx/4215 series) processors support DCPMM memory.

| Symmetric Population within 1 CPU Socket | | | | | | | | | | | | | |
|--|-----------|-----------|-----------|-----------|-----------|-----------|-----------|-----------|-----------|-----------|-----------|-----------|-----------------|
| Modes | P1-DIMMF1 | P1-DIMMF2 | P1-DIMME1 | P1-DIMME2 | P1-DIMMD1 | P1-DIMMD2 | P1-DIMMA2 | P1-DIMMA1 | P1-DIMMB2 | P1-DIMMB1 | P1-DIMMC2 | P1-DIMMC1 | Channel Config. |
| AD | DRAM1 | DCPMM | DRAM1 | DCPMM | DRAM1 | DCPMM | DCPMM | DRAM1 | DCPMM | DRAM1 | DCPMM | DRAM1 | 2-2-2 |
| MM | DRAM1 | DCPMM | DRAM1 | DCPMM | DRAM1 | DCPMM | DCPMM | DRAM1 | DCPMM | DRAM1 | DCPMM | DRAM1 | 2-2-2 |
| AD + MM | DRAM3 | DCPMM | DRAM3 | DCPMM | DRAM3 | DCPMM | DCPMM | DRAM3 | DCPMM | DRAM3 | DCPMM | DRAM3 | 2-2-2 |
| AD | DRAM1 | - | DRAM1 | - | DRAM1 | DCPMM | DCPMM | DRAM1 | - | DRAM1 | - | DRAM1 | 2-1-1 |
| MM | DRAM2 | - | DRAM2 | - | DRAM2 | DCPMM | DCPMM | DRAM2 | - | DRAM2 | - | DRAM2 | 2-1-1 |
| AD + MM | DRAM3 | - | DRAM3 | - | DRAM3 | DCPMM | DCPMM | DRAM3 | - | DRAM3 | - | DRAM3 | 2-1-1 |
| AD | DRAM1 | - | DRAM1 | DCPMM | DRAM1 | DCPMM | DCPMM | DRAM1 | DCPMM | DRAM1 | - | DRAM1 | 2-2-1 |
| MM | DRAM1 | - | DRAM1 | DCPMM | DRAM1 | DCPMM | DCPMM | DRAM1 | DCPMM | DRAM1 | - | DRAM1 | 2-2-1 |
| AD + MM | DRAM3 | - | DRAM3 | DCPMM | DRAM3 | DCPMM | DCPMM | DRAM3 | DCPMM | DRAM3 | - | DRAM3 | 2-2-1 |
| AD | DCPMM | - | DRAM1 | - | DRAM1 | - | - | DRAM1 | - | DRAM1 | - | DCPMM | 1-1-1 |
| MM | DCPMM | - | DRAM1 | - | DRAM1 | - | - | DRAM1 | - | DRAM1 | - | DCPMM | 1-1-1 |
| AD + MM | DCPMM | - | DRAM3 | - | DRAM3 | - | - | DRAM3 | - | DRAM3 | - | DCPMM | 1-1-1 |
| AD | DCPMM | - | DRAM1 | DRAM1 | DRAM1 | DRAM1 | DRAM1 | DRAM1 | DRAM1 | DRAM1 | - | DCPMM | 2-2-1 |

| Asymmetric Population within 1 CPU Socket | | | | | | | | | | | | | |
|---|-----------|-----------|-----------|-----------|-----------|-----------|-----------|-----------|-----------|-----------|-----------|-----------|-----------------|
| Modes | P1-DIMMF1 | P1-DIMMF2 | P1-DIMME1 | P1-DIMME2 | P1-DIMMD1 | P1-DIMMD2 | P1-DIMMA2 | P1-DIMMA1 | P1-DIMMB2 | P1-DIMMB1 | P1-DIMMC2 | P1-DIMMC1 | Channel Config. |
| AD | DRAM1 | - | DRAM1 | - | DRAM1 | - | DCPMM | DRAM1 | - | DRAM1 | - | DRAM1 | 2/1-1-1 |
| AD* | DRAM1 | - | DRAM1 | - | DRAM1 | - | DCPMM | DRAM1 | - | DRAM1 | - | DRAM1 | 2/1-1-1 |

| Legend (for the two tables above) | | | | | |
|-----------------------------------|-------|-----------|--------|------------|---|
| DDR4 Type | | | | | Capacity |
| DRAM1 | RDIMM | 3DS RDIMM | LRDIMM | 3DS LRDIMM | Refer to Validation Matrix (DDR4 DIMMs validated with DCPMM) below. |
| DRAM2 | RDIMM | - | - | - | |
| DRAM3 | RDIMM | 3DS RDIMM | LRDIMM | - | |

 **Note:** DDR4 single rank x8 is not available for DCPMM Memory Mode or App-Direct Mode.

| Legend (for the first two tables above) | |
|---|---|
| Capacity | |
| DCPMM | Any Capacity (Uniformly for all channels for a given configuration) |

- * 2nd socket has no DCPMM DIMM
- Mode definitions: AD=App Direct Mode, MM=Memory Mode, AD+MM=Mixed Mode
- For MM, general DDR4+DCPMM ratio is between 1:4 and 1:16. Excessive capacity for DCPMM can be used for AD.
- For each individual population, rearrangements between channels are allowed as long as the resulting population is compliant with the X11 memory population rules for the 2nd Gen Intel Xeon Scalable-SP processors.
- For each individual population, please use the same DDR4 DIMM in all slots.
- For each individual population, sockets are normally symmetric with exceptions for 1 DCPMM per socket and 1 DCPMM per node case. Currently, DCPMM modules operate at 2666 MHz.
- No mixing of DCPMM and NVMDIMMs within the same platform is allowed.
- This DCPMM population guide targets a balanced DCPMM-to-DRAM-cache ratio in MM and MM + AD modes.

| Validation Matrix (DDR4 DIMMs Validated w/DCPMM) | | | |
|---|--|---------------------------|------------|
| DIMM Type | Ranks Per DIMM & Data Width (Stack) | DIMM Capacity (GB) | |
| | | DRAM Density | |
| | | 4Gb | 8Gb |
| RDIMM | 1Rx4 | 8GB | 16GB |
| | 2Rx8 | 8GB | 16GB |
| | 2Rx4 | 16GB | 32GB |
| LRDIMM | 4Rx4 | N/A | 64GB |
| LRDIMM 3DS | 8Rx4 (4H) | N/A | 128GB |

DIMM Installation

1. Follow the instructions given in the memory population guidelines listed in the previous sections to install memory modules on your motherboard. For the system to work properly, please use memory modules of the same type and speed on the motherboard.
2. Push the release tabs outwards on both ends of the DIMM slot to unlock it.
3. Align the key of the DIMM module with the receptive point on the memory slot.
4. Align the notches on both ends of the module against the receptive points on the ends of the slot.
5. Use two thumbs together to press on both ends of the module straight down into the slot until the module snaps into place.
6. Press the release tabs to the lock positions to secure the DIMM module into the slot.

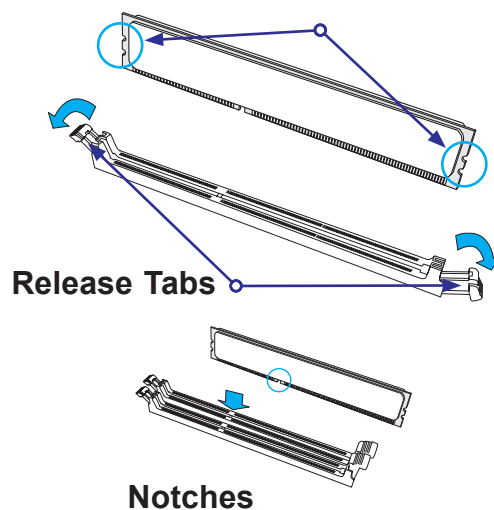
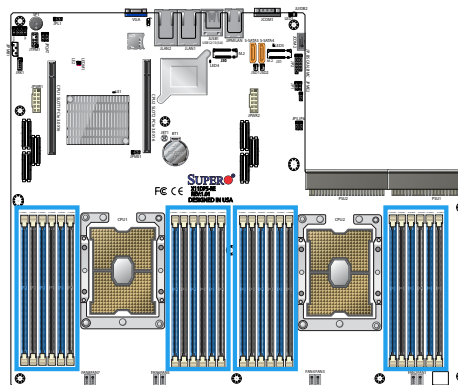

DIMM Module Removal

Press the release tabs on both ends of the DIMM socket to release the DIMM module from the socket as shown in the drawing below.

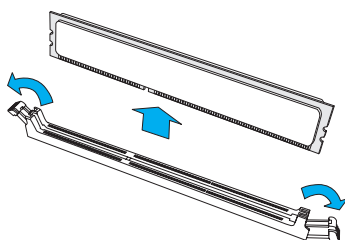

Warnings: 1. Please do not use excessive force when pressing the release tabs on the ends of the DIMM socket to avoid causing any damage to the DIMM module or the DIMM socket. 2. Please handle DIMM modules with care. Carefully follow all the instructions given on Page 1 of this chapter to prevent ESD-related damages to your memory modules or components.

2.5 Rear I/O Ports

See the figure below for the locations and descriptions of the various I/O ports on the rear of the motherboard.

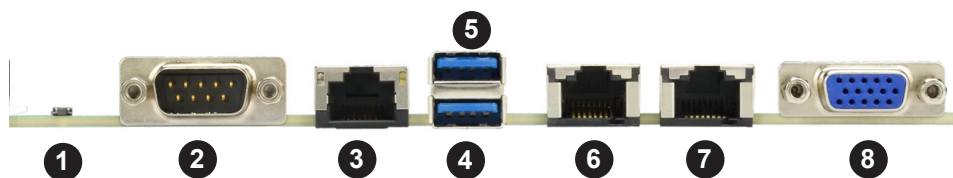
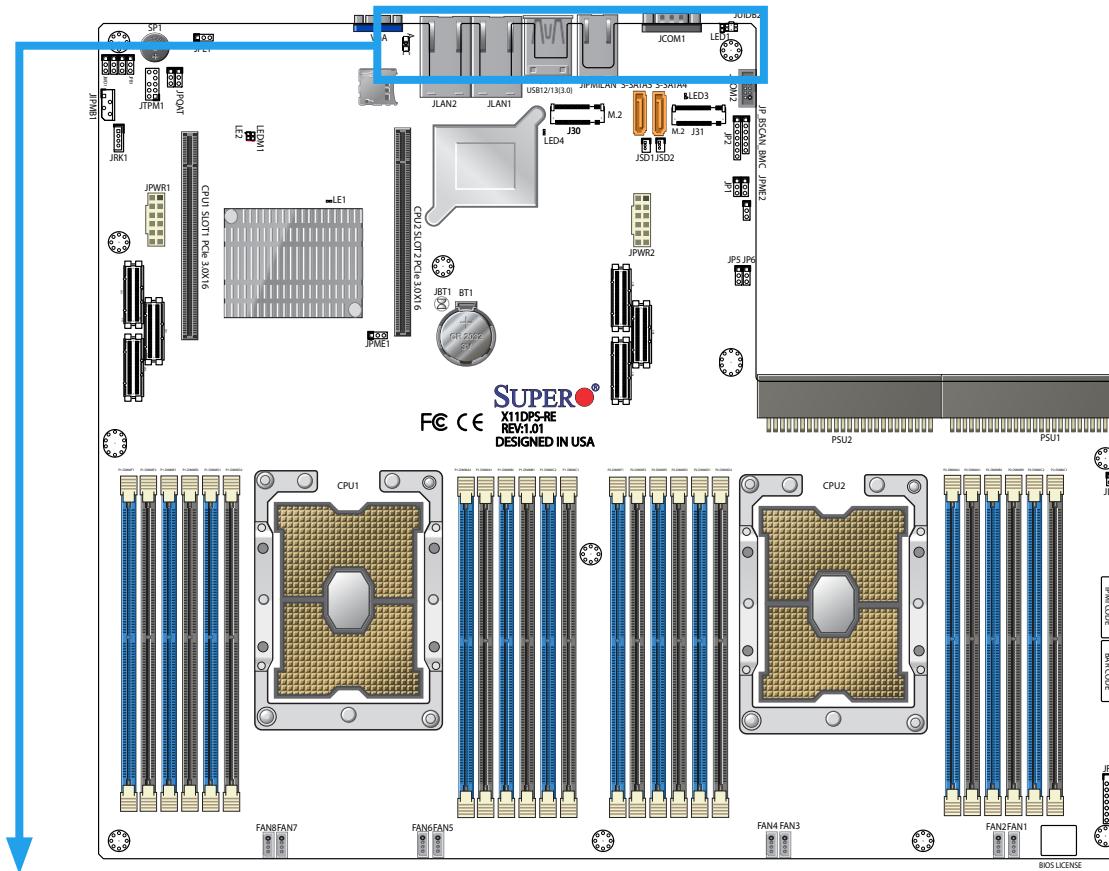

| Back Panel I/O Ports | | | |
|----------------------|---------------------------------|-----|-------------------|
| No. | Description | No. | Description |
| 1. | Unit Identifier Switch (JUIDB2) | 5. | USB13 (3.0) |
| 2. | COM1 (JCOM1) | 6. | LAN Port1 (JLAN1) |
| 3. | IPMI_LAN | 7. | LAN Port2 (JLAN2) |
| 4. | USB12 (3.0) | 8. | VGA |

Serial (COM) Ports

There are two COM connectors (JCOM1/JCOM2) in your system. COM Port 1 (JCOM1) is located on the I/O backplane, and COM Port 2 (JCOM2) is located next to the IO backplane on the motherboard. These COM connectors provide serial communication support. See the layout below for the locations of COM ports.

VGA Port

There is one VGA port on the IO back panel. Connect a VGA cable to this port for the video display.

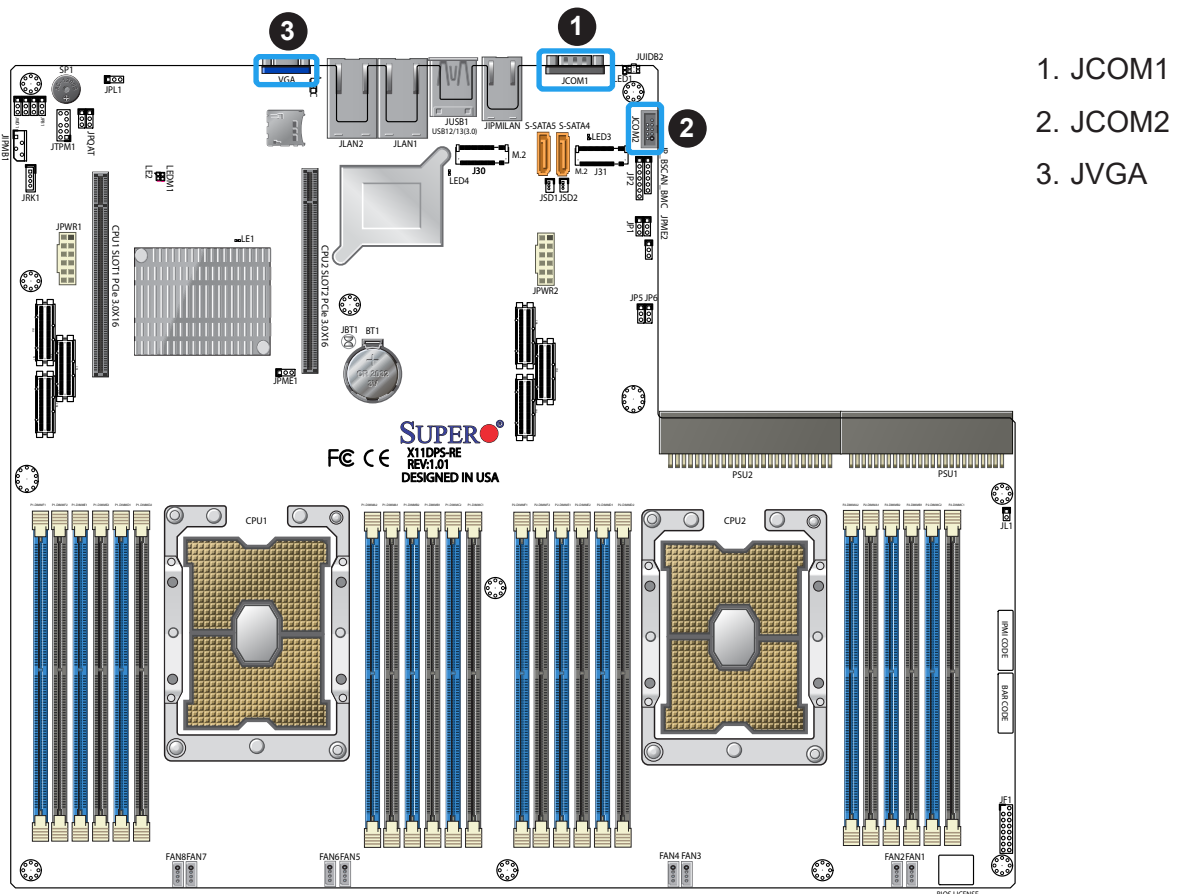

Universal Serial Bus (USB) Ports

There are two USB 3.0 ports (USB12/13) on the I/O back panel located at JUSB1.

| Back Panel USB 12/13 (3.0) Pin Definitions | | | |
|---|------------|------|------------|
| Pin# | Definition | Pin# | Definition |
| A1 | VBUS | B1 | Power |
| A2 | D- | B2 | USB_N |
| A3 | D+ | B3 | USB_P |
| A4 | GND | B4 | GND |
| A5 | Stda_SSRX- | B5 | USB3_RN |
| A6 | Stda_SSRX+ | B6 | USB3_RP |
| A7 | GND | B7 | GND |
| A8 | Stda_SSTX- | B8 | USB3_TN |
| A9 | Stda_SSTX+ | B9 | USB3_TP |

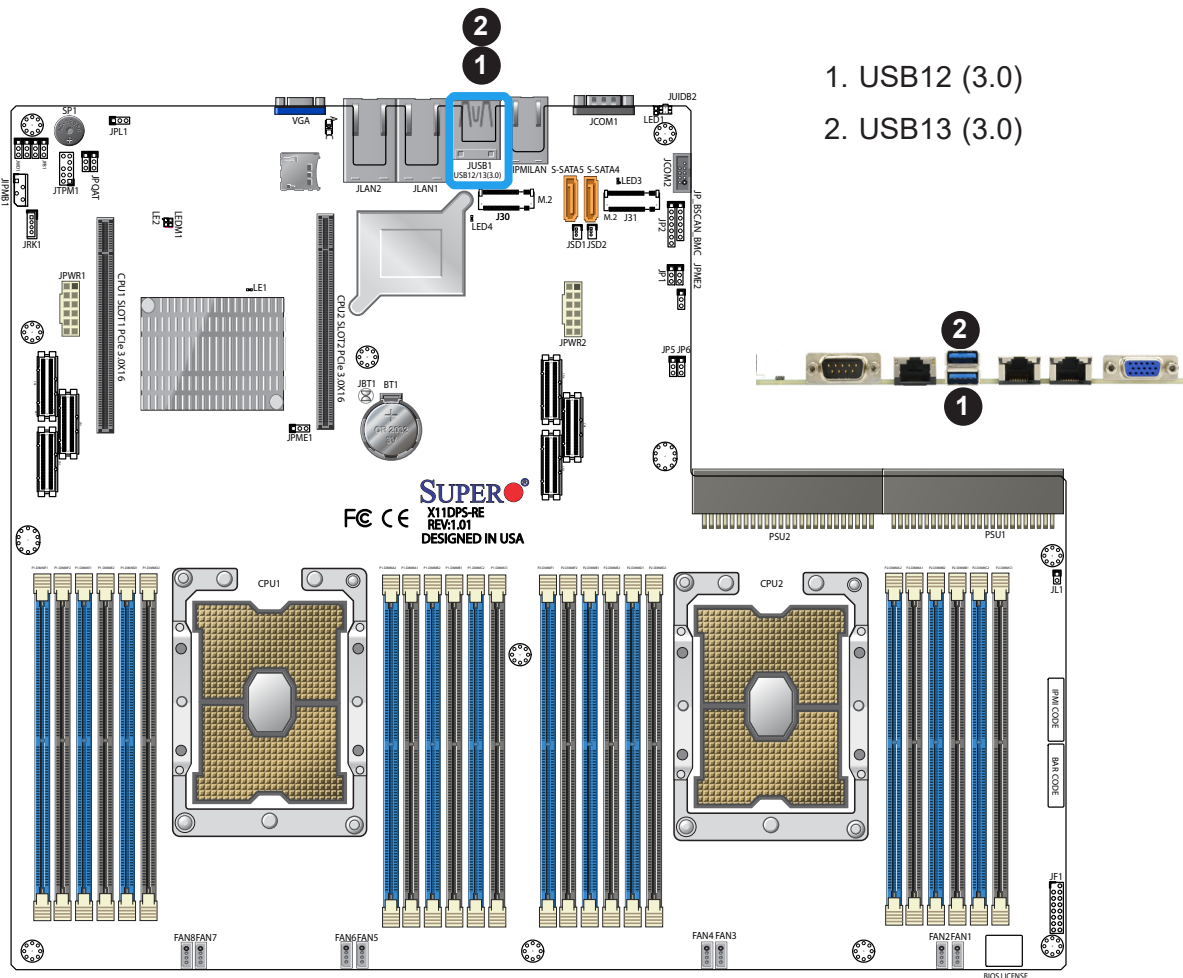

LAN Ports 1/2

Two 10G LAN ports (JLAN1, JLAN2) are located on the I/O back panel. These ports accept RJ45 type cables.

IPMI_LAN Port

An IPMI-dedicated LAN that supports GbE LAN is located on the backplane. Please refer to the LED Indicator Section for LAN LED information.

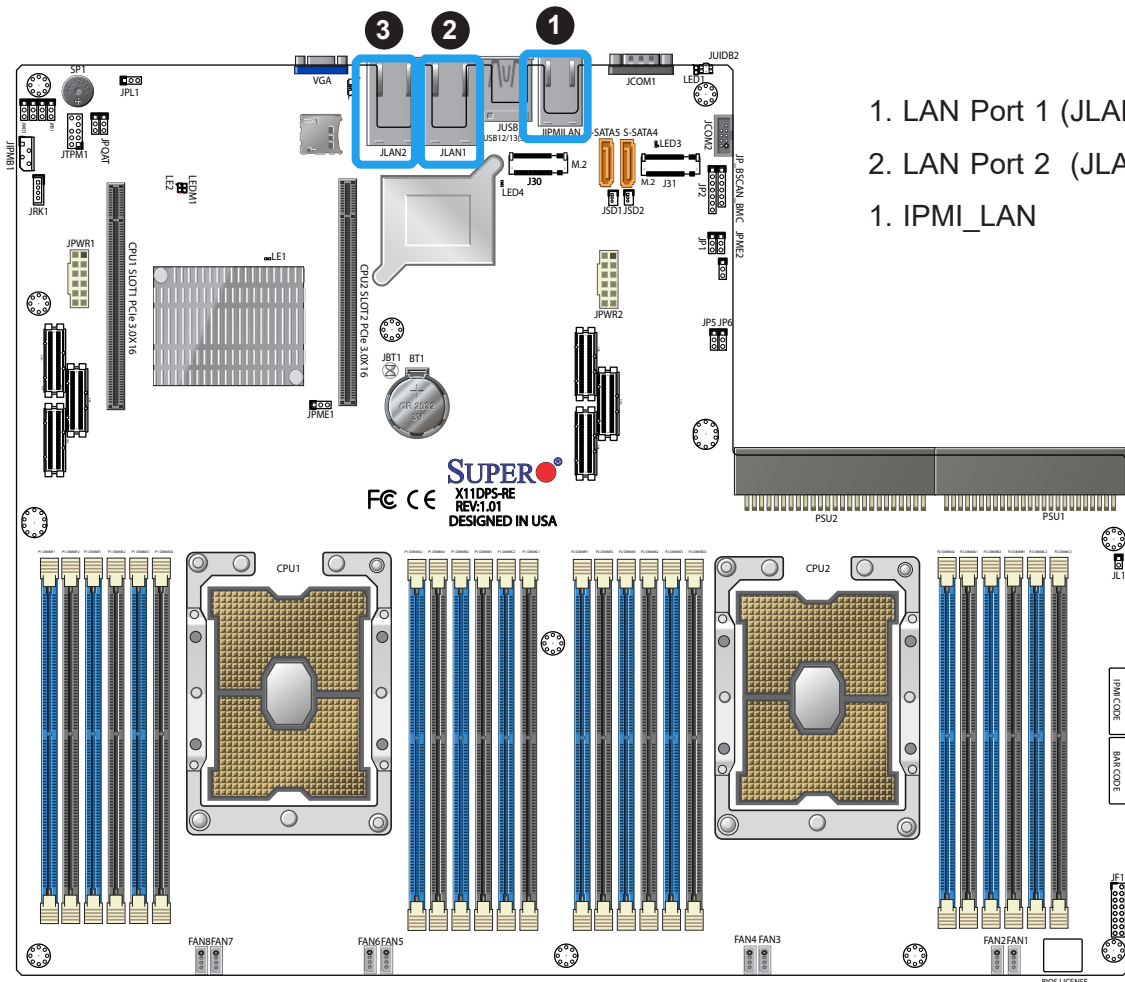

- 1. LAN Port 1 (JLAN1)
- 2. LAN Port 2 (JLAN2)
- 1. IPMI_LAN

2.6 Front Control Panel

JF1 contains header pins for various buttons and indicators that are normally located on a control panel at the front of the chassis. These connectors are designed specifically for use with Supermicro chassis. See the figure below for the descriptions of the front control panel buttons and LED indicators.

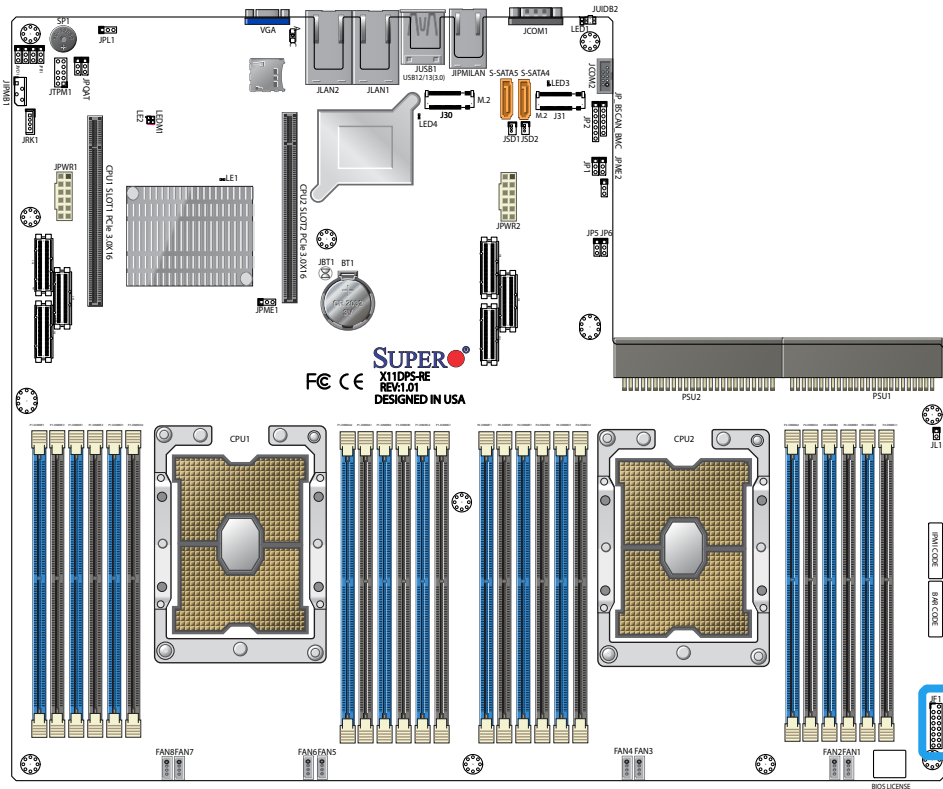

JF1 Header Pins

| | 1 | 2 | |
|--------------|---|---|--------------------------|
| Power Button | ○ | ○ | Ground |
| Reset Button | ○ | ○ | Ground |
| 3.3V | ○ | ○ | Power Fail LED |
| UID LED | ○ | ○ | OH/PWR Fail/Fan Fail LED |
| 3.3V Stby | ○ | ○ | NIC2 Active LED |
| 3.3V Stby | ○ | ○ | NIC1 Active LED |
| 3.3V Stby | ○ | ○ | HDD LED |
| 3.3V | ○ | ○ | PWR LED |

Power Button

The Power Button connection is located on pins 1 and 2 of JF1. Momentarily contacting both pins will power on/off the system. This button can also be configured to function as a suspend button (with a setting in the BIOS - see Chapter 4). To turn off the power when the system is in suspend mode, press the button for 4 seconds or longer. Refer to the table below for pin definitions.

| Power Button Pin Definitions (JF1) | |
|---------------------------------------|------------|
| Pins | Definition |
| 1 | Signal |
| 2 | Ground |

Reset Button

The Reset Button connection is located on pins 3 and 4 of JF1. Attach it to a hardware reset switch on the computer case to reset the system. Refer to the table below for pin definitions.

| Reset Button Pin Definitions (JF1) | |
|---------------------------------------|------------|
| Pins | Definition |
| 3 | Reset |
| 4 | Ground |

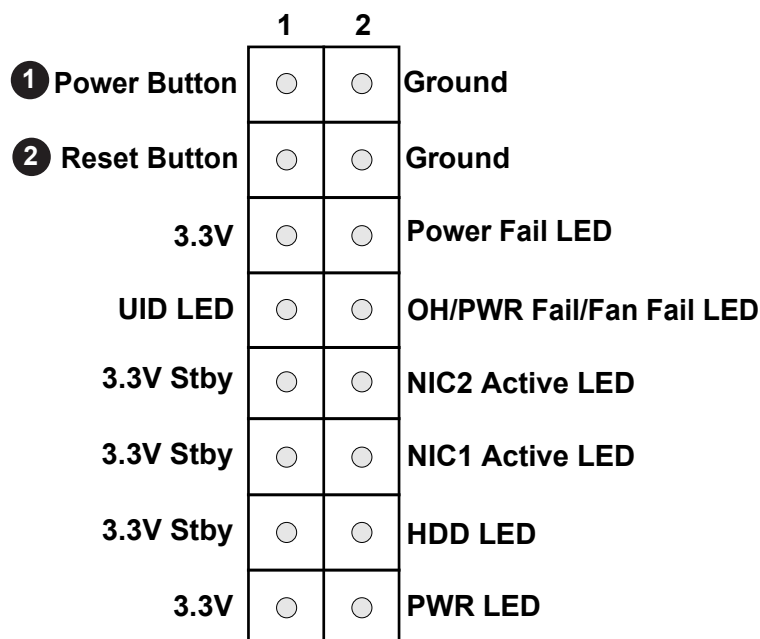

1. PWR Button
2. Reset Button

Power Fail LED

The Power Fail LED connection is located on pins 5 and 6 of JF1. Refer to the table below for pin definitions.

| Power Fail LED Pin Definitions (JF1) | |
|---|-----------------|
| Pin# | Definition |
| 5 | 3.3V |
| 6 | PWR Supply Fail |

OH/Fan Fail/PWR Fail/UID LED

Connect an LED cable to pins 7 and 8 of the Front Control Panel (JF1) to use UID/Overheat/Fan Fail/Power Fail LED connections. The LED on pin 8 provides warnings of overheat, power failure or fan failure. Refer to the tables below for details.

| Information LED-UID/OH/PWR Fail/Fan Fail LED Pin Definitions (Pin 7 & Pin 8 of JF1) | |
|--|--|
| Status | Description |
| Solid red | An overheat condition has occurred. (This may be caused by cable congestion). |
| Blinking red (1Hz) | Fan failure: check for an inoperative fan. |
| Blinking red (0.25Hz) | Power failure: check for a non-operational power supply |
| Solid blue | Local UID is activated. Use this function to locate a unit in a rack mount environment that might be in need of service. |
| Blinking blue (300 msec) | Remote UID is on. Use this function to identify a unit from a remote location that might be in need of service. |

| | 1 | 2 | |
|--------------|---|---|-----------------------------------|
| Power Button | ○ | ○ | Ground |
| Reset Button | ○ | ○ | Ground |
| 3.3V | ○ | ○ | Power Fail LED 1 |
| UID LED | ○ | ○ | OH/PWR Fail/Fan Fail LED 2 |
| 3.3V Stby | ○ | ○ | NIC2 Active LED |
| 3.3V Stby | ○ | ○ | NIC1 Active LED |
| 3.3V Stby | ○ | ○ | HDD LED |
| 3.3V | ○ | ○ | PWR LED |

1. Power Fail LED
2. UID/OH/PWR Fail/Fan Fail LED

NIC1/NIC2 (LAN1/LAN2)

The NIC (Network Interface Controller) LED connection for LAN port 1 is located on pins 11 and 12 of JF1, and LAN port 2 is on pins 9 and 10. Attach the NIC LED cables here to display network activity. Refer to the table below for pin definitions.

| LAN1/LAN2 LED Pin Definitions (JF1) | | | |
|--|------------|------|--------------------|
| Pin# | Definition | Pin# | Definition |
| 9 | +3.3V | 10 | NIC 2 Activity LED |
| 11 | +3.3V | 12 | NIC 1 Activity LED |

HDD LED

The HDD LED connection is located on pins 13 and 14 of JF1. Attach a cable to pin 14 to show hard drive activity status. Refer to the table below for pin definitions.

| HDD LED Pin Definitions (JF1) | |
|----------------------------------|------------|
| Pins | Definition |
| 13 | 3.3V Stdby |
| 14 | HDD Active |

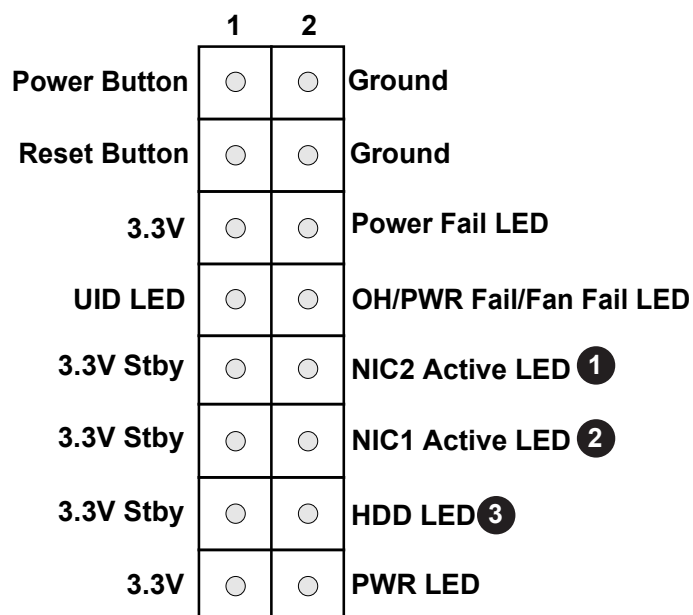

1. NIC2 LED
2. NIC1 LED
3. HDD LED

Unit Identifier Switch/UID LED Indicator

A Unit Identifier (UID) switch and a rear UID LED (LED1) are located on the I/O back panel. A front UID switch is located on pins 7 & 8 of the front panel control (JF1). When you press the front or the rear UID switch, both front and rear UID LEDs will be turned on. Press the UID switch again to turn off the LED indicators. The UID indicators provide easy identification of a system that may be in need of service. (**Note:** UID can also be triggered via IPMI on the motherboard. For more information, please refer to the IPMI User's Guide posted on our website at <http://www.supermicro.com>.)

| UID Switch Pin Definitions | |
|----------------------------|------------|
| Pin# | Definition |
| 1 | Ground |
| 2 | Ground |
| 3 | Button In |
| 4 | Button In |

| UID LED Pin Definitions | |
|-------------------------|-----------------|
| Color | Status |
| Blue: On | Unit Identified |

| | 1 | 2 | |
|------------------|---|---|---------------------------------|
| Power Button | ○ | ○ | Ground |
| Reset Button | ○ | ○ | Ground |
| 3.3V | ○ | ○ | Power Fail LED |
| 3 UID LED | ○ | ○ | OH/PWR Fail/Fan Fail LED |
| 3.3V Stby | ○ | ○ | NIC2 Active LED |
| 3.3V Stby | ○ | ○ | NIC1 Active LED |
| 3.3V Stby | ○ | ○ | HDD LED |
| 3.3V | ○ | ○ | PWR LED |

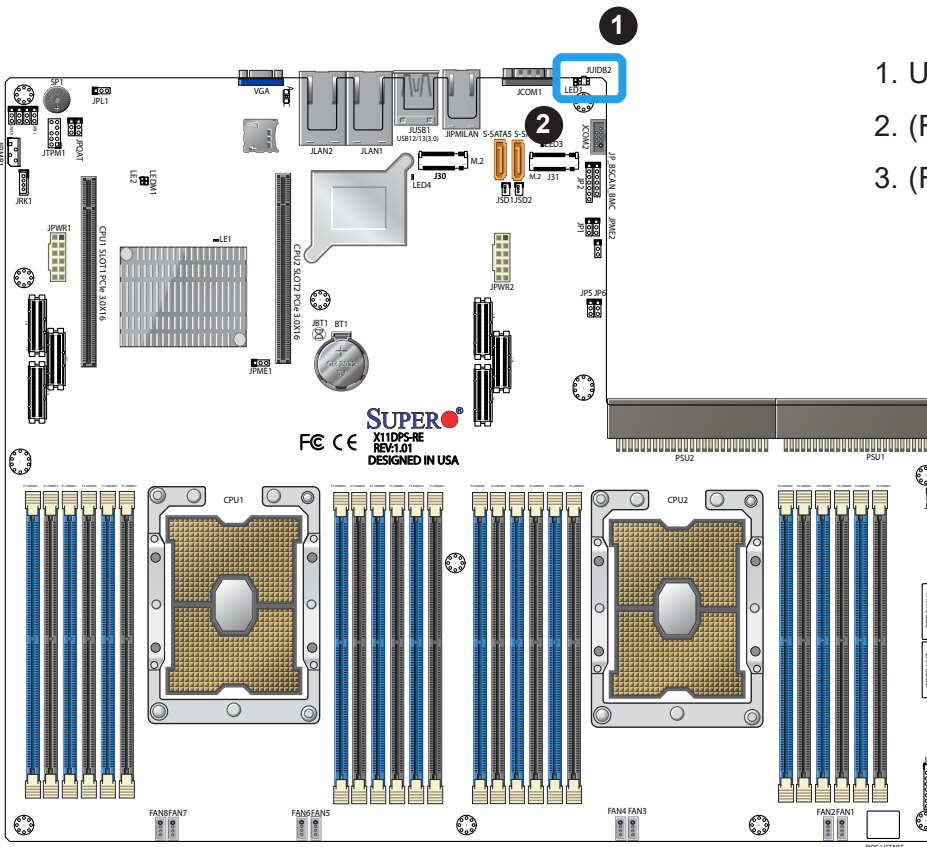

1. UID (JUIDB2)
2. (Rear) UID LED (LED1)
3. (Front) UID LED

Power LED

The Power LED connection is located on pins 15 and 16 of JF1. Refer to the table below for pin definitions.

| Power LED Pin Definitions (JF1) | |
|------------------------------------|------------|
| Pins | Definition |
| 15 | 3.3V |
| 16 | PWR LED |

| | 1 | 2 | |
|--------------|---|---|--------------------------|
| Power Button | ○ | ○ | Ground |
| Reset Button | ○ | ○ | Ground |
| 3.3V | ○ | ○ | Power Fail LED |
| UID LED | ○ | ○ | OH/PWR Fail/Fan Fail LED |
| 3.3V Stby | ○ | ○ | NIC2 Active LED |
| 3.3V Stby | ○ | ○ | NIC1 Active LED |
| 3.3V Stby | ○ | ○ | HDD LED |
| 3.3V | ○ | ○ | PWR LED ① |

1. PWR LED

2.7 Connectors

Power Connectors

SMCI-Proprietary Power Connectors

Two SMCI-proprietary Power Supply Unit connectors, located at PSU1/PSU2, provide main power to your system. Please note that these power connectors are reserved for Supermicro system use only.

PCIe-Proprietary Power Connectors

JPWR1/2 are 12-pin power connectors designed for proprietary PCIe-based backplane memory use. Connect appropriate power cables here to provide power to your PCIe devices.

| 12V 8-pin Power Pin Definitions | |
|---------------------------------|------------|
| Pin# | Definition |
| 1 - 6 | Ground |
| 7 - 12 | +12V |

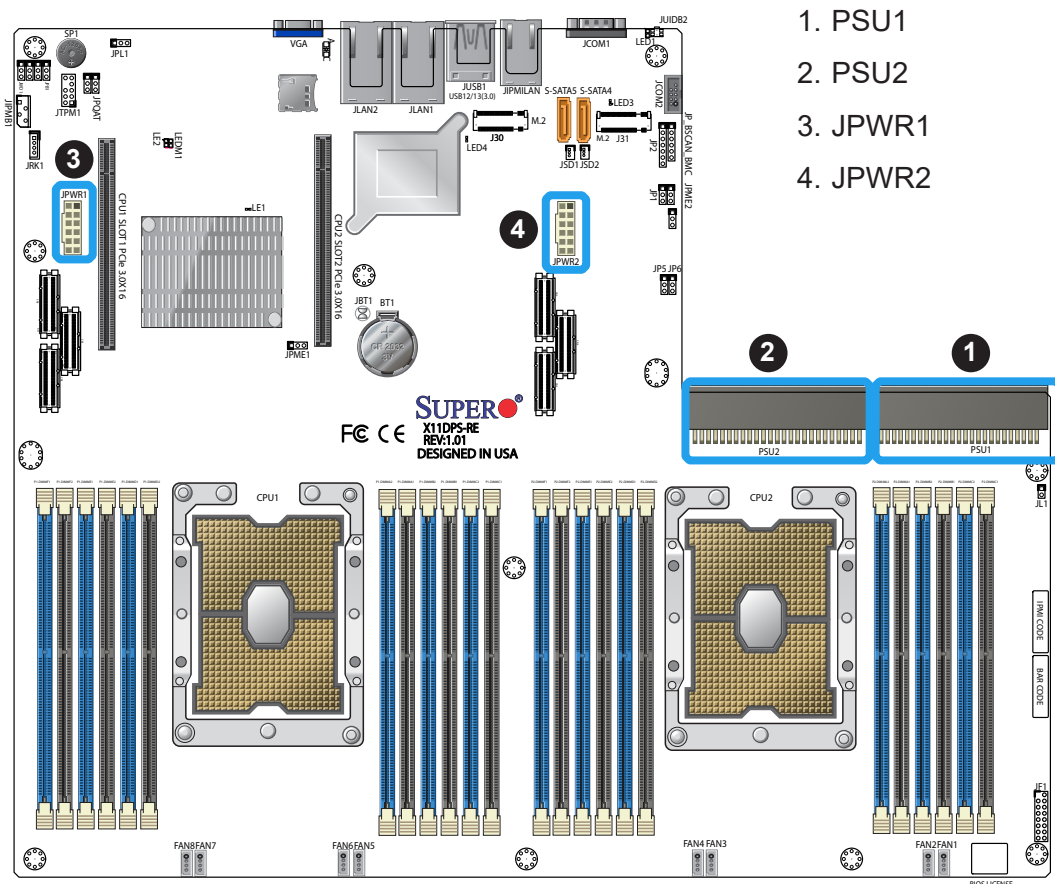

1. PSU1
2. PSU2
3. JPWR1
4. JPWR2

Headers

Onboard Fan Header

This motherboard has eight headers (FAN1~8). All these 4-pin fan headers are backward-compatible with traditional 3-pin fans. However, onboard fan speed control is available only when all 4-pin fans are used on the motherboard. Onboard fan speeds are controlled by thermal management via the BMC (or by IPMI). See the table below for pin definitions.

| Fan Header Pin Definitions | |
|----------------------------|----------------|
| Pin# | Definition |
| 1 | Ground (Black) |
| 2 | +12V (Red) |
| 3 | Tachometer |
| 4 | PWM Control |

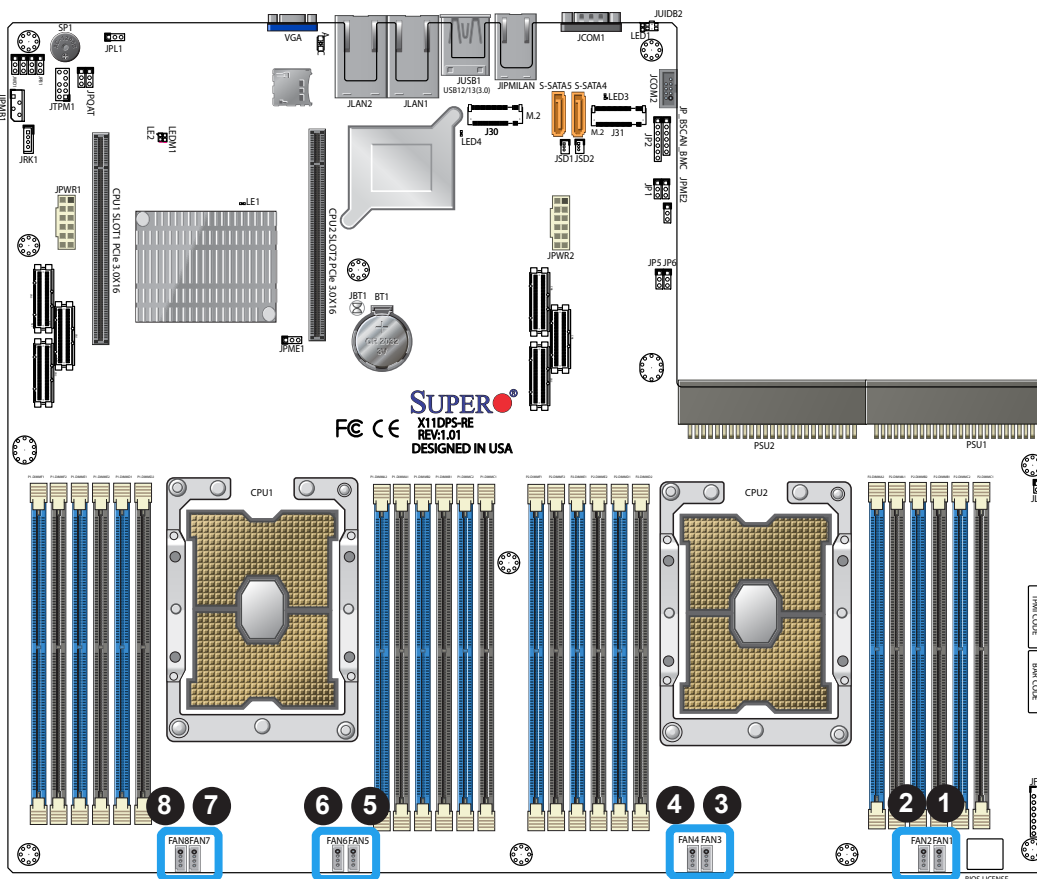

1. FAN 1
2. FAN 2
3. FAN 3
4. FAN 4
5. FAN 5
6. FAN 6
7. FAN 7
8. FAN 8

TPM Header

The Trusted Platform Module (TPM)/Port 80 is located at JTPM1 and is available from SMC1 (optional). A TPM/Port 80 connector is a security device that supports encryption and authentication in hard drives. It allows the motherboard to deny access if the TPM associated with the hard drive is not installed in the system. See the table below for pin definitions.

| TPM/Port 80 Header Pin Definitions | | | |
|---------------------------------------|--------------|-------|------------|
| Pin # | Definition | Pin # | Definition |
| 1 | +3.3V | 2 | SPI_CS# |
| 3 | RESET# | 4 | SPI_MISO |
| 5 | SPI_CLK | 6 | GND |
| 7 | SPI_MOSI | 8 | |
| 9 | +3.3V Stdbby | 10 | SPI_IRQ |

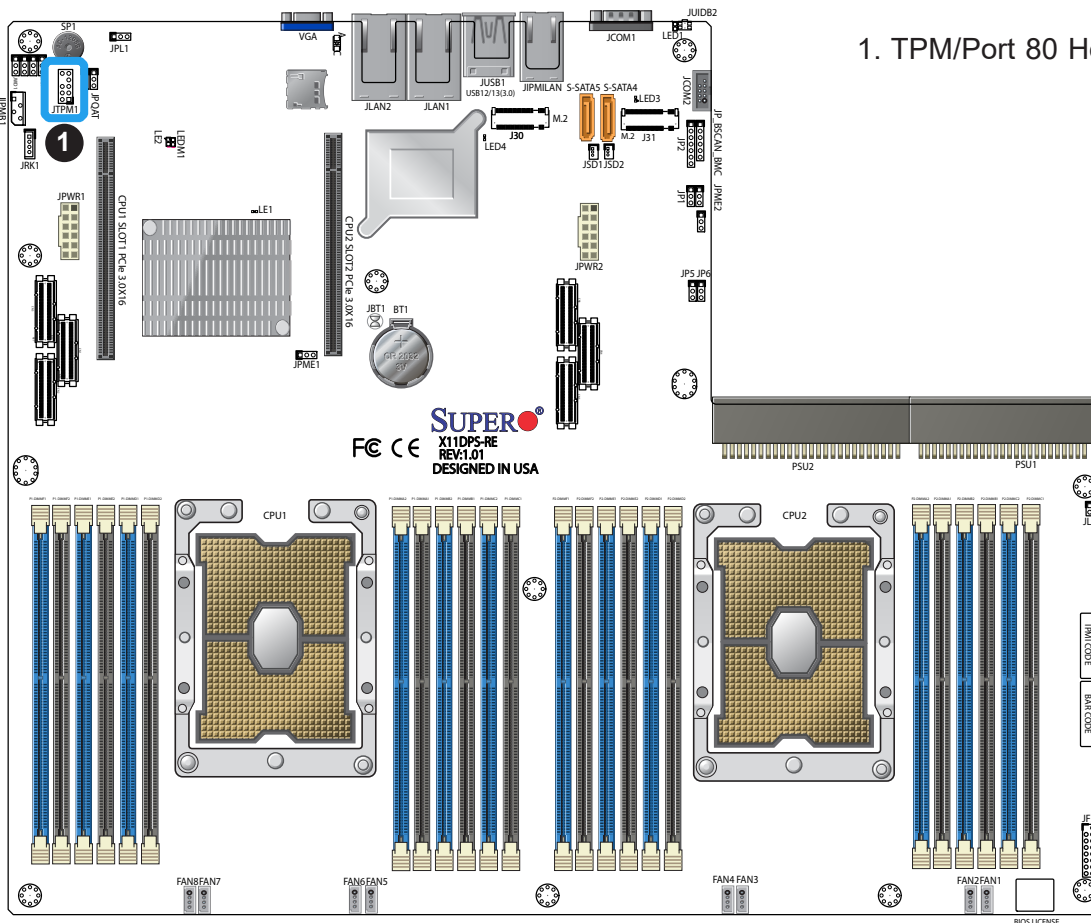

1. TPM/Port 80 Header

VROC RAID Key Header

A VROC RAID Key header is located at JRK1 on the motherboard. Install a VROC RAID Key on JRK1 for NVMe RAID support as shown in the illustration below. Please refer to the layout below for the location of JRK1.

| Intel VROC Key Pin Definitions | |
|--------------------------------|--------------|
| Pin# | Definition |
| 1 | Ground |
| 2 | 3.3V Standby |
| 3 | Ground |
| 4 | PCH RAID Key |

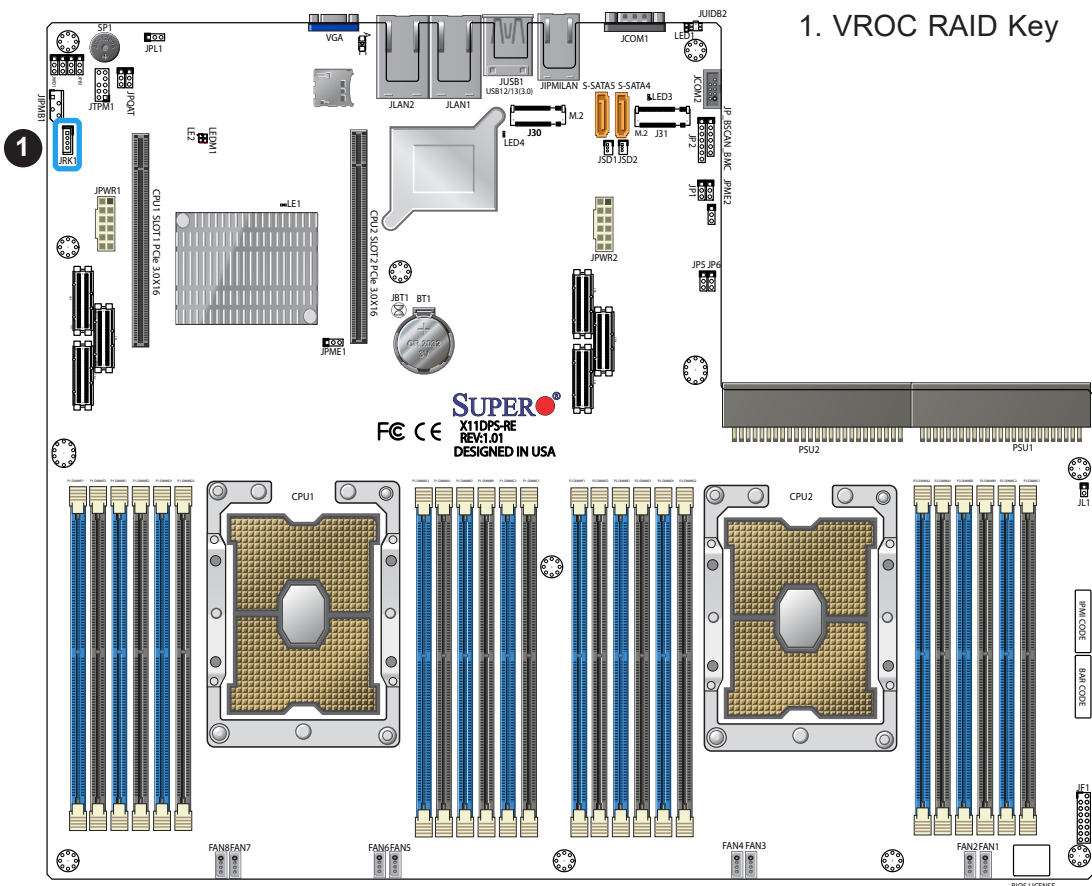
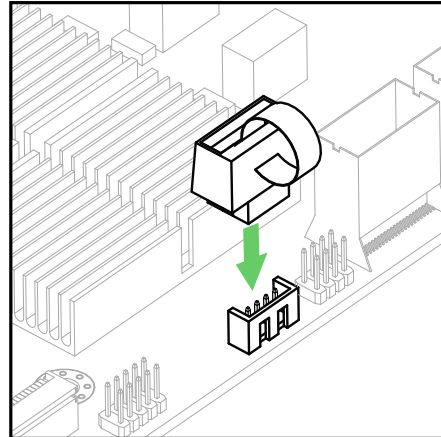

Chassis Intrusion

A Chassis Intrusion header is located at JL1 on the motherboard. Connect an appropriate cable from JL1 to the chassis so that you can be informed of a chassis intrusion (via IPMI). Refer to the table below for pin definitions.

| Chassis Intrusion Pin Definitions | |
|-----------------------------------|-----------------|
| Pin# | Definition |
| 1 | Intrusion Input |
| 2 | Ground |

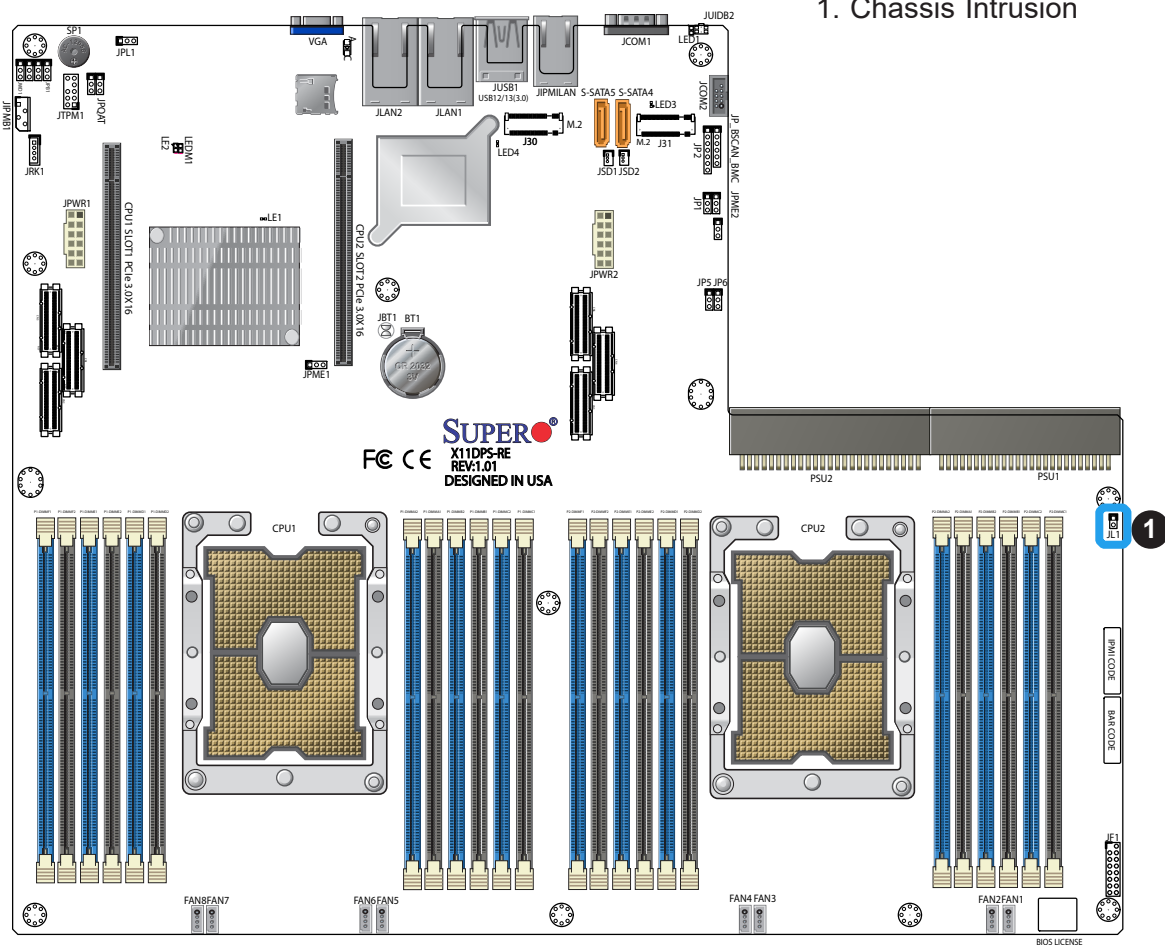

NVMe Slots (PCIe 3.0 x32)

There are two PCIe 3.0 x32 slots with Tray Cable Connector Interface support on the motherboard. These slots offer 32 NVMe connections which support 36 drives (32 NVMe NF1 + 4 SATA3 M.2).

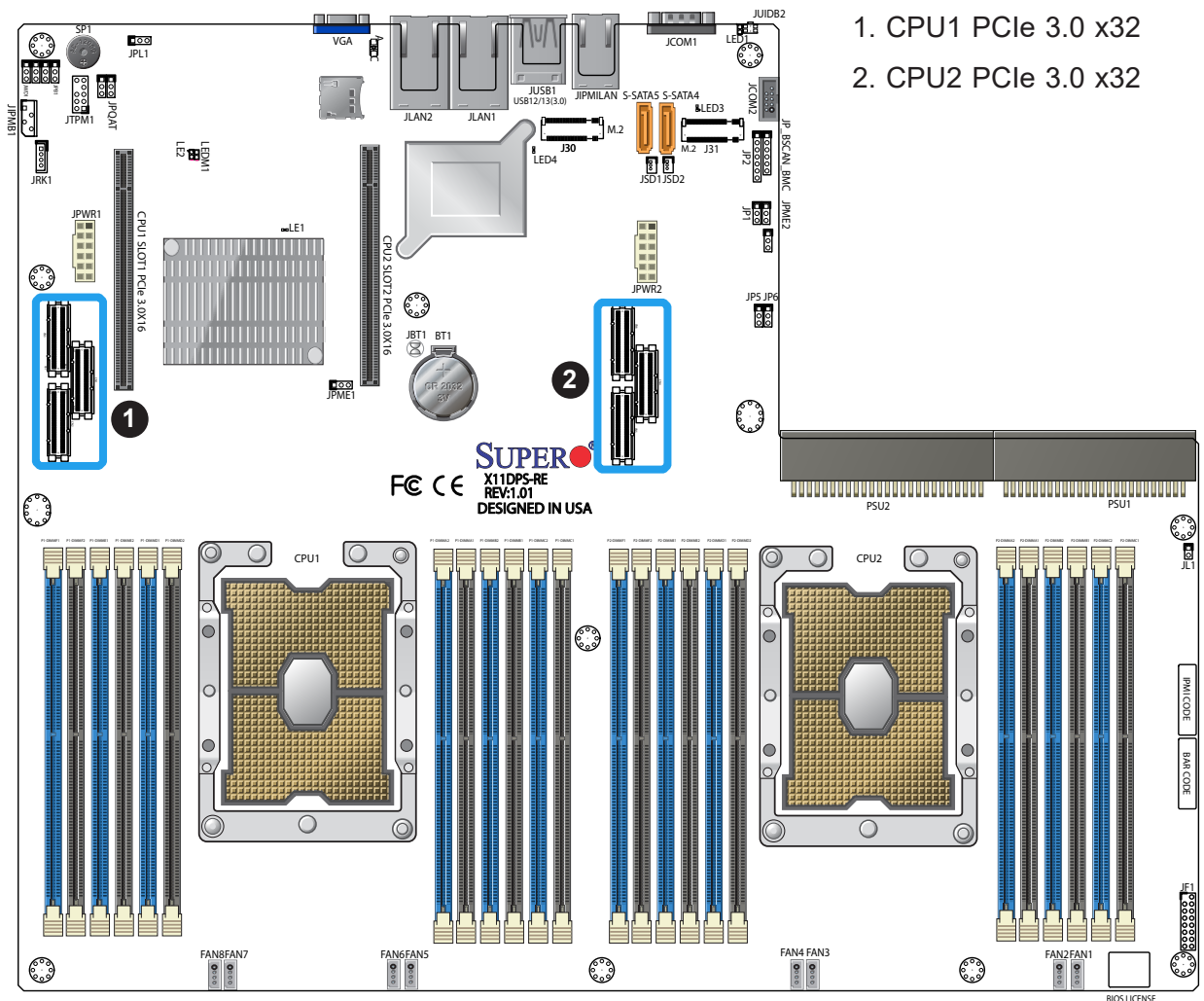

PCIe 3.0 Slots

There are two PCIe 3.0 x16 slots located on the motherboard. CPU1 SLOT1 PCIe and CPU2 SLOT2 PCIe are supported by their corresponding CPU's, and offer riser card support.

 **Note:** To avoid causing interference with other components, please be sure to use an add-on card that is fully compliant with the PCI-standard on a PCI slot.

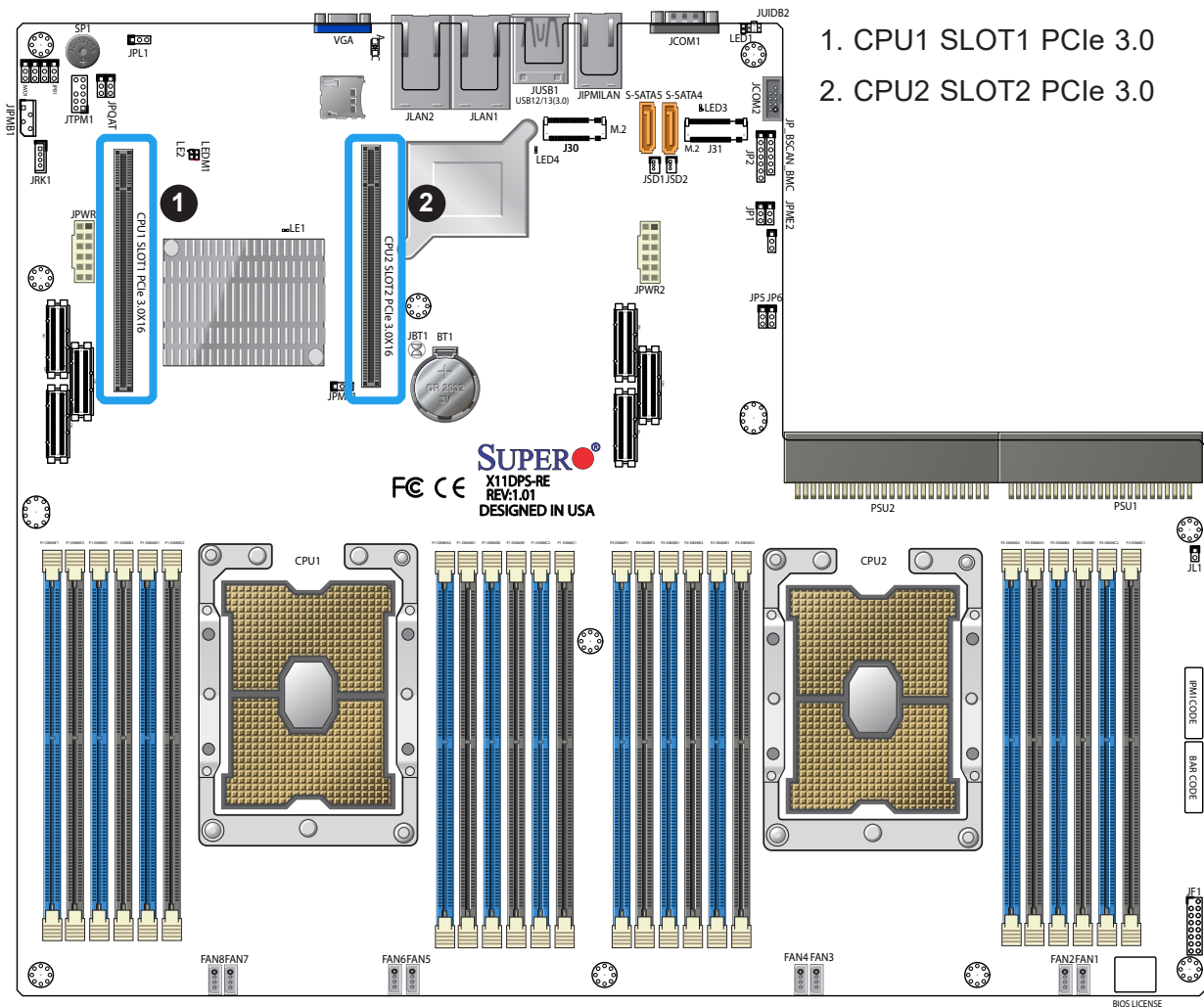

PCIe/SATA Hybrid M.2 Slots

The X11DPS-RE motherboard has two PCIe/SATA Hybrid M.2 slots: J30 (SLOT1) and J31 (SLOT2). M.2 was formerly Next Generation Form Factor (NGFF) and serves to replace mini PCIe. M.2 allows for a variety of card sizes, increased functionality, and spatial efficiency. The M.2 sockets on the motherboard support PCIe 3.0 X4 (32 Gb/s) SSD cards in the 2260, 2280 and 22110 form factors.

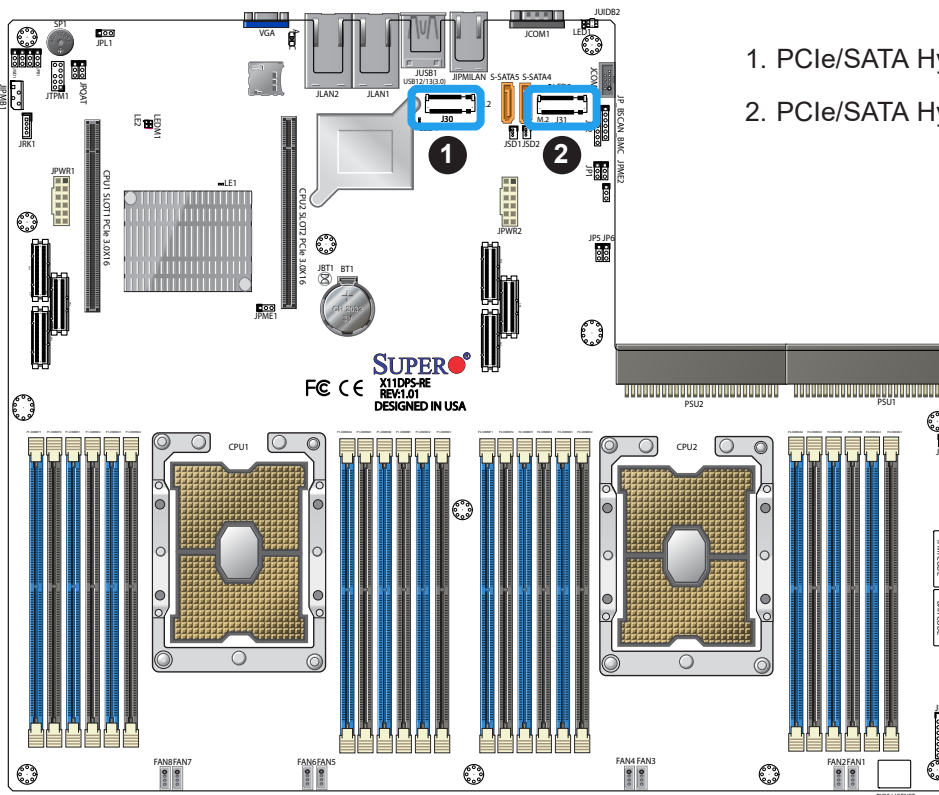
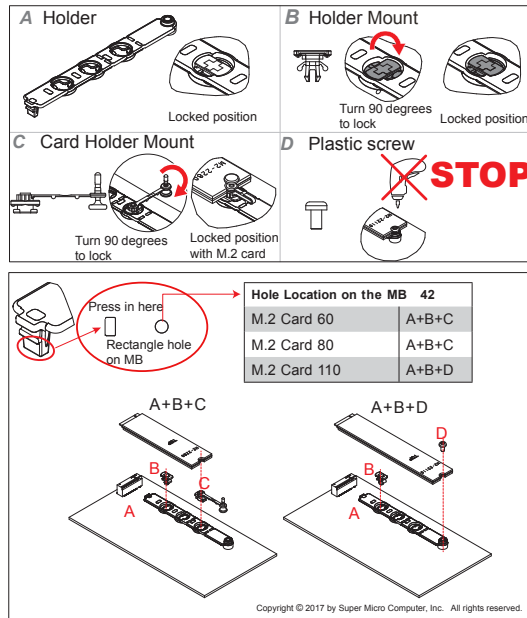

S-SATA 3.0 Ports

The X11DPS-RE has two SATA DOM 3.0 ports (S-SATA4, S-SATA5). S-SATA4/S-SATA5 can be used with Supermicro SuperDOMs which are yellow SATA DOM connectors with power pins built in, and do not require external power cables. Supermicro SuperDOMs are backward-compatible with regular SATA HDDs or SATA DOMs that need external power cables. All these SATA ports provide serial-link signal connections, which are faster than the connections of Parallel ATA.

| SATA 3.0 Port Pin Definitions | |
|-------------------------------|----------|
| Pin# | Signal |
| 1 | Ground |
| 2 | SATA_TXP |
| 3 | SATA_TXN |
| 4 | Ground |
| 5 | SATA_RXN |
| 6 | SATA_RXP |
| 7 | Ground |

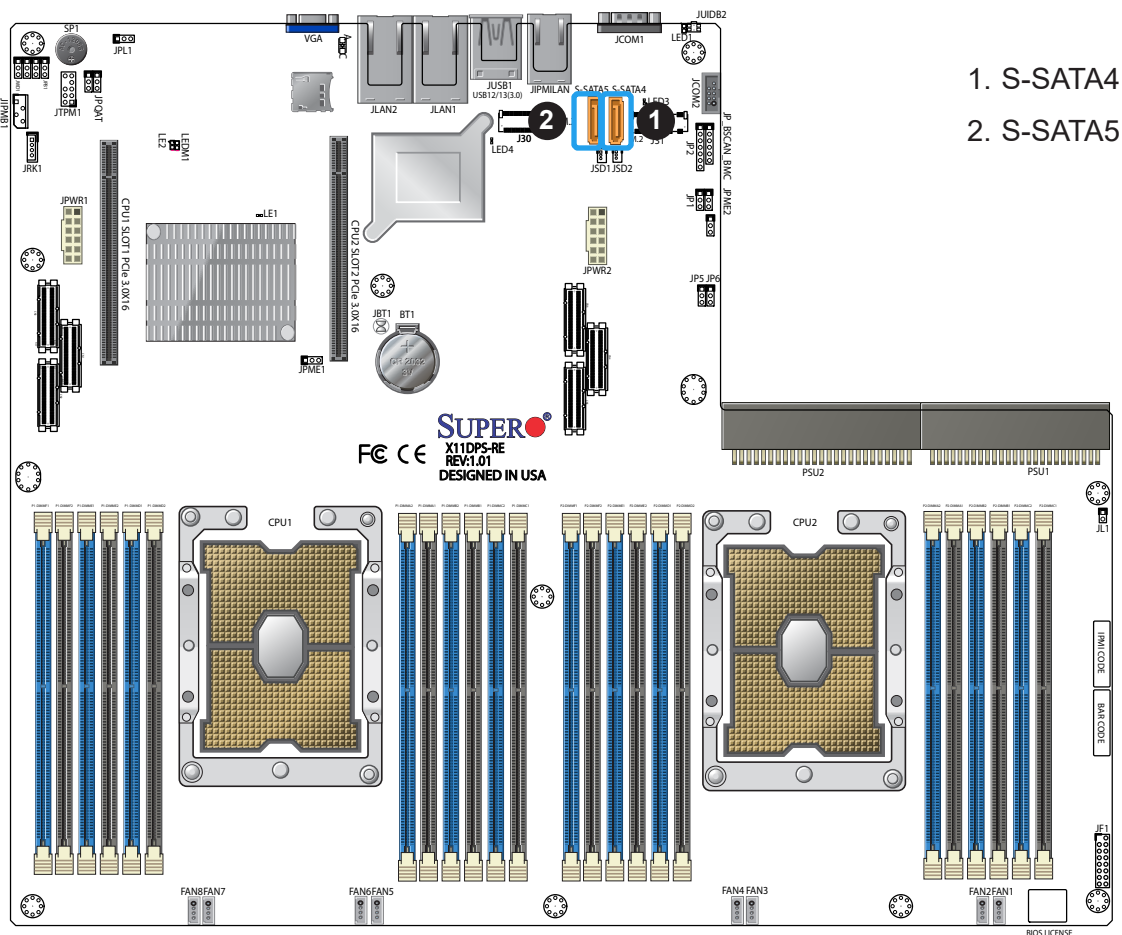

2.8 Jumper Settings

How Jumpers Work

Jumpers are used to modify the operation of the motherboard by creating shorts between two pins to change the function of the connector. In this case, jumpers can be used to choose between optional settings. Pin 1 is identified with a square solder pad on the printed circuit board. See the diagram at right for an example of jumping pins 1 and 2. Refer to the motherboard layout page for jumper locations.

 **Note:** On two-pin jumpers, "Closed" means the jumper is on and "Open" means the jumper is off the pins.

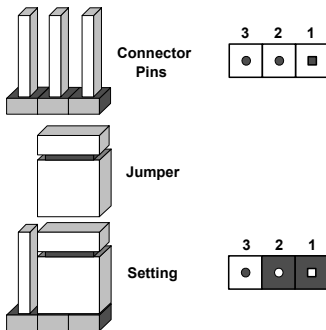

CMOS Clear

JBT1 is used to clear CMOS and will also clear any passwords. Instead of pins, this jumper consists of contact pads to prevent accidentally clearing the contents of CMOS.

To Clear CMOS

1. First power down the system and unplug the power cord(s).
2. Remove the cover of the chassis to access the motherboard.
3. Remove the onboard battery from the motherboard.
4. Short the CMOS pads with a metal object such as a small screwdriver for at least four seconds.
5. Remove the screwdriver (or shorting device).
6. Replace the cover, reconnect the power cord(s), and power on the system.



Note: Clearing CMOS will also clear all passwords.

Do not use the PW_ON connector to clear CMOS.



JBT1 contact pads

1. Clear CMOS

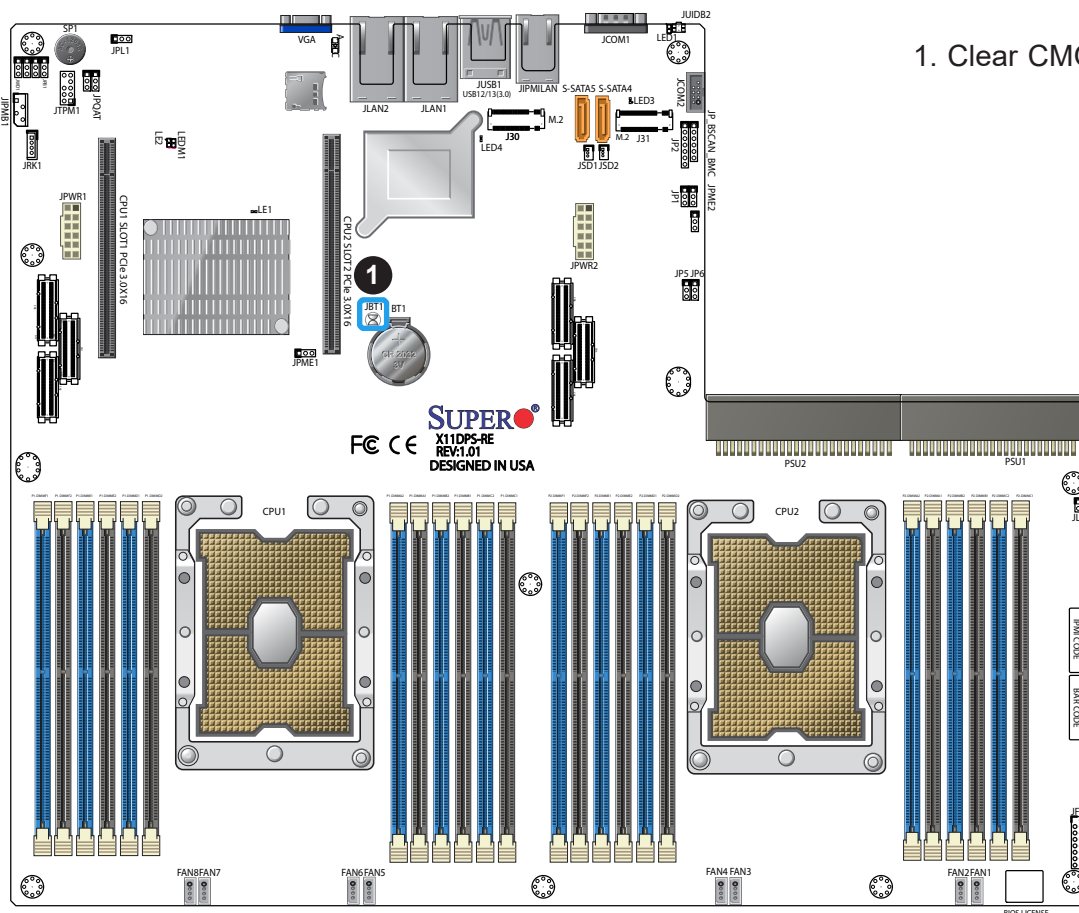

Internal Speaker/Buzzer

The Internal Speaker/Buzzer (SP1) is used to provide audible indications for various beep codes. Refer to the table below for pin definitions.

| Internal Buzzer Pin Definitions | | |
|------------------------------------|------------|---------------|
| Pin# | Definition | |
| 1 | Pos (+) | Beep In |
| 2 | Neg (-) | Alarm Speaker |

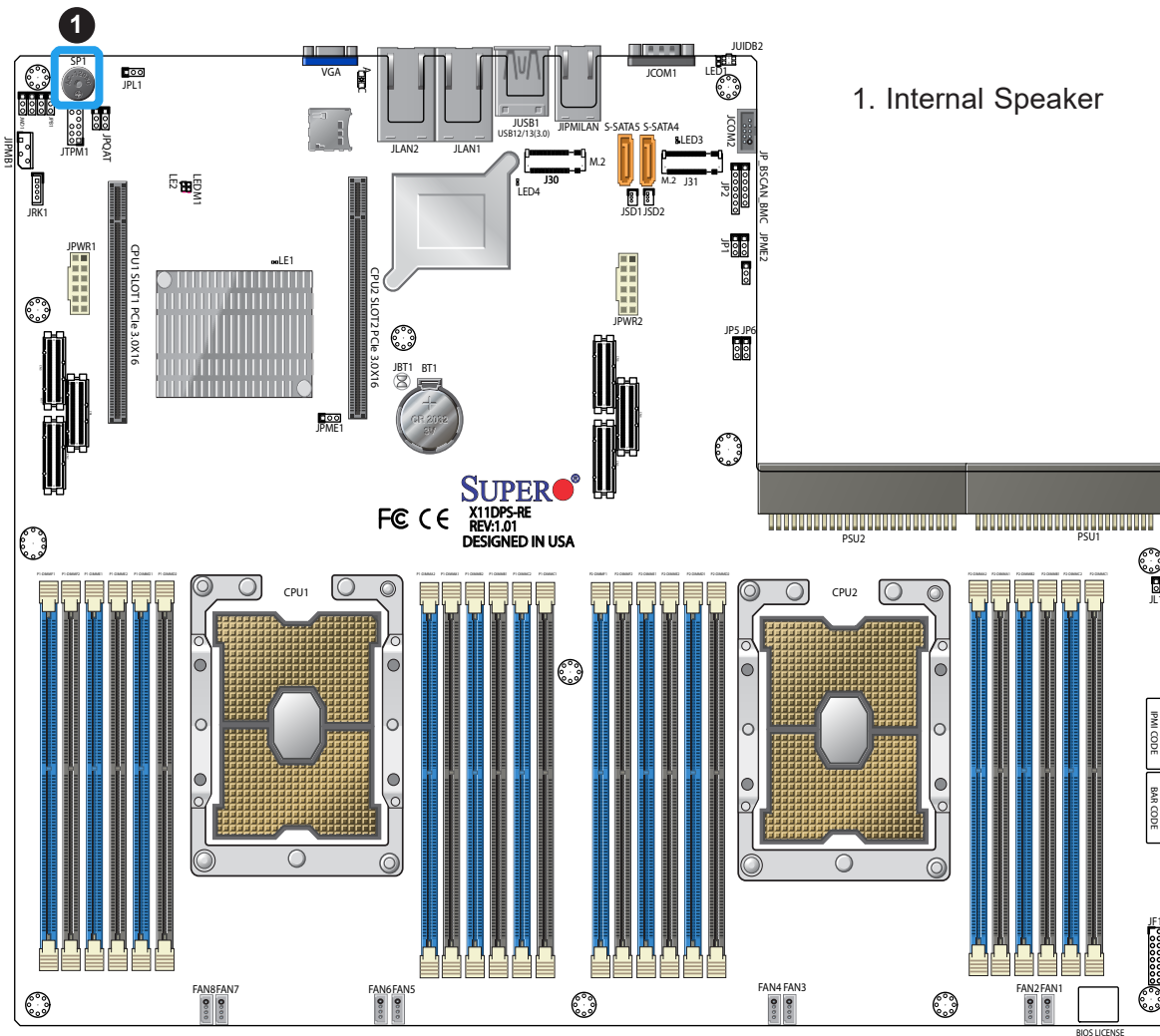

Management Engine (ME) Recovery

Use jumper JPME1 to select ME Firmware Recovery mode, which will limit resource allocation for essential system operation only in order to maintain normal power operation and management. In the single operation mode, online upgrade will be available via ME Recovery mode. See the table below for jumper settings.

| ME Recovery Mode Jumper Settings | |
|----------------------------------|------------------|
| Jumper Setting | Definition |
| Pins 1-2 | Normal (Default) |
| Pins 2-3 | ME Recovery |

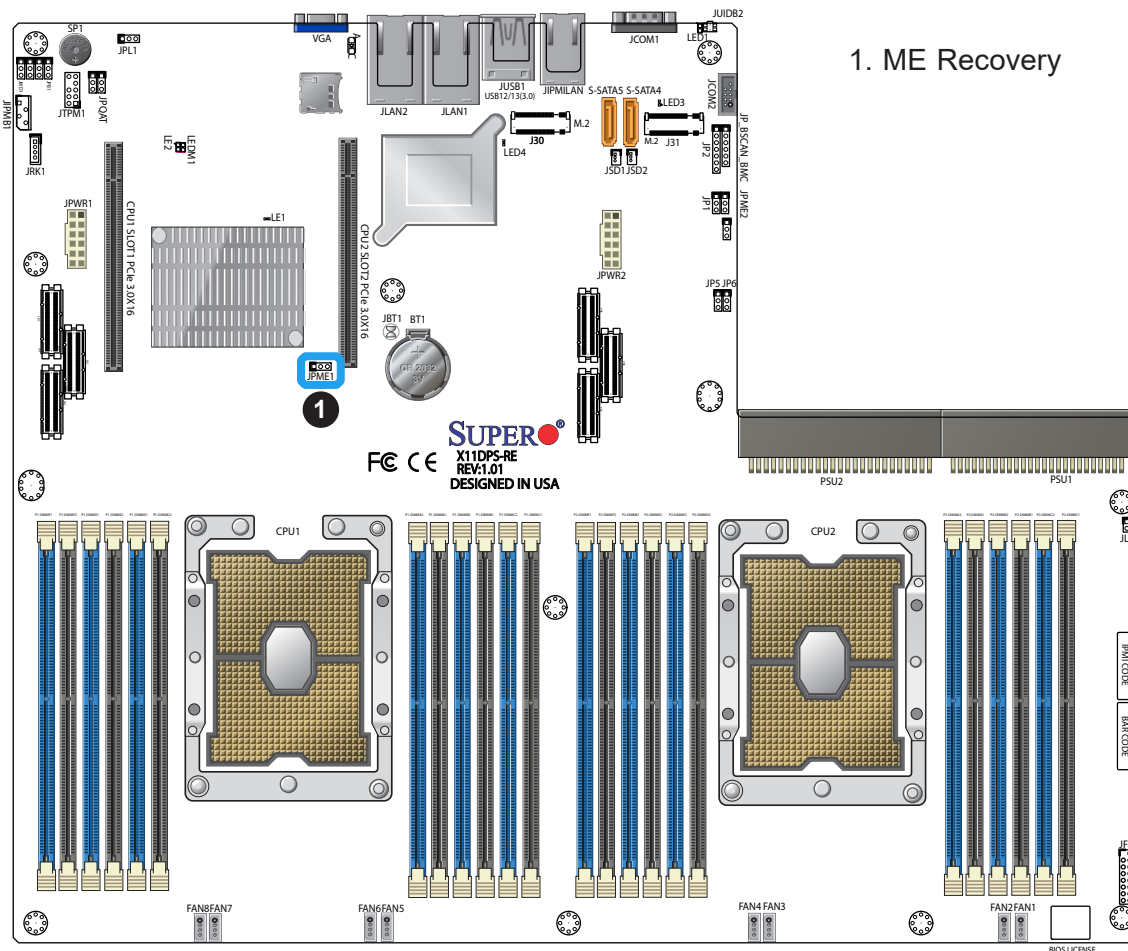

Manufacturing Mode Select

Close JPME2 to bypass SPI flash security and force the system to use the Manufacturing Mode, which will allow you to flash the system firmware from a host server to modify system settings. See the table below for jumper settings.

| Manufacturing Mode Select Jumper Settings | |
|---|--------------------|
| Jumper Setting | Definition |
| Pins 1-2 | Normal (Default) |
| Pins 2-3 | Manufacturing Mode |

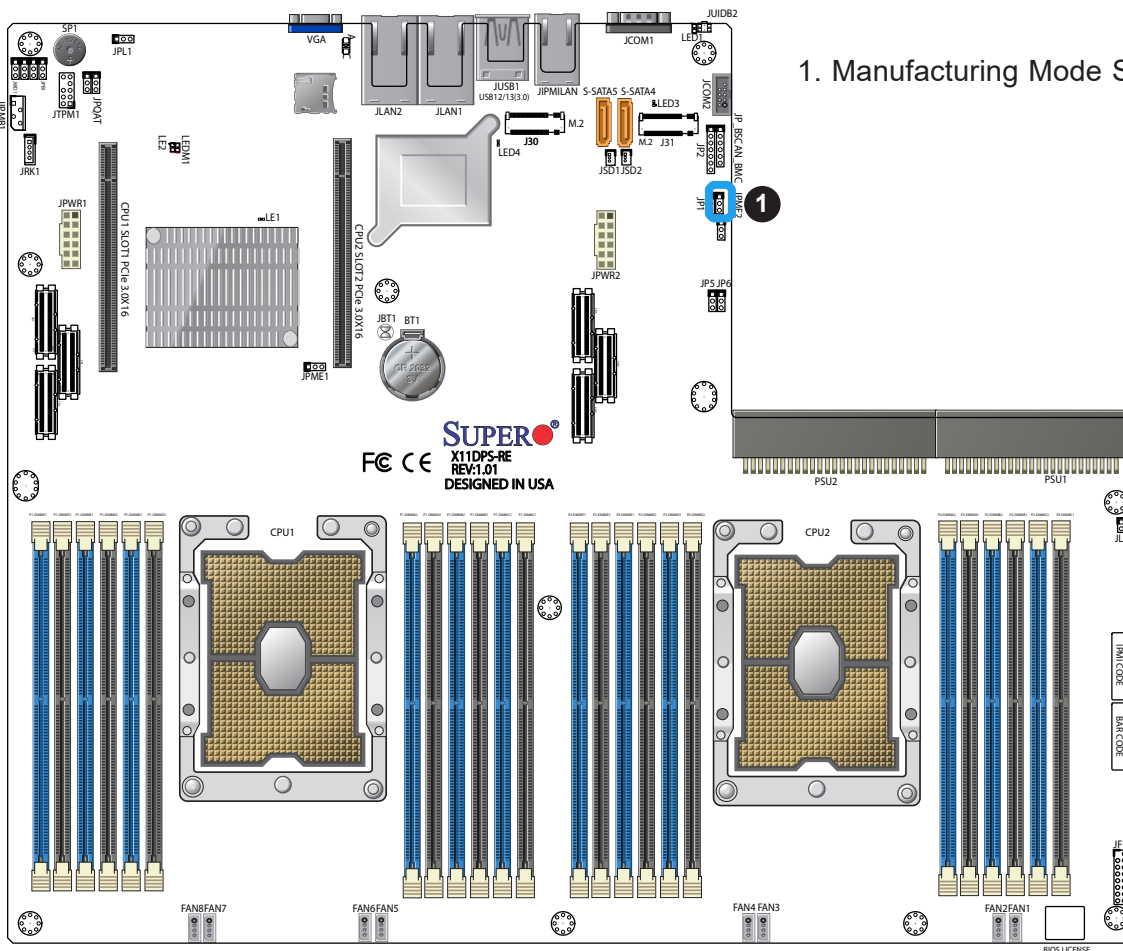

1. Manufacturing Mode Select

Watch Dog Timer Jumper

Jumper JWD1 controls the function of Watch Dog timer. Watch Dog timer is a monitor that can reboot the system when a software application hangs. Closing pins 1-2 will cause Watch Dog to reset the system if an application hangs. Closing pins 2-3 will generate a non-maskable interrupt signal for the application that hangs. For this jumper to work properly, this feature must also be enabled in BIOS. The default setting is Reset.

 **Note:** When Watch Dog is enabled, the user needs to write their own application software to disable it.

| Watch Dog Jumper Settings | |
|---------------------------|------------|
| Jumper Setting | Definition |
| Pins 1-2 | Reset |
| Pins 2-3 | NMI |
| Open | Disabled |

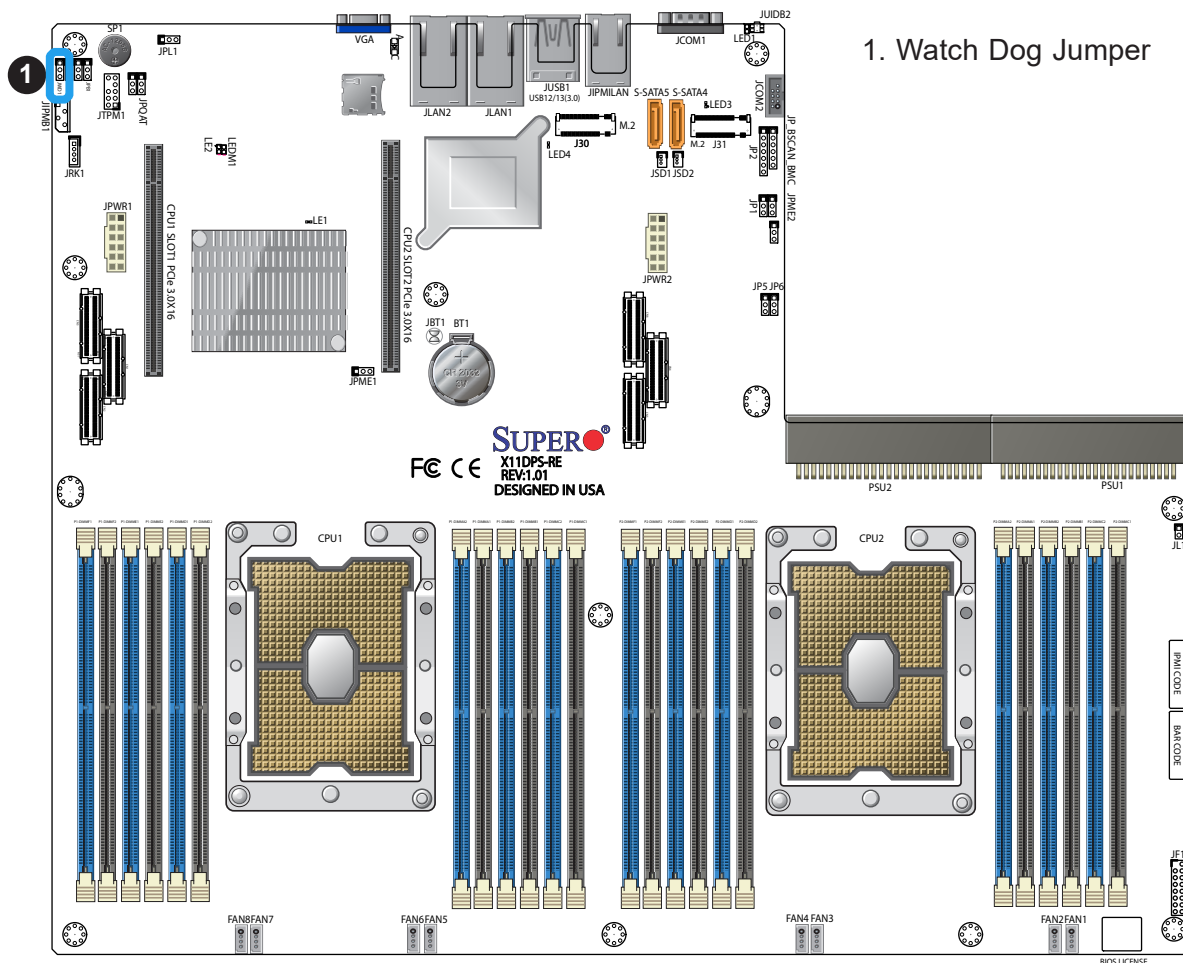

2.9 LED Indicators

IPMI-Dedicated LAN LEDs

An IPMI-dedicated LAN is located on the I/O Backplane of the motherboard. The amber LED on the right indicates activity, while the green LED on the left indicates the speed of the connection. See the tables at right for more information.

| IPMI_LAN Link LED (Left) & Activity LED (Right) | | |
|---|-----------------|------------|
| Color | State | Definition |
| Link (Left) | Green: Solid | 100 Mbps |
| Activity (Right) | Amber: Blinking | Active |

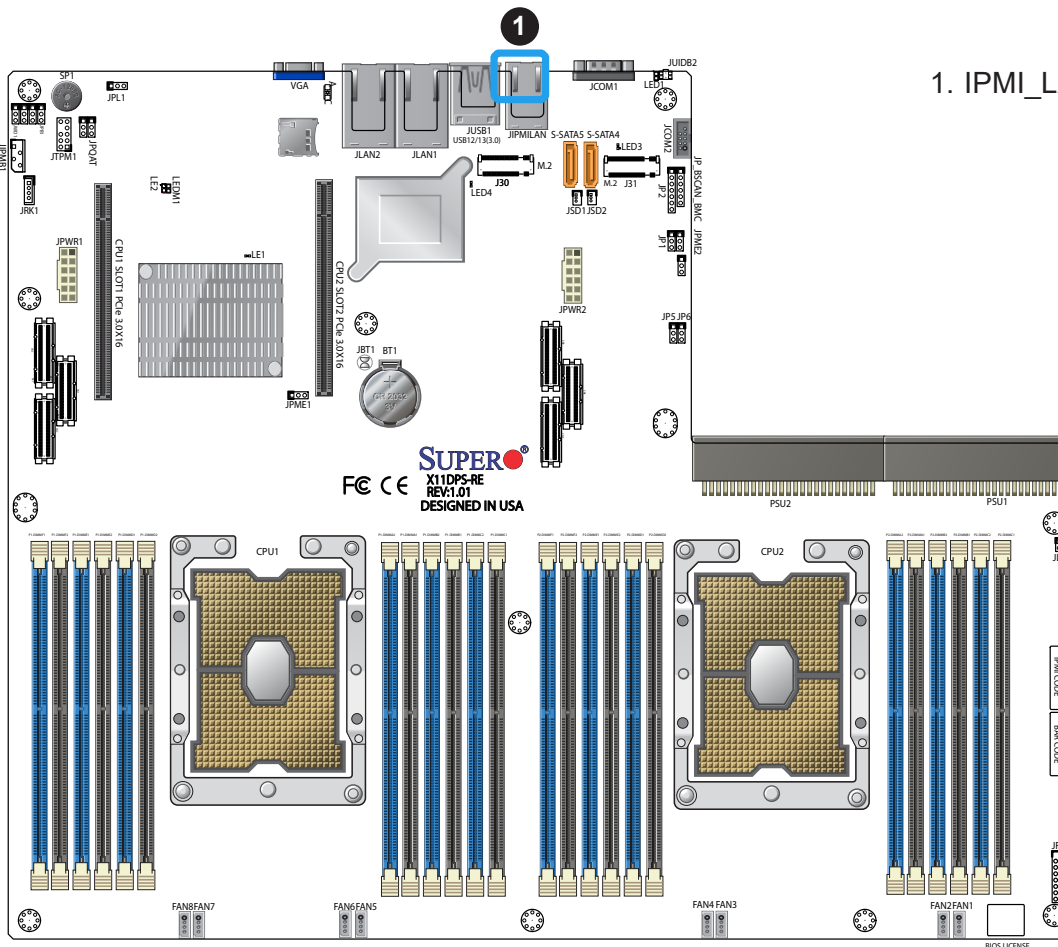

BMC Heartbeat LED

LED1 is the BMC heartbeat LED. When the LED is blinking green, BMC (Baseboard Management Controller) is functioning normally. See the table below for the LED status.

| Onboard Power LED Indicator | |
|-----------------------------|------------|
| LED Color | Definition |
| Green: | BMC Normal |
| Blinking | |

Onboard Power LED

The Onboard Power LED is located at LE2 on the motherboard. When this LED is on, the system is also on. Be sure to turn off the system and unplug the power cord before removing or installing components. Refer to the table below for more information.

| Onboard Power LED Indicator | |
|-----------------------------|---|
| LED Color | Definition |
| Off | System Power Off (power cable not connected) |
| Green | System Power On |

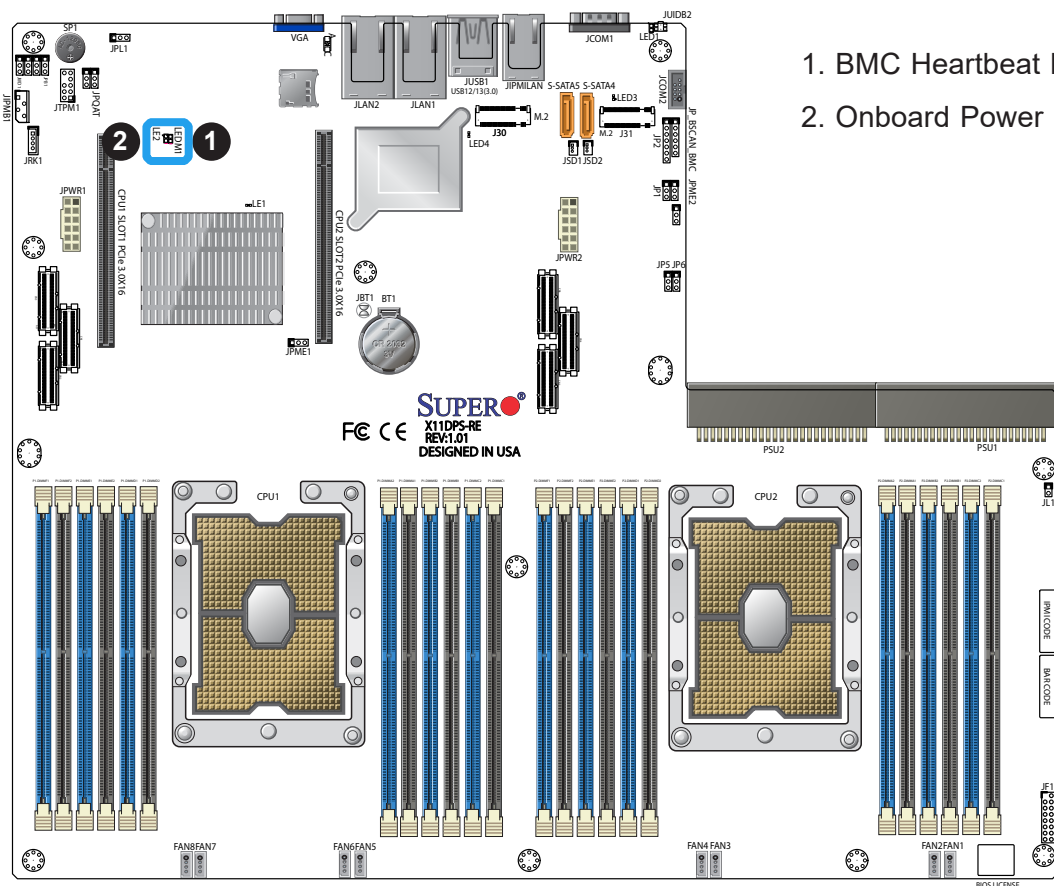

1. BMC Heartbeat LED
2. Onboard Power LED

Unit Identifier (UID) LED

A rear UID LED indicator at LED1 is located next to the UID switch on the I/O back panel. The front UID LED is located at pins 7 and 8 on the front control panel. The UID indicators provide easy identification of a system unit that may need service.

| UID LED LED Indicator | |
|-----------------------|-----------------|
| LED Color | Definition |
| Blue: On | Unit Identified |

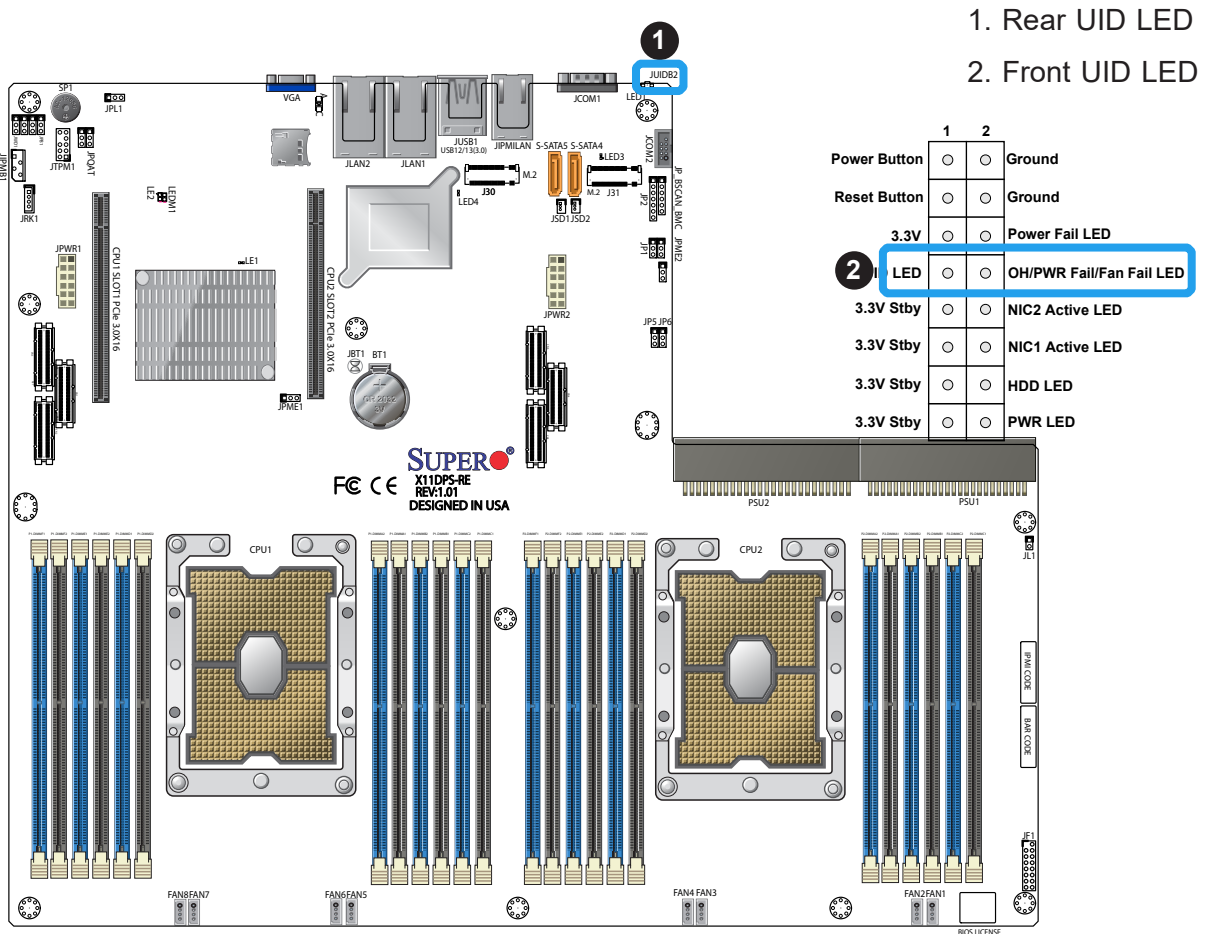
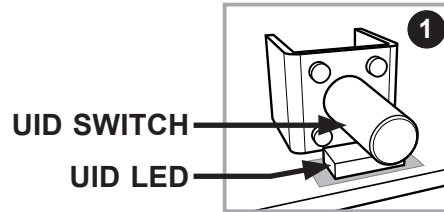

Chapter 3

Troubleshooting

3.1 Troubleshooting Procedures

Use the following procedures to troubleshoot your system. If you have followed all of the procedures below and still need assistance, refer to the 'Technical Support Procedures' and/or 'Returning Merchandise for Service' section(s) in this chapter. Always disconnect the AC power cord before adding, changing or installing any non hot-swap hardware components.

Before Power On

1. Check that the power LED on the motherboard is on.
2. Make sure that the power connector is connected to your power supply.
3. Make sure that no short circuits exist between the motherboard and chassis.
4. Disconnect all cables from the motherboard, including those for the keyboard and mouse.
5. Remove all add-on cards.
6. Install a CPU, a heatsink*, and connect the internal speaker and the power LED to the motherboard. Check all jumper settings as well. (Make sure that the heatsink is fully seated.)
7. Use the correct type of onboard CMOS battery as recommended by the manufacturer. To avoid possible explosion, do not install the CMOS battery upside down.

No Power

1. Make sure that no short circuits exist between the motherboard and the chassis.
2. Verify that all jumpers are set to their default positions.
3. Check that the 115V/230V switch on the power supply is properly set.
4. Turn the power switch on and off to test the system.
5. The battery on your motherboard may be old. Check to verify that it still supplies ~3VDC. If it does not, replace it with a new one.

No Video

1. If the power is on but you have no video, remove all the add-on cards and cables.
2. Use the speaker to determine if any beep codes exist. Refer to Appendix A for details on beep codes.

System Boot Failure

If the system does not display POST (Power-On-Self-Test) or does not respond after the power is turned on, check the following:

1. Check for any error beep from the motherboard speaker.
 - If there is no error beep, try to turn on the system without DIMM modules installed. If there is still no error beep, replace the motherboard.
 - If there are error beeps, clear the CMOS settings by unplugging the power cord and contacting both pads on the CMOS Clear Jumper (JBT1). Refer to chapter 2.
2. Remove all components from the motherboard, especially the DIMM modules. Make sure that system power is on and that memory error beeps are activated.
3. Turn on the system with only one DIMM module installed. If the system boots, check for bad DIMM modules or slots by following the Memory Errors Troubleshooting procedure in this Chapter.

Memory Errors

1. Make sure that the DIMM modules are properly and fully installed.
2. Confirm that you are using the correct memory. Also, it is recommended that you use the same memory type and speed for all DIMMs in the system. [See Section 2.4 for memory details.](#)
3. Check for bad DIMM modules or slots by swapping modules between slots and noting the results.
4. Check the power supply voltage 115V/230V switch.

Losing the System's Setup Configuration

1. Make sure that you are using a high quality power supply. A poor quality power supply may cause the system to lose the CMOS setup information. Refer to Section 1.6 for details on recommended power supplies.
2. The battery on your motherboard may be old. Check to verify that it still supplies ~3VDC. If it does not, replace it with a new one.
3. If the above steps do not fix the setup configuration problem, contact your vendor for repairs.

When the System Becomes Unstable

A. If the system becomes unstable during or after OS installation, check the following:

1. CPU/BIOS support: Make sure that your CPU is supported and that you have the latest BIOS installed in your system.
2. Memory support: Make sure that the memory modules are supported by testing the modules using memtest86 or a similar utility.



Note: Refer to the product page on our website at <http://www.supermicro.com> for memory and CPU support and updates.

3. HDD support: Make sure that all hard disk drives (HDDs) work properly. Replace the bad HDDs with good ones.
4. System cooling: Check the system cooling to make sure that all heatsink fans and CPU/system fans, etc., work properly. Check the hardware monitoring settings in the IPMI to make sure that the CPU and system temperatures are within the normal range. Also check the front panel Overheat LED and make sure that it is not on.
5. Adequate power supply: Make sure that the power supply provides adequate power to the system. Make sure that all power connectors are connected. Please refer to our website for more information on the minimum power requirements.
6. Proper software support: Make sure that the correct drivers are used.

B. If the system becomes unstable before or during OS installation, check the following:

1. Source of installation: Make sure that the devices used for installation are working properly, including boot devices such as CD.
2. Cable connection: Check to make sure that all cables are connected and working properly.

3. Using the minimum configuration for troubleshooting: Remove all unnecessary components (starting with add-on cards first), and use the minimum configuration (but with a CPU and a memory module installed) to identify the trouble areas. Refer to the steps listed in Section A above for proper troubleshooting procedures.
4. Identifying bad components by isolating them: If necessary, remove a component in question from the chassis, and test it in isolation to make sure that it works properly. Replace a bad component with a good one.
5. Check and change one component at a time instead of changing several items at the same time. This will help isolate and identify the problem.
6. To find out if a component is good, swap this component with a new one to see if the system will work properly. If so, then the old component is bad. You can also install the component in question in another system. If the new system works, the component is good and the old system has problems.

3.2 Technical Support Procedures

Before contacting Technical Support, please take the following steps. Also, note that as a motherboard manufacturer, we do not sell directly to end-users, so it is best to first check with your distributor or reseller for troubleshooting services. They should know of any possible problem(s) with the specific system configuration that was sold to you.

1. Please review the 'Troubleshooting Procedures' and 'Frequently Asked Questions' (FAQs) sections in this chapter or see the FAQs on our website before contacting Technical Support.
2. BIOS upgrades can be downloaded from our website. **Note:** Not all BIOS can be flashed depending on the modifications to the boot block code.
3. If you still cannot resolve the problem, include the following information when contacting us for technical support:
 - Motherboard model and PCB revision number
 - BIOS release date/version (this can be seen on the initial display when your system first boots up)
 - System configuration

An example of a Technical Support form is posted on our website.

Distributors: For immediate assistance, please have your account number ready when contacting our technical support department by e-mail.

3.3 Frequently Asked Questions

Question: What type of memory does my motherboard support?

Answer: The X11DPS-RE motherboard supports up to 6TB of LRDIMM/RDIMM/NVDIMM DDR4 ECC 2933*/2666/2400/2133 MHz memory in 24 memory slots (*Note below). It also supports up to 9TB memory with DCPMM modules installed.

 **Note:** 2933 MHz memory is supported by 2nd Gen Intel Xeon Scalable-SP (82xx/62xx series) processors only. See **Section 2.4** for details on installing memory.

Question: Why can't I turn off the power using the momentary power on/off switch?

Answer: The instant power off function is controlled in BIOS by the Power Button mode setting. When the On/Off feature is enabled, the motherboard will have instant off capabilities as long as the BIOS has control of the system. When the Standby or Suspend feature is enabled or when the BIOS is not in control such as during memory count (the first screen that appears when the system is turned on), the momentary on/off switch must be held for more than four seconds to shut down the system. This feature is required to implement the ACPI features on the motherboard.

Question: How do I update my BIOS?

Answer: It is recommended that you **do not** upgrade your BIOS if you are not experiencing any problems with your system. Updated BIOS files are located on our website at http://www.supermicro.com/ResourceApps/BIOS_IPMI_Intel.html. Please check our BIOS warning message and the information on how to update your BIOS on our website. Select your motherboard model and download the BIOS file to your computer. Also, check the current BIOS revision to make sure that it is newer than your BIOS before downloading. Please refer to the following section for the instructions on how to update your BIOS under UEFI Shell.

 **Note:** The SPI BIOS chip used on this motherboard cannot be removed. Send your motherboard back to our RMA Department at Supermicro for repair. For BIOS Recovery instructions, please refer to the AMI BIOS Recovery Instructions posted at <http://www.supermicro.com/support/manuals/>.

Question: How do I update my BIOS under UEFI Shell?

Note: We do not recommend that you update your BIOS if you are not experiencing a BIOS-related problem. If you need to update your BIOS, please follow the steps below to properly update your BIOS under UEFI Shell.

1. Download and save the BIOS update package to your computer.
2. Extract the files from the UEFI folder of the BIOS package to a USB stick.



Note: The USB stick doesn't have to be bootable; however, it has to be formatted with the FAT/FAT32 file system.

3. Insert the USB stick into a USB port, boot to the UEFI Built-In Shell, and enter the following commands to start the BIOS update:

```
Shell> fs0:
```

```
fs0:\> cd UEFI
```

```
fs0:\UEFI> flash.nsh BIOSname#.###
```

4. The FLASH.NSH script will compare the Flash Descriptor Table (FDT) code in the new BIOS with the existing one in the motherboard:

a. If a different FDT is found

- A new file, STARTUP.NSH, will be created, and the system will automatically reboot in 10 seconds without you pressing any key. BIOS will be updated after the system reboots.
- You can also press <Y> to force an immediate system reboot to shorten the process. During system reboot, press the <F11> key to invoke the boot menu and boot into the build-in UEFI Shell. Your BIOS will be updated automatically.

b. If the FDT is the same

- BIOS update will be immediately performed without a system reboot initiated.

Warning: Do not shut down or reset the system while updating the BIOS to prevent possible system boot failure!)

5. Perform an A/C power cycle after the message indicating the BIOS update has completed.
6. Go to the BIOS setup utility, and restore the BIOS settings.

3.4 Battery Removal and Installation

Battery Removal

To remove the onboard battery, follow the steps below:

1. Power off your system and unplug your power cable.
2. Using a tool such as a pen or a small screwdriver, push the battery lock outwards to unlock it. Once unlocked, the battery will pop out from the holder.
3. Remove the battery.

Proper Battery Disposal

Please handle used batteries carefully. Do not damage the battery in any way; a damaged battery may release hazardous materials into the environment. Do not discard a used battery in the garbage or a public landfill. Please comply with the regulations set up by your local hazardous waste management agency to dispose of your used battery properly.

Battery Installation

To install an onboard battery, follow the steps below:

1. Power off your system and unplug your power cable.
2. Locate the onboard battery as shown below
3. Identify the battery's polarity. The positive (+) side should be facing up.
4. Insert the battery into the battery holder and push it down until you hear a click to ensure that the battery is securely locked.

 **Note:** When replacing a battery, be sure to only replace it with the same type.

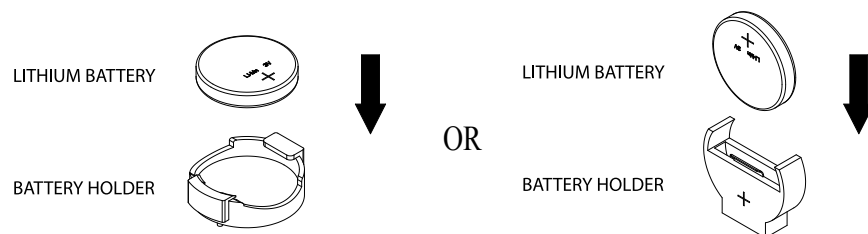

3.5 Returning Merchandise for Service

A receipt or copy of your invoice marked with the date of purchase is required before any warranty service will be rendered. You can obtain service by calling your vendor for a Returned Merchandise Authorization (RMA) number. When returning to the manufacturer, the RMA number should be prominently displayed on the outside of the shipping carton and mailed prepaid or hand-carried. Shipping and handling charges will be applied for all orders that must be mailed when service is complete.

For faster service, RMA authorizations may be requested online (<http://www.supermicro.com/support/rma/>).

This warranty only covers normal consumer use and does not cover damages incurred in shipping or from failure due to the alteration, misuse, abuse or improper maintenance of products.

During the warranty period, contact your distributor first for any product problems.

Chapter 4

UEFI BIOS

4.1 Introduction

This chapter describes the AMIBIOS™ setup utility for the X11DPS-RE motherboard. The BIOS is stored on a chip and can be easily upgraded using a flash program.



Note: Due to periodic changes to the BIOS, some settings may have been added or deleted and might not yet be recorded in this manual. Please refer to the Manual Download area of our website for any changes to the BIOS that may not be reflected in this manual.

Starting the Setup Utility

To enter the BIOS setup utility, press the <Delete> key while the system is booting-up. (In most cases, the <Delete> key is used to invoke the BIOS setup screen. There are a few cases when other keys are used, such as <F1>, <F2>, etc.) Each main BIOS menu option is described in this manual.

The Main BIOS screen has two main frames. The left frame displays all the options that can be configured. “Grayed-out” options cannot be configured. The right frame displays the key legend. Above the key legend is an area reserved for a text message. When an option is selected in the left frame, it is highlighted in white. Often a text message will accompany it. (Note that BIOS has default text messages built in. We retain the option to include, omit, or change any of these text messages.) Settings printed in **Bold** are the default values.

A "►" indicates a submenu. Highlighting such an item and pressing the <Enter> key will open the list of settings within that submenu.

The BIOS setup utility uses a key-based navigation system called hot keys. Most of these hot keys (<F1>, <F2>, <F3>, <F4>, <Enter>, <ESC>, <Arrow> keys, etc.) can be used at any time during the setup navigation process.

4.2 Main Setup

When you first enter the AMI BIOS setup utility, you will see the Main setup screen. You can always return to the Main setup screen by selecting the Main tab on the top of the screen. The Main BIOS setup screen is shown below.

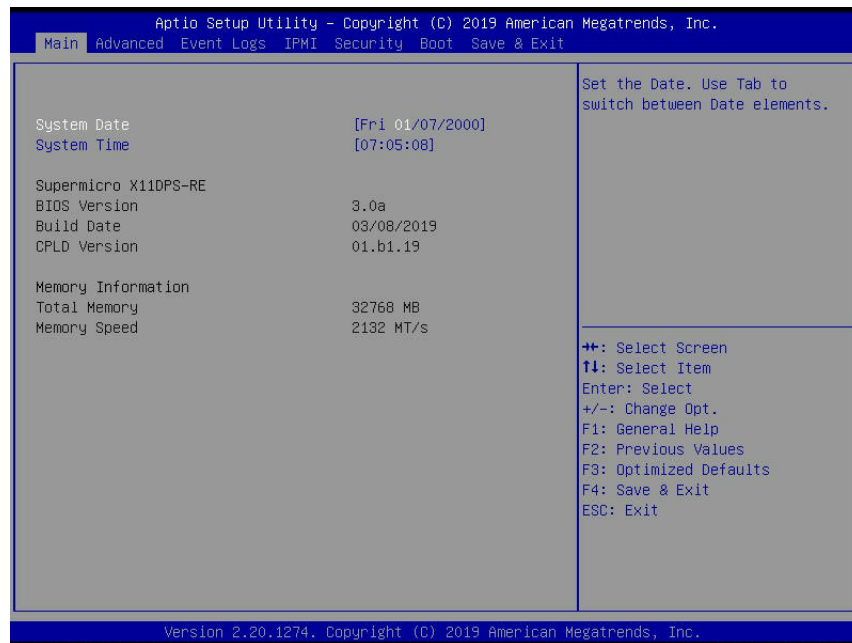

System Date/System Time

Use this item to change the system date and time. Highlight *System Date* or *System Time* using the arrow keys. Enter new values using the keyboard. Press the <Tab> key or the arrow keys to move between fields. The date must be entered in Day MM/DD/YYYY format. The time is entered in HH:MM:SS format.

 **Note:** The time is in the 24-hour format. For example, 5:30 P.M. appears as 17:30:00. The date's default value is the BIOS build date after the RTC (Real Time Clock) reset.

Supermicro X11DPS-RE

BIOS Version

This feature displays the version of the BIOS ROM used in the system.

Build Date

This feature displays the date when the version of the BIOS ROM used in the system was built.

CPLD Version

This feature displays the version of the CPLD (Complex-Programmable Logical Device) used in the system.

Memory Information

Total Memory

This feature displays the total size of memory available in the system.

Memory Speed

This feature displays the default speed of the memory modules installed in the system.

4.3 Advanced Setup Configurations

Use the arrow keys to select the Advanced submenu and press <Enter> to access the submenu items:

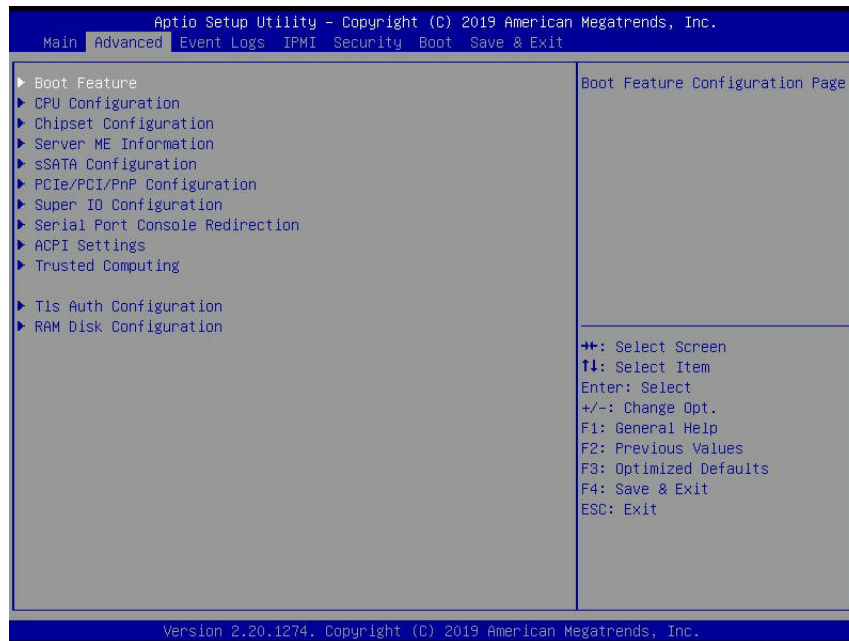

Warning: Take Caution when changing the Advanced settings. An incorrect value, an improper DRAM frequency, or a wrong BIOS timing setting may cause the system to malfunction. When this occurs, restore the setting to the manufacturer default setting.

► Boot Feature

Quiet Boot

Use this feature to select the screen between displaying POST messages or the OEM logo at bootup. Select Disabled to display the POST messages. Select Enabled to display the OEM logo instead of the normal POST messages. The options are **Enabled** and Disabled.

 **Note:** POST message is always displayed regardless of the item setting.

Option ROM Messages

Use this feature to set the display mode for the Option ROM. Select Keep Current to use the current AddOn ROM display settings. Select Force BIOS to use the Option ROM display mode set by the system BIOS. The options are **Force BIOS** and Keep Current.

Bootup NumLock State

Use this feature to set the Power-on state for the Numlock key. The options are Off and **On**.

Wait For 'F1' If Error

Select Enabled to force the system to wait until the <F1> key is pressed if an error occurs. The options are Disabled and **Enabled**.

Interrupt 19 Capture

Interrupt 19 is the software interrupt that handles the boot disk function. When this feature is set to Immediate, the ROM BIOS of the host adaptors will "capture" Interrupt 19 at bootup immediately and allow the drives that are attached to these host adaptors to function as bootable disks. If this item is set to Postponed, the ROM BIOS of the host adaptors will not capture Interrupt 19 immediately to allow the drives attached to these adaptors to function as bootable devices at bootup. The options are **Immediate** and Postponed.

Re-try Boot

When EFI (Extensible Firmware Interface) Boot is selected, the system BIOS will automatically reboot the system from an EFI boot device after an initial boot failure. Select Legacy Boot to allow the BIOS to automatically reboot the system from a Legacy boot device after an initial boot failure. The options are **Disabled**, Legacy Boot, and EFI Boot.

Power Configuration

Watch Dog Function

Select Enabled to allow the Watch Dog timer to reboot the system when it is inactive for more than 5 minutes. The options are Enabled and **Disabled**.

Power Button Function

This feature controls how the system shuts down when the power button is pressed. Select 4 Seconds Override for the user to power off the system after pressing and holding the power button for 4 seconds or longer. Select Instant Off to instantly power off the system as soon as the user presses the power button. The options are 4 Seconds Override and **Instant Off**.

Restore on AC Power Loss

Use this feature to set the power state after a power outage. Select Power Off for the system power to remain off after a power loss. Select Power On for the system power to be turned on after a power loss. Select Last State to allow the system to resume its last power state before a power loss. The options are Stay Off, Power On, and **Last State**.

► CPU Configuration

Warning: Setting the wrong values in the following sections may cause the system to malfunction.

► Processor Configuration

The following CPU information will be displayed:

- Processor BSP Revision
- Processor Socket
- Processor ID
- Processor Frequency
- Processor Max Ratio
- Processor Min Ratio
- Microcode Revision
- L1 Cache RAM
- L2 Cache RAM
- L3 Cache RAM
- Processor 0 Version
- Processor 1 Version

Hyper-Threading (ALL)

Select Enable to use Intel Hyper-Threading Technology to enhance CPU performance. The options are **Enable** and Disable.

Core Enabled

Use this feature to enable or disable CPU cores in the processor specified by the user. Use the <+> key and the <-> key on the keyboard to set the desired number of CPU cores you want to enable in a processor. Please note that the maximum of 24 CPU cores are currently available in each CPU package. The default setting is **0**.

Monitor/Mwait

Select Enable to enable the Monitor/Mwait instructions in the processor. The options are **Enable** and Disable.

Execute Disable Bit (Available if supported by the OS & the CPU)

Select Enable for Execute Disable Bit support which will allow the processor to designate areas in the system memory where an application code can execute and where it cannot, thus preventing a worm or a virus from flooding illegal codes to overwhelm the processor, damaging the system during a virus attack. The options are **Enable** and Disable. (Refer to Intel and Microsoft websites for more information.)

Intel Virtualization Technology (Available when two processors are installed on the motherboard)

Select Enable to use Intel Virtualization Technology which will allow multiple workloads to share the same set of common resources. On shared virtualized hardware, various workloads (or tasks) can co-exist, sharing the same resources, while functioning in full independence from each other, and migrating freely across multi-level infrastructures and scale as needed. The settings are **Enable** and Disable.

PPIN Control

Select Unlock/Enable to use the Protected-Processor Inventory Number (PPIN) in the system. The options are **Unlock/Enable** and Unlock/Disable.

Hardware Prefetcher (Available when supported by the CPU)

If this feature is set to Enable, the hardware prefetcher will prefetch streams of data and instructions from the main memory to the Level 2 (L2) cache to improve CPU performance. The options are Disable and **Enable**.

Adjacent Cache Prefetch (Available when supported by the CPU)

Select Enable for the CPU to prefetch both cache lines for 128 bytes as comprised. Select Disable for the CPU to prefetch both cache lines for 64 bytes. The options are Disable and **Enable**.

 **Note:** Please power off and reboot the system for the changes you've made to take effect. Please refer to Intel's website for detailed information.

DCU Streamer Prefetcher (Available when supported by the CPU)

If this feature is set to Enable, the DCU (Data Cache Unit) streamer prefetcher will prefetch data streams from the cache memory to the DCU (Data Cache Unit) to speed up data accessing and processing to enhance CPU performance. The options are Disable and **Enable**.

DCU IP Prefetcher

This feature allows the system to use the sequential load history, which is based on the instruction pointer of previous loads, to determine whether the system will prefetch additional lines. The options are **Enable** and Disable.

LLC Prefetch

If this feature is set to Enable, LLC (hardware cache) prefetching on all threads will be supported. The options are **Disable** and Enable.

Extended APIC (Extended Advanced Programmable Interrupt Controller)

Based on the Intel Hyper-Threading technology, each logical processor (thread) is assigned 256 APIC IDs (APIDs) in 8-bit bandwidth. When this feature is set to Enable, the APIC ID will be expanded from 8 bits to 16 bits to provide 512 APIDs to each thread to enhance CPU performance. The options are **Disable** and Enable.

AES-NI

Select Enable to use the Intel Advanced Encryption Standard (AES) New Instructions (NI) to ensure data security. The options are **Enable** and Disable.

►Advanced Power Management Configuration

Power Technology

Select Energy Efficient to support power-saving mode. Select Custom to customize system power settings. Select Disabled to disable power-saving settings. The options are Disable, **Energy Efficient**, and Custom.

Power Performance Tuning (Available when "Power Technology" is set to Custom)

Select BIOS to allow the system BIOS to configure the Power-Performance Tuning Bias setting. The options are BIOS Controls EPB and **OS Controls EPB**.

ENERGY_PERF_BIAS_CFG Mode (ENERGY PERFORMANCE BIAS CONFIGURATION Mode) (Available when "Power Performance Tuning" is set to BIOS Controls EPB)

Use this feature to set the processor power use policy to achieve the desired operation settings for your machine by prioritizing system performance or energy savings. Select Maximum Performance to maximize system performance (to its highest potential); however, this may result in maximum power consumption as energy is needed to fuel the processor frequency. The higher the performance is, the higher the power consumption will be. Select Max Power Efficient to maximize power saving; however, system performance may be substantially impacted because limited power use decreases the processor frequency. The options are Max Performance, Performance, **Balanced Performance**, Balanced Power, and Power.

►CPU P State Control (Available when "Power Technology" is set to Custom)

SpeedStep (PStates)

EIST (Enhanced Intel SpeedStep Technology) allows the system to automatically adjust processor voltage and core frequency in an effort to reduce power consumption and heat dissipation. Please refer to Intel's website for detailed information. The options are Disable and **Enable**.

Config (Configure) TDP (Available when SpeedStep is set to Enable)

Use this feature to set the appropriate TDP (Thermal Design Power) level for the system. The TDP refers to the maximum amount of power allowed for running "real applications" without triggering an overheating event. The options are **Normal**, Level 1, and Level 2.

Activate PBF (Available when this feature supported by the processor)

Select Enable to enable Prioritized Base Frequency (PBF) feature support which will enhance CPU performance. The options are **Disable** and Enable.

Configure PBF (Available when Activate PBF is set to Enable)

Select Enable to allow the BIOS to configure high priority CPU cores as Prioritized Base Frequency (PBF) so that software programs do not have to configure the PBF (Prioritized Base Frequency) settings. The options are **Enable** and Disable.

EIST PSD Function (Available when SpeedStep is set to Enable)

Use this item to configure the processor's P-State coordination settings. During a P-State, the voltage and frequency of the processor will be reduced when it is in operation. This makes the processor more energy efficient, resulting in further energy gains. The options are **HW_ALL**, SW_ALL and SW-ANY.

Turbo Mode (Available when SpeedStep is set to Enable)

Select Enable for processor cores to run faster than the frequency specified by the manufacturer. The options are Disable and **Enable**.

►Hardware PM (Power Management) State Control Available when "Power Technology" is set to Custom)

Hardware P-States

If this feature is set to Disable, hardware will choose a P-state setting for the system based on an OS request. If this feature is set to Native Mode, hardware will choose a P-state setting based on OS guidance. If this feature is set to Native Mode with No Legacy Support, hardware will choose a P-state setting independently without OS guidance. The options are **Disable**, Native Mode, Out of Band Mode, and Native Mode with No Legacy Support.

►CPU C State Control

Autonomous Core C-State

Select Enable to support Autonomous Core C-State control which will allow the processor core to control its C-State setting automatically and independently. The options are **Disable** and Enable.

CPU C6 Report (Available when Autonomous Core C-State is set to Disable)

Select Enable to allow the BIOS to report the CPU C6 state (ACPI C3) to the operating system. During the CPU C6 state, power to all caches is turned off. The options are **Auto**, Enable, and Disable.

Enhanced Halt State (C1E) (Available when Autonomous Core C-State is set to Disable)

Select Enable to enable "Enhanced Halt State" support, which will significantly reduce the CPU's power consumption by minimizing CPU's clock cycles and reduce voltage during a "Halt State." The options are Disable and **Enable**.

► Package C State Control (Available when "Power Technology" is set to Custom)**Package C State**

Use this feature to set the limit on the C-State package register. The options are C0/C1 state, C2 state, C6 (non-Retention) state, C6 (Retention) state, No Limit, and **Auto**.

► CPU T State Control Available when "Power Technology" is set to Custom)**Software Controlled T-States**

If this feature is set to Enable, CPU throttling settings will be supported by the software of the system. The options are **Enable** and Disable.

► Chipset Configuration

Warning: Setting the wrong values in the following items may cause the system to malfunction.

► North Bridge

This feature allows the user to configure the settings for the Intel North Bridge.

► UPI (Ultra Path Interconnect) Configuration

This section displays the following UPI General Configuration information:

- Number of CPU
- Number of Active UPI Link
- Current UPI Link Speed
- Current UPI Link Frequency
- UPI Global MMIO Low Base/Limit
- UPI Global MMIO High Base/Limit
- UPI Pci-e Configuration Base/Size

Degrade Precedence

Use this feature to select the degrading precedence option for Ultra Path Interconnect (UPI) connections. Select Topology Precedent to degrade UPI features if system options are in conflict. Select Feature Precedent to degrade UPI topology if system options are in conflict. The options are **Topology Precedence** and Feature Precedence.

Link L0p Enable

Select Enable to enable Link L0p. The options are Disable, Enable, and **Auto**.

Link L1 Enable

Select Enable to enable Link L1 (Level 1 link). The options are Disable, Enable, and **Auto**.

IO Directory Cache (IODC)

Select Enable for the IODC (I/O Directory Cache) to generate snoops instead of generating memory lockups for remote IIO (InvlToM) and/or WCiLF (Cores). Select Auto for the IODC to generate snoops (instead of memory lockups) for WCiLF (Cores). The options are Disable, **Auto**, Enable for Remote InvltoM Hybrid Push, InvltoM AllocFlow, Enable for Remote InvltoM Hybrid AllocNonAlloc, and Enable for Remote InvltoM and Remote WViLF.

SNC

Select Enable to use "Sub NUMA Clustering" (SNC), which supports full SNC (2-cluster) interleave and 1-way IMC interleave. Select Auto for 1-cluster or 2-cluster support depending on the status of IMC (Integrated Memory Controller) Interleaving. The options are **Disable**, Enable, and Auto.

XPT Prefetch

Select Enable to support XPT Prefetching to enhance system performance. The options are Enable, **Disable**, and Auto.

KTI Prefetch

Select Enable to support KTI Prefetching to enhance system performance. The options are **Enable** and Disable.

Local/Remote Threshold

This feature allows the user to set the threshold for the Interrupt Request (IRQ) signal, which handles hardware interruptions. The options are Disable, **Auto**, Low, Medium, and High.

Stale AtoS (A to S)

The in-memory directory has three states: I, A, and S states. The I (-invalid) state indicates that the data is clean and does not exist in the cache of any other sockets. The A (-snoop All) state indicates that the data may exist in another socket in an exclusive or modified state. The S state (-Shared) indicates that the data is clean and may be shared in the caches across one or more sockets. When the system is performing "read" on the memory and if the directory line is in A state, we must snoop all other sockets because another

socket may have the line in a modified state. If this is the case, a "snoop" will return the modified data. However, it may be the case that a line "reads" in an A state, and all the snoops come back with a "miss". This can happen if another socket reads the line earlier and then has silently dropped it from its cache without modifying it. If the "Stale AtoS" feature is enabled, a line will transition to the S state when the line in the A state returns only snoop misses. That way, subsequent reads to the line will encounter it in the S state and will not have to snoop, saving the latency and snoop bandwidth. Stale "AtoS" may be beneficial in a workload where there are many cross-socket reads. The options are Disable, Enable, and **Auto**.

LLC Dead Line Alloc

Select Enable to opportunistically fill the deadlines in the LLC. The options are **Enable**, Disable, and Auto.

Isoc Mode

Select Enable to enable Isochronous support to meet QoS (Quality of Service) requirements. This feature is especially important for Virtualization Technology. The options are Disable, Enable, and **Auto**.

►Memory Configuration

Enforce POR (Plan of Record)

Select POR to enforce POR restrictions for DDR4 memory frequency and voltage programming. The options are **POR** and Disable.

PPR Type

Post Package Repair (PPR) is a new feature available for the DDR4 Technology. PPR provides additional spare capacity within a DDR4 DRAM module that is used to replace faulty cell areas detected during system boot. PPR offers two types of memory repairs. Soft Post Package Repair (sPPR) provides a quick, temporary fix on a raw element in a bank group of a DDR4 DRAM device, while hard Post Package Repair (hPPR) will take a longer time to provide a permanent repair on a raw element. The options are **Auto**, Enable, Soft PPR, and Disable.

Memory Frequency

Use this feature to set the maximum memory frequency for onboard memory modules. The options are **Auto**, 1866, 2000, 2133, 2400, 2666, and 2933. **Note:** 2933 MHz memory is supported by 2nd Gen Intel Xeon Scalable-SP (82xx/62xx series) processors only.

Data Scrambling for DDR4

Select Enable to enable data scrambling for DDR4 memory to enhance system performance and security. Select Auto for the default setting of the Memory Reference Code (MRC) to set configure data scrambling for DDR4 setting. The options are **Auto**, Disable, and Enable.

tCCD_L Relaxation

If this feature is set to Enable, SPD (Serial Presence Detect) will override tCCD_L ("Column to Column Delay-Long", or "Command to Command Delay-Long" on the column side.) If this feature is set to Disable, tCCD_L will be enforced based on the memory frequency. The options are **Auto**, Enable and Disable.

tRWSR (Read to Write turnaround time for Same Rank) Relaxation

Select Enable to use the same tRWSR DDR timing setting among all memory channels, and in which case, the worst case value among all channels will be used. Select Disable to use different values for the tRWSR DDR timing settings for different channels as trained. The options are Auto, **Disable**, and Enable.

Enable ADR

Select Enable for ADR (Async DIMM Self-Refresh) support to enhance memory performance. The options are Disable and **Enable**.

Data Scrambling for NVDIMM

Select Enable to enable data scrambling support for onboard NVDIMM memory to improve system performance and security. The options are **Auto**, Disable, and Enable.

Erase-Arm NVDIMMs

If this feature is set to Enable, the function that arms the NVDIMMs for safe operations in the event of a power loss will be removed. The options are **Enable** and Disable.

Restore NVDIMMs

Select Enable to restore the functionality and the features of NVDIMMs. The options are **Enable** and Disable.

Interleave NVDIMMs

If this item is set to Enable, all onboard NVDIMM modules will be configured together as a group for the interleave mode. If this item is set to Disable, individual NVDIMM modules will be configured separately for the interleave mode. The options are Enable and **Disable**.

Reset Trigger ADR (Async DIMM Self-Refresh)

Upon system power loss, an ADR sequence will be triggered to allow ADR to flush the write-protected data buffers in the memory controller and place the DRAM memory in self-refresh mode. When this process is complete, the NVDIMM will then take control of the DRAM memory and transfer the contents to the onboard Flash memory. After the transfer is complete, the NVDIMM goes into a zero power state. The data transferred will be retained for the duration specified by the flash memory. The options are Enable and **Disable**.

S5 Trigger ADR

Select Enabled to support S5-Triggered ADR to enhance system performance and data integrity. The options are **Disable** and Enable.

2X Refresh

Select Enable for memory 2X refresh support to enhance memory performance. The options are Disable, Enable and **Auto**.

Page Policy

Use this feature to set the page policy for onboard memory support. The options are Closed, Adaptive, and **Auto**.

IMC Interleaving

Use this feature to configure interleaving settings for the IMC (Integrated Memory Controller), which will improve memory performance. The options are 1-way Interleave, 2-way Interleave, and **Auto**.

Average Power Budget (in mW)

This feature sets the power management policy for average power use (in an increment of 250 mW). The default setting is **15000**.

►Memory Topology

This item displays the information of onboard memory modules as detected by the BIOS.

- P1 DIMMA1/DIMMA2/DIMMB1/DIMMB2/DIMMC1/DIMMC2/DIMMD1/DIMMD2/
DIMME1/DIMME2/DIMMF1/DIMMF2
- P2 DIMMA1/DIMMA2/DIMMB1/DIMMB2/DIMMC1/DIMMC2/DIMMD1/DIMMD2/
DIMME1/DIMME2/DIMMF1/DIMMF2

►Memory RAS (Reliability_Availability_Serviceability) Configuration

Use this submenu to configure the following Memory RAS settings.

Static Virtual Lockstep Mode

Select Enable to support Static Virtual Lockstep mode to enhance memory performance. The options are Enable and **Disable**.

Mirror Mode

Use this feature to configure the mirror mode settings for all 1LM/2LM memory modules installed in the system which will create a duplicate copy of data stored in the memory to increase memory security, but it will reduce the memory capacity into half. The options are **Disable** and Enable Mirror Mode (1LM).

UEFI ARM Mirror

If this feature is set to Enable, mirror mode configuration settings for UEFI-based Address Range memory will be enabled upon system boot. This will create a duplicate copy of data stored in the memory to increase memory security, but it will reduce the memory capacity into half. The options are **Disable** and Enable.

Memory Rank Sparing

Select Enable to support memory-rank sparing to optimize memory performance. The options are Enable and **Disable**.



Note: This item will not be available when memory mirror mode is set to Enable Mirror Mode 1LM or an AEP device is plugged in.

Correctable Error Threshold

Use this item to enter the threshold value for correctable memory errors. The default setting is **100**.

Intel Run Sure

Select Enable to use Intel Run Sure Technology which will enhance critical data protection and increase system uptime and resiliency. The options are Enable and **Disable**.

ADDDC (Adaptive Double Device Data Correction) Sparing (Available when Intel Run Sure is set to Enable)

Select Enable for Adaptive Double Device Data Correction (ADDDC) support, which will not only provide memory error checking and correction but will also prevent the system from issuing a performance penalty before a device fails. Please note that virtual lockstep mode will only start to work for ADDDC after a faulty DRAM module is spared. The options are Enable and **Disable**.

Patrol Scrub

Patrol Scrubbing is a process that allows the CPU to correct correctable memory errors detected in a memory module and send the corrections to the requestor (the original source). When this feature is set to Enable, the IO hub will read and write back one cache line every 16K cycles if there is no delay caused by internal processing. By using this method, roughly 64 GB of memory behind the IO hub will be scrubbed every day. The options are **Enable** and Disable.

Patrol Scrub Interval

Use this item to specify the number of hours (between 0 to 24) required for the system to complete a full patrol scrubbing. Enter 0 for patrol scrubbing to be performed automatically. The default setting is **24**.



Note: This item is hidden when Patrol Scrub item is set to Disable.

► IIO Configuration

EV DFX (Device Function On-Hide) Features

When this feature is set to Enable, the EV_DFX Lock Bits that are located in a processor will always remain clear during electric tuning. The options are **Disable** and **Enable**.

► CPU1 Configuration/CPU2 Configuration

IOU0 (IIO PCIe Br1)

Use this feature to configure the PCIe Bifurcation setting for a PCIe port specified by the user. The options are x4x4x4x4, x4x4x8, x8x4x4, x8x8, x16, and **Auto**.

IOU1 (IIO PCIe Br2)

Use this feature to configure the PCIe Bifurcation setting for a PCIe port specified by the user. The options are x4x4x4x4, x4x4x8, x8x4x4, x8x8, x16, and **Auto**.

IOU2 (IIO PCIe Br3)

Use this feature to configure the PCIe Bifurcation setting for a PCIe port specified by the user. The options are x4x4x4x4, x4x4x8, x8x4x4, x8x8, x16, and **Auto**.

MCP0 (IIO PCIe Br4)

Use this feature to configure the PCIe Bifurcation setting for a PCIe port specified by the user. The options are x16 and **Auto**.

MCP1 (IIO PCIe Br5)

Use this feature to configure the PCIe Bifurcation setting for a PCIe port specified by the user. The options are x16 and **Auto**.

► Socket 0 PCI-E Br0D00F0 - Port 0/DMI (Available for CPU 1 Configuration only)

Link Speed

Use this feature to configure the link speed of a PCIe port specified by the user. The options are **Auto**, Gen 1 (Generation 1) (2.5 GT/s), Gen 2 (Generation 2) (5 GT/s), and Gen 3 (Generation 3) (8 GT/s)

The following information will be displayed:

- PCI-E Port Link Status
- PCI-E Port Link Max
- PCI-E Port Link Speed

PCI-E Port Max (Maximum) Payload Size (Available for CPU 1 Configuration only)

Select Auto for the system BIOS to automatically set the maximum payload value for a PCIe device specified by to user for system performance enhancement. The options are **Auto**, 128B, and 256B.

►IOAT Configuration

Disable TPH (TLP Processing Hint)

TPH is used for data-tagging with a destination ID and a few important attributes. It can send critical data to a particular cache without writing through to memory. Select No in this item for TLP Processing Hint support, which will allow a "TLP request" to provide "hints" to help optimize the processing of each transaction occurred in the target memory space. The options are Yes and **No**.

Prioritize TPH (TLP Processing Hint)

Select Yes to prioritize the TPL requests that will allow the "hints" to be sent to help facilitate and optimize the processing of certain transactions in the system memory. The options are Enable and **Disable**.

Relaxed Ordering

Select Enable to allow certain transactions to be processed and completed before other transactions that have already been enqueued. The options are **Disable** and Enable.

►Intel VT for Directed I/O (VT-d)

Intel® VT for Directed I/O (VT-d)

Select Enable to use Intel Virtualization Technology support for Direct I/O VT-d by reporting the I/O device assignments to the VMM (Virtual Machine Monitor) through the DMAR ACPI tables. This feature offers fully-protected I/O resource sharing across Intel platforms, providing greater reliability, security and availability in networking and data-sharing. The options are **Enable** and Disable.

ACS (Access Control Services) Control

Select Enable to program Access Control Services to Chipset PCIe Root Port Bridges. Select Disable to program Access Control Services to all PCIe Root Port Bridges. The options are Enable and **Disable**.

Interrupt Remapping

Select Enable for Interrupt Remapping support to enhance system performance. The options are **Enable** and Disable.

PassThrough DMA

Select Enable for the Non-Isoch VT-d engine to pass through DMA (Direct Memory Access) to enhance system performance. The options are **Enable** and Disable.

ATS

Select Enable to enable ATS (Address Translation Services) support for the Non-Isoch VT-d engine to enhance system performance. The options are **Enable** and Disable.

Posted Interrupt

Select Enable to support VT_D Posted Interrupt which will allow external interrupts to be sent directly from a direct-assigned device to a client machine in non-root mode to improve virtualization efficiency by simplifying interrupt migration and lessening the need of physical interrupts. The options are **Enable** and Disable.

Coherency Support (Non-Isoch)

Select Enable for the Non-Isoch VT-d engine to pass through DMA (Direct Memory Access) to enhance system performance. The options are **Enable** and Disable.

► Intel® VMD Technology

This section describes the configuration settings for the Intel Volume Management Device (VMD) Technology.



Note: After you've enabled VMD in the BIOS on a PCIe slot of your choice, this PCIe slot will be dedicated for VMD use only, and it will no longer support any PCIe device. To re-activate this slot for PCIe use, please disable VMD in the BIOS.

► Intel® VMD for CPU1

Intel® VMD for CPU1 PStack0

Intel® VMD for Volume Management Device for PStack0

Select Enable to enable Intel Volume Management Device Technology support for the stack specified by the user. The options are **Disable** and Enable.

Note: When this option is set to Enable, the following two items will display.

CPU1 Slot1 PCI-E 3.0 x8 VMD

Select Enable to enable Intel Volume Management Device Technology support for the root port specified by the user. The options are **Disable** and Enable.

Hot Plug Capable

Select Enable to enable Hot Plug support for the root ports specified by the user, which will allow the user to change the devices on those root ports without shutting down the system. The options are **Disable** and Enable.

Intel® VMD for CPU1 PStack1

Intel® VMD for Volume Management Device for PStack1

Select Enable to enable Intel Volume Management Device Technology support for the stack specified by the user. The options are **Disable** and Enable.



Note: When this option is set to Enable, the following two items will display.

CPU1 M.2 C-2 PCI-E 3.0 x4 VMD/CPU1 M.2 C-1 PCI-E 3.0 x4 VMD/CPU1 Slot3 PCI-E 3.0 x8 VMD

Select Enable to enable Intel Volume Management Device Technology support for the root port specified by the user. The options are **Disable** and Enable.

Hot Plug Capable

Select Enable to enable Hot Plug support for the root ports specified by the user, which will allow the user to change the devices on those root ports without shutting down the system. The options are **Disable** and Enable.

VMD Configuration for PStack2

Intel® VMD for Volume Management Device for PStack2

Select Enable to enable Intel Volume Management Device Technology support for the stack specified by the user. The options are **Disable** and Enable.



Note: When this option is set to Enable, the following two items will display.

CPU1 Slot6 PCI-E 3.0 x8 VMD/CPU1 Slot7 PCI-E 3.0 x8 VMD

Select Enable to enable Intel Volume Management Device Technology support for the root port specified by the user. The options are **Disable** and Enable.

Hot Plug Capable

Select Enable to enable Hot Plug support for the root ports specified by the user, which will allow the user to change the devices on those root ports without shutting down the system. The options are **Disable** and Enable.

►Intel® VMD for CPU2

Intel® VMD for CPU2 PStack0

Intel® VMD for Volume Management Device for PStack0

Select Enable to enable Intel Volume Management Device Technology support for the stack specified by the user. The options are **Disable** and Enable.



Note: When this option is set to Enable, the following two items will display.

CPU2 Slot2 PCI-E 3.0 x16 VMD

Select Enable to enable Intel Volume Management Device Technology support for the root port specified by the user. The options are **Disable** and Enable.

Hot Plug Capable

Select Enable to enable Hot Plug support for the root ports specified by the user, which will allow the user to change the devices on those root ports without shutting down the system. The options are **Disable** and Enable.

Suppress PTT Commands (Available when PTT Support is set to Enable. This feature is for the X11DPH-Tq board only)

Select Enable to bypass TPM2 commands submitting to PTT Firmware. The options are **Disable** and Enable.

Intel® VMD for CPU2 PStack1

Intel® VMD for Volume Management Device for PStack1

Select Enable to enable Intel Volume Management Device Technology support for the stack specified by the user. The options are **Disable** and Enable.



Note: When this option is set to Enable, the following two items will display.

CPU2 Slot5 PCI-E 3.0 x16 VMD

Select Enable to enable Intel Volume Management Device Technology support for the root port specified by the user. The options are **Disable** and Enable.

Hot Plug Capable

Select Enable to enable Hot Plug support for the root ports specified by the user, which will allow the user to change the devices on those root ports without shutting down the system. The options are **Disable** and Enable.

VMD Configuration for PStack2

Intel® VMD for Volume Management Device for PStack2

Select Enable to enable Intel Volume Management Device Technology support for the stack specified by the user. The options are Enable, and **Disable**.



Note: When this option is set to Enable, the following two items will display.

CPU2 Slot4 PCI-E 3.0 x16 VMD

Select Enable to enable Intel Volume Management Device Technology support for the root port specified by the user. The options are **Disable** and Enable.

Hot Plug Capable

Select Enable to enable Hot Plug support for the root ports specified by the user, which will allow the user to change the devices on those root ports without shutting down the system. The options are **Disable** and Enable.

► Intel® VMD for Onboard NVMe

VMD Configuration Onboard NVMe

Onboard NVMe Mode

Select Legacy Mode for the onboard NVMe devices to support Legacy Mode. The options are **Legacy Mode** and the VMD Mode.

Note: When this option is set to VMD Mode, the following two items will display.

P1_NVMe0 VMD/P2_NVMe1 VMD

Select Enable to enable Intel Volume Management Device Technology support for the root port specified by the user. The options are **Enable** and Disable.



Note: After you've enabled VMD support on a NVMe port, this port will be dedicated for VMD use only. To reactivate this port for NVMe use, please disable VMD support on the port.

Hot Plug Capable

Select Enable to enable Hot Plug support for the root ports specified by the user, which will allow the user to change the devices on those root ports without shutting down the system. The options are **Disable** and Enable.

► IIO-PCIE Express Global Options

IIO-PCIE Express Global Options

The section allows the user to configure the following PCIe global options:

PCE-E Hot Plug

Select Enable to support Hot-plugging for the selected PCIe slots which will allow the user to replace the devices installed in the slots without shutting down the system. The options are **Enable** and Disabled.

PCI-E Completion Timeout (Global) Disable

Use this feature to select the PCIe Completion Time-out settings. The options are Yes, **No**, and Per-Port.

► South Bridge

The following South Bridge information will display:

- USB Module Version
- USB Devices

Legacy USB Support

Select Enabled to support onboard legacy USB devices. Select Auto to disable legacy support if there are no legacy USB devices present. Select Disable to have all USB devices available for EFI applications only. The options are **Enabled**, Disabled and Auto.

XHCI Hand-Off

This is a work-around solution for operating systems that do not support XHCI (Extensible Host Controller Interface) hand-off. The XHCI ownership change should be claimed by the XHCI driver. The options are Disabled and **Enabled**.

Port 60/64 Emulation

Select Enabled for I/O port 60h/64h emulation support, which in turn, will provide complete legacy USB keyboard support for the operating systems that do not support legacy USB devices. The options are **Enabled** and Disabled.

PCIe PLL SSC

Select Enabled for PCH PCIe Spread Spectrum Clocking support, which will allow the BIOS to monitor and attempt to reduce the level of Electromagnetic Interference caused by the components whenever needed. The options are Enabled and **Disabled**.

Port 61h Bit-4 Emulation

Select Enabled for I/O Port 61h-Bit 4 emulation support to enhance system performance. The options are Enabled and **Disabled**.

Install Windows 7 USB Support

Select Enabled to install the Windows 7 USB utility to support legacy USB devices for Windows 7 systems. The options are Enabled and **Disabled**.

►Server ME (Management Engine) Configuration

This feature displays the following system ME configuration settings.

- Oper. (Operational) Firmware Version
- Backup Firmware Version
- Recovery Firmware Version
- ME Firmware Status #1ME Firmware Status #2
 - Current State
 - Error Code

PTT Support (Available when TPM Configuration is set to Disable.)

Select Enable to support Intel® Platform Trust Technology (PTT) to enhance system security and data integrity. Intel PTT technology integrates the Host software stack, the system BIOS, Manageability Engine (ME) features, and the PCH to run on Intel's TCG (Trusted Computing Group) in conjunction with the TPM (Trusted Platform Module) firmware installed in your system to ensure data security and integrity. The options are **Disable** and Enable.

Suppress PTT Commands (Available when PTT Support is set to Enable.)

Select Enable to bypass TPM2 commands and submit the system to the PTT (Platform Trust Technology) Firmware.

►(PCH) SATA Configuration

When this submenu is selected, the AMI BIOS automatically detects the presence of the SATA devices that are supported by the Intel PCH chip and displays the following items:

SATA Controller

This item enables or disables the onboard SATA controller supported by the Intel PCH chip. The options are **Enable** and Disable.

Configure SATA as (Available when SATA Controller is set to Enable)

Select AHCI to configure a SATA drive specified by the user as an AHCI drive. Select RAID to configure a SATA drive specified by the user as a RAID drive. The options are **AHCI** and RAID. (**Note:** This item is hidden when the SATA Controller item is set to Disabled.)

SATA HDD Unlock (Available when SATA Controller is set to Enable)

Select Enable to unlock SATA HDD password in the OS. The options are **Enable** and Disable.

SATA/sSATA RAID Boot Select (Available when Configure SATA as is set to RAID)

This feature allows the user to decide which controller should be used to boot the system. The options are None, SATA Controller, **sSATA Controller**, and Both.

Aggressive Link Power Management

When this feature is set to Enable, the SATA AHCI controller manages the power use of the SATA link. The controller will put the link in a low power mode during an extended period of I/O inactivity, and will return the link to an active state when I/O activity resumes. The options are Enable and **Disable**.

SATA RAID Option ROM/UEFI Driver (Available when Configure SATA as is set to RAID)

Select EFI to load the EFI driver for system boot. Select Legacy to load a legacy driver for system boot. The options are Disable, EFI, and **Legacy**.

SATA Port 0 - SATA Port 7

Hot Plug

Select Enable to support Hot-plugging for the device installed on a selected SATA port which will allow the user to replace the device installed in the slot without shutting down the system. The options are **Enable** and Disable.

Spin Up Device

When this feature is set to Enable, the SATA device installed on the SATA port specified by the user will start a COMRESET initialization when an edge is detected from 0 to 1. The options are Enable and **Disable**.

SATA Device Type

Use this feature to specify if the device installed on the SATA port specified by the user should be connected to a Solid State drive or a Hard Disk Drive. The options are **Hard Disk Drive** and Solid State Drive.

►sSATA Configuration

When this submenu is selected, the AMI BIOS automatically detects the presence of the sSATA devices that are supported by the sSATA controller and displays the following items:

sSATA Controller

This item enables or disables the onboard sSATA controller supported by the Intel PCH. The options are **Enable** and Disable.

Configure sSATA as (Available when sSATA Controller is set to Enable)

Select AHCI to configure an sSATA drive specified by the user as an AHCI drive. Select RAID to configure an sSATA drive specified by the user as a RAID drive. The options are **AHCI** and RAID. (**Note:** This feature is hidden when the sSATA Controller item is set to Disabled.)

SATA HDD Unlock (Available when sSATA Controller is set to Enable)

Select Enable to unlock sSATA HDD password in the OS. The options are **Enable** and Disable.

SATA/sSATA RAID Boot Select (Available when Configure sSATA as is set to RAID)

This feature allows the user to decide which controller should be used to boot the system. The options are None, SATA Controller, **sSATA Controller**, and Both.

Aggressive Link Power Management

When this feature is set to Enable, the sSATA AHCI controller manages the power use of the sSATA link. The controller will put the link in a low power mode during an extended period of I/O inactivity, and will return the link to an active state when I/O activity resumes. The options are **Disable** and Enable.

sSATA RAID Option ROM/UEFI Driver (Available when Configure sSATA as is set to RAID)

Select EFI to load the EFI driver for system boot. Select Legacy to load a legacy driver for system boot. The options are Disable, EFI, and **Legacy**.

sSATA Port 0 - sSATA Port 5

Hot Plug

Select Enable to support Hot-plugging for the device installed on an sSATA port specified by the user which will allow the user to replace the device installed in the slot without shutting down the system. The options are **Enable** and Disabled.

Spin Up Device

This setting allows the SATA device installed on the SATA port specified by the user to start a COMRESET initialization when an edge is detected from 0 to 1. The options are Enable and **Disable**.

sSATA Device Type

Use this feature to specify if the device installed on the sSATA port specified by the user should be connected to a Solid State drive or a Hard Disk Drive. The options are **Hard Disk Drive** and Solid State Drive.

►PCIe/PCI/PnP Configuration

The following PCI information will be displayed:

- **PCI Bus Driver Version**
- **PCI Devices Common Settings**

Above 4G Decoding (Available if the system supports 64-bit PCI decoding)

Select Enabled to decode a PCI device that supports 64-bit in the space above 4G Address. The options are **Enabled** and Disabled.

SR-IOV Support (Available if the system supports Single-Root Virtualization)

Select Enabled for Single-Root IO Virtualization support. The options are Enabled and **Disabled**.

MMIOHBase

Use this feature to select the base memory size according to memory-address mapping for the IO hub. The options are **56T**, 40T, 24T, 16T, 4T, and 1T.

MMIO High Granularity Size

Use this feature to select the high memory size according to memory-address mapping for the IO hub. The options are 1G, 4G, 16G, 64G, **256G**, and 1024G.

Maximum Read Request

Select Auto for the system BIOS to automatically set the maximum size for a read request for a PCIe device to enhance system performance. The options are **Auto**, 128 Bytes, 256 Bytes, 512 Bytes, 1024 Bytes, 2048 Bytes, and 4096 Bytes.

MMCFG Base

This feature determines how the lowest MMCFG (Memory-Mapped Configuration) base is assigned to onboard PCI devices. The options are 1G, 1.5G, 1.75G, **2G**, 2.25G, and 3G.

VGA Priority

Use this feature to select the graphics device to be used as the primary video display for system boot. The options are Auto, **Onboard** and Offboard.

Disable Unused PLX

Select Enabled to turn off PCIe support when there are no downstream PCIe devices attached to this device. The options are **Enabled** and Disabled.

PLX Workaround For NVIDIA GPU

Select Enabled to shut down PLX BAR0 and BAR1 support when a NVIDIA GPU is populated in the slots. The options are **Enabled** and Disabled.

PCI Devices Option ROM Settings

Onboard NVME1/NVME2 OPROM

Select EFI to allow the user to boot the computer using an EFI (Extensible Firmware Interface) device installed on the NVME connector specified by the user. Select Legacy to allow the user to boot the computer using a legacy device installed on the NVME connector specified by the user. The options are Disabled, Legacy and **EFI**.

CPU1 Slot1 PCI-E x16 RSC-R1U-E16R OPROM/ CPU2 Slot2 PCI-E x16 RSC-R1U-E16R OPROM

Select EFI to allow the user to boot the computer using an EFI (Extensible Firmware Interface) device installed on the PCIe slot specified by the user. Select Legacy to allow the user to boot the computer using a legacy device installed on the PCIe slot specified by the user. The options are Disabled, **Legacy** and EFI. (**Note:** Riser card names may differ in each system.)

Onboard Video OPROM (Option ROM)

Use this feature to select the Onboard Video Option ROM type. The options are Do Not Launch, **Legacy** and UEFI.

Onboard LAN1 ROM

Use this feature to select the type of device installed in LAN Port1, which will be used for system boot. The options are **Legacy**, EFI and Disabled.

Onboard LAN 2 ROM

Use this feature to select the type of device installed in LAN Port2, which will be used for system boot. The options are Legacy, EFI and **Disabled**.

► Network Stack Configuration

Network Stack

Select Enabled to enable PXE (Preboot Execution Environment) or UEFI (Unified Extensible Firmware Interface) for network stack support. The options are **Enabled** and Disabled.

**If "Network Stack" is set to Enabled, the following items will display:*

Ipv4 PXE Support

Select Enabled to enable Ipv4 PXE boot support. If this feature is disabled, it will not create the Ipv4 PXE boot option. The options are Disabled and **Enabled**.

Ipv4 HTTP Support

Select Enabled to enable Ipv4 HTTP boot support. If this feature is disabled, it will not create the Ipv4 HTTP boot option. The options are Enabled and **Disabled**.

Ipv6 PXE Support

Select Enabled to enable Ipv6 PXE boot support. If this feature is disabled, it will not create the Ipv6 PXE boot option. The options are Disabled and **Enabled**.

Ipv6 HTTP Support

Select Enabled to enable Ipv6 HTTP boot support. If this feature is disabled, it will not create the Ipv6 HTTP boot option. The options are Enabled and **Disabled**.

IPSEC Certificate

Select Enable to enable the IPSEC certificate for Ikev support. The options are Disabled and **Enabled**.

PXE Boot Wait Time

Use this feature to select the wait time to press the <ESC> key to abort the PXE boot. The default is **0**.

Media Detect Time

Use this feature to select the wait time in seconds for the BIOS ROM to detect the LAN media (Internet connection or LAN port). The default is **1**.

► Super IO Configuration

Super IO Chip AST2500

► Serial Port 1 Configuration

Serial Port

Select Enabled to enable Serial Port 1. The options are **Enabled** and Disabled.

Device Settings (Available when the item above "Serial Port (1)" is set to Enabled)

This item displays the base I/O port address and the Interrupt Request address of a serial port specified by the user.

Change Settings

This feature specifies the base I/O port address and the Interrupt Request address of Serial Port 1. Select **Auto** for the BIOS to automatically assign the base I/O and IRQ address to a serial port specified.

The options for Serial Port 1 are **Auto**, (IO=3F8h; IRQ=4), (IO=3F8h; IRQ=3, 4, 5, 6, 7, 9, 10, 11, 12), (IO=2F8h; IRQ=3, 4, 5, 6, 7, 9, 10, 11, 12); (IO=3E8h; IRQ=3, 4, 5, 6, 7, 9, 10, 11, 12), and (IO=2E8h; IRQ=3, 4, 5, 6, 7, 9, 10, 11, 12).

► Serial Port 2 Configuration

Serial Port

Select Enabled to enable Serial Port 2. The options are **Enabled** and Disabled.

Device Settings (IO=2F8h; IRQ=3) (Available when the item above "Serial Port (2)" is set to Enabled)

This feature displays the base I/O port address and the Interrupt Request address of a serial port specified by the user.

Change Settings

This feature specifies the base I/O port address and the Interrupt Request address of Serial Port 2. Select Auto for the BIOS to automatically assign the base I/O and IRQ address to a serial port specified.

The options for Serial Port 2 are **Auto**, (IO=2F8h; IRQ=3), (IO=3F8h; IRQ=3, 4, 5, 6, 7, 9, 10, 11, 12), (IO=2F8h; IRQ=3, 4, 5, 6, 7, 9, 10, 11, 12); (IO=3E8h; IRQ=3, 4, 5, 6, 7, 9, 10, 11, 12), and (IO=2E8h; IRQ=3, 4, 5, 6, 7, 9, 10, 11, 12).

Serial Port 2 Attribute

Select SOL to use COM Port 2 as a Serial_Over_LAN (SOL) port for console redirection. The options are COM and **SOL**.

►Serial Port Console Redirection

COM 1 Console Redirection

Select Enabled to enable COM Port 1 for Console Redirection, which will allow a client machine to be connected to a host machine at a remote site for networking. The options are Enabled and **Disabled**.

**If the item above is set to Enabled, the following items will become available for configuration:*

COM 1

►Console Redirection Settings (for COM 1)

Terminal Type

Use this feature to select the target terminal emulation type for Console Redirection. Select VT100 to use the ASCII Character set. Select VT100+ to add color and function key support. Select ANSI to use the Extended ASCII Character Set. Select VT-UTF8 to use UTF8 encoding to map Unicode characters into one or more bytes. The options are ANSI, VT100, **VT100+**, and VT-UTF8.

Bits Per second

Use this feature to set the transmission speed for a serial port used in Console Redirection. Make sure that the same speed is used in the host computer and the client computer. A lower transmission speed may be required for long and busy lines. The options are 9600, 19200, 38400, 57600 and **115200** (bits per second).

Data Bits

Use this feature to set the data transmission size for Console Redirection. The options are 7 (Bits) and **8 (Bits)**.

Parity

A parity bit can be sent along with regular data bits to detect data transmission errors. Select Even if the parity bit is set to 0, and the number of 1's in data bits is even. Select Odd if the parity bit is set to 0, and the number of 1's in data bits is odd. Select None if you do not want to send a parity bit with your data bits in transmission. Select Mark to add a mark as a parity bit to be sent along with the data bits. Select Space to add a Space as a parity bit to be sent with your data bits. The options are **None**, Even, Odd, Mark and Space.

Stop Bits

A stop bit indicates the end of a serial data packet. Select 1 Stop Bit for standard serial data communication. Select 2 Stop Bits if slower devices are used. The options are **1** and 2.

Flow Control

Use this feature to set the flow control for Console Redirection to prevent data loss caused by buffer overflow. Send a "Stop" signal to stop sending data when the receiving buffer is full. Send a "Start" signal to start sending data when the receiving buffer is empty. The options are **None** and Hardware RTS/CTS.

VT-UTF8 Combo Key Support

Select Enabled to enable VT-UTF8 Combination Key support for ANSI/VT100 terminals. The options are **Enabled** and Disabled.

Recorder Mode

Select Enabled to capture the data displayed on a terminal and send it as text messages to a remote server. The options are **Disabled** and Enabled.

Resolution 100x31

Select Enabled for extended-terminal resolution support. The options are Disabled and **Enabled**.

Putty KeyPad

This feature selects Function Keys and KeyPad settings for Putty, which is a terminal emulator designed for the Windows OS. The options are **VT100**, LINUX, XTERMR6, SCO, ESCN, and VT400.

COM2/SOL (Serial-Over-LAN)**Console Redirection (for COM2/SOL)**

Select Enabled to use the SOL port for Console Redirection. The options are **Enabled** and Disabled.

**If the item above is set to Enabled, the following items will become available for user's configuration:*

► Console Redirection Settings (for COM2/SOL)

Use this feature to specify how the host computer will exchange data with the client computer, which is the remote computer used by the user.

Terminal Type

Use this feature to select the target terminal emulation type for Console Redirection. Select VT100 to use the ASCII Character set. Select VT100+ to add color and function key support. Select ANSI to use the Extended ASCII Character Set. Select VT-UTF8 to use UTF8 encoding to map Unicode characters into one or more bytes. The options are ANSI, VT100, **VT100+**, and VT-UTF8.

Bits Per second

Use this feature to set the transmission speed for a serial port used in Console Redirection. Make sure that the same speed is used in the host computer and the client computer. A lower transmission speed may be required for long and busy lines. The options are 9600, 19200, 38400, 57600 and **115200** (bits per second).

Data Bits

Use this feature to set the data transmission size for Console Redirection. The options are 7 (Bits) and **8 (Bits)**.

Parity

A parity bit can be sent along with regular data bits to detect data transmission errors. Select Even if the parity bit is set to 0, and the number of 1's in data bits is even. Select Odd if the parity bit is set to 0, and the number of 1's in data bits is odd. Select None if you do not want to send a parity bit with your data bits in transmission. Select Mark to add a mark as a parity bit to be sent along with the data bits. Select Space to add a Space as a parity bit to be sent with your data bits. The options are **None**, Even, Odd, Mark and Space.

Stop Bits

A stop bit indicates the end of a serial data packet. Select 1 Stop Bit for standard serial data communication. Select 2 Stop Bits if slower devices are used. The options are **1** and 2.

Flow Control

Use this feature to set the flow control for Console Redirection to prevent data loss caused by buffer overflow. Send a "Stop" signal to stop sending data when the receiving buffer is full. Send a "Start" signal to start data-sending when the receiving buffer is empty. The options are **None** and Hardware RTS/CTS.

VT-UTF8 Combo Key Support

Select Enabled to enable VT-UTF8 Combination Key support for ANSI/VT100 terminals. The options are **Enabled** and Disabled.

Recorder Mode

Select Enabled to capture the data displayed on a terminal and send it as text messages to a remote server. The options are **Disabled** and Enabled.

Resolution 100x31

Select Enabled for extended-terminal resolution support. The options are Disabled and **Enabled**.

Putty KeyPad

This feature selects Function Keys and KeyPad settings for Putty, which is a terminal emulator designed for the Windows OS. The options are **VT100**, LINUX, XTERMR6, SCO, ESCN, and VT400.

► Legacy Console Redirection Settings

► Console Redirection Settings (for COM2/SOL)

Use this feature to specify how the host computer will exchange data with the client computer, which is the remote computer used by the user.

Terminal Type

Use this feature to select the target terminal emulation type for Console Redirection. Select VT100 to use the ASCII Character set. Select VT100+ to add color and function key support. Select ANSI to use the Extended ASCII Character Set. Select VT-UTF8 to use UTF8 encoding to map Unicode characters into one or more bytes. The options are ANSI, VT100, **VT100+**, and VT-UTF8.

Bits Per second

Use this feature to set the transmission speed for a serial port used in Console Redirection. Make sure that the same speed is used in the host computer and the client computer. A lower transmission speed may be required for long and busy lines. The options are 9600, 19200, 38400, 57600 and **115200** (bits per second).

Data Bits

Use this feature to set the data transmission size for Console Redirection. The options are 7 (Bits) and **8 (Bits)**.

Parity

A parity bit can be sent along with regular data bits to detect data transmission errors. Select Even if the parity bit is set to 0, and the number of 1's in data bits is even. Select Odd if the parity bit is set to 0, and the number of 1's in data bits is odd. Select None if you do not want to send a parity bit with your data bits in transmission. Select Mark to add a mark as a parity bit to be sent along with the data bits. Select Space to add a Space as a parity bit to be sent with your data bits. The options are **None**, Even, Odd, Mark and Space.

Stop Bits

A stop bit indicates the end of a serial data packet. Select 1 Stop Bit for standard serial data communication. Select 2 Stop Bits if slower devices are used. The options are **1** and **2**.

Flow Control

Use this feature to set the flow control for Console Redirection to prevent data loss caused by buffer overflow. Send a "Stop" signal to stop sending data when the receiving buffer is full. Send a "Start" signal to start data-sending when the receiving buffer is empty. The options are **None** and Hardware RTS/CTS.

VT-UTF8 Combo Key Support

Select Enabled to enable VT-UTF8 Combination Key support for ANSI/VT100 terminals. The options are **Enabled** and Disabled.

Recorder Mode

Select Enabled to capture the data displayed on a terminal and send it as text messages to a remote server. The options are **Disabled** and Enabled.

Resolution 100x31

Select Enabled for extended-terminal resolution support. The options are Disabled and **Enabled**.

Putty KeyPad

This feature selects Function Keys and KeyPad settings for Putty, which is a terminal emulator designed for the Windows OS. The options are **VT100**, LINUX, XTERMR6, SCO, ESCN, and VT400.

Legacy Console Redirection Settings

Use this feature to select the COM port to display redirection of Legacy OS and Legacy OPROM messages. The options are COM1 and **COM2/SOL**.

Legacy OS Redirection Resolution

Use this feature to select the number of rows and columns used in Console Redirection for Legacy OS support. The options are **80x24** and 80x25.

Redirection After BIOS Post

Use this feature to enable or disable Legacy Console Redirection after BIOS POST. When the option-Bootloader is selected, Legacy Console Redirection is disabled before booting the OS. When the option-Always Enable is selected, Legacy Console Redirection remains enabled upon OS bootup. The options are **Always Enable** and Bootloader.

Serial Port for Out-of-Band Management/Windows Emergency Management Services (EMS)

The feature allows the user to configure Console Redirection settings to support Out-of-Band Serial Port management.

Console Redirection (for EMS)

Select Enabled to use a COM port specified by the user for EMS Console Redirection. The options are Enabled and **Disabled**.

**If the item above is set to Enabled, the following items will become available for user's configuration:*

► Console Redirection Settings (for EMS)

Out-of-Band Management Port

This feature selects a serial port in a client server to be used by the Windows Emergency Management Services (EMS) to communicate with a remote host server. The options are **COM1 (Console Redirection)** and COM2/SOL (Console Redirection).

Terminal Type

Use this feature to select the target terminal emulation type for Console Redirection. Select VT100 to use the ASCII character set. Select VT100+ to add color and function key support. Select ANSI to use the extended ASCII character set. Select VT-UTF8 to use UTF8 encoding to map Unicode characters into one or more bytes. The options are ANSI, VT100, VT100+, and **VT-UTF8**.

Bits Per Second

This feature sets the transmission speed for a serial port used in Console Redirection. Make sure that the same speed is used in both host computer and the client computer. A lower transmission speed may be required for long and busy lines. The options are 9600, 19200, 57600, and **115200** (bits per second).

Flow Control

Use this feature to set the flow control for Console Redirection to prevent data loss caused by buffer overflow. Send a "Stop" signal to stop data-sending when the receiving buffer is full. Send a "Start" signal to start data-sending when the receiving buffer is empty. The options are **None**, Hardware RTS/CTS, and Software Xon/Xoff.

The setting for each these features is displayed:

Data Bits, Parity, Stop Bits

►ACPI Settings

Use this feature to configure Advanced Configuration and Power Interface (ACPI) power management settings for your system.

NUMA Support (Available when the OS supports this feature)

Select Enabled to enable Non-Uniform Memory Access support to enhance system performance. The options are **Enabled** and Disabled.

WHEA Support

Select Enabled to support the Windows Hardware Error Architecture (WHEA) platform and provide a common infrastructure for the system to handle hardware errors within the Windows OS environment to reduce system crashes and to enhance system recovery and health monitoring. The options are **Enabled** and Disabled.

►Trusted Computing (Available when a TPM device is installed and detected by the BIOS)

When a TPM (Trusted-Platform Module) device is detected in your machine, the following information will be displayed.



- TPM2.0 Device Found
- Firmware Version
- Vendor

Security Device Support

If this feature and the TPM jumper (JPT1) on the motherboard are both enabled, the onboard security (TPM) device will be enabled in the BIOS to enhance data integrity and system security. Please note that the OS will not show the security device. Neither TCG EFI protocol nor INT1A interaction will be made available for use. If you have made changes on the setting on this item, be sure to reboot the system for the change to take effect. The options are Disable and **Enable**. If this option is set to Enable, the following screen and items will display:

- Active PCR Banks
- Available PCR Banks

SHA-1 PCR Bank

Select Enabled to enable SHA-1 PCR Bank support to enhance system security and data integrity. The options are **Enabled** and Disabled.

SHA256 PCR Bank

Select Enabled to enable SHA256 PCR Bank support to enhance system security and data integrity. The options are **Enabled** and Disabled.

Pending Operation

Use this feature to schedule a TPM-related operation to be performed by a security (TPM) device at the next system boot to enhance system data integrity. Your system will reboot to carry out a pending TPM operation. The options are **None** and TPM Clear.



Note: Your system will reboot to carry out a pending TPM operation.

Platform Hierarchy (for TPM Version 2.0 and above)

Select Enabled for TPM Platform Hierarchy support which will allow the manufacturer to utilize the cryptographic algorithm to define a constant key or a fixed set of keys to be used for initial system boot. These early boot codes are shipped with the platform and are included in the list of "public keys". During system boot, the platform firmware uses the trusted public keys to verify a digital signature in an attempt to manage and control the security of the platform firmware used in a host system via a TPM device. The options are **Enabled** and Disabled.

Storage Hierarchy

Select Enabled for TPM Storage Hierarchy support that is intended to be used for non-privacy-sensitive operations by the platform owner such as an IT professional or the end user. Storage Hierarchy has an owner policy and an authorization value, both of which can be set and are held constant (-rarely changed) through reboots. This hierarchy can be cleared or changed independently of the other hierarchies. The options are **Enabled** and Disabled.

Endorsement Hierarchy

Select Enabled for Endorsement Hierarchy support, which contains separate controls to address the user's privacy concerns because the primary keys in this hierarchy are certified

by the TPM or a manufacturer to be constrained to an authentic TPM device that is attached to an authentic platform. A primary key can be an encrypted, and a certificate can be created using TPM2_ActivateCredential. It allows the user to independently enable "flag, policy, and authorization value" without involving other hierarchies. A user with privacy concerns can disable the endorsement hierarchy while still using the storage hierarchy for TPM applications and permitting the platform software to use the TPM. The options are **Enabled** and Disabled.

PH (Platform Hierarchy) Randomization (for TPM Version 2.0 and above)

Select Enabled for Platform Hierarchy Randomization support, which is used only during the platform developmental stage. This feature cannot be enabled in the production platforms. The options are **Disabled** and Enabled.

TXT Support

Select Enabled to enable Intel Trusted Execution Technology (TXT) support to enhance system security and data integrity. The options are **Disabled** and Enabled.

 **Note 1:** If the option for this item (TXT Support) is set to Enabled, be sure to disable EV DFX (Device Function On-Hide) support for the system to work properly. (EV DFX is under "IIO Configuration" in the "Chipset/North Bridge" submenu).

Note 2: For more information on TPM, please refer to the TPM manual at <http://www.supermicro.com/manuals/other>.

► TLS Authenticate Configuration

When this submenu is selected, the following items will be displayed:

► Server CA Configuration

This feature allows the user to configure the client certificate that is to be used by the server.

► Enroll Certification

This feature allows the user to enroll the certificate in the system.

► Enroll Cert (Certification) Using File

This feature allows the user to enroll the security certificate in the system by using a file.

Cert (Certification) GUID (Global Unique Identifier)

This feature displays the GUID for this system.

► Commit Changes and Exit

Select this feature to keep the changes you have made and exit from the system.

▶Discard Changes and Exit

Select this feature to discard the changes you have made and exit from the system.

▶Delete Certification

If this feature is set to Enable, the certificate enrolled in the system will be deleted. The options are Enable and **Disable**.

▶Client Certification Configuration

This feature allows the user to configure the client certificate to be used by the server.

▶Enroll Certification

This feature allows the user to enroll the certificate in the system.

▶Enroll Cert (Certification) Using File

This feature allows the user to enroll the security certificate in the system by using a file.

Cert (Certification) GUID (Global Unique Identifier)

This feature displays the GUID for this system.

▶Commit Changes and Exit

Select this feature to keep the changes you have made and exit from the system.

▶Discard Changes and Exit

Select this feature to discard the changes you have made and exit from the system.

▶Delete Certification

If this feature is set to Enable, the certificate enrolled in the system will be deleted. The options are Enable and **Disable**.

▶RAM Disk Configuration

This feature allows the user to configure the settings for the RAM disks installed in the system. When you select this submenu and press <Enter>, the following items will display:

- Disk Memory Type: This feature specifies the type of memory that is available for you to create a RAM disk. The options are **Boot Service Data** and Reserved.

► Create Raw

This feature allows the user to create a raw RAM disk from all available memory modules in the system. When you select this submenu and press <Enter>, the following items will display:

- **Size (Hex):** Use this feature to set the size of the raw RAM disk. The default setting is **1**.
- **Create & Exit:** Select this feature when you want to exit from this submenu after you've created a raw RAM disk.
- **Discard & Exit:** Select this feature when you want to abandon the changes you've made and to exit from the submenu.

► Create from File

This feature allows the user to create a RAM disk from a file specified by the user. Select this submenu and press <Enter>, the following items will display:

- **Create RAM Disk List:** Use this feature to create a RAM disk list.
- **Remove Selected RAM Disk(s):** Use this feature to delete the RAM disk(s) specified by the user.

► Intel® Optane® DC Persistent Memory Configuration

When you select this submenu and press <Enter>, the following screen will display:

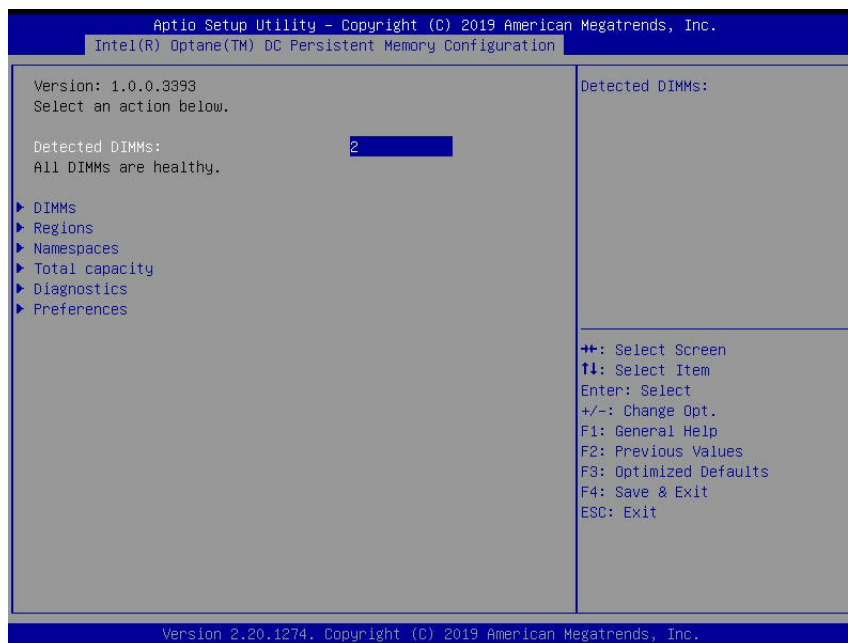

- **Version:** This feature displays the version of DCPMM used in the system.
- **Select an action below**
- **Detected DIMMs:** This feature displays the number of DCPMM memory modules detected by the BOS.
- **All DIMMs are healthy** (The health status of the DCPMM is displayed.)

► DIMMs

This submenu allows the user to view and configure the settings of the DCPMM memory modules installed in the system. Select this submenu and press <Enter>, the following items will display:

- Select a specific DIMM that you want to view.
- DIMMs on Socket 0x0000:
- DIMMs on Socket 0x0001:

► DIMM ID

This submenu allows the user to view and to perform an action on a DCPMM module specified by the user. When this submenu is selected, the following items will display:

- **DIMM UID:** This feature displays the unique ID of the DCPMM module.
- **DIMM Handle:** This feature displays the unique handle that the CPU assigns to the DCPMM module.
- **DIMM Physical ID:** This feature displays the physical ID of the DCPMM module.
- **Manageability State:** This feature indicates the manageability state of the DCPMM module.
- **Health State:** This feature indicates the health state of the DCPMM module.
- **Health State Reason:** This feature indicates the reason that effectuates the health state of the DCPMM module.
- **Capacity:** This feature indicates the capacity of the DCPMM module.
- **Firmware Version:** This feature indicates the firmware version of the DCPMM module.
- **Firmware API Version:** This feature indicates the firmware API version of the DCPMM module.

- **Lock State:** This feature indicates the lock state of the DCPMM module.
- **Staged Firmware Version:** This feature indicates the staged firmware version of the DCPMM module.
- **Firmware Update Status:** This feature indicates the firmware update status of the DCPMM module.
- **Manufacturer:** This feature indicates the manufacturer of the DCPMM module.

Show More Details

Select Enabled to view more detailed information on the DCPMM module. The options are **Disabled** and **Enabled**.

**If this option is set to Enabled, the following items will display:*

- Serial Number
- Part Number
- Socket
- Memory Controller ID
- Vendor ID
- Device ID
- System Vendor ID
- Subsystem Vendor ID
- Subsystem Device ID
- Device Locator
- Subsystem Revision ID
- Interface Format Code
- Manufacturing Information Valid
- Manufacturing Date
- Manufacturing Location
- Memory Type
- Memory Bank Label
- Data Width Label [b]

- Total Width [b]
- Speed [MHz]
- Channel ID
- Channel Position
- Revision ID
- Form Factor
- Manufacturer ID
- Controller Revision ID
- IS New
- Memory Capacity
- APP Direct Capacity
- Unconfigured Capacity
- Inaccessible Capacity
- Reserved Capacity
- Peak Power Budget [mW]
- Avg (Average) Power Budget [mW]
- Max Average Power Budget [mW]
- Package Sparing Capable
- Package Sparing Enabled
- Package Spares Available
- Configuration Status
- SKU Violation
- ARS Status
- Overwrite DIMM Status
- Last Shutdown Time

- First Fast Refresh
- Viral Policy Enable
- Viral State
- Latched Last Shutdown Status
- Unlatched Last Shutdown Status
- Security Capabilities
- Modes Supported
- Boot Status
- AIT DRAM Enabled
- Error Injection Enabled
- Media Temperature Injection Enabled
- Software Triggers Enabled
- Software Triggers Enabled Details
- Poison Error Injections Counter
- Poison Error Clear Counter
- Media Temperature Injections Counter
- Software Triggers Counter
- Master Passphrase Enabled

► Monitor Health

Select this submenu to view the health status and thresholds of the DCPMM module specified by the user.

- **Sensor Type:** This feature displays the type of health items that are being monitored.
- **Value:** This feature displays the value of the monitor sensor mentioned above.
- **Non-critical Thresholds:** This feature displays the normal threshold value for the DCPMM module to maintain normal operations.

- **Critical Lower Threshold:** This feature displays the lowest threshold value for the DCPMM module to maintain normal operations.
- **Critical Upper Threshold:** This feature displays the higher threshold value for the DCPMM module to maintain normal operations.
- **Fatal Threshold:** This feature indicates the highest value allowed for the DCPMM module to remain functional. Beyond this value, the DCPMM selected will become non-operational.
- **State:** This feature indicates the health state of the DCPMM module.
- **Alarm Enabled State:** This feature indicates the status of the non-critical threshold alarm for the DCPMM module specified by the user.
- **Modify Non-critical Thresholds:** Use this feature to modify non-critical thresholds.
- **Controller Temperature:** This feature displays the controller temperature in Celsius.
- **Media Temperature:** This feature displays the media temperature in Celsius.
- **Percentage Remaining**

►Apply Changes

Use this feature to apply changes that you've made on the DCPMM modules to the system.

►Back to Main Menu

Select this feature and press <Enter> to go back to the **Intel® Optane® DC Persistent Memory Configuration** menu.

►Update Firmware

Use this feature to select the firmware image to be loaded on the DCPMM module. Once it is loaded to the system, please reboot the system and select update for the firmware to take effect. The following items will display:

- **Current Firmware Version:** This feature displays the current firmware version.
- **Selected Firmware Version:** This feature allows the user to select a new firmware version to use.
- **File:** This feature allows the user to specify the file path in the root directory that contains the new firmware for firmware update.
- **Staged Firmware Version:** This feature indicates the staged firmware version of the DCPMM module specified by the user.

►Update

Select this feature to update the firmware settings.

►Back to Main Menu

Select this feature and press <Enter> to go back to the **Intel® Optane® DC Persistent Memory Configuration** menu.

►Configure Security

Use this feature to configure the security settings for all onboard DCPMM modules.

State

Select Enabled to configure the security settings for the DCPMM modules installed in the system. The options are **Disabled** and Enabled.

- **Enable Security:** Use this feature to enable security settings for the onboard DCPMM modules.
- **Secure Erase:** Use this feature to erase all the persistent data saved in the DCPMM modules.
- **Freeze Lock:** Use this feature to enable the security lock for the onboard DCPMM modules.

►Back to Main Menu

- Select this feature and press <Enter> to go back to the **Intel® Optane® DC Persistent Memory Configuration** menu.

►Configure Data Policy

Use this feature to configure the data policy settings for all onboard DCPMM modules.

First Fast Fresh State

Select Enabled to display the First Fast Fresh state for onboard DCPMM modules.

►Enable First Fast Fresh State

Select Enabled to support the first fast fresh state of DCPMM data policy.

►Disable First Fast Fresh State

Select Disable to disable the first fast fresh state of DCPMM data policy.

► Back to Main Menu

Select this feature and press <Enter> to go back to the **Intel® Optane® DC Persistent Memory Configuration** menu.

► Regions

Current Configuration

► Region ID

When this submenu is selected, the following items will display:

- **Region ID:** This feature displays the Region ID of the DCPMM module.
- **DIMM ID:** This feature displays the DIMM ID of the DCPMM module.
- **ISet ID:** This feature displays the ISet ID of the DCPMM module.
- **Persistent Memory Type:** This feature indicates the persistent memory type of the DCPMM module.
- **Capacity:** This feature indicates the capacity of the DCPMM module.
- **Free Capacity:** This feature indicates the capacity of the DCPMM module that is available for use.
- **Health:** This feature indicates the health state of the DCPMM module.
- **Socket ID:** This feature displays the Socket ID of the DCPMM module.

Persistent Memory Type

Capacity

Free Capacity

► Create Goal Configuration

When this submenu is selected, the following items will display:

- **Create Goal Configuration for:** Use this feature to select the target to create goal configuration for the DCPMM modules. The options are **Platform** and **Socket**.
- **Reserved [%]:** Use this feature to reserve a percentage of the DCPMM capacity for a particular purpose and keep this portion of memory space from being mapped into the physical address of system for system use.
- **Memory Mode [%]:** Use this feature to reserve a percentage of the DCPMM capacity for special use in a specific Memory Mode. Please note that this value can be automatically set by the system.

Persistent Memory Type

This feature allows the user to specify the type of DCPMM memory capacity to be created. The options are **App Direct** and App Direct Not Interleave.

Namespace Label Version

Use this feature to view and modify the namespace label version to initialize when creating goals. The options are **1.2** and 1.1.

►Back to Regions Menu

Select this feature and press <Enter> to go back to the Regions submenu.

►Back to Main Menu

Select this feature and press <Enter> to go back to the **Intel® Optane® DC Persistent Memory Configuration** menu.

►Namespaces

This subsection allows the user to select a namespace to view the following information on the selected namespace

Namespace ID/Name/Health Status

►0x00000201

Select this feature and press <Enter>, the following items will display:

- UUID
- ID
- Name
- Region
- Health
- Mode
- Block Size
- Units: Use this feature to change the namespace capacity (in the unit of B, MB, MiB, GB, **GiB**, TB, and TiB.)
- Capacity
- Label Version

►Save: After configuring the settings for the namespace above, click on <Save> to save changes.

► **Delete** After configuring the settings for the namespace above, click on <delete> to delete the changes you've made on the namespace. Please note that all data contained in the namespace will be deleted as well when you press <delete>.

► **Back to Namespaces**

► **Back to Main Menu**

► **Create Namespace**

Use this submenu to create a namespace. The following information will display:

Name

Region ID

This feature displays the region ID of the DCPMM module. The options are **0x0001** and 0x0002.

Mode

Use this item to set the Namespace mode. The options are **None** and Sector.

Capacity Input

Select Remaining to use the maximum memory capacity currently available as system memory capacity. Select Manual to enter the system memory capacity manually. The options are **Remaining** and Manual.

Units

Use this feature to select the type of unit to use when inputting namespace capacity in the system.

The options are B, MB, MiB, GB, **GiB**, TB, and TiB.

- **Capacity**: This feature displays the namespace capacity.

► **Back to Namespace**

Select this feature and press <Enter> to go back to the **Namespaces** submenu.

► **Back to Main Menu**

Select this feature and press <Enter> to go back to the **Intel® Optane® DC Persistent Memory Configuration** menu.

► **Total Capacity**

This feature allows the user to set the total DCPMM resource capacity allocated across all segments in the host server.

- **Raw Capacity:** This feature specifies the raw capacity of the DCPMM module.
- **App. Direct Capacity:** This feature specifies the App. direct capacity of the DCPMM module.
- **Memory Capacity:** This feature specifies the memory capacity of the DCPMM module.
- **Unconfigured Capacity:** This feature specifies the capacity of the DCPMM module that has not been configured.
- **Inaccessible Capacity:** This feature specifies the capacity of the DCPMM memory that is not accessible to the user.
- **Reserved Capacity:** This feature specifies the capacity of the DCPMM memory that is reserved for a particular use.

► **Back to Main Menu**

Select this feature and press <Enter> to go back to the **Intel® Optane® DC Persistent Memory Configuration** menu.

► **Diagnostics**

Perform Diagnostic Tests on DIMMs

When you select this submenu and press <enter>, the following items will display:

Choose Diagnostics Type:

Quick Diagnostics

Select Enabled for the quick diagnostics test to be performed on the DCPMM module installed in the system when needed. The options are **Enabled** and Disabled.

DIMM ID

Select Enabled for the quick diagnostics test to be performed on the DCPMM module. The options are **Enabled** and Disabled. (**Note:** More DIMM IDs will appear If more DCPMM modules are installed on the motherboard.)

Config (Configure) Diagnostics

Select Enabled for the platform configuration diagnostics test to be performed on the DCPMM module. The options are **Enabled** and Disabled.

FW (Firmware) Diagnostics

Select Enabled for the firmware diagnostics test to be performed on the DCPMM module. The options are **Enabled** and Disabled.

Security Diagnostics

Select Enabled for the security diagnostics test to be performed on the DCPMM module. The options are **Enabled** and Disabled.

▶Execute Tests

Select this feature and press <Enter> to execute the selected diagnostic tests.

▶Back to Main Menu

Select this feature and press <Enter> to go back to the **Intel® Optane® DC Persistent Memory Configuration** menu.

▶Preferences

View and/or modify user preferences

Default DIMM ID

This feature allows the user to view and to modify the default DIMM ID as displayed on the screen. The options are **Handle** and UID.

Capacity Units

This feature allows the user to view and to set the default capacity unit of the selected DCPMM to be displayed on the screen. The options are **Auto**, Auto_10, B, MB, MiB, GB, GiB, TB, and TiB.

App Direct Settings

This feature displays the Application Direct Settings. The default setting is **4KB_4KB (Recommended)**.

App Direct Granularity

This feature allows the user to view and modify the minimum App Direct Granularity for each DIMM installed on the motherboard. The default setting is **Recommended** and 1.

▶Back to Main Menu

Use this feature to go back to the **Intel® Optane® DC Persistent Memory Configuration** menu.

4.4 Event Logs

Use this feature to configure Event Log settings.

 **Note:** After you've made a change on a setting below, please be sure to reboot the system for the change to take effect.



► Change SMBIOS Event Log Settings

Enabling/Disabling Options

SMBIOS Event Log

Select Enabled to enable SMBIOS (System Management BIOS) Event Logging during system boot. The options are **Enabled** and Disabled.

Erasing Settings

Erase Event Log

Select "No" to keep the event log without erasing it upon next system bootup. Select "Yes, Next Reset" to erase the event log upon next system reboot. The options are **"No"**, "Yes, Next Reset", and "Yes, Every Reset".

When Log is Full

Select Erase Immediately to immediately erase all errors in the SMBIOS event log when the event log is full. Select Do Nothing for the system to do nothing when the SMBIOS event log is full. The options are **Do Nothing** and Erase Immediately.

SMBIOS Event Log Standard Settings

Log System Boot Event

Select Enabled to log system boot events. The options are Enabled and **Disabled**.

MECI (Multiple Event Count Increment)

Enter the increment value for the multiple event counter. Enter a number between 1 to 255. The default setting is 1.

METW (Multiple Event Count Time Window)

This feature is used to determine how long (in minutes) should the multiple event counter wait before generating a new event log. Enter a number between 0 to 99. The default setting is **60**.

►View System Event Log

This feature allows the user to view the event in the system event log. Select this item and press <Enter> to view the status of an event in the log. The following categories are displayed:
Date/Time/Error Code/Severity

4.5 IPMI

Use this feature to configure Intelligent Platform Management Interface (IPMI) settings.



When you select this submenu and press the <Enter> key, the following information will display:

- **IPMI Firmware Revision:** This feature indicates the IPMI firmware revision used in your system.
- **Status of BMC:** This feature indicates the status of the BMC (Baseboard Management Controller) installed in your system.
- **BMC Configured Power:** This feature allows to set power control for BMC configuration.
- **Control Policy:** This feature allows to set power control. Default setting is **Power off**.
- **Power Control Policy:** This feature provides support for power control policy. The options are Do not Powerup, Last Power State, Power Restore and **Unspecified**.

▶ System Event Log

Enabling/Disabling Options

SEL Components

Select Enabled to enable all system event logging upon system boot. The options are **Enabled** and Disabled.

Erasing Settings

Erase SEL

Select "Yes, On next reset" to erase all system event logs upon next system boot. Select "Yes, On every reset" to erase all system event logs upon each system reboot. Select "No" to keep all system event logs after each system reboot. The options are "**No**", "Yes, On next reset", and "Yes, On every reset".

When SEL is Full

This feature allows the user to determine what the BIOS should do when the system event log is full. Select Erase Immediately to erase all events in the log when the system event log is full. The options are **Do Nothing** and Erase Immediately.



Note: After you've made a change on a setting below, please be sure to reboot the system for the change to take effect.

► BMC Network Configuration

The following items will be displayed:

- IPMI LAN Selection: This feature displays the IPMI LAN setting. The default setting is **Failover**.
- IPMI Network Link Status: This feature displays the IPMI Network Link status. The default setting is **Dedicated LAN**.
- Station MAC Address: This feature displays the Station MAC address for this computer. Mac addresses are 6 two-digit hexadecimal numbers.
- VLAN: This feature displays the status of VLAN support. The default setting is **Disabled**.
- IPv4 Address Source: This feature displays the source of IPv4 addresses. The default setting is **Static**.
- Station IP Address: This feature displays the Station IP address for this computer. This should be in decimal and in dotted quad form (i.e., 192.168.10.253).
- Subnet Mask: This feature displays the sub-network that this computer belongs to. The value of each three-digit number separated by dots should not exceed 255.
- Gateway IP Address: This feature displays the Gateway IP address for this computer. This should be in decimal and in dotted quad form (i.e., 192.168.10.253).
- IPv6 Address Status: This feature displays the IPv6 address status. The default setting is **Disabled**.

- Station IPv6 Address: This feature displays the station IPv6 address.
- Prefix Length: This item displays the prefix length.
- IPv6 Router IP Address: This feature displays the IPv6 router IP address.

Update IPMI LAN Configuration

Select Yes for the BIOS to implement all IP/MAC address changes upon next system boot. The options are **No** and Yes. If this option is set to Yes, the following items will display:

IPMI LAN Selection (Available when Update IPMI LAN Configuration is set to Yes)

Use this feature to select the type of the IPMI LAN. The options are Dedicated, Shared, and **Failover**.

VLAN

Select Enabled to enable IPMI VLAN function support. The default setting is **Disabled**.

Configuration Address Source

Use this feature to select the IP address source for this computer. If Static is selected, you will need to know the IP address of this computer and enter it to the system manually in the field. If DHCP is selected, AMI BIOS will search for a DHCP (Dynamic Host Configuration Protocol) server attached to the network and request the next available IP address for this computer. The options are **DHCP** and Static.

IPv6 Support: Select Enabled for IPv6 support. The options are Enabled, and **Disabled**. If this option is set to Enabled, the following item will display:

Configuration Address Source: Use this feature to select the IP address source for this computer. If Static is selected, you will need to know the IP address of this computer and enter it to the system manually in the field. If DHCP is selected, AMI BIOS will search for a DHCP (Dynamic Host Configuration Protocol) server attached to the network and request the next available IP address for this computer. The options are **DHCP** and Static

4.6 Security Settings

This menu allows the user to configure the following security settings for the system.



Administrator Password

Use this feature to set the administrator password which is required to enter the BIOS setup utility. The length of the password should be from 3 characters to 20 characters long.

User Password

Use this feature to set the user password which is required to enter the BIOS setup utility. The length of the password should be from 3 characters to 20 characters long.

Password Check

Select Setup for the system to check for a password at Setup. Select Always for the system to check for a password at system boot and upon entering the BIOS Setup utility. The options are **Setup** and **Always**.

▶Secure Boot

When you select this submenu and press the <Enter> key, the following items will display:

- System Mode

Secure Boot

Select Enabled to use Secure Boot settings. The options are Enabled and **Disabled**.

Secure Boot Mode

Use this feature to select the desired secure boot mode for the system. The options are Standard and **Custom**.

CMS Support

If this feature is set to Enabled, legacy devices will be supported by the system. The options are **Enabled** and Disabled.

▶Restore Factory Keys

Select Yes to restore manufacturer default keys used to ensure system security. The options are **Yes** and No.

▶Reset to Setup Mode

Select Yes to reset the system to the Setup Mode. The options are **Yes** and No.

▶Key Management

Vendor Keys

Factory Key Provision

Select Yes to install manufacturer default keys for system security use. The options are Enabled and **Disabled**.

▶Restore Factory Keys

Select Yes to restore all manufacturer default keys for system security use. The options are **Yes** and No.

▶Reset to Setup Mode

This feature resets the system to Setup Mode.

▶Export Secure Boot Variables

This feature is used to copy the NVRAM content of Secure Boot variables to a storage device.

▶Enroll EFI Image

Select this feature and press <Enter> to specify an EFI (Extensible Firmware Interface) image for the system to use when it operates in the Secure Boot mode.

Device Guard Ready

▶Remove 'UEFI CA' from DB

Select Yes to remove UEFI CA from the database. The options are **Yes** and No.

▶Restore DB defaults

Select Yes to restore database variables to the manufacturer default settings. The options are **Yes** and No.

Secure Boot Variable/Size/Keys/Key Source

▶Platform Key (PK)

This feature allows the user to enter and configure a set of values to be used as platform firmware keys for the system. The sizes, keys numbers, and key sources of the platform keys will be indicated as well. Select Update to update the platform key.

▶Key Exchange Keys

This feature allows the user to enter and configure a set of values to be used as Key-Exchange-Keys for the system. The sizes, keys numbers, and key sources of the Key-Exchange-Keys will be indicated as well. Select Update to update your "Key Exchange Keys". Select Append to append your "Key Exchange Keys".

▶Authorized Signatures

This feature allows the user to enter and configure a set of values to be used as Authorized Signatures for the system. These values also indicate the sizes, keys numbers, and the sources of the authorized signatures. Select Update to update your "Authorized Signatures". Select Append to append your "Authorized Signatures". The settings are Details, Export, Update, Append, and Delete.

►Forbidden Signatures

This feature allows the user to enter and configure a set of values to be used as Forbidden Signatures for the system. These values also indicate sizes, keys numbers, and key sources of the forbidden signatures. Select Update to update your "Forbidden Signatures". Select Append to append your "Forbidden Signatures". The settings are Details, Export, Update, Append, and Delete.

►Authorized TimeStamps

This feature allows the user to set and save the timestamps for the authorized signatures which will indicate the time when these signatures are entered into the system. Select Update to update your "Authorized TimeStamps". Select Append to append your "Authorized TimeStamps". The settings are Update, and Append.

►Os Recovery Signatures

This feature allows the user to set and save the authorized signatures used for OS recovery. Select Update to update your "OS Recovery Signatures". Select Append to append your "OS Recovery Signatures". The settings are Update, and Append.

4.7 Boot Settings

Use this feature to configure Boot Settings:

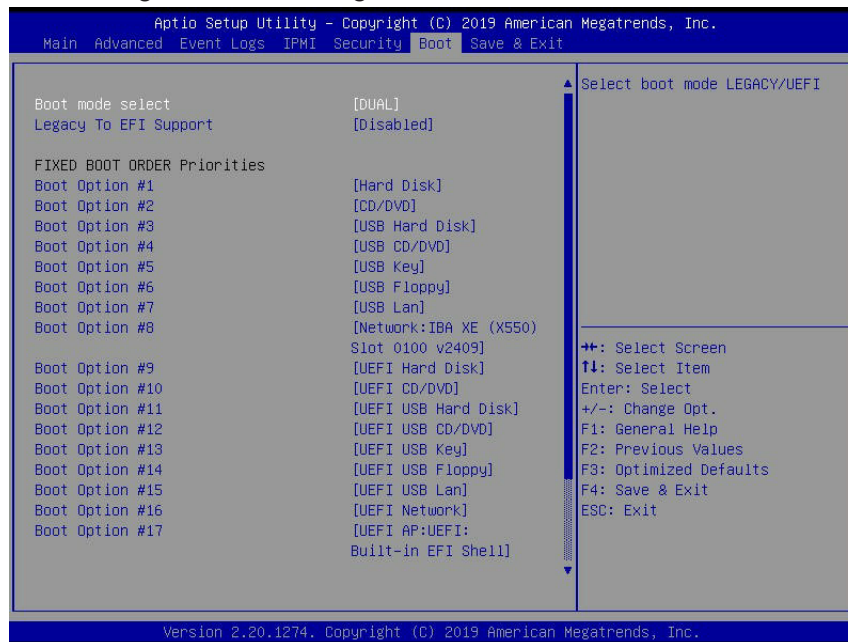

Boot Mode Select

Use this feature to select the type of devices from which the system will boot. The options are Legacy, UEFI (Unified Extensible Firmware Interface), and **Dual**.

Legacy to EFI Support

Select Enabled for the system to boot from an EFI OS when the Legacy OS fails. The options are Enabled and **Disabled**.

Fixed Boot Order Priorities

This feature prioritizes the order of a bootable device from which the system will boot. Press <Enter> on each item sequentially to select devices.

When the item above -"Boot Mode Select" is set to **Dual** (default), the following items will be displayed for user's configuration:

- Boot Option #1 - Boot Option #17

When the item above -"Boot Mode Select" is set to Legacy, the following items will be displayed for configuration:

- Boot Option #1 - Boot Option #8

When the item above -"Boot Mode Select" is set to UEFI, the following items will be displayed for configuration:

- Boot Option #1 - Boot Option #9

Add New Boot Option

This feature allows the user to add a new boot option to the boot priority features for system boot.

Add Boot Option

Use this item to specify the name for the new boot option.

Path for Boot Option

Use this feature to enter the path for the new boot option in the format fsx:\path\filename.efi.

Boot Option File Path

Use this feature to specify the file path for the new boot option.

Create

After the name and the file path for the boot option are set, press <Enter> to create the new boot option in the boot priority list.

► Delete Boot Option

Use this feature to select a boot device to delete from the boot priority list.

Delete Boot Option

Use this feature to remove an EFI boot option from the boot priority list.

► Add New Driver Option

Use this feature to select a new driver to add to the boot priority list.

Add Driver Option

Use this feature to specify the name of the driver to be added to the boot priority list.

Path for Drover Option

Use this feature to specify the path to the driver that will be added to the boot priority list.

Driver Option File Path

Use this feature to specify the file path of the driver that will be added to the boot priority list.

Create

After the driver option name and the file path are set, press <Enter> to enter to submenu and click OK to create the new boot option drive.

▶ Delete Driver Option

Use this item to select a boot driver to delete from the boot priority list.

Delete Drive Option

Select the target boot driver to delete from the boot priority list.

▶ Hard Disk Drive BBS Priorities

- Boot Option #1 - #5

▶ USB Key Drive BBS Priorities

- Boot Option #1

▶ UEFI Application Boot Priorities

- Boot Option #1

▶ Network Drive BBS Priorities

- Boot Option #1

▶ UEFI Application Boot Priorities

- Boot Option #1

4.8 Save & Exit

Select the Save & Exit menu from the BIOS setup screen to configure the settings below.

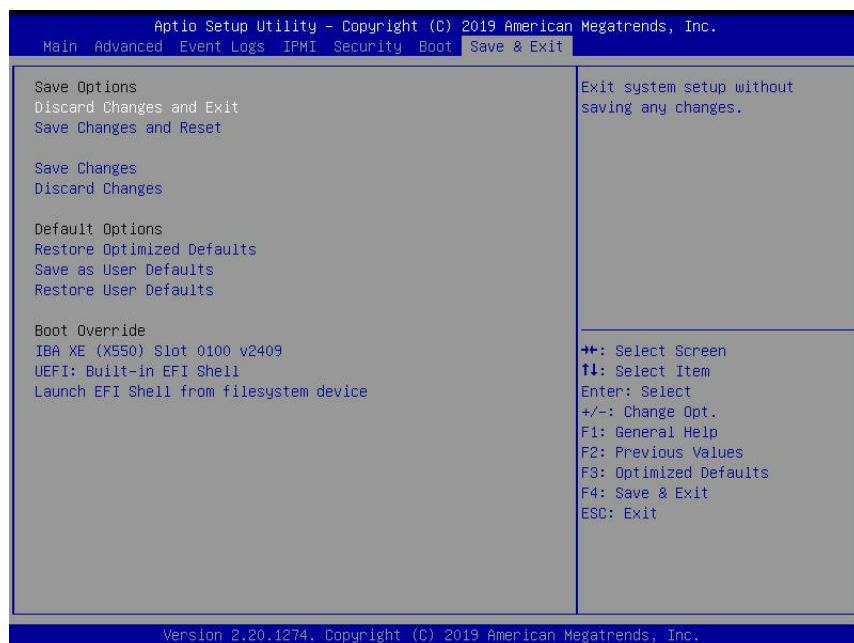

Save Options

Discard Changes and Exit

Select this option to exit from the BIOS setup utility without making any permanent changes to the system configuration and reboot the computer.

Save Changes and Reset

When you have completed the system configuration changes, select this option to leave the BIOS setup utility and reboot the computer for the new system configuration parameters to become effective.

Save Changes

When you have completed the system configuration changes, select this option to save all changes made. This will not reset (reboot) the system.

Discard Changes

Select this option and press <Enter> to discard all the changes you've made and return to the AMI BIOS setup utility.

Default Options

Restore Optimized Defaults

To set this feature, select Restore Defaults from the Exit menu and press <Enter> to load manufacturer default settings which are intended for maximum system performance but not for maximum stability.

Save As User Defaults

To set this feature, select Save as User Defaults from the Exit menu and press <Enter>. This enables the user to save all changes to the BIOS setup for future use.

Restore User Defaults

To set this feature, select Restore User Defaults from the Exit menu and press <Enter>. Use this feature to retrieve user-defined default settings that were saved previously.

Boot Override

This feature allows the user to override the Boot priorities sequence in the Boot menu, and immediately boot the system with a device specified by the user instead of the one specified in the boot list. This is a one-time override.

IBA XE (X550) Slot 0100 v2409

UEFI: Built-in EFI Shell

The Extensible Firmware Interface (EFI) shell is effectively a small operating system built into the system motherboard on modern servers. This provides an environment for troubleshooting and maintenance outside of the operating system.

Launch EFI Shell from file system device

This feature allows to launch EFI (Extensible Firmware Interface) shell from system devices.

Appendix A

BIOS Codes

A.1 BIOS Error POST (Beep) Codes

During the POST (Power-On Self-Test) routines, which are performed each time the system is powered on, errors may occur.

Non-fatal errors are those which, in most cases, allow the system to continue the boot-up process. The error messages normally appear on the screen.

Fatal errors are those which will not allow the system to continue the boot-up procedure. If a fatal error occurs, you should consult with your system manufacturer for possible repairs.

The fatal errors are usually communicated through repeated patterns of audible beeps. Each pattern of audible beeps listed below corresponds to its respective error.

| BIOS Beep (POST) Codes | | |
|------------------------|---------------------------------|--|
| Beep Code | Error Message | Description |
| 1 beep | Refresh | Circuits have been reset (Ready to power up) |
| 5 short, 1 long | Memory error | No memory detected in system |
| 5 long, 2 short | Display memory read/write error | Video adapter missing or with faulty memory |
| 1 long continuous | System OH | System overheat condition |

A.2 Additional BIOS POST Codes

The AMI BIOS supplies additional checkpoint codes, which are documented online at <http://www.supermicro.com/support/manuals/> ("AMI BIOS POST Codes User's Guide").

When BIOS performs the Power On Self Test, it writes checkpoint codes to I/O port 0080h. If the computer cannot complete the boot process, a diagnostic card can be attached to the computer to read I/O port 0080h (Supermicro p/n AOC-LPC80-20).

For information on AMI updates, please refer to <http://www.ami.com/products/>.

Appendix B

Software

After the hardware has been installed, you can install the Operating System (OS), configure RAID settings and install the drivers.

B.1 Microsoft Windows OS Installation

If you will be using RAID, you must configure RAID settings before installing the Windows OS and the RAID driver. Refer to the RAID Configuration User Guides posted on our website at www.supernmicro.com/support/manuals.

Installing the OS

1. Create a method to access the MS Windows installation ISO file. That might be a DVD, perhaps using an external USB/SATA DVD drive, or a USB flash drive, or the IPMI KVM console.
2. Retrieve the proper RST/RSTe driver. Go to the Supermicro web page for your motherboard and click on "Download the Latest Drivers and Utilities", select the proper driver, and copy it to a USB flash drive.
3. Boot from a bootable device with Windows OS installation. You can see a bootable device list by pressing **F11** during the system startup.

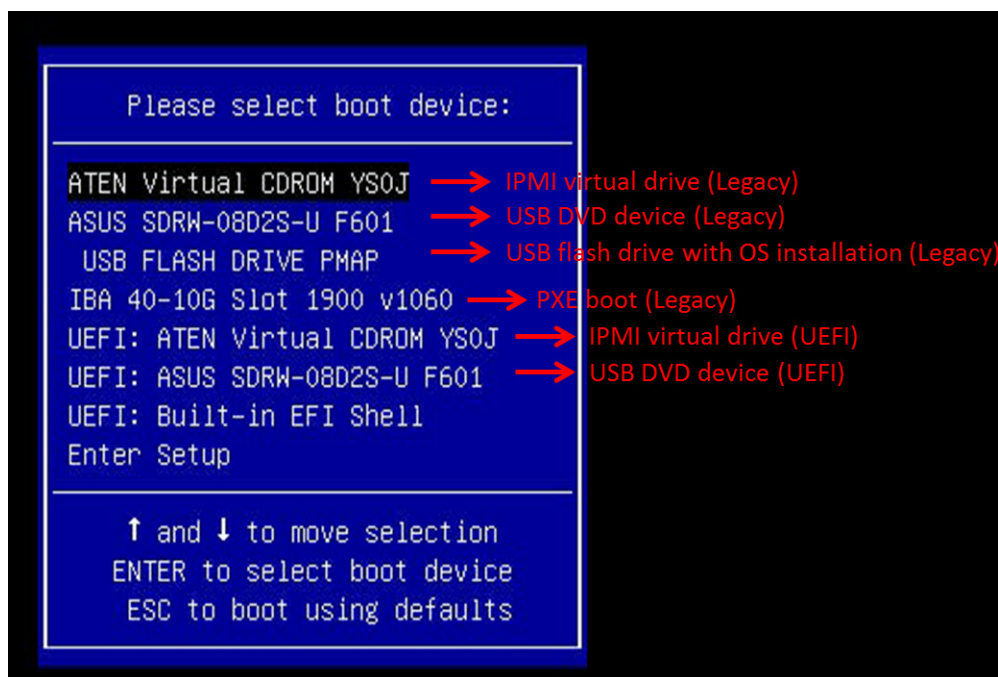

Figure B-1. Select Boot Device

4. During Windows Setup, continue to the dialog where you select the drives on which to install Windows. If the disk you want to use is not listed, click on “Load driver” link at the bottom left corner.

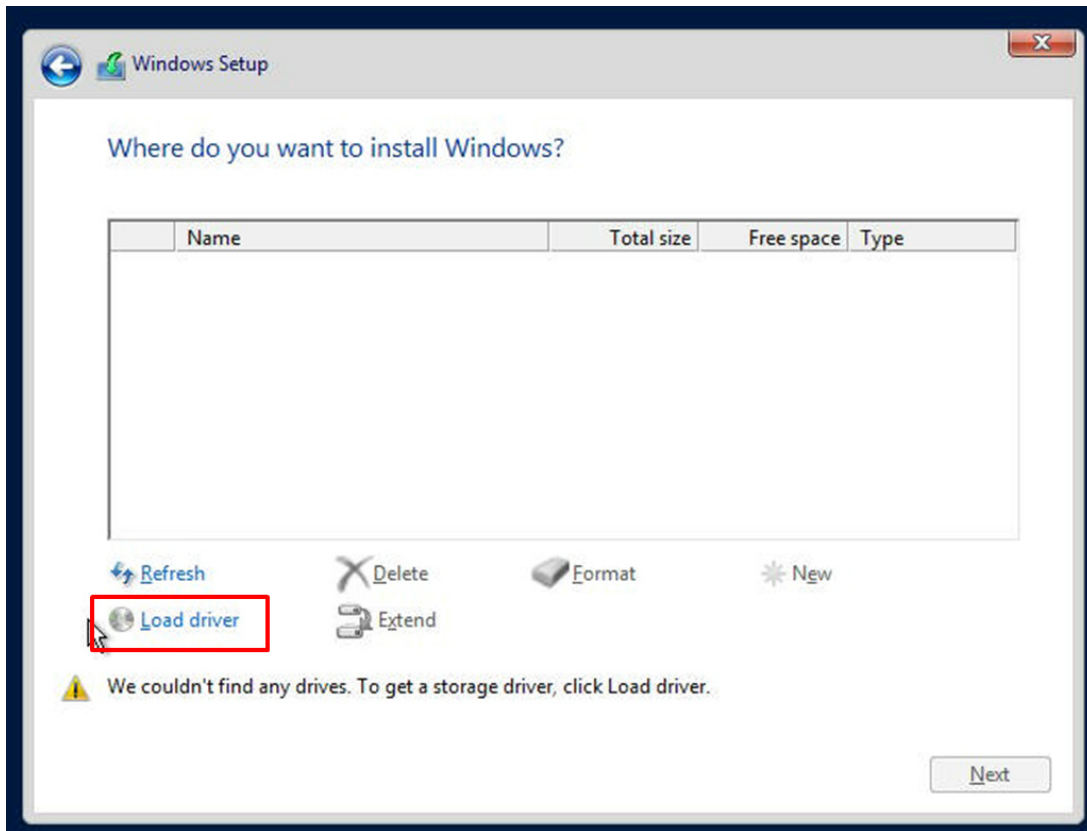

Figure B-2. Load Driver Link

To load the driver, browse the USB flash drive for the proper driver files.

- For RAID, choose the SATA/sSATA RAID driver indicated then choose the storage drive on which you want to install it.
 - For non-RAID, choose the SATA/sSATA AHCI driver indicated then choose the storage drive on which you want to install it.
5. Once all devices are specified, continue with the installation.
 6. After the Windows OS installation has completed, the system will automatically reboot multiple times.

B.2 Driver Installation

The Supermicro website contains drivers and utilities for your system at <https://www.supermicro.com/wftp/driver>. Some of these must be installed, such as the chipset driver.

After accessing the website, go into the CDR_Images (in the parent directory of the above link) and locate the ISO file for your motherboard. Download this file to a USB flash drive or a DVD. (You may also use a utility to extract the ISO file if preferred.)

Another option is to go to the Supermicro website at <http://www.supermicro.com/products/>. Find the product page for your motherboard, and "Download the Latest Drivers and Utilities".

Insert the flash drive or disk and the screenshot shown below should appear.

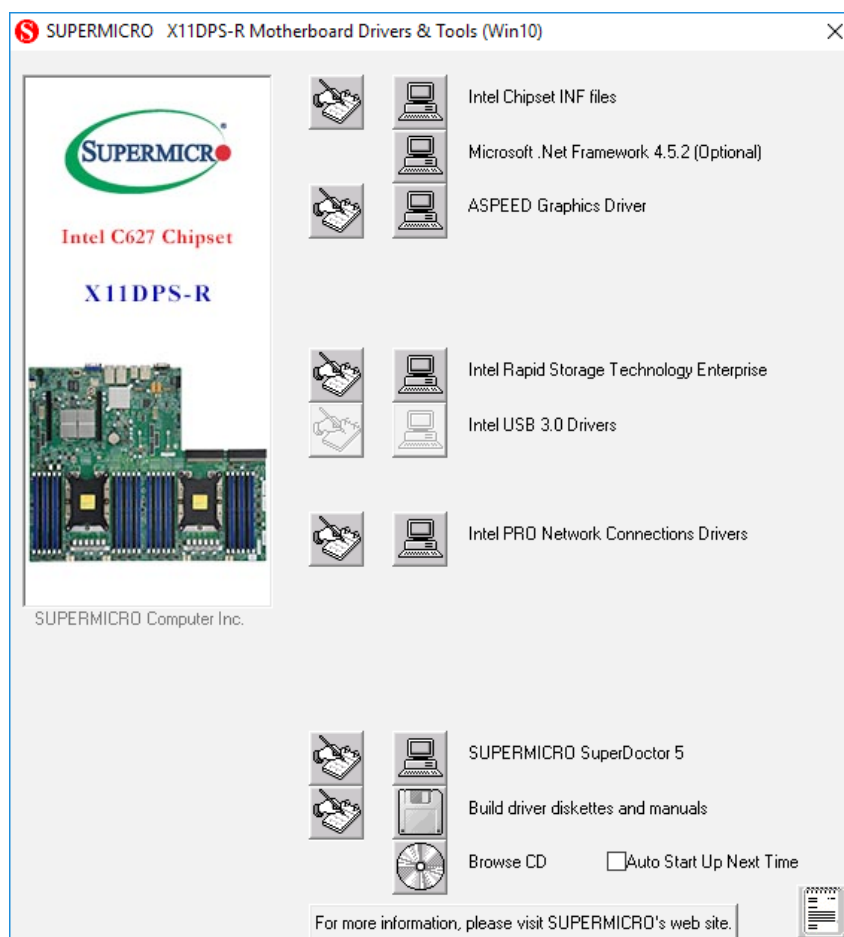

Figure B-3. Driver & Tool Installation Screen

Note: Click the icons showing a hand writing on paper to view the readme files for each item. Click the computer icons to the right of these items to install each item (from top to the bottom) one at a time. **After installing each item, you must re-boot the system before moving on to the next item on the list.** The bottom icon with a CD on it allows you to view the entire contents.

B.3 SuperDoctor® 5

The Supermicro SuperDoctor 5 is a program that functions in a command-line or web-based interface for Windows and Linux operating systems. The program monitors such system health information as CPU temperature, system voltages, system power consumption, fan speed, and provides alerts via email or Simple Network Management Protocol (SNMP).

SuperDoctor 5 comes in local and remote management versions and can be used with Nagios to maximize your system monitoring needs. With SuperDoctor 5 Management Server (SSM Server), you can remotely control power on/off and reset chassis intrusion for multiple systems with SuperDoctor 5 or IPMI. SuperDoctor 5 Management Server monitors HTTP, FTP, and SMTP services to optimize the efficiency of your operation.

Note: The default User Name and Password for SuperDoctor 5 is ADMIN / ADMIN.

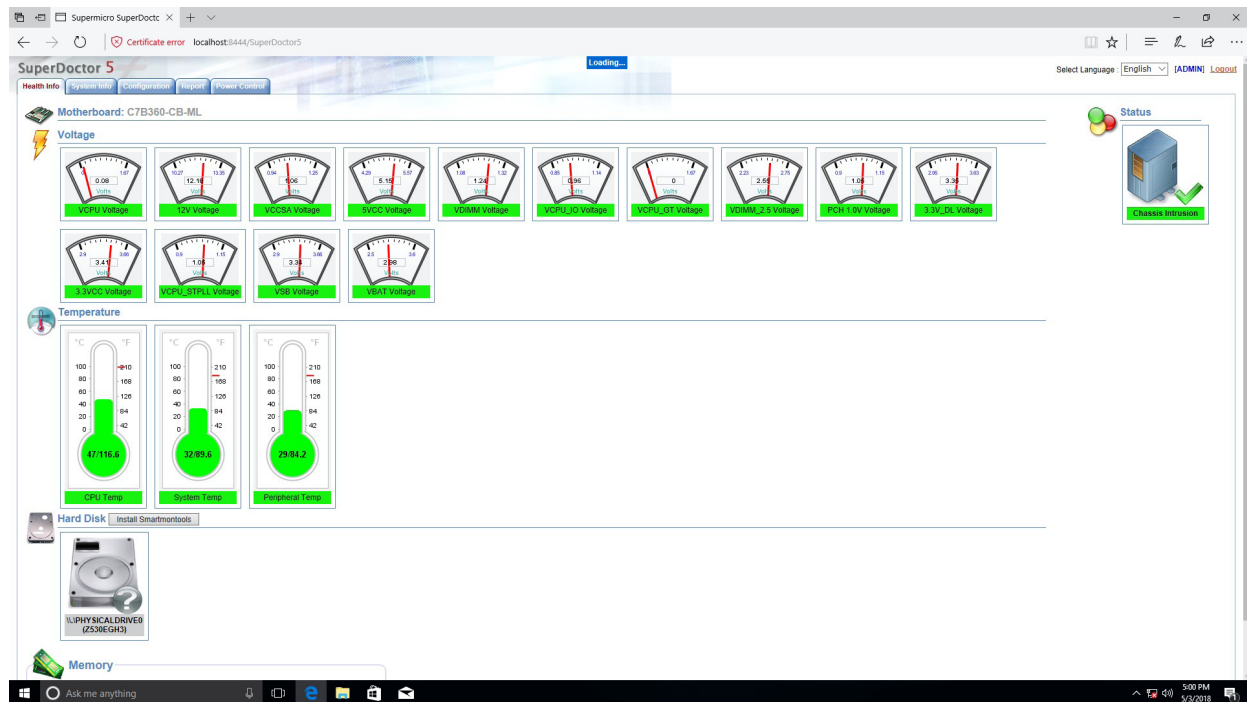

Figure B-4. SuperDoctor 5 Interface Display Screen (Health Information)

B.4 IPMI

The [motherboard models] supports the Intelligent Platform Management Interface (IPMI). IPMI is used to provide remote access, monitoring and management. There are several BIOS settings that are related to IPMI.

For general documentation and information on IPMI, please visit our website at: <http://www.supermicro.com/products/nfo/IPMI.cfm>.

B.5 Logging into the BMC (Baseboard Management Controller)

Supermicro ships standard products with a unique password for the BMC user. This password can be found on a label on the motherboard.

When logging in to the BMC for the first time, please use the unique password provided by Supermicro to log in. You can change the unique password to a user name and password of your choice for subsequent logins.

For more information regarding BMC passwords, please visit our website at <http://www.supermicro.com/bmcpassword>.

Appendix C

Standardized Warning Statements

The following statements are industry standard warnings, provided to warn the user of situations which have the potential for bodily injury. Should you have questions or experience difficulty, contact Supermicro's Technical Support department for assistance. Only certified technicians should attempt to install or configure components.

Read this section in its entirety before installing or configuring components.

These warnings may also be found on our website at http://www.supermicro.com/about/policies/safety_information.cfm.

Battery Handling



Warning! There is the danger of explosion if the battery is replaced incorrectly. Replace the battery only with the same or equivalent type recommended by the manufacturer. Dispose of used batteries according to the manufacturer's instructions

電池の取り扱い

電池交換が正しく行われなかった場合、破裂の危険性があります。交換する電池はメーカーが推奨する型、または同等のものを使用下さい。使用済電池は製造元の指示に従って処分して下さい。

警告

電池更換不當會有爆炸危險。請只使用同類電池或製造商推薦的功能相當的電池更換原有電池。請按製造商的說明處理廢舊電池。

警告

電池更換不當會有爆炸危險。請使用製造商建議之相同或功能相當的電池更換原有電池。請按照製造商的說明指示處理廢棄舊電池。

Warnung

Bei Einsetzen einer falschen Batterie besteht Explosionsgefahr. Ersetzen Sie die Batterie nur durch den gleichen oder vom Hersteller empfohlenen Batterietyp. Entsorgen Sie die benutzten Batterien nach den Anweisungen des Herstellers.

Attention

Danger d'explosion si la pile n'est pas remplacée correctement. Ne la remplacer que par une pile de type semblable ou équivalent, recommandée par le fabricant. Jeter les piles usagées conformément aux instructions du fabricant.

¡Advertencia!

Existe peligro de explosión si la batería se reemplaza de manera incorrecta. Reemplazar la batería exclusivamente con el mismo tipo o el equivalente recomendado por el fabricante. Desechar las baterías gastadas según las instrucciones del fabricante.

אזהרה!

קיימת סכנת פיצוץ של הסוללה במידה והוחלפה בדרך לא תקינה. יש להחליף את הסוללה בסוג התואם מחברת יצרן מומלצת. סילוק הסוללות המשומשות יש לבצע לפי הוראות היצרן.

هناك خطر من انفجار في حالة اسبدال البطارية بطريقة غير صحيحة فعلي
اسبدال البطارية فقط بنفس النع أو ما يعادلها مما أوصت به الشركة المصنعة
جخلص من البطاريات المسعملة وفقا لعمليات الشركة الصانعة

경고!

배터리가 올바르게 교체되지 않으면 폭발의 위험이 있습니다. 기존 배터리와 동일하거나 제조사에서 권장하는 동등한 종류의 배터리로만 교체해야 합니다. 제조사의 안내에 따라 사용된 배터리를 처리하여 주십시오.

Waarschuwing

Er is ontploffingsgevaar indien de batterij verkeerd vervangen wordt. Vervang de batterij slechts met hetzelfde of een equivalent type die door de fabrikant aanbevolen wordt. Gebruikte batterijen dienen overeenkomstig fabrieksvoorschriften afgevoerd te worden.

Product Disposal



Warning! Ultimate disposal of this product should be handled according to all national laws and regulations.

製品の廃棄

この製品を廃棄処分する場合、国の関係する全ての法律・条例に従い処理する必要があります。

警告

本产品的废弃处理应根据所有国家的法律和规章进行。

警告

本產品的廢棄處理應根據所有國家的法律和規章進行。

Warnung

Die Entsorgung dieses Produkts sollte gemäß allen Bestimmungen und Gesetzen des Landes erfolgen.

¡Advertencia!

Al deshacerse por completo de este producto debe seguir todas las leyes y reglamentos nacionales.

Attention

La mise au rebut ou le recyclage de ce produit sont généralement soumis à des lois et/ou directives de respect de l'environnement. Renseignez-vous auprès de l'organisme compétent.

סילוק המוצר

אזהרה!

סילוק סופי של מוצר זה חייב להיות בהתאם להנחיות וחוקי המדינה.

عند التخلص النهائي من هذا المنتج ينبغي التعامل معه وفقا لجميع القوانين واللوائح الوطنية

경고!

이 제품은 해당 국가의 관련 법규 및 규정에 따라 폐기되어야 합니다.

Waarschuwing

De uiteindelijke verwijdering van dit product dient te geschieden in overeenstemming met alle nationale wetten en reglementen.

Appendix D

UEFI BIOS Recovery

Warning: Do not upgrade the BIOS unless your system has a BIOS-related issue. Flashing the wrong BIOS can cause irreparable damage to the system. In no event shall Supermicro be liable for direct, indirect, special, incidental, or consequential damages arising from a BIOS update. If you need to update the BIOS, do not shut down or reset the system while the BIOS is updating to avoid possible boot failure.

D.1 Overview

The Unified Extensible Firmware Interface (UEFI) provides a software-based interface between the operating system and the platform firmware in the pre-boot environment. The UEFI specification supports an architecture-independent mechanism that will allow the UEFI OS loader stored in an external storage device to boot the system. The UEFI offers clean, hands-off management to a computer during system boot.

D.2 Recovering the UEFI BIOS Image

A UEFI BIOS flash chip consists of a recovery BIOS block and a main BIOS block (a main BIOS image). The recovery block contains critical BIOS codes, including memory detection and recovery codes for the user to flash a healthy BIOS image if the original main BIOS image is corrupted. When the system power is turned on, the recovery block codes execute first. Once this process is complete, the main BIOS code will continue with system initialization and the remaining POST (Power-On Self-Test) routines.



Note 1: Follow the BIOS recovery instructions in Section D.3 for BIOS recovery when the main BIOS block crashes.

Note 2: If the recovery instructions in Section D.3 for BIOS recovery fail, you may use the Supermicro Update Manager (SUM) Out-of-Band (OOB) (https://www.supermicro.com.tw/products/nfo/SMS_SUM.cfm) to reflash the BIOS.

Note 3: If the recovery block processes stated in Note 1 and Note 2 above fail, you will need to follow the procedures to make a Returned Merchandise Authorization (RMA) request. Refer to Section 3.5 for more information about the RMA request.

D.3 Recovering the Main BIOS Block with a USB Device

This feature allows the user to recover the main BIOS image using a USB-attached device without additional utilities used. A USB flash device such as a USB Flash Drive, or a USB CD/DVD ROM/RW device can be used for this purpose. However, a USB hard disk drive cannot be used for BIOS recovery at this time. The file system supported by the recovery block is FAT (including FAT12, FAT16, and FAT32) which is installed on a bootable or non-bootable USB-attached device.

To perform UEFI BIOS recovery using a USB-attached device, follow the instructions below.

1. Please use a different machine to download the BIOS package for your motherboard or your system from the product page available on our website at www.supermicro.com.
2. Extract the BIOS package to a USB device and rename the BIOS ROM file [BIOSname#.###] that is included in the BIOS package to SUPER.ROM for BIOS recovery use.
3. Copy the SUPER.ROM file into the Root "\\" directory of the USB device.

 **Note:** Before recovering the main BIOS image, confirm that the SUPER.ROM file you have is the same version or a close version meant for your motherboard.

4. Insert the USB device that contains the SUPER.ROM file into the system before you power on the system or when the following screen appears.



- After locating the SUPER.ROM file, the system will enter the BIOS Recovery menu as shown below.

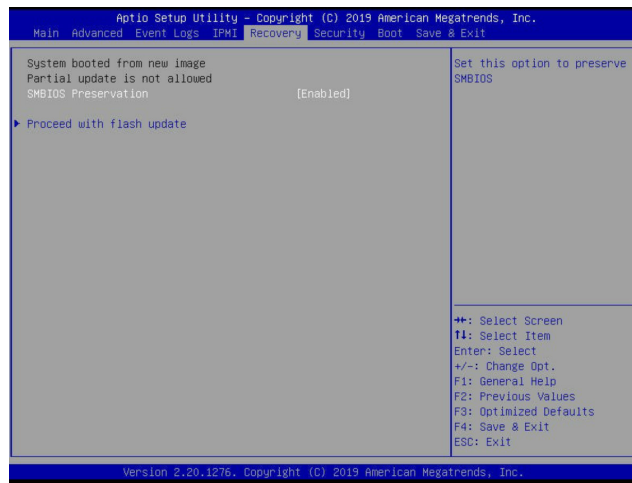

Note: At this point, you may decide if you want to start the BIOS recovery. If you decide to proceed with BIOS recovery, follow the procedures below.

- When the screen as shown above displays, use the arrow keys to select the item "Proceed with flash update" and press the <Enter> key. You will see the BIOS recovery progress as shown in the screen below.

Note: Do not interrupt the BIOS flashing process until it is complete.

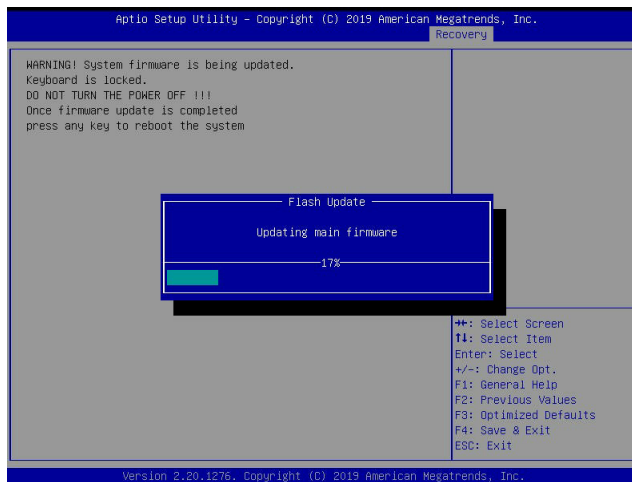

7. After the BIOS recovery process is complete, press any key to reboot the system.

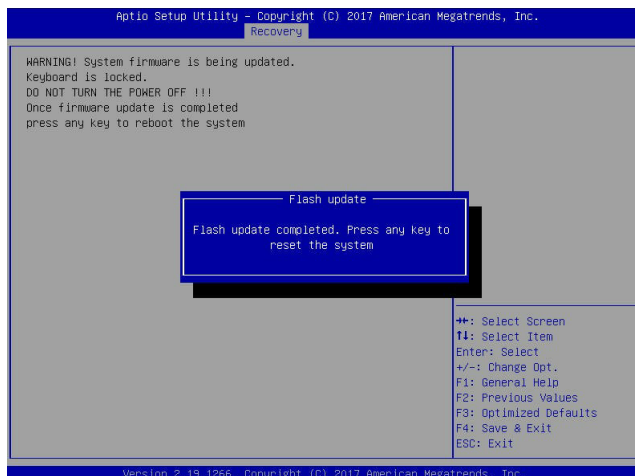

 **Note:** It is recommended that you update your BIOS after BIOS recovery. Please refer to Chapter 3 for BIOS update instructions.

8. Press during system boot to enter the BIOS Setup utility. From the top of the tool bar, select Boot to enter the submenu. From the submenu list, select Boot Option #1 as shown below. Then, set Boot Option #1 to [UEFI AP:UEFI: Built-in EFI Shell]. Press <F4> to save the settings and exit the BIOS Setup utility.

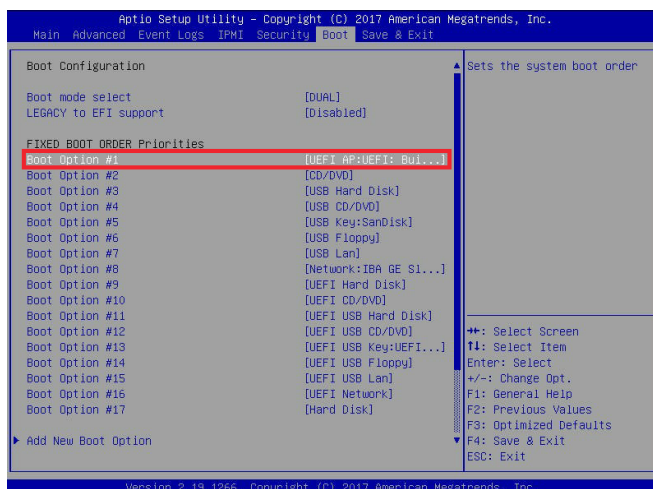

- When the UEFI Shell prompt appears, type `fs#` to change the device directory path. Go to the directory that contains the BIOS package you extracted earlier from Step 1. Enter `flash.nsh BIOSname#.###` at the prompt to start the BIOS update process.

```

UEFI Interactive Shell v2.1
EDK II
UEFI v2.50 (American Megatrends, 0x0005000C)
Mapping table
  FS0: Alias(s):HD0F0B:BLK1:
        PciRoot(0x0)/Pci(0x14,0x0)/USB(0x11,0x0)/HD(1,MBR,0x379101D2,0x800,0x1
DR9592)
  BLK0: Alias(s):
        PciRoot(0x0)/Pci(0x14,0x0)/USB(0x11,0x0)
Press F8 in 1 seconds to skip startup.nsh or any other key to continue.
Shell> fs0:
FS0:\> cd \AFUDOS
FS0:\AFUDOS> cd SNIJPE2_03162017
FS0:\AFUDOS\SNIJPE2_03162017> flash.nsh X11DP17_314
    
```



Note: Do not interrupt this process until the BIOS flashing is complete.

```

Done.
[ Access Cmos Port Ex ]
<Read>
Index 0x51: 0x10

Done.
*****
* Program BIOS and ME (including FDT) regions...
*****
| AMT Firmware Update Utility v5.09.01.1917 |
| Copyright (C)2017 American Megatrends Inc. All Rights Reserved. |
-----
CPUID = 50652

Reading flash ..... done
- ME Data Size checking - ok
- FFS checksums ..... ok
- Check RomLayout ..... Ok
Erasing Boot Block ..... done
Updating Boot Block ..... done
Verifying Boot Block ..... done
Erasing Main Block ..... 0x00132000 (0x)
    
```

- The screen above indicates that the BIOS update process has completed. Reboot the system when you see the screen below.

```

Verifying NDB Block ..... done
- Update success for FDR
- Update success for IE
- Successful Update Recovery Loader to OPRx11
- Successful Update MFSB11
- Successful Update FPR11
- Successful Update MFS, IVB1 and IVB211
- Successful Update FLOG and UTDK11
- ME Entire Image update success !!
WARNING : System must power-off to have the changes take effect !!
Moving FS0:\AFUDOS\SNIJPE2_03162017\fdt\k64.efi -> FS0:\AFUDOS\SNIJPE2_03162017\
d1.smc
- [ok]
Moving FS0:\AFUDOS\SNIJPE2_03162017\afuef1k64.efi -> FS0:\AFUDOS\SNIJPE2_0316201
7\afuef1.smc
- [ok]
*****
* Please ignore this 'Shell: Cannot read from file - Device Error'
* warning message due to it does not impact flashing process.
*****
Deleting "afuef1.smc"
Delete successful.
FS0:\>
    
```

Appendix E

Configuring VROC RAID Settings

Intel® Virtual RAID on CPU (Intel® VROC) is a RAID (Redundant Array of Independent Disks) solution that integrates with Intel® Volume Management Device (Intel® VMD) for Non-Volatile Memory Express (NVMe) solid-state drives (SSDs). The E.1 section provides instructions on how to access the All Intel VMD Controller menu. The E.2 section provides instructions on how to configure RAID settings. The E.3 section describes the use of journaling drive for the RAID5 volume (parity based RAID).

 **Note 1:** Only use NVMe devices that have been validated by Supermicro. For the latest updates, please contact us or refer to our website at <https://www.supermicro.com>.

Note 2: Depending on the version of driver/utility/package, it may or may not have exactly the same as the BIOS settings/features shown in the appendix.

E.1 All Intel VMD Controllers Menu

The following section provide you with instructions on how to access the **All Intel VMD Controllers menu** which will allow you to enable a selected PCI slot for VMD support.

Enabling a PCI Slot for VMD Support in the BIOS Setup Utility

1. Press during system boot to enter the BIOS Setup utility.
2. Use the arrow key to select **Advanced** on top of the BIOS menu bar.
3. Use the down arrow key to select **Chip Configuration** and press <Enter>.
4. Select **North Bridge** and press <Enter>.
5. Use the down arrow key to select **IIO Configuration** and press <Enter>.

6. When the following screen displays, use the down arrow key to select **Intel® VMD Technology** and press <Enter> to enter the Intel® VMD Technology submenu.

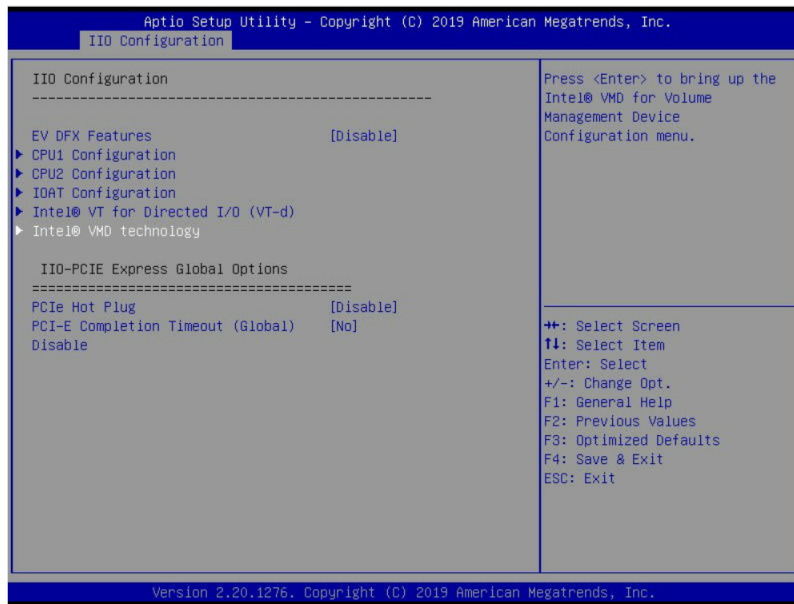

7. When the Intel® VMD Technology submenu appears, it will display all the PCI slots that can be configured for VMD support on the screen.
8. From the available PCI slots displayed on the screen, select a PCI slot you want to use for a VMD device by highlighting it.
9. Select the option [Enable] and press <Enter> to enable the selected slot for VMD support.
10. Repeat Step 8 ~ Step 9 to select and enable all the PCI slots of your choice for VMD support.
11. After enabling all PCI slots for VMD support on the BIOS Setup utility, install the VMD devices (such as add-on cards) on the slots that you've configured for VMD support on the motherboard. For the changes to take effect,
12. Press <F4> to save the settings and exit the BIOS Setup utility. Press during system boot to enter the BIOS Setup utility.



Note: After you've enabled VMD in the BIOS on a PCIe slot of your choice, this PCIe slot will be dedicated for VMD use only, and it will no longer support any PCIe device. To re-activate this slot for PCIe use, please disable VMD in the BIOS.

13. Navigate to the Advanced tab.

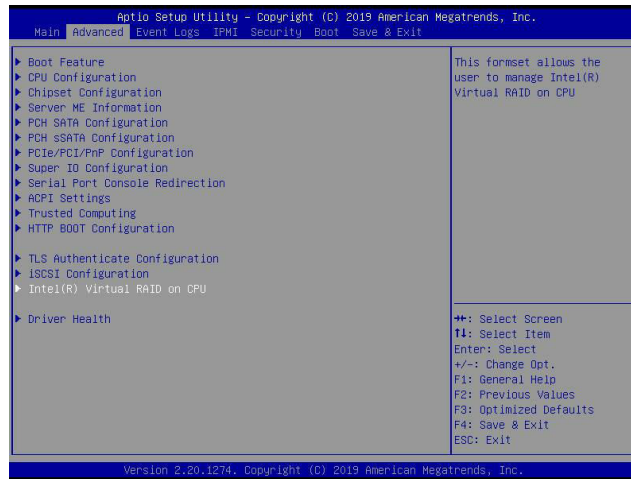

14. Use the arrow keys to select Intel(R) Virtual RAID on CPU and press <Enter> to access the menu items. The following screen will appear showing that the feature "All Intel VMD Controllers" has become available.

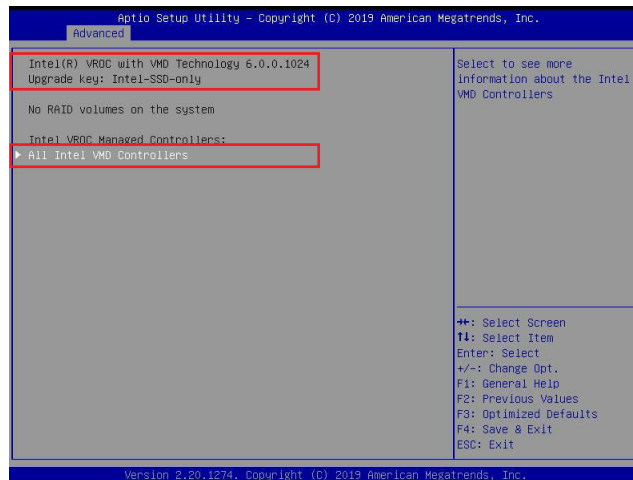

Note 1: The license and header (on the motherboard) for Intel® VROC hardware key are required. Also, be sure the version of Intel® Rapid Storage Technology enterprise (Intel® RSTe) VROC utility is 5 or above (look for Intel(R) VROC with VMD Technology x.x.x.xxxx shown on the screen).

Note 2: Intel® VROC Premium hardware key is used in the appendix to demonstrate RAID settings.

15. Use the arrow keys to select **All Intel VMD Controllers** and press <Enter> to access the menu items. The following screen will appear. It allows the user to create RAID volumes and configure settings of NVMe devices as detected by the system.

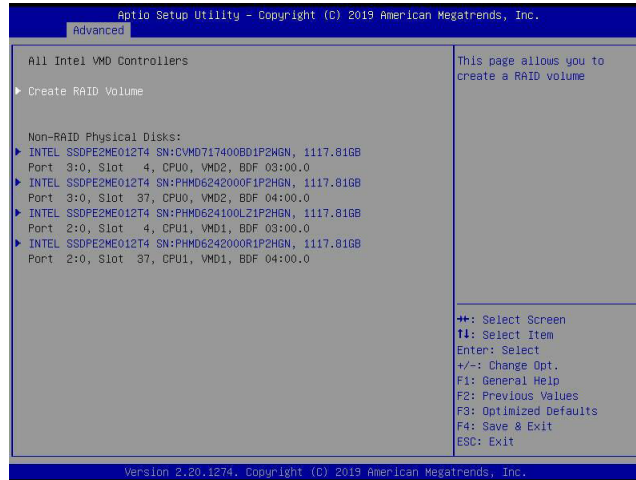

Note : A single Intel® VMD supported processor supplies 48 PCIe lanes and contains three Intel® VMD controllers (domains). Refer to the following illustration for more information.

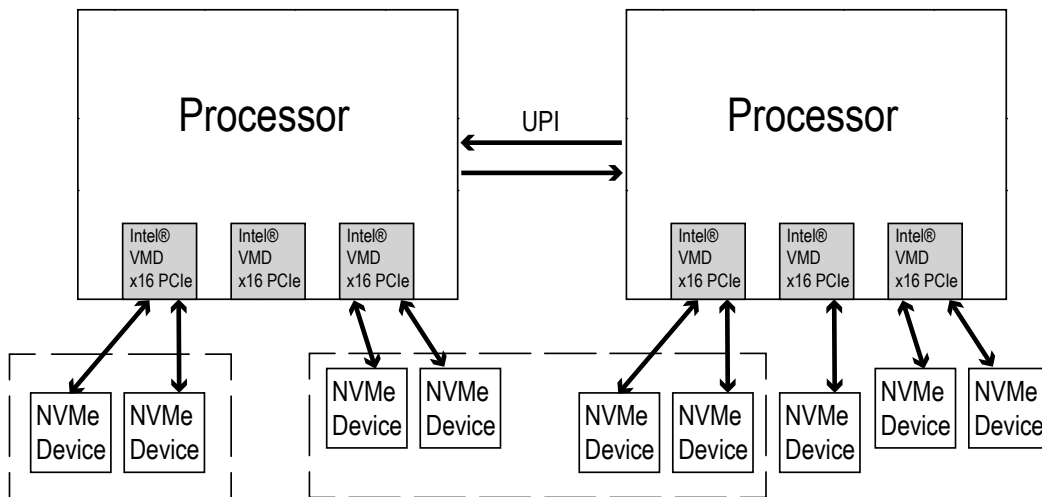

* Boot RAID will NOT be able to cross VMDs.

* Data RAID will be allowed to cross VMDs and processors.

E.2 Configuring RAID Settings

Follow the instructions stated in the E.1 section to access the **All Intel VMD Controllers** menu items, the following screen will appear. Please carefully follow the instructions listed in this section to configure RAID settings for your devices as desired.

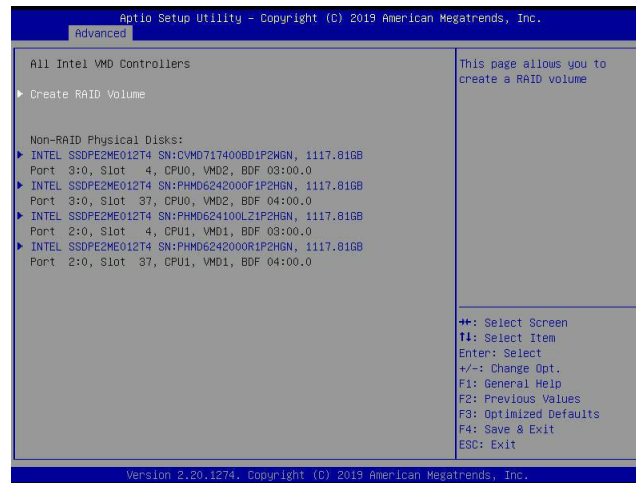

To Create a RAID Volume

Use the arrow keys to select **Create RAID Volume** from the screen above and press <Enter> to create a RAID Volume. The Create RAID Volume submenu, which allows you to configure the settings of the RAID volume you've created, will appear as shown below.

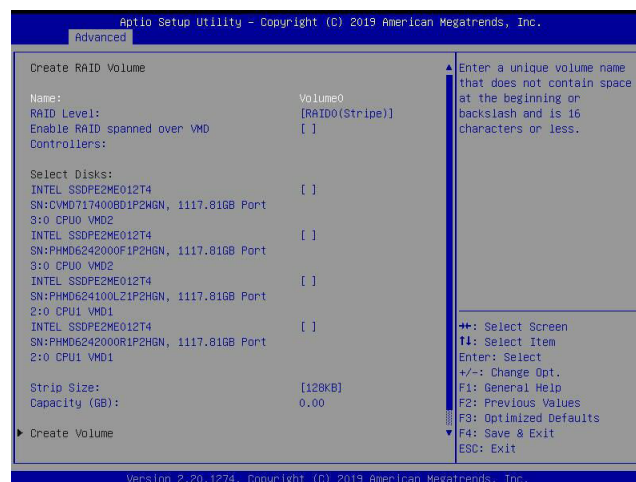

To Enter a Name for the RAID Volume

From the **Create RAID Volume** submenu as shown on the previous screen, use the arrow keys to select **Name** and press <Enter>, and the following screen will display.

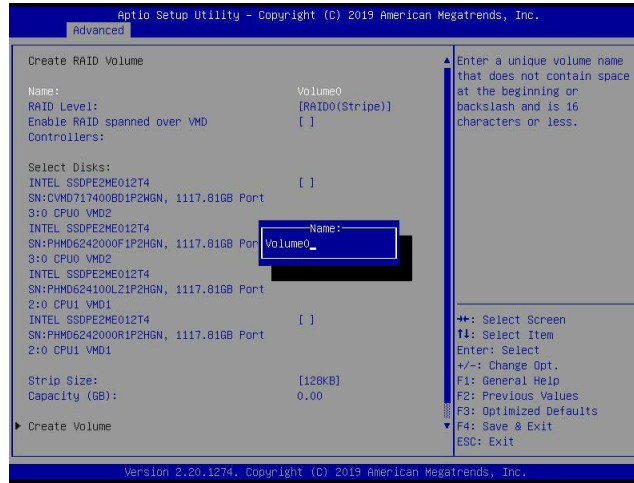

When the screen above displays, enter a unique name for the RAID volume.

To Set the RAID Level for the RAID Volume

From the **Create RAID Volume** submenu, select **RAID Level** and press <Enter>. The following screen will display.

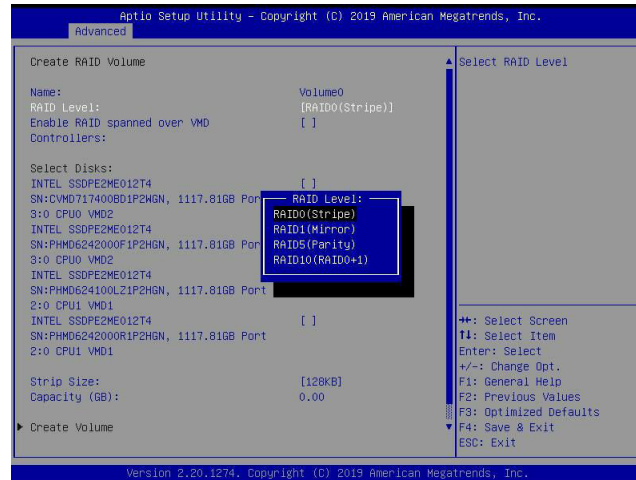

Use the arrow keys to select the desired RAID level for the RAID volume that you've created. The options are **RAID0(Stripe)**, **RAID1(Mirror)**, **RAID5(Parity)**, and **RAID10(RAID0+1)**.

 **Note 1:** The RAID level(s) displayed is(are) based on the number of NVMe devices connected to the system.

Note 2: For RAID0/RAID1/RAID5/RAID10, the minimum number of NVMe devices required is two/two/three/four respectively.

Note 3: Use Intel® VROC Standard hardware key to support RAID 0/1/10. Use Intel® VROC Premium hardware key (or Intel SSD Only hardware key) to support RAID 0/1/5/10.

Enabling RAID Spanned over VMD Controllers

From the **Create RAID Volume** submenu, use the arrow keys to select **Enter RAID spanned over VMD Controllers** and press <Enter>. The following screen will display.

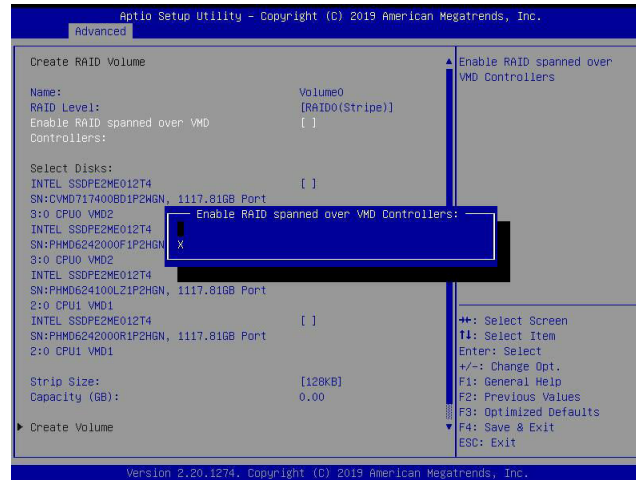

Enter a desired setting for your RAID volume in the pop-up menu. The options are **(not selected)** and X (selected). Please set this feature to X if the RAID level you selected earlier from Step 3 will cross VMD domains.



Note: For a bootable RAID volume, do not cross VMD domains.

To Select Disks for the RAID Volumes

From the **Create RAID Volume** submenu, use the arrow keys to highlight **Select Disk:** and press <Enter>. The following screen will display.

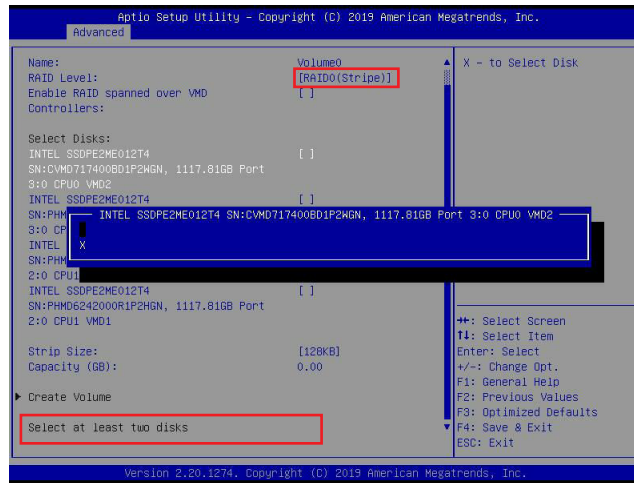

The options are **(not selected)** and X (selected). Set the features one by one to X to select the desired RAID disks for your RAID volumes.

To Set Strip Size for the RAID Volume

From the **Create RAID Volume** submenu, use the arrow keys to select **Strip Size:** and press <Enter>. The following screen will display.

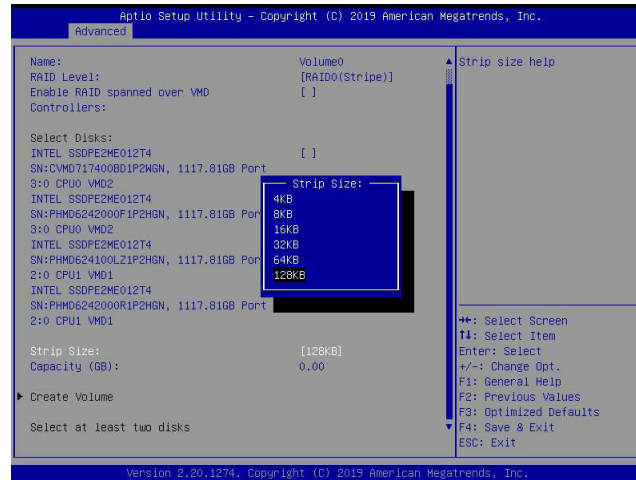

From the pop-up menu as shown above, select the desired RAID strip size for your RAID volume and press <Enter>. The options are 4KB, 8KB, 16KB, 32KB, 64KB, and **128KB**.

 **Note:** For RAID5, the options are 4KB, 8KB, 16KB, 32KB, **64KB**, and 128KB. For RAID10, the options are 4KB, 8KB, 16KB, 32KB, and **64KB**.

To Set the Capacity (GB) for the RAID Volume

From the **Create RAID Volume** submenu, use the arrow keys to select **Capacity (GB):** and press <Enter>. The following screen will display.

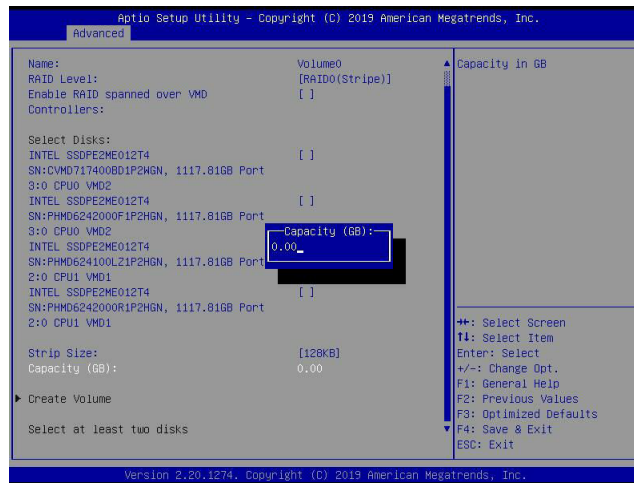

Enter the desired RAID capacity (in GB) in the pop-up menu to set the capacity for your RAID volume.

To Create Volumes

To finalize your RAID volume configuration, select **Create Volume** from the **Create RAID Volume** submenu as shown on the screen below.

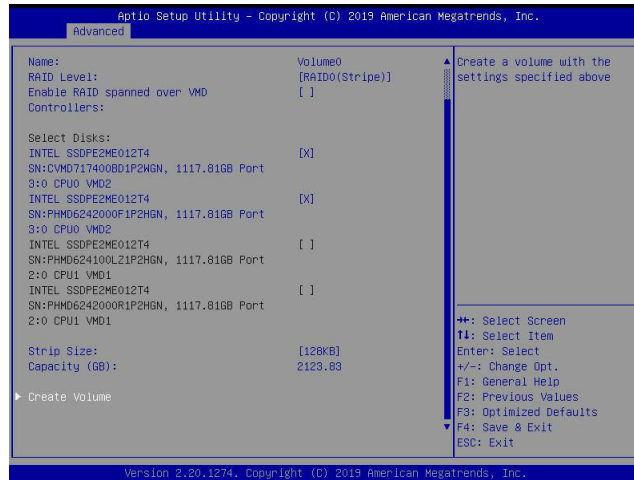

After selecting **Create Volume**, press <Enter>. The following screen will appear and display RAID volumes as shown below.

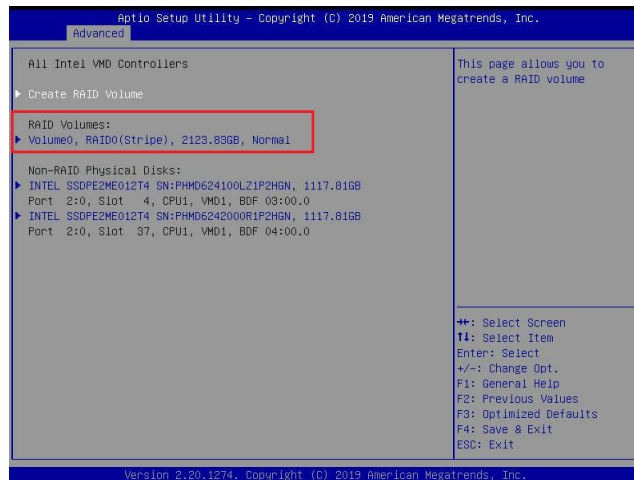

To Display RAID Volumes

For detailed RAID volume information, use the arrow keys to select the desired RAID volume as shown below.

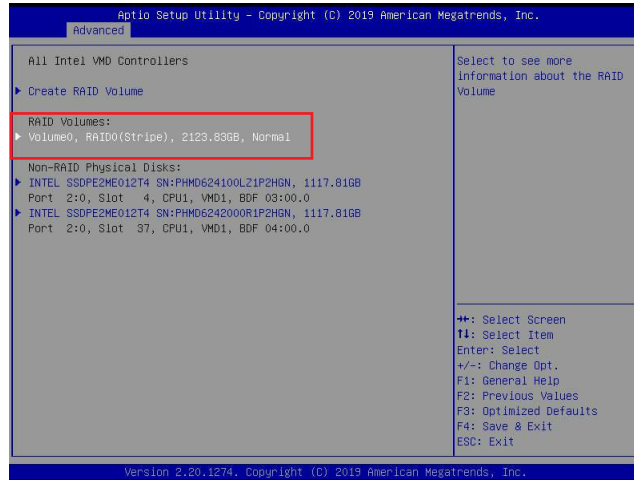

To Display RAID VOLUME Information

When the screen above appears, press <Enter>. The **RAID VOLUME INFO** menu will appear and display the detailed information about the RAID volume you've selected as shown below.

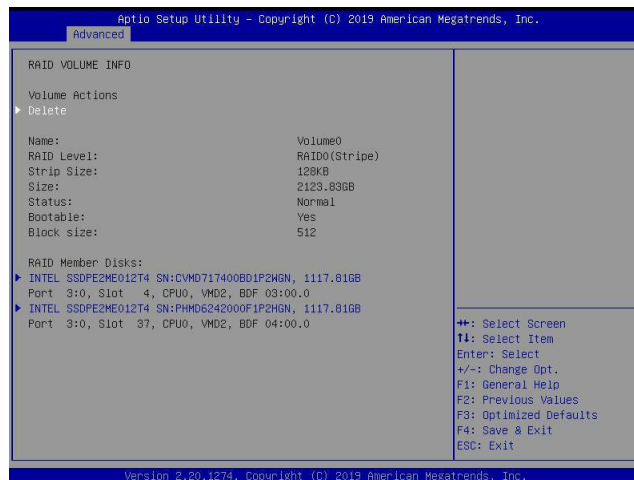

To Delete a RAID Volume

On the **RAID VOLUME INFO** menu, use the arrow keys to select Delete and press <Enter> to delete the RAID volume you have selected.



The following screen will appear to confirm if you want to delete the RAID Volume. Select Yes to delete the RAID Volume. The options are **Yes** and No.



To Reset the RAID Volume to non-RAID

On the **RAID VOLUME INFO** submenu shown on the bottom screen of page 169, select the desired NVMe device from the list of RAID Member Disks and press <Enter> as shown below.

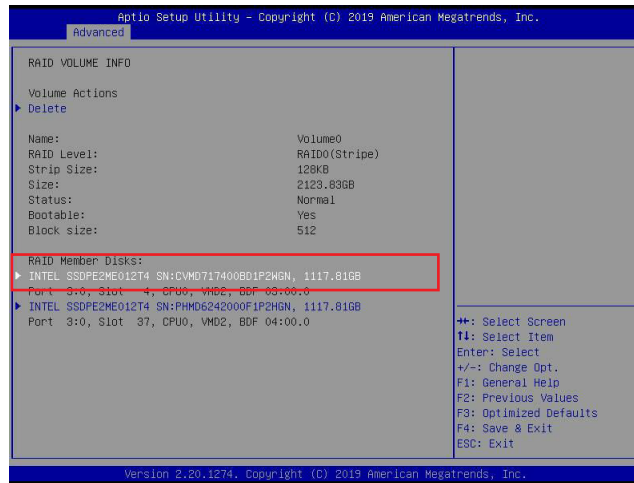

Select **Reset to Non-RAID** from the screen below and press <Enter> to remove RAID data from the selected NVMe device.

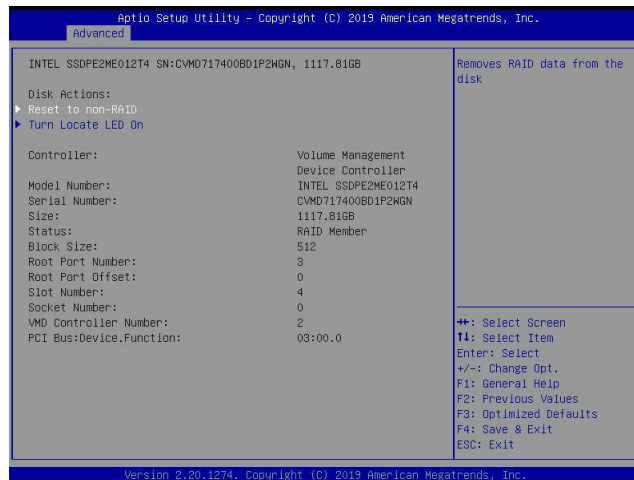

When the following screen appears, select **Yes** to confirm that you want to set the selected NVMe device to non-RAID. The options are **Yes** and **No**.

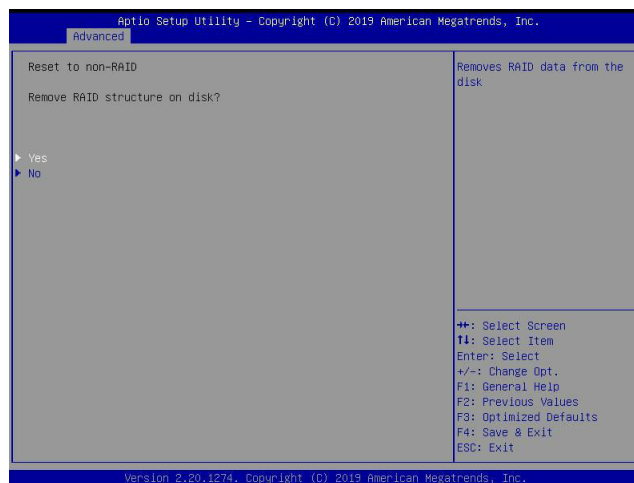

To Turn on the Disk Locator LED

Follow the instructions stated in the E.1 section to access the **All Intel VMD Controllers** menu. When the following screen displays, select a non-RAID physical disk to turn on the disk locator LED to locate a selected device.

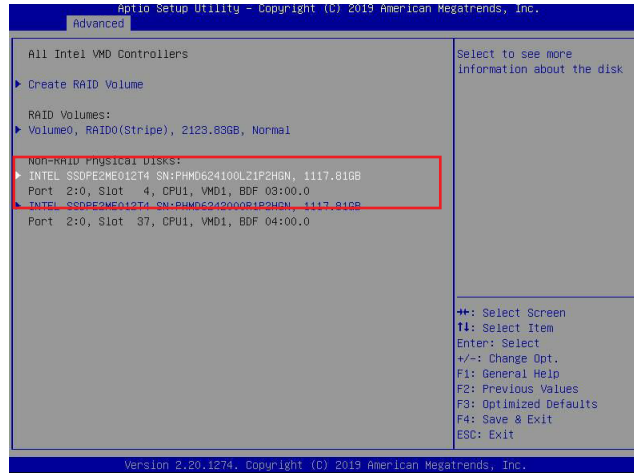

You can also select a RAID member disk to locate the selected device.

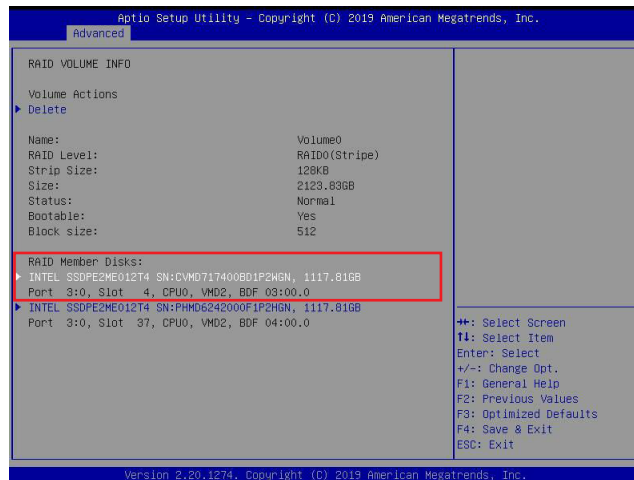

When the following screen appears, use the arrow keys to select **Turn Locate LED On**. Press <Enter> to turn on the locator LED to show the location of the selected device.

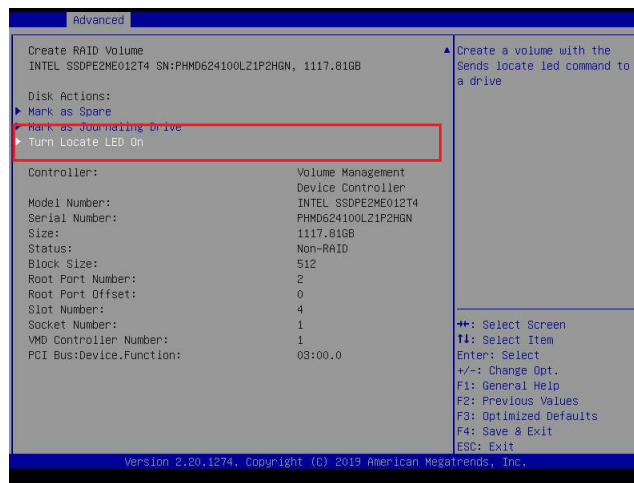

To Mark a RAID Volume as Spare

Follow the instructions stated in the E.1 section to access the **All Intel VMD Controllers** menu. When the following screen appears, select a desired NVMe device from the list of Non-RAID Physical Disks.

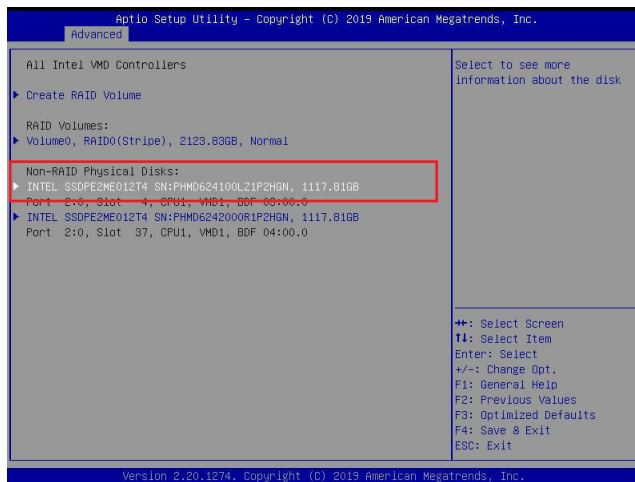

After a NVMe device is selected, press <Enter> and the following screen will appear. Select **Mark as Spare** and press <Enter> to mark the selected device as a spare device.

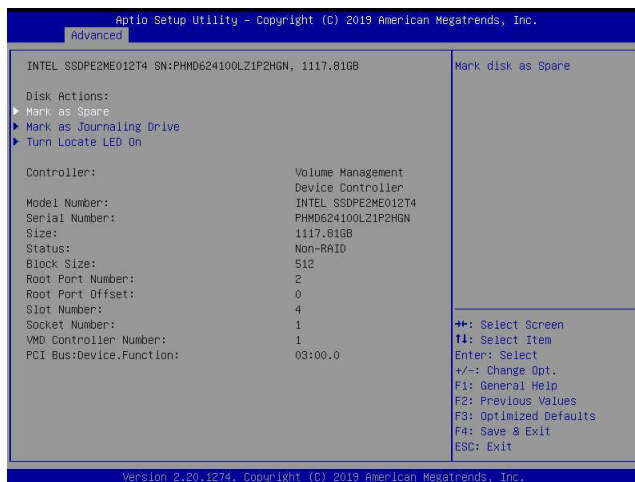

When the following screen appears, select Yes to confirm that you want the selected device to be used as a spare device. The options are **Yes** and No.



 **Note:** A spare disk is used for automatic RAID volume rebuilds when status of failed, missing, or at risk is detected on the array disk. For a RAID0 volume, only status of at risk will trigger automatic RAID volume rebuilds.

To Mark a RAID Volume as a Journaling Drive

Refer to the instructions stated in the E.1 section to access the All Intel VMD Controllers menu. When the following screen appears, select a desired NVMe device from the list of Non-RAID Physical Disks for use as a journaling drive.

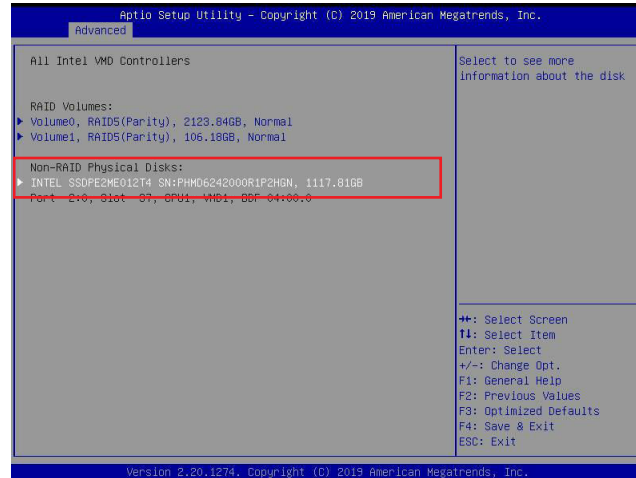

After selecting a NVMe device, press <Enter> and the following screen will appear. Select **Mark as Journaling Drive** and press <Enter>.

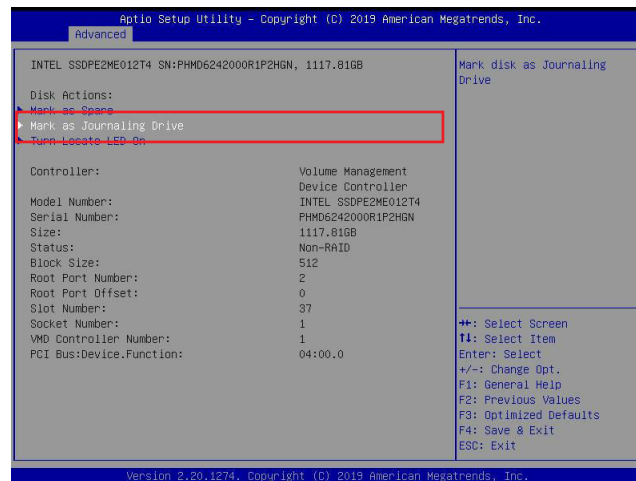

When the following screen appears, select Yes to confirm that the selected device is to be used as a journaling drive. The options are **Yes** and No.



Note: RAID Write Hole (RWH) is a condition associated with a power/drive-failure/crash while writing to a RAID5 volume. The use of journaling drive that contains partial parity logging (PPL) can reduce the potential data loss. Refer to the following illustration for the use of journaling drive.

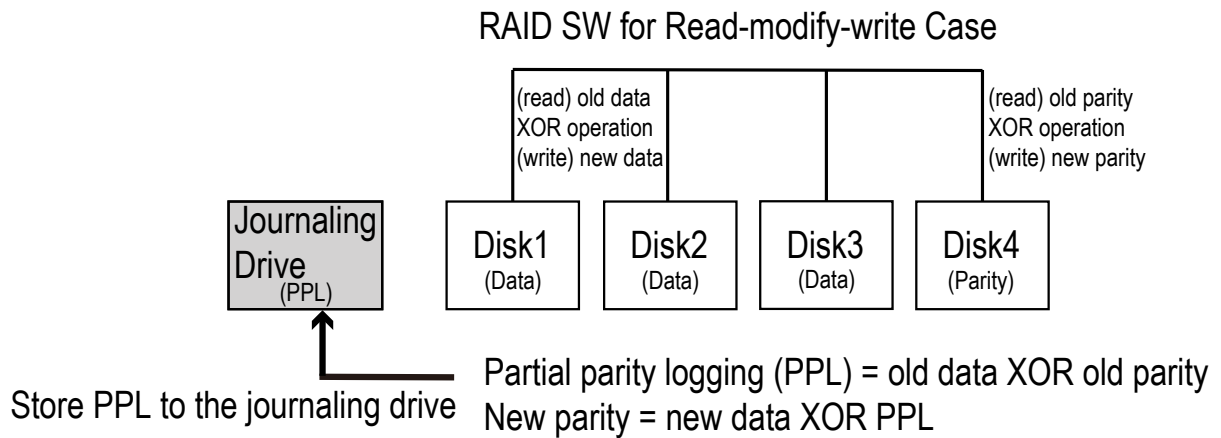

E.3 Use of Journaling Drive

The following section describes the use of a journaling drive for the RAID5 volume, which is a parity-based RAID.

Step 1. Refer to the instructions stated in the E.1 section to access All Intel VMD Controllers menu items. When the following screen appears, use the arrow keys to select the desired RAID5 volume.

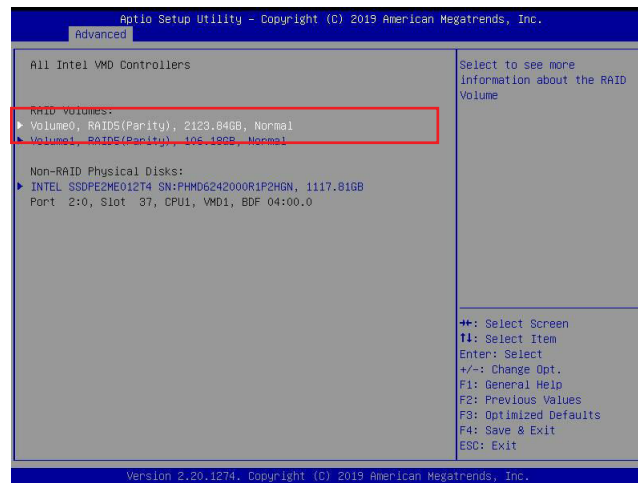

Press <Enter> and the following screen will appear.

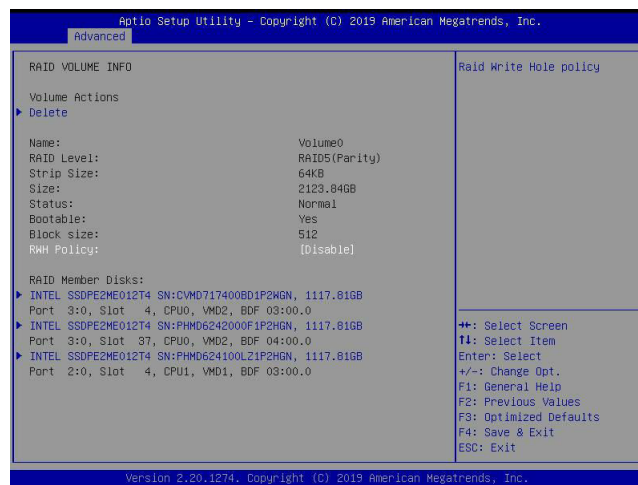

Step 2. Use the arrow keys to select RWH Policy. RWH is a scenario related to a power/drive-failure/crash.

RWH Policy

Press <Enter> and the following screen will appear. If any device has been set as a journaling drive (see pages 175 and 170), the options are Distributed PPL, Journaling Drive, and Disable.

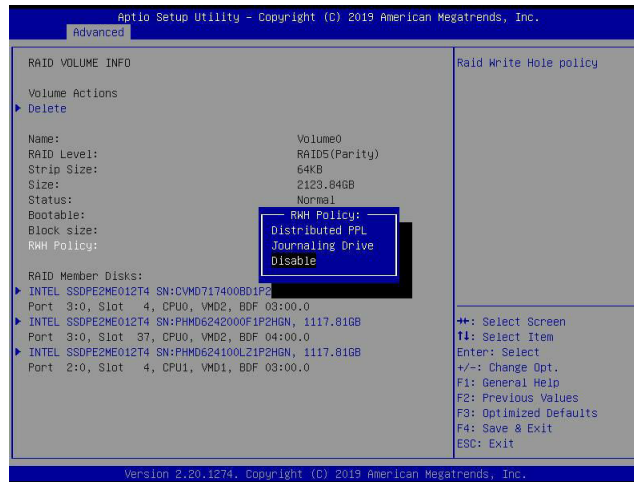

If no device has been set as a journaling drive, the options are Distributed PPL and **Disable**.

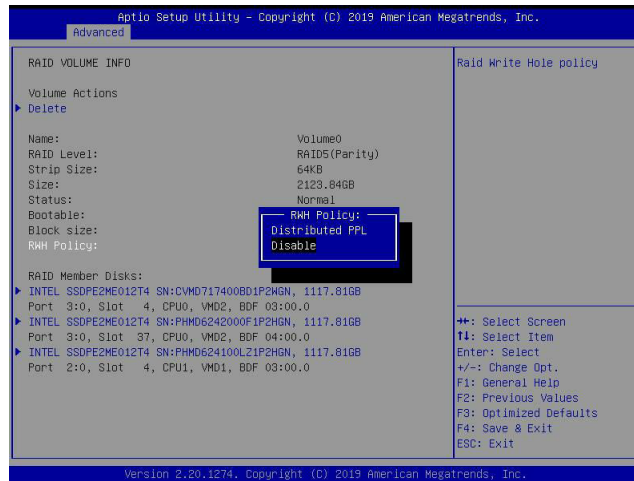

Note 1: Partial parity logging (PPL) can be defined as the result of XOR calculation of old data and old parity. PPL is a feature available for RAID5 volumes. While a power/drive-failure/crash occurring, PPL information helps rebuild the RAID volume and reduce the potential data loss.

Note 2: For the RWH condition, the Intel® RSTe 5.X or above RWH closure algorithm provides the option of use of an additional NVMe device for RAID volume rebuilds (Journaling Drive RWH closure mode). Without the use of an additional NVMe device, PPL distributed RWH closure mode can be utilized to close the RWH by using the parity drive for example.

Step 3. Set the feature, RWH Policy, to **Journaling Drive**.

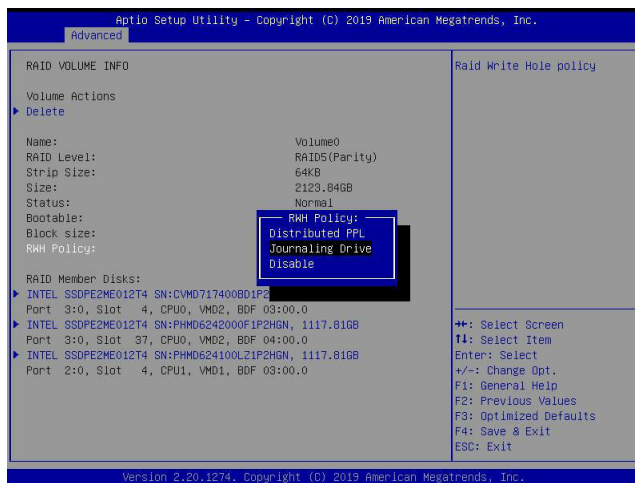

Press <Enter> and the RWH JD feature will become available as shown below.

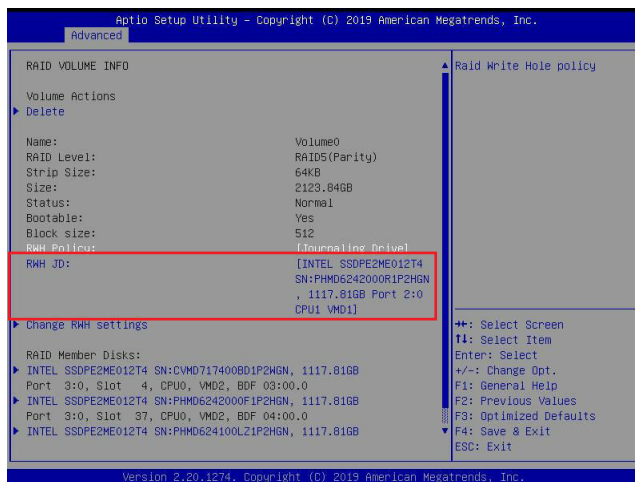

RWH JD

Use the arrow keys to select RWH JD. Press <Enter> and the following screen will appear. The feature displays the information of journaling drive(s).

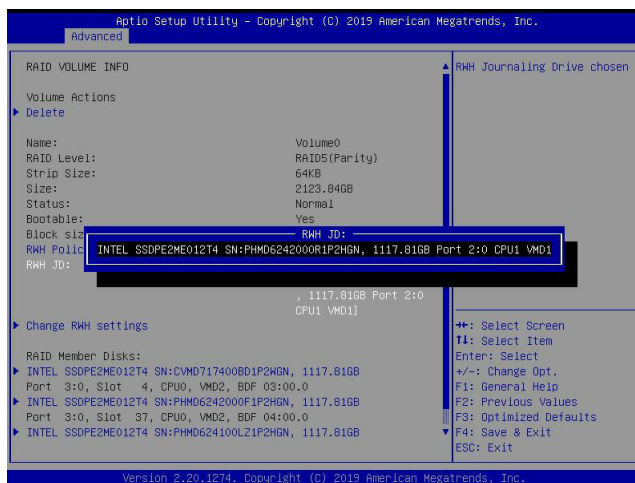

Step 4. Use the arrow keys and press <Enter> to select the desired journaling drive from the option list of RWH JD.

Step 5. For the changes to take effect, use the arrow keys to select Change RWH settings and press <Enter>.

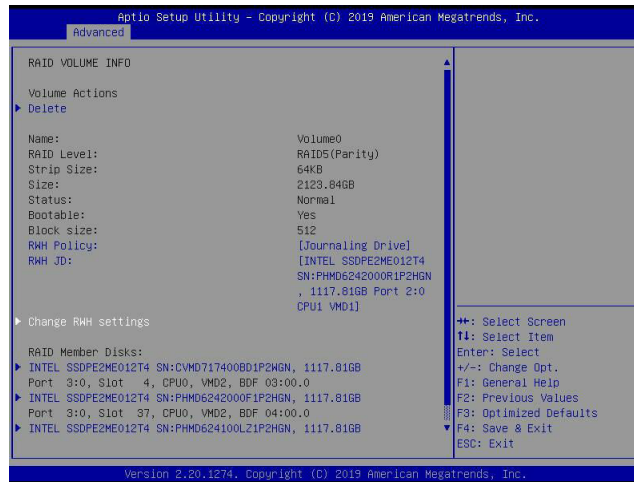

Your computer will return to the main screen of All Intel VMD Controllers as shown below.

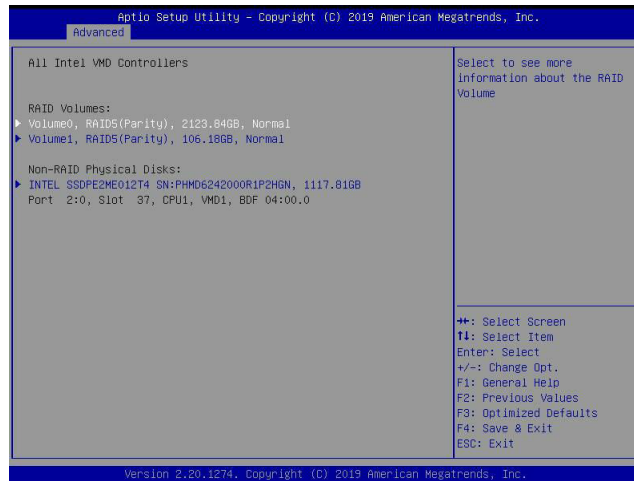

Appendix F

Secure Boot Settings

Secure boot is a feature of UEFI (Unified Extensible Firmware Interface) that ensures boot loaders are digitally signed and validated. The F.1, F.2, and F.3 sections provide instructions on how to enable the secure boot features. The F.4 section states Key Management settings.

F.1 Boot mode select Feature

Press during system boot to enter the BIOS Setup utility. Navigate to the Boot tab. Use the arrow keys to select Boot mode select and press <Enter>. The options are LEGACY, UEFI, and **DUAL**. Set Boot mode select to UEFI. For the changes to take effect, press <F4> to save the settings and exit the BIOS Setup utility.

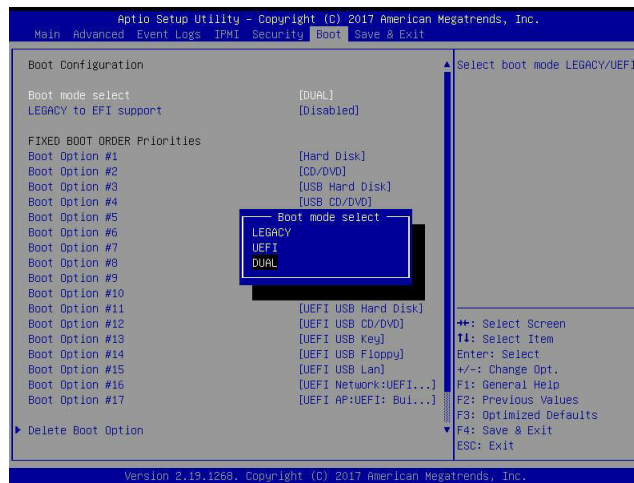

F.2 Secure Boot/ Secure Boot Mode/ CSM Support Features

Press during system boot to enter the BIOS Setup utility. Navigate to the Security tab as shown below.

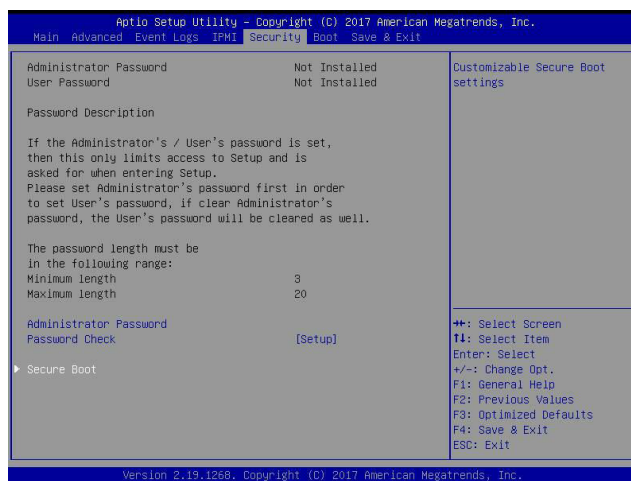

Use the arrow keys to select Secure Boot and press <Enter> to access the menu items. The following screen will appear.



Secure Boot

This feature is available when the platform key (PK) is pre-registered where the platform operates in the User mode and compatibility support module (CSM) support is disabled in the BIOS Setup utility. Select Enabled for secure boot flow control. The options are **Disabled** and Enabled.

Secure Boot Mode

Use this feature to set the secure boot mode. The options are Standard and **Custom**. Select Standard to load manufacturer's default secure variables. Select Custom to change the image execution policy and to manage secure boot keys.

CSM Support

Select Enabled to support the legacy CSM, which provides compatibility support for traditional legacy BIOS for system boot. The options are Disabled and **Enabled**.

F.3 Secure Boot Settings

To have the secure boot support, be sure to follow the steps below (Step 1 ~ Step 4).

Step 1. Set Secure Boot Mode to Standard. Press Yes to install factory default keys as needed.

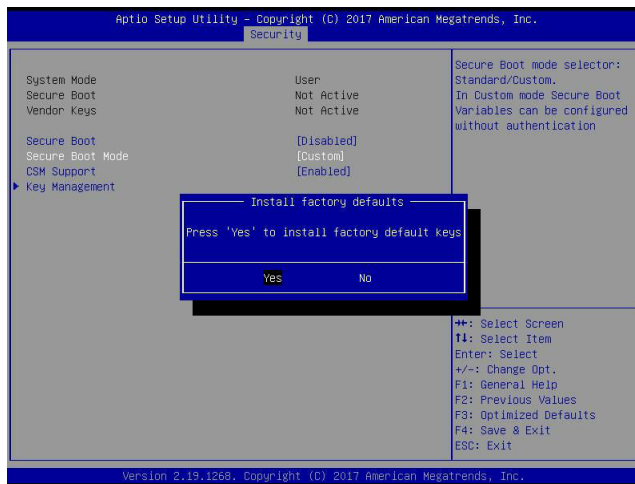
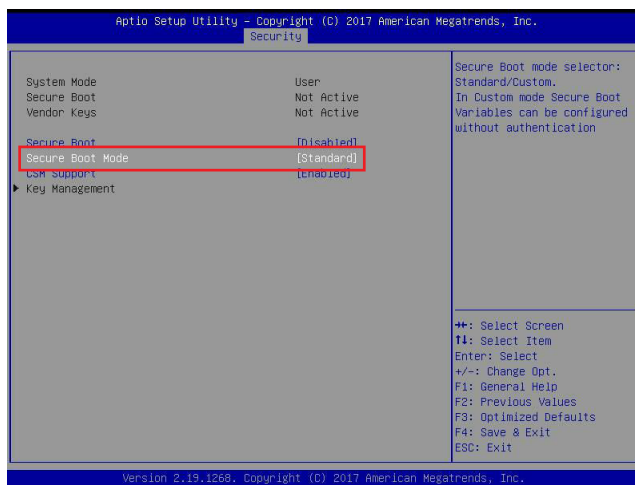

 **Note:** The Key Management menu will become unavailable when Secure Boot Mode is set to Standard.

Step 2. For the changes to take effect, press <F4> to save the settings and exit the BIOS Setup utility.

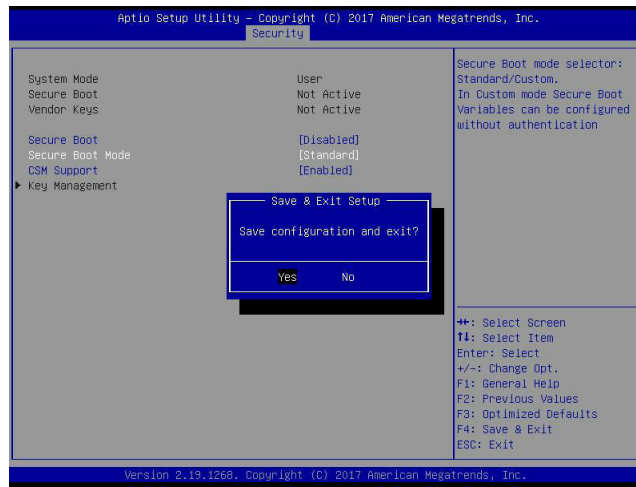

Step 3. Press during system boot to enter the BIOS Setup utility. Navigate to the Security tab and enter the Secure Boot menu. Set CSM Support to Disabled.

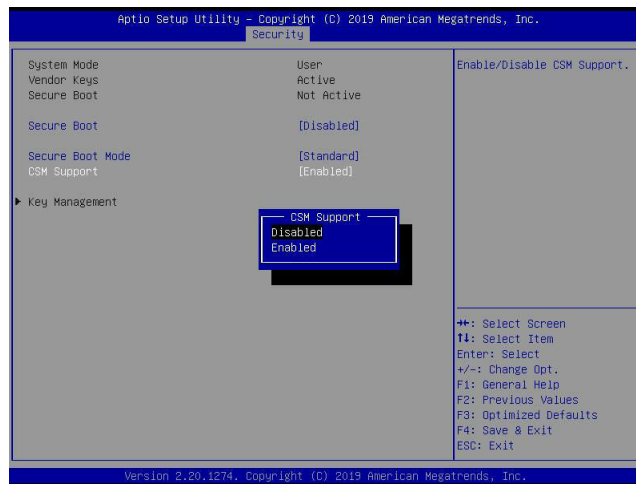

For the changes to take effect, press <F4> to save the settings and exit the BIOS Setup utility.

Step 4. Press during system boot to enter the BIOS Setup utility. Navigate to the Security tab and enter the Secure Boot menu. Set Secure Boot to Enabled.

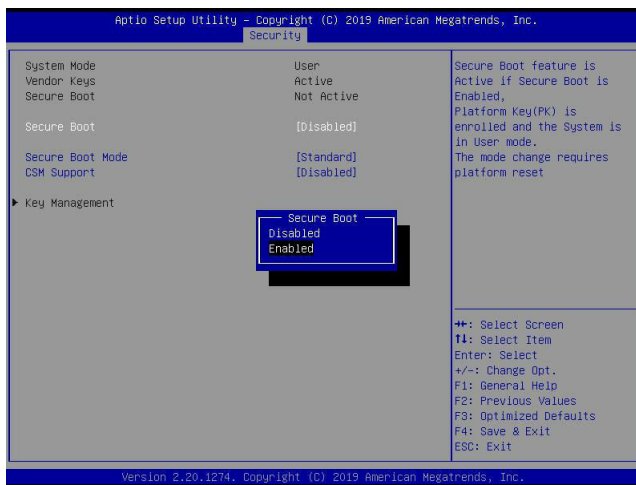

For the changes to take effect, press <F4> to save the settings and exit the BIOS Setup utility. Press during system boot to enter the BIOS Setup utility. Navigate to the Security tab and enter the Secure Boot menu. The following screen will appear.

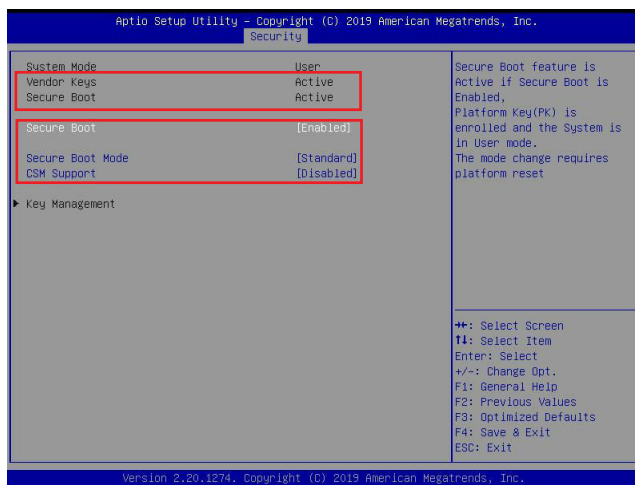

Note: Once Secure Boot is enabled, CSM Support will become disabled and the legacy environment is no longer valid. The authorized UEFI support such as UEFI OS, AOC UEFI FW, and UEFI PXE server are allowed.

F.4 Key Management Settings

The Key Management menu as shown below, which is available when Secure Boot Mode is set to Custom, allows the secure boot keys to be installed via the external device and be involved in the secure boot process.

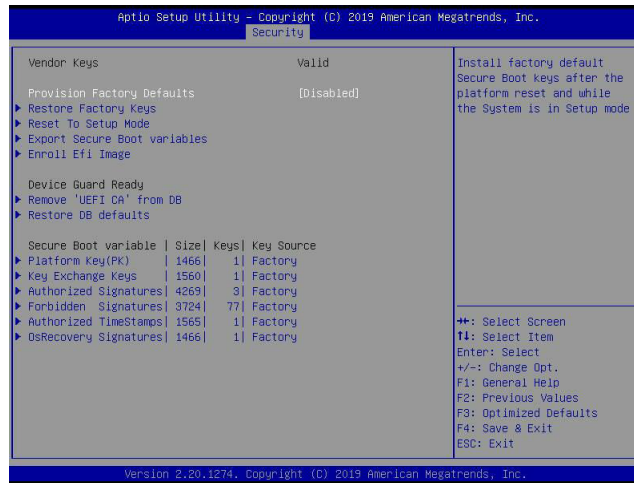

Provision Factory Defaults

This feature is to provision the default secure boot keys set by the manufacturer when system is in the Setup mode. The options are **Disabled** and Enabled.

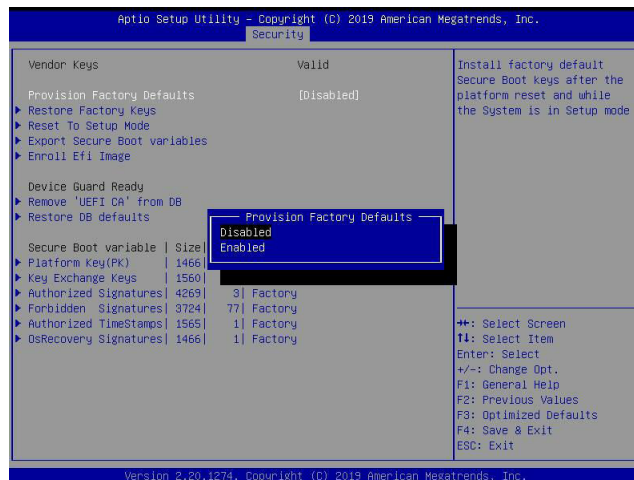

► Restore Factory Keys

Select and press Yes to restore factory default secure boot keys and key variables. Also, it will reset the system to the User mode. The options are **Yes** and No.

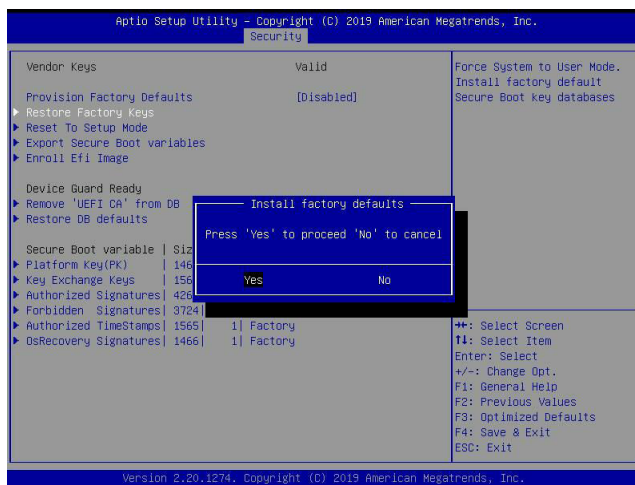

► Reset To Setup Mode (available when the System Mode is in User mode)

Select and press Yes to clear all secure boot variables and reset the system to the Setup mode. The options are **Yes** and No.

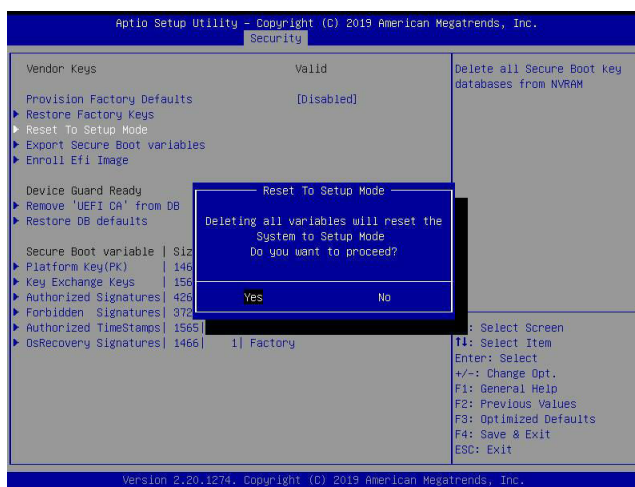

► Export Secure Boot variables

Use this feature to export NVRAM content of secure boot variables to files in a root folder on a file system device.

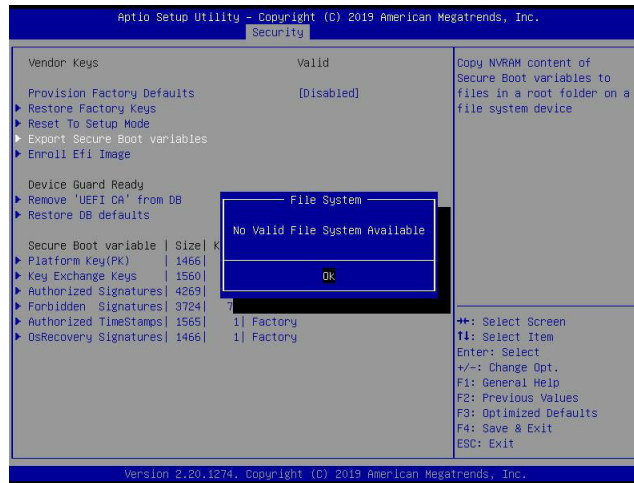

► Enroll Efi Image

This feature is to enroll SHA256 hash of the binary into the Authorized Signature Database (DB) and to allow the image to run in the secure boot mode.

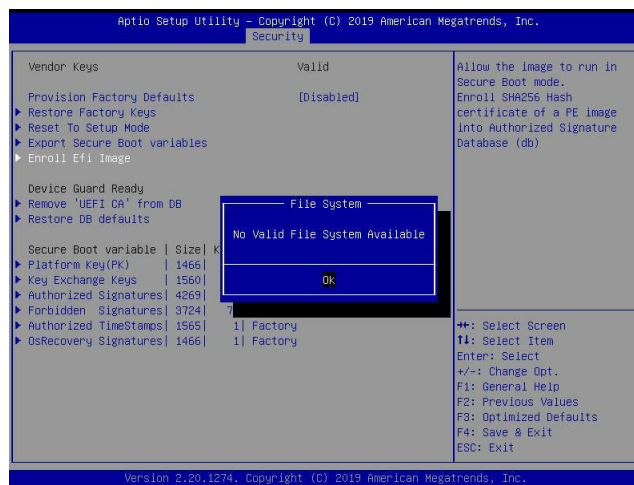

► Remove 'UEFI CA' from DB (available when the system is not in Device Guard Ready)

Select and press Yes to remove Microsoft UEFI CA certificate from the DB. The options are **Yes** and **No**.

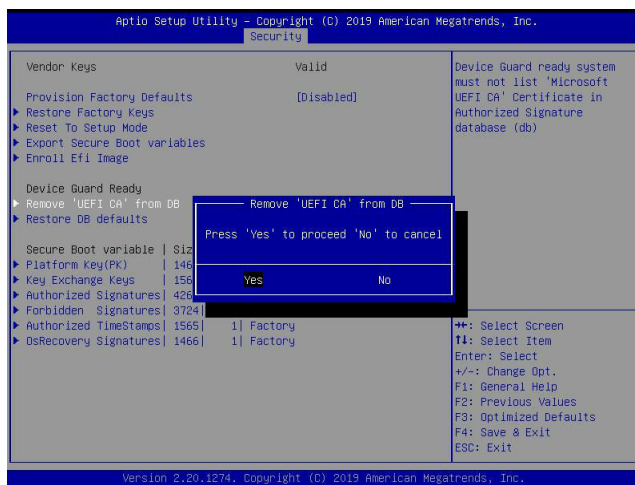

► Restore DB defaults

Select and press Yes to restore the DB variables to factory defaults. The options are **Yes** and **No**.

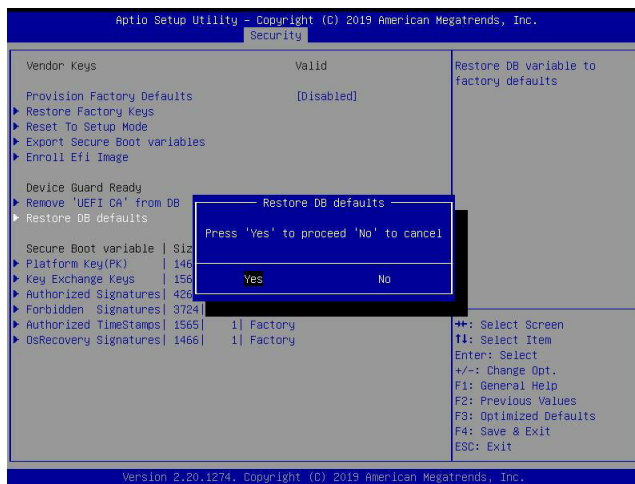

***Refer to the following settings for keys and signatures related to secure boot.**

► Platform Key (PK)

The Platform Key (PK), which is pre-installed in firmware during manufacturing, provides full control of the secure boot key hierarchy. The options are **Details**, Export, Update, and Delete. Select Details to display detailed information of PK. Select Export to save the current PKs to a FAT formatted USB flash drive. Select Update to load the factory defaults or load PKs from a file on the external device. Select Delete to clear the current PKs and reset the system to the Setup mode. See the following for more information of each option.

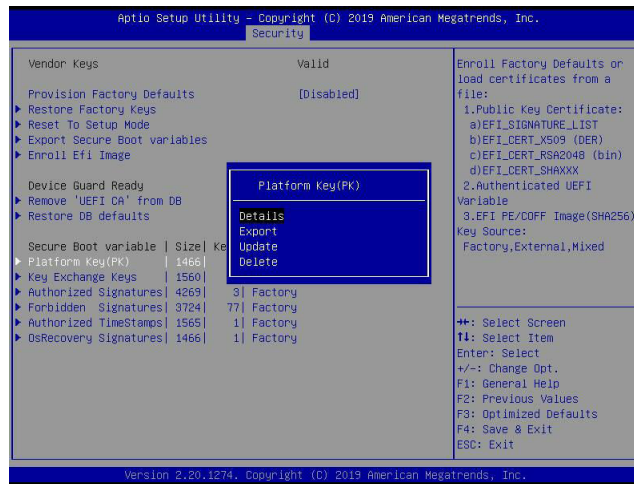

Details: Use the arrow keys to select Details and press <Enter>. It displays detailed information of PK as shown below.

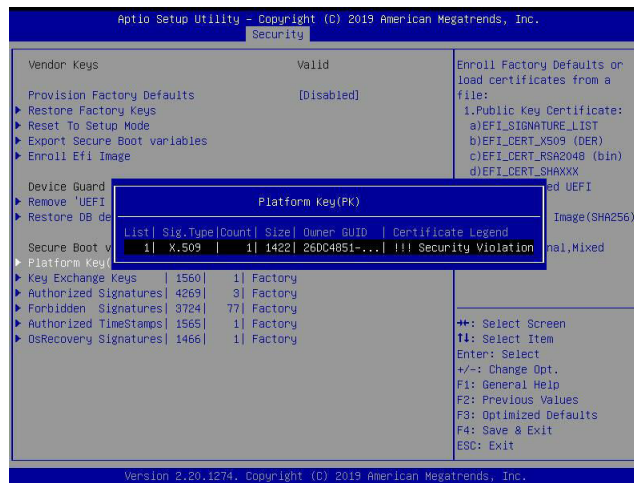

Export: Use the arrow keys to select Export. It is to save the current PKs to a FAT formatted USB flash drive.

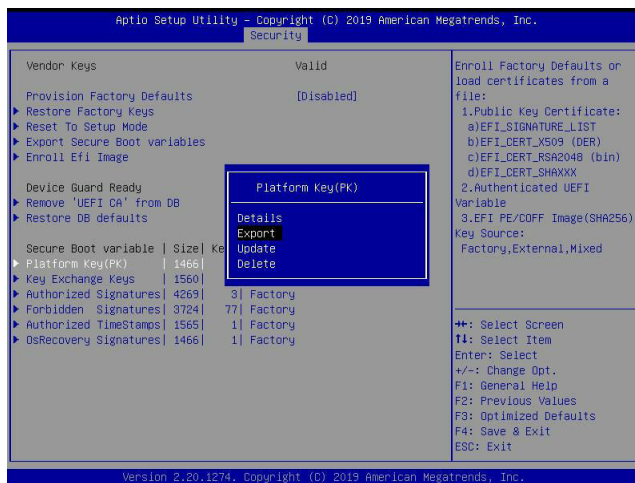

Press <Enter> and the following screen will appear.

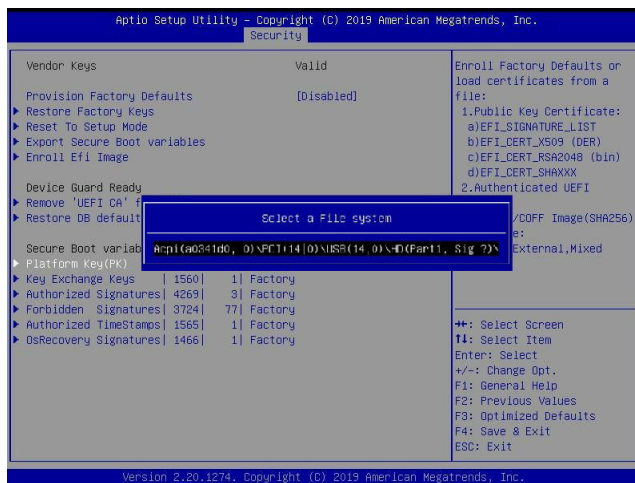

Note: Refer to the right panel of the screen for the file formats accepted.

Update: Use the arrow keys to select Update. It is to load the factory defaults or load PKs from a file on the external device.

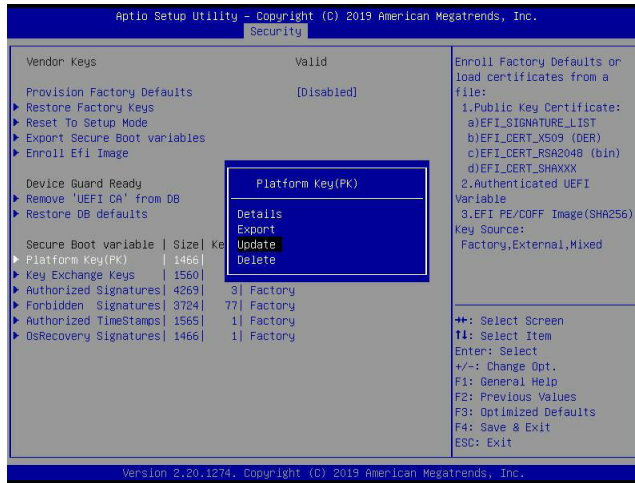

Press <Enter> and the following screen will appear.

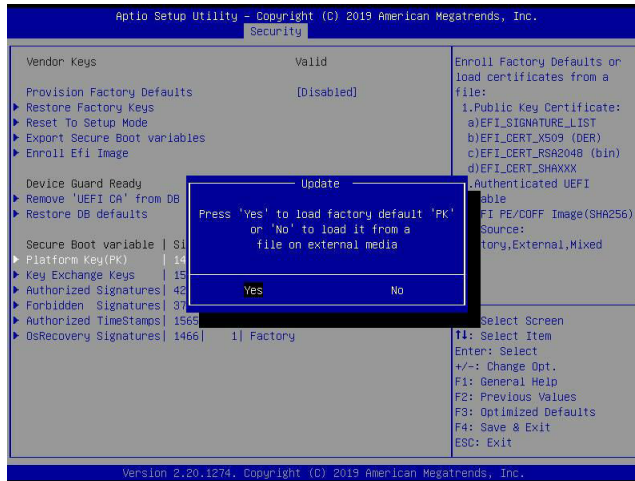

To load the factory defaults, navigate to Yes and press <Enter>. The following screen will appear.

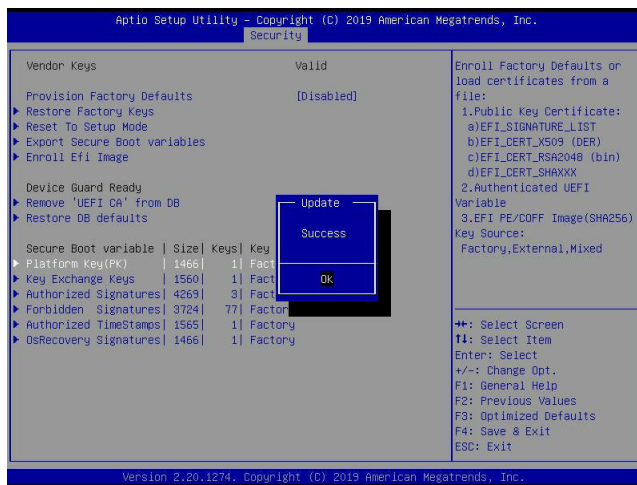

To load PKs from a file on the external device, navigate to No and press <Enter>.

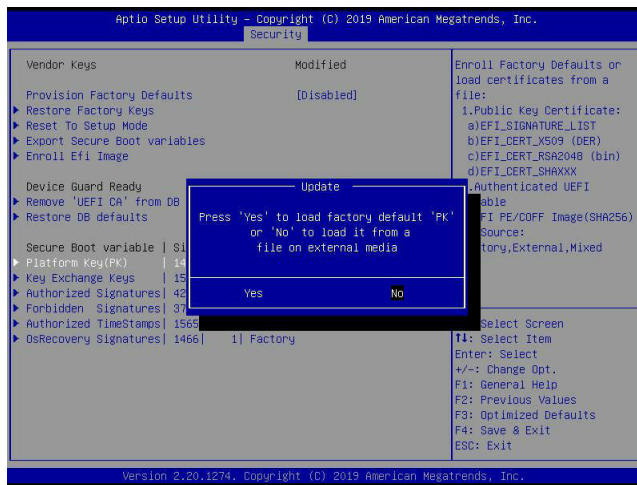

When the following screen appears, select the USB flash drive that contains the desired file.

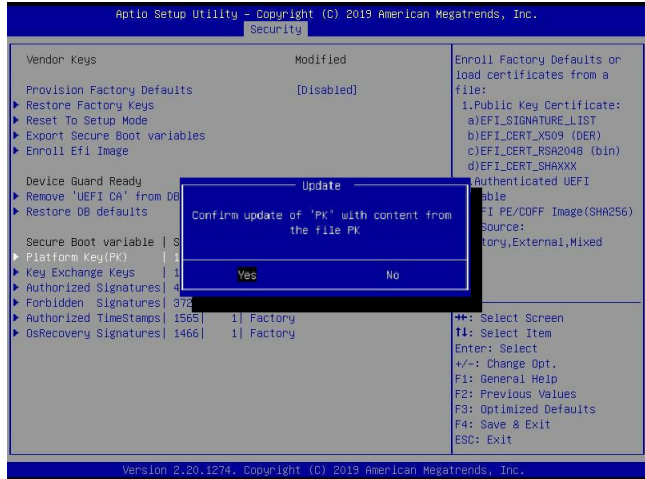
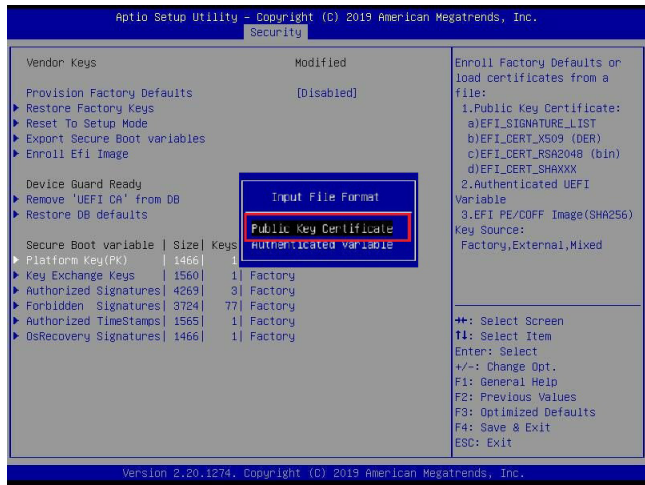
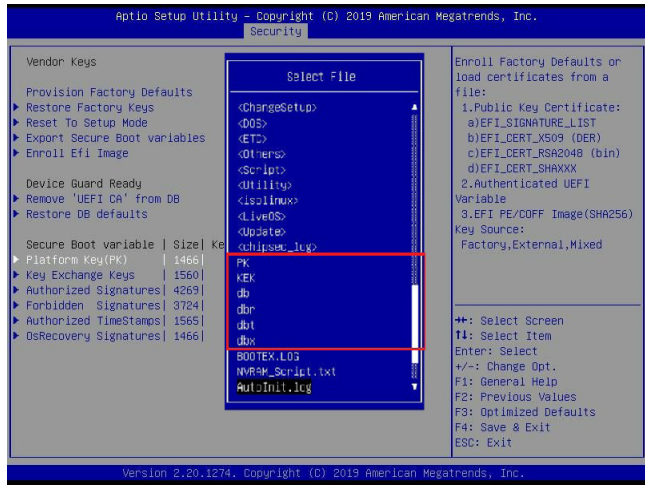

Press <Enter> and the following screen will appear.

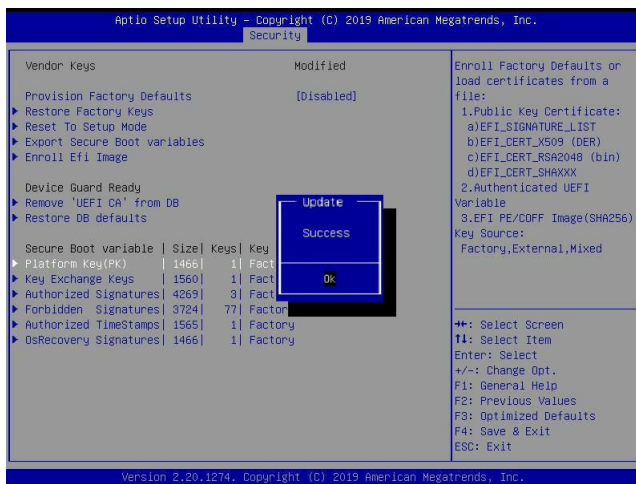

Delete: Use the arrow keys to select Delete and press <Enter> to clear the current PKs and reset the system to the Setup mode.

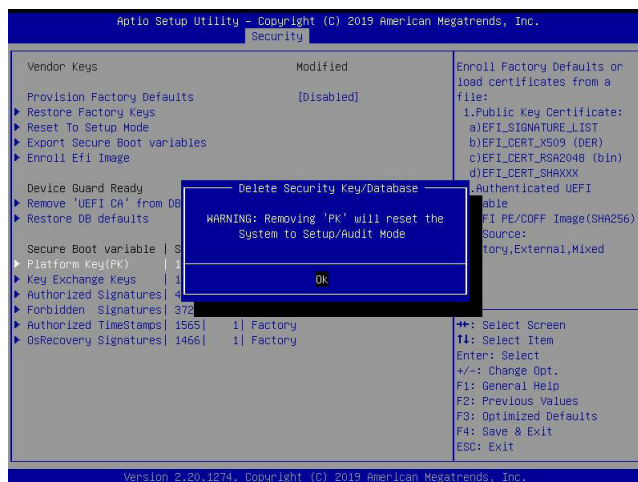
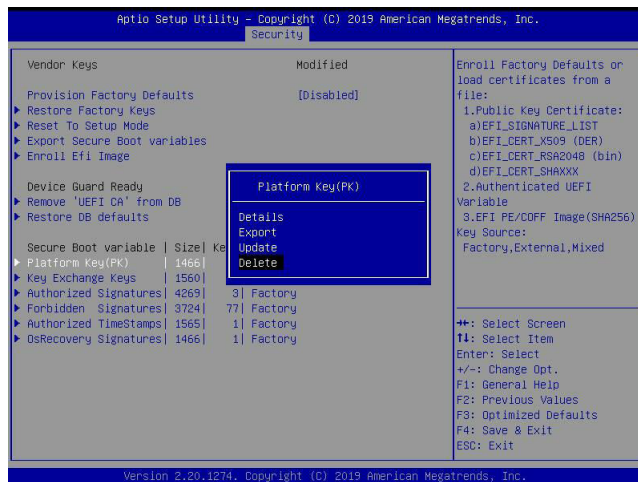

► Key Exchange Key

The Key Exchange Key (KEK), which is held by the operating system vendor, can be updated by the holder of the PK and be used by secure boot to protect access to signatures databases. The options are **Details**, Export, Update, Append, and Delete. Select Details to display detailed information of KEKs. Select Export to save the current KEKs to a FAT formatted USB flash drive. Select Update to load the factory defaults or load KEKs from a file on the external device. Select Append to load the factory defaults or load KEKs from a file on the external device. Select Delete to clear the current KEKs or to delete only one certificate from the key database. (Refer to page 191 for the Export process. Refer to pages 192, 193, 194, and 195 for the Update process.)

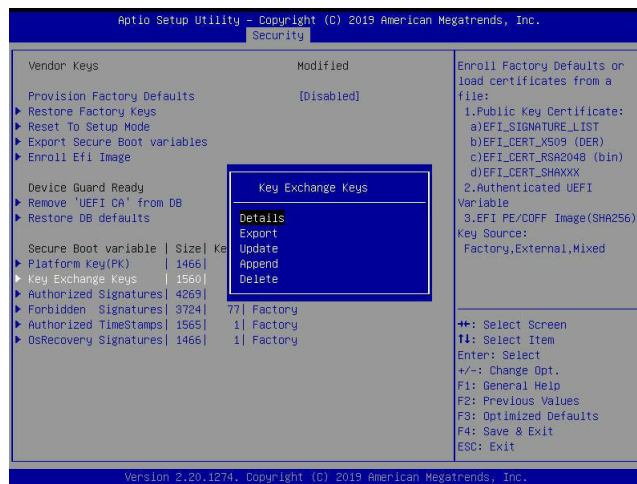

Append: Use the arrow keys to select Append.

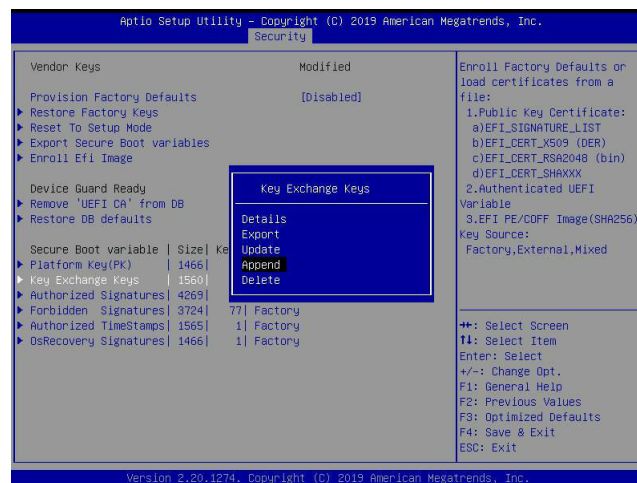

Press <Enter> and the following screen will appear.

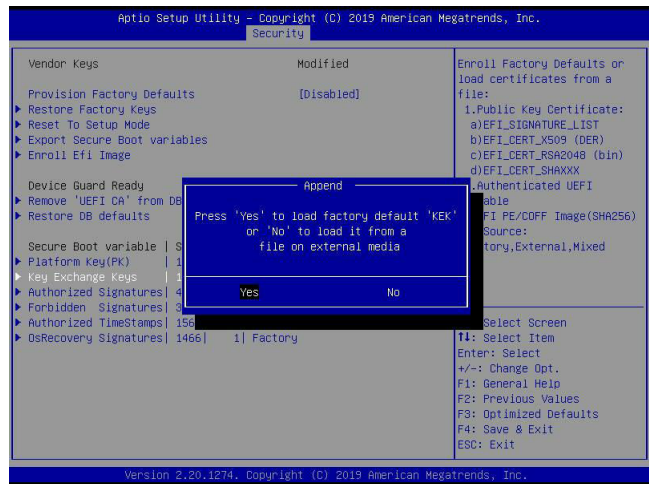

To load the factory defaults, navigate to Yes and press <Enter>. The following screen will appear.

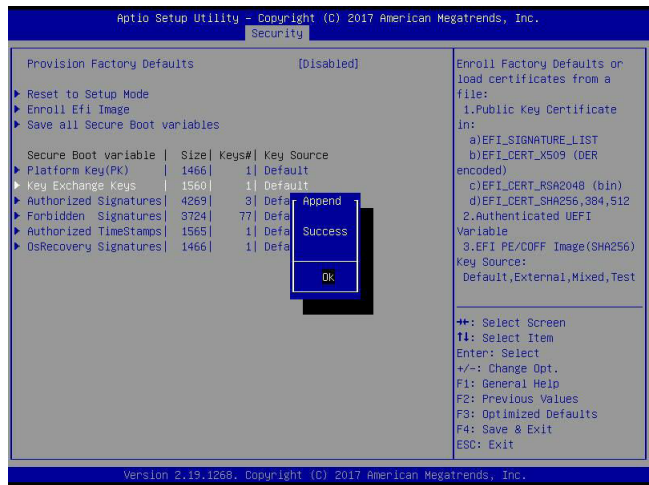

To load KEKs from a file on the external device, navigate to No and press <Enter>. Refer to pages 194 and 195 on how to load KEKs from a file on the external device.

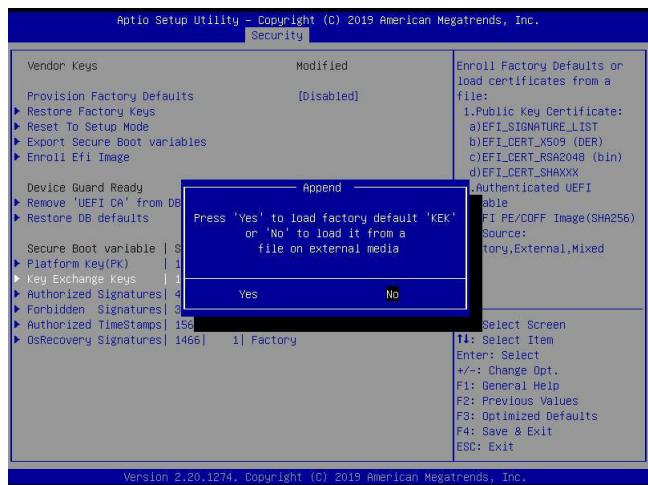

Delete: Use the arrow keys to select Delete and press <Enter>. Navigate to Yes and press <Enter> to clear the current KEKs.

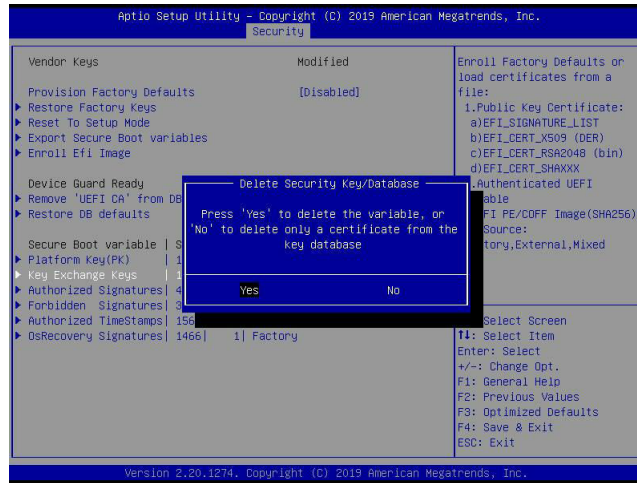
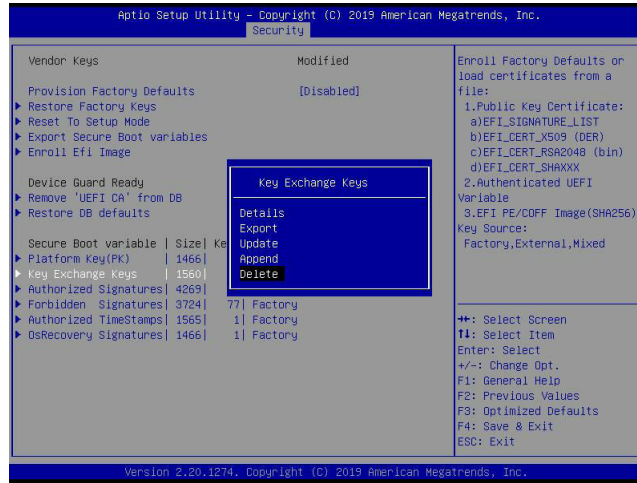

Navigate to No and press <Enter> to delete only one certificate from the key database.

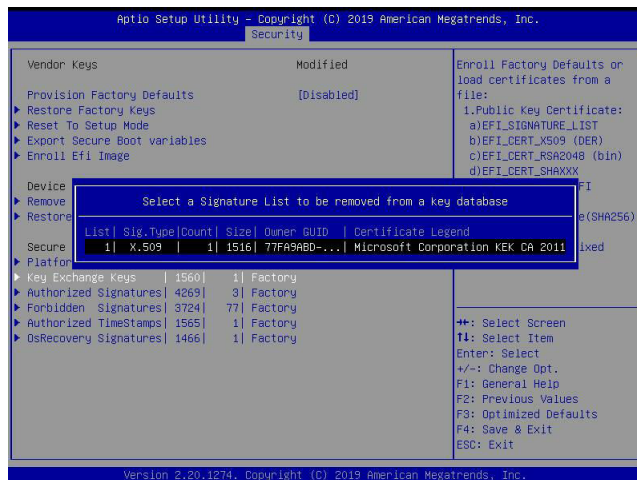

► Authorized Signatures

Authorized Signature Database (DB) contains authorized signing certificates and digital signatures. The options are **Details**, Export, Update, Append, and Delete. Select Details to display detailed information of Authorized Signatures. Select Export to save the current DB to a FAT formatted USB flash drive. Select Update to load the factory defaults or load DB from a file on the external device. Select Append to add variables to the existing DB. Select Delete to clear the current DB or to delete only one certificate from the key database. (Refer to page 191 for the Export process. Refer to pages 192, 193, 194, and 195 for the Update process. Refer to pages 196 and 197 for the Append process. Refer to page 198 for the Delete process.)

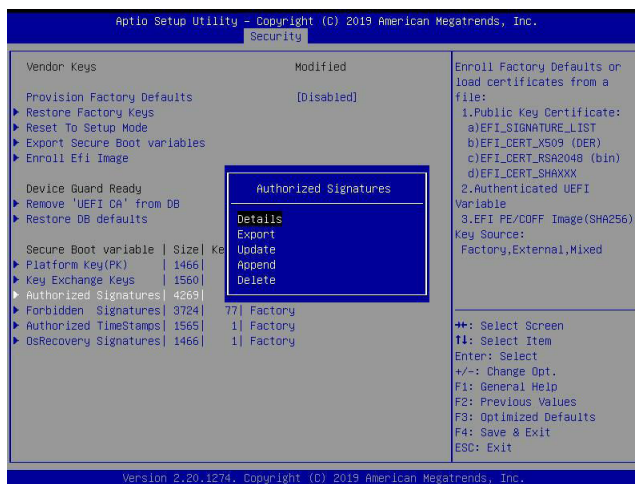

► Forbidden Signatures

Forbidden Signature Database (DBX), which is the inverse of DB, contains forbidden certificates and digital signatures. The options are **Details**, Export, Update, Append, and Delete. Select Details to display detailed information of Forbidden Signatures. Select Export to save the current DBX to a FAT formatted USB flash drive. Select Update to load the factory defaults or load DBX from a file on the external device. Select Append to add variables to the existing DBX. Select Delete to clear the current DBX or to delete only one certificate from the key database. (Refer to page 191 for the Export process. Refer to pages 192, 193, 194, and 195 for the Update process. Refer to pages 196 and 197 for the Append process. Refer to page 198 for the Delete process.)

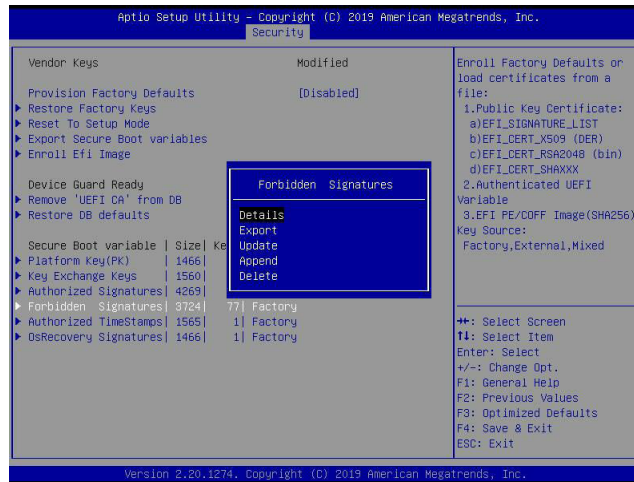

► Authorized TimeStamps

Authorized Timestamp Database (DBT) is used to issue and check signed time stamp certificates. The options are **Details**, Export, Update, Append, and Delete. Select Details to display detailed information of Authorized Timestamps. Select Export to save the current DBT to a FAT formatted USB flash drive. Select Update to load the factory defaults or load DBT from a file on the external device. Select Append to add variables to the existing DBT. Select Delete to clear the current DBT or to delete only one certificate from the key database. (Refer to page 191 for the Export process. Refer to pages 192, 193, 194, and 195 for the Update process. Refer to pages 196 and 197 for the Append process. Refer to page 198 for the Delete process.)

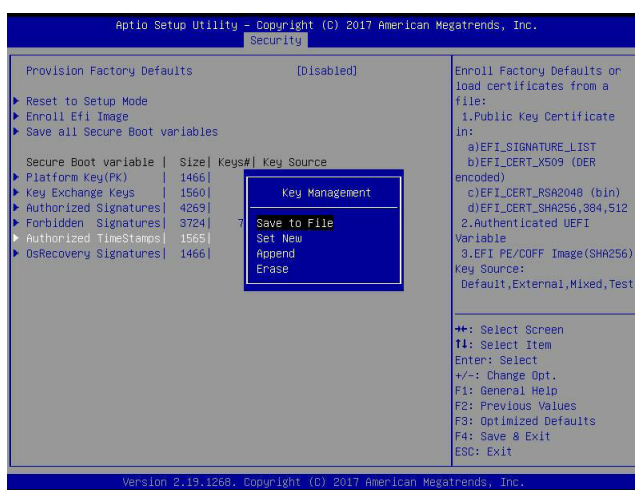

► OsRecovery Signatures

OsRecovery Signatures Database (DBR) contains secure boot authorized recovery variables. The options are **Details**, Export, Update, Append, and Delete. Select Details to display detailed information of OsRecovery Signatures. Select Export to save the current DBR to a FAT formatted USB flash drive. Select Update to load the factory defaults or load DBR from a file on the external device. Select Append to add variables to the existing DBR. Select Delete to clear the current DBR or to delete only one certificate from the key database. (Refer to page 191 for the Export process. Refer to pages 192, 193, 194, and 195 for the Update process. Refer to pages 196 and 197 for the Append process. Refer to page 198 for the Delete process.)

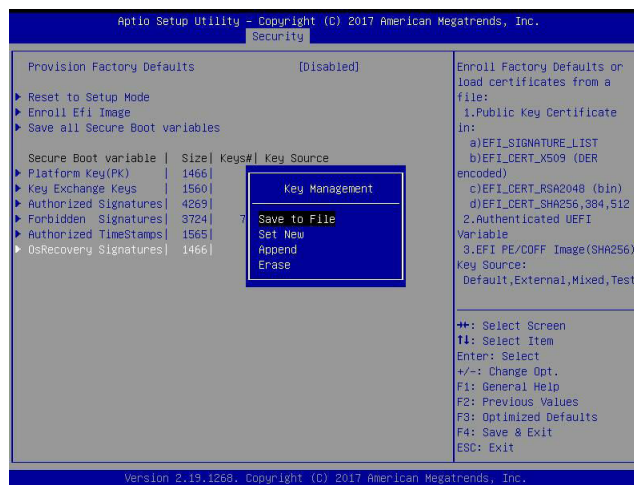

Appendix G

Configuring iSCSI Settings

Internet small computer system interface (iSCSI) is a protocol that defines how block-level data transports between the iSCSI initiator and iSCSI target over an Internet protocol (IP) network. The iSCSI initiator (client/host) enables a connection to the iSCSI target and initiates I/O requests. The iSCSI target can be a group of storage devices or an intermediate device attached to storage devices. The iSCSI initiator and iSCSI target must connect to an IP network. To have iSCSI settings available, refer to instructions stated in the G.1 section. The G.2 section explains iSCSI settings.

G.1 PCIe/PCI/PnP Features

Press during system boot to enter the BIOS Setup utility. Navigate to the Advanced tab. Use the arrow keys to select PCIe/PCI/PnP Configuration and press <Enter> to access the menu items.

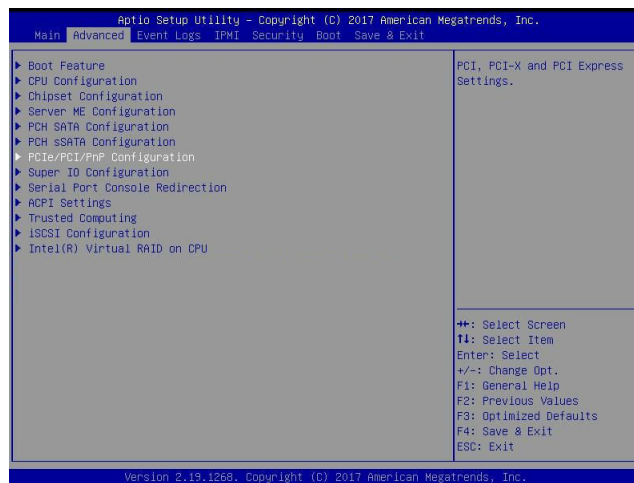

Note: Be sure to have configuration information for the iSCSI initiator and iSCSI target before starting iSCSI settings.

Onboard LAN1 Option ROM

Use the arrow keys to select Onboard LAN1 Option ROM and press <Enter>. The options are Disabled, **Legacy**, and EFI. Set this feature to EFI.

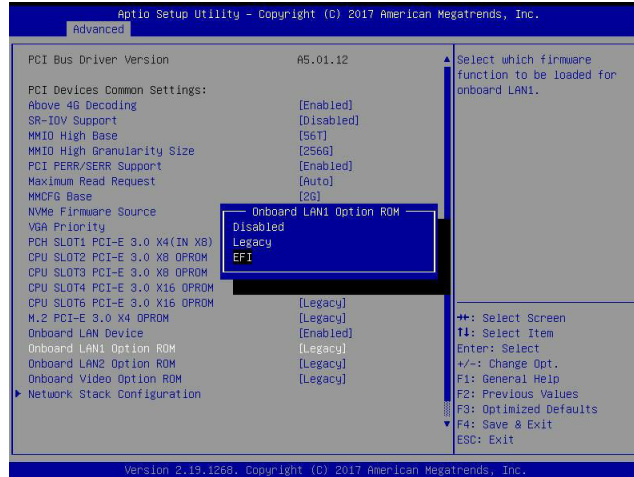

Note: If Onboard LAN1 Option ROM is set to EFI, all features for onboard LAN option ROM will be set to EFI by the EFI driver. Additionally, these features will become unavailable except Onboard LAN1 Option ROM.

Network Stack Configuration

Use the arrow keys to select Network Stack Configuration and press <Enter> to access the menu items.

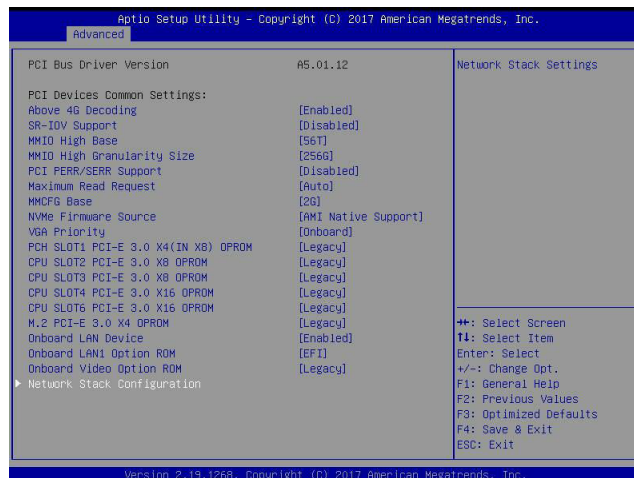

Ipv4 PXE Support/Ipv6 PXE Support

To enable Ipv4/Ipv6 PXE boot support, use the arrow keys to select and set Ipv4 PXE Support/Ipv6 PXE Support to Enabled.



 **Note:** Enable both Ipv4 PXE Support and Ipv6 PXE Support to have iSCSI settings available. In some cases, enabling either one feature may also have iSCSI settings available depending on the configuration of iSCSI initiator and iSCSI target.

For the changes to take effect, save settings and restart the system. Press during system boot to enter the BIOS Setup utility. When the BIOS main screen appears, navigate to the Advanced tab. Use the arrow keys to select iSCSI Configuration and press <Enter> to access the menu items.

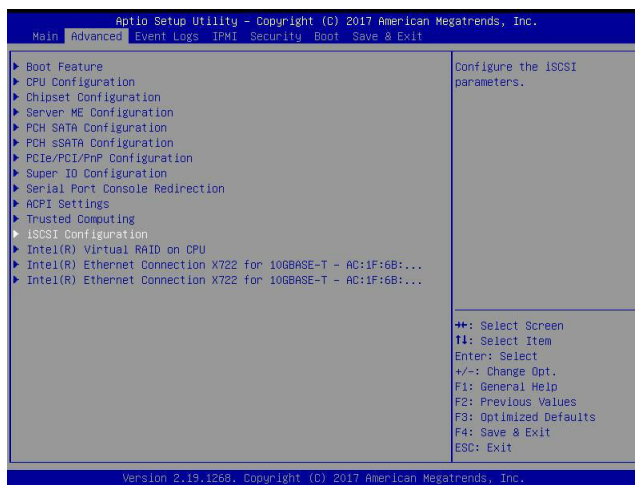

G.2 Configuring iSCSI Settings

iSCSI Initiator Name

Use this feature to enter the unique initiator name in iSCSI qualified name (IQN) format.

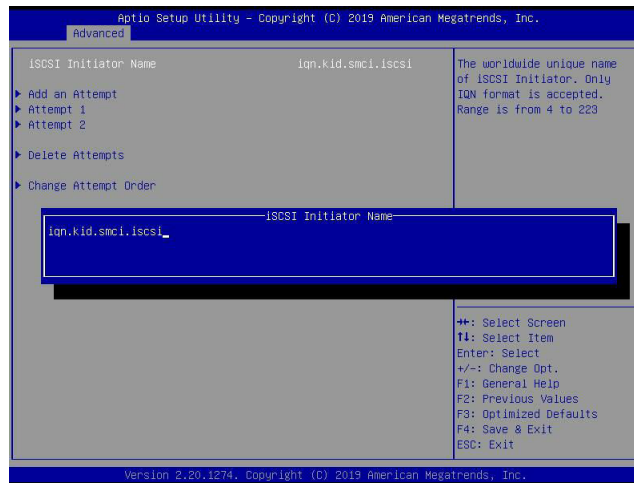

Add an Attempt

Use the arrow keys to select Add an Attempt.

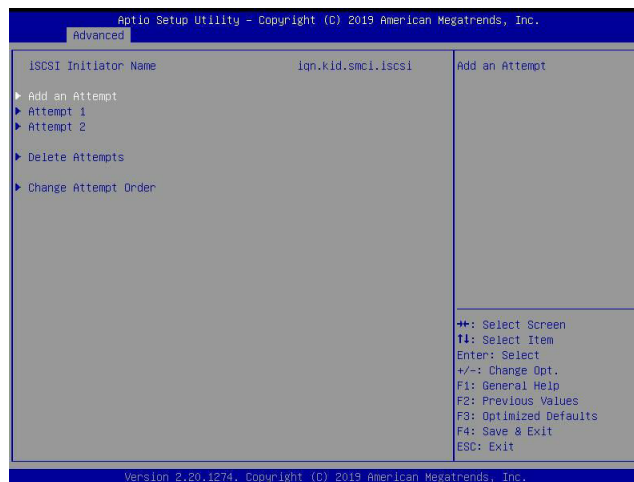

Press <Enter> and the following screen will appear. Use the arrow keys to select the desired media access control address (MAC address), network interface card (NIC) port.

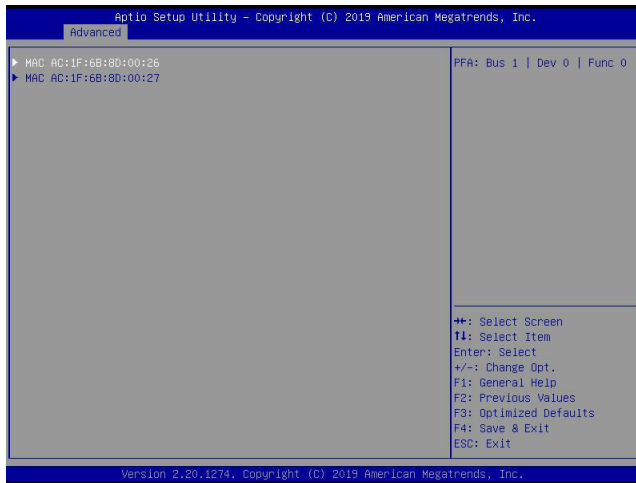

Press <Enter> and the following screen will appear.

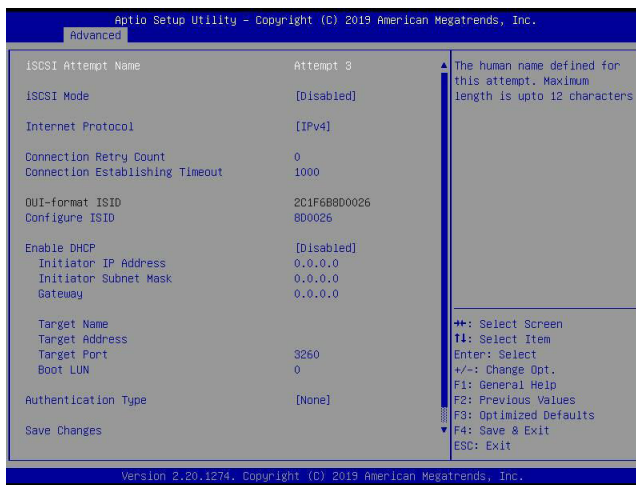

iSCSI Attempt Name

This feature displays the iSCSI attempt name.

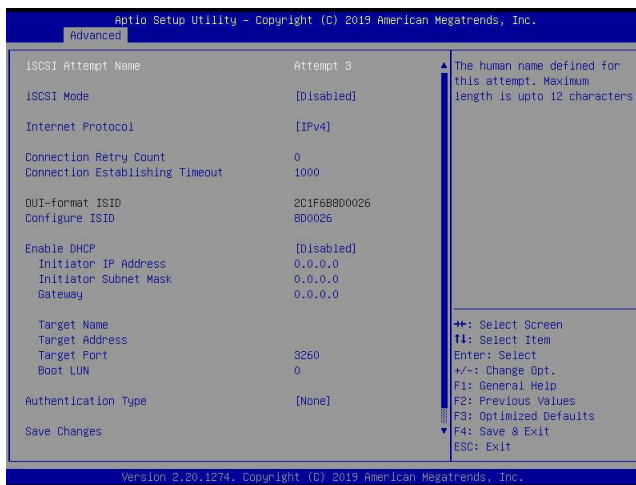

iSCSI Mode

Use this feature to set the iSCSI mode. The options are **Disabled**, Enabled, and Enabled for MPIO. Multipath I/O (MPIO) is a feature that allows the system to route I/O through the available paths if the active path fails (be sure to have more than one physical path connected to the system).

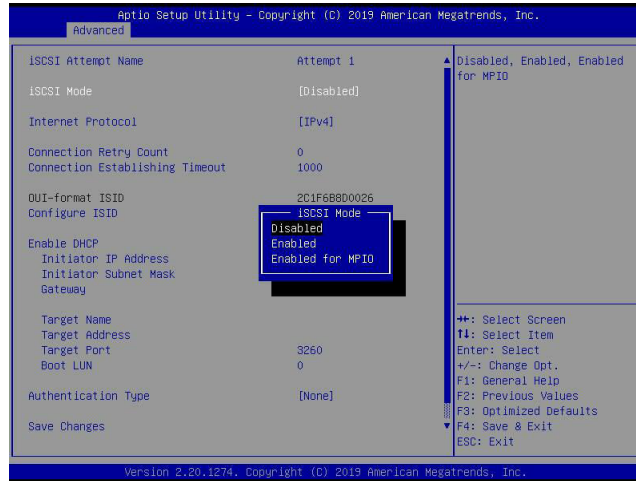

 **Note:** Enabling the feature, iSCSI Mode, is required for iSCSI configuration.

Internet Protocol

Use this feature to set the Internet Mask protocol. The options are **IPv4**, IPv6, and Autoconfigure.

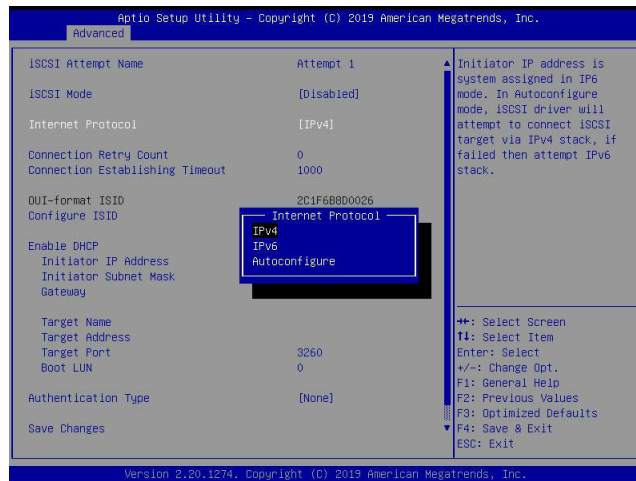

Connection Retry Count

The valid range is 0~16. Use this feature to enter the number of logon sessions allowed for the iSCSI initiator to restart with the iSCSI target if the first logon connection fails.

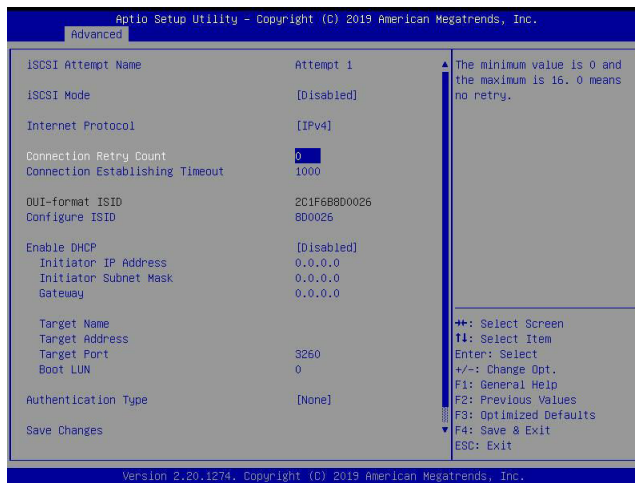

Connection Establishing Timeout

Use this feature to set the logon connection establishing timeout (in milliseconds). The valid range is from 100 milliseconds to 20 seconds.

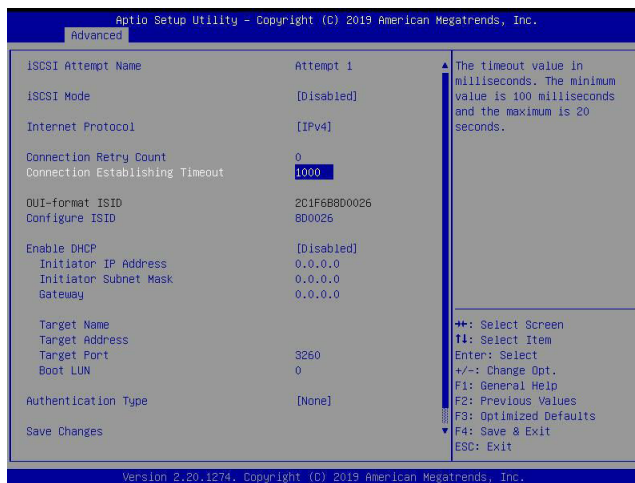

OUI-format ISID

This feature displays the default ISID in OUI format. The value (in six bytes) is derived from the MAC address of the NIC port that you selected earlier.

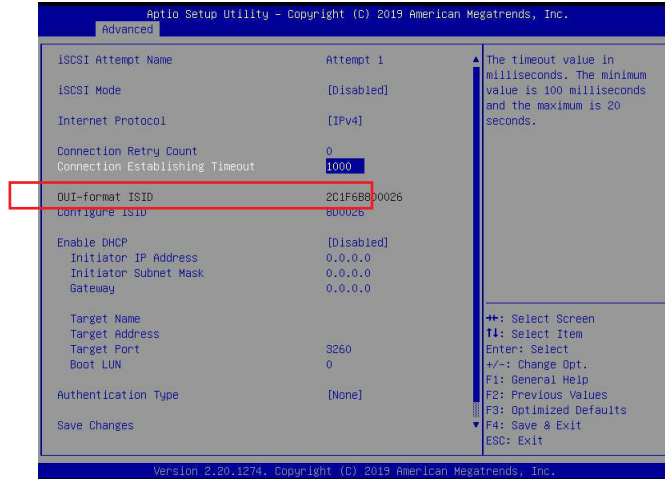

Configure ISID

Press <Enter> to configure the ISID. The default value is derived from the last three bytes of the OUI-format ISID. Also, only the last three bytes of the ISID are configurable.

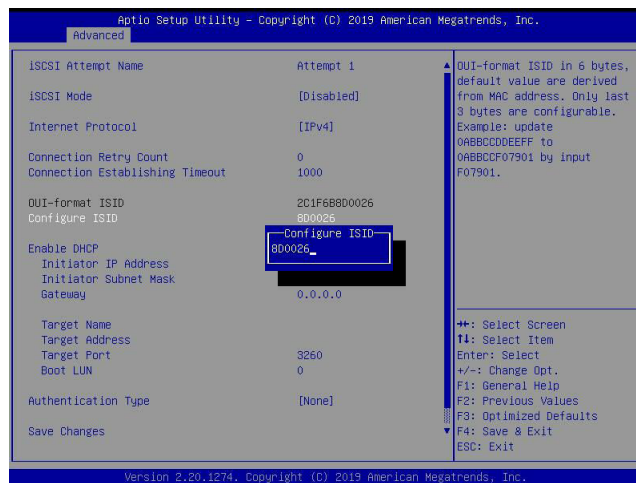

Enable DHCP

Use this feature to disable/enable dynamic host configuration protocol (DHCP) server service for the iSCSI initiator. The options are **Disabled** and Enabled.

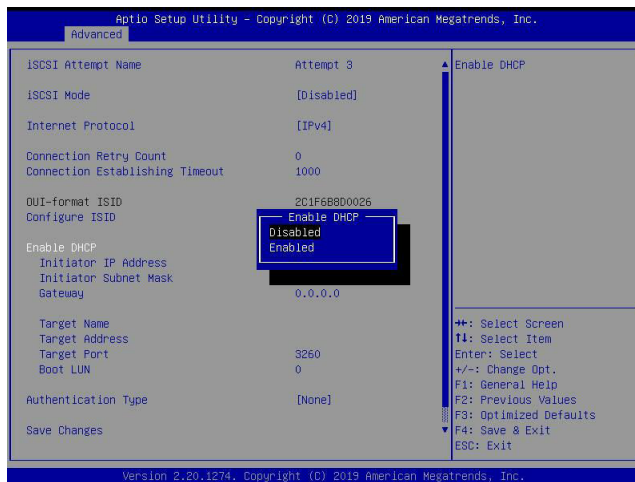

 **Note:** Set the feature, Enable DHCP, to Disabled if you would like to specify the iSCSI initiator IP address/subnet mask/gateway.

Initiator IP Address (available when Enable DHCP is set to Disabled)

Use this feature to enter the desired iSCSI initiator IP address.

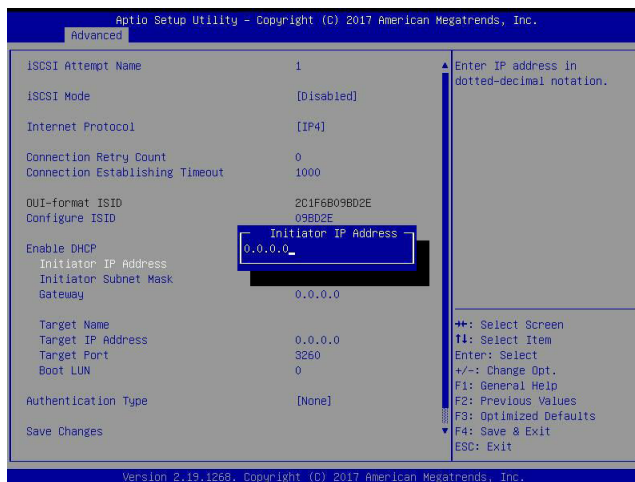

Initiator Subnet Mask (available when Enable DHCP is set to Disabled)

Use this feature to enter the desired iSCSI initiator subnet mask.

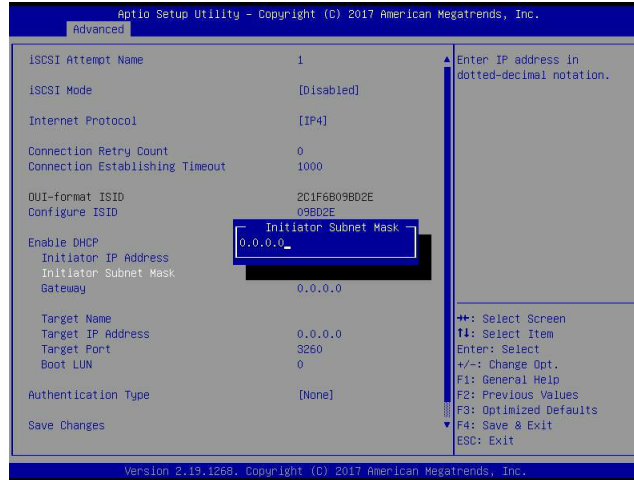

Gateway (available when Enable DHCP is set to Disabled)

Use this feature to enter the desired iSCSI initiator gateway.

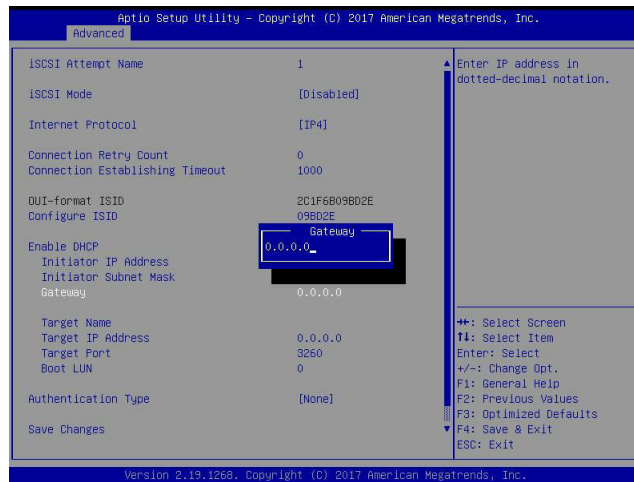

Get target info via DHCP (available when Enable DHCP is set to Enabled)

Use this feature to disable/enable dynamic host configuration protocol (DHCP) server service for the iSCSI target. The options are **Disabled** and **Enabled**.

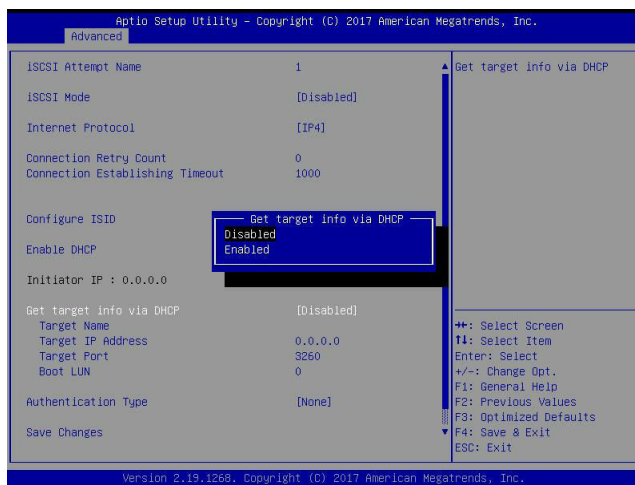

Note 1: Set the feature, Get target info via DHCP, to Disabled if you would like to specify the iSCSI target name/IP address/boot LUN.

Note 2: LUN stands for logical unit number, which is used to identify a logical/physical disk.

Target Name

Use this feature to enter the desired iSCSI target name in IQN format.

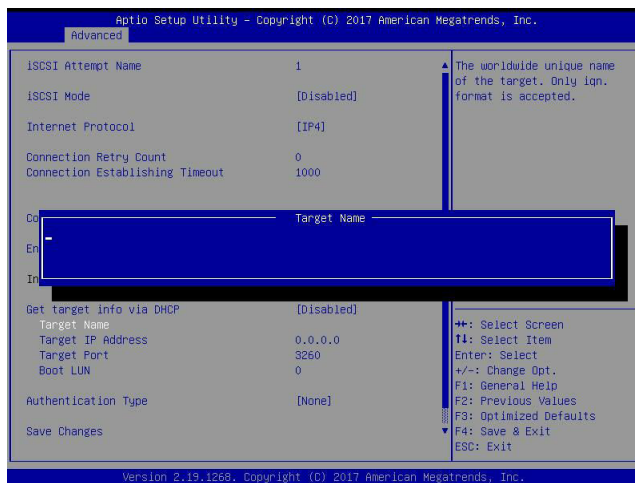

Target Address

Use this feature to enter the desired iSCSI target IP address.

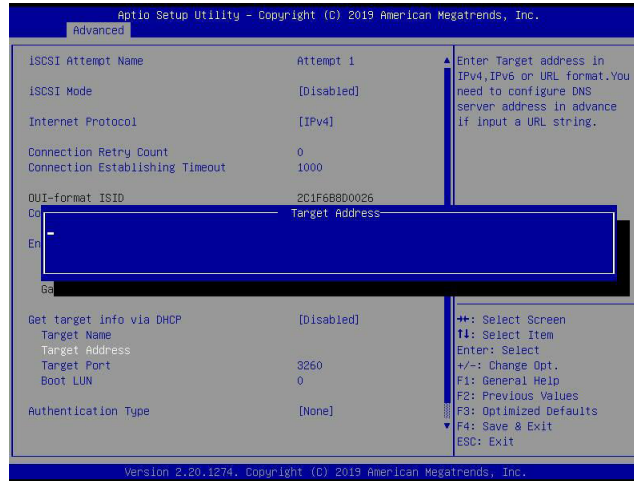

Target Port

This feature displays the iSCSI target port.

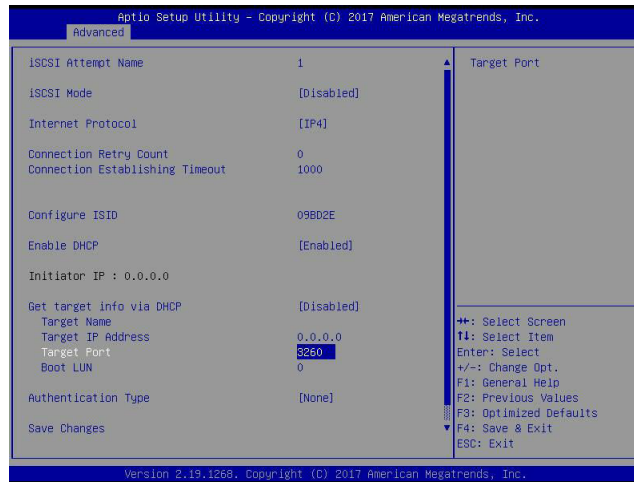

Boot LUN

Use this feature to enter the LUN ID of boot LUN.

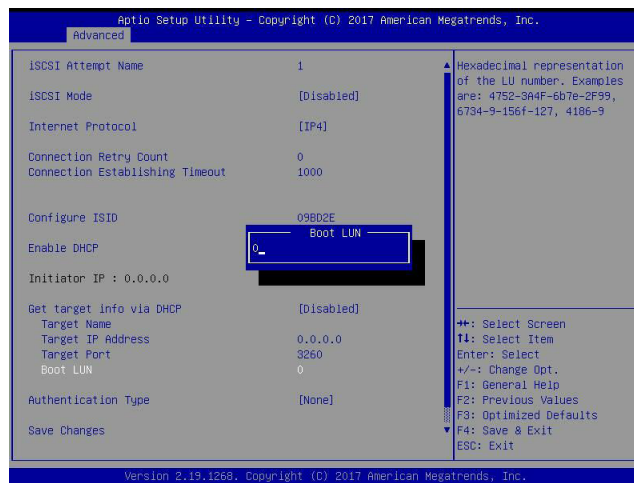

Authentication Type

Use this feature to set the authentication method. The options are CHAP and **None**.

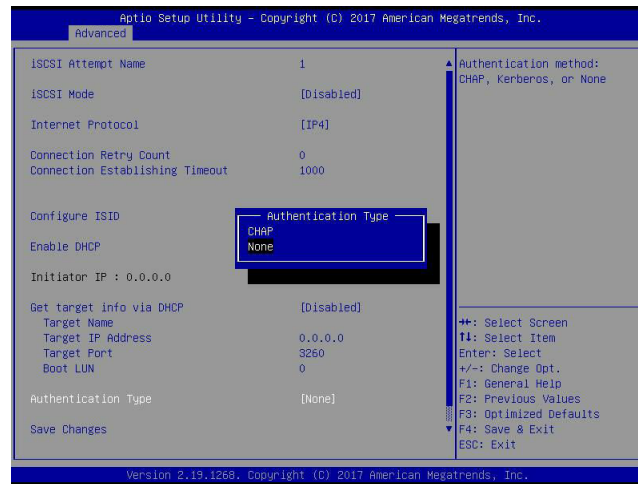

 **Note:** Challenge handshake authentication protocol (CHAP) is a protocol used to verify the identity of the peer of a connection.

CHAP Type (available when Authentication Type is set to CHAP)

Use this feature to set the CHAP type. The options are One way and **Mutual**.



 **Note 1:** If one way (unidirectional) CHAP authentication is performed, the iSCSI target authenticates the iSCSI initiator.

Note 2: If mutual (bidirectional) CHAP authentication is performed, the iSCSI target and iSCSI initiator authenticate each other.

CHAP Name (available when Authentication Type is set to CHAP)

Use this feature to enter the CHAP name authenticated by the iSCSI target.

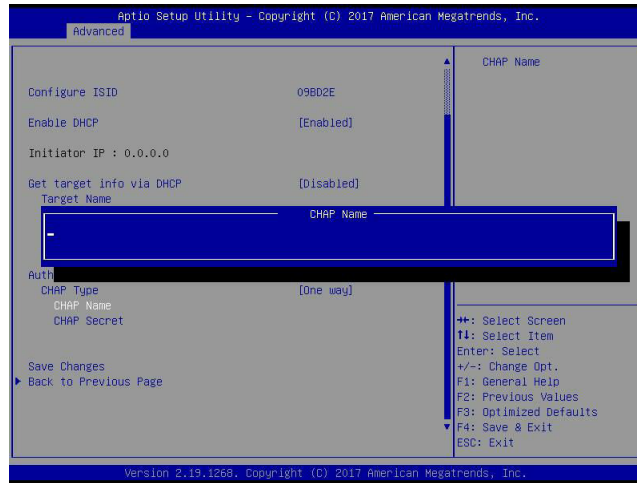

CHAP Secret (available when Authentication Type is set to CHAP)

Use this feature to enter the CHAP secret (12~16 characters) authenticated by the iSCSI target.

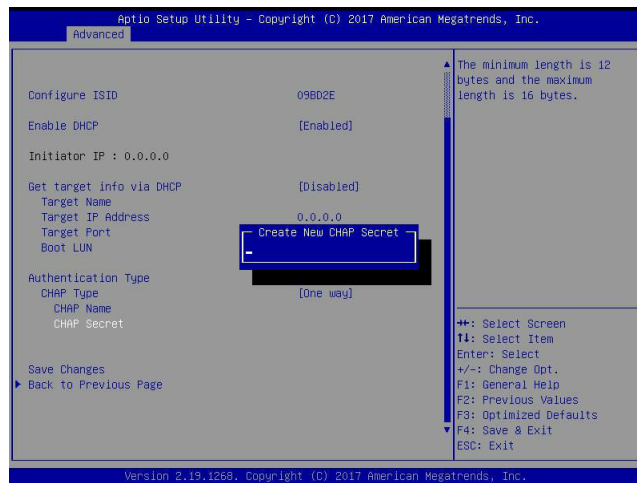

CHAP Status

This feature displays the CHAP status.

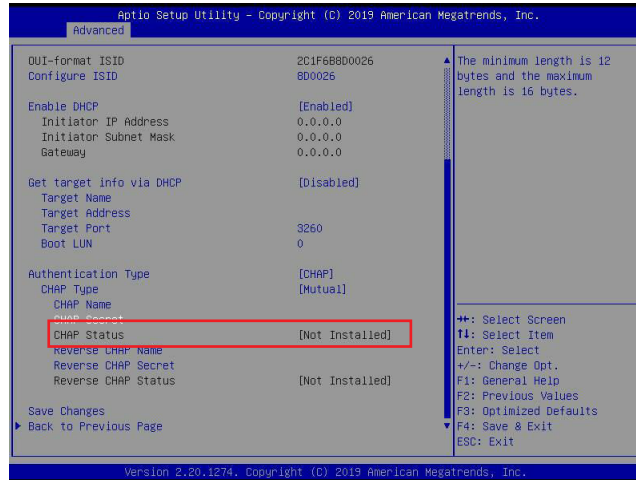

Reverse CHAP Name (available when CHAP Type is set to Mutual)

Use this feature to enter the CHAP name authenticated by the iSCSI initiator.



Reverse CHAP Secret (available when CHAP Type is set to Mutual)

Use this feature to enter the CHAP secret (12~16 characters) authenticated by the iSCSI initiator.

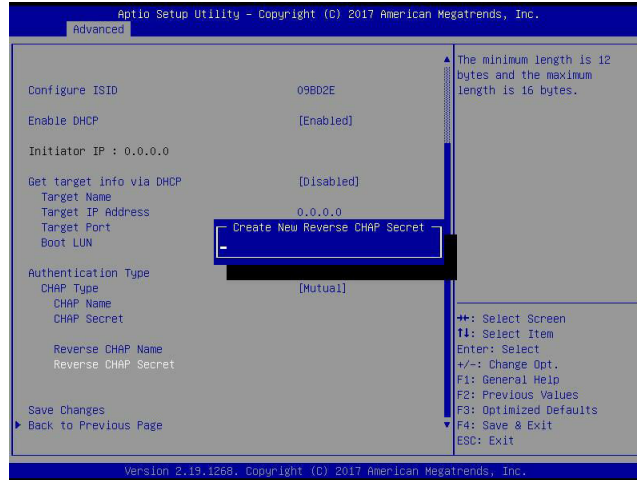

Reverse CHAP Status (available when CHAP Type is set to Mutual)

This feature displays the reverse CHAP status.

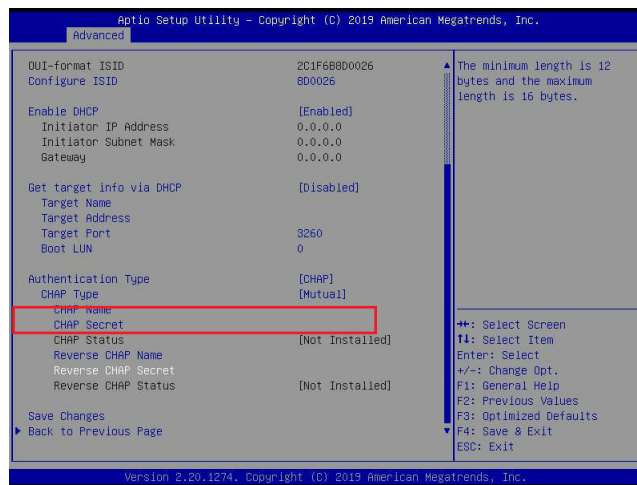

Save Changes

Use the arrow keys to select Save Changes and press <Enter> to save settings shown on the screen.

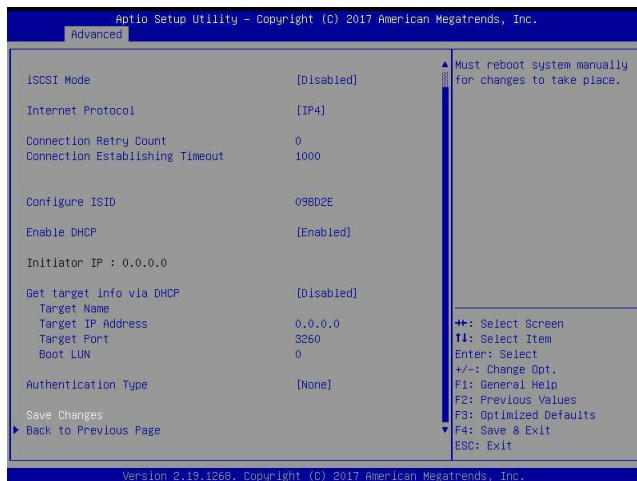

Note: For the changes to take effect, save settings and restart the system.

Back to Previous Page

Use the arrow keys to select Back to Previous Page and press <Enter>.

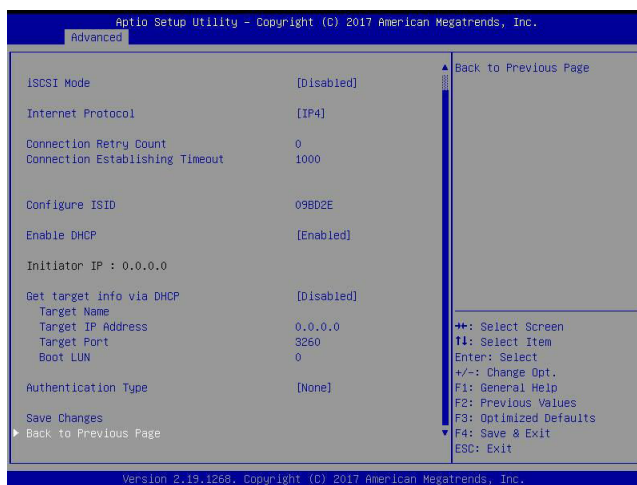

The user will be returned to the main screen of iSCSI Configuration as shown below.



Delete Attempts

Use the arrow keys to select Delete Attempts.

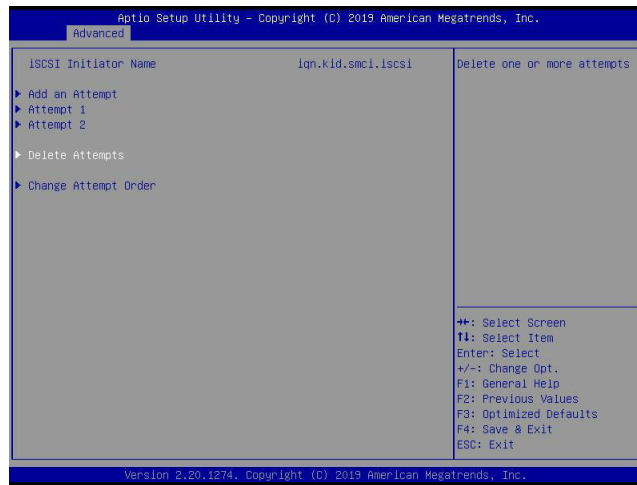

Press <Enter> and the following screen will appear.



Attempt 1

Use the feature to disable/enable Attempt 1. The options are **Disabled** and Enabled.

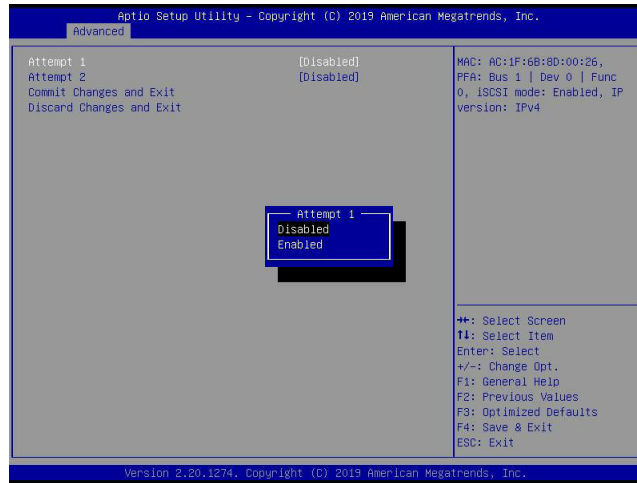

Attempt 2

Use the feature to disable/enable Attempt 2. The options are **Disabled** and Enabled.

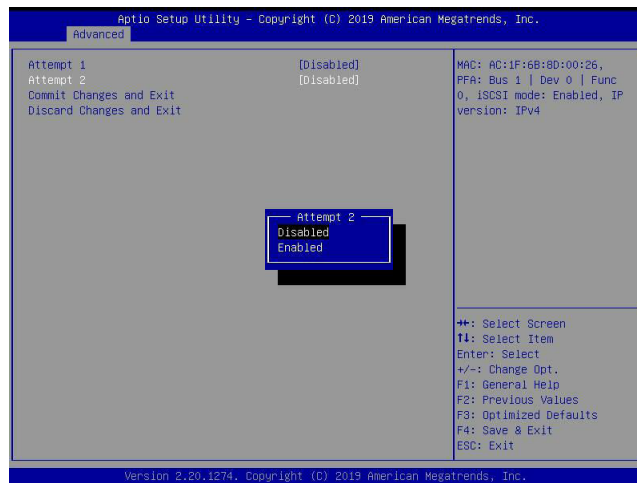

Commit Changes and Exit

Press <Enter> to save changes and return to the main screen of iSCSI Configuration.



Discard Changes and Exit

Press <Enter> to return to the main screen of iSCSI Configuration without any change.

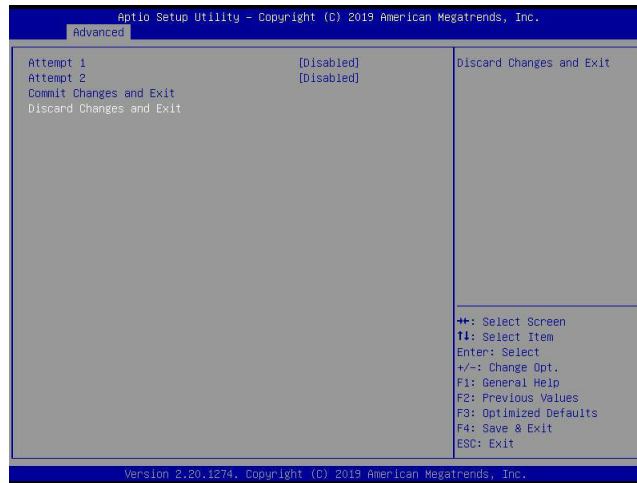

Change Attempt Order

Use the arrow keys to select Change Attempt Order.



Press <Enter> and the following screen will appear.



Change Attempt Order

This feature is to change the Attempt order. Use arrow keys to select the desired Attempt, then <+/-> keys to move up/down the selected Attempt. For instance, move up the selected Attempt by using <+> key. Move down the selected Attempt by using <-> key.

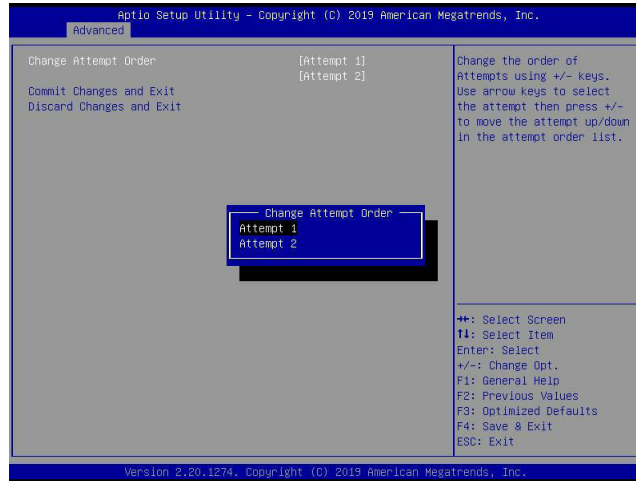

Commit Changes and Exit

Press <Enter> to save changes and return to the main screen of iSCSI Configuration.

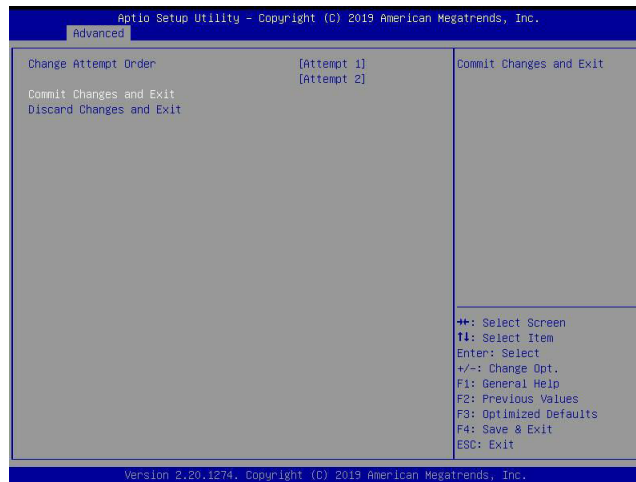

Discard Changes and Exit

Press <Enter> to return to the main screen of iSCSI Configuration without any change.



Appendix H

Configuring Network Interface Card (NIC) Settings

The appendix describes settings of onboard Intel® LAN devices via the BIOS Setup utility supported by the Unified Extensible Firmware Interface (UEFI) driver.

H.1 Network Interface Card (NIC) Settings

Press during system boot to enter the BIOS Setup utility. Navigate to the Advanced tab. Use the arrow keys to select PCIe/PCI/PnP Configuration and press <Enter> to access the menu items.

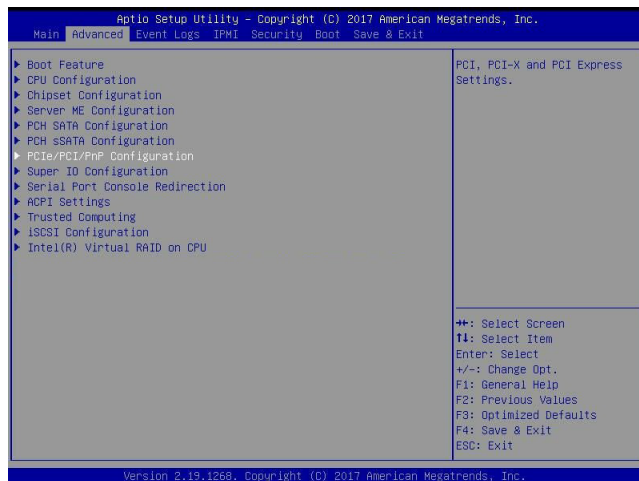

Onboard LAN1 Option ROM (available when NIC(s) is(are) detected by the system)

Use the arrow keys to select Onboard LAN1 Option ROM and press <Enter>. The options are Disabled, **Legacy**, and EFI. Set this feature to EFI.

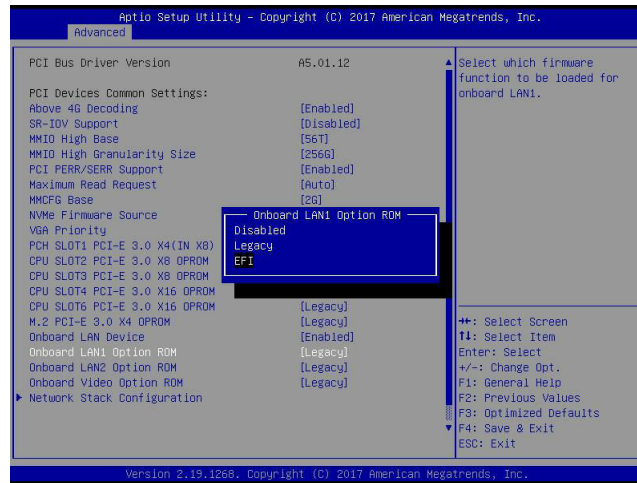

Note : If Onboard LAN1 Option ROM is set to EFI, all features for onboard LAN option ROM will be set to EFI by the EFI driver. Additionally, these features will become unavailable except Onboard LAN1 Option ROM.

For the changes to take effect, press <F4> to save the settings and exit the BIOS Setup utility. Press during system boot to enter the BIOS Setup utility. Navigate to the Advanced tab. The feature(s) for onboard Intel® LAN device(s) will become available for configuration as shown below.

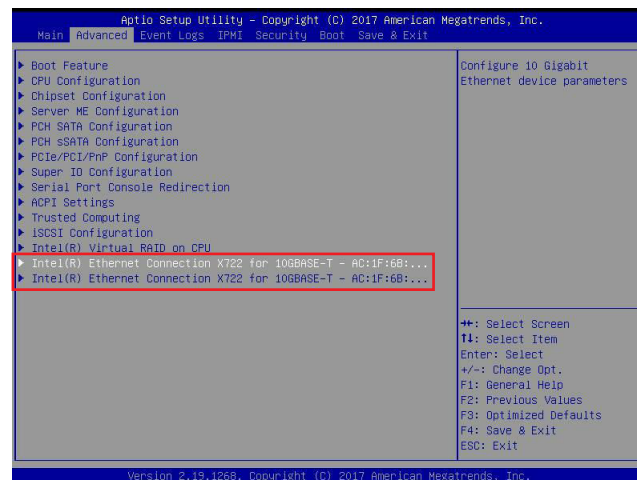

Use the arrow keys to select the desired onboard LAN device as shown below.

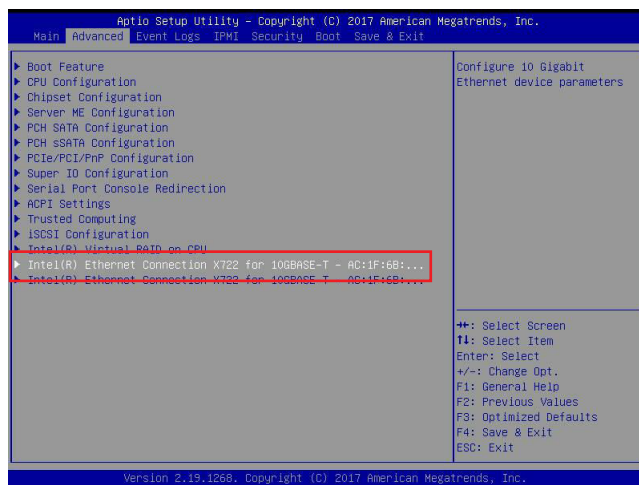

Press <Enter> and the following screen will appear. It displays the detailed information for the selected onboard LAN device.

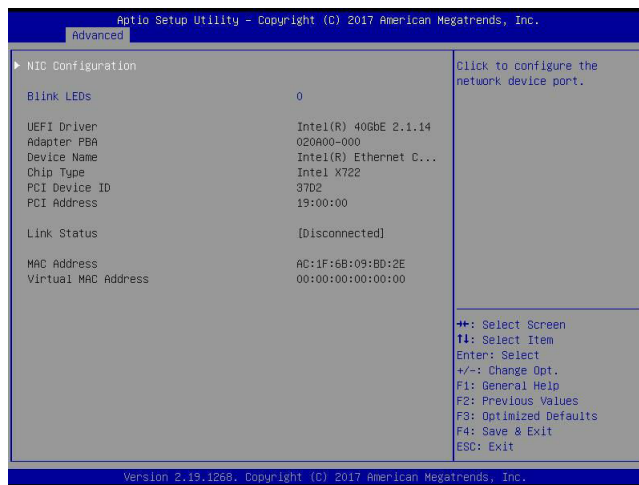

Blink LEDs

This feature allows the user to set the LED blink duration (in seconds). The valid range is 0~15 (seconds).

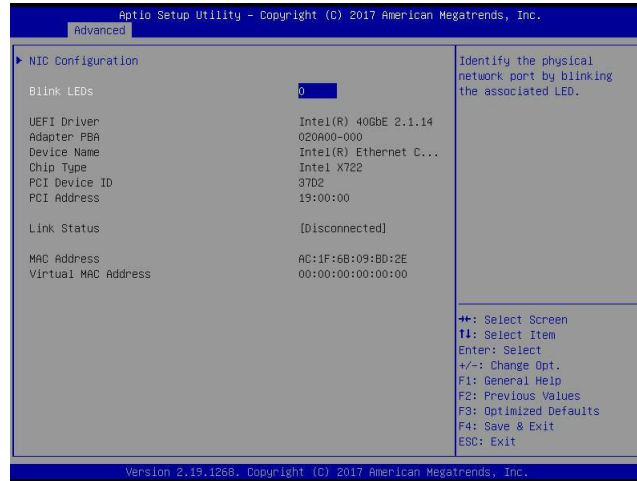

NIC Configuration

Use the arrow keys to select NIC Configuration.

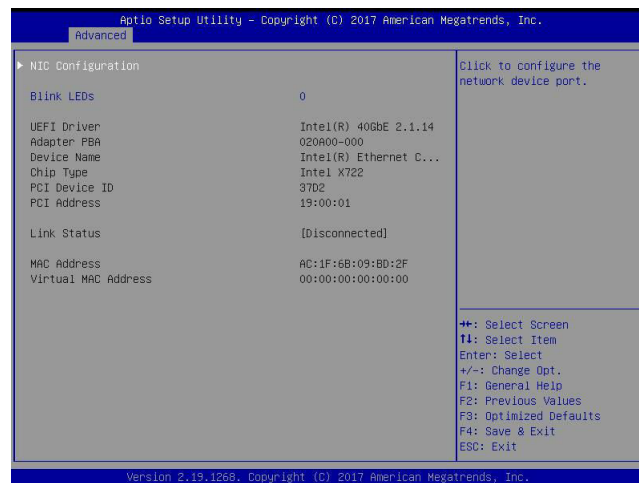

Press <Enter> and the following screen will appear.

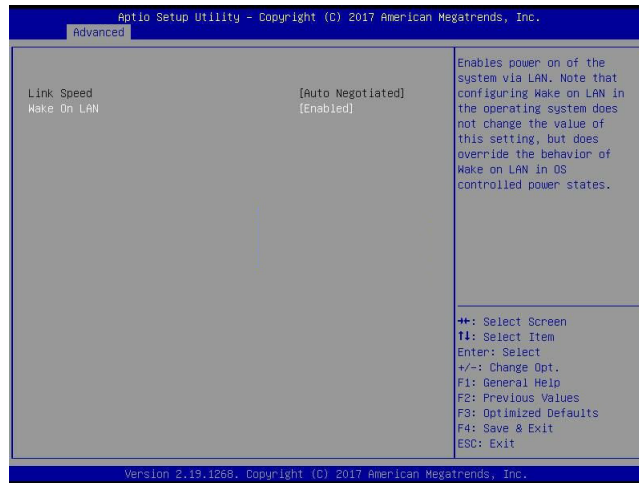

Wake on LAN

Use the arrow keys to select Wake On LAN and press <Enter>. The following screen will appear. The options are **Disabled** and Enabled. Set this feature to support system wake-up via the selected LAN device.

