

SUPERO[®]

SUPER P4DPL-8GM
SUPER P4DPL-iGM
SUPER P4DPL-M

USER'S MANUAL

Revision 1.0

The information in this User's Manual has been carefully reviewed and is believed to be accurate. The vendor assumes no responsibility for any inaccuracies that may be contained in this document, makes no commitment to update or to keep current the information in this manual, or to notify any person or organization of the updates.

Please Note: For the most up-to-date version of this manual, please see our web site at www.supermicro.com.

SUPERMICRO COMPUTER reserves the right to make changes to the product described in this manual at any time and without notice. This product, including software, if any, and documentation may not, in whole or in part, be copied, photocopied, reproduced, translated or reduced to any medium or machine without prior written consent.

IN NO EVENT WILL SUPERMICRO COMPUTER BE LIABLE FOR DIRECT, INDIRECT, SPECIAL, INCIDENTAL, OR CONSEQUENTIAL DAMAGES ARISING FROM THE USE OR INABILITY TO USE THIS PRODUCT OR DOCUMENTATION, EVEN IF ADVISED OF THE POSSIBILITY OF SUCH DAMAGES. IN PARTICULAR, THE VENDOR SHALL NOT HAVE LIABILITY FOR ANY HARDWARE, SOFTWARE, OR DATA STORED OR USED WITH THE PRODUCT, INCLUDING THE COSTS OF REPAIRING, REPLACING, INTEGRATING, INSTALLING OR RECOVERING SUCH HARDWARE, SOFTWARE, OR DATA.

Any disputes arising between manufacturer and customer shall be governed by the laws of Santa Clara County in the State of California, USA. The State of California, County of Santa Clara shall be the exclusive venue for the resolution of any such disputes. Supermicro's total liability for all claims will not exceed the price paid for the hardware product.

Unless you request and receive written permission from SUPER MICRO COMPUTER, you may not copy any part of this document.

Information in this document is subject to change without notice. Other products and companies referred to herein are trademarks or registered trademarks of their respective companies or mark holders.

Copyright © 2002 by SUPER MICRO COMPUTER INC.
All rights reserved.

Printed in the United States of America

Preface

About This Manual

This manual is written for system integrators, PC technicians and knowledgeable PC users. It provides information for the installation and use of the SUPER P4DPL-8GM/P4DPL-iGM/P4DPL-M mainboard. The SUPER P4DPL-8GM/P4DPL-iGM/P4DPL-M supports single or dual Intel® 603-pin Xeon™ 512K L2 cache processors at up to 2.8 GHz at a 400 MHz front side bus. Please refer to the support section of our web site (<http://www.supermicro.com/TechSupport.htm>) for a complete listing of supported processors. This product is intended to be professionally installed.

Manual Organization

Chapter 1 begins with a checklist of what should be included in your mainboard box, describes the features, specifications and performance of the motherboard and provides detailed information about the chipset.

Chapter 2 begins with instructions on handling static-sensitive devices. Read this chapter when you want to install the processor and memory modules and when mounting the mainboard in the chassis. Also refer to this chapter to connect the floppy and hard disk drives, SCSI drives, the IDE interfaces, the parallel and serial ports, the keyboard and mouse, the power supply and various other connections, buttons and indicators.

If you encounter any problems, see **Chapter 3**, which describes troubleshooting procedures for the video, the memory and the setup configuration stored in CMOS. For quick reference, a general FAQ [Frequently Asked Questions] section is provided. Instructions are also included for contacting technical support. In addition, you can visit our web site (at www.supermicro.com/techsupport.htm) for more detailed information.

Chapter 4 includes an introduction to PhoenixBIOS and provides detailed information on running the CMOS Setup utility.

Appendix A gives information on PhoenixBIOS POST messages.

Appendix B provides PhoenixBIOS POST codes.

Table of Contents

Preface

About This Manual	iii
Manual Organization	iii

Chapter 1: Introduction

1-1 Overview	1-1
Checklist	1-1
Contacting Supermicro	1-2
Super P4DPL-8GM/P4DPL-iGM Image	1-4
Super P4DPL-M Image	1-5
Super P4DPL-8GM/P4DPL-iGM Layout	1-6
Super P4DPL-8GM/P4DPL-iGM Quick Reference	1-7
Super P4DPL-M Layout	1-8
Super P4DPL-M Quick Reference	1-9
Motherboard Features	1-10
Intel E7500 Chipset: System Block Diagram	1-12
1-2 Chipset Overview	1-13
1-3 Special Features	1-13
ATI Graphics Controller	1-13
BIOS Recovery	1-13
Recovery from AC Power Loss	1-14
1-4 PC Health Monitoring	1-14
1-5 ACPI Features	1-15
1-6 Power Supply	1-17
1-7 Super I/O	1-18

Chapter 2: Installation

2-1 Static-Sensitive Devices	2-1
Precautions	2-1
Unpacking	2-1
2-2 PGA Processor and Heatsink Installation	2-2
2-3 Installing DIMMs	2-5
2-4 I/O Ports/Control Panel Connectors	2-6
2-5 Connecting Cables	2-8
ATX Power Connector	2-8
Processor Power Connector	2-8
NMI Button	2-8
Power LED	2-8

HDD LED	2-9
NIC1 LED	2-9
NIC2 LED	2-9
Overheat LED	2-9
Power Fail Button	2-9
Reset Button	2-10
Power Button	2-10
Chassis Intrusion	2-10
Universal Serial Bus (USB0/1)	2-10
Extra Universal Serial Bus Headers	2-11
Serial Ports	2-11
LAN (Ethernet) Ports	2-11
ATX PS/2 Keyboard and Mouse Ports	2-11
Fan Headers	2-12
Power LED/Speaker (JD1)	2-12
Power Supply Fail Header	2-12
Keylock	2-13
Wake-On-LAN	2-13
Wake-On-Ring	2-13
2-6 Jumper Settings	2-14
Explanation of Jumpers	2-14
CMOS Clear	2-14
Mb LAN Enable/Disable	2-15
Gb LAN Enable/Disable	2-15
VGA Enable/Disable	2-15
Power Supply Alarm Enable/Disable	2-15
SCSI Enable/Disable	2-16
SCSI Termination Enable/Disable	2-16
Watch Dog Enable/Disable	2-16
2-7 Onboard Indicators	2-17
Gb LAN LEDs	2-17
2-8 Parallel Port, Floppy/Hard Disk Drive and SCSI Connections	2-17
Parallel Port Connector	2-17
Floppy Connector	2-18
IDE Connectors	2-18
Ultra320 SCSI Connectors	2-19
2-8 Installing Software Drivers	2-20

Chapter 3: Troubleshooting

3-1	Troubleshooting Procedures	3-1
	Before Power On	3-1
	No Power	3-1
	No Video	3-1
	Memory Errors	3-2
	Losing the System's Setup Configuration	3-2
3-2	Technical Support Procedures	3-2
3-3	Frequently Asked Questions	3-3
3-4	Returning Merchandise for Service	3-5

Chapter 4: PhoenixBIOS

4-1	Introduction	4-1
4-2	Running Setup	4-2
4-3	Main Setup	4-2
4-4	Advanced Setup	4-6
4-5	Security Setup	4-15
4-6	Power Setup	4-17
4-7	Boot Setup	4-18
4-8	PIR Setup	4-20
4-9	Exit	4-22

Appendices:

Appendix A:	BIOS POST Messages	A-1
Appendix B:	BIOS POST Codes	B-1

Chapter 1

Introduction

1-1 Overview

Checklist

Congratulations on purchasing your computer motherboard from an acknowledged leader in the industry. Supermicro boards are designed with the utmost attention to detail to provide you with the highest standards in quality and performance.

Please check that the following items have all been included with your motherboard. If anything listed here is damaged or missing, contact your retailer.

One (1) Supermicro Mainboard

One (1) ribbon cable for IDE devices

One (1) floppy ribbon cable

One (1) I/O backpanel shield

One (1) Supermicro CD or diskettes containing drivers and utilities

One (1) User's/BIOS Manual

Two (2) Pentium 4 Xeon active heatsinks (FAN-042, retail only)

Two (2) heatsink retention clips (SKT-095)

SCSI Accessories (P4DPL-8GM only)

One (1) 68-pin LVD SCSI cable

One (1) set of SCSI driver diskettes

One (1) SCSI manual

Contacting Supermicro

Headquarters

Address: SuperMicro Computer, Inc.
980 Rock Ave.
San Jose, CA 95131 U.S.A.

Tel: +1 (408) 503-8000

Fax: +1 (408) 503-8008

Email: marketing@supermicro.com (General Information)
support@supermicro.com (Technical Support)

Web Site: www.supermicro.com

Europe

Address: SuperMicro Computer B.V.
Het Sterrenbeeld 28, 5215 ML
's-Hertogenbosch, The Netherlands

Tel: +31 (0) 73-6400390

Fax: +31 (0) 73-6416525

Email: sales@supermicro.nl (General Information)
support@supermicro.nl (Technical Support)
rma@supermicro.nl (Customer Support)

Asia-Pacific

Address: SuperMicro, Taiwan
D5, 4F, No. 16 Chien-Ba Road
Chung-Ho 235, Taipei Hsien, Taiwan, R.O.C.

Tel: +886-(2) 8226-3990

Fax: +886-(2) 8226-3991

Web Site: www.supermicro.com.tw

Technical Support:

Email: support@supermicro.com.tw

Tel: 886-2-8226-3990, ext.132 or 139

Notes

Figure 1-1. SUPER P4DPL-8GM/P4DPL-iGM Image

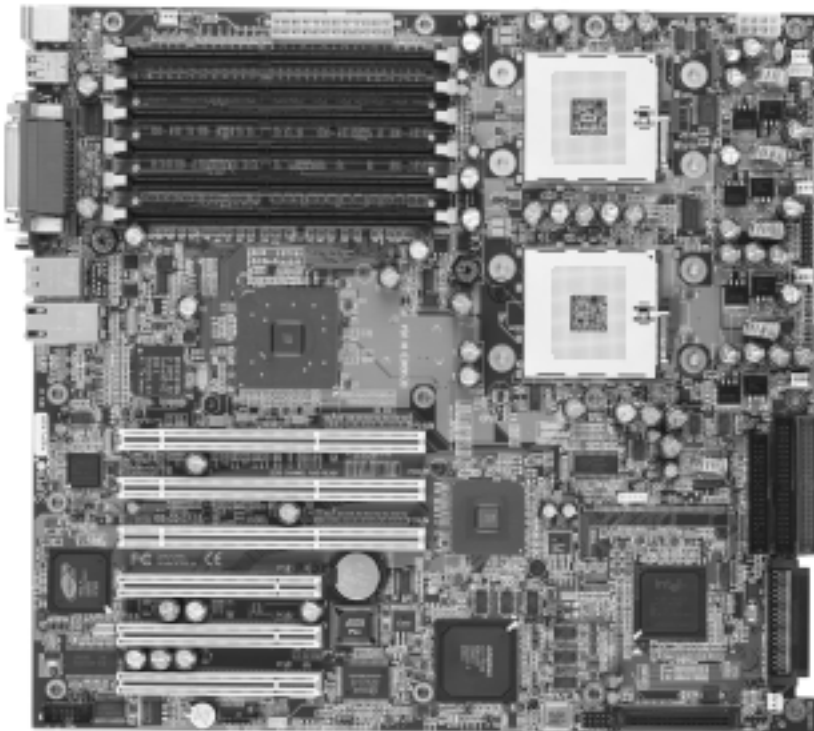

Figure 1-2. SUPER P4DPL-M Image

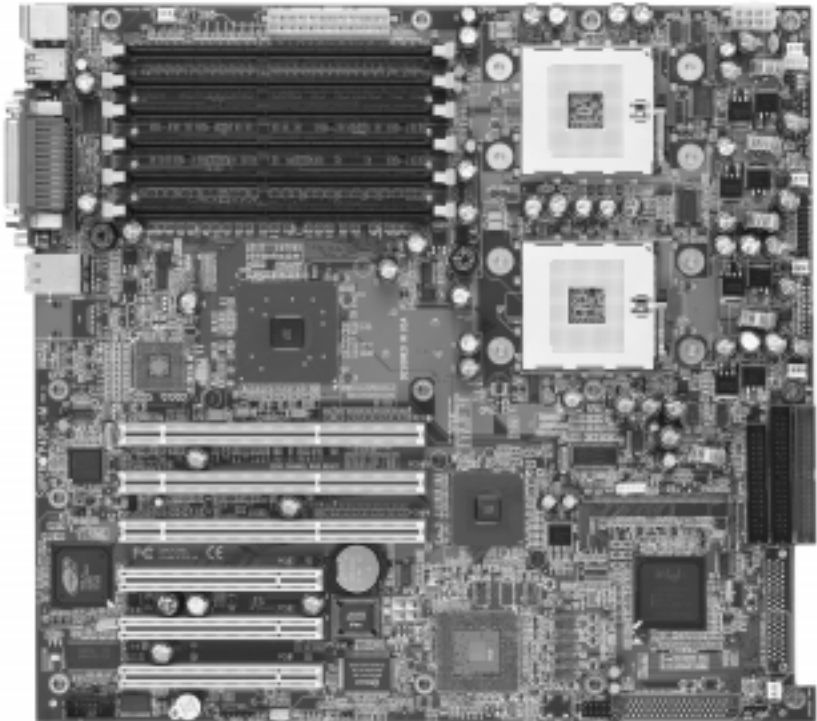
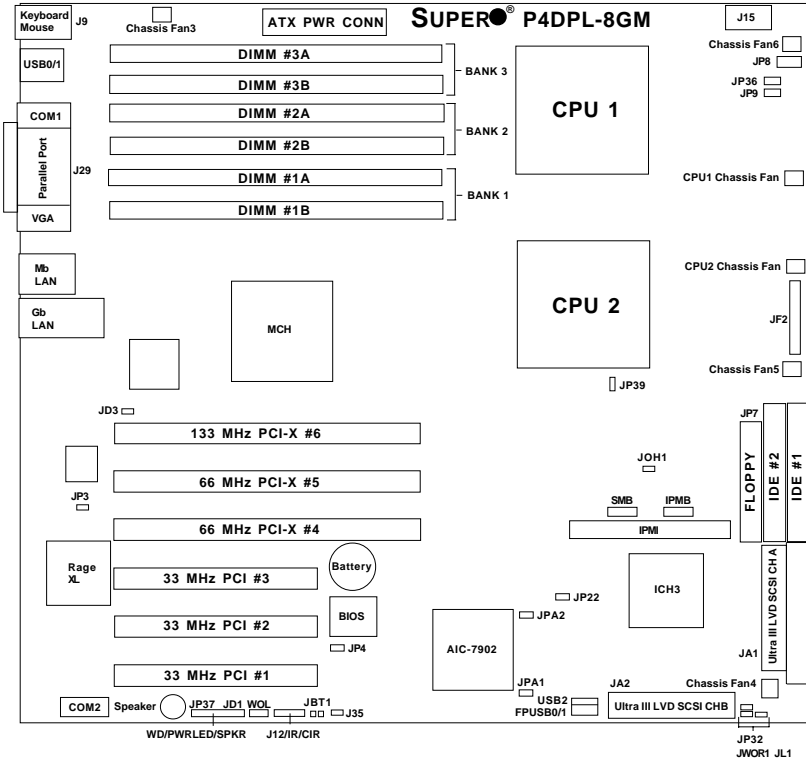

Figure 1-3. SUPER P4DPL-8GM/P4DPL-iGM Layout*
(not drawn to scale)



The IPMI socket is an optional feature.

Jumpers not noted are for test purposes only.

***Note:**

The P4DPL-iGM has the same layout as the P4DPL-8GM but with no SCSI.

P4DPL-8GM/P4DPL-iGM Quick Reference

<u>Jumper</u>	<u>Description</u>	<u>Default Setting</u>
JBT1	CMOS Clear	See Section 2-6
JP3/JD3	Mb/Gb LAN Enable/Disable	Pins 1-2 (Enabled)
JP4	VGA Enable/Disable	Pins 1-2 (Enabled)
JP9	3rd P/S Fail Alarm En/Dis	Open (Disabled)
JP22*	SCSI Enable/Disable	Pins 1-2 (Enabled)
JP37	Watch Dog Enable/Disable	Open (Disabled)
JPA1/JPA2*	SCSI CH A/B Termination	Open (Enabled)

<u>Connector</u>	<u>Description</u>
ATX PWR CONN	Primary ATX Power Connector
DIMM#1A-DIMM#3B	Memory (RAM) Slots
COM1/COM2	COM1/COM2 Serial Port Connector
CPU/Chassis FAN	CPU/Chassis Fan Headers
Gb LAN	Gb LAN (Ethernet) Port
IDE#1/IDE#2	IDE #1/#2 Hard Disk Drive Connectors
FPUSB0/1	Front Side USB0/1 Headers
J9	PS/2 Keyboard/Mouse Ports
J15**	Processor Power Connector
J29	Parallel (Printer) Port
JA1*	Ultra320 LVD SCSI CH A Connector
JA2*	Ultra320 LVD SCSI CH B Connector
JD1	PWR LED Header / Speaker Header/Jumper
JF2	Front Control Panel Connector
JL1	Chassis Intrusion Header
JOH1	Overheat LED
JP7	Floppy Disk Drive Connector
JP8	Third Power Supply Fail Header
JP35	Keylock Switch Connector
JP36	3rd Power Supply Alarm Reset Switch
JWOR1	Wake-on-Ring Header
Mb LAN	Mb LAN (Ethernet) Port
Speaker	Onboard Speaker Header
USB2	USB2 Header
VGA	VGA Display (Monitor) Port
WOL	Wake-on-LAN Header

* P4DPL-8GM only

** The 12v 8-pin processor power connector at J15 must also be connected to your power supply.

Figure 1-4. SUPER P4DPL-M Layout
(not drawn to scale)

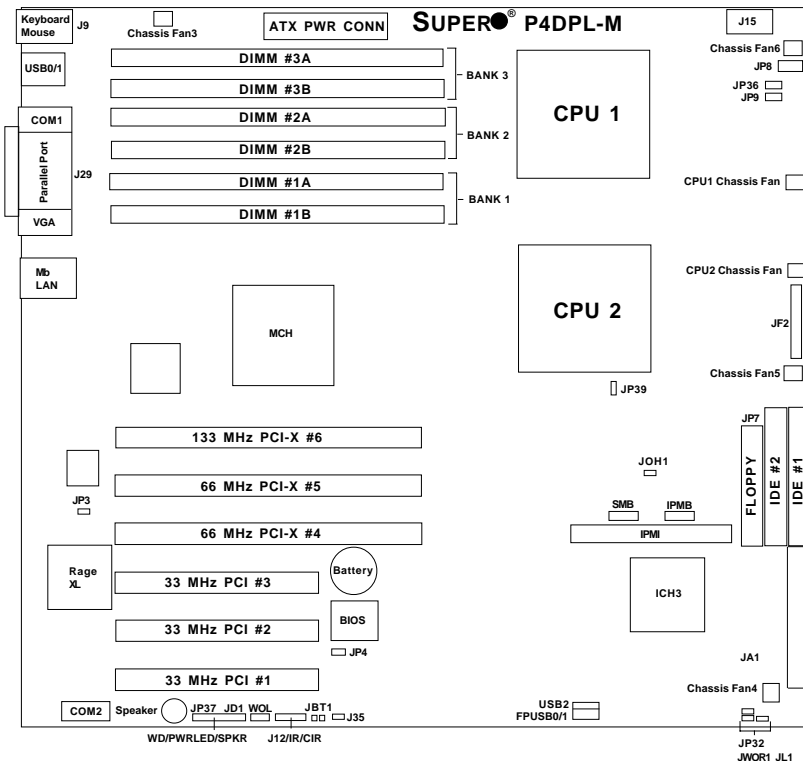

The IPMI socket is an optional feature.

Jumpers not noted are for test purposes only.

P4DPL-M Quick Reference

<u>Jumper</u>	<u>Description</u>	<u>Default Setting</u>
JBT1	CMOS Clear	See Section 2-6
JP3	Mb LAN Enable/Disable	Pins 1-2 (Enabled)
JP4	VGA Enable/Disable	Pins 1-2 (Enabled)
JP9	3rd P/S Fail Alarm En/Dis	Open (Disabled)
JP37	Watch Dog Enable/Disable	Open (Disabled)

<u>Connector</u>	<u>Description</u>
ATX PWR CONN	Primary ATX Power Connector
DIMM#1A-DIMM#3B	Memory (RAM) Slots
COM1/COM2	COM1/COM2 Serial Port Connector
CPU/Chassis FAN	CPU/Chassis Fan Headers
IDE#1/IDE#2	IDE #1/#2 Hard Disk Drive Connectors
FPUSB0/1	Front Side USB0/1 Headers
J9	PS/2 Keyboard/Mouse Ports
J15*	Processor Power Connector
J29	Parallel (Printer) Port
JD1	PWR LED Header / Speaker Header/Jumper
JF2	Front Control Panel Connector
JL1	Chassis Intrusion Header
JOH1	Overheat LED
JP7	Floppy Disk Drive Connector
JP8	Third Power Supply Fail Header
JP35	Keylock Switch Connector
JP36	3rd Power Supply Alarm Reset Switch
JWOR1	Wake-on-Ring Header
Mb LAN	Mb LAN (Ethernet) Port
Speaker	Onboard Speaker Header
USB2	USB2 Header
VGA	VGA Display (Monitor) Port
WOL	Wake-on-LAN Header

* The 12v 8-pin processor power connector at J15 must also be connected to your power supply.

Motherboard Features

CPU

- Single or dual Intel® 603-pin Xeon™ 512K L2 cache processors at up to 2.8 GHz at a 400 MHz front side (system) bus speed.

Note: Please refer to the support section of our web site for a complete listing of supported processors (<http://www.supermicro.com/TechSupport.htm>).

Memory

- Six 184-pin DDR DIMM sockets supporting up to 12 GB of registered ECC PC1600 (DDR-200) DDR SDRAM

Note: Interleaved memory; requires memory modules to be installed in pairs. PC2100 (DDR-266) memory is supported but will only run at 200 MHz. See Section 2-3 for details.

Chipset

- Intel E7500 (Plumas) chipset

Expansion Slots

- One 64-bit, 133 MHz PCI-X
- Two 64-bit, 100 MHz PCI-X
- Three 32-bit, 33 MHz PCI

BIOS

- 4 Mb Phoenix® Flash ROM
- APM 1.2, DMI 2.1, PCI 2.2, ACPI 1.0, Plug and Play (PnP), SMBIOS 2.3

PC Health Monitoring

- Onboard voltage monitors for CPU cores, chipset voltage, 3.3V, +5V, +12V and 3.3V standby
- Fan status monitor with firmware/software on/off control
- CPU/chassis temperature monitors
- Environmental temperature monitor and control
- CPU fan auto-off in sleep mode
- CPU slow-down on temperature overheat
- CPU overheat LED header
- Power-up mode control for recovery from AC power loss
- Auto-switching voltage regulator for CPU core
- Chassis intrusion detection
- System resource alert

ACPI/PC 98 Features (optional)

- Microsoft OnNow
- Slow blinking LED for suspend state indicator
- Main switch override mechanism
- External modem ring-on

Onboard I/O

- AIC-7902 for dual channel Ultra320 SCSI (P4DPL-8GM only)
- Integrated ATI Rage XL graphics controller
- One Intel 82550 10/100 Mb fast Ethernet and one Intel 82545EM Gb Ethernet port (P4DPL-8GM/P4DPL-iGM)
- One Intel 82550 10/100 Mb fast Ethernet port (P4DPL-M)
- 2 EIDE Ultra DMA/100 bus master interfaces
- 1 floppy port interface (up to 2.88 MB)
- 2 Fast UART 16550A compatible serial ports
- 1 EPP/ECP Parallel Port (Enhanced Parallel Port/Extended Capabilities Port)
- PS/2 mouse and PS/2 keyboard ports
- Two USB (Universal Serial Bus) ports, three USB headers (USB 1.1)

Other

- Internal/external modem ring-on
- Recovery from AC power loss control
- Wake-on-LAN (WOL)
- Console redirection
- IPMI (optional)

CD/Diskette Utilities

- BIOS flash upgrade utility
- Device drivers

Dimensions

- P4DPL-8GM: Extended ATX, 12" x 13.05" (304.8 x 331.5 mm)
- P4DPL-iGM: Extended ATX, 12" x 13.05" (304.8 x 331.5 mm)
- P4DPL-M: Extended ATX, 12" x 13.05" (304.8 x 331.5 mm)

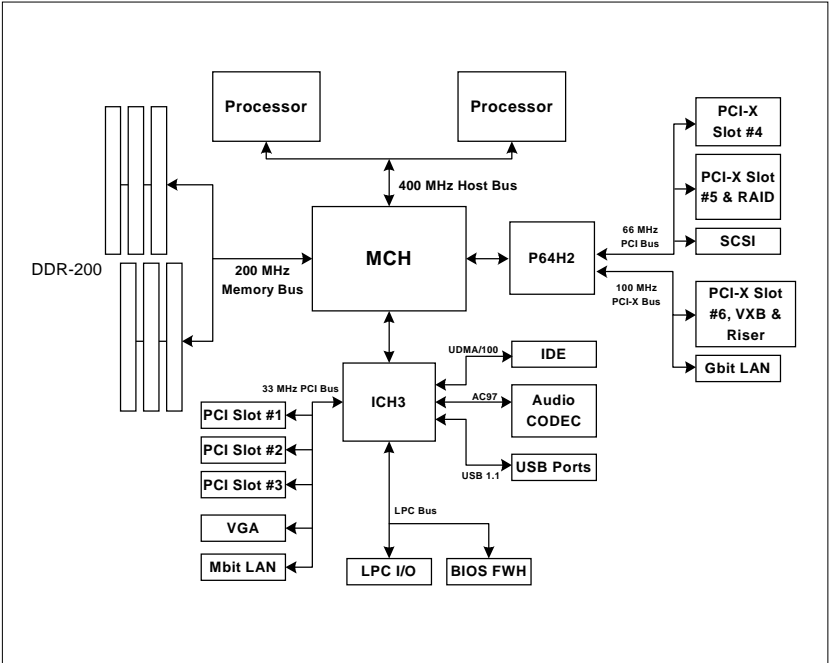

**Figure 1-5. Intel E7500 Chipset:
System Block Diagram**

Note: This is a general block diagram. Please see the previous Motherboard Features pages for details on the features of each motherboard. (Because the P4DPL-iGM and P4DPL-M have no onboard SCSI controller, PCI-X slots #4 and 5 run on a 100 MHz PCI-X bus.)

1-2 Chipset Overview

The Intel E7500 (Plumas) chipset is a high-performance chipset with a performance and feature-set designed for mid-range, dual processor servers. The E7500 chipset consists of four major components: the Memory Controller Hub (MCH), the I/O Controller Hub 3 (ICH3), the PCI-X 64-bit Hub 2.0 (P64H2) and the 82808AA Host Channel Adapter (VxB).

The MCH has four hub interfaces, one to communicate with the ICH3 and three for high-speed I/O communications. The MCH employs a 144-bit wide memory bus for a DDR-200 memory interface, which provides a total bandwidth of 3.2 GB/s. The ICH3 interface is a 266 MB/sec point-to-point connection using an 8-bit wide, 66 MHz base clock at a 4x data transfer rate. The P64H2 interface is a 1 GB/s point-to-point connection using a 16-bit wide, 66 MHz base clock at a 8x data transfer rate.

The ICH3 I/O Controller Hub provides various integrated functions, including a two-channel UDMA100 bus master IDE controller, USB host controllers, an integrated LAN controller, a System Management Bus controller and an AC'97 compliant interface.

The P64H2 PCI-X Hub provides a 16-bit connection to the MCH for high-performance I/O capability and two 64-bit PCI-X interfaces.

1-3 Special Features

ATI Graphics Controller

The P4DPL-8GM/P4DPL-iGM/P4DPL-M has an integrated ATI video controller based on the Rage XL graphics chip. The Rage XL fully supports sideband addressing and AGP texturing. This onboard graphics package can provide a bandwidth of up to 512 MB/sec over a 32-bit graphics memory bus.

BIOS Recovery

The BIOS Recovery function allows you to recover your BIOS image file if the BIOS flashing procedure fails (see Section 3-3).

Recovery from AC Power Loss

BIOS provides a setting for you to determine how the system will respond when AC power is lost and then restored to the system. You can choose for the system to remain powered off (in which case you must hit the power switch to turn it back on) or for it to automatically return to a power-on state. See the Power Lost Control setting in the Advanced BIOS Setup section (Peripheral Device Configuration) to change this setting. The default setting is Always On.

1-4 PC Health Monitoring

This section describes the PC health monitoring features of the SUPER P4DPL-8GM/P4DPL-iGM/P4DPL-M. The motherboard has an onboard System Hardware Monitor chip that supports PC health monitoring.

Onboard Voltage Monitors for the CPU Cores, Chipset Voltage, +3.3V, +5V, +12V and +3.3V Standby

An onboard voltage monitor will scan these voltages continuously. Once a voltage becomes unstable, a warning is given or an error message is sent to the screen. Users can adjust the voltage thresholds to define the sensitivity of the voltage monitor.

Fan Status Monitor with Firmware/Software On/Off Control

The PC health monitor can check the RPM status of the cooling fans. The onboard 3-pin CPU and chassis fans are controlled by the power management functions. The thermal fan is controlled by the overheat detection logic.

Environmental Temperature Control

The thermal control sensor monitors the CPU temperature in real time and will turn on the thermal control fan whenever the CPU temperature exceeds a threshold. The overheat circuitry runs independently from the CPU. It can continue to monitor for overheat conditions even when the CPU is in sleep mode. Once it detects that the CPU temperature is too high, it will automatically turn on the thermal control fan to prevent any overheat damage to the CPU. The onboard chassis thermal circuitry can monitor the overall system temperature and alert users when the chassis temperature is too high.

CPU Fan Auto-Off in Sleep Mode

The CPU fan activates when the power is turned on. It continues to operate when the system enters Standby mode. When in sleep mode, the CPU will not run at full power, thereby generating less heat.

CPU Overheat LED

JOH1 is a header used to connect to a CPU overheat LED. When the CPU temperature becomes too high, both the overheat fan and the warning LED are activated.

System Resource Alert

This feature is available when used with Intel's LANDesk Client Manager (optional). LDCM is used to notify the user of certain system events. For example, if the system is running low on virtual memory and there is insufficient hard drive space for saving the data, you can be alerted of the potential problem.

Auto-Switching Voltage Regulator for the CPU Core

The auto-switching voltage regulator for the CPU core can support up to 20A current and auto-sense voltage IDs ranging from 1.4V to 3.5V. This will allow the regulator to run cooler and thus make the system more stable.

1-5 ACPI Features

ACPI stands for Advanced Configuration and Power Interface. The ACPI specification defines a flexible and abstract hardware interface that provides a standard way to integrate power management features throughout a PC system, including its hardware, operating system and application software. This enables the system to automatically turn on and off peripherals such as CD-ROMs, network cards, hard disk drives and printers. This also includes consumer devices connected to the PC such as VCRs, TVs, telephones and stereos.

In addition to enabling operating system-directed power management, ACPI provides a generic system event mechanism for Plug and Play and an operating system-independent interface for configuration control. ACPI leverages the Plug and Play BIOS data structures while providing a processor architecture-independent implementation that is compatible with both Windows 2000 and Windows NT 5.0.

Microsoft OnNow

The OnNow design initiative is a comprehensive, system-wide approach to system and device power control. OnNow is a term for a PC that is always on but appears to be off and responds immediately to user or other requests.

Slow Blinking LED for Suspend-State Indicator

When the CPU goes into a suspend state, the chassis power LED will start blinking to indicate that the CPU is in suspend mode. When the user presses any key, the CPU will wake-up and the LED will automatically stop blinking and remain on.

Main Switch Override Mechanism

When an ATX power supply is used, the power button can function as a system suspend button to make the system enter a SoftOff state. The monitor will be suspended and the hard drive will spin down. Depressing the power button again will cause the whole system to wake-up. During the SoftOff state, the ATX power supply provides power to keep the required circuitry in the system alive. In case the system malfunctions and you want to turn off the power, just depress and hold the power button for 4 seconds. This option can be set in the Power section of the BIOS Setup routine.

External Modem Ring-On

Wake-up events can be triggered by a device such as the external modem ringing when the system is in the SoftOff state. Note that external modem ring-on can only be used with an ATX 2.01 (or above) compliant power supply.

Wake-On-LAN (WOL)

Wake-On-LAN is defined as the ability of a management application to remotely power up a computer that is powered off. Remote PC setup, updates and asset tracking can occur after hours and on weekends so that daily LAN traffic is kept to a minimum and users are not interrupted. The motherboards have a 3-pin header (WOL) to connect to the 3-pin header on a Network Interface Card (NIC) that has WOL capability. Wake-On-LAN must be enabled in BIOS. Note that Wake-On-Lan can only be used with an ATX 2.01 (or above) compliant power supply.

1-6 Power Supply

As with all computer products, a stable power source is necessary for proper and reliable operation. It is even more important for processors that have high CPU clock rates.

The SUPER P4DPL-8GM/P4DPL-iGM/P4DPL-M accommodates ATX power supplies. Although most power supplies generally meet the specifications required by the CPU, some are inadequate. You should use one that will supply at least 400W of power and includes the additional +12V, 8-pin power connector - an even higher wattage power supply is recommended for high-load configurations. Also your power supply must provide 1.5A, which is needed for the LAN port(s).

NOTE: The processor 12v power connector (J15) is necessary to support Intel Xeon CPUs. Failure to provide this extra power will result in the CPUs becoming unstable after only a few minutes of operation. See Section 2-5 for details on connecting the power supply cables.

It is strongly recommended that you use a high quality power supply that meets ATX power supply Specification 2.02 or above. It must also be SSI compliant (info at <http://www.ssiforum.org/>). Additionally, in areas where noisy power transmission is present, you may choose to install a line filter to shield the computer from noise. It is recommended that you also install a power surge protector to help avoid problems caused by power surges.

1-7 Super I/O

The disk drive adapter functions of the Super I/O chip include a floppy disk drive controller that is compatible with industry standard 82077/765, a data separator, write pre-compensation circuitry, decode logic, data rate selection, a clock generator, drive interface control logic and interrupt and DMA logic. The wide range of functions integrated onto the Super I/O greatly reduces the number of components required for interfacing with floppy disk drives. The Super I/O supports 360 K, 720 K, 1.2 M, 1.44 M or 2.88 M disk drives and data transfer rates of 250 Kb/s, 500 Kb/s or 1 Mb/s. It also provides two high-speed, 16550 compatible serial communication ports (UARTs), one of which supports serial infrared communication. Each UART includes a 16-byte send/receive FIFO, a programmable baud rate generator, complete modem control capability and a processor interrupt system. Each UART includes a 16-byte send/receive FIFO, a programmable baud rate generator, complete modem control capability and a processor interrupt system. Both UARTs provide legacy speed with baud rate of up to 115.2 Kbps as well as an advanced speed with baud rates of 250 K, 500 K, or 1 Mb/s, which support higher speed modems.

The Super I/O supports one PC-compatible printer port (SPP), Bi-directional Printer Port (BPP), Enhanced Parallel Port (EPP) or Extended Capabilities Port (ECP).

The Super I/O provides functions that comply with ACPI (Advanced Configuration and Power Interface), which includes support of legacy and ACPI power management through an SMI or SCI function pin. It also features auto power management to reduce power consumption.

The IRQs, DMAs and I/O space resources of the Super I/O can flexibly adjust to meet ISA PnP requirements, which support ACPI and APM (Advanced Power Management).

Chapter 2 Installation

2-1 Static-Sensitive Devices

Electric-Static-Discharge (ESD) can damage electronic components. To prevent damage to your system board, it is important to handle it very carefully. The following measures are generally sufficient to protect your equipment from ESD.

Precautions

- Use a grounded wrist strap designed to prevent static discharge.
- Touch a grounded metal object before removing the board from the anti-static bag.
- Handle the board by its edges only; do not touch its components, peripheral chips, memory modules or gold contacts.
- When handling chips or modules, avoid touching their pins.
- Put the motherboard and peripherals back into their antistatic bags when not in use.
- For grounding purposes, make sure your computer chassis provides excellent conductivity between the power supply, the case, the mounting fasteners and the motherboard.

Unpacking

The motherboard is shipped in antistatic packaging to avoid static damage. When unpacking the board, make sure the person handling it is static protected.

2-2 PGA Processor and Heatsink Installation



When handling the processor package, avoid placing direct pressure on the label area of the fan. Also, do not place the motherboard on a conductive surface, which can damage the BIOS battery and prevent the system from booting up.

IMPORTANT: Always connect the power cord last and always remove it before adding, removing or changing any hardware components. Make sure that you install the processor into the CPU socket **before** you install the CPU heat sink.

1. Locate the following components, which are included in the shipping package. The amounts shown are for each CPU.

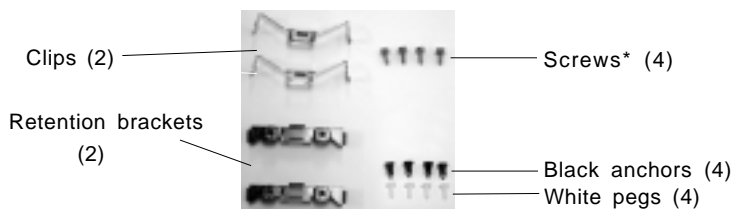

*These screws are for mounting the motherboard to the back panel of a chassis that has four mounting holes (as shown on right).

For chassis that do not have four mounting holes, use the anchor/peg assemblies:



2. Insert the white pegs into the black anchors. Do not force the white pegs all the way in - only about 1/3 of the way into the black anchors.

Anchor/peg assemblies



3. Place a retention bracket in the proper position and secure it by pressing pegs into two of the retention holes until you hear a *click*. The clicking sound indicates that the peg is locked and secured.

Two pegs in position



One retention bracket in position

4. Secure the other retention bracket into position by repeating Step 3.



5. Lift the lever on the CPU socket: lift the lever completely or you will damage the CPU socket when power is applied. (Install CPU1 first.)

Socket lever



6. Install the CPU in the socket. Make sure that pin 1 of the CPU is seated on pin 1 of the socket (both corners are marked with a triangle). When using only one CPU, install it into CPU socket #1 (CPU socket #2 is automatically disabled if only one CPU is used).

Pin 1

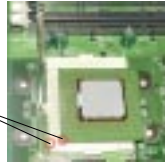

7. Press the lever down until you hear it *click* into the locked position.

Socket lever in locked position

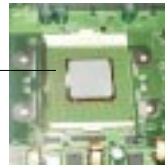

8. Apply the proper amount of thermal glue to the CPU die and place the heatsink and fan on top of the CPU.

Heatsink

CPU



9. Secure the heatsink by locking the retention clips into their proper position.

Retention clip



10. Connect the three wires of the CPU fan to the respective CPU fan connector.

CPU fan wires

CPU fan connector

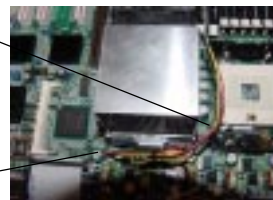
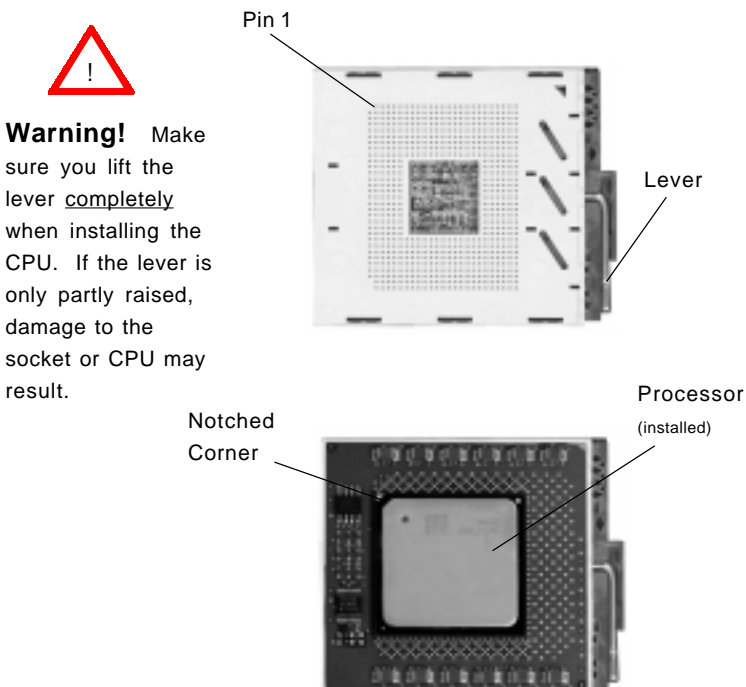

Figure 2-1. PGA603 Socket: Empty and with Processor Installed



Warning! Make sure you lift the lever completely when installing the CPU. If the lever is only partly raised, damage to the socket or CPU may result.

Mounting the Motherboard in the Chassis

All motherboards have standard mounting holes to fit different types of chassis. Make sure the location of all the mounting holes for both the motherboard and the chassis match. Although a chassis may have both plastic and metal mounting fasteners, metal ones are highly recommended because they ground the motherboard to the chassis. Make sure the metal standoffs click in or are screwed in tightly. Then use a screwdriver to secure the motherboard onto the motherboard tray.

2-3 Installing DIMMs

Note: Check the Supermicro web site for recommended memory modules:
http://www.supermicro.com/TECHSUPPORT/FAQs/Memory_vendors.htm

CAUTION

Exercise extreme care when installing or removing DIMM modules to prevent any possible damage. Also note that the memory is interleaved to improve performance (see step 1).

DIMM Installation (See Figure 2-2)

1. Insert the desired number of DIMMs into the memory slots, starting with Bank 1. The memory scheme is interleaved so you must install two modules at a time, beginning with Bank 1, then Bank 2, then Bank 3.
2. Insert each DIMM module vertically into its slot. Pay attention to the notch along the bottom of the module to prevent inserting the DIMM module incorrectly.
3. Gently press down on the DIMM module until it snaps into place in the slot. Repeat for all modules (see step 1 above).

Memory Support

The P4DPL-8GM/P4DPL-iGM/P4DPL-M only supports ECC registered PC1600 (DDR-200) memory. PC2100 (DDR-266) is supported but only at 200 MHz (PC1600 speed). PC100/133 SDRAM is not supported.

Figure 2-2. Installing and Removing DIMMs

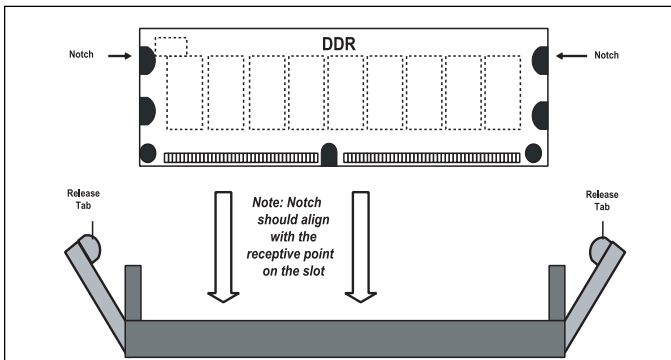

To Install: Insert module vertically and press down until it snaps into place. Pay attention to the notches.

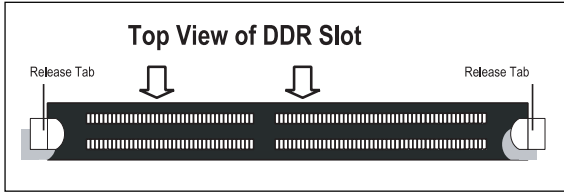

To Remove:

Use your thumbs to gently push near the edge of both ends of the module. This should release it from the slot.

2-4 I/O Ports/Control Panel Connectors

The I/O ports are color coded in conformance with the PC 99 specification. See Figure 2-3 below for the colors and locations of the various I/O ports.

Figure 2-3. I/O Port Locations and Definitions

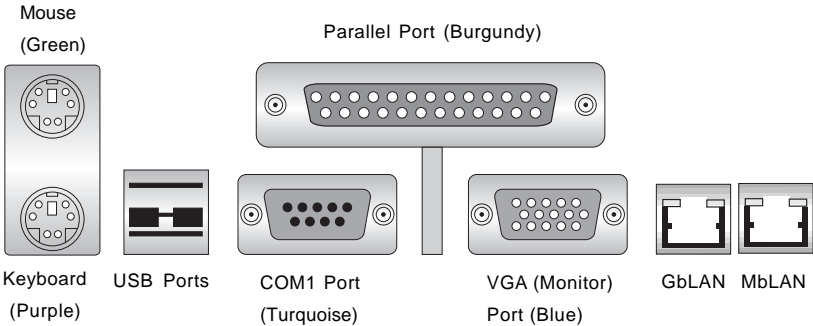

Note: The GbLAN port is not included on the P4DPL-M.

COM2 is a header located on the motherboard - see the motherboard layout pages in Chapter 1 for location.

Front Control Panel

JF2 contains header pins for various buttons and indicators that are normally located on a control panel at the front of the chassis. These connectors are designed especially for use with Supermicro server chassis. See Figure 2-4 for the descriptions of the various control panel buttons and LED indicators. Refer to the following section for descriptions and pin definitions.

Figure 2-4. JF2 Header Pins

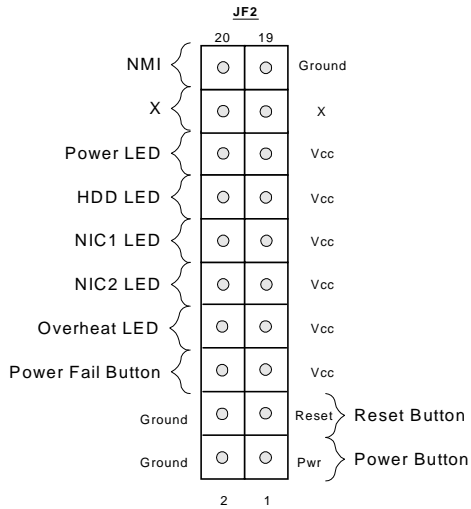

2-5 Connecting Cables

ATX Power Connector

The main power supply connector meets the SSI (Superset ATX) 24-pin specification, however it also supports a 20-pin power supply connector. Make sure that the orientation of the PS connector is correct.

ATX Power Supply 24-pin Connector
Pin Definitions

Pin Number	Definition	Pin Number	Definition
13	+3.3V	1	+3.3V
14	-12V	2	+3.3V
15	COM	3	COM
16	PS_ON#	4	+5V
17	COM	5	COM
18	COM	6	+5V
19	COM	7	COM
20	Res(NC)	8	PWR_OK
21	+5V	9	5VSB
22	+5V	10	+12V
23	+5V	11	+12V
24	COM	12	+3.3V

Processor Power Connector

In addition to the Primary ATX power connector (above), the 12v 8-pin Processor Power Connector at J15 must also be connected to your power supply. See the table on the right for pin definitions.

Processor Power
Connector (J15)

Pins	Definition
1 thru 4	Ground
5 thru 8	+12v

NMI Button

The non-maskable interrupt button header is located on pins 19 and 20 of JF2. Refer to the table on the right for pin definitions.

NMI Button Pin
Definitions (JF2)

Pin Number	Definition
19	Ground
20	Control

Power LED

The Power LED connection is located on pins 15 and 16 of JF2. Refer to the table on the right for pin definitions.

PWR_LED Pin Definitions
(JF2)

Pin Number	Definition
15	Vcc
16	Control

HDD LED

The HDD LED (for IDE Hard Disk Drives) connection is located on pins 13 and 14 of JF2. Attach the IDE hard drive LED cable to these pins to display disk activity. Refer to the table on the right for pin definitions.

**HDD LED Pin
Definitions
(JF2)**

Pin Number	Definition
13	Vcc
14	HD Active

NIC1 LED

The NIC1 (Network Interface Controller) LED connection is located on pins 11 and 12 of JF2. Attach the NIC1 LED cable to display network activity. Refer to the table on the right for pin definitions.

**NIC1 LED Pin
Definitions
(JF2)**

Pin Number	Definition
11	Vcc
12	GND

NIC2 LED

The NIC2 (Network Interface Controller) LED connection is located on pins 9 and 10 of JF2. Attach the NIC2 LED cable to display network activity. Refer to the table on the right for pin definitions.

**NIC2 LED Pin
Definitions
(JF2)**

Pin Number	Definition
9	Vcc
10	GND

Overheat LED (OH)

Connect an LED to the OH connection on pins 7 and 8 of JF2 to provide advanced warning of chassis overheating. Refer to the table on the right for pin definitions.

**Overheat (OH) LED
Pin Definitions
(JF2)**

Pin Number	Definition
7	Vcc
8	GND

Power Fail Button

The Power Fail Button connection is located on pins 5 and 6 of JF2. Refer to the table on the right for pin definitions.

**Power Fail Button
Pin Definitions
(JF2)**

Pin Number	Definition
5	Vcc
6	GND

Reset Button

The Reset Button connection is located on pins 3 and 4 of JF2. Attach it to the hardware reset switch on the computer case. Refer to the table on the right for pin definitions.

**Reset Pin
Definitions
(JF2)**

Pin Number	Definition
3	Reset
4	Ground

Power Button

The Power Button connection is located on pins 1 and 2 of JF2. Momentarily contacting both pins will power on/off the system. This button can also be configured to function as a suspend button (see the Power Button Mode setting in BIOS). To turn off the power when set to suspend mode, depress the button for at least 4 seconds. Refer to the table on the right for pin definitions.

**Power Button
Connector
Pin Definitions
(JF2)**

Pin Number	Definition
1	PW_ON
2	Ground

Chassis Intrusion

A Chassis Intrusion header is located at JL1. Attach the appropriate cable to inform you of a chassis intrusion.

Universal Serial Bus (USB0/1)

Two Universal Serial Bus ports are located beside the PS/2 keyboard/mouse ports. USB0 is the bottom connector and USB1 is the top connector. See the table on the right for pin definitions.

Universal Serial Bus Pin Definitions

USB0		USB1	
Pin Number	Definition	Pin Number	Definition
1	+5V	1	+5V
2	P0-	2	P0-
3	P0+	3	P0+
4	Ground	4	Ground
5	N/A	5	Key

Extra Universal Serial Bus Headers

Extra USB headers (FPUSB0/1 and USB2) are included on the motherboard. FPUSB0/1 were designed to provide front side USB access. You will need a USB cable (not included) for these headers. Refer to the tables on the right for pin definitions.

**USB2 Pin
Definitions (J13)**

Pin Number	Definition
2	Power
4	-
6	+
8	Ground
10	Key

**USB3 Pin
Definitions (J14)**

Pin Number	Definition
1	Power
3	-
5	+
7	Ground
9	Key

Serial Ports

The COM1 serial port is located under the parallel port (see Figure 2-3). See the table on the right for pin definitions. The COM2 connector is a header located near the PCI-X #1 slot on the motherboard.

**Serial Port Pin Definitions
(COM1, COM2)**

Pin Number	Definition	Pin Number	Definition
1	DCD	6	CTS
2	DSR	7	DTR
3	Serial In	8	RI
4	RTS	9	Ground
5	Serial Out	10	NC

LAN (Ethernet) Ports

Two Ethernet ports (one only on the P4DPL-M) are located beside the VGA port on the IO backplane. These ports accept RJ45 type cables. See Figure 2-3 for port definitions.



ATX PS/2 Keyboard and PS/2 Mouse Ports

The ATX PS/2 keyboard and the PS/2 mouse are located on J9. See the table on the right for pin definitions. (The mouse port is above the keyboard port. See Figure 2-3.)

**PS/2 Keyboard
and Mouse Port
Pin Definitions
(J9)**

Pin Number	Definition
1	Data
2	NC
3	Ground
4	VCC
5	Clck
6	NC

Fan Headers

Your motherboard has several fan headers designated CPU1 Chassis Fan, CPU2 Chassis Fan, Chassis Fan3, Chassis Fan4 Chassis Fan5 and Chassis Fan63. The first two attach to the fans on the CPU heatsinks. See the table on the right for pin definitions.

Fan Header Pin Definitions

Pin Number	Definition
1	Ground (black)
2	+12V (red)
3	Tachometer

Caution: These fan headers are DC power.

Power LED/Speaker (JD1)

On the JDI header, pins 1-3 are for the PWR LED and pins 4-7 are for the speaker connection. See the table on the right for speaker pin definitions. Note: The speaker connector pins are for use with an external speaker. If you wish to use the onboard speaker, you should close pins 6-7 with a jumper. (Note that the two pins beside the PWR LED header is for JP37 and not part of JD1 - see silkscreen on motherboard.)

Speaker Connector Pin Definitions (JD1)

Pin Number	Function	Definition
6	+	Red wire, Speaker data
7	Key	No connection
8		Key
9		Speaker data

Power Supply Fail Header

Connect a cable from your power supply to the JP8 header to provide warning of power supply failure. This warning signal is passed through the PWR_LED pin on JF2 to indicate of a power failure on the chassis. See the table on the right for pin definitions.

Power Supply Fail Header Pin Definitions (JP8)

Pin Number	Definition
1	P/S 1 Fail Signal
2	P/S 2 Fail Signal
3	P/S 3 Fail Signal
4	Reset (from MB)

Note: This feature is only available when using redundant Supermicro power supplies.

Keylock

The keyboard lock connection is located on JP35. Utilizing this header allows you to inhibit any actions made on the keyboard, effectively "locking" it.

Wake-On-LAN

The Wake-On-LAN header is designated WOL. See the table on the right for pin definitions. You must enable the LAN Wake-Up setting in BIOS to use this feature. You must also have a LAN card with a Wake-on-LAN connector and cable.

Wake-On-LAN Pin Definitions (WOL)

Pin Number	Definition
1	+5V Standby
2	Ground
3	Wake-up

Wake-On-Ring

The Wake-On-Ring header is designated JWOR1. This function allows your computer to receive and "wake-up" by an incoming call to the modem when in suspend state. See the table on the right for pin definitions. You must have a Wake-On-Ring card and cable to use this feature.

Wake-on-Ring Pin Definitions (JWOR1)

Pin Number	Definition
1	Ground
2	Wake-up

2-6 Jumper Settings

Explanation of Jumpers

To modify the operation of the motherboard, jumpers can be used to choose between optional settings. Jumpers create shorts between two pins to change the function of the connector. Pin 1 is identified with a square solder pad on the printed circuit board. See the motherboard layout pages for jumper locations.

Note: On two pin jumpers, "Closed" means the jumper is on and "Open" means the jumper is off the pins.

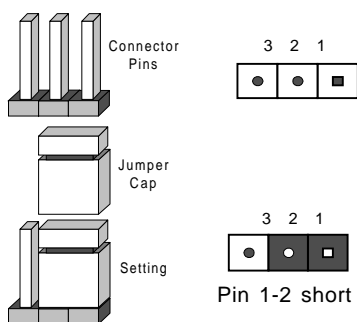

CMOS Clear

JBT1 is used to clear CMOS. Instead of pins, this jumper consists of contact pads to prevent accidentally clearing the contents of CMOS. To clear CMOS, use a metal object such as a small screwdriver to touch both pads at the same time to short the connection. Always remove the AC power cord from the system before clearing CMOS. **Note:** For an ATX power supply, you must completely shut down the system, remove the AC power cord and then short JBT1 to clear CMOS. Do not use the PW_ON connector to clear CMOS.

Mb LAN Enable/Disable

Change the setting of jumper JP3 to enable or disable the Mb LAN port on the motherboard (see Figure 2-3 for location). Refer to the table on the right for jumper settings. The default setting is Enabled.

**Mb LAN
Enable/Disable
Jumper Settings
(JP3)**

Jumper Position	Definition
Pins 1-2	Enabled
Pins 2-3	Disabled

Gb LAN Enable/Disable (P4DPL-8GM/P4DPL-iGM)

Change the setting of jumper JD3 to enable or disable the Gb LAN port on the motherboard. (see Figure 2-3 for location). Refer to the table on the right for jumper settings. The default setting is Enabled.

**Gb LAN
Enable/Disable
Jumper Settings
(JD3)**

Jumper Position	Definition
Pins 1-2	Enabled
Pins 2-3	Disabled

VGA Enable/Disable

JP4 allows you to enable or disable the VGA port. The default position is on pins 1 and 2 to enable VGA. See the table on the right for jumper settings.

**VGA Enable/Disable
Jumper Settings
(JP4)**

Jumper Position	Definition
1-2	Enabled
2-3	Disabled

Power Supply Alarm Enable/Disable

The system will notify you in the event of a power supply failure. This feature assumes that Supermicro redundant power supply units are installed in the chassis. If you only have a single power supply installed, you should disable this (the default setting) with JP9 to prevent false alarms. See the table on the right for jumper settings.

**Power Supply
Alarm Enable/Disable
Jumper Settings (JP9)**

Jumper Position	Definition
Open	Disabled
Closed	Enabled

SCSI Enable/Disable (P4DPL-8GM)

The SCSI Termination jumper at JP22 allows you to enable or disable the onboard SCSI controller. The normal (default) position is on pins 1-2 to enable SCSI termination. See the table on the right for jumper settings.

SCSI Enable/Disable
Jumper Settings
(JP22)

Jumper Position	Definition
Pins 1-2	Enabled
Pins 2-3	Disabled

SCSI Termination Enable/ Disable (P4DPL-8GM)

Jumpers JPA1 and JPA2 allow you to enable or disable termination for the individual SCSI channels. Jumper JPA1 controls SCSI channel A and JPA2 controls SCSI channel B. The normal (default) setting is open to enable (terminate) both SCSI channels. If you wish to connect external SCSI devices, you should disable termination for the channel(s) you will be connecting them to. See the table on the right for jumper settings.

SCSI Channel Termination
Enable/Disable
Jumper Settings
(JPA1, JPA2)

Jumper Position	Definition
Open	Enabled
Closed	Disabled

Watch Dog Enable/Disable

Use JP37 to enable or disable the Watch Dog feature. The default position is open to disable the Watch Dog timer. The jumper must be used in conjunction with the Watch Dog enabled setting in BIOS (Advanced Setup > I/O Device Configuration). When enabled, Watch Dog can reboot your PC if an application is "hung up" or the system goes down. See the table on the right for jumper settings.

Watch Dog Timer Enable/
Disable Jumper Settings
(JP37)

Jumper Position	Definition
Open	Disabled
Closed	Enabled

2-7 Onboard Indicators

Gb LAN LEDs (P4DPL-8GM, P4DPL-iGM)

The Gb LAN (Ethernet) port has two LEDs. On the Gb LAN port, the yellow (left) LED indicates activity while the other (right) LED may be green, orange or off to indicate the speed of the connection. See the tables at right for the functions associated with these LEDs.

Gb LAN Right LED Indicator

LED Color	Definition
Off	No Connection
Green	100 MHz
Orange	1 GHz

Gb LAN Left LED Indicator

LED Color	Definition
Off	Not Active
Yellow	Active

2-8 Parallel Port, Floppy/Hard Disk Drive and SCSI Connections

Note the following when connecting the floppy and hard disk drive cables:

- The floppy disk drive cable has seven twisted wires.
- A red mark on a wire typically designates the location of pin 1.
- A single floppy disk drive ribbon cable has 34 wires and two connectors to provide for two floppy disk drives. The connector with twisted wires always connects to drive A, and the connector that does not have twisted wires always connects to drive B.

Parallel Port Connector

The parallel (printer) port is located on J29. See the table on the right for pin definitions.

Parallel (Printer) Port Pin Definitions (J29)

Pin Number	Function	Pin Number	Function
1	Strobe-	2	Auto Feed-
3	Data Bit 0	4	Error-
5	Data Bit 1	6	Init-
7	Data Bit 2	8	SLCT IN-
9	Data Bit 3	10	GND
11	Data Bit 4	12	GND
13	Data Bit 5	14	GND
15	Data Bit 6	16	GND
17	Data Bit 7	18	GND
19	ACK	20	GND
21	BUSY	22	GND
23	PE	24	GND
25	SLCT	26	NC

Floppy Connector

The floppy connector is located on JP7. See the table below for pin definitions.

Floppy Connector Pin Definitions (JP7)

Pin Number	Function	Pin Number	Function
1	GND	2	FDHDIN
3	GND	4	Reserved
5	Key	6	FEEDIN
7	GND	8	Index-
9	GND	10	Motor Enable
11	GND	12	Drive Select B-
13	GND	14	Drive Select A-
15	GND	16	Motor Enable
17	GND	18	DIR-
19	GND	20	STEP-
21	GND	22	Write Data-
23	GND	24	Write Gate-
25	GND	26	Track 00-
27	GND	28	Write Protect-
29	GND	30	Read Data-
31	GND	32	Side 1 Select-
33	GND	34	Diskette

IDE Connectors

There are no jumpers to configure the onboard IDE#1 and #2 connectors. See the table on the right for pin definitions.

**IDE Connector Pin Definitions
(IDE#1, IDE#2)**

Pin Number	Function	Pin Number	Function
1	Reset IDE	2	GND
3	Host Data 7	4	Host Data 8
5	Host Data 6	6	Host Data 9
7	Host Data 5	8	Host Data 10
9	Host Data 4	10	Host Data 11
11	Host Data 3	12	Host Data 12
13	Host Data 2	14	Host Data 13
15	Host Data 1	16	Host Data 14
17	Host Data 0	18	Host Data 15
19	GND	20	Key
21	DRQ3	22	GND
23	I/O Write-	24	GND
25	I/O Read-	26	GND
27	IOCHRDY	28	BALE
29	DACK3-	30	GND
31	IRQ14	32	IOCS16-
33	Addr 1	34	GND
35	Addr 0	36	Addr 2
37	Chip Select 0	38	Chip Select 1-
39	Activity	40	GND

Ultra320 SCSI Connector (P4DPL-8GM)

Refer to the table below for the pin definitions of the Ultra320 SCSI connectors located at JA1 and JA2.

68-pin Ultra320 SCSI Connectors (JA1 and JA2)

Connector Contact Number	Signal Names	Connector Contact Number	Signal Names
1	+DB(12)	35	-DB(12)
2	+DB(13)	36	-DB(13)
3	+DB(14)	37	-DB(14)
4	+DB(15)	38	-DB(15)
5	+DB(P1)	39	-DB(P1)
6	+DB(0)	40	-DB(0)
7	+DB(1)	41	-DB(1)
8	+DB(2)	42	-DB(2)
9	+DB(3)	43	-DB(3)
10	+DB(4)	44	-DB(4)
11	+DB(5)	45	-DB(5)
12	+DB(6)	46	-DB(6)
13	+DB(7)	47	-DB(7)
14	+DB(P)	48	-DB(P)
15	GROUND	49	GROUND
16	DIFFSENS	50	GROUND
17	TERMPWR	51	TERMPWR
18	TERMPWR	52	TERMPWR
19	RESERVED	53	RESERVED
20	GROUND	54	GROUND
21	+ATN	55	-ATN
22	GROUND	56	GROUND
23	+BSY	57	-BSY
24	+ACK	58	-ACK
25	+RST	59	-RST
26	+MSG	60	-MSG
27	+SEL	61	-SEL
28	+C/D	62	-C/D
29	+REQ	63	-REQ
30	+I/O	64	-I/O
31	+DB(8)	65	-DB(8)
32	+DB(9)	66	-DB(9)
33	+DB(10)	67	-DB(10)
34	+DB(11)	68	-DB(11)

2-9 Installing Software Drivers

After all the hardware has been installed you must install the software drivers. The necessary drivers are all included on the Supermicro CD that came packaged with your motherboard. After inserting this CD into your CDROM drive, the display shown in Figure 2-5 should appear. (If this display does not appear, click on the My Computer icon and then on the icon representing your CDROM drive. Finally, double click on the S "Setup" icon.)

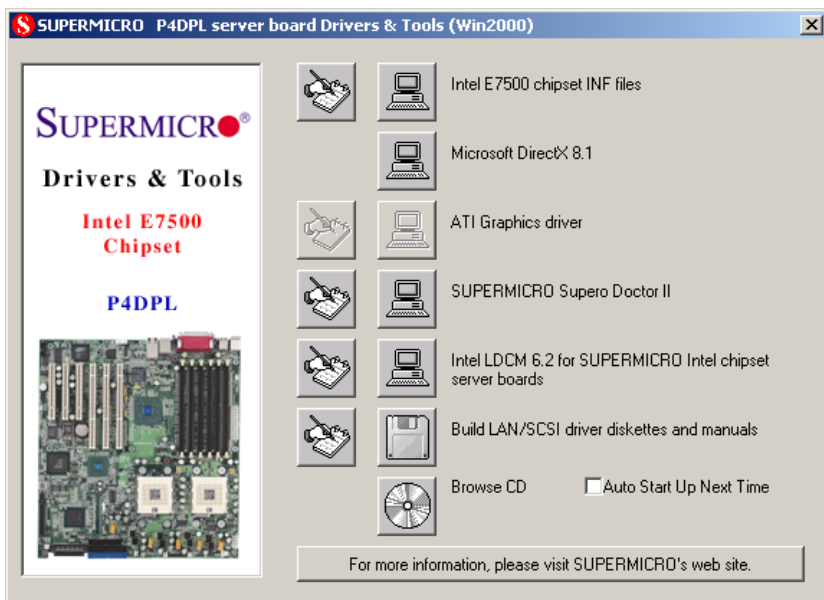

Figure 2-5. Driver/Tool Installation Display Screen

Click the icons showing a hand writing on paper to view the readme files for each item. The bottom icon with a CD on it allows you to view the entire contents of the CD.

Chapter 3

Troubleshooting

3-1 Troubleshooting Procedures

Use the following procedures to troubleshoot your system. If you have followed all of the procedures below and still need assistance, refer to the 'Technical Support Procedures' and/or 'Returning Merchandise for Service' section(s) in this chapter.

Note: Always disconnect the power cord before adding, changing or installing any hardware components.

Before Power On

1. Make sure no short circuits exist between the motherboard and chassis.
2. Disconnect all ribbon/wire cables from the motherboard, including those for the keyboard and mouse.
3. Remove all add-on cards.
4. Install one CPU (making sure it is fully seated) and connect the chassis speaker and the power LED to the motherboard. (Check all jumper settings as well.)

No Power

1. Make sure no short circuits exist between the motherboard and the chassis.
2. Verify that all jumpers are set to their default positions.
3. Check that the 115V/230V switch on the power supply is properly set.
4. Turn the power switch on and off to test the system.
5. The battery on your motherboard may be old. Check to verify that it still supplies ~3VDC. If it does not, replace it with a new one.

No Video

1. If the power is on but you have no video, remove all the add-on cards and cables.
2. Use the speaker to determine if any beep codes exist. Refer to the Appendix for details on beep codes.

NOTE

If you are a system integrator, VAR or OEM, a POST diagnostics card is recommended. For I/O port 80h codes, refer to App. B.

Memory Errors

1. Make sure the DIMM modules are properly and fully installed.
2. Determine if different speeds of DIMMs have been installed and verify that the BIOS setup is configured for the fastest speed of RAM used. It is recommended to use the same RAM speed for all DIMMs in the system.
3. Make sure you are using registered ECC, PC1600 (DDR-200) or PC2100 (DDR-266) SDRAM. EDO SDRAM and PC100/133 SDRAM are not supported. (Note: PC2100 is supported but runs at 200 MHz only.)
4. Check for bad DIMM modules or slots by swapping a single module between two slots and noting the results.
5. Make sure all memory modules are fully seated in their slots. As an interleaved memory scheme is used, you must install two modules at a time, beginning with Bank 1, then Bank 2, then Bank 3 (see Section 2-3).
6. Check the power supply voltage 115V/230V switch.

Losing the System's Setup Configuration

1. Ensure that you are using a high quality power supply. A poor quality power supply may cause the system to lose the CMOS setup information. Refer to Section 1-6 for details on recommended power supplies.
2. The battery on your motherboard may be old. Check to verify that it still supplies ~3VDC. If it does not, replace it with a new one.
3. If the above steps do not fix the Setup Configuration problem, contact your vendor for repairs.

3-2 Technical Support Procedures

Before contacting Technical Support, please take the following steps. Also, note that as a motherboard manufacturer, SuperMicro does not sell directly to end-users, so it is best to first check with your distributor or reseller for troubleshooting services. They should know of any possible problem(s) with the specific system configuration that was sold to you.

1. Please go through the 'Troubleshooting Procedures' and 'Frequently Asked Question' (FAQ) sections in this chapter or see the FAQs on our web site (<http://www.supermicro.com/techsupport.htm>) before contacting Technical Support.
2. BIOS upgrades can be downloaded from our web site at <http://www.supermicro.com/techsupport/download.htm>.

Note: Not all BIOS can be flashed depending on the modifications to the boot block code.

3. If you still cannot resolve the problem, include the following information when contacting Super Micro for technical support:
 - Motherboard model and PCB revision number
 - BIOS release date/version (this can be seen on the initial display when your system first boots up)
 - System configurationAn example of a Technical Support form is on our web site at http://www.supermicro.com/techsupport/contact_support.htm.
4. Distributors: For immediate assistance, please have your account number ready when placing a call to our technical support department. We can be reached by e-mail at support@supermicro.com or by fax at: (408) 503-8000, option 2.

3-3 Frequently Asked Questions

Question: What are the various types of memory that the P4DPL-8GM/P4DPL-iGM/P4DPL-M motherboard can support?

Answer: The P4DPL-8GM/P4DPL-iGM/P4DPL-M has six DIMM slots that support 184-pin, registered ECC PC1600 (DDR-200) SDRAM modules (DDR-266 is also supported but only at 200 MHz). It is strongly recommended that you do not mix memory modules of different speeds and sizes. Unbuffered SDRAM, non-ECC memory and PC100/133 SDRAM modules are not supported.

Question: How do I update my BIOS?

Answer: It is recommended that you **do not** upgrade your BIOS if you are experiencing no problems with your system. Updated BIOS files are located on our web site at <http://www.supermicro.com>. Please check our BIOS warning message and the info on how to update your BIOS on our web

site. Also, check the current BIOS revision and make sure it is newer than your BIOS before downloading. Select your motherboard model and download the BIOS file to your computer. Unzip the BIOS update file and you will find the readme.txt (flash instructions), the phlash.bat (BIOS flash utility), the platform.bin (platform file) and the BIOS image (xxxxxx.rom) files. Copy these files onto a bootable floppy and reboot your system. It is not necessary to set BIOS boot block protection jumpers on the motherboard. At the DOS prompt, enter the command "plash." This will start the flash utility and give you an opportunity to save your current BIOS image. Flash the boot block and enter the name of the update BIOS image file.

Question: After flashing the BIOS my system does not have video. How can I correct this?

Answer: If the system does not have video after flashing your new BIOS, it indicates that the flashing procedure failed. To remedy this, first clear CMOS per the instructions in this manual and retry the BIOS flashing procedure. If you still do not have video, please use the following **BIOS Recovery Procedure**. Boot up the system from a Win98 boot disk. Type `A:\>plash /s /cz /mfg /mode=3 [BIOS filename.rom]`, making sure you insert the spaces. The system will flash BIOS from here and reboot once it finishes.

To recover BIOS: a recovery flash requires an update key over the COM port as follows: hardwire Pin4 to Pin8, hardwire Pin9 and Pin7 to Pin6, and hardwire Pin3 to Pin2. Use the Supermicro CD to make a "Phoenix BIOS Crisis Disk for Supermicro Mainboard". This disk includes a BIOS file named "bios.rom". Please note, this BIOS file can be changed to a different Phoenix BIOS file as long as it's named "bios.rom". Connect the serial key to the COM port, insert the recovery disk into floppy drive and power on the system. When the system starts to read the disk, remove the serial key immediately. When the system is done with the BIOS recovery, it will automatically reboot.

Question: What's on the CD that came with my motherboard?

Answer: The supplied compact disc has quite a few drivers and programs that will greatly enhance your system. We recommend that you review the CD and install the applications you need. Applications on the CD include chipset drivers for Windows and security and audio drivers.

Question: Why can't I turn off the power using the momentary power on/off switch?

Answer: The instant power off function is controlled in BIOS by the Power Button Mode setting. When the On/Off feature is enabled, the motherboard

will have instant off capabilities as long as the BIOS has control of the system. When the Standby or Suspend feature is enabled or when the BIOS is not in control such as during memory count (the first screen that appears when the system is turned on), the momentary on/off switch must be held for more than four seconds to shut down the system. This feature is required to implement the ACPI features on the motherboard.

3-4 Returning Merchandise for Service

A receipt or copy of your invoice marked with the date of purchase is required before any warranty service will be rendered. You can obtain service by calling your vendor for a Returned Merchandise Authorization (RMA) number. When returning to the manufacturer, the RMA number should be prominently displayed on the outside of the shipping carton, and mailed prepaid or hand-carried. Shipping and handling charges will be applied for all orders that must be mailed when service is complete.

This warranty only covers normal consumer use and does not cover damages incurred in shipping or from failure due to the alternation, misuse, abuse or improper maintenance of products.

During the warranty period, contact your distributor first for any product problems.

Notes

Chapter 4

BIOS

4-1 Introduction

This chapter describes the PhoenixBIOS™ Setup utility for the P4DPL-8GM/P4DPL-iGM/P4DPL-M. The Phoenix ROM BIOS is stored in a flash chip and can be easily upgraded using a floppy disk-based program.

Note: Due to periodic changes to the BIOS, some settings may have been added or deleted and might not yet be recorded in this manual. Please refer to the Manual Download area of the Supermicro web site <<http://www.supermicro.com>> for any changes to BIOS that may not be reflected in this manual.

System BIOS

The BIOS is the Basic Input Output System used in all IBM® PC, XT™, AT®, and PS/2® compatible computers. The PhoenixBIOS flash chip stores the system parameters, such type of disk drives, video displays, etc. in the CMOS. The CMOS memory requires very little electrical power. When the computer is turned off, a back-up battery provides power to the BIOS flash chip, enabling it to retain system parameters. Each time the computer is powered-on the computer is configured with the values stored in the BIOS ROM by the system BIOS, which gains control at boot-up.

How To Change the Configuration Data

The CMOS information that determines the system parameters may be changed by entering the BIOS Setup utility. This Setup utility can be accessed by pressing the <Delete> key at the appropriate time during system boot, see below.

Starting the Setup Utility

Normally, the only visible POST (Power On Self Test) routine is the memory test. As the memory is being tested, press the <Delete> key to enter the main menu of the BIOS Setup utility. From the main menu, you can access the other setup screens, such as the Security and Power menus. Beginning with Section 4-3, detailed descriptions are given for each parameter setting in the Setup utility.

4-2 Running Setup

**Default settings are in bold text unless otherwise noted.*

The BIOS setup options described in this section are selected by choosing the appropriate text from the main BIOS Setup screen. All displayed text is described in this section, although the screen display is often all you need to understand how to set the options (see on next page).

When you first power on the computer, the PhoenixBIOS™ is immediately activated.

While the BIOS is in control, the Setup program can be activated in one of two ways:

1. By pressing <Delete> immediately after turning the system on, or
2. When the message shown below appears briefly at the bottom of the screen during the POST (Power On Self-Test), press the <Delete> key to activate the main Setup menu:

Press the <Delete> key to enter Setup

4-3 Main BIOS Setup

All main Setup options are described in this section. The main BIOS Setup screen is displayed below.

Use the Up/Down arrow keys to move among the different settings in each menu. Use the Left/Right arrow keys to change the options for each setting.

Press the <Esc> key to exit the CMOS Setup Menu. The next section describes in detail how to navigate through the menus.

Items that use submenus are indicated with the ► icon. With the item highlighted, press the <Enter> key to access the submenu.

Main BIOS Setup Menu

Phoenix BIOS Setup Utility					
Main	Advanced	Security	Power	Boot	Exit
System Time [16:19:20] System Date [02/02/02] Legacy Diskette A: [1.44/1.25 MB] Legacy Diskette B: [Not Installed] ▶ Primary Master [120 GB] ▶ Primary Slave [None] ▶ Secondary Master [CD-ROM] ▶ Secondary Slave [None] System Memory 256 MB Extended Memory 3967 KB				Item Specific Help	
F1 Help	↑↓	Select Item	-/+	Change Values	F9 Setup Defaults
Esc Exit	↔	Select Menu	Enter	Select ▶ Sub-Menu	F10 Save and Exit

Main Setup Features

System Time

To set the system date and time, key in the correct information in the appropriate fields. Then press the <Enter> key to save the data.

System Date

Using the arrow keys, highlight the month, day and year fields and enter the correct data. Press the <Enter> key to save the data.

Legacy Diskette A

This setting allows the user to set the type of floppy disk drive installed as diskette A. The options are Disabled, 360Kb 5.25 in, 1.2MB 5.25 in, 720Kb 3.5 in, **1.44/1.25MB**, 3.5 in and 2.88MB 3.5 in.

Legacy Diskette B

This setting allows the user to set the type of floppy disk drive installed as diskette B. The options are **Disabled**, 360Kb 5.25 in, 1.2MB 5.25 in, 720Kb 3.5 in, 1.44/1.25MB, 3.5 in and 2.88MB 3.5 in.

► Primary Master/Primary Slave/Secondary Master/Secondary Slave

These settings allow the user to set the parameters of the IDE Primary Master/Slave and IDE Secondary Master/Slave slots. Hit <Enter> to activate the following sub-menu screen for detailed options of these items. Set the correct configurations accordingly. The items included in the sub-menu are:

Phoenix BIOS Setup Utility					
Main	Advanced	Security	Power	Boot	Exit
Type:		[Auto]			Item Specific Help
Multi Sector Transfer:		[16 Sectors]			Select the drive type of the fixed disk installed in your system. If type User is selected, Cylinders, Heads, and Sectors can be edited directly. Auto attempts to automatically detect the drive type for drives that comply with ANSI specifications.
LBA Mode Control:		[Enabled]			
32-bit I/O:		[Enabled]			
Transfer Mode:		[Fast PIO 4]			
Ultra DMA Mode		[Disabled]			
F1 Help	↑↓	Select Item	-/+	Change Values	F9 Setup Defaults
Esc Exit	↔	Select Menu	Enter	Select ► Sub-Menu	F10 Save and Exit

Type

Selects the type of IDE hard drive. The options are **Auto** (allows BIOS to automatically determine the hard drive's capacity, number of heads, etc.), a number from 1-39 to select a predetermined type of hard drive, CD-ROM and ATAPI Removable.

Multi-Sector Transfers

Select the number of transfer sectors. Options are 2, 4, 6, 8 and **16 Sectors**.

LBA Mode Control

This item determines whether Phoenix BIOS will access the IDE Primary Master Device via LBA mode. The options are **Enabled** and Disabled.

32-bit I/O

Selects 32-bit I/O operation. Options are Enabled and **Disabled**.

Transfer Mode

Selects the transfer mode. Options are Standard, Fast PIO1, Fast PIO2, Fast PIO3, **Fast PIO4**, FPIO3/DMA1 and FPIO4/DMA2.

Ultra DMA Mode

Selects Ultra DMA Mode. Options are **Disabled**, Mode 0, Mode 1, Mode 2, Mode 3, Mode 4 and Mode 5.

System Memory

This display informs you how much system memory is recognized as being present in the system.

Extended Memory

This display informs you how much extended memory is recognized as being present in the system.

4-4 Advanced Setup

Choose Advanced from the Phoenix BIOS Setup Utility main menu with the arrow keys. You should see the following display. The items with a triangle beside them have sub menus that can be accessed by highlighting the item and pressing <Enter>. Options for PIR settings are displayed by highlighting the setting option using the arrow keys and pressing <Enter>. All Advanced BIOS Setup options are described in this section.

Phoenix BIOS Setup Utility						
Main	Advanced	Security	Power	Boot	PIR	Exit
Quick Boot Mode [Enabled] Quiet Boot [Enabled] ▶ PCI/PnP Configuration ▶ Cache Memory ▶ I/O Device Configuration ▶ Advanced Chipset Control ▶ Advanced Processor Options ▶ DMI Event Logging ▶ Console Redirection					Item Specific Help	
F1 Help	↑↓ Select Item	-/+ Change Values	F9 Setup Defaults			
Esc Exit	↔ Select Menu	Enter Select ▶ Sub-Menu	F10 Save and Exit			

Quick Boot Mode

If enabled, this feature will speed up the POST (Power On Self Test) routine after the computer is turned on. The settings are **Enabled** and Disabled. If Disabled, the POST routine will run at normal speed.

Quiet Boot

This setting allows you to **Enable** or Disable the diagnostic screen during boot-up.

► PCI/PnP Configuration

Access the submenu for this item to make changes to the PCI/PnP configuration, as listed below.

Onboard LAN1 OPROM Configure

Enabling this setting allows you to boot your system from LAN 1. Options are Enabled and **Disabled**.

Onboard LAN2 OPROM Configure

Enabling this setting allows you to boot your system from LAN 2. Options are Enabled and **Disabled**.

Legacy USB Support

This setting allows you to enable support for Legacy USB devices. The settings are Enabled and **Disabled**.

Installed OS

This setting allows you to select the operating system for your computer. The settings are Other, Win95, Win98, WinMe and **Win 2000**.

NT4 Installation Workaround

This setting allows BIOS to provide a workaround for the absence of a floppy drive during NT4 installation. Options are Enabled and **Disabled**.

Reset Configuration Data

Options are Yes and **No**. Choosing Yes will clear the Extended System Configuration Data (ECSD).

▶ PCI Slot Configuration

PCI/PCIX Frequency (Slot 4-5)

This setting controls the bus speed of PCI-X slots # 4 and 5. Options are 33 MHz, 66 MHz, 100 MHz, 133 MHz and **Auto**. Note that the onboard SCSI limits the speed of these two slots to 66 MHz on the P4DMS-6GM.

PCI/PCIX Frequency (Slot 6)

This setting controls the bus speed of PCI-X slots # 4 and 5. Options are 33 MHz, 66 MHz, 100 MHz, 133 MHz and **Auto**.

▶ PCI Device, Slot 1

▶ PCI Device, Slot 2

▶ PCI Device, Slot 3

▶ PCI Device, Slot 4

▶ PCI Device, Slot 5

▶ PCI Device, Slot 6

Option ROM Scan

This setting (included in the submenu for the above six settings) will initialize the selected device's expansion ROM when enabled. Options are **Enabled** and Disabled.

Enabled Master

This setting (included in the submenu for the above six settings) will designate the selected device as the PCI bus master when enabled. Options are Enabled and **Disabled**.

Latency Timer

This setting (included in the submenu for the above six settings) sets the minimum guaranteed time slice allotted to the bus master in units of PCI bus clocks. Options are **Default**, 0020h, 0040h, 0060h, 0080h, 00A0h, 00C0h and 00E0h.

Large Disk Access Mode

This setting determines how large hard drives are to be accessed. The options are **DOS** or Other (for Unix, Novelle NetWare and other operating systems).

Local Bus IDE Adapter

Use this setting to enable the integrated local bus IDE adapter. Options are Disable, Primary, Secondary and **Both**.

►Cache Memory

Access the submenu for this item to specify one of the following actions for the various sections of cache memory: Uncached, Write Protect, Write Back, Write Through or Disabled. See the "Item Specific Help" window for details.

►I/O Device Configuration

Access the submenu to make changes to the following settings.

Power Loss Control

This setting allows you to choose how the system will react when power returns after an unexpected loss of power. Options are Stay Off, Power On and **Last State**.

Watch Dog

This setting is used to enable or disabled the Watch Dog Timer function. It must be used in conjunction with the JP37 jumper (see Chapter 2 for details). Options are Enabled and **Disabled**.

KBC Clock Input

Use this setting to select the keyboard clock rate. Options are 6 MHz, 8 MHz and **12 MHz**.

Serial Port A

This setting allows you to assign control of serial port A. The options are **Enabled** (user defined), Disabled, Auto (BIOS controlled) and OS Controlled.

Base I/O Address

Select the base I/O address for serial port A. The options are **3F8**, 2F8, 3E8 and 2E8.

Interrupt

Select the IRQ (interrupt request) for serial port A. Options are IRQ3 and **IRQ4**.

Serial Port B

This setting allows you to assign control of serial port B. The options are **Enabled** (user defined), Disabled, Auto (BIOS controlled) and OS Controlled.

Mode

Specify the type of device that will be connected to serial port B. Options are **Normal** and IR (for an infrared device).

Base I/O Address

Select the base I/O address for serial port B. The options are 3F8, **2F8**, 3E8 and 2E8.

Interrupt

Select the IRQ (interrupt request) for serial port B. Options are **IRQ3** and IRQ4.

Parallel Port

This setting allows you to assign control of the parallel port. The options are **Enabled** (user defined), Disabled and Auto (BIOS controlled).

Base I/O Address

Select the base I/O address for the parallel port. The options are **378**, 278 and 3BC.

Interrupt

Select the IRQ (interrupt request) for the parallel port. Options are IRQ5 and **IRQ7**.

Mode

Specify the parallel port mode. Options are Output Only, Bi-directional, EPP and **ECP**.

DMA Channel

Specify the DMA channel. Options are DMA1 and **DMA3**.

Floppy Disk Controller

This setting allows you to assign control of the floppy disk controller. The options are **Enabled** (user defined), Disabled and Auto (BIOS controlled).

Base I/O Address

Select the base I/O address for the parallel port. The options are **Primary** and Secondary.

► Advanced Chipset Control

Access the submenu to make changes to the following settings.

Enable Memory Gap

This setting allows you to turn off system RAM to free up address space. The options for this setting are **Disabled** and Extended.

ECC Configuration

This setting lets you enable or disable ECC (Error Correction and Checking). The options are **ECC** and Disabled.

ECC Error Type

This setting lets you select which type of interrupt will be activated as a result of an ECC error. The options are **None**, NMI (Non-Maskable Interrupt), SMI (System Management Interrupt) and SCI (System Control Interrupt).

SERR Signal Condition

This setting specifies the conditions required to qualify as an ECC error. Options are **None**, Single Bit, Multiple Bit and Both.

► Advanced Processor Options

Access the submenu to make changes to the following settings.

CPU Speed

This is a display that indicates the speed of the installed processor.

Frequency Ratio

This setting allows you to specify the value of the internal frequency multiplier of the processor, which is used to determine the processor speed. Options are x8, x16, x17, x18, x19 and x20.

Fast String Operations

This setting allows you to **Enable** or Disable fast string operations.

Compatible FPU Code

This setting allows you to Enable or **Disable** the compatible FPU code.

Split Lock Operations

This setting allows you to **Enable** or Disable split lock operations.

Hyper-Threading

This setting allows you to **Enable** or Disable hyper-threading. Enabling hyper-threading results in increased CPU performance.

L3 Cache

This setting allows you to Enable or **Disable** the L3 cache.

► DMI Event Logging

Access the submenu to make changes to the following settings.

Event Log Validity

This is a display, not a setting, informing you of the event log validity.

Event Log Capacity

This is a display, not a setting, informing you of the event log capacity.

View DMI Event Log

Highlight this item and press <Enter> to view the contents of the event log.

Event Logging

This setting allows you to **Enable** or Disable event logging.

ECC Event Logging

This setting allows you to **Enable** or Disable ECC event logging.

Mark DMI Events as Read

Highlight this item and press <Enter> to mark the DMI events as read.

Clear All DMI Event Logs

This setting will clear all DMI event logs when set to Yes. Options are Yes and **No**.

► Console Redirection

Access the submenu to make changes to the following settings.

COM Port Address

Specifies to redirect the console to On-board COMA or On-board COMB. This setting can also be **Disabled**.

BAUD Rate

Select the BAUD rate for console redirection.

Console Type

Choose from the available options to select the console type for console redirection.

Flow Control

Choose from the available options to select the flow control for console redirection.

Console Connection

Select the console connection: either Direct or Via Modem.

Continue CR after POST

Choose whether to continue with console redirection after the POST routine. Options are On and **Off**.

of Video Pages to Support

Choose the number of video pages to allocate for redirection when video hardware is not available. Options are 1, 2, 3, 4, 5, 6, 7 and 8.

4-5 Security

Choose Security from the Phoenix BIOS Setup Utility main menu with the arrow keys. You should see the following display. Security setting options are displayed by highlighting the setting using the arrow keys and pressing <Enter>. All Security BIOS settings are described in this section.

Phoenix BIOS Setup Utility						
Main	Advanced	Security	Power	Boot	PIR	Exit
Supervisor Password Is: [Clear] User Password Is: [Clear] Set Supervisor Password: [Enter] Set User Password: [Enter] Password on Boot [Disabled] Fixed Disk Boot Sector [Normal]					Item Specific Help	
F1 Help	↑↓	Select Item	-/+	Change Values	F9 Setup Defaults	
Esc Exit	↔	Select Menu	Enter	Select ▶	Sub-Menu F10 Save and Exit	

Supervisor Password Is:

This displays whether a supervisor password has been entered for the system. Clear means such a password has not been used and Set means a supervisor password has been entered for the system.

User Password Is:

This displays whether a user password has been entered for the system. Clear means such a password has not been used and Set means a user password has been entered for the system.

Set Supervisor Password

When the item "Set Supervisor Password" is highlighted, hit the <Enter> key. When prompted, type the Supervisor's password in the dialogue box to set or to change supervisor's password, which allows access to BIOS.

Set User Password

When the item "Set User Password" is highlighted, hit the <Enter> key. When prompted, type the user's password in the dialogue box to set or to change the user's password, which allows access to the system at boot-up.

Password on Boot

This setting allows you to require a password to be entered when the system boots up. Options are Enabled (password required) and Disabled (password not required).

Fixed Disk Boot Sector

This setting may offer some protection against viruses when set to Write Protect, which protects the boot sector on the hard drive from having a virus written to it. The other option is **Normal**.

4-6 Power

Choose Power from the Phoenix BIOS Setup Utility main menu with the arrow keys. You should see the following display. Power setting options are displayed by highlighting the setting using the arrow keys and pressing <Enter>. All Power BIOS settings are described in this section.

Phoenix BIOS Setup Utility						
Main	Advanced	Security	Power	Boot	PIR	Exit
ACPI Mode: [Yes] Power Savings: [Customized] Suspend Timeout: [Off] Resume on Time: [Off] Resume Time: [00:00:00]					Item Specific Help	
F1 Help	↑↓	Select Item	-/+	Change Values	F9	Setup Defaults
Esc Exit	↔	Select Menu	Enter	Select ▶ Sub-Menu	F10	Save and Exit

ACPI Mode

Use the setting to determine if you want to employ ACPI (Advanced Configuration and Power Interface) power management on your system. Options are **Yes** and No.

Power Savings

This setting sets the degree of power saving for the system. The options are Disabled, **Customized**, Maximum Power Savings and Maximum Performance. Customized allows you to alter the other two modes.

Suspend Timeout

Use this setting to specify the period of system inactivity to transpire before entering the suspend state. Options are **Off**, 5 min, 10 min, 15 min, 20 min, 30 min, 40 min and 60 min.

Resume on Time

Select either **Off** or **On**, which will wake the system up at the time specified in the next setting.

Resume Time

Use this setting to specify the time you want the system to wake up (the above setting must be set to **On**). Enter the time with the number keys.

4-7 Boot

Choose **Boot** from the Phoenix BIOS Setup Utility main menu with the arrow keys. You should see the following display. Highlighting a setting with a + or - will expand or collapse that entry. See details on how to change the order and specs of boot devices in the Item Specific Help window. All Boot BIOS settings are described in this section.

Phoenix BIOS Setup Utility						
Main	Advanced	Security	Power	Boot	PIR	Exit
+ Removable Devices CD-ROM Drive + Hard Drive					Item Specific Help	
F1 Help	↑↓	Select Item	-/+	Change Values	F9	Setup Defaults
Esc Exit	↔	Select Menu	Enter	Select ▶	Sub-Menu	F10 Save and Exit

+Removable Devices

Highlight and press <Enter> to expand the field. See details on how to change the order and specs of removable devices in the Item Specific Help window.

CD-ROM Drive

See details on how to change the order and specs of removable devices in the Item Specific Help window.

+Hard Drive

Highlight and press <Enter> to expand the field. See details on how to change the order and specs of hard drives in the Item Specific Help window.

4-8 PIR

Choose PIR from the Phoenix BIOS Setup Utility main menu with the arrow keys. You should see the following display. The items with a triangle beside them have sub menus that can be accessed by highlighting the item and pressing <Enter>. PIR stands for "Processor Info ROM", which allows BIOS to read certain information from the processors. Options for PIR settings are displayed by highlighting the setting option using the arrow keys and pressing <Enter>. All PIR BIOS Setup options are described in this section.

Phoenix BIOS Setup Utility						
Main	Advanced	Security	Power	Boot	PIR	Exit
Select the Processor's PIR Select the Thermal Unit ▶ Processor Info ROM Data ▶ Hardware Monitor Logic					Item Specific Help	
F1 Help	↑↓	Select Item	-/+	Change Values	F9	Setup Defaults
Esc Exit	↔	Select Menu	Enter	Select ▶ Sub-Menu	F10	Save and Exit

Select the Processor's PIR

Selects the processor PIR. Options are **A0h/A1h**, A2h/A3h, A4h/A5h, A6h/A7h, A8h/A8h, AAh/ABh, ACh/ADh and AEh/AFh. See the Item Specific Help field for details.

Select the Thermal Unit

Selects the thermal unit. Options are **30h/31h**, 32h/33h, 34h/35h, 52h/53h, 54h/55h, 56h/57h, 98h/99h, 9Ah/9Bh and 9Ch/9Dh. See the Item Specific Help field for details.

► Processor Info ROM Data

Highlight this and hit <Enter> to see PIR data on the following items:

Header Info

Processor Data

Processor Core Data

L3 Cache Data

Package Data

Part Number Data

Thermal Reference Data

Feature Data

Other Data

OEM Data

► Hardware Monitor Logic

Highlight this and hit <Enter> to see monitor data for the following items:

CPU1 Temperature

CPU2 Temperature

System Temperature

CPU Fan1 Chassis Fan

CPU Fan2 Chassis Fan

Processor Vcore (V)

3.3V Standby (V)

3.3V Vcc (V)

5V Vcc (V)

12V Vcc (V)

1.8V Vcc (V)

-12V Vcc (V)

4-9 Exit

Choose Exit from the Phoenix BIOS Setup Utility main menu with the arrow keys. You should see the following display. All Exit BIOS settings are described in this section.

Phoenix BIOS Setup Utility						
Main	Advanced	Security	Power	Boot	PIR	Exit
Exit Saving Changes Exit Discarding Changes Load Setup Defaults Discard Changes Save Changes					Item Specific Help	
F1 Help	↑↓ Select Item	-/+ Change Values		F9 Setup Defaults		
Esc Exit	↔ Select Menu	Enter Select ▶Sub-Menu		F10 Save and Exit		

Exit Saving Changes

Highlight this item and hit <Enter> to save any changes you made and to exit the BIOS Setup utility.

Exit Discarding Changes

Highlight this item and hit <Enter> to exit the BIOS Setup utility without saving any changes you may have made.

Load Setup Defaults

Highlight this item and hit <Enter> to load the default settings for all items in the BIOS Setup. These are the safest settings to use.

Discard Changes

Highlight this item and hit <Enter> to discard (cancel) any changes you made. You will remain in the Setup utility.

Save Changes

Highlight this item and hit <Enter> to save any changes you made. You will remain in the Setup utility.

Notes

Appendix A

BIOS POST Messages

During the Power-On Self-Test (POST), the BIOS will check for problems. If a problem is found, the BIOS will activate an alarm or display a message. The following is a list of such BIOS messages.

Failure Fixed Disk

Fixed disk is not working or not configured properly. Check to see if fixed disk is attached properly. Run Setup. Find out if the fixed-disk type is correctly identified.

Stuck key

Stuck key on keyboard.

Keyboard error

Keyboard not working.

Keyboard Controller Failed

Keyboard controller failed test. May require replacing keyboard controller.

Keyboard locked - Unlock key switch

Unlock the system to proceed.

Monitor type does not match CMOS - Run SETUP

Monitor type not correctly identified in Setup

Shadow Ram Failed at offset: nnnn

Shadow RAM failed at offset **nnnn** of the 64k block at which the error was detected.

System RAM Failed at offset: nnnn

System RAM failed at offset **nnnn** of in the 64k block at which the error was detected.

Extended RAM Failed at offset: nnnn Extended memory not working or not configured properly at offset **nnnn**.

System battery is dead - Replace and run SETUP

The CMOS clock battery indicator shows the battery is dead. Replace the battery and run Setup to reconfigure the system.

System CMOS checksum bad - Default configuration used

System CMOS has been corrupted or modified incorrectly, perhaps by an application program that changes data stored in CMOS. The BIOS installed Default Setup Values. If you do not want these values, enter Setup and enter your own values. If the error persists, check the system battery or contact your dealer.

System timer error

The timer test failed. Requires repair of system board.

Real time clock error

Real-Time Clock fails BIOS hardware test. May require board repair.

Check date and time settings

BIOS found date or time out of range and reset the Real-Time Clock. May require setting legal date (1991-2099).

Previous boot incomplete - Default configuration used

Previous POST did not complete successfully. POST loads default values and offers to run Setup. If the failure was caused by incorrect values and they are not corrected, the next boot will likely fail. On systems with control of **wait states**, improper Setup settings can also terminate POST and cause this error on the next boot. Run Setup and verify that the waitstate configuration is correct. This error is cleared the next time the system is booted.

Memory Size found by POST differed from CMOS

Memory size found by POST differed from CMOS.

Diskette drive A error

Diskette drive B error

Drive A: or B: is present but fails the BIOS POST diskette tests. Check to see that the drive is defined with the proper diskette type in Setup and that the diskette drive is attached correctly.

Incorrect Drive A type - run SETUP

Type of floppy drive A: not correctly identified in Setup.

Incorrect Drive B type - run SETUP

Type of floppy drive B: not correctly identified in Setup.

System cache error - Cache disabled

RAM cache failed and BIOS disabled the cache. On older boards, check the cache jumpers. You may have to replace the cache. See your dealer. A disabled cache slows system performance considerably.

CPUID:

CPU socket number for Multi-Processor error.

EISA CMOS not writeable

ServerBIOS2 test error: Cannot write to EISA CMOS.

DMA Test Failed

ServerBIOS2 test error: Cannot write to extended **DMA** (Direct Memory Access) registers.

Software NMI Failed

ServerBIOS2 test error: Cannot generate software NMI (Non-Maskable Interrupt).

Fail-Safe Timer NMI Failed

ServerBIOS2 test error: Fail-Safe Timer takes too long.

device Address Conflict

Address conflict for specified **device**.

Allocation Error for: device

Run ISA or EISA Configuration Utility to resolve resource conflict for the specified **device**.

CD ROM Drive

CD ROM Drive identified.

Entering SETUP ...

Starting Setup program

Failing Bits: nnnn

The hex number **nnnn** is a map of the bits at the RAM address which failed the memory test. Each 1 (one) in the map indicates a failed bit. See errors 230, 231, or 232 above for offset address of the failure in System, Extended, or Shadow memory.

Fixed Disk n

Fixed disk n (0-3) identified.

Invalid System Configuration Data

Problem with NVRAM (CMOS) data.

I/O device IRQ conflict

I/O device IRQ conflict error.

PS/2 Mouse Boot Summary Screen:

PS/2 Mouse installed.

nnnn kB Extended RAM Passed

Where nnnn is the amount of RAM in kilobytes successfully tested.

nnnn Cache SRAM Passed

Where nnnn is the amount of system cache in kilobytes successfully tested.

nnnn kB Shadow RAM Passed

Where nnnn is the amount of shadow RAM in kilobytes successfully tested.

nnnn kB System RAM Passed

Where nnnn is the amount of system RAM in kilobytes successfully tested.

One or more I2O Block Storage Devices were excluded from the Setup Boot Menu

There was not enough room in the IPL table to display all installed I2O block-storage devices.

Operating system not found

Operating system cannot be located on either drive A: or drive C:. Enter Setup and see if fixed disk and drive A: are properly identified.

Parity Check 1 nnnn

Parity error found in the system bus. BIOS attempts to locate the address and display it on the screen. If it cannot locate the address, it displays ?????. Parity is a method for checking errors in binary data. A parity error indicates that some data has been corrupted.

Parity Check 2 nnnn

Parity error found in the I/O bus. BIOS attempts to locate the address and display it on the screen. If it cannot locate the address, it displays **????**.

Press <F1> to resume, <F2> to Setup, <F3> for previous

Displayed after any recoverable error message. Press <F1> to start the boot process or <F2> to enter Setup and change the settings. Press <F3> to display the previous screen (usually an initialization error of an **Option ROM**, i.e., an add-on card). Write down and follow the information shown on the screen.

Press <F2> to enter Setup

Optional message displayed during POST. Can be turned off in Setup.

PS/2 Mouse:

PS/2 mouse identified.

Run the I2O Configuration Utility

One or more unclaimed block storage devices have the Configuration Request bit set in the LCT. Run an I2O Configuration Utility (e.g. the SAC utility).

System BIOS shadowed

System BIOS copied to shadow RAM.

UMB upper limit segment address: nnnn

Displays the address **nnnn** of the upper limit of **Upper Memory Blocks**, indicating released segments of the BIOS which can be reclaimed by a virtual memory manager.

Video BIOS shadowed

Video BIOS successfully copied to shadow RAM.

Notes

Appendix B

BIOS POST Codes

This section lists the POST (Power On Self Test) codes for the PhoenixBIOS. POST codes are divided into two categories: recoverable and terminal.

Recoverable POST Errors

When a recoverable type of error occurs during POST, the BIOS will display an POST code that describes the problem. BIOS may also issue one of the following beep codes:

- 1 long and two short beeps - video configuration error
- 1 continuous long beep - no memory detected

Terminal POST Errors

If a terminal type of error occurs, BIOS will shut down the system. Before doing so, BIOS will write the error to port 80h, attempt to initialize video and write the error in the top left corner of the screen.

The following is a list of codes that may be written to port 80h.

POSTCode	Description
02h	Verify Real Mode
03h	Disable Non-Maskable Interrupt (NMI)
04h	Get CPU type
06h	Initialize system hardware
07h	Disable shadow and execute code from the ROM.
08h	Initialize chipset with initial POST values
09h	Set IN POST flag
0Ah	Initialize CPU registers
0Bh	Enable CPU cache
0Ch	Initialize caches to initial POST values
0Eh	Initialize I/O component
0Fh	Initialize the local bus IDE
10h	Initialize Power Management
11h	Load alternate registers with initial POST values
12h	Restore CPU control word during warm boot
13h	Initialize PCI Bus Mastering devices
14h	Initialize keyboard controller
16h	1-2-2-3 BIOS ROM checksum
17h	Initialize cache before memory Auto size

POST Code	Description
18h	8254 timer initialization
1Ah	8237 DMA controller initialization
1Ch	Reset Programmable Interrupt Controller
20h	1-3-1-1 Test DRAM refresh
22h	1-3-1-3 Test 8742 Keyboard Controller
24h	Set ES segment register to 4 GB
28h	Auto size DRAM
29h	Initialize POST Memory Manager
2Ah	Clear 512 kB base RAM
2Ch	1-3-4-1 RAM failure on address line xxxx*
2Eh	1-3-4-3 RAM failure on data bits xxxx* of low byte of memory bus
2Fh	Enable cache before system BIOS shadow
32h	Test CPU bus-clock frequency
33h	Initialize Phoenix Dispatch Manager
36h	Warm start shut down
38h	Shadow system BIOS ROM
3Ah	Auto size cache
3Ch	Advanced configuration of chipset registers
3Dh	Load alternate registers with CMOS values
41h	Initialize extended memory for RomPilot
42h	Initialize interrupt vectors
45h	POST device initialization
46h	2-1-2-3 Check ROM copyright notice
47h	Initialize I20 support
48h	Check video configuration against CMOS
49h	Initialize PCI bus and devices
4Ah	Initialize all video adapters in system
4Bh	QuietBoot start (optional)
4Ch	Shadow video BIOS ROM
4Eh	Display BIOS copyright notice
4Fh	Initialize MultiBoot
50h	Display CPU type and speed
51h	Initialize EISA board
52h	Test keyboard
54h	Set key click if enabled
55h	Enable USB devices
58h	2-2-3-1 Test for unexpected interrupts
59h	Initialize POST display service
5Ah	Display prompt "Press F2 to enter SETUP"
5Bh	Disable CPU cache

POSTCode	Description
5Ch	Test RAM between 512 and 640 kB
60h	Test extended memory
62h	Test extended memory address lines
64h	Jump to UserPatch1
66h	Configure advanced cache registers
67h	Initialize Multi Processor APIC
68h	Enable external and CPU caches
69h	Setup System Management Mode (SMM) area
6Ah	Display external L2 cache size
6Bh	Load custom defaults (optional)
6Ch	Display shadow-area message
6Eh	Display possible high address for UMB recovery
70h	Display error messages
72h	Check for configuration errors
76h	Check for keyboard errors
7Ch	Set up hardware interrupt vectors
7Dh	Initialize Intelligent System Monitoring
7Eh	Initialize coprocessor if present
80h	Disable onboard Super I/O ports and IRQs
81h	Late POST device initialization
82h	Detect and install external RS232 ports
83h	Configure non-MCD IDE controllers
84h	Detect and install external parallel ports
85h	Initialize PC-compatible PnP ISA devices
86h	Re-initialize onboard I/O ports.
87h	Configure Motherboard Configurable Devices (optional)
88h	Initialize BIOS Data Area
89h	Enable Non-Maskable Interrupts (NMIs)
8Ah	Initialize Extended BIOS Data Area
8Bh	Test and initialize PS/2 mouse
8Ch	Initialize floppy controller
8Fh	Determine number of ATA drives (optional)
90h	Initialize hard-disk controllers
91h	Initialize local-bus hard-disk controllers
92h	Jump to UserPatch2
93h	Build MPTABLE for multi-processor boards
95h	Install CD ROM for boot
96h	Clear huge ES segment register
97h	Fix up Multi Processor table
98h	1-2 Search for option ROMs. One long, two short beeps on checksum failure

POST Code	Description
99h	Check for SMART Drive (optional)
9Ah	Shadow option ROMs
9Ch	Set up Power Management
9Dh	Initialize security engine (optional)
9Eh	Enable hardware interrupts
9Fh	Determine number of ATA and SCSI drives
A0h	Set time of day
A2h	Check key lock
A4h	Initialize typematic rate
A8h	Erase F2 prompt
AAh	Scan for F2 key stroke
ACh	Enter SETUP
A Eh	Clear Boot flag
B0h	Check for errors
B1h	Inform RomPilot about the end of POST.
B2h	POST done - prepare to boot operating system
B4h	1 One short beep before boot
B5h	Terminate QuietBoot (optional)
B6h	Check password (optional)
B7h	Initialize ACPI BIOS
B9h	Prepare Boot
BAh	Initialize SMBIOS
BBh	Initialize PnP Option ROMs
BCh	Clear parity checkers
BDh	Display MultiBoot menu
BEh	Clear screen (optional)
BFh	Check virus and backup reminders
C0h	Try to boot with INT 19
C1h	Initialize POST Error Manager (PEM)
C2h	Initialize error logging
C3h	Initialize error display function
C4h	Initialize system error handler
C5h	PnPnd dual CMOS (optional)
C6h	Initialize note dock (optional)
C7h	Initialize note dock late
C8h	Force check (optional)
C9h	Extended checksum (optional)
CAh	Redirect Int 15h to enable remote keyboard
CBh	Redirect Int 13h to Memory Technologies Devices such as ROM, RAM, PCMCIA, and serial disk
CCh	Redirect Int 10h to enable remote serial video

POST Code	Description
CDh	Re-map I/O and memory for PCMCIA
CEh	Initialize digitizer and display message
D2h	Unknown interrupt

The following are for boot block in Flash ROM

POST Code	Description
E0h	Initialize the chipset
E1h	Initialize the bridge
E2h	Initialize the CPU
E3h	Initialize system timer
E4h	Initialize system I/O
E5h	Check force recovery boot
E6h	Checksum BIOS ROM
E7h	Go to BIOS
E8h	Set Huge Segment
E9h	Initialize Multi Processor
EAh	Initialize OEM special code
EBh	Initialize PIC and DMA
ECh	Initialize Memory type
EDh	Initialize Memory size
EEh	Shadow Boot Block
EFh	System memory test
F0h	Initialize interrupt vectors
F1h	Initialize Run Time Clock
F2h	Initialize video
F3h	Initialize System Management Manager
F4h	Output one beep
F5h	Clear Huge Segment
F6h	Boot to Mini DOS
F7h	Boot to Full DOS

* If the BIOS detects error 2C, 2E, or 30 (base 512K RAM error), it displays an additional word-bitmap (**xxxx**) indicating the address line or bits that failed. For example, "2C 0002" means address line 1 (bit one set) has failed. "2E 1020" means data bits 12 and 5 (bits 12 and 5 set) have failed in the lower 16 bits. The BIOS also sends the bitmap to the port-80 LED display. It first displays the checkpoint code, followed by a delay, the high-order byte, another delay, and then the low-order byte of the error. It repeats this sequence continuously.

Notes