



H13SAE-MF

USER'S MANUAL

Revision 1.1

The information in this User's Manual has been carefully reviewed and is believed to be accurate. The vendor assumes no responsibility for any inaccuracies that may be contained in this document, and makes no commitment to update or to keep current the information in this manual, or to notify any person or organization of the updates. **Please Note: For the most up-to-date version of this manual, please see our website at [www.supermicro.com](http://www.supermicro.com).**

Super Micro Computer, Inc. ("Supermicro") reserves the right to make changes to the product described in this manual at any time and without notice. This product, including software and documentation, is the property of Supermicro and/or its licensors, and is supplied only under a license. Any use or reproduction of this product is not allowed, except as expressly permitted by the terms of said license.

IN NO EVENT WILL Super Micro Computer, Inc. BE LIABLE FOR DIRECT, INDIRECT, SPECIAL, INCIDENTAL, SPECULATIVE OR CONSEQUENTIAL DAMAGES ARISING FROM THE USE OR INABILITY TO USE THIS PRODUCT OR DOCUMENTATION, EVEN IF ADVISED OF THE POSSIBILITY OF SUCH DAMAGES. IN PARTICULAR, SUPER MICRO COMPUTER, INC. SHALL NOT HAVE LIABILITY FOR ANY HARDWARE, SOFTWARE, OR DATA STORED OR USED WITH THE PRODUCT, INCLUDING THE COSTS OF REPAIRING, REPLACING, INTEGRATING, INSTALLING OR RECOVERING SUCH HARDWARE, SOFTWARE, OR DATA.

Any disputes arising between manufacturer and customer shall be governed by the laws of Santa Clara County in the State of California, USA. The State of California, County of Santa Clara shall be the exclusive venue for the resolution of any such disputes. Supermicro's total liability for all claims will not exceed the price paid for the hardware product.

FCC Statement: This equipment has been tested and found to comply with the limits for a Class A or Class B digital device pursuant to Part 15 of the FCC Rules. These limits are designed to provide reasonable protection against harmful interference when the equipment is operated in industrial environment for Class A device or in residential environment for Class B device. This equipment generates, uses, and can radiate radio frequency energy and, if not installed and used in accordance with the manufacturer's instruction manual, may cause harmful interference with radio communications. Operation of this equipment in a residential area is likely to cause harmful interference, in which case you will be required to correct the interference at your own expense.

California Best Management Practices Regulations for Perchlorate Materials: This Perchlorate warning applies only to products containing CR (Manganese Dioxide) Lithium coin cells. "Perchlorate Material-special handling may apply. See [www.dtsc.ca.gov/hazardouswaste/perchlorate](http://www.dtsc.ca.gov/hazardouswaste/perchlorate)".



WARNING: This product can expose you to chemicals including lead, known to the State of California to cause cancer and birth defects or other reproductive harm. For more information, go to [www.P65Warnings.ca.gov](http://www.P65Warnings.ca.gov).

The products sold by Supermicro are not intended for and will not be used in life support systems, medical equipment, nuclear facilities or systems, aircraft, aircraft devices, aircraft/emergency communication devices or other critical systems whose failure to perform be reasonably expected to result in significant injury or loss of life or catastrophic property damage. Accordingly, Supermicro disclaims any and all liability, and should buyer use or sell such products for use in such ultra-hazardous applications, it does so entirely at its own risk. Furthermore, buyer agrees to fully indemnify, defend and hold Supermicro harmless for and against any and all claims, demands, actions, litigation, and proceedings of any kind arising out of or related to such ultra-hazardous use or sale.

Manual Revision 1.1

Release Date: August 19, 2025

Unless you request and receive written permission from Super Micro Computer, Inc., you may not copy any part of this document. Information in this document is subject to change without notice. Other products and companies referred to herein are trademarks or registered trademarks of their respective companies or mark holders.

Copyright © 2025 by Super Micro Computer, Inc.  
All rights reserved.

**Printed in the United States of America**

# Preface

## About This Manual

This manual is written for system integrators, IT technicians and knowledgeable end users. It provides information for the installation and use of the H13SAE-MF motherboard.

## About This Motherboard

Built upon the functionality and capability of AMD EPYC™ 4005, 4004 Series or Ryzen™ 9000, 8700G\* (for specific system SKU only), and 7000 Series Desktop processor, the H13SAE-MF motherboard provides superior graphics capability and system performance while consuming little power. Please note that this motherboard is intended to be installed and serviced by professional technicians only. For processor/memory updates, please refer to our website at <http://www.supermicro.com/products/>.

## Conventions Used in the Manual

Special attention should be given to the following symbols for proper installation and to prevent damage done to the components or injury to yourself:



**Warning!** Indicates important information given to prevent equipment/property damage or personal injury.



**Warning!** Indicates high voltage may be encountered when performing a procedure.

---

---

## Contacting Supermicro

### Headquarters

Address: Super Micro Computer, Inc.  
980 Rock Ave.  
San Jose, CA 95131 U.S.A.

Tel: +1 (408) 503-8000

Fax: +1 (408) 503-8008

Email: marketing@supermicro.com (General Information)  
Sales-USA@supermicro.com (Sales Inquiries)  
Government\_Sales-USA@supermicro.com (Gov. Sales Inquiries)  
support@supermicro.com (Technical Support)  
RMA@supermicro.com (RMA Support)  
Webmaster@supermicro.com (Webmaster)

Website: [www.supermicro.com](http://www.supermicro.com)

### Europe

Address: Super Micro Computer B.V.  
Het Sterrenbeeld 28, 5215 ML  
's-Hertogenbosch, The Netherlands

Tel: +31 (0) 73-6400390

Fax: +31 (0) 73-6416525

Email: Sales\_Europe@supermicro.com (Sales Inquiries)  
Support\_Europe@supermicro.com (Technical Support)  
RMA\_Europe@supermicro.com (RMA Support)

Website: [www.supermicro.nl](http://www.supermicro.nl)

### Asia-Pacific

Address: Super Micro Computer, Inc.  
3F, No. 150, Jian 1st Rd.  
Zhonghe Dist., New Taipei City 235  
Taiwan (R.O.C)

Tel: +886-(2) 8226-3990

Fax: +886-(2) 8226-3992

Email: Sales-Asia@supermicro.com.tw (Sales Inquiries)  
Support@supermicro.com.tw (Technical Support)  
RMA@supermicro.com.tw (RMA Support)

Website: [www.supermicro.com.tw](http://www.supermicro.com.tw)

# Table of Contents

Contacting Supermicro.....	4
<b>Chapter 1 Introduction</b>	
1.1 Quick Reference.....	10
Quick Reference Table.....	11
Motherboard Features.....	13
Block Diagram.....	15
1.2 Processor and Chipset Overview.....	16
1.3 Special Features .....	16
Recovery from AC Power Loss.....	16
1.4 System Health Monitoring .....	17
Onboard Voltage Monitors .....	17
Fan Status Monitor with Firmware Control .....	17
Environmental Temperature Control .....	17
System Resource Alert.....	17
1.5 Power Supply .....	18
1.6 Super I/O .....	18
<b>Chapter 2 Installation</b>	
2.1 Static-Sensitive Devices.....	19
Precautions .....	19
Unpacking .....	19
2.2 Motherboard Installation.....	20
Location of Mounting Holes .....	20
Installing the Motherboard.....	22
2.3 Processor and Heatsink Installation.....	23
AMD EPYC™ 4005, 4004 Series or Ryzen™ 9000, 8700G, and 7000 Series Desktop Processor .....	23
Overview of the Processor Socket.....	24
Overview of the Heatsink.....	25
Installing the Processor.....	26
Installing the Heatsink.....	29
<b>Supported Processors and Operating Systems .....</b>	<b>31</b>
2.4 Memory Support and Installation .....	32

Memory Support.....	32
DIMM Module Population Sequence .....	33
DIMM Installation .....	34
DIMM Removal .....	34
2.5 Rear I/O Ports .....	35
2.6 Front Control Panel.....	38
Front Control Panel Pin Definitions.....	39
2.7 Connectors .....	41
Power Connections .....	41
Headers.....	42
2.8 Jumper Settings .....	45
How Jumpers Work.....	45
2.9 LED Indicators.....	47
<b>Chapter 3 Troubleshooting</b>	
3.1 Troubleshooting Procedures .....	49
Before Power On .....	49
No Power .....	49
No Video .....	50
System Boot Failure.....	50
Memory Errors .....	51
The System Cannot Retain the Setup Configuration .....	51
When the System Becomes Unstable .....	51
When BIOS Firmware Update Fails .....	53
3.2 Technical Support Procedures .....	53
3.3 Frequently Asked Questions .....	54
3.4 Returning Merchandise for Service.....	55
3.5 Battery Removal and Installation .....	56
Battery Removal.....	56
Proper Battery Disposal .....	56
Battery Installation.....	56
<b>Chapter 4 BIOS</b>	
4.1 Introduction.....	57
Starting the Setup Utility .....	57

4.2 Main Setup .....	58
4.3 Advanced.....	60
4.4 BMC.....	79
4.5 Security.....	82
4.6 Boot .....	86
4.7 Save & Exit.....	88

***Appendix A Software***

A.1 Configuring SATA RAID Drives .....	90
Enabling SATA RAID Mode .....	90
Creating RAID Arrays .....	92
A.2 Configuring M.2 RAID Drives .....	94
Enabling M.2 RAID Mode .....	94
A.3 Microsoft Windows OS Installation.....	95
Installing RAID Drivers for SATA During Windows Setup .....	95
Installing RAID Drivers.....	96
Installing RAID Drivers for M.2 During Windows Setup .....	98
A.4 Driver Installation.....	104
A.5 SuperDoctor® 5.....	105
A.6 IPMI .....	105

***Appendix B Standardized Warning Statements***

B.1 Battery Handling.....	106
B.2 Product Disposal .....	108

# Chapter 1

## Introduction

Congratulations on purchasing your computer motherboard from an industry leader. Supermicro boards are designed to provide you with the highest standards in quality and performance. In addition to the motherboard, several important parts that are included with the system are listed below. If anything listed is damaged or missing, please contact your retailer.

### Important Links

For your system to work properly, please follow the links below to download all necessary drivers/utilities and the user's manual for your workstation.

- Supermicro product manuals: <http://www.supermicro.com/support/manuals/>
- Product drivers and utilities: <https://www.supermicro.com/wdl>
- Product safety info: [http://www.supermicro.com/about/policies/safety\\_information.cfm](http://www.supermicro.com/about/policies/safety_information.cfm)
- A secure data deletion tool designed to fully erase all data from storage devices can be found at our website: [https://www.supermicro.com/about/policies/disclaimer.cfm?url=/wdl/utility/Lot9\\_Secure\\_Data\\_Deletion\\_Utility](https://www.supermicro.com/about/policies/disclaimer.cfm?url=/wdl/utility/Lot9_Secure_Data_Deletion_Utility)
- If you have any questions, please contact our support team at: [support@supermicro.com](mailto:support@supermicro.com)

This manual may be periodically updated without notice. Please check the Supermicro website for possible updates to the manual revision level.



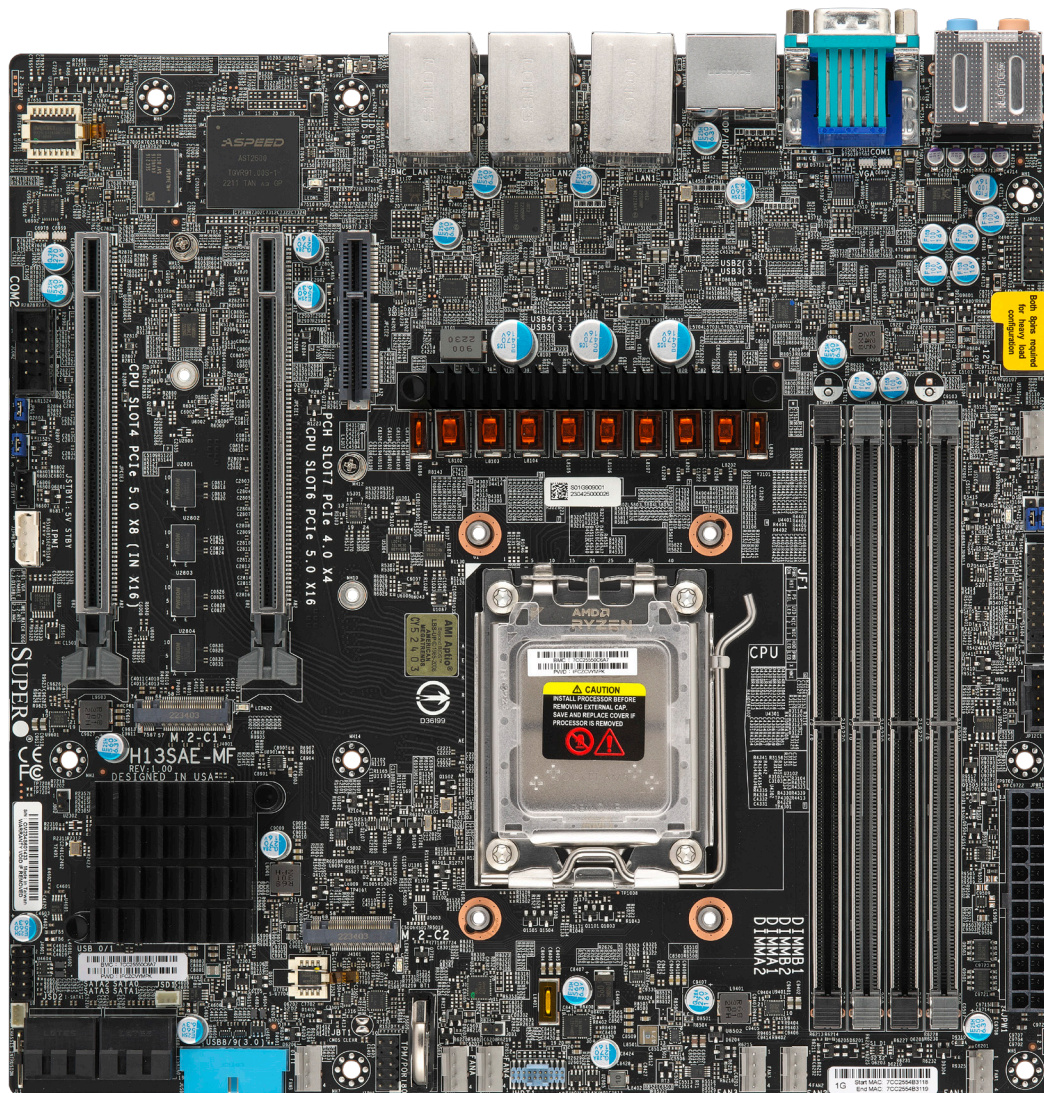

Figure 1-1. H13SAE-MF Motherboard Image

**Note:** All graphics shown in this manual were based upon the latest PCB revision available at the time of publication of the manual. The motherboard you received may or may not look exactly the same as the graphics shown in this manual.

## 1.1 Quick Reference

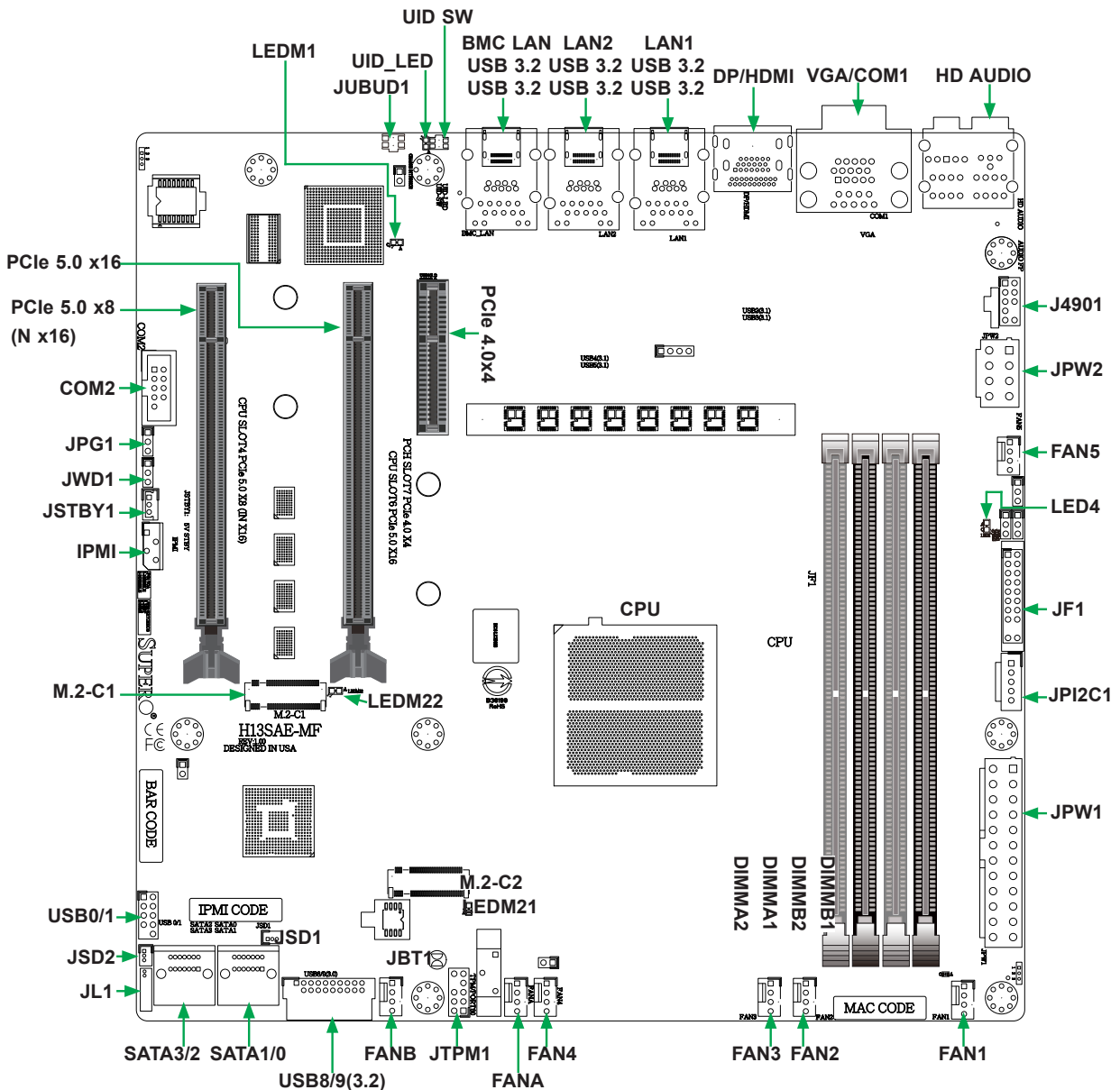

Figure 1-2. H13SAE-MF Layout

### Notes:

- Components not documented are for internal testing only.
- See Chapter 2 for detailed information on jumpers, I/O ports, and JF1 front panel connections.
- Use only the correct type of onboard CMOS battery as specified by the manufacturer. To avoid possible explosion, do not install the onboard battery upside down.

## Quick Reference Table

Jumper	Description	Default Setting
JBT1	CMOS Clear	Open (Normal)
JPG1	VGA Enable	Pins 1-2 (Enabled)
JUBUD1	BIOS Update	Off
JWD1	Watch Dog Control	Pins 1-2 (Reset)
UID SW	Unit ID Switch (Push-Button Toggle Switch ON/OFF)	Off

LED	Description	Status
LED1	Unit Identifier (UID) LED	Blue: UID Identified
LED4	Onboard Power LED	Solid Green: Power On
LEDM1	BMC Heartbeat LED	Green: Blinking (BMC Normal) Green: Fast Blinking (BMC Initializing)
LEDM21-LEDM22	M.2 SSD LED	Blinking: Device Working

Connector	Description
BMC LAN	BMC LAN Port
BT1	Onboard Battery
COM1/COM2	Serial Port/Header
DIMMA1-DIMMB2	DIMM Slots
FAN1-FAN5	CPU Fans
FANA-FANB	System Cooling Fans
JL1	Chassis Intrusion Header
J4901	Front Panel HD Audio Header
JF1	Front Control Panel Header
JIPMB1	4-pin BMC External I <sup>2</sup> C Header (For an IPMI-Supported Card)
JPI2C1	Power System Management Bus (SMB) I <sup>2</sup> C Header
JPW1	24-pin ATX Main Power Connector (Required)
JPW2	12V 8-pin CPU Core Power Supply Connector
JSTBY1	Inject External P5V_STBY Power
JTPM1	TPM (Trusted Platform Module)/Port 80
M.2-C1/M.2-C2	M.2 PCIe Interfaces
PCIe 5.0 x16	PCIe 5.0 x16 Slot
PCIe 5.0 x8 (N x16)	PCIe 5.0 x8 (IN x16) Slot
SATA0-1, SATA2-3	Dual SATA Port Connectors Supporting up to Four Devices
USB0/1	USB 2.0 Ports
USB2/4	Rear USB 3.2 Gen1 Alt Ports
USB3/5/7	Rear USB 3.2 Gen2 Ports
USB6	Rear USB3.2 Gen2x2 Port
USB8/9	Front USB 3.2 Gen1 Ports
VGA	Rear Panel VGA Port

**Note:** Jumpers, connectors, switches, and LED indicators that are not described in the preceding tables are for manufacturing testing purposes only, and are not covered in this manual.

## Motherboard Features

### CPU

- AMD EPYC™ 4005, 4004 Series or Ryzen™ 9000, 8700G\* (for specific system SKU only), and 7000 Series Desktop Processor in Socket AM5

### Memory

- Up to 192 GB of ECC/Non ECC UDIMM DDR5 5600 MHz in four DIMM slots

**Note:** Please refer to [2.4 Memory Support and Installation](#) for more details on memory speed.

### DIMM Size

- 8 GB, 16 GB, and 32 GB at 1.1 V

### Chipset

- AMD B650 chipset

### Expansion Slots

- One PCIe 5.0 x16
- One PCIe 5.0 x8 (in x16 slot)
- One PCIe 4.0 x4
- Two M.2 PCIe 5.0 x4 Connector (supporting Key-M 2280 and 22110)
- Four SATA 6 GB/s

### Network

- Two 1 Gb LAN ports (i210 AT)
- One dedicated Realtek 1 Gb LAN for IPMI

### Graphics

- ASPEED AST2600 BMC chip with one VGA port
- AMD Radeon™ Graphics

### USB Ports

- One USB 3.2 Gen2 x2 port (one rear Type C 20 Gb)
- Five USB 3.2 Gen2 ports (three rear Type A 10 Gb; two rear Type C 10 Gb, support DP Alt mode)
- Two USB 3.2 Gen1 ports (two headers via a header)
- Two USB 2 ports (two ports by a header)

### Video Output

- One DP 1.4a port, one HDMI 2.0 port, two rear Type C ports DP 1.4 Alt mode

### BIOS

- 256 Mb SPI AMI BIOS® SM Flash UEFI BIOS
- ACPI 6.4, SMBIOS 3.5.0, Plug-and-Play (PnP), RTC (Real Time Clock) wakeup, Riser Card Auto-Detection Support

**Note:** Table continues on the next page.

## Power Management

- ACPI power management (S3/S5)
- Wake-On-LAN
- Power-on mode for AC power recovery

## System Health Monitoring

- Onboard voltage monitoring for +3.3 V, +5 V, +12 V, +3.3 VStb, +5 Stb, CPU temperature, system temperature, memory temperature, and peripheral temperature
- CPU Thermal Trip support

## Fan Control

- Seven 4-pin fan headers
- Fans monitored by IPMI
- Dual cooling zones

## System Management

- IPMIView/SMCIPMITOOL/IPMICFG
- SuperDoctor® 5
- SDO/SPM/SSM/SUM-OOB/InBand
- Trusted Platform Module (TPM) support

## LED Indicators

- M.2 SSD Read / Write LED Indicators
- BMC Heartbeat LED Indicator
- Unit Identifier LED Indicator

## Dimensions

- 9.6" (W) x 9.6" (L) (243.84 x 243.84 mm), Micro ATX

## Block Diagram

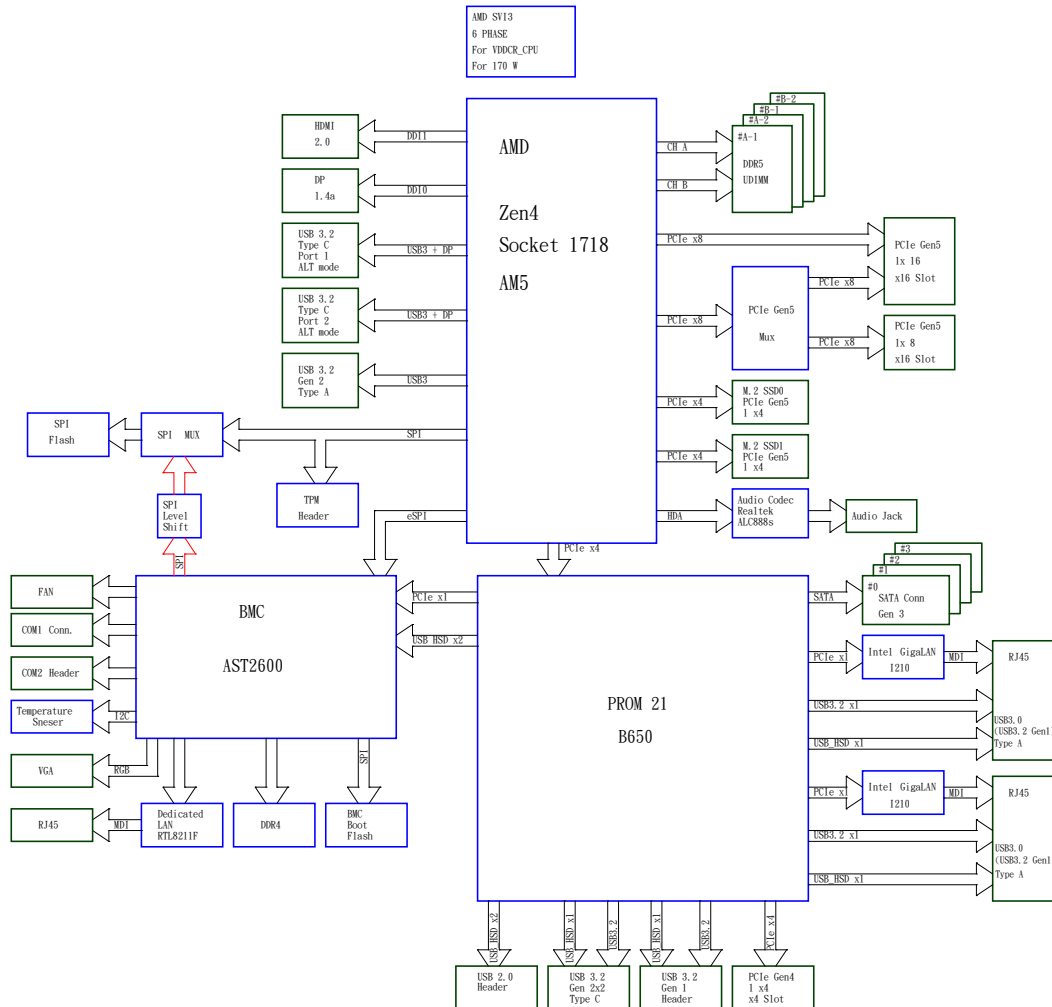

Figure 1-3. System Block Diagram

**Note:** This is a general block diagram and may not exactly represent the features on your motherboard. See the previous pages for the actual specifications of your motherboard.

## 1.2 Processor and Chipset Overview

Built upon the functionality and capability of the AMD EPYC™ 4005, 4004 Series or Ryzen™ 9000, 8700G\* (for specific system SKU only), and 7000 Series Desktop processor in Socket AM5, the H13SAE-MF motherboard offers maximum I/O expendability, energy efficiency, and data reliability in a 5-nm process architecture, and is optimized for embedded storage solutions, networking applications, or cloud-computing platforms.

With support of the new microarchitecture 5-nm process technology, the H13SAE-MF drastically increases system performance for a multitude of workstation applications.

The AMD EPYC™ 4005, 4004 Series or Ryzen™ 9000, 8700G\* (for specific system SKU only), and 7000 Series Desktop processors support the following features:

- High-performance “Zen 4” cores
- AMD 3D V-Cache technology
- ECC/non ECC DDR5 memory
- PCIe 5.0 storage

## 1.3 Special Features

This section describes the health monitoring features of the H13SAE-MF motherboard. The motherboard has an onboard System Hardware Monitor chip that supports system health monitoring.

### Recovery from AC Power Loss

The Basic I/O System (BIOS) provides a setting that determines how the system will respond when AC power is lost and then restored to the system. You can choose for the system to remain powered off (in which case you must press the power switch to turn it back on), or for it to automatically return to the power-on state. See the Advanced BIOS Setup section for this setting. The default setting is Last State.



## 1.4 System Health Monitoring

This section describes the health monitoring features of the H13SAE-MF motherboard. The motherboard has an onboard Baseboard Management Controller (BMC) chip that supports system health monitoring. Once a voltage becomes unstable, a warning is given or an error message is sent to the screen. The user can adjust the voltage thresholds to define the sensitivity of the voltage monitor.

### Onboard Voltage Monitors

The onboard voltage monitor will continuously scan crucial voltage levels. Once a voltage becomes unstable, it will give a warning or send an error message to the screen. The user can adjust the voltage thresholds to define the sensitivity of the voltage monitor. Real time readings of these voltage levels are all displayed in BMC.

### Fan Status Monitor with Firmware Control

PC health monitoring in the BMC can check the RPM status of the cooling fans. The onboard CPU and chassis fans are controlled by Thermal Management through BMC.

### Environmental Temperature Control

The thermal control sensor monitors the CPU temperature in real time and will turn on the thermal control fan whenever the CPU temperature exceeds a user-defined threshold. The overheat circuitry runs independently from the CPU. Once the thermal sensor detects that the CPU temperature is too high, it will automatically turn on the thermal fans to prevent the CPU from overheating. The onboard chassis thermal circuitry can monitor the overall system temperature and alert the user when the chassis temperature is too high.

**Note:** To avoid possible system overheating, please be sure to provide adequate airflow to your system.

### System Resource Alert

This feature is available when used with SuperDoctor 5<sup>®</sup>. SuperDoctor 5 is used to notify the user of certain system events. For example, you can configure SuperDoctor 5 to provide you with warnings when the system temperature, CPU temperatures, voltages and fan speeds go beyond a predefined range.

## 1.5 Power Supply

As with all computer products, a stable power source is necessary for proper and reliable operation. It is even more important for processors that have high CPU clock rates. In areas where noisy power transmission is present, you may choose to install a line filter to shield the computer from noise. It is recommended that you also install a power surge protector to help avoid problems caused by power surges.

## 1.6 Super I/O

The ASPEED AST2600 Super I/O provides one high-speed, 16550 compatible Universal Asynchronous Receiver/Transmitter (UART), which supports serial infrared communications. This UART includes a send/receive FIFO, a programmable baud rate generator, complete modem control capability and a processor interrupt system. This UART provides legacy speed with baud rate of up to 115.2 Kbps as well as an advanced speed with baud rates of 250 K, 500 K, or 1 Mb/s, which support higher speed modems.

# Chapter 2

## Installation

### 2.1 Static-Sensitive Devices

Electrostatic Discharge (ESD) can damage electronic components. To prevent damage to your motherboard, it is important to handle it very carefully. The following measures are generally sufficient to protect your equipment from ESD.

#### Precautions

- Use a grounded wrist strap designed to prevent static discharge.
- Touch a grounded metal object before removing the board from the antistatic bag.
- Handle the board by its edges only; do not touch its components, peripheral chips, memory modules or gold contacts.
- When handling chips or modules, avoid touching their pins.
- Put the motherboard and peripherals back into their antistatic bags when not in use.
- For grounding purposes, make sure that your chassis provides excellent conductivity between the power supply, the case, the mounting fasteners and the motherboard.
- Use only the correct type of CMOS onboard battery as specified by the manufacturer. Do not install the CMOS battery upside down, which may result in a possible explosion.

#### Unpacking

The motherboard is shipped in antistatic packaging to avoid static damage. When unpacking the motherboard, make sure that the person handling it is static protected.

## 2.2 Motherboard Installation

All motherboards have standard mounting holes to fit different types of chassis. Make sure that the locations of all the mounting holes for both the motherboard and the chassis match. Although a chassis may have both plastic and metal mounting fasteners, metal ones are highly recommended because they ground the motherboard to the chassis. Make sure that the metal standoffs click in or are screwed in tightly.



Philips Screwdriver (1)



Philips Screws (6)



Standoffs (6)  
Only if Needed

### Tools Needed

### Location of Mounting Holes

#### Notes:

1. To avoid damaging the motherboard and its components, please do not use a force greater than 8 lb/inch on each mounting screw during motherboard installation.
2. Some components are very close to the mounting holes. Please take precautionary measures to avoid damaging these components when installing the motherboard to the chassis.

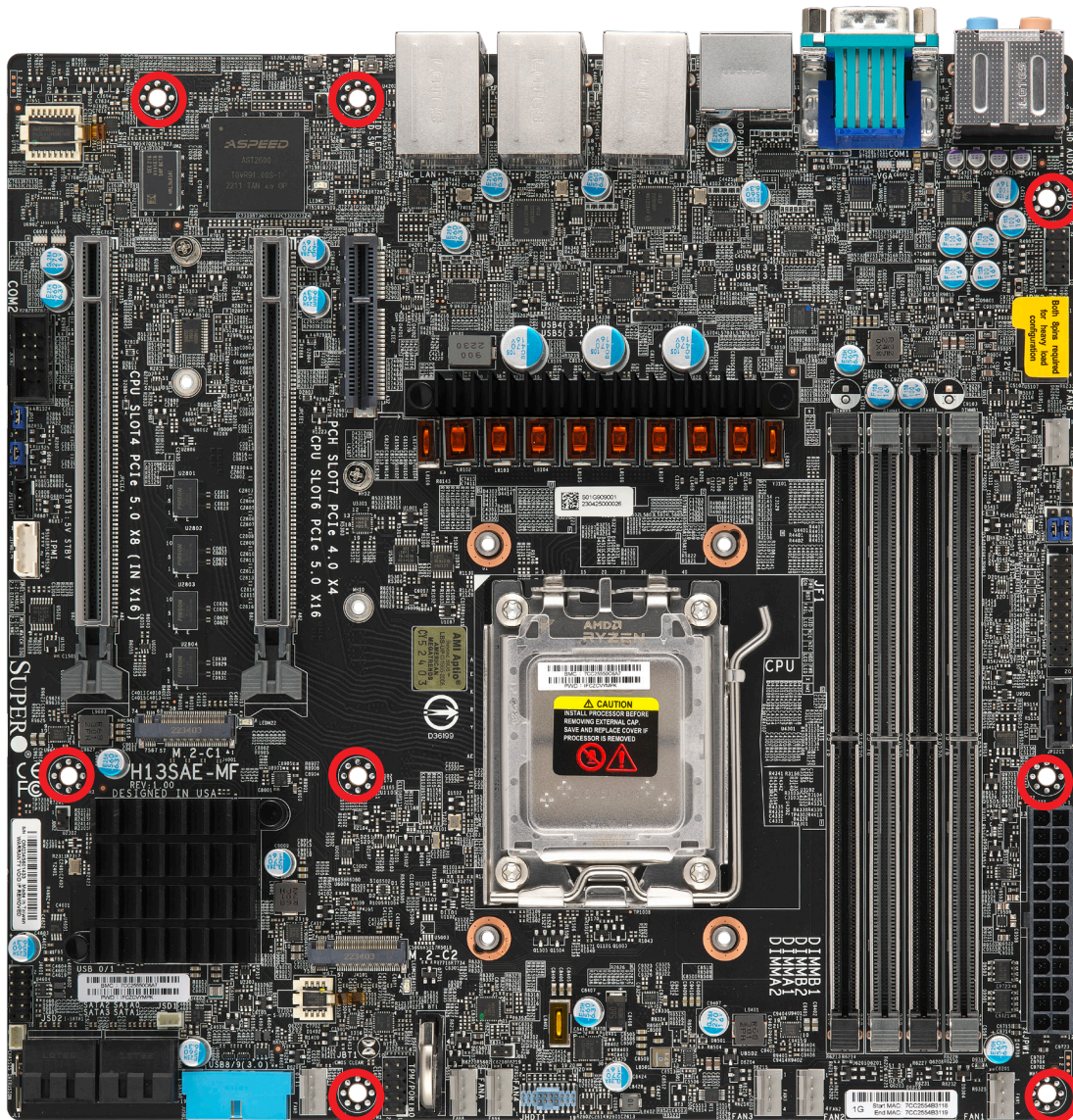
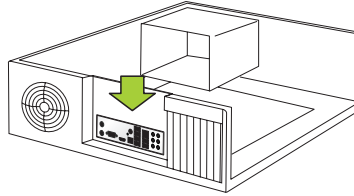

Figure 2-1. Motherboard Mounting Holes

## Installing the Motherboard

1. Install the I/O shield into the back of the chassis.



2. Locate the mounting holes on the motherboard. See the previous page for the location.

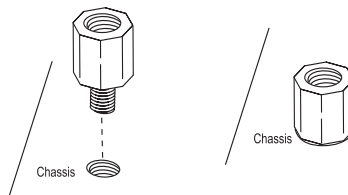

3. Locate the matching mounting holes on the chassis. Align the mounting holes on the motherboard against the mounting holes on the chassis.

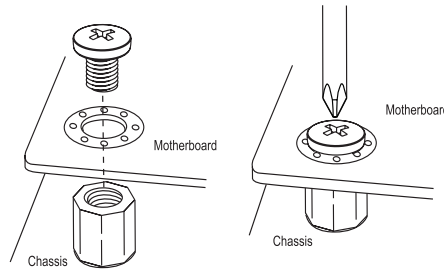

4. Install standoffs in the chassis as needed.
5. Install the motherboard into the chassis carefully to avoid damaging other motherboard components.
6. Using the Phillips screwdriver, insert a Phillips head #6 screw into a mounting hole on the motherboard and its matching mounting hole on the chassis.
7. Repeat Step 5 to insert #6 screws into all mounting holes.
8. Make sure that the motherboard is securely placed in the chassis.

**Note:** Images displayed are for illustration only. Your chassis or components might look different from those shown in this manual.

## 2.3 Processor and Heatsink Installation

### Notes:

- Use ESD protection.
- Shut down the system and then unplug the AC power cord from all power supplies.
- Check that the plastic protective cover is on the processor socket and none of the socket pins are bent. If they are, contact your retailer.
- When handling the processor, avoid touching or placing direct pressure on the LGA lands (gold contacts). Improper installation or socket misalignment can cause serious damage to the processor or socket, which may require manufacturer repairs.
- Thermal grease is pre-applied on a new heatsink. No additional thermal grease is needed.
- Refer to the Supermicro website for updates on processor support.
- All graphics in this manual are for illustrative purposes only. Your components may look different.
- Installing the processor does not require a screwdriver. Do not unscrew the processor socket.
- Installing the heatsink requires a Phillips #1 screwdriver.

### AMD EPYC™ 4005, 4004 Series or Ryzen™ 9000, 8700G, and 7000 Series Desktop Processor

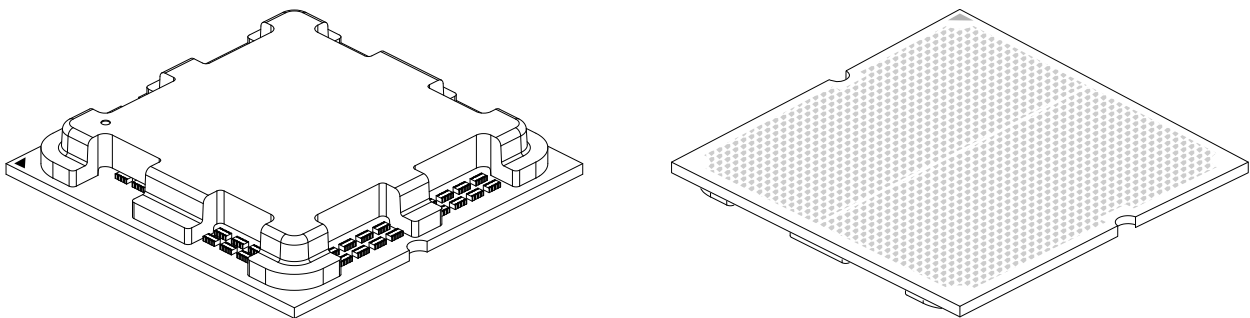

## Overview of the Processor Socket

The processor socket is protected by an outer plastic protective cover.

### 1. Outer Plastic Cover

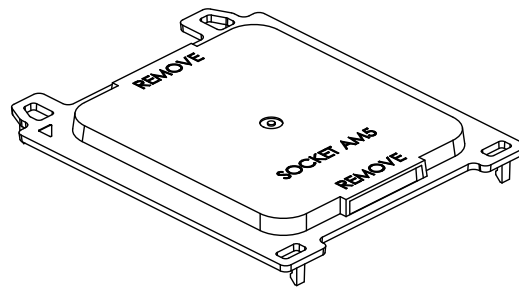

### 2. Socket AM5

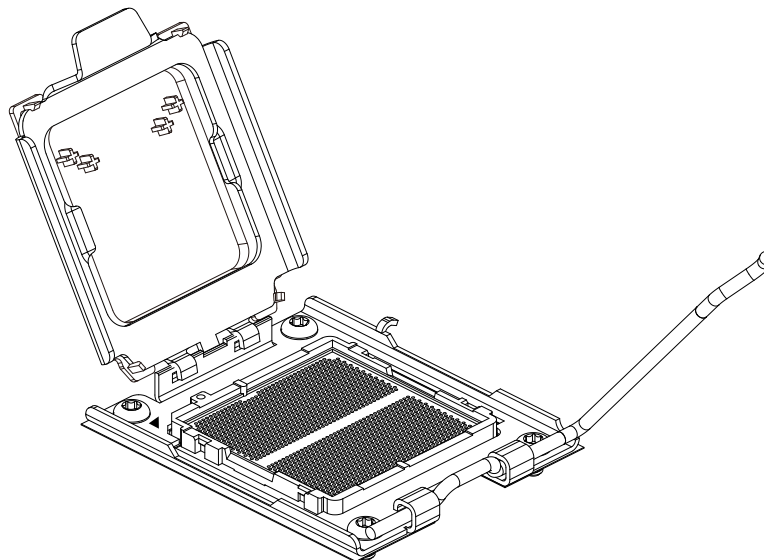



## Overview of the Heatsink

The heatsink (SNK-P0093AP4) is attached to the socket with Phillips #1 screws after the processor is secured. If this is a new heatsink, thermal grease is pre-applied.

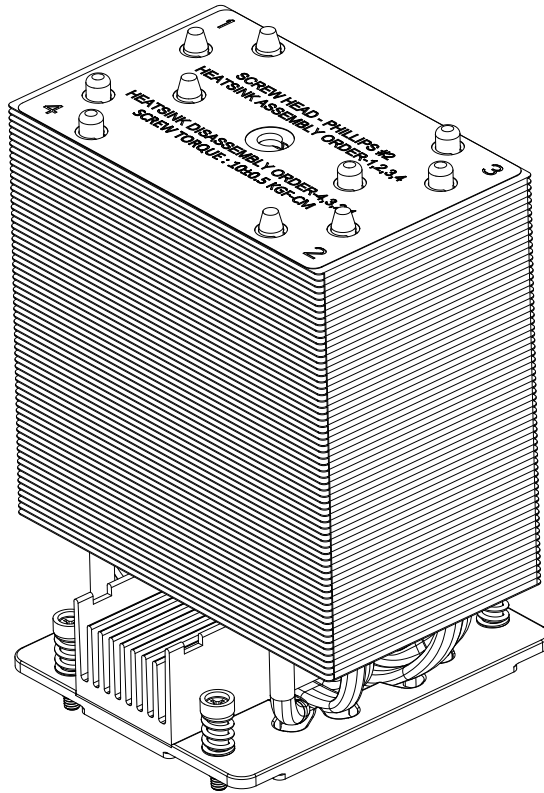

## Installing the Processor

**Note:** Do not remove the plastic cover covering the outside of the socket. This cover will pop out during installation of the processor.

1. Use a finger to push down the lever, then move the lever rightward. Pull the lever until it passes over the processor socket.

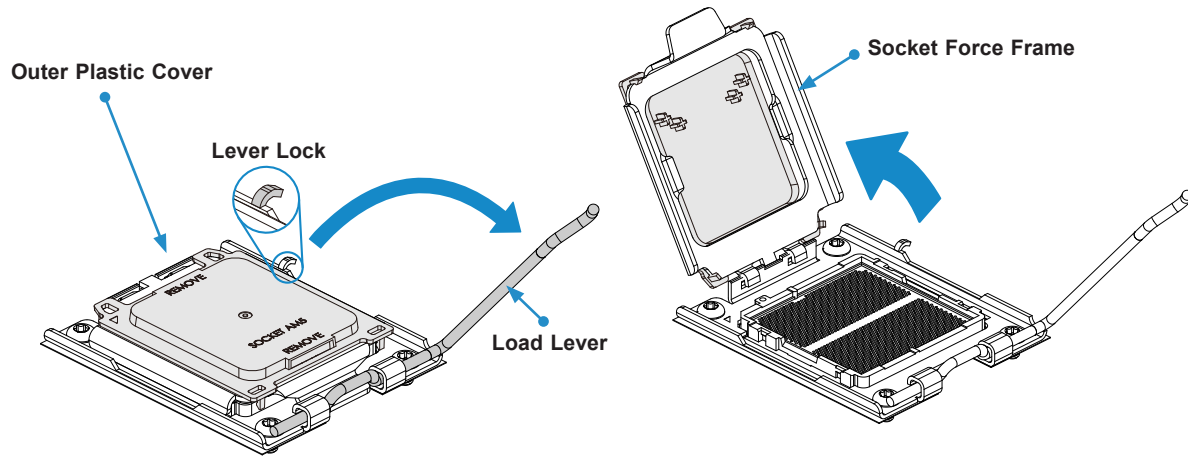

2. Pick up the processor on its left and right edges. Hold the processor over the socket and align the arrow on the top-left corner of the processor with the arrow on the top-left corner of the socket. Gently lower it onto the AM5 socket pins.

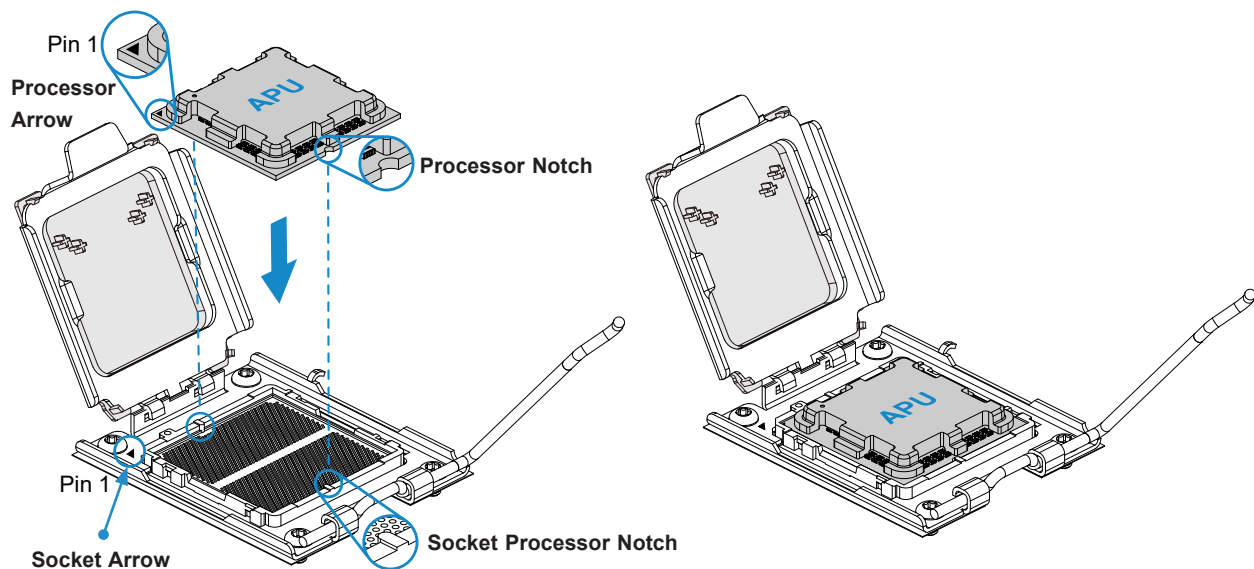

3. With the processor in the socket, lower the socket force frame.

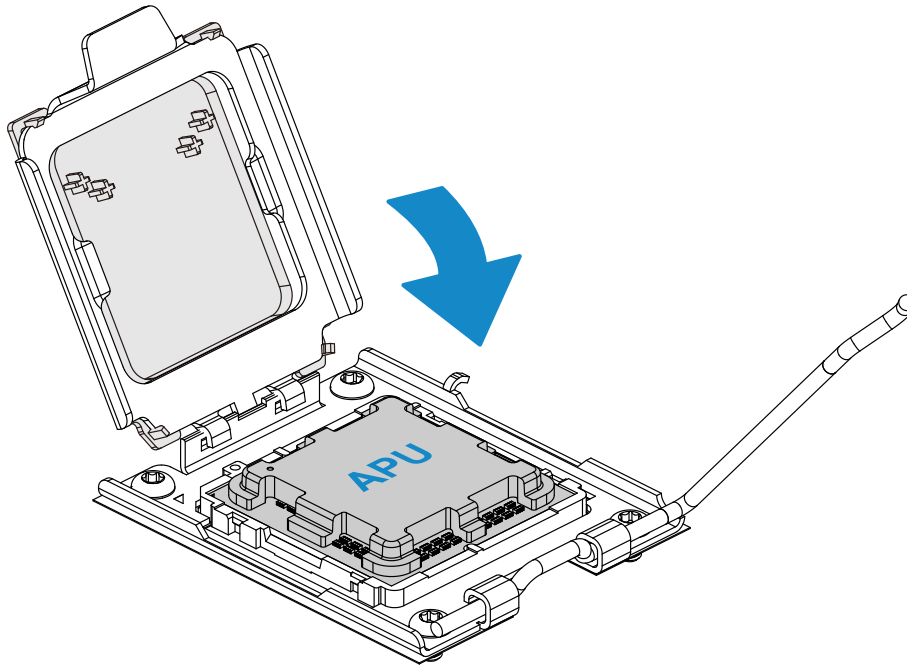

4. Reattach the lever arm onto the right side of the socket. The outer plastic cover will pop out when the lever arm is reattached.

**Note:** Store the outer plastic cover. Attach the outer plastic cover to the socket force frame when storing or transporting the motherboard without a processor.

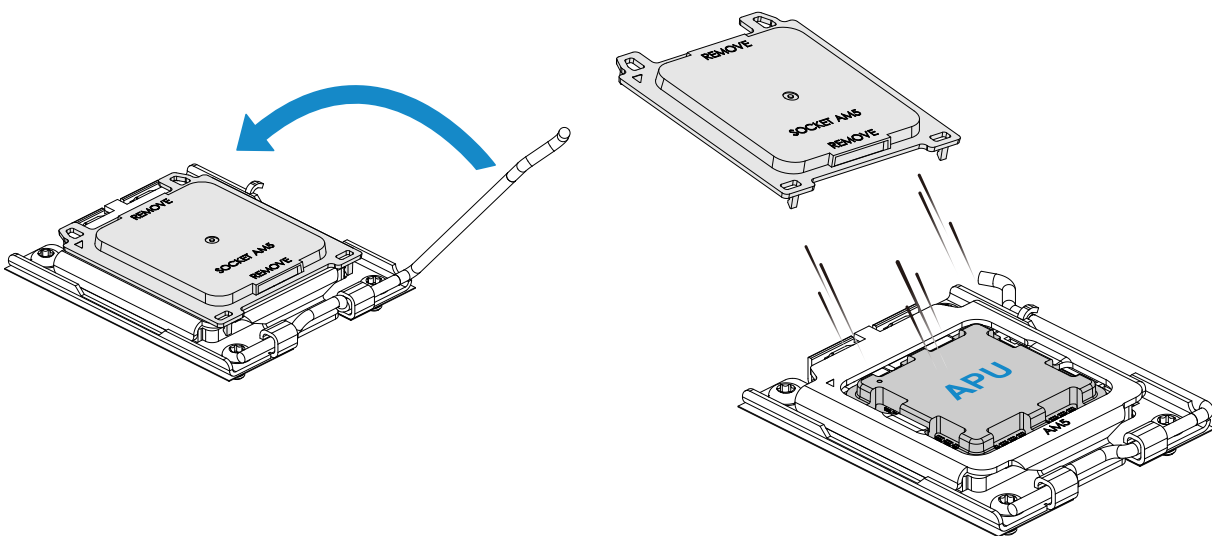

5. When finished, the socket force frame will secure the processor.

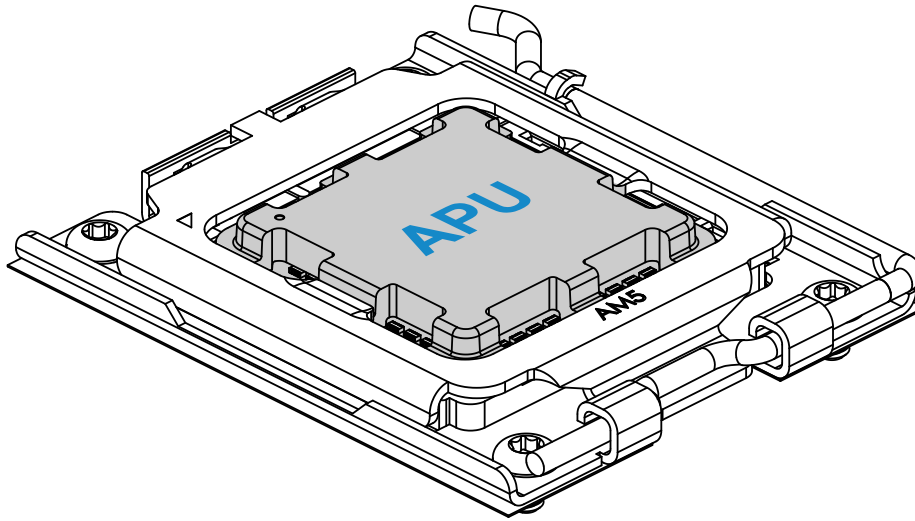

## Installing the Heatsink

1. After the processor is secured, now you must install the heatsink to the socket frame. Lower the heatsink down until the four screws on the heatsink align with the four screw holes on the socket frame.
2. Using a diagonal pattern, tighten the four screws down on the heatsink in the sequence 1-2-3-4 till it is secured. The heatsink will now be secured and you have finished installing the processor and heatsink onto the motherboard. When finished, the heatsink will be secured over the socket and processor.

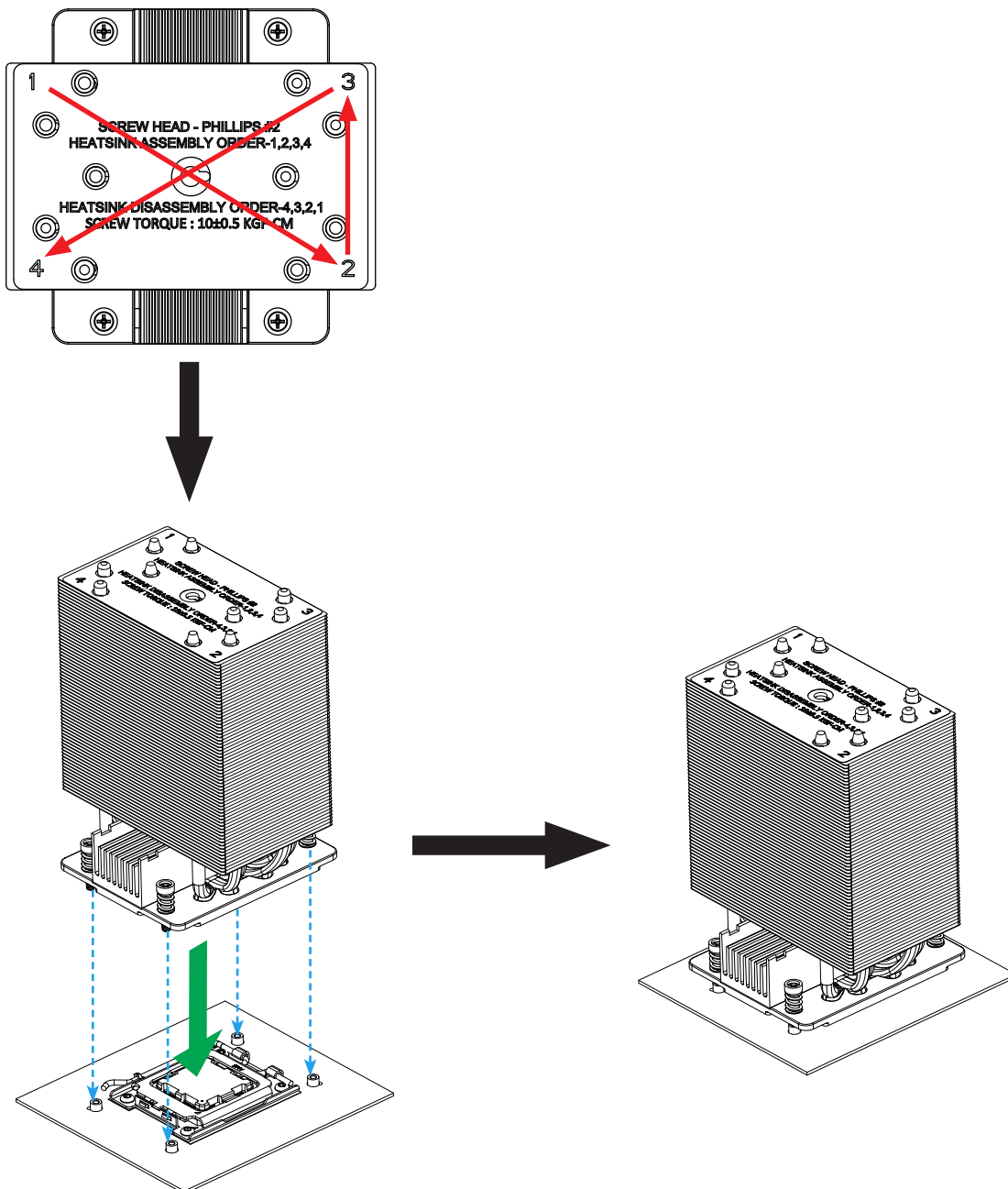

3. Install the heatsink cooling fan and holder assembly on the heatsink body and then tighten the single locking screw on top of the fan holder.

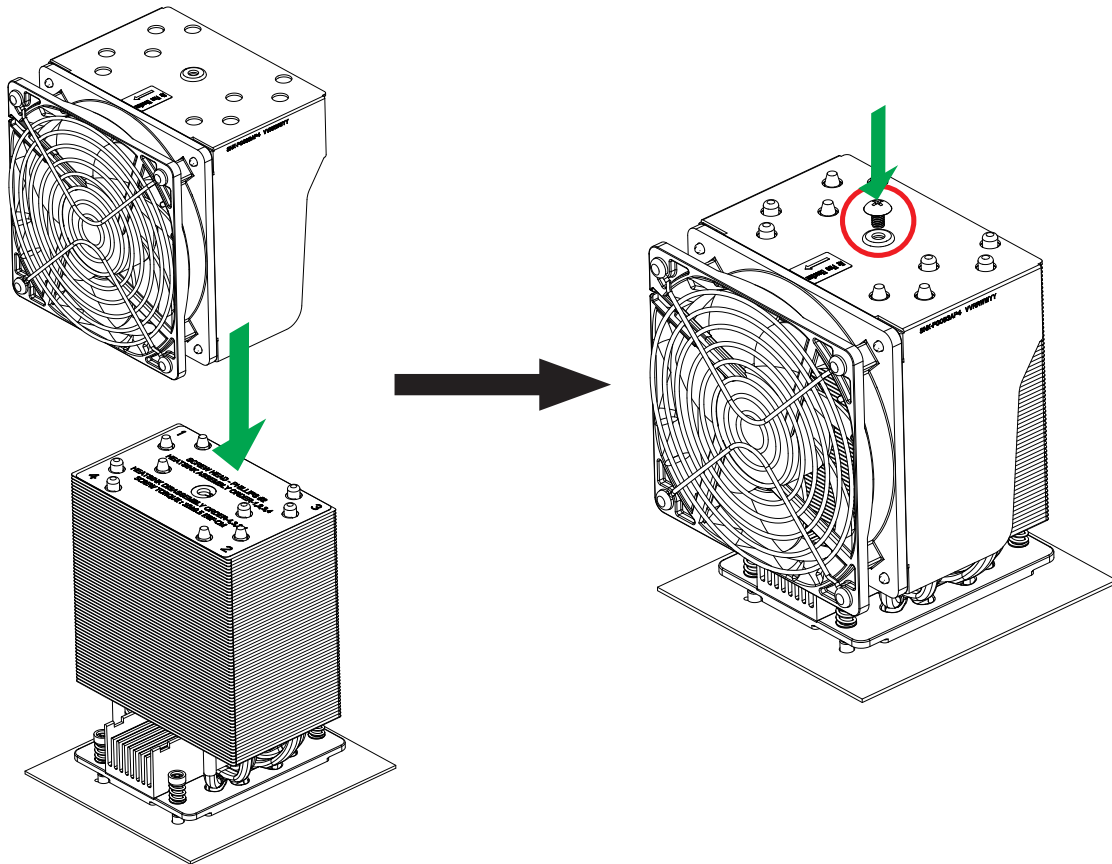

4. Connect cooling fan connector to the fan header labeled for CPU on the motherboard.

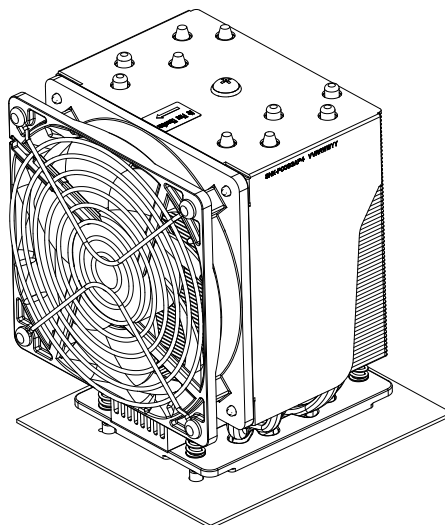

## Supported Processors and Operating Systems

This table provides an overview of the supported processors and operating systems compatible with H13SAE-MF. Please refer to this table to select the appropriate processor and operating system for your system configuration.

Supported Processors and Operating Systems				
Windows 10/11		Windows Server 2022	EPYC™ Windows Server 2022	
Ryzen™ 7000	Client OPNs	Server "A" OPNs	EPYC™ 4004	Server OPNs
Ryzen 9 7950X	100-000000514	100-000000514A	EPYC 4564P	100-000001476
Ryzen 9 7900X	100-000000589	100-000000589A	N/A	N/A
Ryzen 9 7900	100-000000590	100-000000590A	EPYC 4464P	100-000001478
Ryzen 7 PRO 7745	100-000000599	100-000000599A	N/A	N/A
Ryzen 7 7700X	100-000000591	100-000000591A	EPYC 4364P	100-000001477
Ryzen 7 7700	100-000000592	100-000000592A	EPYC 4344P	100-000001479
Ryzen 5 7600X	100-000000593	100-000000593A	N/A	N/A
Ryzen 5 PRO 7645	100-000000600	100-000000600A	N/A	N/A
N/A	N/A	N/A	EPYC 4124P	100-000001570
Ryzen 5 7600	100-0000001015	100-000001015A	EPYC 4244P	100-000001480
Ryzen 9 7950X3D	100-000000908	100-000000908A	EPYC 4584PX	100-000001481
Ryzen 9 7900X3D	100-000000909	100-000000909A	EPYC 4484PX	100-000001482
Ryzen 9 7800X3D	100-000000910	100-000000910A	N/A	N/A

## 2.4 Memory Support and Installation

**Note:** Check the Supermicro website for recommended memory modules.

**Important:** Exercise extreme care when installing or removing DIMM modules to prevent any possible damage.

### Memory Support

The H13SAE-MF motherboard supports up to 192 GB of ECC/Non ECC UDIMM DDR5 5600 MHz, populated in four DIMM slots. Refer to the table below for additional memory information.

#### Notes:

- Always use DDR5 DIMM modules of the same type, size and speed.
- For memory optimization, use only DIMM modules that have been validated by Supermicro. For the latest memory updates, please refer to our website at <http://www.supermicro.com/products/motherboard>.
- Please be aware that removing a DDR5 DIMM module at a slant angle may cause damages. It is recommend that you lift the module straight up out of the slot.
- The DDR5 DIMM module is NOT hot-swappable and be sure to disconnect power for a minimum of twenty seconds before inserting or removing it.
- Please be aware that removing a DDR5 DIMM module at a slant angle may cause damages. It is recommend that you lift the module straight up out of the slot.

DIMM Population Guide				
Type	Channel			
	A1	A2	B1	B2
1 DIMM			V	
2 DIMMs	V		V	
4 DIMMs	V	V	V	V

Populating DDR5 Memory Modules with AMD EPYC™ 4005, 4004 Series or Ryzen™ 9000, 8700G, and 7000 Series Desktop				
Type	Number of DIMM Sockets per Channel	Number of DIMMs Populated	Channel 0	Channel 1
SMT UDIMM	2	1	SR: 5200 MT/s DR: 5200 MT/s	Not Valid
		1	Not Valid	SR: 5200 MT/s DR: 5200 MT/s
		2	SR: 3600 MT/s DR: 3600 MT/s	SR: 3600 MT/s DR: 3600 MT/s



## DIMM Module Population Sequence

There is no specific order or sequence required when installing memory modules. However do keep the following in mind:

- The motherboard will support one, two or four modules. Note that three modules are not supported. However, to achieve the best memory performance, fully populate the motherboard with validated memory modules.

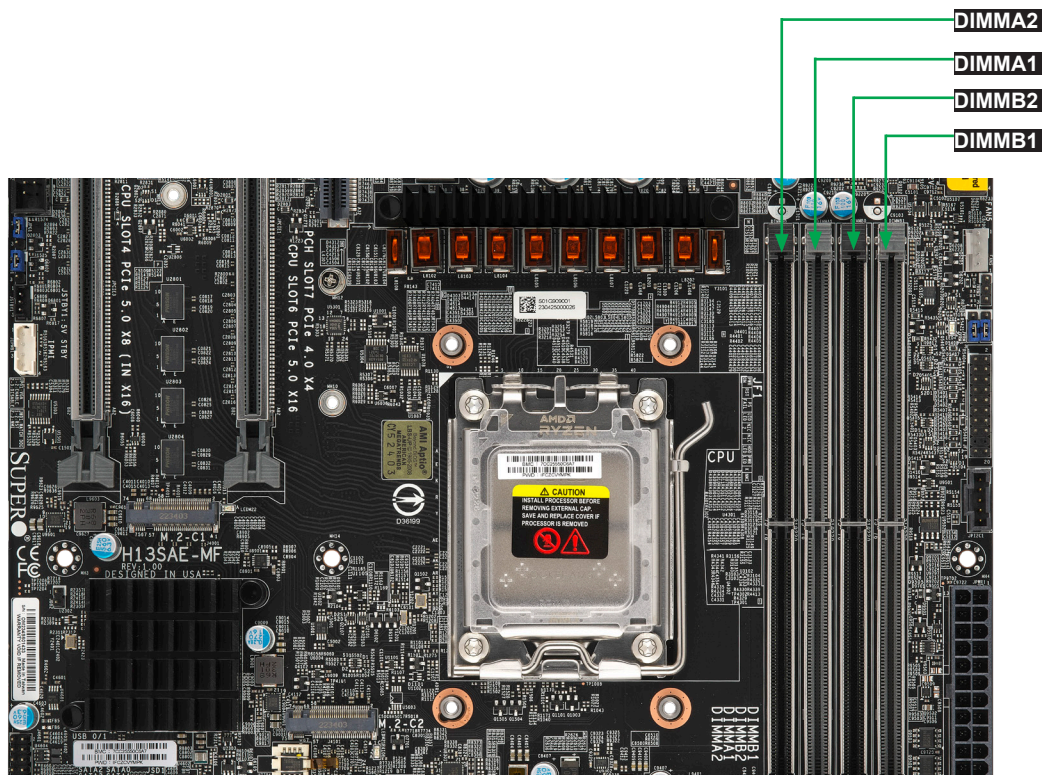
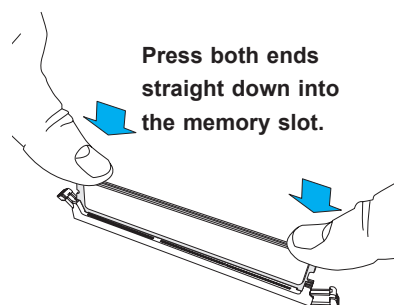
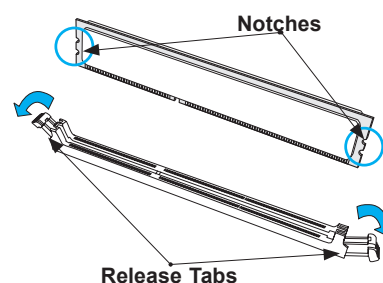
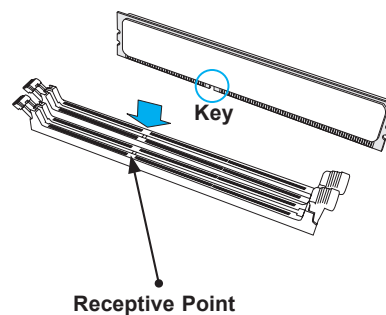

Figure 2-2. DIMM Numbering

## DIMM Installation

1. Insert the desired number of DIMMs into the memory slots. See [Memory Support](#) for details on memory population guidelines.
2. Push the release tabs outwards on both ends of the DIMM slot to unlock it.
3. Align the key of the DIMM module with the receptive point on the memory slot.
4. Align the notches on both ends of the module against the receptive points on the ends of the slot.
5. Press both ends of the module straight down into the slot until the module snaps into place.
6. Press the release tabs to the lock positions to secure the DIMM module into the slot.



## DIMM Removal

Press both release tabs on the ends of the DIMM module to unlock it. Once the DIMM module is loosened, remove it from the memory slot.

## 2.5 Rear I/O Ports

See Figure 2-3 below for the locations and descriptions of the various I/O ports on the rear of the motherboard.

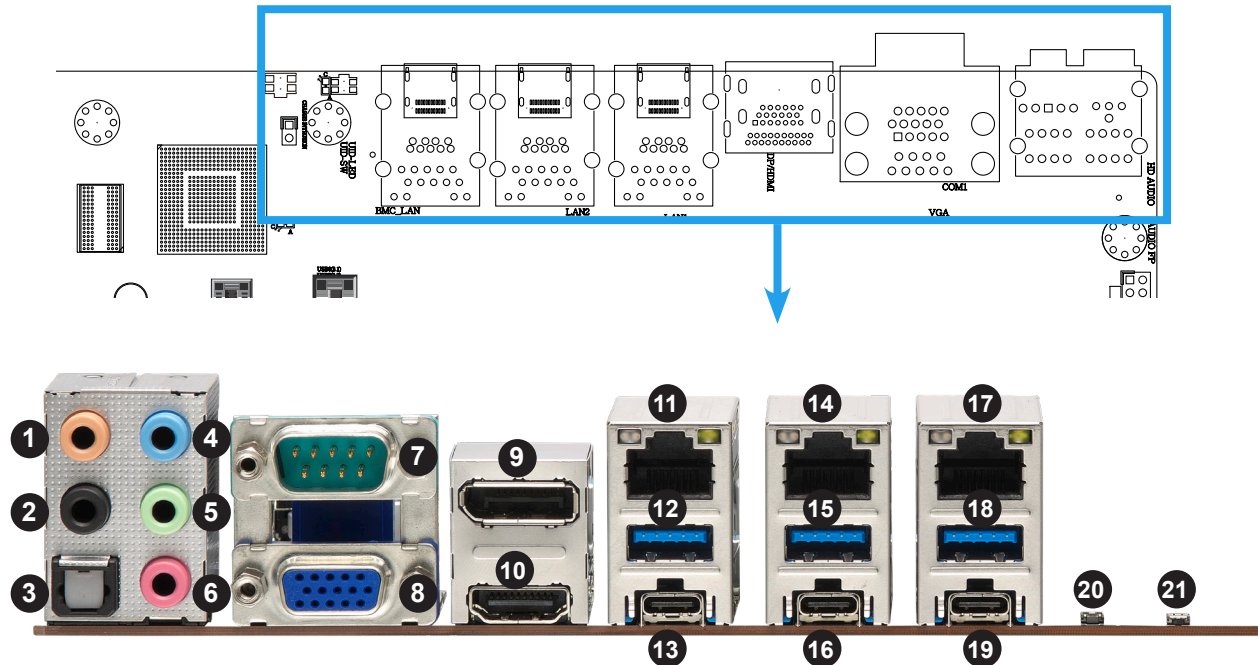

Figure 2-3. I/O Port Locations and Definitions

Rear I/O Ports			
#	Description	#	Description
1	Center/LFE Out	12	USB 3.2 Gen2 Type A (10 GbE)
2	Surround Out	13	USB 3.2 Gen2 Alt Mode*
3	S/PDIF Out	14	1 GbE RJ45 Port
4	Line In	15	USB 3.2 Gen2 Type A (10 GbE)
5	Line Out	16	USB 3.2 Gen2 Alt Mode*
6	Mic In	17	Dedicated IPMI LAN Port (1 GbE)
7	COM Port	18	USB 3.2 Gen2 Type A (10 GbE)
8	VGA Port	19	USB 3.2 Gen2x2 (20 GbE)
9	DisplayPort 1.4a	20	UID Switch
10	HDMI 2.0 Port	21	JUBUD1
11	1 GbE RJ45 Port		

\*Video out only supports one output at the same time, and it must use Type C to DP (standard) cable.

**1~2. Center/LFE Out and Surround Out**

This motherboard features a 7.1+2 Channel High Definition Audio (HDA) codec that provides 10 DAC channels. The HD Audio connections simultaneously supports multiple-streaming 7.1 sound playback with two channels of independent stereo output through the front panel stereo out for front, rear, center and subwoofer speakers. To enable this function, download the advanced software for this motherboard.

CEN/LFE is the audio output for the center channel and low frequency channel.

**3. S/PDIF Out**

This is a fibre optic audio output for a TOSLINK connector and cable.

**4. Line In**

This type of connector attaches audio devices.

**5. Line Out**

This is a headphone jack.

**6. Mic Port**

This is a microphone jack.

**7. COM Port**

One serial communications (COM) port is included on the rear I/O panel.

**8. VGA Port**

There is one VGA port on the rear I/O panel.

**9. DisplayPort 1.4a**

A Display Port on the rear I/O panel delivers digital display at a fast refresh rate. It can connect to virtually any display device using a DisplayPort adapter for devices, such as VGA, DVI, and HDMI 2.0. Note that 8K resolution is not supported.

**10. HDMI 2.0 Port**

There is one HDMI 2.0 port on the rear I/O panel. Note that 8K resolution is not supported.

**11 & 14. 1 GbE RJ45 Ports**

There are two 1 GbE RJ45 ports on the rear I/O panel.

**Note:** Location 11 supports shared IPMI LAN port, location 14 does not support shared IPMI LAN port.

### 12~13, 15~16, 18~19 Universal Serial Bus (USB) Ports

There are two USB 3.2 Gen2 Alt Mode ports, three USB 3.2 Gen2 Type A ports, and one USB 3.2 Gen2x2 Port on the rear I/O panel.

### 17. Dedicated IPMI LAN Port

One dedicated IPMI LAN port is located on the rear I/O panel. This port accepts an RJ45 type cable.

### 20. UID Switch and UID LED

A Unit Identifier (UID SW) switch and UID LED (LED1) are located on the I/O backpanel. The rear UID LED (LED1) is located next to the UID switch. When you press the UID switch, both rear and front UID LED indicators will turn on. Press the UID switch again to turn off the LED indicators. The UID Indicator provides easy identification of a system that may be in need of service. See [Section 2.6](#) for the front panel UID LED header location on JF1.

**Note:** UID can also be triggered via IPMI on the serverboard. For more information on IPMI, please refer to the IPMI User's Guide posted on our website at <http://www.supermicro.com>

### 21. JUBUD1 Button

A JUBUD1 button on the rear I/O panel allows BIOS recovery.

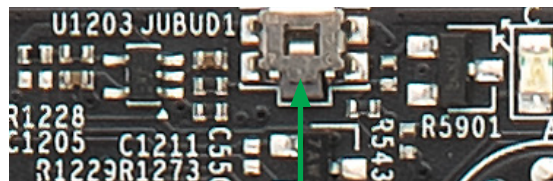

JUBUD1

## 2.6 Front Control Panel

JF1 contains header pins for various buttons and indicators that are normally located on a control panel at the front of the chassis. These connectors are designed specifically for use with Supermicro chassis. See the figure below for the location of JF1.

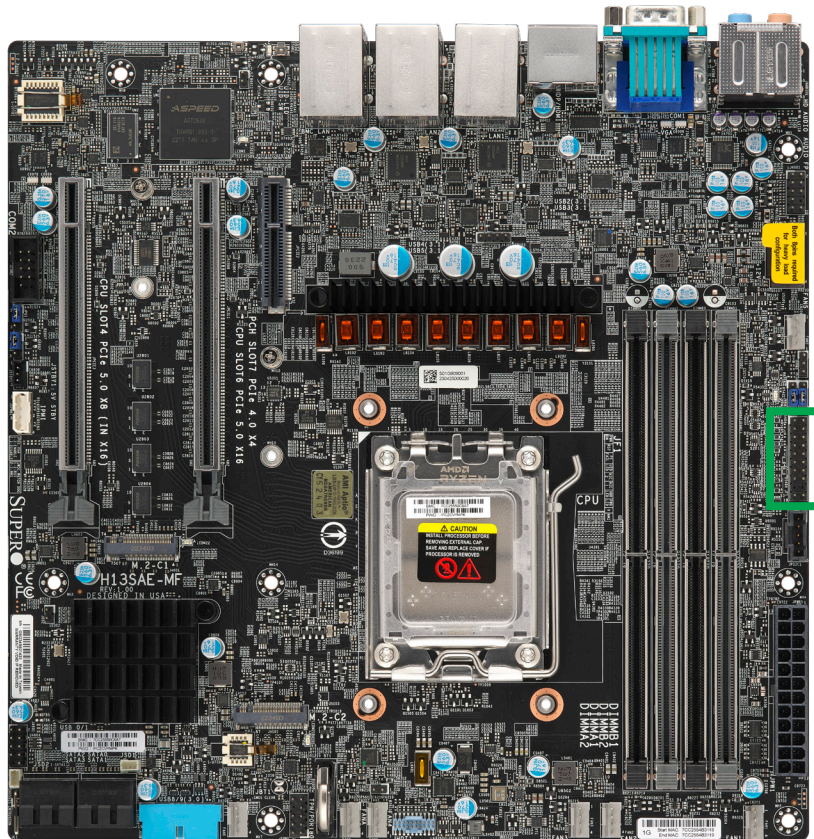

	1	2	
Power Switch	○	○	Ground
Reset Switch	○	○	Ground
Power Fail LED+	○	○	Power Fail LED-
UID LED+	○	○	UID LED-
NIC2 Link LED+	○	○	NIC2 Link LED-
NIC1 Link LED+	○	○	NIC1 Link LED-
HDD LED+/UID Switch+	○	○	HDD LED-
PWR LED+	○	○	PWR_LED-
Key, no pin	○	○	Key, no pin
NMI Switch	○	○	Ground
	19	20	

Figure 2-4. JF1 Pin Definitions

## Front Control Panel Pin Definitions

### Power Button

The Power Button connection is located on pins 1 and 2 of JF1. Momentarily contacting both pins will power on/off the system. This button can also be configured to function as a suspend button (with a setting in the BIOS - see Chapter 4). To turn off the power in the suspend mode, press the button for at least 4 seconds. Refer to the table below for pin definitions.

Power Button Pin Definitions (JF1)	
Pin#	Definition
1	Power Switch
2	Ground

### Power LED

The Power LED connection is located on pins 15 and 16 of JF1. Refer to the table below for pin definitions.

Power LED Pin Definitions (JF1)	
Pin#	Definition
15	PWR_LED+
16	PWR_LED-

### Power Fail LED

The Power Fail LED connection is located on pins 5 and 6 of JF1. Refer to the table below for pin definitions.

Power Fail LED Pin Definitions (JF1)	
Pin#	Definition
5	Power Fail LED+
6	Power Fail LED-

### Reset Button

The Reset Button connection is located on pins 3 and 4 of JF1. Attach the hardware reset switch from the computer case to this header to reset the system. Refer to the table below for pin definitions.

Reset Button Pin Definitions (JF1)	
Pin#	Definition
3	Reset Switch
4	Ground

### Storage Drive LED

The Storage Drive LED connection is located on pins 13 and 14 of JF1. Attach a drive LED cable here to display disk activity detected on the motherboard's built-in disk controllers. See the table below for pin definitions.

Storage Drive LED Pin Definitions (JF1)	
Pin#	Definition
13	Drive LED+/UID Switch+
14	Drive_LED-

### UID LED

The UID LED is on pins 7 and 8 of JF1. Connect the front panel UID LED to this header to indicate when the rear UID switch is turned on. Refer to the table below for pin definitions.

UID LED Pin Definitions (JF1)	
Pin#	Definition
7	UID LED+
8	UID LED-



## 2.7 Connectors

### Power Connections

#### 12V 8-pin Auxiliary Power Connector (JPW2)

JPW2 is an 8-pin ATX power input to provide auxiliary power to the processor. Refer to the table below for pin definitions.

12V 8-pin Power Connector Pin Definitions			
Pin#	Definition	Pin#	Definition
1	Ground	5	+12V
2	Ground	6	+12V
3	Ground	7	+12V
4	Ground	8	+12V

#### Main Power Supply Connector (JPW1)

The primary power supply connector (JPW1) is an ATX power connector that the power supply plugs directly into.

ATX Power 24-pin Connector Pin Definitions			
Pin#	Definition	Pin#	Definition
1	+3.3V	13	+3.3V
2	+3.3V	14	-12V
3	Ground	15	Ground
4	+5V	16	PS_ON
5	Ground	17	Ground
6	+5V	18	Ground
7	Ground	19	Ground
8	PWR_OK	20	Res (NC)
9	5VSB	21	+5V
10	+12V	22	+5V
11	+12V	23	+5V
12	+3.3V	24	Ground

## Headers

### Audio Front Panel Header

A 10-pin audio header (AUDIO FP) located on the motherboard allows you to use the onboard sound chip (ALC888S) for audio function. Connect an audio cable to this header to use this feature. Refer to the table below for pin definitions.

Audio Header Pin Definitions			
Pin#	Definition	Pin#	Definition
1	Microphone_Left	2	Audio_Ground
3	Microphone_Right	4	Audio_Detect
5	Line_2_Right	6	Ground
7	Jack_Detect	8	Key
9	Line_2_Left	10	Ground

### Chassis Intrusion (JL1)

A Chassis Intrusion header is located at JL1 on the motherboard. Attach the appropriate cable from the chassis to the header to inform you when the chassis has been opened.

Chassis Intrusion Pin Definitions	
Pins	Definition
1	Intrusion Input
2	Ground

### COM Header

There are two COM headers on the motherboard. COM1 is located next to the VGA port, and COM2 is located next to the JPG1 jumper. (PCI 33MHz). Refer to the table below for pin definitions.

COM Header Pin Definitions			
Pin#	Definition	Pin#	Definition
1	DCD	6	DSR
2	RXD	7	RTS
3	TXD	8	CTS
4	DTR	9	RI
5	Ground	10	N/A

### 4-pin External BMC I2C Header

A System Management Bus header for IPMI 2.0 is located at JIPMB1. Connect a cable to this header to use the IPMB I<sup>2</sup>C connection on your system. Refer to the table below for pin definitions.

External I <sup>2</sup> C Header Pin Definitions	
Pin#	Definition
1	Data
2	Ground
3	Clock
4	+3.3V Stdbby

### FAN Headers

There are two system fan headers (FANA~FANB) and six CPU fan headers (FAN1~FAN5) on this motherboard. These are 4-pin fan headers; pins 1-3 are backward compatible with traditional 3-pin fans. The onboard fan speeds are controlled by Thermal Management (via Hardware Monitoring) in the BMC. When using Thermal Management setting, please use all 4-pin fans.

System Fan Headers Pin Definitions	
Pin#	Definition
1	Ground
2	+12V (Red)
3	Tachometer
4	PWM Control

### Onboard Battery (BT1)

The onboard back up battery is located at BT1. The onboard battery provides backup power to the on-chip CMOS, which stores the BIOS' setup information. It also provides power to the Real Time Clock (RTC) to keep it running.

### PCIe M.2 Connectors (M.2-C1, M.2-C2)

The PCIe M.2 connectors are for devices such as memory cards, wireless adapters, etc. These devices must conform to the PCIe M.2 specifications (formerly known as NGFF). These particular PCIe M.2 connectors support M-Key (PCIe x2) storage cards. M.2-C1 and M.2-C2 can support a speed of PCIe 5.0.

### Standby Power Header

The Standby Power header is located at JSTBY1 on the motherboard.

Standby Power Pin Definitions	
Pin#	Definition
1	+5V Standby
2	Ground
3	Wake-up

### TPM/Port 80 Header (JTPM1)

A Trusted Platform Module (TPM)/Port 80 header is located at JTPM1 to provide TPM support and Port 80 connection. Use this header to enhance system performance and data security. Refer to the table below for pin definitions. Please go to the following link for more information on the TPM: <http://www.supermicro.com/manuals/other/TPM.pdf>.

Trusted Platform Module Header Pin Definitions			
Pin#	Definition	Pin#	Definition
1	+3.3V	2	SPI_CS#
3	RESET#	4	SPI_MISO
5	SPI_CLK	6	GND
7	SPI_MOSI	8	NC
9	+1.8V Stdby	10	SPI_IRQ#

### USB Ports (USB0~1, USB8~9)

There are a total of nine USB ports supported on the motherboard. Four are located on the front panel, and five are located on the back panel. Note that USB devices are not able to wake up from S3/S4 state.

Front Panel USB 0/1 (2.0) Pin Definitions			
Pin#	Definition	Pin#	Definition
1	+5 V	2	+5 V
3	USB_N	4	USB_N
5	USB_P	6	USB_P
7	Ground	8	Ground
9	NC	10	OC

Front Panel USB 8/9 (3.0) Pin Definitions			
Pin#	Definition	Pin#	Definition
1	+5 V		
2	USB3_RN	19	+5 V
3	USB3_RN	18	USB_SSRXN
4	GND	17	USB_SSRXP
5	USB3_TN	16	GND
6	USB3_TP	15	USB_SSTXN
7	GND	14	USB_SSTXP
8	USB_N	13	GND
9	USB_P	12	USB_D-
10	GND	11	USB_D+

## 2.8 Jumper Settings

### How Jumpers Work

To modify the operation of the motherboard, jumpers can be used to choose between optional settings. Jumpers create shorts between two pins to change the function of the connector. Pin #1 is identified with a square solder pad on the printed circuit board. See the diagram below for an example of jumping pins 1 and 2. Refer to the motherboard layout page for jumper locations.

**Note:** On two-pin jumpers, "Closed" means the jumper is on and "Open" means the jumper is off the pins.

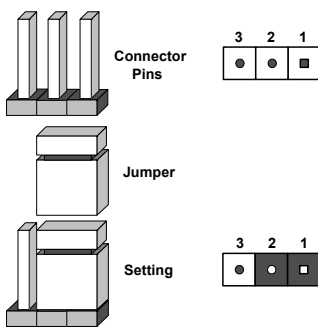

### CMOS Clear (JBT1)

JBT1 is used to clear CMOS, which will also clear any passwords. Instead of pins, this jumper consists of contact pads to prevent accidentally clearing the contents of CMOS.

#### **To Clear CMOS**

1. First power down the system and unplug the power cord(s).
2. Remove the cover of the chassis to access the motherboard.
3. Remove the CMOS battery from the motherboard.
4. Short the CMOS pads with a metal object such as a small screwdriver for at least four seconds.
5. Remove the screwdriver (or shorting device).
6. Re-install the CMOS battery on the motherboard.
7. Replace the cover, reconnect the power cord(s), and power on the system.

**Note:** Clearing CMOS will also clear all passwords.

Do not use the PW\_ON connector to clear CMOS.



## Unit Identifier Switch

A Unit Identifier (UID) switch and an LED Indicator are located on the motherboard. The UID switch is located at JUIDB1, which is next to the VGA port on the back panel. The UID LED is located next to the UID switch. When you press the UID switch, the UID LED will be turned on. Press the UID switch again to turn off the LED indicator. The UID Indicator provides easy identification of a system unit that may be in need of service.

**Note:** The UID can also be triggered via IPMI on the motherboard. For more information on IPMI, please refer to the IPMI User's Guide posted on our website at <http://www.supermicro.com>.

UID Switch Pin Definitions	
Pin#	Definition
1	GND
2	GND
3	Button In
4	Button In

## VGA Enable/Disable (JPG1)

JPG1 allows you to enable or disable the VGA port using the onboard graphics controller. The default setting is Enabled.

VGA Enable/Disable Pin Definitions	
Pin#	Definition
1-2	Enabled
2-3	Disabled

## Watch Dog

JWD1 controls the Watch Dog function. Watch Dog is a monitor that can reboot the system when a software application hangs. Jumping pins 1-2 will cause Watch Dog to reset the system if an application hangs. Jumping pins 2-3 will generate a non-maskable interrupt (NMI) signal for the application that hangs. Watch Dog must also be enabled in BIOS. The default setting is Reset.

**Note:** When Watch Dog is enabled, the user needs to write their own application software to disable it.

Watch Dog Jumper Settings	
Jumper Setting	Definition
Pins 1-2	Reset (Default)
Pins 2-3	NMI
Open	Disabled

## 2.9 LED Indicators

### BMC Heartbeat LED (LEDM1)

A BMC Heartbeat LED is located at LEDM1 on the motherboard. When LEDM1 is blinking, the BMC is functioning normally. See the table below for more information.

BMC Heartbeat LED State		
Color	State	Definition
Green	Solid On	BMC is not ready
Green	Blinking	BMC Normal
Green	Fast Blinking	BMC: Initializing

### BMC LAN Port LEDs

A dedicated BMC LAN is located on the rear I/O panel and has two LED indicators. The LED on the right indicates connection and activity, while the LED on the left indicates the speed of connection. The Link LED may amber, green, or off to indicate the speed of the connection. Refer to the tables below for more information.

Link LED, Connection Link Speed Indicator	
LED Color	Definition
Amber	1 GbE/s
Green	100 Mb/s
Off	10 Mb/s

Activity LED		
Color	State	Definition
None	No Connection	
Yellow	Solid On	Link
Yellow	Flashing	Active

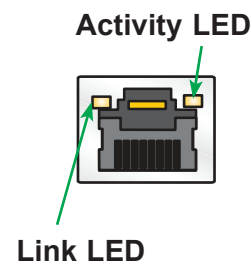

### M.2-C1 and M.2-C2

Two M.2 indicators blink green when they are functioning normally.

Onboard Power LED Indicator	
LED Color	Definition
Blinking Green	Device working

## RJ45 LEDs

The LED on the right indicates connection and activity, while the LED on the left indicates the speed of connection. The Link LED may amber, green, or off to indicate the speed of the connection. Refer to the tables below for more information.

Link LED, Connection Link Speed Indicator	
LED Color	Definition
Amber	1 GbE/s
Green	100 Mb/s
Off	10 Mb/s

Activity LED		
Color	State	Definition
None	No Connection	
Yellow	Solid On	Link
Yellow	Flashing	Active

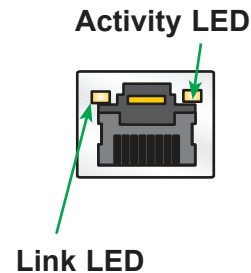

## UID LED Indicator (LED1)

The UID LED1 is located next to the UID switch. The front UID LED is located on the front panel. When you press the UID switch, both rear UID LED and front UID LED indicators will turn on. Press the UID switch again to turn off the LED indicators. Use this UID Indicator to 'mark' the system, so the system can be easily identified whether on the front or back (e.g., a system rack with multiple units installed).

UID LED Indicator		
Color	State	Definition
None	Off	UID Off
Blue	Solid On	Unit Identified by Local UID Switch
Blue	Slow Blinking	Unit Identified via IPMI Web Interface



# Chapter 3

## Troubleshooting

### 3.1 Troubleshooting Procedures

Use the following procedures to troubleshoot your system. If you have followed all of the procedures below and still need assistance, refer to the 'Technical Support Procedures' and/or 'Returning Merchandise for Service' section(s) in this chapter. Always disconnect the AC power cord before adding, changing or installing any non hot-swap hardware components.

#### Before Power On

1. Check that the BMC Heartbeat (LEDM1) is blinking before the motherboard is turned on.
2. Check that the Onboard Power OK (LED4) on the motherboard is on.
3. Make sure that the power connector is connected to your power supply.
4. Make sure that no short circuits exist between the motherboard and chassis.
5. Disconnect all cables from the motherboard, including those for the keyboard and mouse.
6. Remove all add-on cards.
7. Install a CPU, a heatsink\*, and at least one DIMM on the motherboard. Check all jumper settings properly. \*Make sure that the heatsink is fully seated.
8. Use the correct type of onboard CMOS battery (CR2032) as recommended by the manufacturer. To avoid possible explosion, do not install the CMOS battery upside down.

#### No Power

1. Make sure that no short circuits exist between the motherboard and the chassis.
2. Verify that all jumpers are set to their default positions.
3. Check that the 115 V/230 V switch on the power supply is properly set.
4. Turn the power switch on and off to test the system
5. The CMOS battery on your motherboard may be old. Check to verify that it still supplies approximately 3 VDC. If it does not, replace it with a new one.

## No Video

### **A. If you're facing a no-video issue, start with these basic checks:**

1. Check that the VGA cable is connected properly, and the monitor is on.
2. Check if you follow the guidelines to install the memory module (see *DIMM Module Population* in chapter 2).
3. Reseat the memory DIMM modules.

**Note:** If you are a system integrator, VAR or OEM, a POST diagnostics card is recommended.

### **B. When Windows is installed on the H13SAE-MF motherboard, there's no display output on either HDMI or DisplayPort.**

1. Enter BIOS setup.
2. Navigate to the Advanced tab.
3. Enter PCIe/PCI/PnP Configuration page.
4. Locate the setting "Onboard VGA Function."
5. Change the setting from "Enabled" to "Disabled."
6. Save your changes and exit BIOS setup.

**Note:** The following table illustrates scenarios where only one display output functions in dual-monitor configurations on the H13SAE-MF motherboard:

Multi-Output Display Configuration: VGA, HDMI, and DisplayPort			
Configuration	VGA	HDMI	DisplayPort
VGA and HDMI	Active	No Display	N/A
VGA and DisplayPort	Active	N/A	No Display
HDMI and DisplayPort	N/A	No Display	No Display

## System Boot Failure

If the system does not display POST (Power-On-Self-Test) or does not respond after the power is turned on, check the following:

1. Clear the CMOS settings by unplugging the power cord and contacting both pads on the CMOS Clear Jumper (JBT1). Refer to chapter 2.
2. Remove all components from the motherboard, especially the DIMM modules.
3. Turn on the system with only one DIMM module installed. If the system boots, check for bad DIMM modules or slots by following the Memory Errors Troubleshooting procedure in this Chapter.

## Memory Errors

1. Make sure that the DIMM modules are properly and fully installed.
2. Confirm that you are using the correct memory. Also, it is recommended that you use the same memory type and speed for all DIMMs in the system. See Section 2.4 for memory details.
3. Check for bad DIMM modules or slots by swapping modules between slots and noting the results.
4. Check the power supply voltage 115 V/230 V switch.

## The System Cannot Retain the Setup Configuration

1. Make sure that you are using a high quality power supply. A poor quality power supply may cause the system to lose the CMOS setup information. Refer to Section 1 for details on power supplies.
2. The battery on your motherboard may be old. Check to verify that it still supplies approximately 3 VDC. If it does not, replace it with a new one.
3. If the above steps do not fix the setup configuration problem, contact your vendor for repairs.

## When the System Becomes Unstable

### ***A. If the system becomes unstable during or after OS installation, check the following:***

1. CPU/BIOS support: Make sure that your CPU is supported and that you have the latest BIOS installed in your system.
2. Memory support: Make sure that the memory modules are supported by testing the modules using memtest86 or a similar utility.

**Note:** Refer to the product page on our website at <http://www.supermicro.com> for memory and CPU support and updates.

3. Drive support: Make sure that all storage drives work properly. Replace the bad drives with good ones.
4. System cooling: Check the system cooling to make sure that all heatsink fans and CPU/system fans, etc., work properly. Check the hardware monitoring settings in the IPMI to make sure that the CPU and system temperatures are within the normal range. Also check the front panel Overheat LED and make sure that it is not on.

5. Adequate power supply: Make sure that the power supply provides adequate power to the system. Make sure that all power connectors are connected. Please refer to our website for more information on the minimum power requirements.
6. Proper software support: Make sure that the correct drivers are used.

***B. If the system becomes unstable before or during OS installation, check the following:***

1. Source of installation: Make sure that the devices used for installation are working properly, including boot devices such as USB flash or media drives.
2. Cable connection: Check to make sure that all cables are connected and working properly.
3. Using the minimum configuration for troubleshooting: Remove all unnecessary components (starting with add-on cards first), and use the minimum configuration (but with a CPU and a memory module installed) to identify the trouble areas. Refer to the steps listed in Section A above for proper troubleshooting procedures.

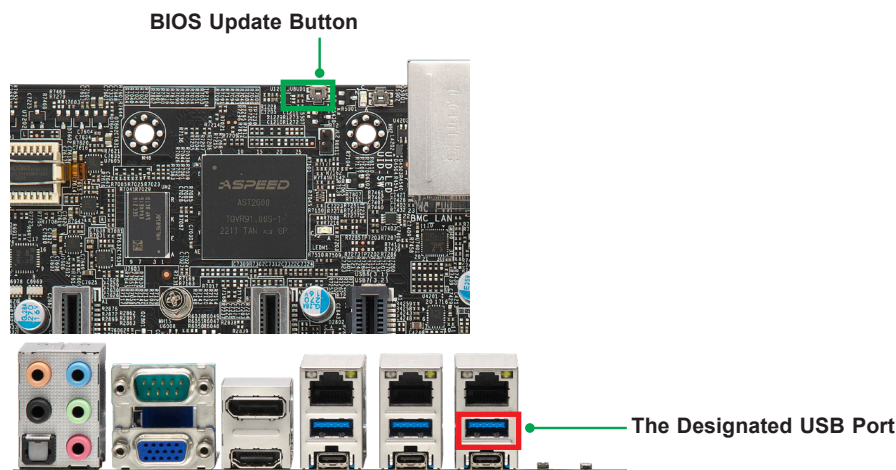

4. Identifying bad components by isolating them: If necessary, remove a component in question from the chassis, and test it in isolation to make sure that it works properly. Replace a bad component with a good one.
5. Check and change one component at a time instead of changing several items at the same time. This will help isolate and identify the problem.
6. To find out if a component is good, swap this component with a new one to see if the system will work properly. If so, then the old component is bad. You can also install the component in question in another system. If the new system works, the component is good and the old system has problems.

## When BIOS Firmware Update Fails

***If the BIOS firmware fails to be updated or accidental disconnection causes firmware update fail, follow these steps to update BIOS firmware:***

1. Locate these two files in the BIOS package and save them in a USB 2.0 flash drive: BIOSUBU.BIN and the BIOS image file, e.g., "BIOS\_H13SAE-1C97\_20230329\_1.0\_STDsp.bin."
2. Rename the BIOS image file (e.g., "BIOS\_H13SAE-1C97\_20230329\_1.0\_STDsp.bin") as "PSPBIOS.IMG."
3. While the system is in shutdown state, insert the flash drive to the designated USB port, hold down the Update button on the motherboard and press the Power button on the system.
4. Wait about ten minutes for the update to complete. When the update is complete, the system will automatically restart.

## 3.2 Technical Support Procedures

**Before contacting Technical Support, please take the following steps.** Also, note that as a motherboard manufacturer, we do not sell directly to end-users, so it is best to first check with your distributor or reseller for troubleshooting services. They should know of any possible problem(s) with the specific system configuration that was sold to you.

1. Please review the 'Troubleshooting Procedures' and 'Frequently Asked Questions' (FAQs) sections in this chapter or see the FAQs on our website before contacting Technical Support.
2. BIOS upgrades can be downloaded from our website.  
**Note:** Not all BIOS can be flashed depending on the modifications to the boot block code.
3. If you still cannot resolve the problem, include the following information when contacting us for technical support:
  - Motherboard model and PCB revision number
  - BIOS release date/version (this can be seen on the initial display when your system first boots up)
  - System configuration

An example of a Technical Support form is posted on our website.

**Distributors:** For immediate assistance, please have your account number ready when contacting our technical support department by e-mail.

### 3.3 Frequently Asked Questions

**Question: What type of memory does my motherboard support?**

**Answer:** The H13SAE-MF motherboard supports up to 192 GB of ECC/Non ECC UDIMM DDR5 5600 MHz in 4 slots. See [Section 2.4](#) for details on installing memory.

**Question: How do I update my BIOS?**

**Answer:** It is recommended that you **do not** upgrade your BIOS if you are not experiencing any problems with your system. Updated BIOS files are located on our website at <http://www.supermicro.com>.

To update your BIOS:

1. Please check the BIOS warning message and the information on how to update your BIOS on our website.
2. Select your motherboard model and check the current BIOS revision to make sure it is newer than your motherboard's installed BIOS before downloading.
3. Download the zip file and save the BIOS package to your computer.
4. Unzip the BIOS files onto a USB stick with FAT/FAT32 file system.
5. Boot to the motherboard's built-in UEFI Shell and type the following to start the BIOS update process:

```
FLASH.nsh BIOSname#.### <ENTER>
```

**Note:** Supermicro no longer supports the BIOS update method in DOS.

6. Perform an A/C power cycle after the message indicating the BIOS update has completed. You may refer to the "Readme" file in BIOS package for more details.

**Question: Why can't I turn off the power using the momentary power on/off switch?**

**Answer:** The instant power off function is controlled in BIOS by the Power Button Mode setting. When the On/Off feature is enabled, the motherboard will have instant off capabilities as long as the BIOS has control of the system. When the 4 Seconds Override feature is enabled or when the BIOS is not in control such as during memory count (the first screen that appears when the system is turned on), the momentary on/off switch must be held for more than four seconds to shutdown the system. This feature is required to implement the ACPI features on the motherboard.

**Question:** On an H13SAE-MF system running Windows 11 with the TPM set to fTPM in the BIOS and BitLocker enabled, are there any specific considerations I need to be mindful of when replacing the CPU?

**Answer:** Before changing the CPU, please back up the BitLocker key. After changing the CPU, a message "New CPU installed, fTPM/PSP NV corrupted, or fTPM/PSP NV structure changed. Press <Y> to reset fTPM..., N to keep the previous fTPM..." appears on the POST screen. If you don't press either <Y> or <N> key within 60 seconds, the <Y> option will be automatically selected to reset fTPM.

Regardless of whether you choose <Y> or <N>, you will need to enter the BitLocker key for OS boot on this page. If you press the <Y> key, you will be directed to the "BitLocker Recovery" page to enter the BitLocker key. Once you enter the correct key, it will be remembered, and the "BitLocker Recovery" page will not appear again after a reboot.

If you press the <N> key, you will be directed to the "BitLocker Recovery" page to enter the BitLocker key. However, if you choose this option, the key will not be remembered, and the "BitLocker Recovery" page will reappear after each reboot, requiring you to input the BitLocker key again every time

### 3.4 Returning Merchandise for Service

A receipt or copy of your invoice marked with the date of purchase is required before any warranty service will be rendered. You can obtain service by calling your vendor for a Returned Merchandise Authorization (RMA) number. When returning to the manufacturer, the RMA number should be prominently displayed on the outside of the shipping carton and mailed prepaid or hand-carried. Shipping and handling charges will be applied for all orders that must be mailed when service is complete.

For faster service, RMA authorizations may be requested online (<http://www.supermicro.com/support/rma/>).

This warranty only covers normal consumer use and does not cover damages incurred in shipping or from failure due to the alteration, misuse, abuse or improper maintenance of products.

During the warranty period, contact your distributor first for any product problems.

## 3.5 Battery Removal and Installation

### Battery Removal

*To remove the onboard battery, follow the steps below:*

1. Power off your system and unplug your power cable.
2. Locate the onboard battery (see Figure 3-1).
3. Using a tool such as a pen or a small screwdriver, push the battery lock outwards to unlock it. Once unlocked, the battery will pop out from the holder.
4. Remove the battery.

### Proper Battery Disposal

Please handle used batteries carefully. Do not damage the battery in any way; a damaged battery may release hazardous materials into the environment. Do not discard a used battery in the garbage or a public landfill. Please comply with the regulations set up by your local hazardous waste management agency to dispose of your used battery properly.

### Battery Installation

1. To install an onboard battery, follow steps 1 and 2 in Battery Removal section and continue below:
2. Identify the battery's polarity. The positive (+) side should be facing up.
3. Insert the battery into the battery holder and push it down until you hear a click to ensure that the battery is securely locked.

**Important:** When replacing a battery, be sure to only replace it with the same type.

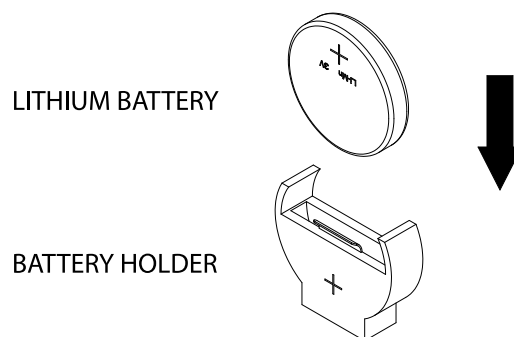

**Figure 3-1. Battery Installation**



# Chapter 4

## BIOS

### 4.1 Introduction

This chapter describes the AMIBIOS™ Setup utility for the H13SAE-MF motherboard. The BIOS is stored on a chip and can be easily upgraded using a flash program.

**Note:** Due to periodic changes to the BIOS, some settings may have been added or deleted and might not yet be recorded in this manual. Please refer to the Manual Download area of our website for any changes to BIOS that may not be reflected in this manual.

#### Starting the Setup Utility

To enter the BIOS Setup Utility, hit the <Delete> key while the system is booting-up. (In most cases, the <Delete> key is used to invoke the BIOS setup screen. There are a few cases when other keys are used, such as <F1>, <F2>, etc.) Each main BIOS menu option is described in this manual.

The Main BIOS screen has two main frames. The left frame displays all the options that can be configured. "Grayed-out" options cannot be configured. The right frame displays the key legend. Above the key legend is an area reserved for a text message. When an option is selected in the left frame, it is highlighted in white. Often a text message will accompany it. (Note that BIOS has default text messages built in. We retain the option to include, omit, or change any of these text messages.) Settings printed in Bold are the default values.

A " ►" indicates a submenu. Highlighting such an item and pressing the <Enter> key will open the list of settings within that submenu.

The BIOS setup utility uses a key-based navigation system called hot keys. Most of these hot keys (<F1>, <F2>, <F3>, <Enter>, <ESC>, <Arrow> keys, etc.) can be used at any time during the setup navigation process.

## 4.2 Main Setup

When you first enter the AMI BIOS setup utility, you will enter the Main setup screen. You can always return to the Main setup screen by selecting the Main tab on the top of the screen. The Main BIOS setup screen is shown below. The following Main menu items will be displayed:

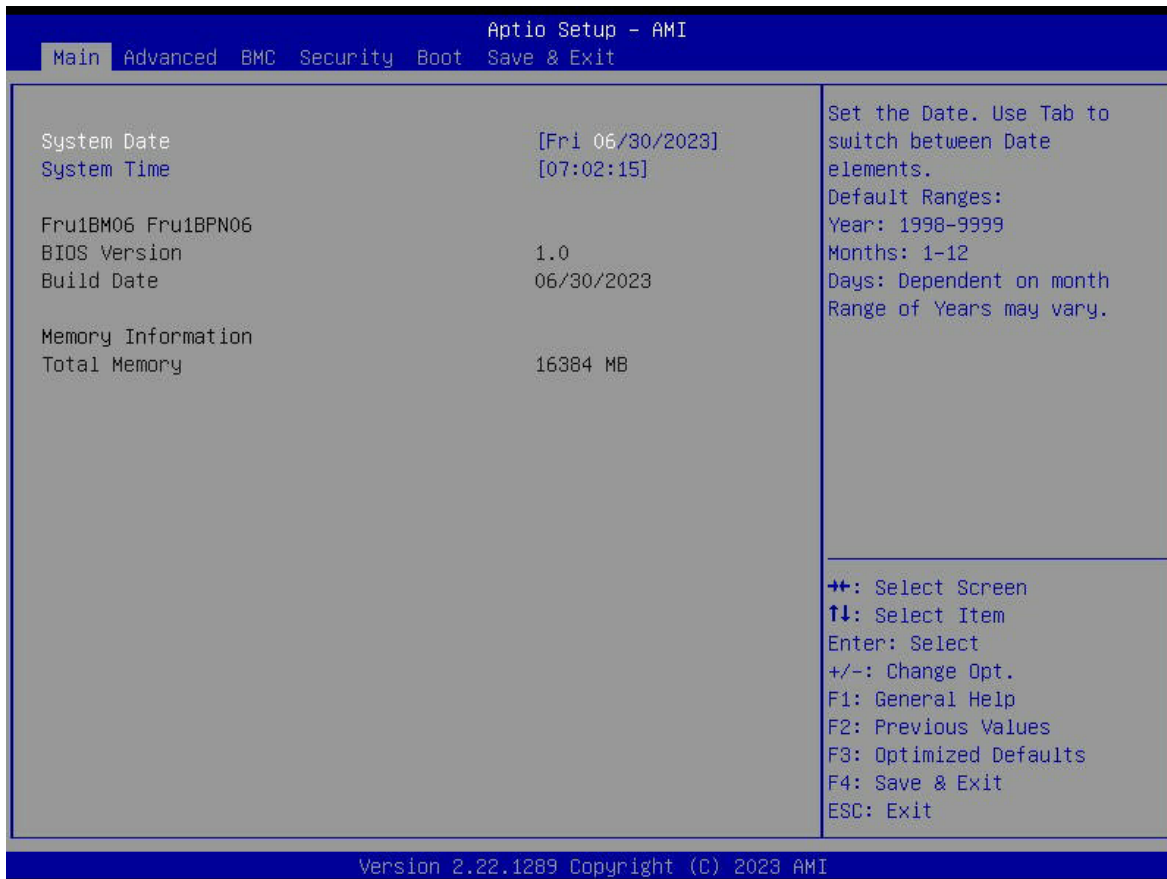

### System Date/System Time

Use this option to change the system date and time. To change system date and time settings, please highlight *System Date* or *System Time* using the arrow keys and enter new values using the keyboard. Press the <Tab> key or the arrow keys to move between fields. The date must be entered in MM/DD/YYYY format. The time is entered in HH:MM:SS format.

**Note:** The time is in the 24-hour format. For example, 5:30 P.M. appears as 17:30:00. The date's default value is 01/01/2015 after RTC reset.

**Supermicro H13SAE-MF****BIOS Version**

This item displays the version of the BIOS ROM used in the system.

**Build Date**

This item displays the date when the version of the BIOS ROM used in the system was built.

**Memory Information****Total Memory**

This item displays the total size of memory available in the system.

## 4.3 Advanced

Use the arrow keys to select Boot Setup and press <Enter> to access the submenu items.

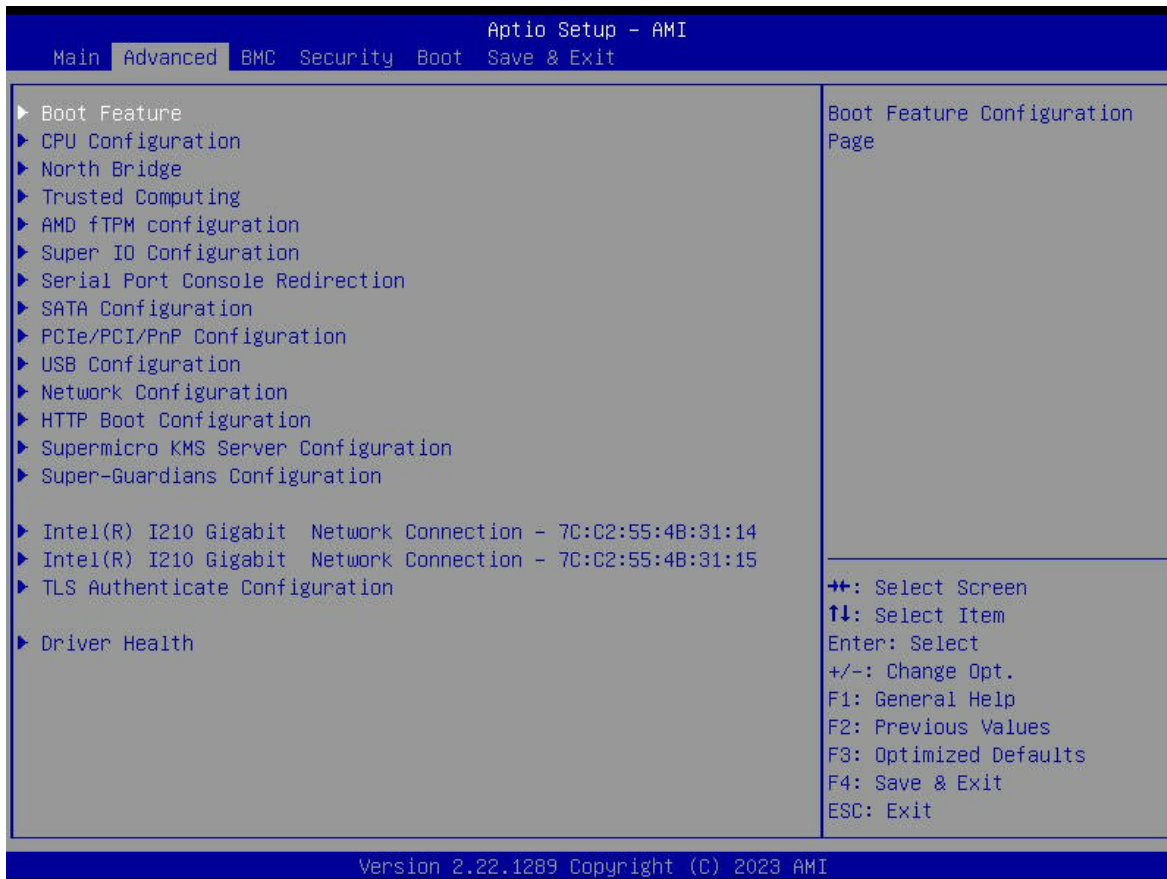

**Warning:** Take caution when changing the Advanced settings. An incorrect value, a very high DRAM frequency, or an incorrect DRAM timing setting may make the system unstable. When this occurs, revert to the default to the manufacture default settings.

### ► Boot Feature

#### Quiet Boot

Use this feature to select the screen display between the Power-on Self Test (POST) messages and the OEM logo upon bootup. Select Disabled to display the POST messages. Select Enabled to display the OEM logo instead of the normal POST messages. The options are Disabled and **Enabled**.

#### Option ROM Messages

Use this feature to set the display mode for the Option ROM. Select Keep Current to display the current AddOn ROM setting. Select Force BIOS to use the Option ROM display set by the system BIOS. The options are **Force BIOS** and Keep Current.

**Bootup NumLock State**

Use this feature to select the keyboard <Numlock> state. The options are **On** and **Off**.

**Wait For "F1" If Error**

Use this feature to force the system to wait until the <F1> key is pressed if an error occurs. The options are **Disabled** and **Enabled**.

**INT19 (Interrupt 19) Trap Response**

Interrupt 19 is the software interrupt that handles the boot disk function. When this item is set to **Immediate**, the ROM BIOS of the host adaptors will "capture" Interrupt 19 at bootup immediately and allow the drives that are attached to these host adaptors to function as bootable disks. If this item is set to **Postponed**, the ROM BIOS of the host adaptors will not capture Interrupt 19 immediately and allow the drives attached to these adaptors to function as bootable devices at bootup. The options are **Immediate** and **Postponed**.

**Re-try Boot**

If this item is enabled, the BIOS will automatically reboot the system from a specified boot device after its initial boot failure. The options are **Disabled**, **Legacy Boot**, and **EFI Boot**.

**Power Configuration****Watch Dog Function**

If enabled, the Watch Dog Timer will allow the system to reset or generate NMI based on jumper settings when it is expired for more than 5 minutes. The options are **Disabled** and **Enabled**.

**Restore on AC Power Loss**

Use this feature to set the power state after a power outage. Select **Stay-Off** for the system power to remain off after a power loss. Select **Power-On** for the system power to be turned on after a power loss. Select **Last State** to allow the system to resume its last power state before a power loss. The options are **Stay Off**, **Power On**, and **Last State**.

**Power Button Function**

This feature controls how the system shuts down when the power button is pressed. Select **Instant Off** to instantly power off the system as soon as the user presses the power button. Select **4 Seconds Override** for the user to power off the system after pressing and holding the power button for 4 seconds or longer. The options are **Instant Off** and **4 Seconds Override**.

**DeepS5 Power Policy**

This feature enables or disables S5 Deep sleep mode. The options are **Disabled**, and **Enabled**.

## ► CPU Configuration

### CPU Configuration

#### PSS Support

Use this setting to enable or disable the generation of ACPI\_PPC, \_PSS, and PCT objects. The options include Disabled and **Enabled**.

#### PPC Adjustment

Use this setting to adjust PPC object. The options include **PState 0**, PState 1, PState 2, and PState 3.

#### NX Mode

Use this setting to enable or disable no-execute page protection function. The options include Disabled and **Enabled**.

#### SVM Mode

Use this setting to enable or disable CPU Virtualization. The options include Disabled and **Enabled**.

#### SMT Control

Use this setting to specify Symmetric Multithreading. The options include Disabled and **Auto**.

## ► CPU Information

### CPU Configuration

These sections are for informational purposes. They will display some details about the detected CPUs on the motherboard, such as:

- CPU Version
- Number of Cores Running
- Processor Family
- Processor Model
- Microcode Patch Level
- L1 Instruction Cache (Size/Method)
- L1 Data Cache (Size/Method)
- L2 Cache (Size/Method)
- L3 Cache per Socket (Size/Method)

## ▶ North Bridge

### North Bridge Configuration

#### Above 4GB MMIO Limit

Use this setting select Above 4GB MMIO Limit to 38 to 43 bits limit. This option only works when "Above 4G decoding" is enabled. Options include **40bit (1TB)**, 41bit (2TB), 42bit (3TB), and 43bit (8TB).

## ▶ Memory Information

These sections are for informational purposes. They display some details about the detected memory according to each CPU on the motherboard, such as:

- Detected Size (per slot, in MB)
- Current Speed (MT/s)

## ▶ Trusted Computing

### Configuration

#### Security Device Support

If this feature and the TPM jumper on the motherboard are both set to Enabled, onboard security devices will be enabled for TPM (Trusted Platform Module) support to enhance data integrity and network security. Please reboot the system for a change on this setting to take effect. The options are Disable and **Enable**.

## ▶ AMD fTPM Configuration

### AMD fTPM Switch

The options are **AMD CPU fTPM** and Route to SPI TPM.

#### Erase fTPM NV For Factory Reset

When New CPU is installed, select Enabled to reset fTPM, if you have BitLocker or encryption-enabled system, the system will not boot without a recovery key. Select Disabled to keep previous fTPM record and continue system boot, fTPM will not be enabled with new CPU unless fTPM is reset (reinitialized), you could swap back to the old CPU to recover TPM related keys and data. The options are Disabled and **Enabled**.

## ► Super IO Configuration

### Super IO Configuration

The following Super IO information will display:

- Super IO Chip AST2600

## ► Serial Port 1 Configuration

### Serial Port 1 Configuration

#### Serial Port 1

Select Enabled to enable the selected onboard serial port. The options are Disabled and Enabled.

#### Change Settings

This feature specifies the base I/O port address and the Interrupt Request address of a serial port specified by the user. Select Auto to allow the BIOS to automatically assign the base I/O and IRQ address. The options are **Auto**, (IO=3F8h; IRQ=4;), (IO=2F8h; IRQ=4;), (IO=3E8h; IRQ=4;), and (IO=2E8h; IRQ=4;).

## ► Serial Port 2 Configuration

### Serial Port 2 Configuration

#### Serial Port 2

Select Enabled to enable the selected onboard serial port. The options are Disabled and Enabled.

#### Change Settings

This feature specifies the base I/O port address and the Interrupt Request address of a serial port specified by the user. Select Auto to allow the BIOS to automatically assign the base I/O and IRQ address. The options are **Auto**, (IO=2F8h; IRQ=3;), (IO=3F8h; IRQ=3;), (IO=3E8h; IRQ=3;), and (IO=2E8h; IRQ=3;).

#### Serial Port 2 Attribute

The options are **SOL** and **COM**.



## ► Serial Port Console Redirection

### COM1

#### Console Redirection

Select Enabled to enable console redirection support for a serial port specified by the user. The options are **Disabled** and Enabled. If set to Enabled, the following options become available.

### ► Console Redirection Settings

#### Terminal Type

This feature allows the user to select the target terminal emulation type for Console Redirection. Select VT100 to use the ASCII Character set. Select VT100+ to add color and function key support. Select ANSI to use the Extended ASCII Character Set. Select VT-UTF8 to use UTF8 encoding to map Unicode characters into one or more bytes. The options are VT100, **VT100Plus**, VT-UTF8, and ANSI.

#### Bits Per Second

Use this feature to set the transmission speed for a serial port used in Console Redirection. Make sure that the same speed is used in the host computer and the client computer. A lower transmission speed may be required for long and busy lines. The options are 9600, 19200, 38400, 57600 and **115200** (bits per second).

#### Data Bits

Use this feature to set the data transmission size for Console Redirection. The options are 7 and **8**.

#### Parity

Options include **None**, Even, Odd, Mark, and Space.

#### Stop Bits

Options include **1** and 2.

#### Flow Control

Use this feature to set the flow control for Console Redirection to prevent data loss caused by buffer overflow. Send a "Stop" signal to stop sending data when the receiving buffer is full. Send a "Start" signal to start sending data when the receiving buffer is empty. The options are **None** and Hardware RTS/CTS.

#### VT-UTF8 Combo Key Support

The options include Disabled and **Enabled**.

**Recorder Mode**

Select Enabled to capture the data displayed on a terminal and send it as text messages to a remote server. The options are **Disabled** and Enabled.

**Resolution 100x31**

Select Enabled for extended-terminal resolution support. The options include Disabled and **Enabled**.

**Putty KeyPad**

This feature selects the settings for Function Keys and KeyPad used for Putty, which is a terminal emulator designed for the Windows OS. The options include **VT100**, LINUX, XTERMR6, SC0, ESCN and VT400.

**SOL/COM2****Console Redirection**

Options include Disabled and **Enabled**.

**► Console Redirection Settings****Terminal Type**

This feature allows the user to select the target terminal emulation type for Console Redirection. Select VT100 to use the ASCII Character set. Select VT100+ to add color and function key support. Select ANSI to use the Extended ASCII Character Set. Select VT-UTF8 to use UTF8 encoding to map Unicode characters into one or more bytes. The options are VT100, **VT100Plus**, VT-UTF8, and ANSI.

**Bits Per Second**

Use this feature to set the transmission speed for a serial port used in Console Redirection. Make sure that the same speed is used in the host computer and the client computer. A lower transmission speed may be required for long and busy lines. The options are 9600, 19200, 384000, 57600 and **115200** (bits per second).

**Data Bits**

Use this feature to set the data transmission size for Console Redirection. The options are 7 and **8**.

**Parity**

Options include **None**, Even, Odd, Mark, and Space.

**Stop Bits**

Options include **1** and 2.

**Flow Control**

Use this feature to set the flow control for Console Redirection to prevent data loss caused by buffer overflow. Send a "Stop" signal to stop sending data when the receiving buffer is full. Send a "Start" signal to start sending data when the receiving buffer is empty. The options are **None** and Hardware RTS/CTS.

**VT-UTF8 Combo Key Support**

The options include Disabled and **Enabled**.

**Recorder Mode**

Select Enabled to capture the data displayed on a terminal and send it as text messages to a remote server. The options are **Disabled** and Enabled.

**Resolution 100x31**

Select Enabled for extended-terminal resolution support. The options include Disabled and **Enabled**.

**Putty KeyPad**

This feature selects the settings for Function Keys and KeyPad used for Putty, which is a terminal emulator designed for the Windows OS. The options include **VT100**, LINUX, XTERMR6, SC0, ESCN and VT400.

**Legacy Console Redirection****► Legacy Console Redirection Settings****Legacy Serial Redirection Port**

Select a COM port to display redirection of legacy OS and legacy OPROM messages. The options are **COM1** and SOL/COM2.

**Resolution**

On legacy OS, the number of rows and columns supported redirection. The options are 80x24 and **80x25**.

**Redirection After BIOS POST**

When Bootloader is selected, then Legacy Console Redirection is disabled before booting to legacy OS. When Always Enable is selected, then Legacy Console Redirection is enabled for legacy OS. Default setting for this option is set to Always Enable. The options are **Always Enable** and BootLoader.

**Serial Port for Out-of-Band Management/Windows Emergency Management Services (EMS)**

## Console Redirection EMS

The options are **Disabled** and Enabled. If set Enabled, this option becomes available.

### ► Console Redirection Settings

#### Out-of-Band Mgmt Port

Microsoft Windows Emergency Management Services (EMS) allows for remote management of a Windows OS through a serial port. The options are **COM1** and SOL /COM2.

#### Terminal Type

This feature allows the user to select the target terminal emulation type for Console Redirection. Select VT100 to use the ASCII Character set. Select VT100+ to add color and function key support. Select ANSI to use the Extended ASCII Character Set. Select VT-UTF8 to use UTF8 encoding to map Unicode characters into one or more bytes. The options are VT100, VT100Plus, **VT-UTF8** and ANSI.

#### Bits Per Second

Use this feature to set the transmission speed for a serial port used in Console Redirection. Make sure that the same speed is used in the host computer and the client computer. A lower transmission speed may be required for long and busy lines. The options are 9600, 19200, 57600 and **115200** (bits per second).

#### Flow Control EMS

Use this feature to set the flow control for Console Redirection to prevent data loss caused by buffer overflow. Send a "Stop" signal to stop sending data when the receiving buffer is full. Send a "Start" signal to start sending data when the receiving buffer is empty. The options are **None**, Hardware RTS/CTS, and Software Xon/Xoff.

#### Data Bits EMS

Use this feature to set the data transmission size for Console Redirection. The options are 7 and 8.

#### Parity EMS

A parity bit can be sent along with regular data bits to detect data transmission errors. Select Even if the parity bit is set to 0, and the number of 1's in data bits is even. Select Odd if the parity bit is set to 0, and the number of 1's in data bits is odd. Select None if you do not want to send a parity bit with your data bits in transmission. Select Mark to add a mark as a parity bit to be sent along with the data bits. Select Space to add a Space as a parity bit to be sent with your data bits. The options are **None**, Even, Odd, Mark and Space.

### Stop Bits EMS

A stop bit indicates the end of a serial data packet. Select 1 Stop Bit for standard serial data communication. Select 2 Stop Bits if slower devices are used. The options are **1** and **2**.

## ▶ SATA Configuration

This menu provides SATA configuration settings and information.

### SATA Configuration

#### SATA Mode

The options are **AHCI Mode** and RAID Mode.

## ▶ PCIe/PCI/PnP Configuration

This menu provides PCIe/PCI/PnP configuration settings and information.

### PCI Bus Driver Version

#### PCI Devices Common Settings:

##### Above 4G Decoding

This setting Disables or **Enables** 64-bit capable devices ability to be decoded in above 4G address space (only if the system supports 64-bit PCI decoding). The options are Disabled and **Enabled**.

##### Re-Size BAR Support

If system has resizable BAR capable PCIe devices, use the options **Disabled** or Enabled resizable BAR support.

##### SR-IOV Support

If the system has SR-IOV capable PCIe devices, this setting will **Disable** or Enable the Single Root IO Virtualization Support for the system.

##### BME DMA Mitigation

Re-enable Bus Master Attribute disabled during PCI enumeration for PCI Bridges after SMM Locked. The options are **Disabled** and Enabled.

##### ASPM Support

Use this setting to set the ASPM level. The options are **Disabled**, Auto and Force L0s.

##### Relaxed Ordering

Select Enable to enable Relaxed Ordering support, which will allow certain transactions to violate the strict-ordering rules of PCI bus for a transaction to be completed prior to other transactions that have already been enqueued. The options are Disabled and **Enabled**.

**No Snoop**

Select Enable to support no-snoop mode for each CB device. The options are Disabled and **Enabled**.

**NVMe Firmware Source**

Use this setting to select between the AMI Native firmware support or the device vendor-defined firmware support. The options are **Vendor Defined Firmware** and AMI Native Support.

**NVMe RAID mode**

Use this setting to Disable or Enable NVMe RAID mode Set the PCIe/GFX Lanes Configuration item according to the RAID configuration.

**CPU SLOT4 PCIe 5.0 X8 (IN X16) OPROM**

Use this setting to set CPU SLOT4 PCIe 5.0 X8 (IN X16) OPROM option. The options include Disabled and **EFI**.

**CPU SLOT6 PCIe 5.0 X16 OPROM**

Use this setting to set CPU SLOT6 PCIe 5.0 6 X16 OPROM option. The options include Disabled and **EFI**.

**CPU SLOT7 PCIe 4.0 X4 OPROM**

Use this setting to set CPU SLOT7 PCIe 4.0 X4 OPROM option. The options include Disabled and **EFI**.

**PCH SLOT7 PCIe 4.0 X4 OPROM**

Use this setting to set PCH SLOT7 PCIe 4.0 X4 OPROM option. The options include Disabled and **EFI**.

**Onboard LAN1 Option ROM**

Use this setting to select which firmware function to be loaded for onboard LAN1. The options include Disabled and **EFI**.

**Onboard LAN2 Option ROM**

Use this setting to select which firmware function to be loaded for onboard LAN2. The options include Disabled and **EFI**.

**Onboard LAN1 Support**

Use this setting to enable or disable onboard LAN1 support. If disabled, onboard LAN1 will not be available. The default setting is **Enabled**.

**Onboard LAN2 Support**

Use this setting to enable or disable onboard LAN2 support. If disabled, onboard LAN2 will not be available. The default setting is **Enabled**.

### **Onboard M.2-C1 Option ROM**

Use this setting to enable or disable M.2-C1 Option ROM. The default setting is **EFI**.

### **Onboard M.2-C2 Option ROM**

Use this setting to enable or disable M.2-C2 Option ROM. The default setting is **EFI**.

## **► USB Configuration**

### **USB Devices: 2 Keyboards, 2 Mice, 2 Hubs**

#### **XHCI Hand-Off**

This is a work-around solution for operating systems that do not support XHCI (Extensible Host Controller Interface) hand-off. The XHCI ownership change should be claimed by the XHCI driver. The options are **Enabled** and Disabled.

#### **Port 60/64 Emulation**

Select Enabled for I/O port 60h/64h emulation support, which in turn, will provide complete legacy USB keyboard support for the operating systems that do not support legacy USB devices. The options are Disabled and **Enabled**.

## **► Network Configuration**

### **Network Stack**

This setting allows you to Disable or **Enable** the UEFI Network Stack.

#### **IPv4 PXE Support**

This setting allows you to Disable or **Enable** IPv4 PXE boot support. If disabled, IPv4 PXE boot support will not be available.

#### **IPv4 HTTP Support**

This setting allows you to **Disable** or Enable IPv4 HTTP boot support. If disabled, IPv4 HTTP boot support will not be available.

#### **IPv6 PXE Support**

This setting allows you to Disable or **Enable** IPv6 PXE boot support. If disabled, IPv6 PXE boot support will not be available.

#### **IPv6 HTTP Support**

This setting allows you to **Disable** or Enable IPv4 HTTP boot support. If disabled, IPv4 HTTP boot support will not be available.

**PXE Boot Wait Time**

This setting allows you to set in a number field the wait time to press the ESC key to abort the PXE boot. The default value is **0**.

**Media Detect Count**

This setting allows you set in a number field the number of times presence of media will be checked. The default value is **1**.

**▶ MAC: 7CC2554B3118-IPv4 Network Configuration****Configured**

Indicae whether network address configured successfully or not. The options include **Disabled** and **Enabled**.

**▶ MAC: 7CC2554B3118-IPv6 Network Configuration****▶ Enter Configuration Menu**

Interface Name

Interface Type

MAC address

Host address

Route Table

Gateway addresses

DNS addresses

**Interface ID**

The 64-bit alternative interface ID for the device. The string is colon separated. The default setting is **7E:C2:55:FF:FE:4B:31:18**.

**DAD Transmit Count**

The number of consecutive neighbor solicitation messages sent while performing duplicate address detection on a tentative address. A value of zero indicates that duplicate address detection is not performed. The default value is **1**.

**Policy**

The options are automatic and **manual**.



### Save Changes and Exit

This setting saves changes for interface ID, DAD transmit count, policy, and data in advanced configuration.

## ▶ MAC: 7CC2554B3119-IPv4 Network Configuration

### Configured

This setting indicates whether network address configured successfully or not. The options include **Disabled** and Enabled.

### Save Changes and Exit

This setting saves changes and exit.

## ▶ MAC: 7CC2554B3119-IPv6 Network Configuration

### ▶ Enter Configuration Menu

Interface Name

Interface Type

MAC address

Host address

Route Table

Gateway addresses

DNS addresses

### Interface ID

The 64-bit alternative interface ID for the device. The string is colon separated. The default setting is **7E:C2:55:FF:FE:4B:31:19**.

### DAD Transmit Count

The number of consecutive neighbor solicitation messages sent while performing duplicate address detection on a tentative address. A value of zero indicates that duplicate address detection is not performed. The default value is **1**.

### Policy

The options are **automatic** and manual.

### **Save Changes and Exit**

This setting saves changes for interface ID, DAD transmit count, policy, and data in advanced configuration.

## **► HTTP Boot Configuration**

### **HTTP Boot Configuration**

#### **HTTP Boot Policy**

Sets the HTTP boot policy to Apply to all LANs, **Apply to each LAN**, or Boot Priority #1 instantly.

#### **HTTPS Boot Checks Hostname**

Selects whether HTTPS Boot checks the hostname of TLS certificates matches the hostname provided by the remote server. The options include **Enabled** and Disabled (WARNING: Security Risk!!).

#### **Priority of HTTP Boot**

##### **Instance of Priority 1**

The default value is **1**.

##### **Select IPv4 or IPv6**

Choose to set the targeted LAN port to boot from **IPv4** or IPv6.

#### **Boot Description**

This setting must be filled out, otherwise the boot option for the URI cannot be created.

#### **Boot URI**

This option is an input field used to enter a web or network address to point to the HTTP boot files. This supports the HTTP or HTTPS protocols only.

##### **Instance of Priority 2**

Rank targeted port

## **► Supermicro KMS Server Configuration**

### **Supermicro KMS Server IP address**

Enter IP4 address in dotted-decimal notation.

### **Second Supermicro KMS Server IP address**

Enter IP4 address in dotted-decimal notation.

**Supermicro KMS TCP Port number**

Enter Supermicro KMS TCP port number. The default value is **5696**.

**KMS Time Out**

KMS Server connecting time-out, unit is second, in the range of 5~30 seconds. The default value is **5**.

**TimeZone**

Enter the correct timezone. The default value is **0**.

**Client UserName**

Use this setting to enter the client identity. Choose a username 0-63 characters long.

**Client Password**

Use this setting to enter the client password. Choose a password 0-31 characters long.

**KMS TLS Certificate / Size****▶ CA Certificate**

The options include Update, Delete and Export.

**▶ Client Certificate**

The options include Update, Delete and Export.

**▶ Client Private Key**

The options include Update, Delete and Export.

**▶ Super-Guardians Configuration**

Super Guardians is a unified security solution to facilitate KMS, TPM, or USB-based authentication controls for Supermicro motherboards. Use this submenu to configure the authentication policy, method, and KMS server settings.

**Super-Guardians Protection Policy**

Use this feature to enable the Super-Guardians Protection Policy. The options are Storage, System, and "System and Storage." Set this feature to Storage to protect and have secure access to Trusted Computing Group (TCG) NVMe devices with the Authentication-Key (AK). Set this feature to System to protect and have secure access to your system/motherboard

with the AK. Set this feature to "System and Storage" to protect and have secure access to your TCG NVMe devices/system/motherboard with the AK.

The options include **Disabled** and Enabled.

### **KMS Security Policy**

Set this feature to Enabled to enable the Key Management Service (KMS) Security Policy. When this feature has not previously been set to Enabled, the options are **Disabled** and Enabled. Changes take effect after you save settings and reboot the system.

#### **Notes:**

- Be sure that the KMS server is ready before configuring this feature.
- Use the professional KMS server solutions (e.g., Thales Server) or the Supermicro PyKMIP Software Package to establish the KMS server.

When this feature has previously been set to Enabled, the options are Enabled, Reset, and Key Rotation. Set this feature to Key Rotation to obtain an existing Authentication-Key from the KMS server and create a new Authentication-Key. To disable the KMS Security Policy, set this feature to Reset. When this feature is set to reset, the system and TCG NVMe devices chosen in "Super-Guardians Protection Policy" will be in the unprotected mode.

### **KMS Server Retry Count**

Use this feature to specify how many times the system will attempt reconnecting to the KMS server. Press <+> or <-> on your keyboard to change the value. The default setting is **5**. If the value is 0, the system will retry infinitely. The valid range is 0 to 10.

### **TPM Security Policy**

Use this feature to enable or disable the TPM Security Policy. When this feature has not previously been set to Enabled, the options are Disabled and Enabled. Changes take effect after you save settings and reboot the system.

**Note:** Install a Trusted Platform Module 2.0 device to your system before configuring this feature.

When this feature has previously been set to Enabled, the options are **Disabled** and Enabled. To disable the TPM Security Policy, set this feature to Reset. When this feature is set to reset, the system and TCG NVMe devices chosen in "Super-Guardians Protection Policy" will be in the unprotected mode.

### **Load Authentication-Key**

Use this feature to toggle whether the BIOS should automatically load an Authentication-Key named TPMAuth.bin from a USB flash drive. The options are Disabled and Enabled. Set this feature to Enabled to load the Authentication-Key. After an Authentication Key is loaded, this

option will be reset to Disabled. Changes take effect after you save settings and reboot the system.

**Notes:**

- Connect a USB flash drive with the Authentication-Key (TPMAuth.bin) to your system before configuring this feature.
- Load the Authentication-Key after installing a TPM device. The TPM function will not work properly without an Authentication-Key.

**USB Security Policy**

Use this feature to configure USB Security Policy settings. When this feature has not previously been set to Enabled, this feature will toggle whether the BIOS should automatically save a USB Authentication-Key named "USBAuth.bin" to a USB flash drive and begin the USB Security Policy. The options are **Disabled** and Enabled. Changes take effect after you save settings and reboot the system.

**Note:** Connect a USB flash drive to your system before configuring this feature. Save the USB Authentication-Key and keep a backup.

When this feature has been previously set to Enabled, the options are Enabled and Reset. To disable the USB Security Policy, set this feature to Reset. When this feature is set to reset, the system and TCG NVMe devices chosen in "Super-Guardians Protection Policy" will be in the unprotected mode.

**▶ Intel(R) I210 Gigabit Network Connection - XX:XX:XX:XX:XX:XX****▶ Firmware Image Properties**

The following information is displayed:

- Option ROM Version
- Unique NVM/EEPROM ID
- NVM Version

**▶ NIC Configuration**

Use this setting to configure the network device port.

**Blink LEDs**

Use this setting to set blink LEDs for a duration up to 15 seconds.

### ▶ Firmware Image Properties

Use this setting to view device firmware version information.

### ▶ NIC Configuration

Use this setting to configure the network device port.

### Blink LEDs

Use this setting to set blink LEDs for a duration up to 15 seconds.

### ▶ TLS Authenticate Configuration

This submenu allows the user to configure Transport Layer Security (TLS) settings.

### ▶ Server CA Configuration

#### ▶ Enroll Certification

##### ▶ Enroll Certification Using File

Use this feature to enroll certification from a file.

##### Certification GUID

Use this feature to enroll to input the certification GUID.

##### ▶ Commit Changes and Exit

Use this feature to save all changes and exit TLS settings.

##### ▶ Discard Changes and Exit

Use this feature to enroll to discard all changes and exit TLS settings.

#### ▶ Delete Certification

Use this feature to delete certification. The options include **Disabled** and Enabled.

### ▶ Driver Health

This menu provide health status for the drivers and controllers.

## 4.4 BMC

This tab allows you to configure the following IPMI settings for the system.



### BMC Firmware Revision

This item indicates the IPMI firmware revision used in your system.

### BMC Status

This item indicates the status of the IPMI firmware installed in your system.

## ▶ System Event Log

### Enabling/Disabling Options

#### SEL Components

Select Enabled for all system event logging at bootup. The options are Disabled and Enabled.

## Erasing Settings

### Erase SEL

Select Yes, On next reset to erase all system event logs upon next system reboot. Select Yes, On every reset to erase all system event logs upon each system reboot. Select No to keep all system event logs after each system reboot. The options are **No**, Yes, On next reset, and Yes, On every reset.

### When SEL is Full

This feature allows the user to decide what the BIOS should do when the system event log is full. Select Erase Immediately to erase all events in the log when the system event log is full. The options are **Do Nothing** and Erase Immediately.

**Note:** After making changes on a setting, be sure to reboot the system for the changes to take effect.

## ► BMC Network Configuration

### Update BMC LAN Configuration

Select Yes to enable BMC Network Configuration. The options include **No** and Yes. If set to Yes, the following option becomes available.

### Configure IPv4 Support

This section displays static configuration features for .

### BMC LAN Selection

This item displays the IPMI LAN setting. The default setting is **Failover**.

### BMC Network Link Status

This item displays the IPMI Network Link status. The default setting is **Dedicated LAN**.

### Configuration Address Source

This feature allows the user to select the source of the IP address for this computer. If Static is selected, you will need to know the IP address of this computer and enter it to the system manually in the field. If DHCP is selected, the BIOS will search for a DHCP (Dynamic Host Configuration Protocol) server in the network that is attached to and request the next available IP address for this computer. The default setting is **Static**.

### Station IP Address

This item displays the Station IP address for this computer. This should be in decimal and in dotted quad form.



**Subnet Mask**

This item displays the sub-network that this computer belongs to. The value of each three-digit number separated by dots should not exceed 255.

**Station MAC Address**

This item displays the Station MAC address for this computer. Mac addresses are 6 two-digit hexadecimal numbers.

**Gateway IP Address**

This item displays the Gateway IP address for this computer. This should be in decimal and in dotted quad form (i.e., 172.31.0.1).

**VLAN**

The options include **Disabled** and Enabled.

**Configure IPv6 Support**

This section displays configuration features for IPv6 support.

**IPv6 Address Status: Active****IPv6 Support**

Use this feature to enable or disable LAN1 IPv6 support. The default setting is **Enabled**.

**Configuration Address Source**

This feature allows the user to select the source of the IP address for this computer. If Static is selected, you will need to know the IP address of this computer and enter it to the system manually in the field. If DHCP is selected, the BIOS will search for a DHCP (Dynamic Host Configuration Protocol) server in the network that is attached to and request the next available IP address for this computer. The default setting is **DHCP**.

**IPv6 Address****Prefix Length: 0****Gateway IP****Advanced Settings**

Options include **Auto obtain DNS server IP** and Manually obtain DNS server IP.

## 4.5 Security

This tab allows you to configure the following security settings for the system.

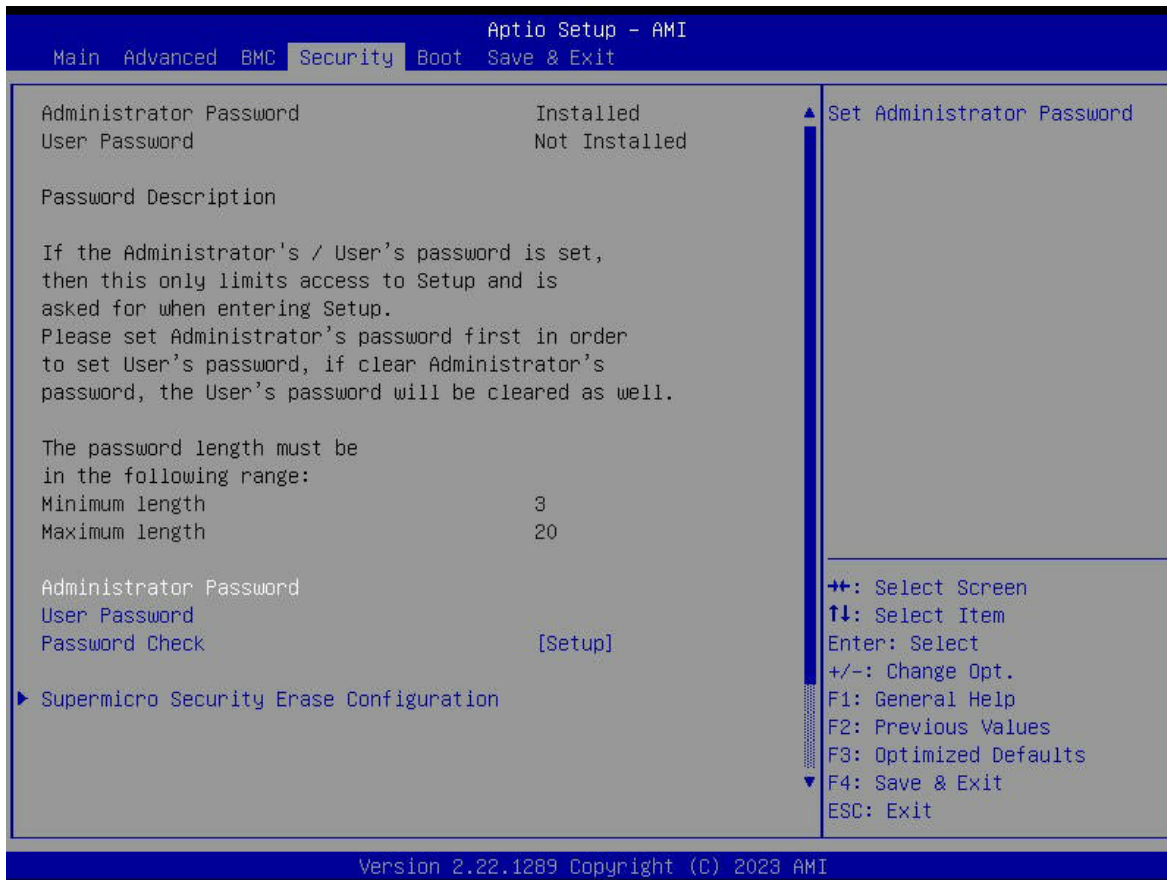

### Administrator Password

Press <Enter> to create a new, or change an existing Administrator password. Note that if the Administrator Password is erased, the User Password will be cleared as well.

### Password Check

Select Setup for the system to check for a password at Setup. Select Always for the system to check for a password at bootup or upon entering the BIOS Setup utility. The options are **Setup** and **Always**.

### Secure Boot

This option allows you specify when the Platform Key (PK) is enrolled. When enabled, the System Mode is user deployed, and the CSM function is disabled. Options include **Disabled** and **Enabled**.

### Secure Boot Mode

Use this item to select the secure boot mode. The options are **Standard** and **Custom**.

### ▶ Enter Audit Mode

### ▶ Enter Deployed Mode

### ▶ Key Management

This submenu allows the user to configure the following Key Management settings.

#### Vendor Keys

##### Provision Factory Defaults

Install factory default Secure Boot keys after the platform reset and while the System is in Setup mode. The default setting is **Disabled**.

##### ▶ Restore Factory Keys

Select and press Yes to restore factory default secure boot keys and key variables. Also, it will reset the system to the User mode. Select Yes to install all default secure keys set by the manufacturer. The options are Yes and No.

##### ▶ Reset To Setup Mode

##### ▶ Enroll Efi Image

This feature is to enroll SHA256 hash of the binary into the Authorized Signature Database (DB) and to allow the image to run in the secure boot mode.

##### ▶ Export Secure Boot Variables

Use this feature to export NVRAM content of secure boot variables to files in a root folder on a file system device.

#### Secure Boot Variable/Size/Key Numbers/Key Source

##### ▶ Platform Key (PK)

This feature allows the user to enter and configure a set of values to be used as platform firmware keys for the system. The sizes, keys numbers, and key sources of the platform keys will be indicated as well. Select Update to update the platform key. Select Yes to load a factory default PK or No to load from a file on an external media.

### ▶ Key Exchange Keys (KEK)

This feature allows the user to enter and configure a set of values to be used as Key-Exchange-Keys for the system. The sizes, keys numbers, and key sources of the Key-Exchange-Keys will be indicated as well. Select Update to update your "Key Exchange Keys". Select Append to append your "Key Exchange Keys".

### ▶ Authorized Signatures (db)

This feature allows the user to enter and configure a set of values to be used as Authorized Signatures for the system. These values also indicate the sizes, keys numbers, and the sources of the authorized signatures. Select Update to update your "Authorized Signatures". Select Append to append your "Authorized Signatures". The settings are **Update**, and Append.

### ▶ Forbidden Signatures (dbx)

This feature allows the user to enter and configure a set of values to be used as Forbidden Signatures for the system. These values also indicate sizes, keys numbers, and key sources of the forbidden signatures. Select Update to update your "Forbidden. Signatures". Select Append to append your "Forbidden Signatures". The settings are **Update**, and Append.

### ▶ Authorized TimeStamps (dbt)

This feature allows the user to set and save the timestamps for the authorized signatures which will indicate the time when these signatures are entered into the system. Select Update to update your "Authorized TimeStamps". Select Append to append your "Authorized TimeStamps". The settings are **Update**, and Append.

### ► OsRecovery Signature (dbr)

This item uploads and installs an OSRecovery Signature. Use this feature to export NVRAM content of secure boot variables to files in a root folder on a file system device.

The file formats accepted are:

- 1) Public Key Certificate
  - a. EFI Signature List
  - b. EFI CERT X509 (DER Encoded)
  - c. EFI CERT RSA2048 (bin)
  - d. EFI SERT SHA256 (bin)
- 2) Authenticated UEFI Variable
- 3) EFI PE/COFF Image (SHA256)

### ► MS UEFI CA Key

The options include Enabled, **Disabled**, and Disabled after BIOS.

## 4.6 Boot

Use this tab to configure Boot Settings:

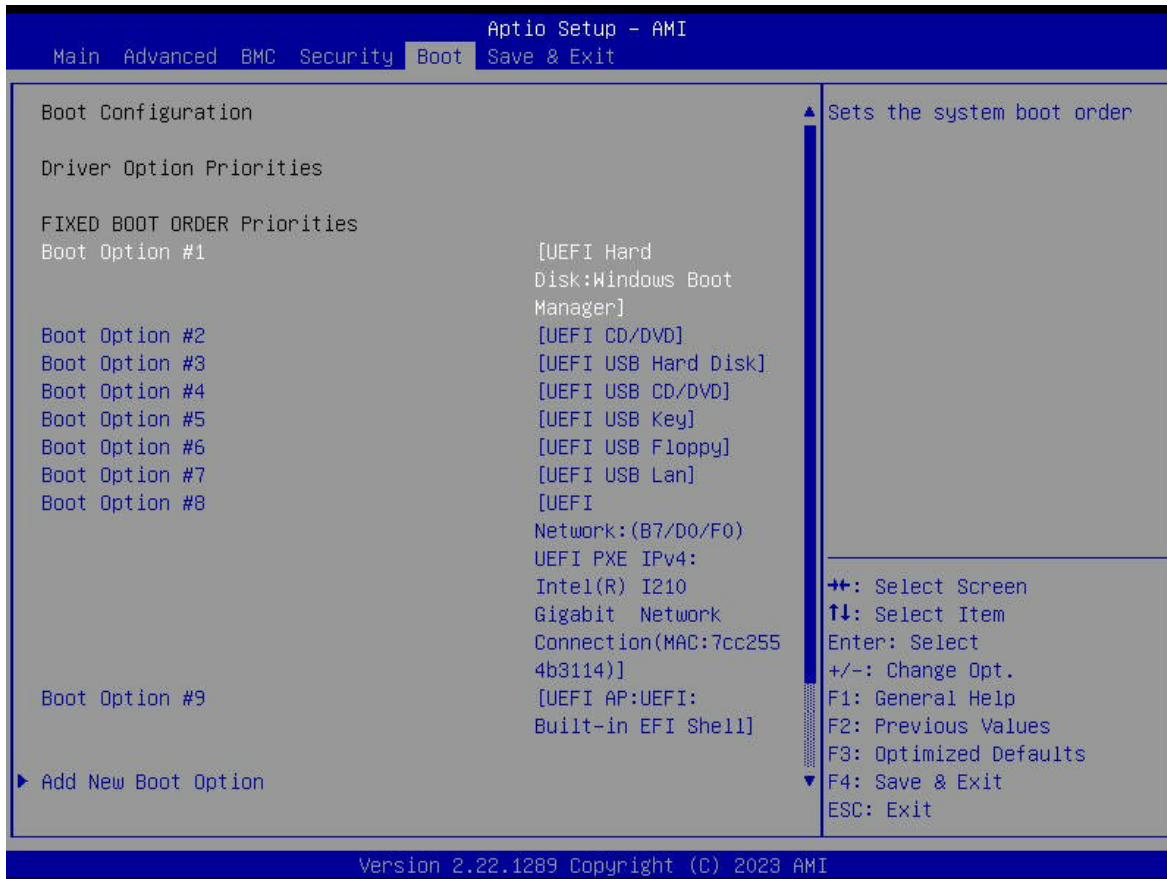

### FIXED BOOT ORDER Priorities Section

This option prioritizes the order of bootable devices that the system to boot from. Press <Enter> on each entry from top to bottom to select devices.

### ► Add New Boot Option

Use this feature to specify name for new boot option.

### ► Delete Boot Option

Use this feature to remove a pre-defined boot device from which the system will boot during startup. The default is **Select one to Delete**.

### ▶UEFI Hard Disk Drive BBS Priorities

Use this feature to set the system boot order.

### ▶UEFI Network Drive BBS Priorities

This feature allows users to specify the Boot Device Priority sequence from available UEFI Network Drives.

### ▶UEFI Application Boot Priorities

This feature allows users to specify the Boot Device Priority sequence from available UEFI Application.

## 4.7 Save & Exit

Select the Save & Exit tab to enter the Save & Exit BIOS Setup screen.

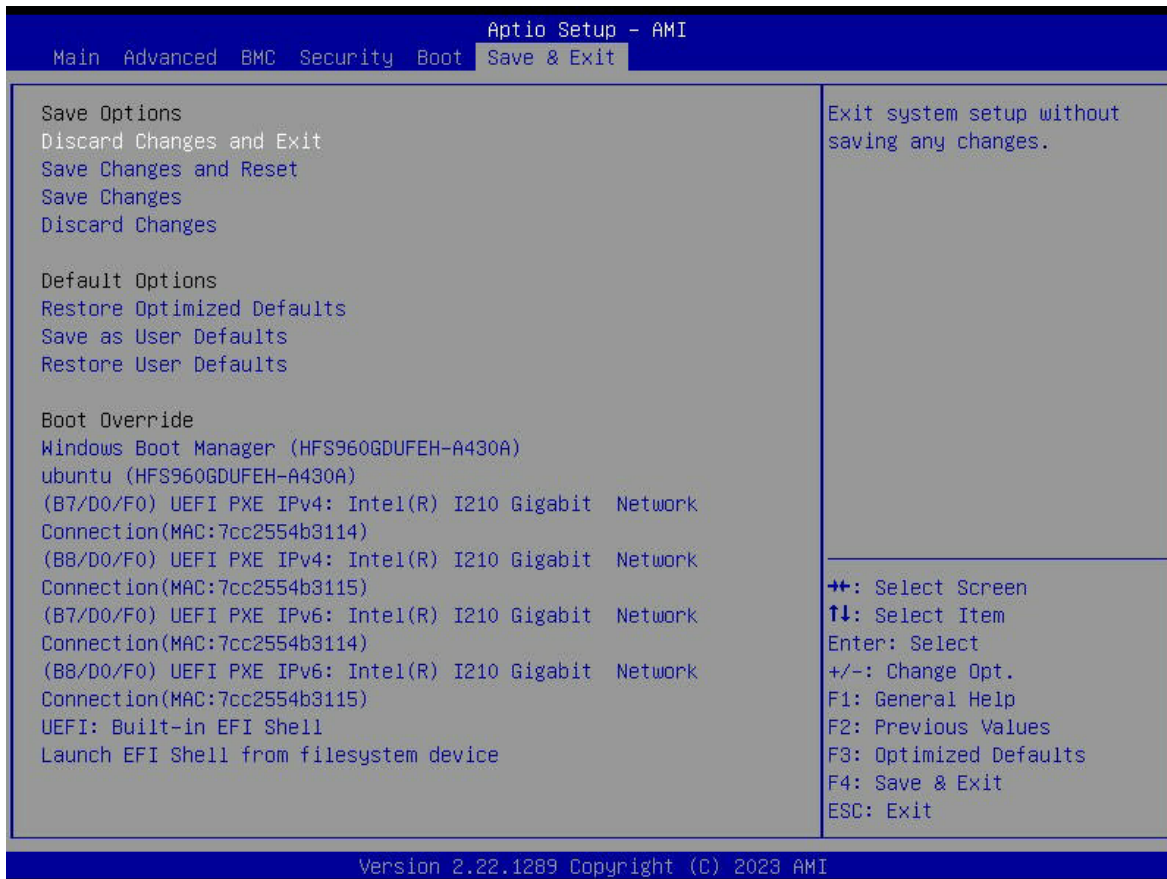

### Save Options

#### Discard Changes and Exit

Select this option to quit the BIOS Setup without making any permanent changes to the system configuration, and reboot the computer. Select Discard Changes and Exit from the Exit menu and press <Enter>.

#### Save Changes and Reset

Select this option to reset the system after saving the changes.

#### Save Changes

After completing the system configuration changes, select this option to save the changes you have made. This will not reset (reboot) the system.

#### Discard Changes

Select this option and press <Enter> to discard all the changes and return to the AMI BIOS utility Program.



## **Default Options**

### **Restore Optimized Defaults**

To set this feature, select Restore Defaults from the Save & Exit menu and press <Enter>. These are factory settings designed for maximum system stability, but not for maximum performance.

### **Save as User Defaults**

To set this feature, select Save as User Defaults from the Exit menu and press <Enter>. This enables the user to save any changes to the BIOS setup for future use.

### **Restore User Defaults**

To set this feature, select Restore User Defaults from the Exit menu and press <Enter>. Use this feature to retrieve user-defined settings that were saved previously.

### **Boot Override Section**

Listed in this section are other boot options for the system (i.e., UEFI: Built-in EFI Shell). Select an option and press <Enter>. Your system will boot to the selected boot option.

# Appendix A

## Software

After the hardware has been installed, you can proceed to install the Operating System (OS), configure RAID settings, and install the drivers. If you plan to use RAID, you must configure RAID settings before installing the Windows OS and the RAID driver.

### A.1 Configuring SATA RAID Drives

#### Enabling SATA RAID Mode

Enabling RAID is done in the BIOS settings. The following steps illustrate an example of configuring SATA drives for RAID.

**Notes:**

- RAID 5 is not supported.
- SATA RAID supports RAID levels 0, 1, and 10.

#### *Enabling SATA RAID Mode*

1. Enter the BIOS setup utility and press the **<Delete>** key while the system is booting-up.
2. Use the arrow key to navigate to the Advanced tab.
3. Use the arrow key to locate SATA Configuration and press the **<Enter>** key.
4. Select **SATA Mode** and press the **<Enter>** key to enter setup.

- Select **RAID Mode** and press the **<Enter>** key to configure.

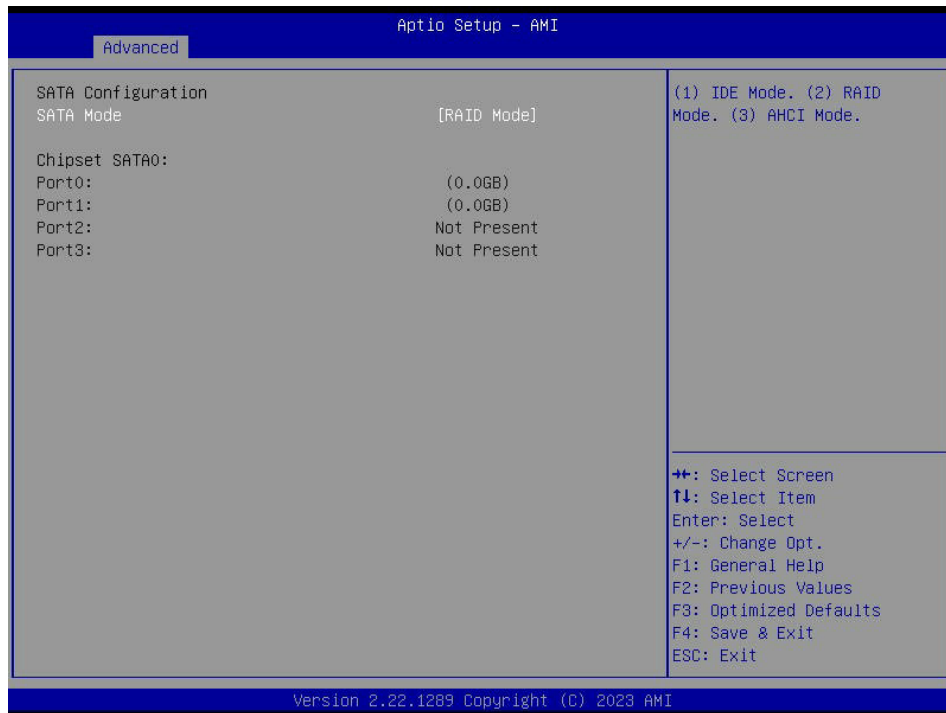

- Press the **<F4>** key, select **Yes**, press the **<Enter>** key to save the changes, and exit BIOS.
- Follow steps 1 and 2 again to enter the Advanced submenu. The RAIDXpert2 Configuration Utility item should now be listed.

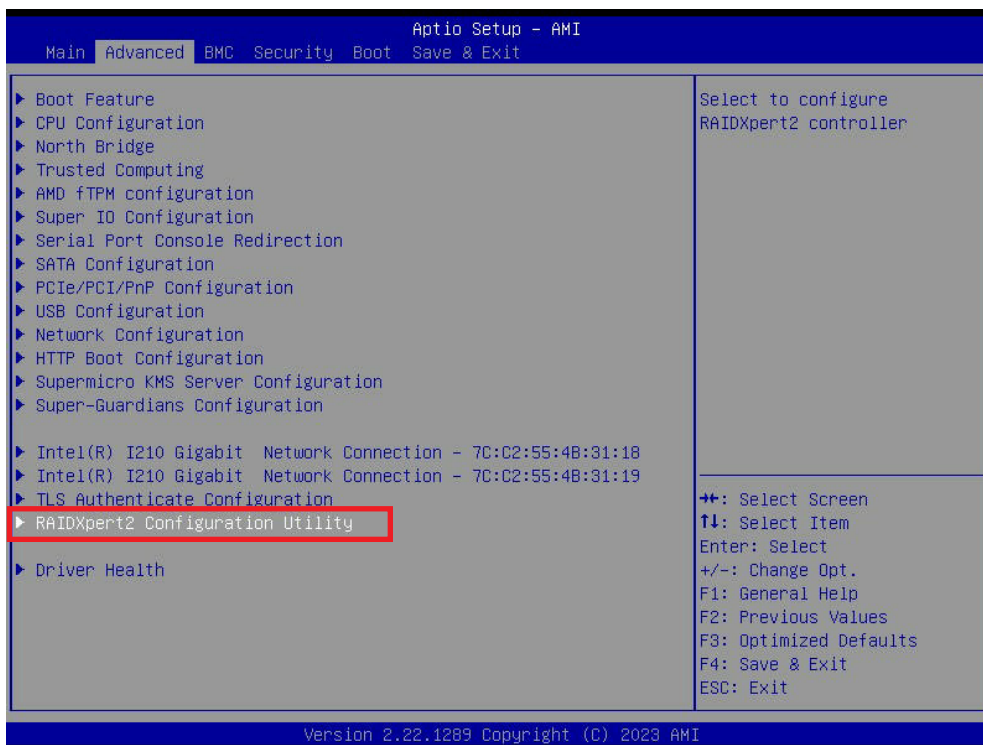

## Creating RAID Arrays

1. Select the **RAIDXpert2 Configuration Utility** item in the Advanced submenu and press the **<Enter>** key.
2. Select **Array Management** and press the **<Enter>** key.

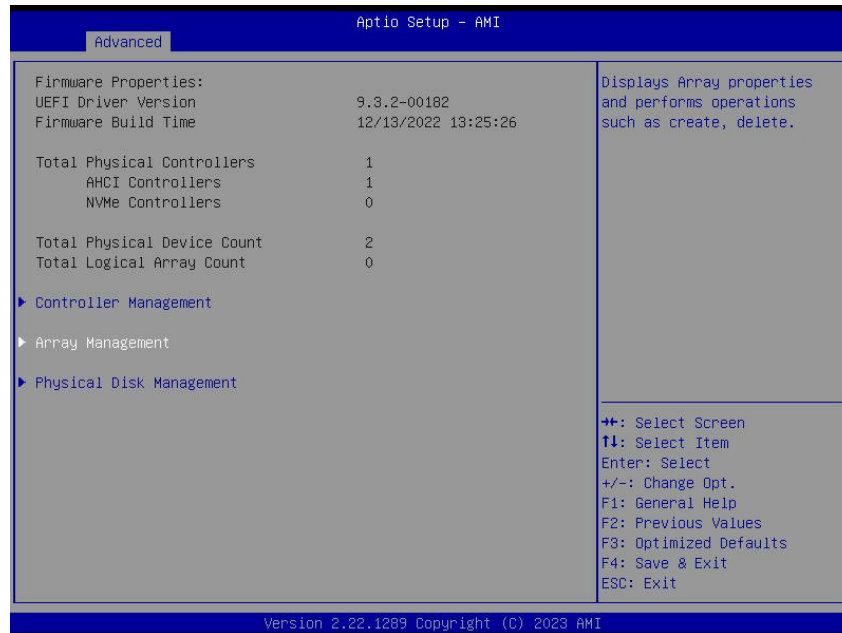

3. Select **Delete Array** and press the **<Enter>** key.
4. Select **Check All**, press the **<Enter>** key, then select **Delete Array(s)** and press the **<Enter>** key.
5. Select **Confirm**, select **Enabled**, press the **<Enter>** key, and then select **Yes**.
6. Return to the Array Management menu, select **Create Array**, and press the **<Enter>** key.
7. Use the arrow key to select **Select RAID Level** and press the **<Enter>** key. Select the option to set your RAID level.
  - **Volume:** Single disk or concatenation of disks (JBOD).
  - **RAIDABLE:** RAID aware single disk for future redundancy.
  - **RAID 0:** Striping two or more disks.
  - **RAID 1:** Mirroring two disks.
  - **RAID 10:** Combining both levels 1 (disk mirroring) and 0 (disk striping), also known as RAID 1 + RAID 0.

8. Use the arrow key to select **Select Physical Disks**.

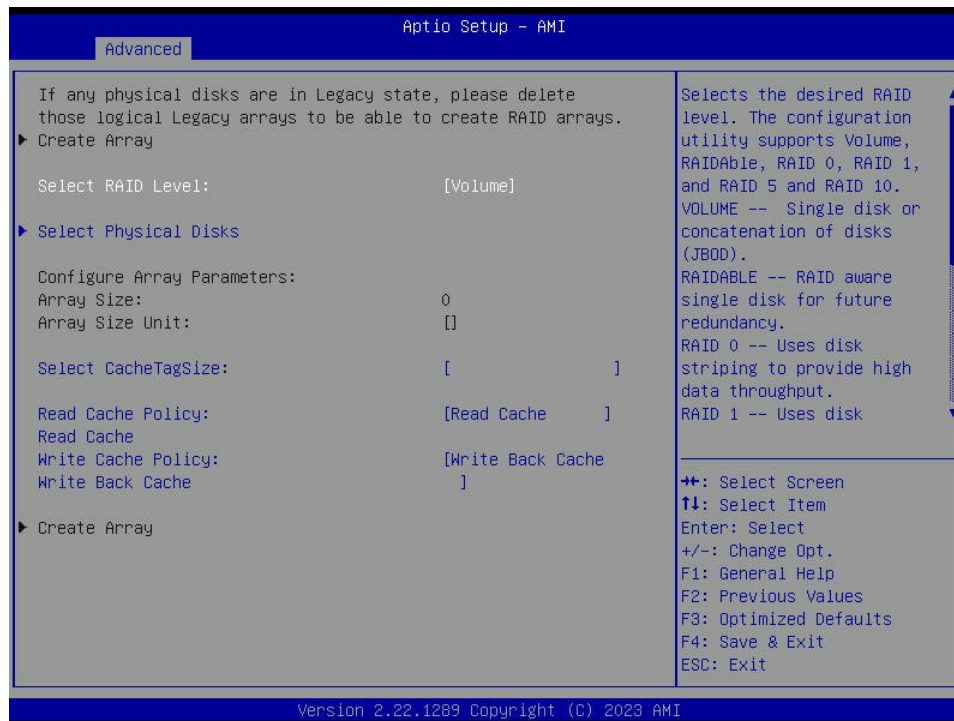

9. Enter **Select Media Type** to select the types of disks. The options include BOTH, HDD, and SSD.
10. Select the desired option and press the **<Enter>** key to enable them or select Check All to enable all available disks.
11. Select **Apply Changes** and press the **<Enter>** key.
12. Use the arrow key to select **Create Array** and press the **<Enter>** key to create the array.

## A.2 Configuring M.2 RAID Drives

### Enabling M.2 RAID Mode

#### *Enabling M.2 RAID Mode*

1. Enter the BIOS setup utility and press the **<Delete>** key while the system is booting up.
2. Use the arrow key to navigate to the **Advanced** tab.
3. Use the arrow key to locate **PCIe/PCI/PnP** and press the **<Enter>** key.
4. Use the arrow key to locate NVMe RAID Mode and select **Enabled**, and then press the **<Enter>** key.
5. Press the **<F4>** key to save and exit.
6. Press the **<Delete>** key while the system is booting up to enter the BIOS setup utility.
7. Use the arrow key to navigate to the **Advanced** tab, select **RaidXpert2 Configuration Utility, Array Management**, and then **Create Array**.
8. Use the arrow key to configure each item:
  - Select RAID Level
  - Select Physical Disks
  - Select Cache TagSize
  - Read Cache Policy
  - Write Cache Policy
9. Use the arrow key to select **Create Array**. Save the configurations.
10. To verify if the M.2 RAID drives have been set up properly, go to the BIOS setup utility, locate **Advanced**, locate **RaidXpert2 Configuration Utility**, locate **Array Management**, and then **Manage Array Properties**.

## A.3 Microsoft Windows OS Installation

If you will be using RAID, you must configure RAID settings before installing the Windows OS and the RAID driver. Refer to the RAID Configuration User Guides posted on our website at [www.supermicro.com/support/manuals](http://www.supermicro.com/support/manuals).

### Installing RAID Drivers for SATA During Windows Setup

After configuring the BIOS settings, you are now ready to install RAID drivers while installing the Windows operating system.

#### Drivers & Utilities

#### For MBD-H13SAE-MF

To locate a driver/utility, please select your OS and Device Type below.

Complete Drivers CD ISO can be downloaded [here](#).

**Select OS Manufacturer**

**Select OS**

**Select Device Type**

For OS supported, please refer to [OS Compatibility](#).

## Installing RAID Drivers

1. Insert a flash drive to the system, go the H13SAE-MF [product page](#), select Resources, select **Download the Latest Drivers and Utilities**, use the drop-down lists to make selections for manufacturer (**Microsoft**), operating system type (**Windows 11**) and driver type (**AMD RAID Driver**), and then click the **Submit** button to download and unzip the zipped file "RAID\_Windows\_Driver" to the flash drive.
2. Insert the flash drive containing the "RAID\_Windows\_Driver" folder and the Windows operating system, power on the system, enter the BIOS setup, and configure it to boot from the flash drive to start Windows Setup. Follow the onscreen instructions to complete the installation.
3. Return to the "RAID\_SATA" subfolder, select the **rcraid** folder, and then click "**rcraid.inf.**"

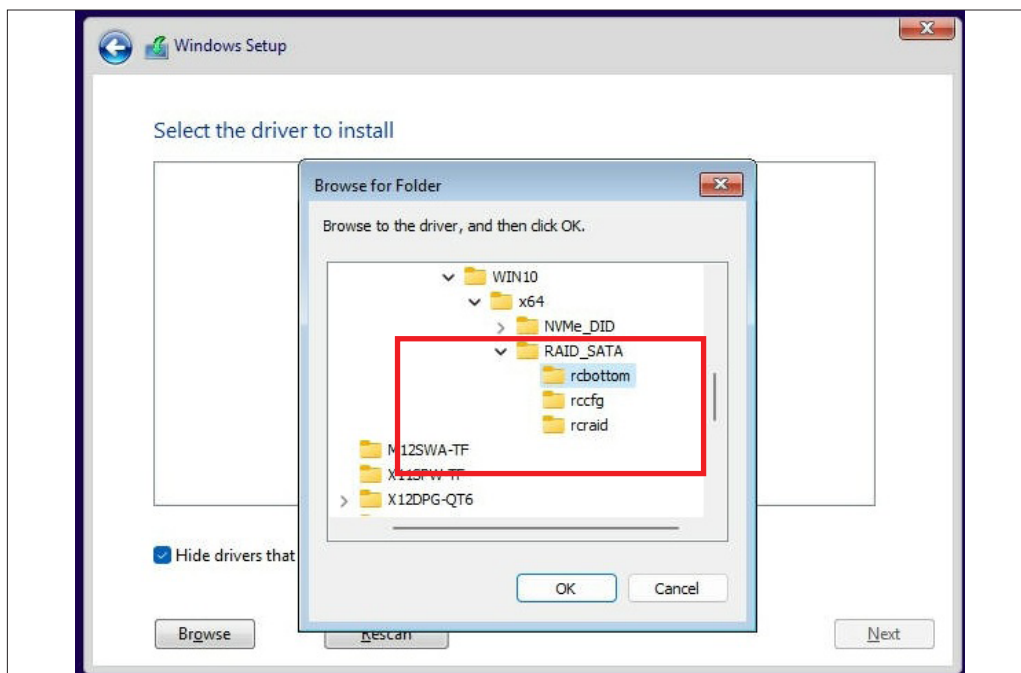

4. After both drives are loaded, they should appear in the system driver list.
5. Find the "rccfg.inf" driver in the list and click **Next**.
6. Follow the on-screen instructions to finish the installation of the Windows operating system.
7. In the Windows Setup, in the Select the driver to install dialog box, click the **Browse** button, locate the "RAID\_Windows\_Driver" folder > **WIN11** > **x64** > **RAID\_SATA** > **rcbottom**, click "rcbottom.inf," and click the **OK** button.
8. Return to the "RAID\_SATA" subfolder, select the **rcraid** folder, and then click "**rcraid.inf.**"



9. After both drives are loaded, they should appear in the system driver list.
10. Find the "rccfg.inf" driver in the list and click **Next**.
11. Follow the on-screen instructions to finish the installation of the Windows operating system.

## Installing RAID Drivers for M.2 During Windows Setup

**Note:** M.2 RAID supports RAID levels 0 and 1

1. Go to <https://rufus.ie/>, download and use the RUFUS utility to create a USB bootable drive with the Windows 10 or 11 ISO image supporting UEFI.
2. Download and unzip the AMD RAID driver 00158.zip onto a USB thumb drive from [https://www.supermicro.com/wdl/driver/AMD/NVMe\\_RAID/Raid\\_PKG\\_S0i3\\_win\\_9.3.2\\_00158.zip](https://www.supermicro.com/wdl/driver/AMD/NVMe_RAID/Raid_PKG_S0i3_win_9.3.2_00158.zip)
3. Install at least two NVMe drives in the system.
4. After the M.2 NVMe drives are installed, press the **<Del>** key to enter the BIOS menu, go to **Advanced > PCIe/PCI/PnP**, use the arrow keys to enable the **"NVMe RAID Mode"** item, and press the **<F4>** key to save and exit the BIOS.
5. Press the **<Del>** key to enter the BIOS menu, go to **Advanced > RaidXpert2 Configuration Utility > Array Management > Create Array**.

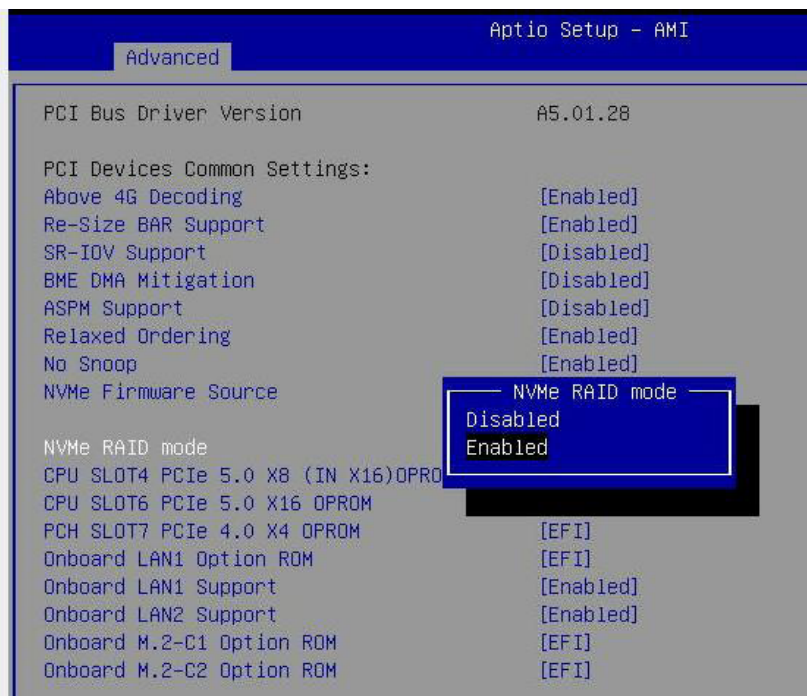

## 6. Change these items as needed:

- Select RAID Level
- Select Physical Disks
- Select CacheTagSize
- Read Cache Policy
- Write Cache Policy

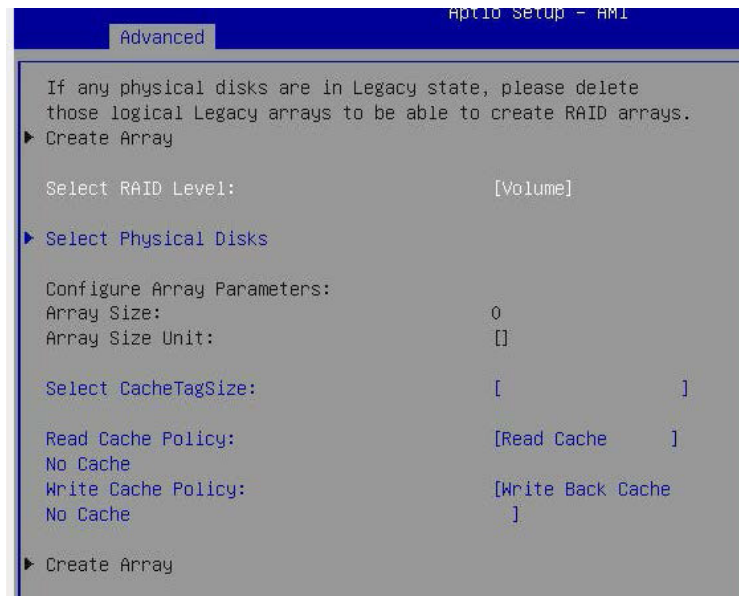
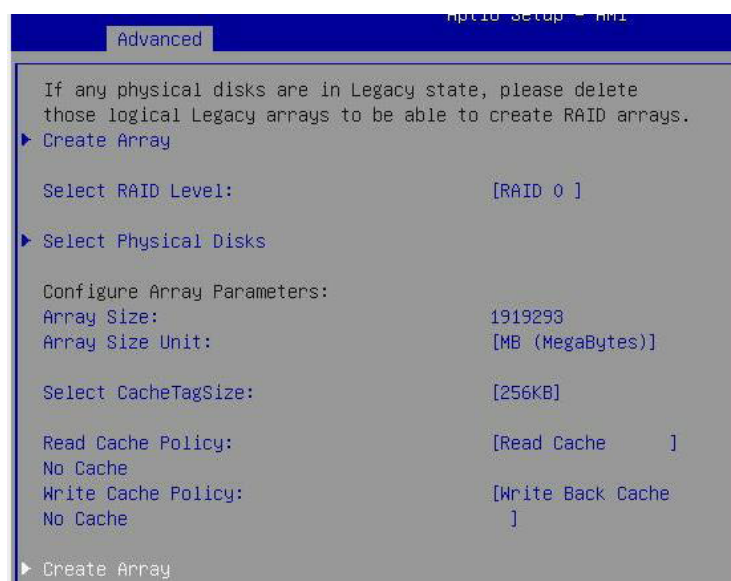
7. Use the arrow keys to select **Create Array**, and then select **Save and Exit** to save the changes and exit BIOS.

8. To check if the RAID drives are properly set up, press the **<Del>** key to enter the BIOS menu, then go to **Advanced > RAIDXpert2 Configuration Utility > Array Management > Manage Array Properties**.



9. Plug in the thumb drive, turn on the system, press the **<F11>** key to enter the boot menu during system bootup, and select **SMI USB DISK**.

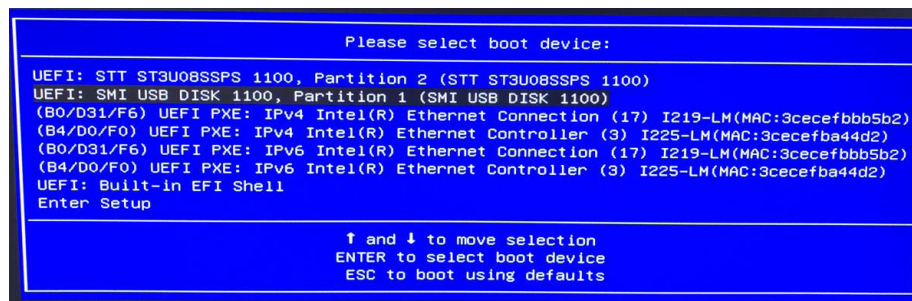

10. Follow the on-screen instructions, select **Custom: Install Windows only (advanced)**, select **Load Driver**, and then click **Next**.

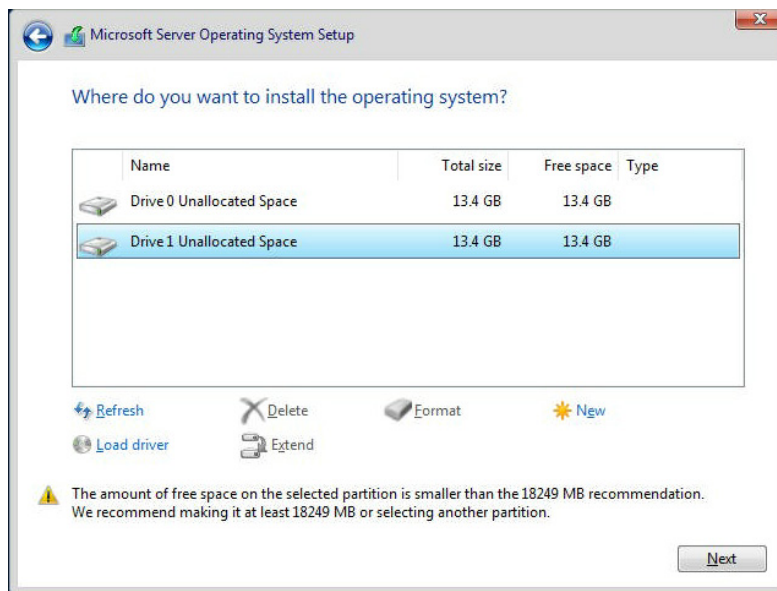

11. Click the **Browse** button, locate the **"RAID\_Windows\_Driver"** folder > **WIN11** > **x64** > **NVMe\_DID** > **rcbottom**, and click the **OK** button.

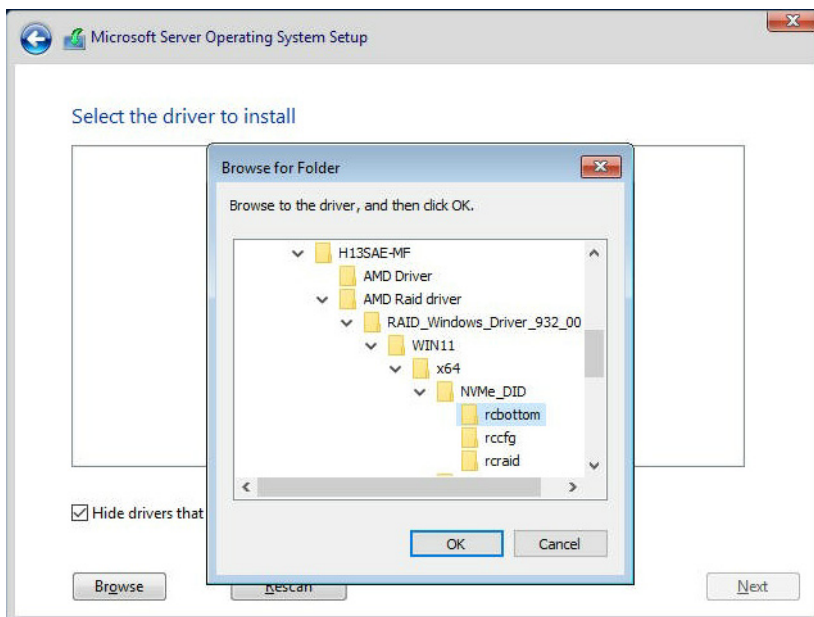

12. Select the driver and then click the **Next** button.

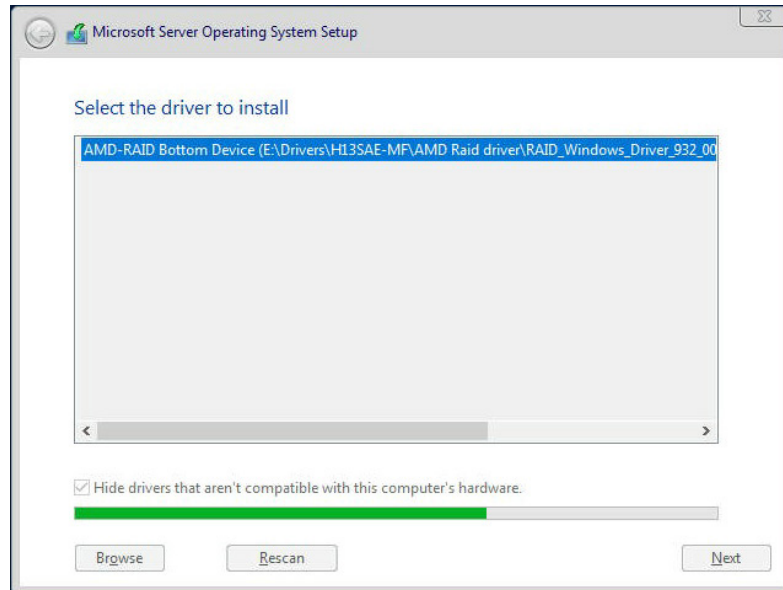

13. Select locate the "**RAID\_Windows\_Driver**" folder > **WIN11** > **x64** > **NVMe\_DID** > **rcaid**, and click the **OK** button.

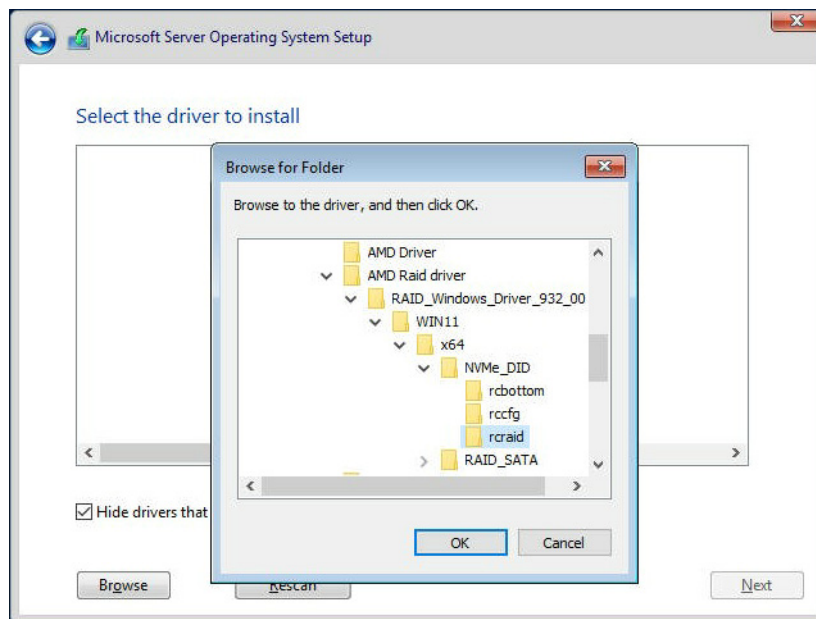

- Once the driver is installed, the RAID drive will be listed as available. Click the **Next** button and follow the on-screen instructions to complete the Windows installation.

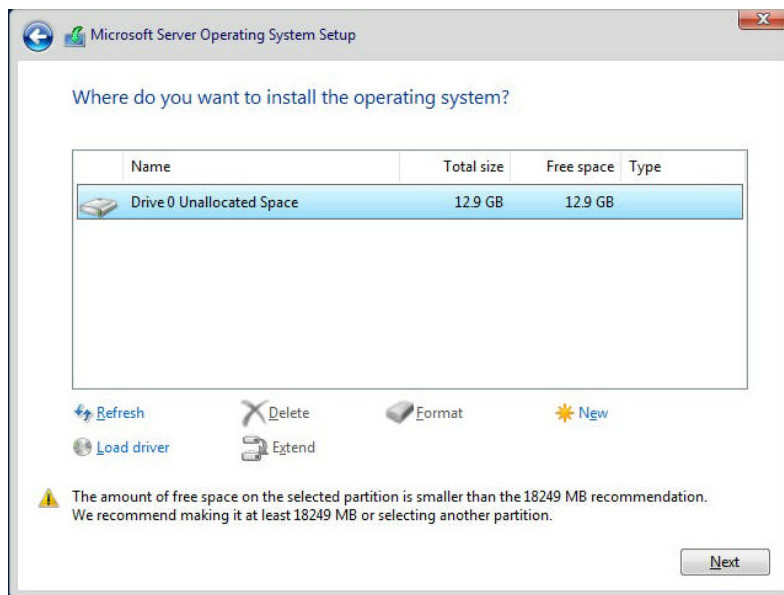

- The Windows Boot Manager should be a boot device option in the boot menu after Windows has been installed.

## A.4 Driver Installation

The Supermicro website contains drivers and utilities for your system at <https://www.supermicro.com/wdl/>. Some of these must be installed, such as the chipset driver.

After accessing the website, go into the CDR\_Images (in the parent directory of the above link) and locate the ISO file for your motherboard. Download this file to a USB flash or media drive. (You may also use a utility to extract the ISO file if preferred.)

Another option is to go to the Supermicro website at <http://www.supermicro.com/products/>. Find the product page for your motherboard, and "Download the Latest Drivers and Utilities". Insert the flash drive or disk and the screenshot shown below should appear.

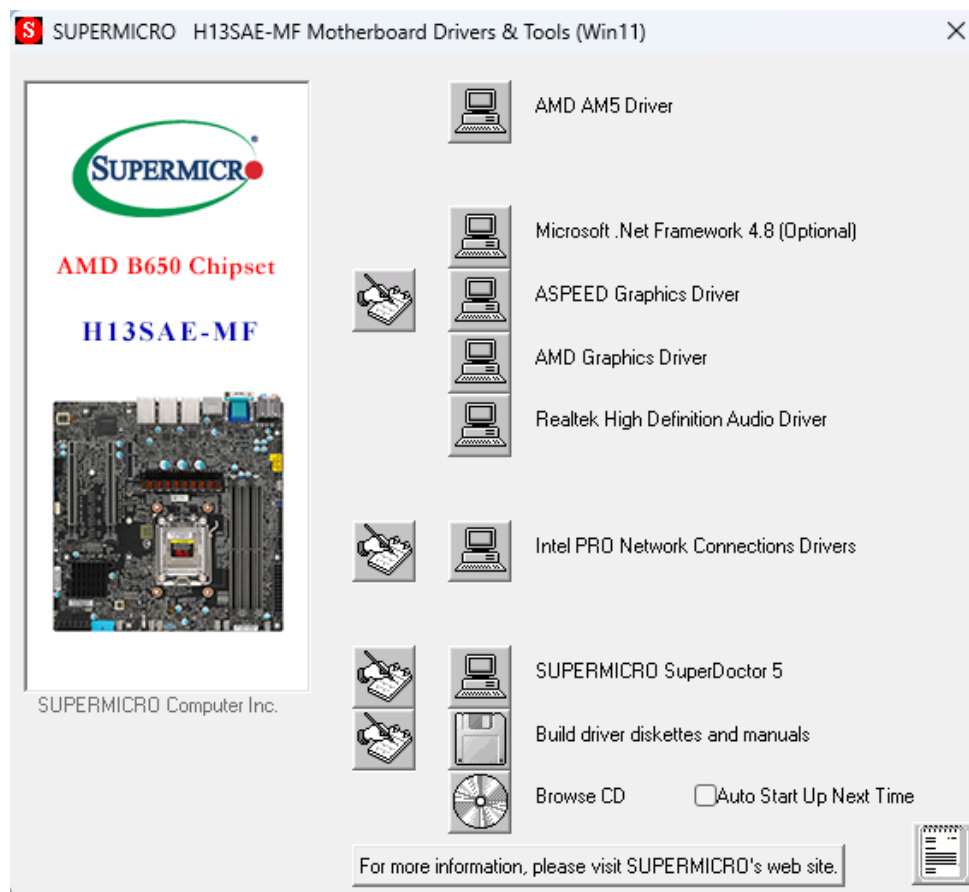

Figure A-1. Driver & Tool Installation Screen

**Note:** Click the icons showing a hand writing on paper to view the readme files for each item. Click the computer icons to the right of these items to install each item (from top to the bottom) one at a time. **After installing each item, you must re-boot the system before moving on to the next item on the list.** The bottom icon with a CD on it allows you to view the entire contents.



## A.5 SuperDoctor® 5

The Supermicro SuperDoctor 5 is a program that functions in a command-line or web-based interface for Windows and Linux operating systems. The program monitors such system health information as CPU temperature, system voltages, system power consumption, fan speed, and provides alerts via email or Simple Network Management Protocol (SNMP).

SuperDoctor 5 comes in local and remote management versions and can be used with Nagios to maximize your system monitoring needs. With SuperDoctor 5 Management Server (SSM Server), you can remotely control power on/off and reset chassis intrusion for multiple systems with SuperDoctor 5 or IPMI. SuperDoctor 5 Management Server monitors HTTP, FTP, and SMTP services to optimize the efficiency of your operation.

[SuperDoctor® Manual and Resources](#)

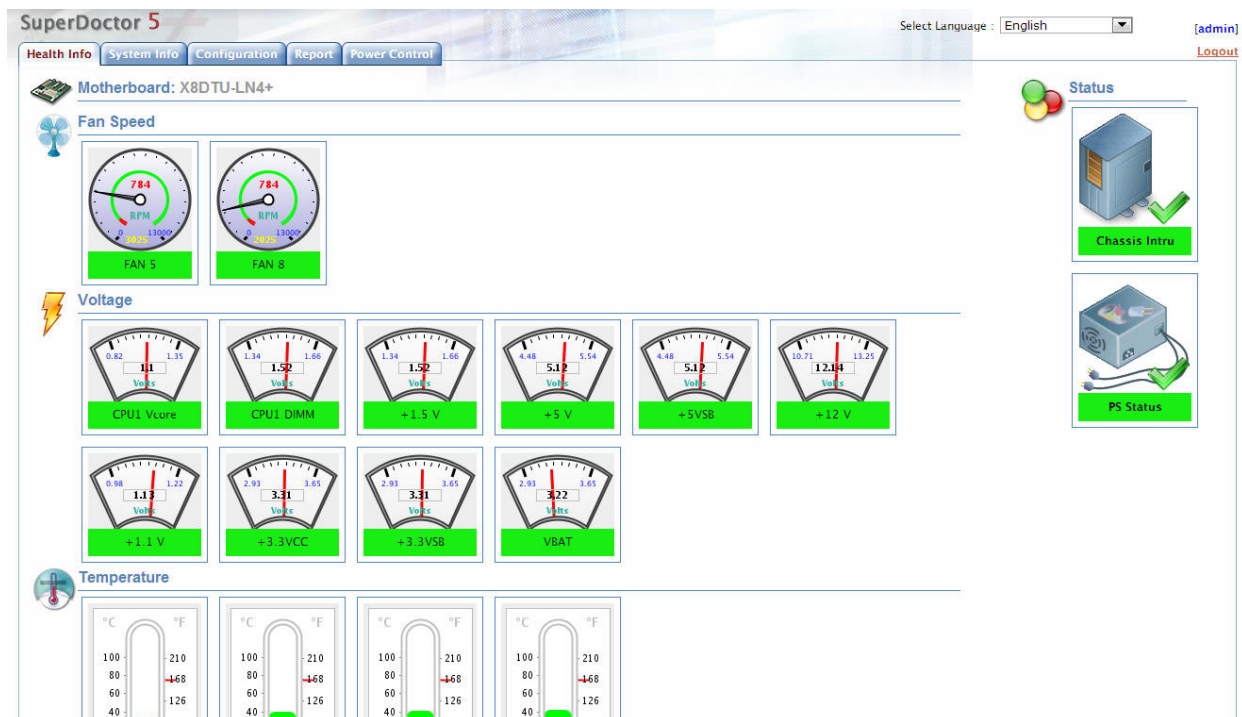

Figure A-2. SuperDoctor 5 Interface Display Screen (Health Information)

## A.6 IPMI

The H13SAE-MF supports the Intelligent Platform Management Interface (IPMI). IPMI is used to provide remote access, monitoring and management. There are several BIOS settings that are related to IPMI.

Supermicro ships standard products with a unique password for the BMC ADMIN user. This password can be found on a label on the motherboard.

For general documentation and information on IPMI, please visit our website at: <http://www.supermicro.com/products/nfo/IPMI.cfm>.

## Appendix B

### Standardized Warning Statements

The following statements are industry standard warnings, provided to warn the user of situations which have the potential for bodily injury. Should you have questions or experience difficulty, contact Supermicro's Technical Support department for assistance. Only certified technicians should attempt to install or configure components.

Read this section in its entirety before installing or configuring components.

These warnings may also be found on our website at [http://www.supermicro.com/about/policies/safety\\_information.cfm](http://www.supermicro.com/about/policies/safety_information.cfm).

#### B.1 Battery Handling



**Warning!** There is the danger of explosion if the battery is replaced incorrectly. Replace the battery only with the same or equivalent type recommended by the manufacturer. Dispose of used batteries according to the manufacturer's instructions

##### 電池の取り扱い

電池交換が正しく行われなかった場合、破裂の危険性があります。交換する電池はメーカーが推奨する型、または同等のものを使用下さい。使用済電池は製造元の指示に従って処分して下さい。

##### 警告

電池更換不當會有爆炸危險。請只使用同類電池或制造商推薦的功能相當的電池更換原有電池。請按製造商的說明處理廢舊電池。

##### 警告

電池更換不當會有爆炸危險。請使用製造商建議之相同或功能相當的電池更換原有電池。請按照製造商的說明指示處理廢棄舊電池。

##### Warnung

Bei Einsetzen einer falschen Batterie besteht Explosionsgefahr. Ersetzen Sie die Batterie nur durch den gleichen oder vom Hersteller empfohlenen Batterietyp. Entsorgen Sie die benutzten Batterien nach den Anweisungen des Herstellers.

**Attention**

Danger d'explosion si la pile n'est pas remplacée correctement. Ne la remplacer que par une pile de type semblable ou équivalent, recommandée par le fabricant. Jeter les piles usagées conformément aux instructions du fabricant.

**¡Advertencia!**

Existe peligro de explosión si la batería se reemplaza de manera incorrecta. Reemplazar la batería exclusivamente con el mismo tipo o el equivalente recomendado por el fabricante. Desechar las baterías gastadas según las instrucciones del fabricante.

**אזהרה!**

קיימת סכנת פיצוץ של הסוללה במידה והוחלפה בדרך לא תקינה. יש להחליף את הסוללה בסוג התואם מחברת יצרן מומלצת.

סילוק הסוללות המשומשות יש לבצע לפי הוראות היצרן.

هناك خطر من انفجار في حالة استبدال البطارية بطريقة غير صحيحة فعليك استبدال البطارية فقط بنفس النوع أو ما يعادلها كما أوصت به الشركة المصنعة تخلص من البطاريات المستعملة وفقا لتعليمات الشركة الصانعة

**경고!**

배터리가 올바르게 교체되지 않으면 폭발의 위험이 있습니다. 기존 배터리와 동일하거나 제조사에서 권장하는 동등한 종류의 배터리로만 교체해야 합니다. 제조사의 안내에 따라 사용된 배터리를 처리하여 주십시오.

**Waarschuwing**

Er is ontploffingsgevaar indien de batterij verkeerd vervangen wordt. Vervang de batterij slechts met hetzelfde of een equivalent type die door de fabrikant aanbevolen wordt. Gebruikte batterijen dienen overeenkomstig fabrieksvoorschriften afgevoerd te worden.

## B.2 Product Disposal



**Warning!** Ultimate disposal of this product should be handled according to all national laws and regulations.

### 製品の廃棄

この製品を廃棄処分する場合、国の関係する全ての法律・条例に従い処理する必要があります。

### 警告

本产品的废弃处理应根据所有国家的法律和规章进行。

### 警告

本產品的廢棄處理應根據所有國家的法律和規章進行。

### Warnung

Die Entsorgung dieses Produkts sollte gemäß allen Bestimmungen und Gesetzen des Landes erfolgen.

### ¡Advertencia!

Al deshacerse por completo de este producto debe seguir todas las leyes y reglamentos nacionales.

### Attention

La mise au rebut ou le recyclage de ce produit sont généralement soumis à des lois et/ou directives de respect de l'environnement. Renseignez-vous auprès de l'organisme compétent.

### סילוק המוצר

אזהרה!

סילוק סופי של מוצר זה חייב להיות בהתאם להנחיות וחוקי המדינה.

عند التخلص النهائي من هذا المنتج ينبغي التعامل معه وفقا لجميع القوانين واللوائح الوطنية

### 경고!

이 제품은 해당 국가의 관련 법규 및 규정에 따라 폐기되어야 합니다.

### Waarschuwing

De uiteindelijke verwijdering van dit product dient te geschieden in overeenstemming met alle nationale wetten en reglementen.