

SUPERO[®]

H8SSL-i

USER'S MANUAL

Revision 1.0b

The information in this User's Manual has been carefully reviewed and is believed to be accurate. The vendor assumes no responsibility for any inaccuracies that may be contained in this document, makes no commitment to update or to keep current the information in this manual, or to notify any person or organization of the updates. **Please Note: For the most up-to-date version of this manual, please see our web site at www.supermicro.com.**

SUPERMICRO COMPUTER reserves the right to make changes to the product described in this manual at any time and without notice. This product, including software, if any, and documentation may not, in whole or in part, be copied, photocopied, reproduced, translated or reduced to any medium or machine without prior written consent.

IN NO EVENT WILL SUPERMICRO COMPUTER BE LIABLE FOR DIRECT, INDIRECT, SPECIAL, INCIDENTAL, SPECULATIVE OR CONSEQUENTIAL DAMAGES ARISING FROM THE USE OR INABILITY TO USE THIS PRODUCT OR DOCUMENTATION, EVEN IF ADVISED OF THE POSSIBILITY OF SUCH DAMAGES. IN PARTICULAR, THE VENDOR SHALL NOT HAVE LIABILITY FOR ANY HARDWARE, SOFTWARE, OR DATA STORED OR USED WITH THE PRODUCT, INCLUDING THE COSTS OF REPAIRING, REPLACING, INTEGRATING, INSTALLING OR RECOVERING SUCH HARDWARE, SOFTWARE, OR DATA.

Any disputes arising between manufacturer and customer shall be governed by the laws of Santa Clara County in the State of California, USA. The State of California, County of Santa Clara shall be the exclusive venue for the resolution of any such disputes. Supermicro's total liability for all claims will not exceed the price paid for the hardware product.

FCC Statement: This equipment has been tested and found to comply with the limits for a Class A digital device pursuant to Part 15 of the FCC Rules. These limits are designed to provide reasonable protection against harmful interference when the equipment is operated in a commercial environment. This equipment generates, uses, and can radiate radio frequency energy and, if not installed and used in accordance with the manufacturer's instruction manual, may cause harmful interference with radio communications. Operation of this equipment in a residential area is likely to cause harmful interference, in which case you will be required to correct the interference at your own expense.

California Best Management Practices Regulations for Perchlorate Materials: This Perchlorate warning applies only to products containing CR (Manganese Dioxide) Lithium coin cells. "Perchlorate Material-special handling may apply. See www.dtsc.ca.gov/hazardouswaste/perchlorate"

WARNING: Handling of lead solder materials used in this product may expose you to lead, a chemical known to the State of California to cause birth defects and other reproductive harm.

Manual Revision 1.0b
Release Date: July 6, 2007

Unless you request and receive written permission from SUPER MICRO COMPUTER, you may not copy any part of this document.

Information in this document is subject to change without notice. Other products and companies referred to herein are trademarks or registered trademarks of their respective companies or mark holders.

Copyright © 2007 by SUPER MICRO COMPUTER INC.
All rights reserved.

Printed in the United States of America

Preface

About This Manual

This manual is written for system integrators, PC technicians and knowledgeable PC users. It provides information for the installation and use of the H8SSL-i motherboard. The H8SSL-i is based on the ServerWorks HT-1000 chipset and supports a single AMD Opteron 100 series processor in a 939-pin microPGA ZIF socket and up to 4 GB of unbuffered ECC DDR400/333 SDRAM.

Please refer to the serverboard specifications pages on our web site for updates on supported processors. This product is intended to be professionally installed.

Manual Organization

Chapter 1 includes a checklist of what should be included in your motherboard box, describes the features, specifications and performance of the motherboard and provides detailed information about the chipset.

Chapter 2 begins with instructions on handling static-sensitive devices. Read this chapter when installing the processor and memory modules and when installing the motherboard in a chassis. Also refer to this chapter to connect the floppy and hard disk drives, the serial ports, the mouse and keyboard and the twisted wires for the power and reset buttons and the system LEDs.

If you encounter any problems, see **Chapter 3**, which describes troubleshooting procedures for the video, the memory and the setup configuration stored in CMOS. For quick reference, a general FAQ (Frequently Asked Questions) section is provided. Instructions are also included for contacting technical support. In addition, you can visit our web site for more detailed information.

Chapter 4 includes an introduction to BIOS and provides detailed information on running the CMOS Setup utility.

Appendix A provides BIOS Error Beep Code Messages.

Appendix B lists BIOS POST Checkpoint Codes.

Table of Contents

Preface

About This Manual	iii
Manual Organization	iii

Chapter 1: Introduction

1-1 Overview	1-1
Checklist	1-1
H8SSL-i Image	1-3
H8SSL-i Motherboard Layout	1-4
H8SSL-i Quick Reference	1-5
Serverboard Features	1-6
ServerWorks HT-1000 Chipset: System Block Diagram	1-8
1-2 Chipset Overview	1-9
1-3 PC Health Monitoring	1-10
1-4 Power Configuration Settings	1-11
1-5 Power Supply	1-12
1-6 Super I/O	1-13

Chapter 2: Installation

2-1 Static-Sensitive Devices	2-1
2-2 Processor and Heatsink Installation	2-2
2-3 Mounting the Serverboard into a Chassis	2-4
2-4 Installing Memory	2-4
2-5 I/O Port and Control Panel Connections	2-6
2-6 Connector Definitions	2-7
Primary ATX Power Connector	2-7
Secondary Power Connector	2-7
NMI Button	2-7
Power LED	2-7
HDD LED	2-8
NIC1 LED	2-8
NIC2 LED	2-8
Overheat/Fan Fail LED	2-8
Power Fail LED	2-8
Reset Button	2-9
Power Button	2-9
Universal Serial Bus Ports (USB0/1)	2-9

Serial ATA Activity LEDs	2-9
USB2/3 Headers	2-10
Serial Ports	2-10
Fan Headers	2-10
Overheat LED	2-10
Power LED/Speaker	2-11
ATX PS/2 Keyboard/Mouse Ports	2-11
Wake-On-Ring	2-11
Wake-On-LAN	2-11
LAN1/2 (Ethernet Ports)	2-12
Chassis Intrusion	2-12
IPMI Header	2-12
Power Supply Fail Alarm Header	2-12
Power Supply Fail Alarm Reset Header	2-12
2-7 Jumper Settings	2-13
Explanation of Jumpers	2-13
CMOS Clear	2-13
Onboard Speaker Enable/Disable	2-14
PCI-X Slot Speed	2-14
VGA Enable/Disable	2-14
LAN Enable/Disable	2-14
Watch Dog Enable/Disable	2-15
Power Force On	2-15
SMBus Enable/Disable	2-15
2-8 Onboard Indicators	2-16
LAN1/LAN2 LEDs	2-16
SATA Activity LEDs	2-16
2-9 Floppy, IDE and SATA Drive Connections	2-17
Floppy Connector	2-17
IDE Connectors	2-18
SATA Connectors	2-18

Chapter 3: Troubleshooting

3-1 Troubleshooting Procedures	3-1
Before Power On	3-1
No Power	3-1
No Video	3-1
Memory Errors	3-2

Losing the System's Setup Configuration	3-2
3-2 Technical Support Procedures	3-2
3-3 Frequently Asked Questions	3-3
3-4 Returning Merchandise for Service	3-4

Chapter 4: BIOS

4-1 Introduction	4-1
4-2 Main Setup	4-2
4-3 Advanced Settings Menu	4-2
4-4 Boot Menu	4-12
4-6 Exit Menu	4-15

Appendices:

Appendix A: BIOS Error Beep Codes	A-1
Appendix B: BIOS POST Checkpoint Codes.....	B-1

Chapter 1

Introduction

1-1 Overview

Checklist

Congratulations on purchasing your computer motherboard from an acknowledged leader in the industry. Our boards are designed with the utmost attention to detail to provide you with the highest standards in quality and performance.

Please check that the following items have all been included with your motherboard. If anything listed here is damaged or missing, contact your retailer.

Included with retail box only

- One (1) H8SSL-i motherboard
- One (1) IDE cable (CBL-036)
- One (1) floppy cable (CBL-022)
- One (1) CPU backplate (BKT-0004)
- One (1) heatsink retention module with two (2) screws (BKT-0005)
- One (1) I/O backpanel shield for chassis (CSE-PT7)
- One (1) CD containing drivers and utilities

Contacting Super Micro

Headquarters

Address: Super Micro Computer, Inc.
980 Rock Ave.
San Jose, CA 95131 U.S.A.

Tel: +1 (408) 503-8000

Fax: +1 (408) 503-8008

Email: marketing@supermicro.com (General Information)
support@supermicro.com (Technical Support)

Web Site: www.supermicro.com

Europe

Address: Super Micro Computer B.V.
Het Sterrenbeeld 28, 5215 ML
's-Hertogenbosch, The Netherlands

Tel: +31 (0) 73-6400390

Fax: +31 (0) 73-6416525

Email: sales@supermicro.nl (General Information)
support@supermicro.nl (Technical Support)
rma@supermicro.nl (Customer Support)

Asia-Pacific

Address: Super Micro, Taiwan
4F, No. 232-1, Liancheng Rd.
Chung-Ho 235, Taipei County
Taiwan, R.O.C.

Tel: +886-(2) 8226-3990

Fax: +886-(2) 8226-3991

Web Site: www.supermicro.com.tw

Technical Support:

Email: support@supermicro.com.tw

Tel: 886-2-8228-1366, ext.132 or 139

Figure 1-1. H8SSL-i Image

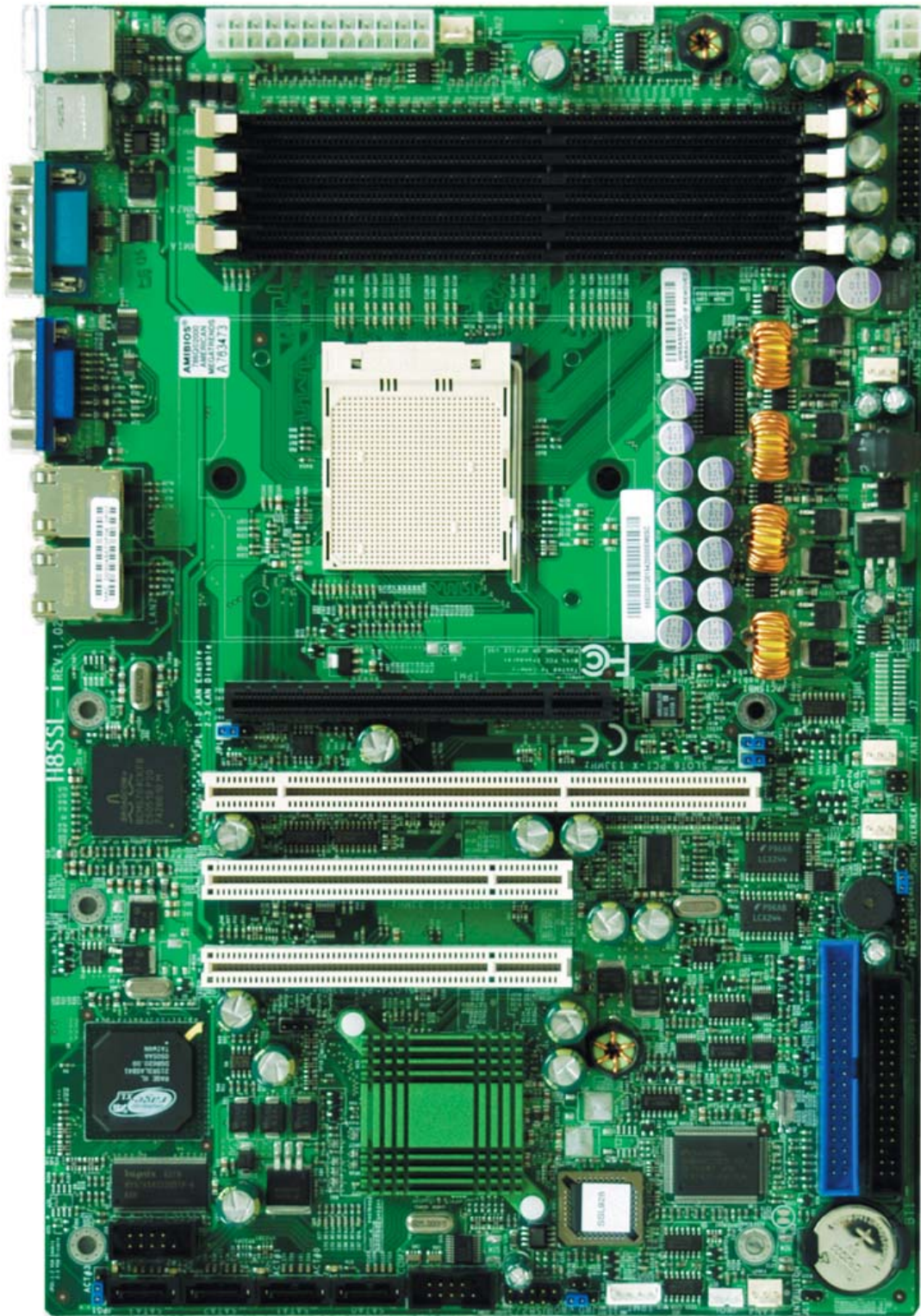
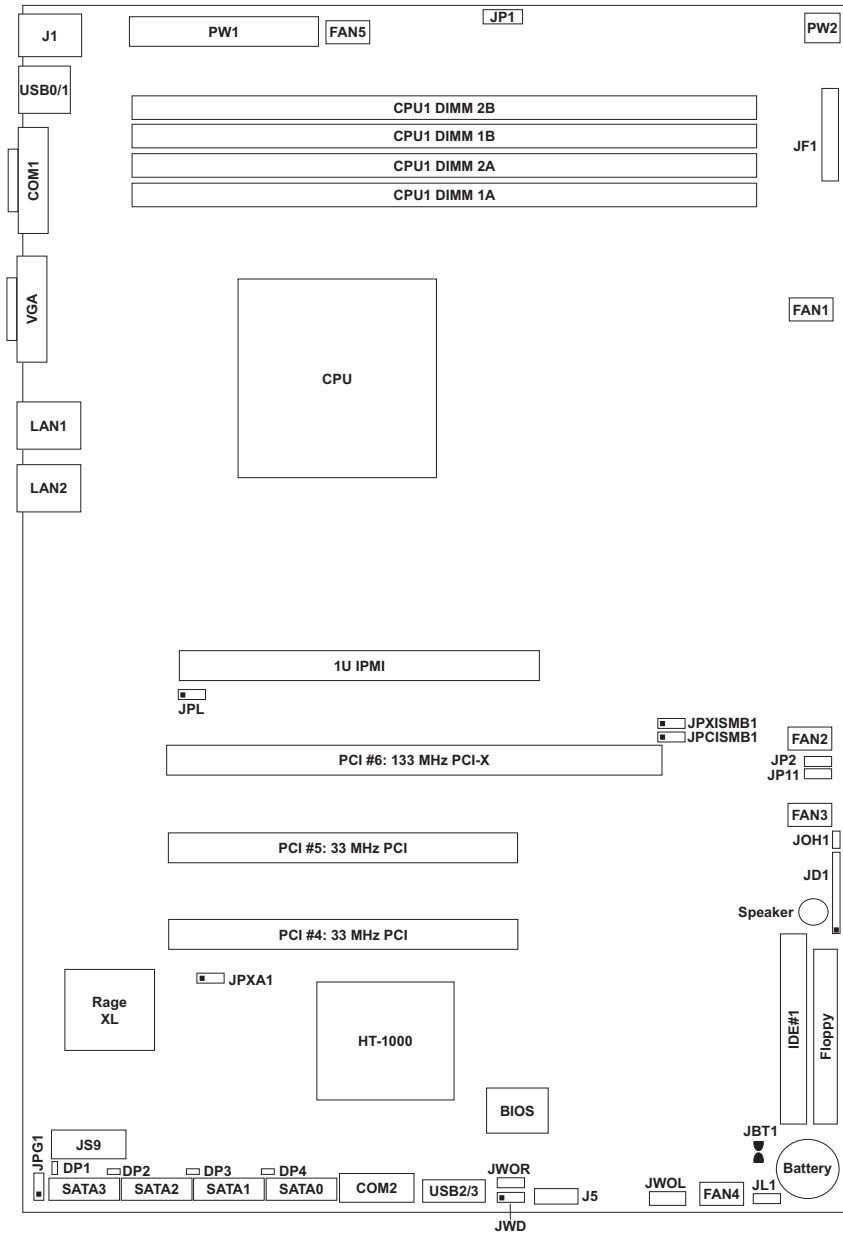

Figure 1-2. H8SSL-i Motherboard Layout
(not drawn to scale)



Notes:

Jumpers not indicated are for test purposes only.

H8SSL-i Quick Reference

Jumpers	Description	Default Setting
JBT1	CMOS Clear	See Section 2-7
JD1	Onboard Speaker En/Disable	Pins 6-7 (Enabled)
JP2	Power Force On	Open (Normal)
JPG1	VGA Enable/Disable	Pins 1-2 (Enabled)
JPL	LAN Enable/Disable	Pins 1-2 (Enabled)
JPCISMB1	SMBus Enable/Disable	Pins 1-2 (Enabled)
JPXISMB1	SMBus Enable/Disable	Pins 1-2 (Enabled)
JPXA1	PCI-X Slot Frequency Select	Open (Auto)
JWD	Watch Dog	Pins 1-2 (Reset)

Connectors	Description
1U IPMI	IPMI 2.0 Socket
COM1/COM2	COM1 Serial Port/Header
FAN1 - 5	Fan Headers
Floppy	Floppy Disk Drive Connector
IDE#1	IDE Connector
J1	Keyboard/Mouse Ports
J5	IPMI Header
JD1	Power LED/Speaker Header
JF1	Front Panel Connector
JL1	Chassis Intrusion Header
JOH1	Overheat Warning Header
JP1	Power Supply Fail Signal Header
JP11	Power Supply Fail Alarm Reset Header
JS9	Serial ATA LED Activity Header
JWOL	Wake-On-LAN Header
JWOR	Wake-On-Ring Header
LAN1/2	Gigabit Ethernet (RJ45) Ports
PW1	Primary 24-pin ATX Power Connector
PW2	Secondary 4-pin Power Connector
SATA0/1/2/3	Serial ATA Connectors
USB0/1	USB (Universal Serial Bus) Ports 0/1
USB2/3	USB2/3 Headers
VGA	Video (Monitor) Port

Onboard LEDs	Description
DP1 - DP4	Serial ATA Activity LEDs

Serverboard Features

CPU

- Single AMD Opteron 100 Series 64-bit processor in a 939-pin microPGA ZIF socket

Memory

- Four dual/single channel DIMM slots supporting up to 4 GB of unbuffered ECC DDR400/333 SDRAM

Note: Refer to Section 2-4 before installing.

Chipset

- ServerWorks HT-1000

Expansion Slots

- One (1) 64-bit, 133 MHz PCI-X slot (3.3V)
- Two (2) 32-bit, 33 MHz PCI slots (5V)

BIOS

- 4 Mb Firmware Hub AMIBIOS® Flash ROM
- APM 1.2, DMI 2.3, PCI 2.2, ACPI 1.0 (ACPI 2.0 is BIOS supported), Plug and Play (PnP)

PC Health Monitoring

- Onboard monitors for CPU core voltage, +2.5V, +3.3V, +5V, +12V and battery voltage
- Fan status monitor with firmware/software speed control in BIOS
- Watch Dog, NMI
- Environmental temperature monitoring via BIOS
- Power-up mode control for recovery from AC power loss
- System resource alert
- Hardware BIOS virus protection
- Auto-switching voltage regulator for the CPU core

ACPI Features

- Microsoft OnNow
- Slow blinking LED for suspend state indicator
- BIOS support for USB keyboard
- Main switch override mechanism
- Internal/external modem ring-on

Onboard I/O

- On-chip Serial ATA controller for 4-port SATA
- One (1) UDMA/ATA100 IDE port
- One (1) floppy port interface (up to 2.88 MB)
- Two (2) Fast UART 16550 compatible serial connectors (1 header, 1 port)
- Broadcom BCM5704 Ethernet controller supports two Gigabit LAN ports
- PS/2 mouse and PS/2 keyboard ports
- Four (4) USB 2.0 ports (two ports, two headers)
- ATI Rage 8 MB XL graphics chip
- VGA port

Other

- Wake-on-Ring (JWOR)
- Wake-on-LAN (JWOL)

CD Utilities

- BIOS flash upgrade utility

Dimensions

- ATX form factor: 8" x 12" (203 x 305 mm)

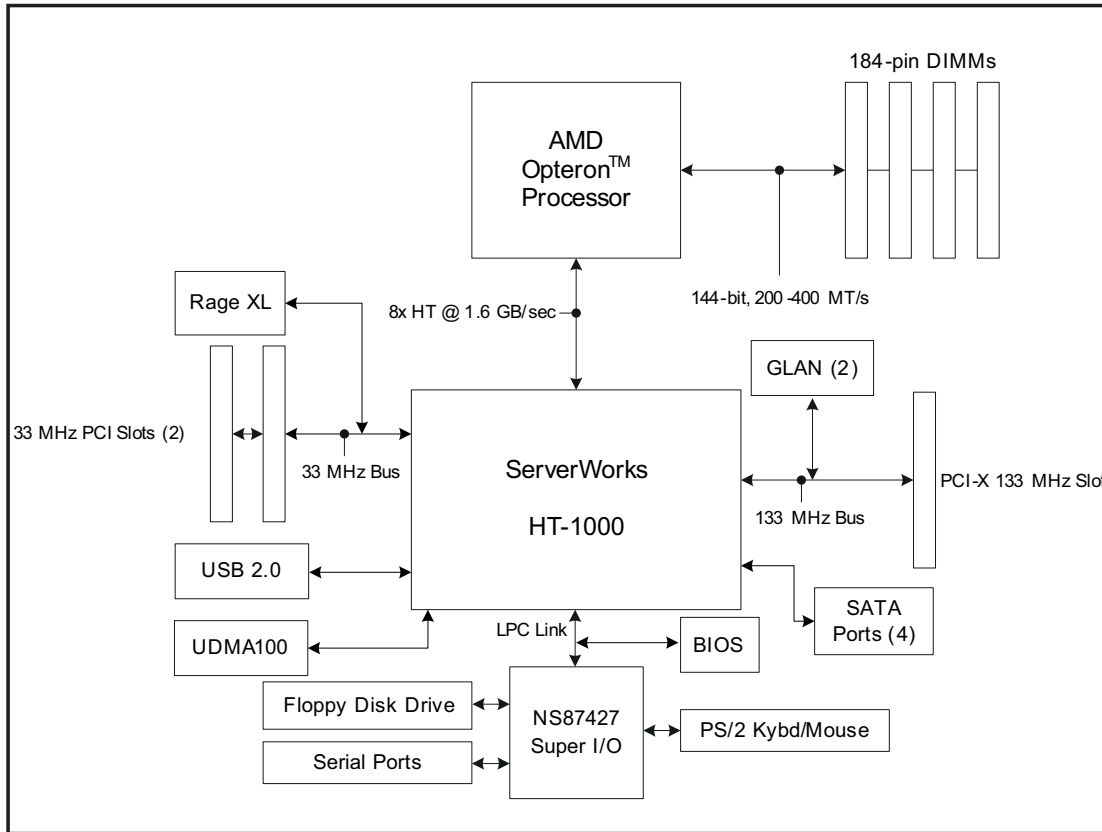

**Figure 1-5. ServerWorks HT-1000™ Chipset:
System Block Diagram**

Note: This is a general block diagram and may not exactly represent the features on your serverboard. See the previous pages for the actual specifications of your serverboard.

1-2 Chipset Overview

The H8SSL-i serverboard is based on Serverworks' HT-1000 chipset, which functions as a HyperTransport™ SystemI/O™ Hub. The HT-1000 chipset provides high performance, scalability and reliability. Its HyperTransport architecture reduces IO bottlenecks to improve overall system performance. System memory controllers not part of the chipset but instead are integrated into the processors to decrease latency.

HT-1000 HyperTransport I/O Hub

The HT-1000 I/O hub interconnects the CPU/host bridge with the I/O bridge via a HyperTransport bus to provide an interface to the various subsystems including the Super I/O functions, the onboard graphics, the IDE controller and the USB ports.

HyperTransport Technology

HyperTransport technology is a high-speed, low latency point to point link that was designed to increase the communication speed by a factor of up to 48x between integrated circuits. This is done partly by reducing the number of buses in the chipset to reduce bottlenecks and by enabling a more efficient use of memory in multi-processor systems. The end result is a significant increase in bandwidth within the chipset.

1-3 PC Health Monitoring

This section describes the PC health monitoring features of the H8SSL-i. The serverboard has an onboard System Hardware Monitor chip that supports PC health monitoring.

Onboard Voltage Monitors for the CPU core, +5Vin, +12Vin, -12V, Memory, 1.2V, +5V Standby, +2.5V Standby and Battery Voltage

The onboard voltage monitor will scan these voltages continuously. Once a voltage becomes unstable, it will give a warning or send an error message to the screen. Users can adjust the voltage thresholds to define the sensitivity of the voltage monitor. Real time readings of these voltage levels are all displayed in the System Health Monitor section of BIOS.

Fan Status Monitor with Firmware/Software Speed Control

The PC health monitor can check the RPM status of the cooling fans. The onboard fans are controlled by thermal management via BIOS.

CPU Overheat/Fan Fail LED and Control

This feature is available when the user enables the CPU overheat/Fan Fail warning function in the BIOS. This allows the user to define an overheat temperature. When this temperature is exceeded or when a fan failure occurs, then, the Overheat/Fan Fail warning LED is triggered.

Auto-Switching Voltage Regulator for the CPU Core

The 3-phase-switching voltage regulator for the CPU core can support up to 80A and auto-sense voltage IDs ranging from 0.875 V to 1.6V. This will allow the regulator to run cooler and thus make the system more stable.

1-4 Power Configuration Settings

This section describes the features of your serverboard that deal with power and power settings.

Microsoft OnNow

The OnNow design initiative is a comprehensive, system-wide approach to system and device power control. OnNow is a term for a PC that is always on but appears to be off and responds immediately to user or other requests.

Slow Blinking LED for Suspend-State Indicator

When the CPU goes into a suspend state, the chassis power LED will start blinking to indicate that the CPU is in suspend mode. When the user presses any key, the CPU will wake-up and the LED will automatically stop blinking and remain on.

BIOS Support for USB Keyboard

If a USB keyboard is the only keyboard in the system, it will function like a normal keyboard during system boot-up.

Main Switch Override Mechanism

When an ATX power supply is used, the power button can function as a system suspend button. When the user depresses the power button, the system will enter a SoftOff state. The monitor will be suspended and the hard drive will spin down. Depressing the power button again will cause the whole system to wake-up. During the SoftOff state, the ATX power supply provides power to keep the required circuitry in the system alive. In case the system malfunctions and you want to turn off the power, just depress and hold the power button for 4 seconds. The power will turn off and no power will be provided to the serverboard.

Wake-On-Ring Header (JWOR)

Wake-up events can be triggered by a device such as the external modem ringing when the system is in the SoftOff state. Note that external modem ring-on can only be used with an ATX 2.01 (or above) compliant power supply.

1-5 Power Supply

As with all computer products, a stable power source is necessary for proper and reliable operation. It is even more important for processors that have high CPU clock rates of 1 GHz and faster.

The H8SSL-i accommodates 12V ATX power supplies. Although most power supplies generally meet the specifications required by the CPU, some are inadequate. A 2 amp current supply on a 5V Standby rail is strongly recommended.

It is strongly recommended that you use a high quality power supply that meets 12V ATX power supply Specification 1.1 or above. Additionally, in areas where noisy power transmission is present, you may choose to install a line filter to shield the computer from noise. It is recommended that you also install a power surge protector to help avoid problems caused by power surges.

Warning: To prevent the possibility of explosion, do not use the wrong type of onboard CMOS battery or install it upside down.

1-6 Super I/O

The disk drive adapter functions of the Super I/O chip include a floppy disk drive controller that is compatible with industry standard 82077/765, a data separator, write pre-compensation circuitry, decode logic, data rate selection, a clock generator, drive interface control logic and interrupt and DMA logic. The wide range of functions integrated onto the Super I/O greatly reduces the number of components required for interfacing with floppy disk drives. The Super I/O supports two 360 K, 720 K, 1.2 M, 1.44 M or 2.88 M disk drives and data transfer rates of 250 Kb/s, 500 Kb/s or 1 Mb/s.

It also provides two high-speed, 16550 compatible serial communication ports (UARTs), one of which supports serial infrared communication. Each UART includes a 16-byte send/receive FIFO, a programmable baud rate generator, complete modem control capability and a processor interrupt system. Both UARTs provide legacy speed with baud rate of up to 115.2 Kbps as well as an advanced speed with baud rates of 250 K, 500 K, or 1 Mb/s, which support higher speed modems.

The Super I/O provides functions that comply with ACPI (Advanced Configuration and Power Interface), which includes support of legacy and ACPI power management through a SMI or SCI function pin. It also features auto power management to reduce power consumption.

The IRQs, DMAs and I/O space resources of the Super I/O can be flexibly adjusted to meet ISA PnP requirements, which support ACPI and APM (Advanced Power Management).

Notes

Chapter 2

Installation

2-1 Static-Sensitive Devices

Electrostatic Discharge (ESD) can damage electronic components. To prevent damage to your motherboard, it is important to handle it very carefully. The following measures are generally sufficient to protect your equipment from ESD.

Precautions

- Use a grounded wrist strap designed to prevent static discharge.
- Touch a grounded metal object before removing the board from the antistatic bag.
- Handle the board by its edges only; do not touch its components, peripheral chips, memory modules or gold contacts.
- When handling chips or modules, avoid touching their pins.
- Put the motherboard and peripherals back into their antistatic bags when not in use.
- For grounding purposes, make sure your computer chassis provides excellent conductivity between the power supply, the case, the mounting fasteners and the motherboard.
- Use only the correct type of CMOS onboard battery as specified by the manufacturer. Do not install the CMOS onboard battery upside down, which may result in a possible explosion.

Unpacking

The motherboard is shipped in antistatic packaging to avoid static damage. When unpacking the board, make sure the person handling it is static protected.

Installation Procedures

Follow the procedures as listed below to install the motherboard into a chassis:

1. Install the processor(s) and the heatsink(s).
2. Install the motherboard in the chassis.
3. Install the memory and add-on cards.
4. Finally, connect the cables and install the drivers.

2-2 Processor and Heatsink Installation



Exercise extreme caution when handling and installing the processor. Always connect the power cord last and always remove it before adding, removing or changing any hardware components.

Installing the CPU Backplates

One CPU backplate (BKT-0004) is included in the retail box. The backplate prevents the CPU area of the motherboard from bending and provide a base for attaching the heatsink retention modules. To install, begin by peeling off the release paper to expose the adhesive. On the underside of the motherboard, locate the two holes on either side of the CPU socket. Attach the adhesive side of the backplate to the board by inserting the standoffs into the two holes and applying light pressure so that the backplate sticks to the underside of the board. See Figure 2-1.

Installing the Processor

1. Lift the lever on CPU socket until it points straight up.



2. Use your thumb and your index finger to hold the CPU. Locate pin 1 on the CPU socket and pin 1 on the CPU. Both are marked with a triangle.



3. Align pin 1 of the CPU with pin 1 of the socket. Once aligned, carefully place the CPU into the socket. *Do not drop the CPU on the socket, move the CPU horizontally or vertically or rub the CPU against the socket or against any pins of the socket, which may damage the CPU and/or the socket.*



4. With the CPU inserted into the socket, inspect the four corners of the CPU to make sure that it is properly installed and flush with the socket.



5. Gently press the CPU socket lever down until it locks in the plastic tab.



Installing the Heatsink Retention Modules

One heatsink retention module (BKT-0005) and two screws are included in the retail box. Once installed, these are used to help attach the heatsink to the CPU. To install, position the module so that the CPU backplate standoffs insert through the holes on the heatsink retention module and the four feet on the module contact the motherboard. Secure the retention module to the backplate with the two screws provided. See Figure 2-1. **Note:** BKT-0005 is included for use with non-proprietary heatsinks only. When installing Super Micro heatsinks, only BKT-0004 (CPU backplate) is needed. The BKT-0005 retention module was designed to provide compatibility with clip-and-cam type heatsinks from third parties.

Figure 2-1. CPU Backplate/Heatsink Retention Module Installation

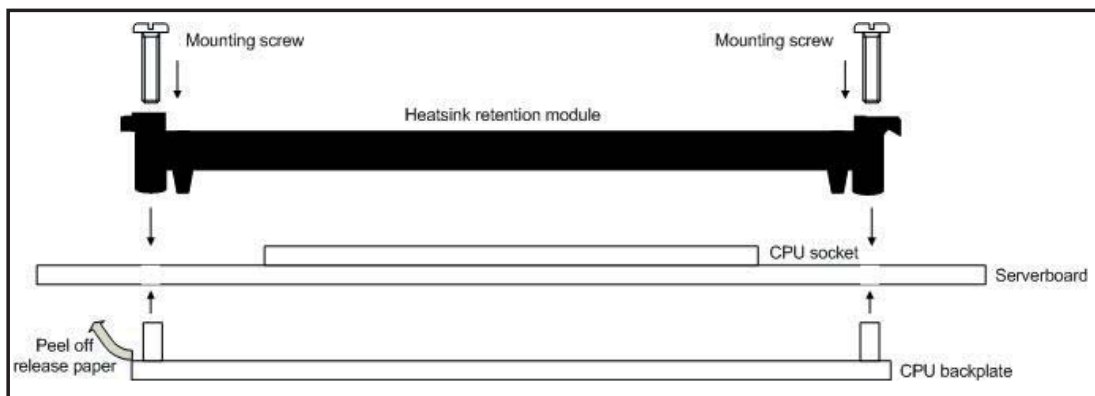

Installing the Heatsink

We recommend the use of active type heatsinks (except for 1U systems). Connect the heatsink fans to a fan header near the CPU. To install the heatsinks, please follow the instructions included with your heatsink package (not included).

2-3 Mounting the Motherboard into a Chassis

All motherboards have standard mounting holes to fit different types of chassis. Make sure that the locations of all the mounting holes for both the motherboard and the chassis match. Although a chassis may have both plastic and metal mounting fasteners, metal ones are highly recommended because they ground the motherboard to the chassis. Make sure that the metal standoffs click in or are screwed in tightly.

1. Check the compatibility of the motherboard ports and the I/O shield

The H8SSL-i motherboard requires a chassis that can support ATX boards 8" x 12" in size. Make sure that the I/O ports on the motherboard align with their respective holes in the I/O shield at the rear of the chassis.

2. Mounting the motherboard onto the motherboard tray in the chassis

Carefully mount the motherboard onto the tray by aligning the motherboard mounting holes with the raised metal standoffs in the tray. Insert screws into all the mounting holes in the motherboard that line up with the standoffs. Then use a screwdriver to secure the motherboard to the mainboard tray - tighten until just snug (if too tight you might strip the threads). Metal screws provide an electrical contact to the motherboard ground to provide a continuous ground for the system.

2-4 Installing Memory

CAUTION

Exercise extreme care when installing or removing memory modules to prevent any possible damage.

1. Insert each memory module vertically into its slot, beginning with slot 1A, then 2A, etc.. Pay attention to the notch along the bottom of the module to prevent inserting the module incorrectly (see Figure 2-2). See support information below.

2. Gently press down on the memory module until it snaps into place.

Note: It is highly recommended that you remove the power cord from the system before installing or changing any memory modules.

Support

The H8SSL-i supports single or dual-channel, unbuffered ECC DDR400/333 SDRAM.

Both interleaved and non-interleaved memory are supported, so you may populate any number of DIMM slots (see note on previous page).

Populating two adjacent slots at a time with memory modules of the same size and type will result in interleaved (128-bit) memory, which is faster than non-interleaved (64-bit) memory.

Maximum memory: 4 GB of unbuffered ECC DDR400/333.

Figure 2-2. Side and Top Views of DDR Installation

To Install:

Insert module vertically and press down until it snaps into place. The release tabs should close - if they do not you should close them yourself.

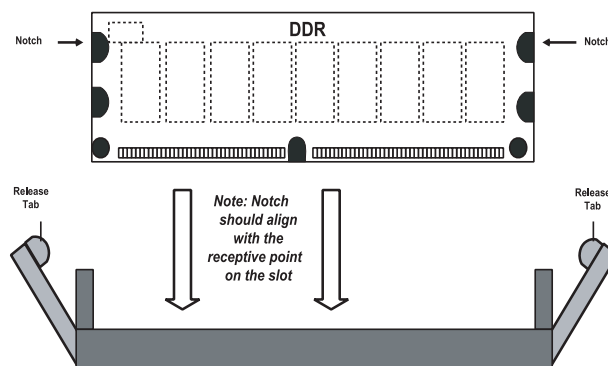

Note the notch in the slot and on the bottom of the DIMM. These prevent the DIMM from being installed incorrectly.

To Remove:

Use your thumbs to gently push each release tab outward to release the DIMM from the slot.

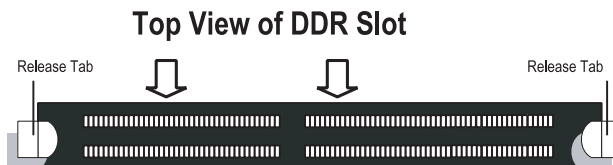

2-5 I/O Port and Control Panel Connections

The I/O ports are color coded in conformance with the PC99 specification to make setting up your system easier. See Figure 2-3 below for the colors and locations of the various I/O ports.

Figure 2-3. I/O Port Locations and Definitions

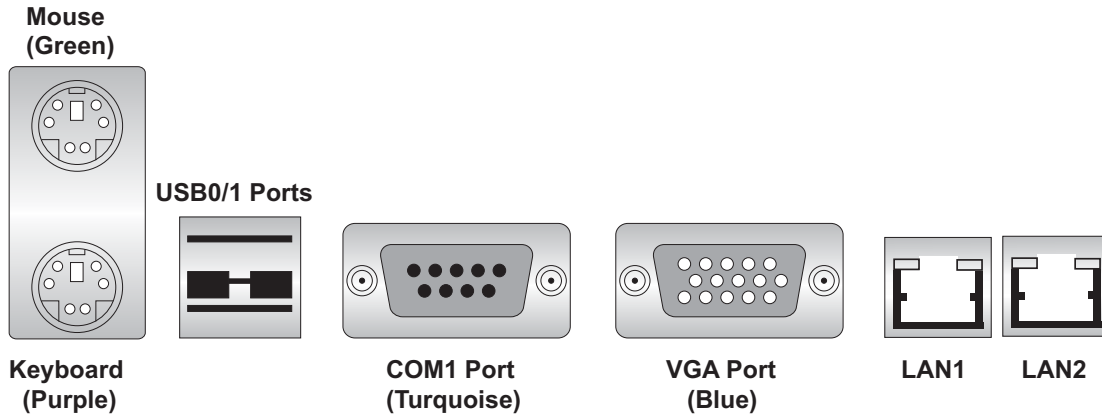

Front Control Panel

JF1 contains header pins for various front control panel connectors. See Figure 2-4 for the pin definitions of the various connectors. Refer to Section 2-6 for details.

Figure 2-4. JF1: Front Control Panel Header (JF1)

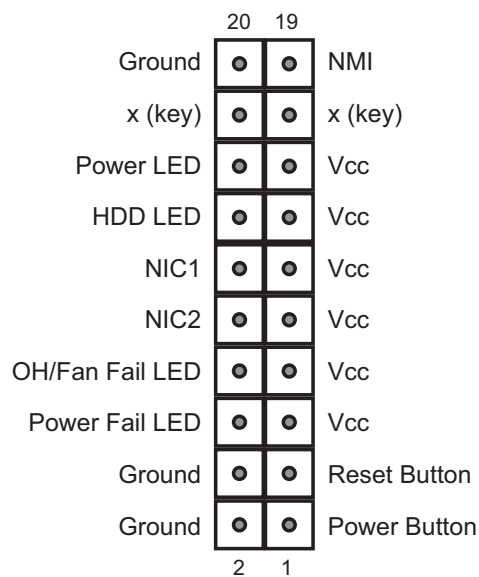

2-6 Connector Definitions

Primary ATX Power Connector

The primary power connector on the H8SSL-i meets the SSI (Superset ATX) 24-pin specification. Refer to the table on the right for the pin definitions of the main ATX power connector.

Note: You must also connect the PW2 power connector to your power supply (see below).

ATX Power 24-pin Connector Pin Definitions (PW1)			
Pin#	Definition	Pin #	Definition
13	+3.3V	1	+3.3V
14	-12V	2	+3.3V
15	COM	3	COM
16	PS_ON	4	+5V
17	COM	5	COM
18	COM	6	+5V
19	COM	7	COM
20	Res (NC)	8	PWR_OK
21	+5V	9	5VSB
22	+5V	10	+12V
23	+5V	11	+12V
24	COM	12	+3.3V

Required Connection

Secondary Power Connector

In addition to the primary ATX power connector (above), the 4-pin power connector at PW2 must also be connected to your power supply. See the table on the right for pin definitions.

Secondary Power Connector Pin Definitions (PW2)	
Pins	Definition
1 & 2	Ground
3 & 4	+12V

Required Connection

NMI Button

The non-maskable interrupt button header is located on pins 19 and 20 of JF1. Refer to the table on the right for pin definitions.

NMI Button Pin Definitions (JF1)	
Pin#	Definition
19	Control
20	Ground

Power LED

The Power LED connection is located on pins 15 and 16 of JF1. Refer to the table on the right for pin definitions.

Power LED Pin Definitions (JF1)	
Pin#	Definition
15	Vcc
16	Control

HDD LED

The HDD (IDE Hard Disk Drive) LED connection is located on pins 13 and 14 of JF1. Attach the IDE hard drive LED cable to display disk activity. Refer to the table on the right for pin definitions.

HDD LED Pin Definitions (JF1)	
Pin#	Definition
13	Vcc
14	HD Active

NIC1 LED

The NIC1 (Network Interface Controller) LED connection is located on pins 11 and 12 of JF1. Attach the NIC1 LED cable to display network activity. Refer to the table on the right for pin definitions.

NIC1 LED Pin Definitions (JF1)	
Pin#	Definition
11	Vcc
12	NIC1 Active

NIC2 LED

The NIC2 (Network Interface Controller) LED connection is located on pins 9 and 10 of JF1. Attach the NIC2 LED cable to display network activity. Refer to the table on the right for pin definitions.

NIC2 LED Pin Definitions (JF1)	
Pin#	Definition
9	Vcc
10	NIC2 Active

Overheat/Fan Fail LED

Connect an LED to the OH connection on pins 7 and 8 of JF1 to provide advanced warning of chassis overheating. Refer to the table on the right for pin definitions.

OH/Fan Fail LED Pin Definitions (JF1)	
Pin#	Definition
7	Vcc
8	Control

Power Fail LED

The Power Fail LED connection is located on pins 5 and 6 of JF1. See the table on the right for pin definitions.

Power Fail LED Pin Definitions (JF1)	
Pin#	Definition
5	Vcc
6	Control

Note: This feature is only available when using redundant power supplies.

Reset Button

The Reset Button connection is located on pins 3 and 4 of JF1. Attach it to the hardware reset switch on the computer case. Refer to the table on the right for pin definitions.

Reset Button Pin Definitions (JF1)	
Pin#	Definition
3	Reset
4	Ground

Power Button

The Power Button connection is located on pins 1 and 2 of JF1. Momentarily contacting both pins will power on/off the system. This button can also be configured to function as a suspend button (see the Power Button Mode setting in BIOS). To turn off the power when set to suspend mode, depress the button for at least 4 seconds. Refer to the table on the right for pin definitions.

Power Button Pin Definitions (JF1)	
Pin#	Definition
1	PW_ON
2	Ground

USB0/1 (Universal Serial Bus Ports)

Two Universal Serial Bus ports (USB2.0) are located beside the keyboard/mouse ports on the I/O backpanel. See the table on the right for pin definitions.

Universal Serial Bus Ports Pin Definitions (USB0/1)			
USB0		USB1	
Pin #	Definition	Pin #	Definition
1	+5V	1	+5V
2	PO-	2	PO-
3	PO+	3	PO+
4	Ground	4	Ground

Serial ATA Activity LEDs

Connect an LED to the JS9 header to provide indication of Serial ATA drive activity. See the table on the right for pin definitions.

Serial ATA Activity LEDs Pin Definitions (JS9)			
Pin #	Definition	Pin #	Definition
1	SATA0 LED	6	NC
2	SATA1 LED	7	NC
3	SATA2 LED	8	NC
4	SATA3 LED	9	NC
5	Ground	10	Key

Note: NC indicates no connection.

USB2/3 Headers

Two additional USB2.0 headers (USB2/3) are included on the motherboard near the COM2 header. These may be connected to provide front side USB access. USB cables (not included) are needed for the connections. See the table on the right for pin definitions.

Extra Universal Serial Bus Headers Pin Definitions (USB2/3)			
USB2		USB3/4	
Pin #	Definition	Pin #	Definition
1	+5V	1	+5V
2	PO-	2	PO-
3	PO+	3	PO+
4	Ground	4	Ground
5	Key	5	No connection

Serial Ports

The COM1 serial port is located between the USB ports and the VGA port. COM2 is a header located near the SATA0 port (see motherboard layout for location). See the table on the right for pin definitions.

Serial Port Pin Definitions (COM1/COM2)			
Pin #	Definition	Pin #	Definition
1	DCD	6	DSR
2	RXD	7	RTS
3	TXD	8	CTS
4	DTR	9	RI
5	Ground	10	NC

Note: Pin 10 is included on the header but not on the port. NC indicates no connection.

Fan Headers

The H8SSL-i has five 3-pin fan headers. Fan speed is controlled via Thermal Management with a BIOS setting (refer to Chapter 4). See the table on the right for pin definitions.

Fan Header Pin Definitions (FAN1-5)	
Pin#	Definition
1	Ground
2	+12V
3	Tachometer

Overheat LED (JOH1)

Connect an LED to the JOH1 header to provide warning of chassis overheating. See the table on the right for pin definitions.

Overheat LED Pin Definitions (JOH1)	
Pin#	Definition
1	+5V
2	OH Active

Power LED/Speaker

On JD1, pins 1, 2, and 3 are for the power LED and pins 4 through 7 are for the speaker. See the tables on the right for pin definitions.

Note: The speaker connector pins are for use with an external speaker. If you wish to use the onboard speaker, you should close pins 6 and 7 with a jumper.

PWR LED Connector Pin Definitions (JD1)	
Pin#	Definition
1	+Vcc
2	Control
3	Control

Speaker Connector Pin Definitions (JD1)	
Pin#	Definition
4	Red wire, Speaker data
5	No connection
6	Buzzer signal
7	Speaker data

ATX PS/2 Keyboard and PS/2 Mouse Ports

The ATX PS/2 keyboard and the PS/2 mouse ports are located beside the USB ports. See the table on the right for pin definitions.

PS/2 Keyboard and Mouse Port Pin Definitions (J1)			
Pin #	Definition	Pin #	Definition
1	Data	4	VCC
2	NC	5	Clock
3	Ground	6	NC

Wake-On-Ring

The Wake-On-Ring header is designated JWOR. This function allows your computer to receive and "wake-up" by an incoming call to the modem when in suspend state. See the table on the right for pin definitions. You must have a Wake-On-Ring card and cable to use this feature.

Wake-On-Ring Pin Definitions (JWOR)	
Pin#	Definition
1	Ground (Black)
2	Wake-up

Wake-On-LAN

The Wake-On-LAN header is designated JWOL. See the table on the right for pin definitions. You must have a LAN card with a Wake-On-LAN connector and cable to use the Wake-On-LAN feature.

Wake-On-LAN Pin Definitions (JWOL)	
Pin#	Definition
1	+5V Standby
2	Ground
3	Wake-up

LAN1/2 (Ethernet Ports)

Two Gigabit Ethernet ports (designated LAN1 and LAN2) are located beside the VGA port. These ports accept RJ45 type cables.



Chassis Intrusion

A Chassis Intrusion header is located at JL1. Attach the appropriate cable to inform you of a chassis intrusion.

Chassis Intrusion Pin Definitions (JL1)	
Pin#	Definition
1	Intrusion Input
2	Ground

IPMI Header

The Intelligent Platform Management Interface (IPMI) header is located at J5. Connect the appropriate cable here to utilize IPMB on your system. See the table on the right for pin definitions.

IPMI Pin Definitions (J5)	
Pin#	Definition
1	Data
2	Ground
3	Clock
4	N/A

Power Supply Fail Alarm Header

Connect a cable from your power supply to JP1 to provide you with warning of a power supply failure. The warning signal is passed through the PWR_LED pin to indicate a power failure. See the table on the right for pin definitions.

Power Supply Fail Alarm Header Pin Definitions (JP1)	
Pin#	Definition
1	P/S 1 Fail Signal
2	P/S 2 Fail Signal
3	NC
4	Reset (from MB)

Note: This feature is only available when using redundant power supplies.

Power Supply Fail Alarm Reset Header

Connect JP11 to the alarm reset button on your chassis (if available) or to a microswitch to allow you to turn off the alarm that sounds when a power supply module fails. See the table on the right for pin definitions.

Alarm Reset Header Pin Definitions (JP11)	
Pin#	Definition
1	Ground
2	Reset Signal

2-7 Jumper Settings

Explanation of Jumpers

To modify the operation of the serverboard, jumpers can be used to choose between optional settings. Jumpers create shorts between two pins to change the function of the connector. Pin 1 is identified with a square solder pad on the printed circuit board. See the diagram at right for an example of jumping pins 1 and 2. Refer to the serverboard layout page for jumper locations.

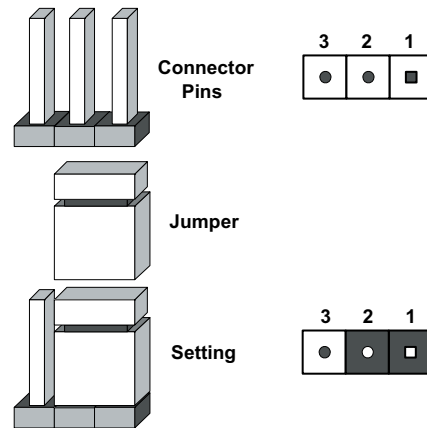

Note: On two-pin jumpers, "Closed" means the jumper is on and "Open" means the jumper is off the pins.

CMOS Clear

JBT1 is used to clear CMOS and will also clear any passwords. Instead of pins, this jumper consists of contact pads to prevent accidentally clearing the contents of CMOS.

To clear CMOS,

- 1) First power down the system and unplug the power cord(s).
- 2) With the power disconnected, short the CMOS pads with a metal object such as a small screwdriver for at least four seconds.
- 3) Remove the screwdriver (or shorting device).
- 4) Reconnect the power cord(s) and power on the system.

Notes:

Do not use the PW_ON connector to clear CMOS.

The onboard battery does not need to be removed when clearing CMOS, however you must short JBT1 for at least four seconds.



JBT1 contact pads

Onboard Speaker Enable/ Disable

The JD1 header allows you to use either an external speaker or the internal (onboard) speaker. To use the internal (onboard) speaker, close pins 6 and 7 with a jumper. To use an external speaker, connect the speaker wires to pins 4 through 7 of JD1. See the table on the right for settings and the table associated with the Power LED/Speaker connection (previous section) for pin definitions.

Onboard Speaker Enable/Disable Pin Definitions (JD1)	
Pins	Definition
6-7	Jump for onboard speaker
4-7	Attach external speaker wires

PCI-X Slot Speed

Jumpers JPXA1 can be used to change the speed of PCI-X slot #6. See the table on the right for jumper settings.

PCI-X Slot Speed Jumper Settings (JPXA1)	
Jumper Setting	Definition
Open	Auto
Pins 1-2	PCI-X 66 MHz
Pins 2-3	PCI 66 MHz

VGA Enable/Disable

JPG1 allows you to enable or disable the VGA port. The default position is on pins 1 and 2 to enable VGA. See the table on the right for jumper settings.

VGA Enable/Disable Jumper Settings (JPG1)	
Jumper Setting	Definition
Pins 1-2	Enabled
Pins 2-3	Disabled

LAN Enable/Disable

Change the setting of jumper JPL to enable or disable the LAN1 and LAN2 Gb Ethernet ports. See the table on the right for jumper settings. The default setting is enabled.

JLAN1/2 Enable/Disable Jumper Settings (JPL)	
Jumper Setting	Definition
Pins 1-2	Enabled
Pins 2-3	Disabled

Watch Dog Enable/Disable

JWD controls the Watch Dog function. Watch Dog is a system monitor that can reboot the system when a software application hangs. Pins 1-2 will cause WD to reset the system if an application has frozen. Pins 2-3 will generate a non-maskable interrupt signal for the application that is frozen. See the table on the right for jumper settings. Watch Dog must also be enabled in BIOS.

Watch Dog Jumper Settings (JWD)	
Jumper Setting	Definition
Pins 1-2	Reset
Pins 2-3	NMI
Open	Disabled

Note: When enabled, the user needs to write their own application software in order to disable the Watch Dog Timer.

Power Force On

JP2 allows you to enable or disable the Power Force On function. If enabled, system power will always stay on. If disabled (the default setting), the user needs to depress the power button to power up the system.

Power Force On Jumper Settings (JP2)	
Jumper Setting	Definition
Closed	Force On
Open	Disabled

SMBus Enable/Disable

Jumpers JPCISMB1 and JPXISMB1 allow you to enable or disable the System Management Bus. See the table on the right for jumper settings.

SMBus Enable/Disable Jumper Settings	
Jumper Setting	Definition
Pins 1-2	Enabled
Pins 2-3	Disabled

2-8 Onboard Indicators

LAN1/LAN2 LEDs

The Ethernet ports (located beside the VGA port) have two LEDs. On each Gb LAN port, one LED indicates activity when blinking while the other LED may be green, amber or off to indicate the speed of the connection. See the table on the right for the functions associated with the connection speed LED.

LAN LED (Connection Speed Indicator)	
LED Color	Definition
Off	10 MHz
Green	100 MHz
Amber	1 GHz

SATA Activity LEDs

When illuminated, the DP1, DP2, DP3 and DP4 LEDs indicate activity on SATA channels SATA3, SATA2, SATA1 and SATA0, respectively

SATA Activity LEDs (DP1-DP3)	
State	System Status
On	SATA channel active
Off	SATA channel inactive

2-9 Floppy, IDE and SATA Drive Connections

Use the following information to connect the floppy and hard disk drive cables.

- The floppy disk drive cable has seven twisted wires.
- A red mark on a wire typically designates the location of pin 1.
- A single floppy disk drive ribbon cable has 34 wires and two connectors to provide for two floppy disk drives. The connector with twisted wires always connects to drive A, and the connector that does not have twisted wires always connects to drive B.

Floppy Connector

The floppy connector is located beside the IDE#1 connector. See the table on the right for pin definitions.

Floppy Drive Connector Pin Definitions (Floppy)			
Pin#	Definition	Pin #	Definition
1	GND	2	FDHDIN
3	GND	4	Reserved
5	Key	6	FDEDIN
7	GND	8	Index-
9	GND	10	Motor Enable
11	GND	12	Drive Select B-
13	GND	14	Drive Select A-
15	GND	16	Motor Enable
17	GND	18	DIR-
19	GND	20	STEP-
21	GND	22	Write Data-
23	GND	24	Write Gate-
25	GND	26	Track 00-
27	GND	28	Write Protect-
29	GND	30	Read Data-
31	GND	32	Side 1 Select-
33	GND	34	Diskette

IDE Connectors

There are no jumpers to configure the onboard IDE#1 connector. See the table on the right for pin definitions.

IDE Drive Connectors Pin Definitions (IDE#1)			
Pin#	Definition	Pin #	Definition
1	Reset IDE	2	Ground
3	Host Data 7	4	Host Data 8
5	Host Data 6	6	Host Data 9
7	Host Data 5	8	Host Data 10
9	Host Data 4	10	Host Data 11
11	Host Data 3	12	Host Data 12
13	Host Data 2	14	Host Data 13
15	Host Data 1	16	Host Data 14
17	Host Data 0	18	Host Data 15
19	Ground	20	Key
21	DRQ3	22	Ground
23	I/O Write	24	Ground
25	I/O Read	26	Ground
27	IOCHRDY	28	BALE
29	DACK3	30	Ground
31	IRQ14	32	IOCS16
33	Addr1	34	Ground
35	Addr0	36	Addr2
37	Chip Select 0	38	Chip Select 1
39	Activity	40	Ground

SATA Ports

There are no jumpers to configure the SATA ports, which are designated SATA0, SATA1, SATA2 and SATA3. See the table on the right for pin definitions.

SATA Drive Ports Pin Definitions (SATA0-SATA3)	
Pin #	Definition
1	Ground
2	TXP
3	TXN
4	Ground
5	RXN
6	RXP
7	Ground

Chapter 3

Troubleshooting

3-1 Troubleshooting Procedures

Use the following procedures to troubleshoot your system. If you have followed all of the procedures below and still need assistance, refer to the 'Technical Support Procedures' and/or 'Returning Merchandise for Service' section(s) in this chapter. Always disconnect the AC power cord before adding, changing or installing any hardware components.

Before Power On

1. Make sure that the 4-pin power connector at PW2 is connected to your power supply.
2. Make sure that no short circuits exist between the motherboard and chassis.
3. Disconnect all ribbon/wire cables from the motherboard, including those for the keyboard and mouse.
4. Remove all add-on cards.
5. Install a CPU and heatsink (making sure it is fully seated) and connect the chassis speaker and the power LED to the motherboard. Check all jumper settings as well.
6. Use the correct type of onboard CMOS battery as recommended by the manufacturer. To avoid possible explosion, do not install the CMOS battery upside down.

No Power

1. Make sure that no short circuits exist between the motherboard and the chassis.
2. Verify that all jumpers are set to their default positions.
3. Check that the 115V/230V switch on the power supply is properly set.
4. Turn the power switch on and off to test the system.
5. The battery on your motherboard may be old. Check to verify that it still supplies ~3VDC. If it does not, replace it with a new one.

No Video

1. If the power is on but you have no video, remove all the add-on cards and cables.
2. Use the speaker to determine if any beep codes exist. Refer to Appendix A for details on beep codes.

NOTE

If you are a system integrator, VAR or OEM, a POST diagnostics card is recommended. For I/O port 80h codes, refer to App. B.

Memory Errors

1. Make sure that the DIMM modules are properly and fully installed.
2. You should be using unbuffered ECC DDR memory (see next page). Also, it is recommended that you use the same memory type and speed for all DIMMs in the system. See Section 2-4 for memory details and limitations.
3. Check for bad DIMM modules or slots by swapping modules between slots and noting the results.
4. Check the power supply voltage 115V/230V switch.

Losing the System's Setup Configuration

1. Make sure that you are using a high quality power supply. A poor quality power supply may cause the system to lose the CMOS setup information. Refer to Section 1-6 for details on recommended power supplies.
2. The battery on your motherboard may be old. Check to verify that it still supplies ~3VDC. If it does not, replace it with a new one.
3. If the above steps do not fix the setup configuration problem, contact your vendor for repairs.

3-2 Technical Support Procedures

Before contacting Technical Support, please take the following steps. Also, note that as a server and motherboard manufacturer, we do not sell directly to end-users, so it is best to first check with your distributor or reseller for troubleshooting services. They should know of any possible problem(s) with the specific system configuration that was sold to you.

1. Please review the 'Troubleshooting Procedures' and 'Frequently Asked Questions' (FAQs) sections in this chapter or see the FAQs on our web site before contacting Technical Support.
2. BIOS upgrades can be downloaded from our web site.

Note: Not all BIOS can be flashed depending on the modifications to the boot block code.

3. If you still cannot resolve the problem, include the following information when contacting us for technical support:

- Motherboard model and PCB revision number
- BIOS release date/version (this can be seen on the initial display when your system first boots up)
- System configuration

An example of a Technical Support form is posted on our web site.

4. Distributors: For immediate assistance, please have your account number ready when contacting our technical support department by e-mail.

3-3 Frequently Asked Questions

Question: What type of memory does my motherboard support?

Answer: The H8SSL-i supports up to 4 GB of unbuffered ECC DDR400/333 interleaved or non-interleaved SDRAM. See Section 2-4 for details on installing memory.

Question: How do I update my BIOS?

Answer: It is recommended that you **not** upgrade your BIOS if you are not experiencing problems with your system. Updated BIOS files are located on our web site. Please check our BIOS warning message and the information on how to update your BIOS on our web site. Also, check the current BIOS revision and make sure it is newer than your current BIOS before downloading.

Select your mainboard model on the web page and download the corresponding BIOS file to your computer. Unzip the BIOS update file, in which you will find the readme.txt (flash instructions), the afudos.exe (BIOS flash utility) and the BIOS image (xxx.rom) files. Copy these files to a bootable floppy disk, insert the disk into drive A and reboot the system. At the DOS prompt after rebooting, enter the command "flash" (without quotation marks) then type in the BIOS file that you want to update with (xxxx.rom).

Question: What's on the CD that came with my motherboard?

Answer: The supplied compact disc has quite a few drivers and programs that will greatly enhance your system. We recommend that you review the CD and install the applications you need. Applications on the CD include chipset drivers for Windows and security and audio drivers.

Question: Why can't I turn off the power using the momentary power on/off switch?

Answer: The instant power off function is controlled in BIOS by the Power Button Mode setting. When the On/Off feature is enabled, the serverboard will have instant off capabilities as long as the BIOS has control of the system. When the Standby or Suspend feature is enabled or when the BIOS is not in control such as during memory count (the first screen that appears when the system is turned on), the momentary on/off switch must be held for more than four seconds to shut down the system. This feature is required to implement the ACPI features on the motherboard.

Also, check that the Power Force On jumper (JP2) has been disabled on the motherboard. If enabled, you cannot remove system power by depressing the on/off switch.

3-4 Returning Merchandise for Service

A receipt or copy of your invoice marked with the date of purchase is required before any warranty service will be rendered. You can obtain service by calling your vendor for a Returned Merchandise Authorization (RMA) number. When returning to the manufacturer, the RMA number should be prominently displayed on the outside of the shipping carton, and mailed prepaid or hand-carried. Shipping and handling charges will be applied for all orders that must be mailed when service is complete.

For faster service, RMA authorizations may be requested online (<http://www.supermicro.com/support/rma/>).

This warranty only covers normal consumer use and does not cover damages incurred in shipping or from failure due to the alteration, misuse, abuse or improper maintenance of products.

During the warranty period, contact your distributor first for any product problems.

Chapter 4

BIOS

4-1 Introduction

This chapter describes the AMIBIOS™ Setup utility for the H8SSL-i. The AMI ROM BIOS is stored in a flash chip and can be easily upgraded using a floppy disk-based program.

Note: Due to periodic changes to the BIOS, some settings may have been added or deleted and might not yet be recorded in this manual. Please refer to the Manual Download area of our web site for any changes to BIOS that may not be reflected in this manual.

Starting the Setup Utility

To enter the BIOS Setup Utility, hit the <Delete> key while the system is booting-up. (In most cases, the <Delete> key is used to invoke the BIOS setup screen. There are a few cases when other keys are used, such as <F1>, <F2>, etc.) Each main BIOS menu option is described in this manual.

The Main BIOS screen has two main frames. The left frame displays all the options that can be configured. “Grayed-out” options cannot be configured. The right frame displays the key legend. Above the key legend is an area reserved for a text message. When an option is selected in the left frame, it is highlighted in white. Often a text message will accompany it. (Note that BIOS has default text messages built in. We retain the option to include, omit, or change any of these text messages.) Settings printed in **Bold** are the default values.

A " ►" indicates a submenu. Highlighting such an item and pressing the <Enter> key will open the list of settings within that submenu.

The BIOS setup utility uses a key-based navigation system called hot keys. Most of these hot keys (<F1>, <F10>, <Enter>, <ESC>, <Arrow> keys, etc.) can be used at any time during the setup navigation process.

4-2 Main Menu

When you first enter AMI BIOS Setup Utility, you will see the Main setup screen. You can always return to the Main setup screen by selecting the **Main** tab on the top of the screen.

The Main Setup screen provides you with a system overview, which includes the version, built date and ID of the AMIBIOS, the type, speed and number of the processors in the system and the amount of memory installed in the system.

System Time/System Date

You can edit this field to change the system time and date. Highlight *System Time* or *System Date* using the <Arrow> keys. Enter new values through the keyboard. Press the <Tab> key or the <Arrow> keys to move between fields. The date must be entered in DAY/MM/DD/YYYY format. The time is entered in HH:MM:SS format. Please note that time is in a 24-hour format. For example, 5:30 A.M. appears as 05:30:00 and 5:30 P.M. as 17:30:00.

4-3 Advanced Settings Menu

► CPU Configuration Sub-Menu

GART Error Reporting

This setting is used for testing only.

MTRR Mapping

This determines the method used for programming CPU MTRRs when 4 GB or more memory is present. The options are **Continuous**, which makes the PCI hole non-cacheable, and **Discrete**, which places the PCI hole below the 4 GB boundary.

► Floppy Configuration

Floppy A

Move the cursor to these fields via up and down <arrow> keys to select the floppy type. The options are Disabled, 360 KB 5 1/4", 1.2 MB 5 1/4", 720 KB 3 1/2", **1.44 MB 3 1/2"**, and 2.88 MB 3 1/2".

Floppy B

Move the cursor to these fields via up and down <arrow> keys to select the floppy type. The options are **Disabled**, 360 KB 5 1/4", 1.2 MB 5 1/4", 720 KB 3 1/2", 1.44 MB 3 1/2", and 2.88 MB 3 1/2".

► IDE Configuration

Onboard PCI IDE Controller

The following options are available to set the IDE controller status: Disabled will disable the controller. **Primary** will enable the primary IDE controller. There is no Secondary option since only one IDE slot is provided on the board.

Primary IDE Master/Slave

Highlight one of the two items above and press <Enter> to access the submenu for that item.

Type

Select the type of device connected to the system. The options are Not Installed, **Auto**, CDROM and ARMD.

LBA/Large Mode

LBA (Logical Block Addressing) is a method of addressing data on a disk drive. In the LBA mode, the maximum drive capacity is 137 GB. For drive capacities of over 137 GB, your system must be equipped with 48-bit LBA mode addressing. If not, contact your manufacturer or install an ATA/133 IDE controller card that supports 48-bit LBA mode. The options are Disabled and **Auto**.

Block (Multi-Sector Transfer)

Block mode boosts IDE drive performance by increasing the amount of data transferred. Only 512 bytes of data can be transferred per interrupt if block mode is not used. Block mode allows transfers of up to 64 KB per interrupt. Select "Disabled" to allow the data to be transferred from and to the device one sector at a time. Select "Auto" to allows the data transfer from and to the device occur multiple sectors at a time if the device supports it. The options are **Auto** and Disabled.

PIO Mode

PIO (Programmable I/O) mode programs timing cycles between the IDE drive and the programmable IDE controller. As the PIO mode increases, the cycle time decreases. The options are **Auto**, 0, 1, 2, 3, and 4. Select Auto to allow AMI BIOS to auto detect the PIO mode. Use this value if the IDE disk drive support cannot be determined. Select 0 to allow AMI BIOS to use PIO mode 0. It has a data transfer rate of 3.3 MBs. Select 1 to allow AMI BIOS to use PIO mode 1. It has a data transfer rate of 5.2 MBs. Select 2 to allow AMI BIOS to use PIO mode 2. It has a data transfer rate of 8.3 MBs. Select 3 to allow AMI BIOS to use PIO mode 3. It has a data transfer rate of 11.1 MBs. Select 4 to allow AMI BIOS to use PIO mode 4. It has a data transfer rate of 16.6 MBs. This setting generally works with all hard disk drives manufactured after 1999. For other disk drives, such as IDE CD-ROM drives, check the specifications of the drive.

DMA Mode

Select the DMA mode of the drive. Options are SWDMA0, SWDMA1, SWDMA2, MWDMA0, MWDMA1, MWDMA2, UDMA0, UDMA1 and UDMA2.

S.M.A.R.T.

Self-Monitoring Analysis and Reporting Technology (SMART) can help predict impending drive failures. Select "Auto" to allow BIOS to auto detect hard disk drive support. Select "Disabled" to prevent AMI BIOS from using the S.M.A.R.T. Select "Enabled" to allow AMI BIOS to use the S.M.A.R.T. to support hard drive disk. The options are Disabled, Enabled, and **Auto**.

32-Bit Data Transfer

Select "Enabled" to activate the function of 32-Bit data transfer. Select "Disabled" to deactivate the function. The options are Enabled and **Disabled**.

Hard Disk Write Protect

Select Enabled to enable the function of Hard Disk Write Protect to prevent data from being written to HDD. The options are Enabled or **Disabled**.

IDE Detect Time Out (Sec)

This feature allows the user to set the time-out value for detecting ATA, ATA PI devices installed in the system. The options are 0 (sec), 5, 10, 15, 20, 25, 30 and **35**.

ATA(PI) 80Pin Cable Detection

This setting allows AMI BIOS to auto-detect the 80-Pin ATA(PI) cable. The options are **Host & Device**, Host and Device.

► PCI/PnP

Clear NVRAM

Select Yes to clear NVRAM during boot-up. The options are Yes and **No**.

Plug & Play OS

Select Yes to allow the OS to configure Plug & Play devices. (This is not required for system boot if your system has an OS that supports Plug & Play.) Select **No** to allow AMIBIOS to configure all devices in the system.

PCI Latency Timer

This option sets the latency of all PCI devices on the PCI bus. Select a value to set the PCI latency in PCI clock cycles. Options are 32, **64**, 96, 128, 160, 192, 224 and 248.

Allocate IRQ to PCI VGA

Set this value to allow or restrict the system from giving the VGA adapter card an interrupt address. The options are **Yes** and No.

Palette Snooping

Select "Enabled" to inform the PCI devices that an ISA graphics device is installed in the system in order for the graphics card to function properly. The options are Enabled and **Disabled**.

PCI IDE BusMaster

Set this value to allow or prevent the use of PCI IDE busmastering. Select "Enabled" to allow AMI BIOS to use PCI busmaster for reading and writing to IDE drives. The options are **Disabled** and Enabled.

Offboard PCI/ISA IDE Card

This option allows the user to assign a PCI slot number to an Off-board PCI/ISA IDE card in order for it to function properly. The options are **Auto**, PCI Slot1, PCI Slot2, PCI Slot3, PCI Slot4, PCI Slot5, and PCI Slot6.

IRQ3/IRQ4/IRQ5/IRQ7/IRQ9/IRQ10/IRQ11/IRQ14/IRQ15

This feature specifies the availability of an IRQ to be used by a PCI/PnP device. Select Reserved for the IRQ to be used by a Legacy ISA device. The options are **Available** and Reserved.

DMA Channel0/Channel1/Channel3/Channel5/Channel6/Channel7

Select Available to indicate that a specific DMA channel is available to be used by a PCI/PnP device. Select Reserved if the DMA channel specified is reserved for a Legacy ISA device. The options are **Available** and Reserved.

Reserved Memory Size

This feature specifies the size of memory block to be reserved for Legacy ISA devices. The options are **Disabled**, 16K, 32K and 64K.

► Super IO Configuration

Onboard Floppy Controller

Use this setting to **Enable** or Disable the onboard floppy controller.

Serial Port1 Address

This option specifies the base I/O port address and Interrupt Request address of serial port 1. Select "Disabled" to prevent the serial port from accessing any system resources. When this option is set to *Disabled*, the serial port physically becomes unavailable. Select "3F8/IRQ4" to allow the serial port to use 3F8 as its I/O port address and IRQ 4 for the interrupt address. The options are Disabled, **3F8/IRQ4**, 3E8/IRQ4 and 2E8/IRQ3.

Serial Port2 Address

This option specifies the base I/O port address and Interrupt Request address of serial port 2. Select "Disabled" to prevent the serial port from accessing any system resources. When this option is set to "Disabled", the serial port physically becomes unavailable. Select "2F8/IRQ3" to allow the serial port to use 2F8 as its I/O port address and IRQ 3 for the interrupt address. The options are Disabled, **2F8/IRQ3**, 3E8/IRQ4 and 2E8/IRQ3.

Serial Port 2 Mode

Tells BIOS which mode to select for serial port 2. The options are **Normal**, Sharp-IR, SIR and Consumer.

Restore on AC Power Loss

This setting allows you to choose how the system will react when power returns after an unexpected loss of power. The options are Power Off and **Last State**.

Watch Dog Timer

This setting is used to enable or disabled the Watch Dog Timer function. It must be used in conjunction with the Watch Dog jumper (see Chapter 2). Options are **Disabled** and Enabled.

▶ **Advanced Chipset Control**

NorthBridge Configuration

▶ **Memory Configuration**

Memclock Mode

This setting determines how the memory clock is set. **Auto** has the memory clock set by the code and Limit allows the user to set a standard value.

MCT Timing Mode

Sets the timing mode for memory. Options are **Auto** and Manual.

User Configuration Mode

Options are **Auto** and Manual.

Bank Interleaving

This setting is used to determine whether bank interleaving is to be employed. The options are **Auto** and Disabled.

Burst Length

Use this setting to set the memory burst length. 64-bit Dq must use 4 beats. Options are 8 beats, **4 beats** and 2 beats.

Enable Clock to All DIMMs

This setting allows the user to enable unused clocks to DIMMs, even if DIMM slots are empty. Options are Enabled and **Disabled**.

Hardware Memory Hole

When "Enabled", allows software memory remapping around the memory hole (only supported by rev. E0 processors and above). Options are Enabled and **Disabled**.

► ECC Configuration

DRAM ECC Enable

DRAM ECC allows hardware to report and correct memory errors automatically. Options are **Enabled** and Disabled.

MCA DRAM ECC Logging

When "Enabled", MCA DRAM ECC logging and reporting is enabled. Options are Enabled and **Disabled**.

ECC Chip Kill

Allows the user to Enable or **Disable** ECC Chip Kill.

DRAM Scrub Redirect

Allows system to correct DRAM ECC errors immediately, even with background scrubbing on. Options are Enabled and **Disabled**.

DRAM BG Scrub

Corrects memory errors so later reads are correct. Options are **Disabled** and various times in nanoseconds and microseconds.

L2 Cache BG Scrub

Allows L2 cache RAM to be corrected when idle. Options are **Disabled** and various times in nanoseconds and microseconds.

Data Cache BG Scrub

Allows L1 cache RAM to be corrected when idle. Options are **Disabled** and various times in nanoseconds and microseconds.

▶ **HT1000 SouthBridge Configuration**

HIDE XIOAPIC PCI Functions

The options are **Yes** and **No**.

▶ **S-ATA Configuration**

HT-1000 S-ATA

Use this setting to **Enable** or Disable the on-chip SATA controller.

Port# to Boot From

Use this setting to select which port to boot from. Options are **Port0**, Port1, Port2 and Port3.

S-ATA Mode

Use this select either **IDE** or MMIO as the SATA mode.

Banner Display

This setting is used to **Enable** or Disable the banner display.

INT13 Support

This setting is used to **Enable** or Disable the INT13 function.

▶ **ACPI Configuration**

▶ **Advanced ACPI Configuration**

ACPI Version Features

Select which version of ACPI you wish to use. Options are **ACPI v. 1.0**, ACPI v. 2.0 and ACPI v. 3.0.

ACPI APIC Support

Select "Enabled" to allow the ACPI APIC Table Pointer to be included in the RSDT pointer list. The options are **Enabled** and Disabled.

ACPI OEMB Table

This setting when enabled will include an OEMB table pointer to pointer lists. Options are **Enabled** and Disabled.

Headless Mode

Select "Enabled" to activate the Headless Operation Mode through ACPI. The options are Enabled and **Disabled**.

▶ **Event Log Configuration**

View Event Log

Highlight this item and press <Enter> to view the contents of the event log.

Mark All Events as Read

Highlight this item and press <Enter> to mark the DMI events as read.

Clear Event Log

This setting will clear all event logs when set to "OK". The options are OK and **Cancel**.

Event Log Statistics

Highlight this item and press <Enter> to view details on the count of total unread events.

▶ **MPS Configuration**

MPS Revision

This setting allows the user to select the MPS revision level. The options are 1.1 and 1.4.

▶ **Remote Access Configuration**

Remote Access

Use this setting to Enable or **Disable** remote access. If Enabled is selected, you can select a Remote Access type.

▶ **USB Configuration**

This screen will display the module version and all USB enabled devices.

Legacy USB Support

Select "Enabled" to enable the support for USB Legacy. Disable Legacy support if there are no USB devices installed in the system. The options are **Enabled** and Disabled.

USB 2.0 Controller Mode

Select the controller mode for your USB ports. Options are HiSpeed and **FullSpeed**. (HiSpeed=480 Mbps, FullSpeed=12 Mbps).

BIOS EHCI Hand-Off

Enable or Disable a workaround for OS's without EHCI hand-off support.

▶ **System Health Monitor**

CPU Overheat Temperature

Use the "+" and "-" keys to set the CPU temperature threshold to between 65° and 90° C. When this threshold is exceeded, the overheat LED on the chassis will light up and an alarm will sound. The LED and alarm will turn off once the CPU temperature has dropped to 5 degrees below the threshold set. The default setting is **78° C**.

The other items in the submenu are all systems monitor displays for the following information:

System Temperature, CPU1 Vcore, +5 Vin, +12Vin, -12V Vcc, DRAM VTT, 1.2V for Hyper-Transport, 5V standby, 2.5V standby and battery voltage.

▶ **System Fan Monitor**

Fan Speed Control Modes

This feature allows the user to determine how the system will control the speed of the onboard fans. If the option is set to "3-pin fan", the fan speed is controlled based upon the CPU die temperature. When the CPU die temperature is higher, the fan speed will be higher as well. If the option is set to "4-pin", the fan speed will be controlled by the Thermal Management Settings pre-configured by the user with this setting. Select "3-pin" if your chassis came with 3-pin fan headers. Select "4-pin" if your chassis came with 4-pin fan headers. Select "Workstation" if your system is used as a Workstation. Select "Server" if your system is used as a Server. Select "Disable" to disable the fan speed control function to allow

the onboard fans to continuously run at full speed (12V). The options are **1) Disable, Full Speed** 2) 3-pin (Server) and 3) 3-pin (Workstation).

FAN1 Speed through FAN5 Speed

The speeds of the onboard fans (in rpm) are displayed here.

4-4 Boot Menu

► Boot Settings Configuration

Quick Boot

If Enabled, this option will skip certain tests during POST to reduce the time needed for the system to boot up. The options are **Enabled** and Disabled.

Quiet Boot

If **Disabled**, normal POST messages will be displayed on boot-up. If Enabled, this display the OEM logo instead of POST messages.

Add-On ROM Display Mode

This setting controls the display of add-on ROM (read-only memory) messages. Select "**Force BIOS**" to allow the computer system to force a third party BIOS to display during system boot. Select "Keep Current" to allow the computer system to display the BIOS information during system boot.

Boot up Num-Lock

Set this to "On" to allow the Number Lock setting to be modified during boot up. The options are **On** and Off.

PS/2 Mouse Support

This setting is to specify PS/2 mouse support. The options are **Auto**, Enabled and Disabled.

Wait for 'F1' If Error

Enable to activate the Wait for F1 if Error function. The options are **Enabled** and Disabled.

Hit 'DEL' Message Display

Enable to display the message telling the user to hit the DEL key to enter the setup utility. The options are **Enabled** and Disabled.

PXE Option ROM

Use this setting to either Enable or Disable the PXE ROM. The options are **Enabled** and Disabled.

Interrupt 19 Capture

Enable to allow ROMs to trap Interrupt 19. The options are Enabled and **Disabled**.

► Boot Device Priority

This feature allows the user to prioritize the sequence for the Boot Device with the devices installed in the system. The default settings (with generic names) are:

- 1st Boot Device – Removeable drive (e.g. floppy drive)
- 2nd Boot Device – CD/DVD
- 3rd Boot Device – Hard drive
- 4th Boot Device – LAN

► Hard Disk Drives

This feature allows the user to prioritize the Boot sequence from available hard drives.

1st Drive/2nd Drive/3rd Drive/4th Drive/5th Drive

Specify the boot sequence for the available hard drives on the system.

► Removable Drives

This feature allows the user to specify the Boot sequence from available removable drives.

1st Drive

Specifies the boot sequence for the 1st Removable Drive.

► **CD/DVD Drives**

This feature allows the user to specify the boot sequence from available CDROM drives.

1st Drive

Specifies the boot sequence for the 1st Hard Drive.

Onboard SCSI Host RAID

Use this setting to Enable or **Disable** the onboard SCSI Host RAID.

Onboard NIC PXE Option ROM

Use this setting to **Enable** or Disable the onboard NIC PXE option ROM.

4-5 Security Menu

AMI BIOS provides a Supervisor and a User password. If you use both passwords, the Supervisor password must be set first.

Change Supervisor Password

Select this option and press <Enter> to access the sub menu, and then type in the password.

Change User Password

Select this option and press <Enter> to access the sub menu, and then type in the password.

Boot Sector Virus Protection

This option is near the bottom of the Security Setup screen. Select "Disabled" to deactivate the Boot Sector Virus Protection. Select "Enabled" to enable boot sector protection. When "Enabled", AMI BIOS displays a warning when any program (or virus) issues a Disk Format command or attempts to write to the boot sector of the hard disk drive. The options are Enabled and **Disabled**.

4-6 Exit Menu

Select the Exit tab from AMI BIOS Setup Utility screen to enter the Exit BIOS Setup screen.

Save Changes and Exit

When you have completed the system configuration changes, select this option to leave BIOS Setup and reboot the computer, so the new system configuration parameters can take effect. Select Save Changes and Exit from the Exit menu and press <Enter>.

Discard Changes and Exit

Select this option to quit BIOS Setup without making any permanent changes to the system configuration and reboot the computer. Select Discard Changes and Exit from the Exit menu and press <Enter>.

Discard Changes

Select this option and press <Enter> to discard all the changes and return to AMI BIOS Utility Program.

Load Optimal Defaults

To set this feature, select Load Optimal Defaults from the Exit menu and press <Enter>. Then Select "OK" to allow BIOS to automatically load the Optimal Defaults as the BIOS Settings. The Optimal settings are designed for maximum system performance, but may not work best for all computer applications.

Load Fail-Safe Defaults

To set this feature, select Load Fail-Safe Defaults from the Exit menu and press <Enter>. The Fail-Safe settings are designed for maximum system stability, but not maximum performance.

Notes

Appendix A

BIOS Error Beep Codes

During the POST (Power-On Self-Test) routines, which are performed each time the system is powered on, errors may occur.

Non-fatal errors are those which, in most cases, allow the system to continue the boot-up process. The error messages normally appear on the screen.

Fatal errors are those which will not allow the system to continue the boot-up procedure. If a fatal error occurs, you should consult with your system manufacturer for possible repairs.

These fatal errors are usually communicated through a series of audible beeps. The numbers on the fatal error list, on the following page, correspond to the number of beeps for the corresponding error. All errors listed, with the exception of Beep Code 8, are fatal errors.

POST codes may be read on the LEDs located beside the LAN port on the serverboard backplane. See the description of the POST code LEDs in Chapter 5.

A-1 AMIBIOS Error Beep Codes

Beep Code	Error Message	Description
1 beep	Refresh	Circuits have been reset. (Ready to power up.)
5 short, 1 long	Memory error	No memory detected in system
1 long, 8 short	Video error	Video adapter disabled or missing

Notes

Appendix B

BIOS POST Checkpoint Codes

When AMIBIOS performs the Power On Self Test, it writes checkpoint codes to I/O port 0080h. If the computer cannot complete the boot process, diagnostic equipment can be attached to the computer to read I/O port 0080h.

B-1 Uncompressed Initialization Codes

The uncompressed initialization checkpoint codes are listed in order of execution:

Checkpoint	Code Description
D0h	The NMI is disabled. Power on delay is starting. Next, the initialization code checksum will be verified.
D1h	Initializing the DMA controller, performing the keyboard controller BAT test, starting memory refresh and entering 4 GB flat mode next.
D3h	Starting memory sizing next.
D4h	Returning to real mode. Executing any OEM patches and setting the Stack next.
D5h	Passing control to the uncompressed code in shadow RAM at E000:0000h. The initialization code is copied to segment 0 and control will be transferred to segment 0.

B-2 Bootblock Recovery Codes

The bootblock recovery checkpoint codes are listed in order of execution:

Checkpoint	Code Description
E0h	The onboard floppy controller if available is initialized. Next, beginning the base 512 KB memory test.
E1h	Initializing the interrupt vector table next.
E2h	Initializing the DMA and Interrupt controllers next.
E6h	Enabling the floppy drive controller and Timer IRQs. Enabling internal cache memory.
Edh	Initializing the floppy drive.
Eeh	Looking for a floppy diskette in drive A:. Reading the first sector of the diskette.
Efh	A read error occurred while reading the floppy drive in drive A:.
F0h	Next, searching for the AMIBOOT.ROM file in the root directory.
F1h	The AMIBOOT.ROM file is not in the root directory.
F2h	Next, reading and analyzing the floppy diskette FAT to find the clusters occupied by the AMIBOOT.ROM file.
F3h	Next, reading the AMIBOOT.ROM file, cluster by cluster.
F4h	The AMIBOOT.ROM file is not the correct size.
F5h	Next, disabling internal cache memory.
FBh	Next, detecting the type of flash ROM.
FCh	Next, erasing the flash ROM.
FDh	Next, programming the flash ROM.
FFh	Flash ROM programming was successful. Next, restarting the system BIOS.

B-3 Uncompressed Initialization Codes

The following runtime checkpoint codes are listed in order of execution.

These codes are uncompressed in F0000h shadow RAM.

Checkpoint	Code Description
03h	The NMI is disabled. Next, checking for a soft reset or a power on condition.
05h	The BIOS stack has been built. Next, disabling cache memory.
06h	Uncompressing the POST code next.
07h	Next, initializing the CPU and the CPU data area.
08h	The CMOS checksum calculation is done next.
0Ah	The CMOS checksum calculation is done. Initializing the CMOS status register for date and time next.
0Bh	The CMOS status register is initialized. Next, performing any required initialization before the keyboard BAT command is issued.
0Ch	The keyboard controller input buffer is free. Next, issuing the BAT command to the keyboard controller.
0Eh	The keyboard controller BAT command result has been verified. Next, performing any necessary initialization after the keyboard controller BAT command test.
0Fh	The initialization after the keyboard controller BAT command test is done. The keyboard command byte is written next.
10h	The keyboard controller command byte is written. Next, issuing the Pin 23 and 24 blocking and unblocking command.
11h	Next, checking if <End or <Ins> keys were pressed during power on. Initializing CMOS RAM if the Initialize CMOS RAM in every boot AMIBIOS POST option was set in AMIBCP or the <End> key was pressed.
12h	Next, disabling DMA controllers 1 and 2 and interrupt controllers 1 and 2.
13h	The video display has been disabled. Port B has been initialized. Next, initializing the chipset.
14h	The 8254 timer test will begin next.
19h	Next, programming the flash ROM.
1Ah	The memory refresh line is toggling. Checking the 15 second on/off time next.
2Bh	Passing control to the video ROM to perform any required configuration before the video ROM test.
2Ch	All necessary processing before passing control to the video ROM is done. Looking for the video ROM next and passing control to it.
2Dh	The video ROM has returned control to BIOS POST. Performing any required processing after the video ROM had control
23h	Reading the 8042 input port and disabling the MEGAKEY Green PC feature next. Making the BIOS code segment writable and performing any necessary configuration before initializing the interrupt vectors.
24h	The configuration required before interrupt vector initialization has completed. Interrupt vector initialization is about to begin.

Checkpoint	Code Description
25h	Interrupt vector initialization is done. Clearing the password if the POST DIAG switch is on.
27h	Any initialization before setting video mode will be done next.
28h	Initialization before setting the video mode is complete. Configuring the monochrome mode and color mode settings next.
2Ah	Bus initialization system, static, output devices will be done next, if present. See the last page for additional information.
2Eh	Completed post-video ROM test processing. If the EGA/VGA controller is not found, performing the display memory read/write test next.
2Fh	The EGA/VGA controller was not found. The display memory read/write test is about to begin.
30h	The display memory read/write test passed. Look for retrace checking next.
31h	The display memory read/write test or retrace checking failed. Performing the alternate display memory read/write test next.
32h	The alternate display memory read/write test passed. Looking for alternate display retrace checking next.
34h	Video display checking is over. Setting the display mode next.
37h	The display mode is set. Displaying the power on message next.
38h	Initializing the bus input, IPL, general devices next, if present. See the last page of this chapter for additional information.
39h	Displaying bus initialization error messages. See the last page of this chapter for additional information.
3Ah	The new cursor position has been read and saved. Displaying the Hit message next.
3Bh	The Hit message is displayed. The protected mode memory test is about to start.
40h	Preparing the descriptor tables next.
42h	The descriptor tables are prepared. Entering protected mode for the memory test next.
43h	Entered protected mode. Enabling interrupts for diagnostics mode next.
44h	Interrupts enabled if the diagnostics switch is on. Initializing data to check memory wraparound at 0:0 next.
45h	Data initialized. Checking for memory wraparound at 0:0 and finding the total system memory size next.
46h	The memory wraparound test is done. Memory size calculation has been done. Writing patterns to test memory next.
47h	The memory pattern has been written to extended memory. Writing patterns to the base 640 KB memory next.
48h	Patterns written in base memory. Determining the amount of memory below 1 MB next.
49h	The amount of memory below 1 MB has been found and verified.
4Bh	The amount of memory above 1 MB has been found and verified. Checking for a soft reset and clearing the memory below 1 MB for the soft reset next. If this is a power on situation, going to checkpoint 4Eh next.

Checkpoint	Code Description
4Ch	The memory below 1 MB has been cleared via a soft reset. Clearing the memory above 1 MB next.
4Dh	The memory above 1 MB has been cleared via a soft reset. Saving the memory size next. Going to checkpoint 52h next.
4Eh	The memory test started, but not as the result of a soft reset. Displaying the first 64 KB memory size next.
4Fh	The memory size display has started. The display is updated during the memory test. Performing the sequential and random memory test next.
50h	The memory below 1 MB has been tested and initialized. Adjusting the displayed memory size for relocation and shadowing next.
51h	The memory size display was adjusted for relocation and shadowing.
52h	The memory above 1 MB has been tested and initialized. Saving the memory size information next.
53h	The memory size information and the CPU registers are saved. Entering real mode next.
54h	Shutdown was successful. The CPU is in real mode. Disabling the Gate A20 line, parity, and the NMI next.
57h	The A20 address line, parity, and the NMI are disabled. Adjusting the memory size depending on relocation and shadowing next.
58h	The memory size was adjusted for relocation and shadowing. Clearing the Hit message next.
59h	The Hit message is cleared. The <WAIT...> message is displayed. Starting the DMA and interrupt controller test next.
60h	The DMA page register test passed. Performing the DMA Controller 1 base register test next.
62h	The DMA controller 1 base register test passed. Performing the DMA controller 2 base register test next.
65h	The DMA controller 2 base register test passed. Programming DMA controllers 1 and 2 next.
66h	Completed programming DMA controllers 1 and 2. Initializing the 8259 interrupt controller next.
67h	Completed 8259 interrupt controller initialization.
7Fh	Extended NMI source enabling is in progress.
80h	The keyboard test has started. Clearing the output buffer and checking for stuck keys. Issuing the keyboard reset command next.
81h	A keyboard reset error or stuck key was found. Issuing the keyboard controller interface test command next.
82h	The keyboard controller interface test completed. Writing the command byte and initializing the circular buffer next.
83h	The command byte was written and global data initialization has completed. Checking for a locked key next.
84h	Locked key checking is over. Checking for a memory size mismatch with CMOS RAM data next.
85h	The memory size check is done. Displaying a soft error and checking for a password or bypassing WINBIOS Setup next.

Checkpoint	Code Description
86h	The password was checked. Performing any required programming before WINBIOS Setup next.
87h	The programming before WINBIOS Setup has completed. Uncompressing the WINBIOS Setup code and executing the AMIBIOS Setup or WINBIOS Setup utility next.
88h	Returned from WINBIOS Setup and cleared the screen. Performing any necessary programming after WINBIOS Setup next.
89h	The programming after WINBIOS Setup has completed. Displaying the power on screen message next.
8Ch	Programming the WINBIOS Setup options next.
8Dh	The WINBIOS Setup options are programmed. Resetting the hard disk controller next.
8Fh	The hard disk controller has been reset. Configuring the floppy drive controller next.
91h	The floppy drive controller has been configured. Configuring the hard disk drive controller next.
95h	Initializing the bus option ROMs from C800 next. See the last page of this chapter for additional information.
96h	Initializing before passing control to the adaptor ROM at C800.
97h	Initialization before the C800 adaptor ROM gains control has completed. The adaptor ROM check is next.
98h	The adaptor ROM had control and has now returned control to BIOS POST. Performing any required processing after the option ROM returned control.
99h	Any initialization required after the option ROM test has completed. Configuring the timer data area and printer base address next.
9Ah	Set the timer and printer base addresses. Setting the RS-232 base address next.
9Bh	Returned after setting the RS-232 base address. Performing any required initialization before the Coprocessor test next.
9Ch	Required initialization before the Coprocessor test is over. Initializing the Coprocessor next.
9Dh	Coprocessor initialized. Performing any required initialization after the Coprocessor test next.
9Eh	Initialization after the Coprocessor test is complete. Checking the extended keyboard, keyboard ID, and Num Lock key next. Issuing the keyboard ID command next.
A2h	Displaying any soft errors next.
A3h	The soft error display has completed. Setting the keyboard typematic rate next.
A4h	The keyboard typematic rate is set. Programming the memory wait states next.
A5h	Memory wait state programming is over. Clearing the screen and enabling parity and the NMI next.
A7h	NMI and parity enabled. Performing any initialization required before passing control to the adaptor ROM at E000 next.
A8h	Initialization before passing control to the adaptor ROM at E000h completed. Passing control to the adaptor ROM at E000h next.

Checkpoint	Code Description
A9h	Returned from adaptor ROM at E000h control. Performing any initialization required after the E000 option ROM had control next.
Aah	Initialization after E000 option ROM control has completed. Displaying the system configuration next.
Abh	Uncompressing the DMI data and executing DMI POST initialization next.
B0h	The system configuration is displayed.
B1h	Copying any code to specific areas.
00h	Code copying to specific areas is done. Passing control to INT 19h boot loader next.

Notes