

SUPERO[®]

H8DM3-2

H8DMi-2

USER'S MANUAL

Revision 1.1a

The information in this User's Manual has been carefully reviewed and is believed to be accurate. The vendor assumes no responsibility for any inaccuracies that may be contained in this document, makes no commitment to update or to keep current the information in this manual, or to notify any person or organization of the updates. **Please Note: For the most up-to-date version of this manual, please see our web site at www.supermicro.com.**

Super Micro Computer, Inc. reserves the right to make changes to the product described in this manual at any time and without notice. This product, including software, if any, and documentation may not, in whole or in part, be copied, photocopied, reproduced, translated or reduced to any medium or machine without prior written consent.

IN NO EVENT WILL SUPERMICRO BE LIABLE FOR DIRECT, INDIRECT, SPECIAL, INCIDENTAL, SPECULATIVE OR CONSEQUENTIAL DAMAGES ARISING FROM THE USE OR INABILITY TO USE THIS PRODUCT OR DOCUMENTATION, EVEN IF ADVISED OF THE POSSIBILITY OF SUCH DAMAGES. IN PARTICULAR, SUPERMICRO SHALL NOT HAVE LIABILITY FOR ANY HARDWARE, SOFTWARE, OR DATA STORED OR USED WITH THE PRODUCT, INCLUDING THE COSTS OF REPAIRING, REPLACING, INTEGRATING, INSTALLING OR RECOVERING SUCH HARDWARE, SOFTWARE, OR DATA.

Any disputes arising between manufacturer and customer shall be governed by the laws of Santa Clara County in the State of California, USA. The State of California, County of Santa Clara shall be the exclusive venue for the resolution of any such disputes. Supermicro's total liability for all claims will not exceed the price paid for the hardware product.

FCC Statement: This equipment has been tested and found to comply with the limits for a Class A digital device pursuant to Part 15 of the FCC Rules. These limits are designed to provide reasonable protection against harmful interference when the equipment is operated in a commercial environment. This equipment generates, uses, and can radiate radio frequency energy and, if not installed and used in accordance with the manufacturer's instruction manual, may cause harmful interference with radio communications. Operation of this equipment in a residential area is likely to cause harmful interference, in which case you will be required to correct the interference at your own expense.

California Best Management Practices Regulations for Perchlorate Materials: This Perchlorate warning applies only to products containing CR (Manganese Dioxide) Lithium coin cells. "Perchlorate Material-special handling may apply. See www.dtsc.ca.gov/hazardouswaste/perchlorate"

WARNING: Handling of lead solder materials used in this product may expose you to lead, a chemical known to the State of California to cause birth defects and other reproductive harm.

Manual Revision 1.1a
Release Date: October 9, 2008

Unless you request and receive written permission from Super Micro Computer, Inc., you may not copy any part of this document.

Information in this document is subject to change without notice. Other products and companies referred to herein are trademarks or registered trademarks of their respective companies or mark holders.

Copyright © 2008 by Super Micro Computer, Inc.
All rights reserved.
Printed in the United States of America

Preface

About This Manual

This manual is written for system integrators, PC technicians and knowledgeable PC users. It provides information for the installation and use of the H8DM3-2/H8DMi-2 serverboard. The H8DM3-2/H8DMi-2 is based on the nVidia® MCP55 Pro/AMD-8132 chipset and supports single or dual AMD Opteron™ 2000 Series Socket F type processors and up to 64 GB of DDR2-667 or 32 GB of DDR2-533/400 registered ECC SDRAM.

Please refer to the serverboard specifications pages on our web site for updates on supported processors (<http://www.supermicro.com/aplus/>). This product is intended to be professionally installed.

Manual Organization

Chapter 1 includes a checklist of what should be included in your serverboard box, describes the features, specifications and performance of the serverboard and provides detailed information about the chipset.

Chapter 2 begins with instructions on handling static-sensitive devices. Read this chapter when installing the processor(s) and memory modules and when installing the serverboard in a chassis. Also refer to this chapter to connect the floppy and hard disk drives, the parallel and serial ports, the mouse and keyboard and the twisted wires for the power and reset buttons and the system LEDs.

If you encounter any problems, see **Chapter 3**, which describes troubleshooting procedures for the video, the memory and the setup configuration stored in CMOS. For quick reference, a general FAQ (Frequently Asked Questions) section is provided. Instructions are also included for contacting technical support. In addition, you can visit our web site for more detailed information.

Chapter 4 includes an introduction to BIOS and provides detailed information on running the CMOS Setup utility.

Appendix A provides BIOS Error Beep Code Messages.

Appendix B lists BIOS POST Checkpoint Codes.

Table of Contents

Chapter 1: Introduction

1-1	Overview	1-1
	Checklist	1-1
	Contacting Supermicro	1-2
	H8DM3-2/H8DMi-2 Image	1-3
	H8DM3-2/H8DMi-2 Serverboard Layout	1-4
	H8DM3-2/H8DMi-2 Quick Reference	1-5
	Serverboard Features	1-6
	nVidia nVidia MCP55 Pro Chipset: System Block Diagram	1-7
1-2	Chipset Overview	1-9
1-3	PC Health Monitoring	1-10
1-4	Power Configuration Settings	1-11
1-5	Power Supply	1-12
1-6	Super I/O	1-13

Chapter 2: Installation

2-1	Static-Sensitive Devices	2-1
2-2	Processor and Heatsink Installation	2-2
2-3	Mounting the Serverboard into a Chassis	2-5
2-4	Installing Memory	2-5
2-5	I/O Port and Control Panel Connections	2-8
2-6	Connecting Cables	2-9
	ATX Power Connector	2-9
	Processor Power Connector	2-9
	Auxiliary Power Connector	2-9
	Power LED	2-9
	HDD LED	2-10
	NIC1 LED	2-10
	NIC2 LED	2-10
	Overheat/Fan Fail LED	2-10
	Power Fail LED	2-10
	Reset Button	2-11
	Power Button	2-11
	Universal Serial Bus Ports (USB0/1)	2-11
	USB Headers	2-11
	ATX PS/2 Keyboard/Mouse Ports	2-12

Serial Ports	2-12
Fan Headers	2-12
Power LED/Speaker/Keylock	2-13
Overheat LED	2-13
Chassis Intrusion	2-13
Wake-On-LAN	2-13
Wake-On-Ring	2-14
Power Supply I ² C Header	2-14
LAN1/2 (Ethernet Ports)	2-14
Power Supply Fail Alarm Reset Header	2-14
Power Supply Fail Alarm Header	2-15
Compact Flash Power Header	2-15
SGPIO	2-15
2-7 Jumper Settings	2-16
Explanation of Jumpers	2-16
CMOS Clear	2-16
I ² C to PCI-X Enable/Disable	2-17
I ² C to PCI-E Enable/Disable	2-17
Watch Dog Enable/Disable	2-17
VGA Enable/Disable	2-17
PCI-X Slot Speed	2-18
Compact Flash Master/Slave	2-18
3rd Power Supply Fail Signal Enable/Disable	2-18
SAS RAID Select	2-18
2-8 Onboard Indicators	2-19
LAN1/LAN2 LEDs	2-19
+5V LED	2-19
2-9 Floppy, IDE, SATA and SAS Drive Connections	2-20
Floppy Connector	2-20
IDE Connector	2-21
SATA Ports	2-22
SAS Ports	2-22
2-10 Enabling SATA RAID	2-23
2-11 Installing Additional Drivers	2-25
 Chapter 3: Troubleshooting	
3-1 Troubleshooting Procedures	3-1
Before Power On	3-1
No Power	3-1

No Video	3-1
Memory Errors	3-2
Losing the System's Setup Configuration	3-2
3-2 Technical Support Procedures	3-2
3-3 Frequently Asked Questions	3-3
3-4 Returning Merchandise for Service	3-4

Chapter 4: BIOS

4-1 Introduction	4-1
4-2 Main Menu	4-2
4-3 Advanced Settings Menu	4-2
4-4 Boot Menu	4-17
4-5 Security Menu	4-17
4-6 Exit Menu	4-18

Appendices:

Appendix A: BIOS Error Beep Codes

Appendix B: BIOS POST Checkpoint Codes

Chapter 1

Introduction

1-1 Overview

Checklist

Congratulations on purchasing your computer serverboard from an acknowledged leader in the industry. Our boards are designed with the utmost attention to detail to provide you with the highest standards in quality and performance.

Please check that the following items have all been included with your serverboard. If anything listed here is damaged or missing, contact your retailer.

Included with retail box only

- One (1) H8DM3-2/H8DMi-2 serverboard
- One (1) IDE cable (CBL-036L-02)
- One (1) floppy cable (CBL-022L)
- One (1) COM port cable (CBL-010)
- Two (2) SAS cables, H8DM3-2 only (CBL-0097L-02)
- Four (4) SATA cables, H8DM3-2 only (CBL-044L)
- Six (6) SATA cables, H8DMi-2 only (CBL-044L)
- Two (2) heatsink retention modules with four (4) screws (BKT-0012L)
- One (1) I/O shield for chassis (CSE-PT7L)
- One (1) CD containing drivers and utilities

Contacting Supermicro

Headquarters

Address: Super Micro Computer, Inc.
980 Rock Ave.
San Jose, CA 95131 U.S.A.

Tel: +1 (408) 503-8000

Fax: +1 (408) 503-8008

Email: marketing@supermicro.com (General Information)
support@supermicro.com (Technical Support)

Web Site: www.supermicro.com

Europe

Address: Super Micro Computer B.V.
Het Sterrenbeeld 28, 5215 ML
's-Hertogenbosch, The Netherlands

Tel: +31 (0) 73-6400390

Fax: +31 (0) 73-6416525

Email: sales@supermicro.nl (General Information)
support@supermicro.nl (Technical Support)
rma@supermicro.nl (Customer Support)

Asia-Pacific

Address: Super Micro Computer, Inc.
4F, No. 232-1, Liancheng Rd.
Chung-Ho 235, Taipei County
Taiwan, R.O.C.

Tel: +886-(2) 8226-3990

Fax: +886-(2) 8226-3991

Web Site: www.supermicro.com.tw

Technical Support:

Email: support@supermicro.com.tw

Tel: 886-2-8228-1366, ext.132 or 139

Figure 1-1. H8DM3-2/H8DMi-2 Image

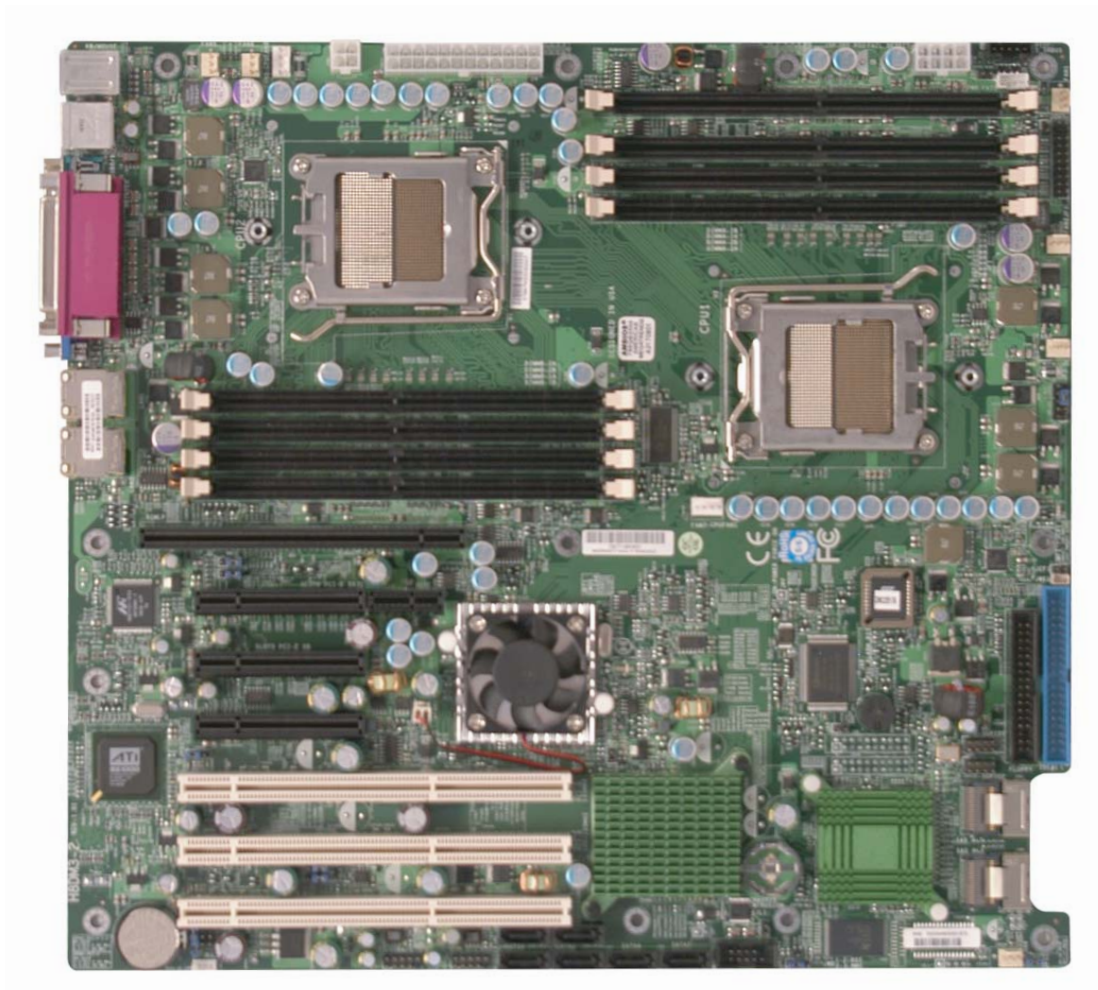

Notes:

H8DM3-2 is pictured. The H8DMi-2 has the same layout as the H8DM3-2 but with no SAS components or ports.

Figure 1-2. H8DM3-2/H8DMi-2 Serverboard Layout
(not drawn to scale)

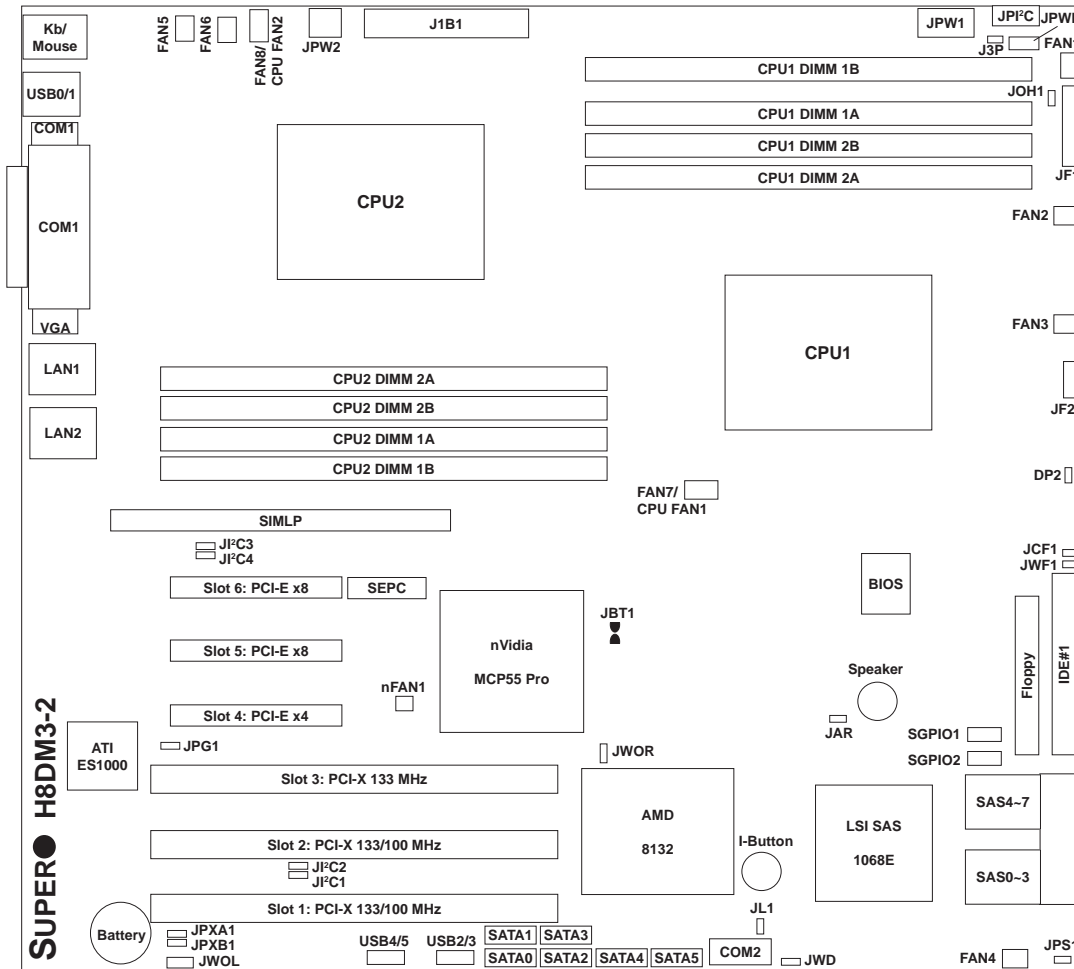

Notes:

1. Jumpers not indicated are for test purposes only.
2. The H8DMi-2 has the same layout as the H8DM3-2 but with no SAS components or ports or I-button.
3. The I-Button (optional) is used to enable RAID 5.
4. For SAS RAID, SR and IT modes are supported but not IR.

H8DM3-2/H8DMi-2 Quick Reference

Jumpers	Description	Default Setting
J3P	Power Supply Fail Detect	Closed (Enabled)
JBT1	CMOS Clear	See Section 2-7
JCF1	Compact Flash Master/Slave	Closed (Master)
J ² C1/2	I ² C to PCI-X Enable/Disable	Pins 2-3 (Disabled)
J ² C3/4	I ² C to PCI-E Enable/Disable	Pins 2-3 (Disabled)
JPG1	VGA Enable/Disable	Pins 1-2 (Enabled)
JPS1*	SAS RAID Select	Closed (SR RAID)
JPXA1/JPXB1	PCI-X Slot 1&2 Freq.	Open (Auto)
JWD	Watch Dog	Pins 1-2 (Reset)
Connectors	Description	
COM1, COM2	COM1/COM2 Serial Port/Header	
FAN 1-8	System Fan Headers	
Floppy	Floppy Disk Drive Connector	
I-Button*	RAID 5 Enable Button (optional)	
IDE#1	IDE Drive Connector	
J1B1	24-Pin ATX Power Connector	
JAR	Power Fail Alarm Reset Header	
JF1	Front Panel Connector	
JF2	Onboard Speaker/Keylock/Power LED	
JL1	Chassis Intrusion Header	
JOH1	Overheat Warning Header	
JPI ² C	Power Supply I ² C Header	
JPW1	8-Pin Processor Power Connector	
JPW2	4-pin Auxiliary Power Connector	
JPWF	Power Supply Fail Alarm Header	
JWF1	Compact Flash Card Power Connector	
JWOL	Wake-On-LAN Header	
JWOR	Wake-On-Ring Header	
LAN1/2	Gigabit Ethernet (RJ45) Ports	
nFAN1	Chipset Heatsink Fan Header	
SAS0~3, SAS4~7*	SAS Ports	
SATA0 ~ SATA5	Serial ATA Ports	
SGPIO1/SGPIO2	SGPIO Headers	
SIMLP	IPMI 2.0 Card Slot	
USB0/1	Universal Serial Bus (USB) Ports 0/1	
USB2/3, USB4/5	USB Headers	
Indicators	Description	
DP2	Onboard Power LED	
*H8DM3-2 only		

Serverboard Features

CPU

- Single or dual AMD Opteron 2000 Series Socket F type processors

Memory

- Eight dual/single channel DIMM slots supporting up to 64 GB of DDR2-667 or 32 GB of DDR2-533/400 registered ECC SDRAM

Note: Memory capacities are halved for single CPU systems. Refer to Section 2-4 before installing.

Chipset

- nVidia MCP55 Pro
- AMD-8132

Expansion Slots

- Two (2) PCI-Express x8 slots
- One (1) PCI-Express x4 slot
- One (1) PCI-X 133 MHz slot
- Two (2) PCI-X 133/100 MHz slots*
- One (1) low-profile SIMLP slot (for IPMI card)

*These slots share a bus and so can only support up to 100 MHz when cards are installed in both slots.

BIOS

- 8 Mb AMIBIOS® LPC Flash ROM
- APM 1.2, DMI 2.3, PCI 2.2, ACPI 2.0, SMBIOS 2.3, Plug and Play (PnP)

PC Health Monitoring

- Onboard voltage monitors for two CPU cores, 3.3V, +5Vin, +12Vin, 5V stby and battery voltage
- Fan status monitor with firmware/software on/off and speed control
- Watch Dog
- Environmental temperature monitoring via BIOS
- Power-up mode control for recovery from AC power loss
- System resource alert (via included utility program)
- Pulse Width Modulated (PWM) fan connectors (FAN7 and FAN8 only)
- Auto-switching voltage regulator for the CPU core

ACPI Features

- Microsoft OnNow
- Slow blinking LED for suspend state indicator
- BIOS support for USB keyboard
- Main switch override mechanism
- Internal/external modem ring-on

Onboard I/O

- On-chip SATA controller supporting six (6) SATA ports (RAID 0, 1, 0+1, 5 and JBOD)
- LSI 1068E SAS controller (H8DM3-2 only, RAID 0, 1, 10 and JBOD; optional RAID 5 support with I-Button installed)
- One (1) UltraDMA (ATA) 133/100 IDE port
- One (1) floppy port interface (up to 2.88 MB)
- Two (2) Fast UART 16550 compatible serial ports
- On-chip (nVidia MCP55) Ethernet controller supports two Gigabit LAN ports
- PS/2 mouse and PS/2 keyboard ports
- Six (6) USB (Universal Serial Bus) 2.0 ports/headers

Other

- Wake-on-Ring (JWOR)
- Wake-on-LAN (JWOL)
- Onboard +5V power LED
- Chassis intrusion detection

CD Utilities

- BIOS flash upgrade utility

Dimensions

- Extended ATX form factor, 12" x 13.05" (305 x 332 mm)

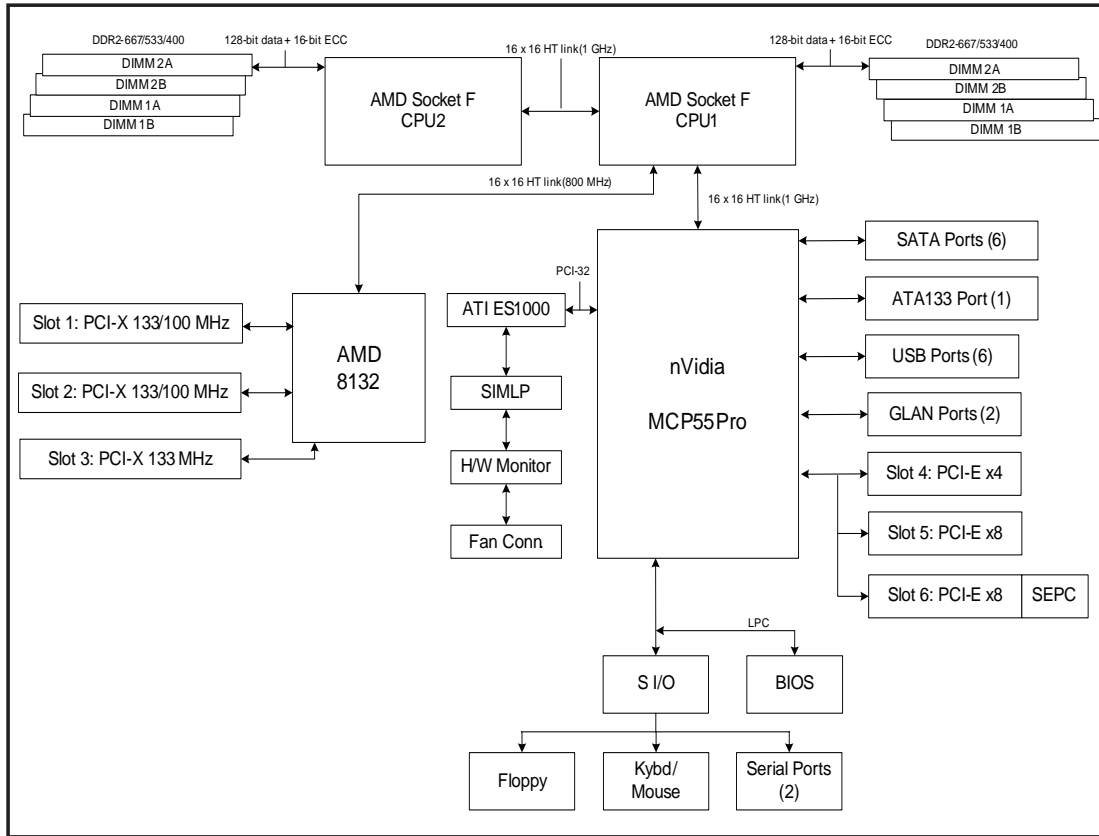

**Figure 1-3. nVidia MCP55 Pro/AMD-8132 Chipset:
System Block Diagram**

Note: This is a general block diagram and may not exactly represent the features on your serverboard. See the previous pages for the actual specifications of your serverboard.

1-2 Chipset Overview

The H8DM3-2/H8DMi-2 serverboard is based on the nVidia MCP55 Pro/AMD-8132 chipset. The nVidia MCP55 Pro functions as Media and Communications Processor (MCP). Controllers for the system memory are integrated directly into the AMD Opteron processors.

MCP55 Pro Media and Communications Processor

The MCP55 Pro is a single-chip, high-performance HyperTransport peripheral controller. It includes a 28-lane PCI Express interface, an AMD Opteron 16-bit HyperTransport interface link, a six-port Serial ATA interface, a dual-port Gb Ethernet interface, a dual ATA133 bus master interface and a USB 2.0 interface. This hub connects directly to CPU#1 and through that to CPU#2.

8132 HyperTransport PCI-X Tunnel

This hub includes AMD-specific technology that provides two PCI-X bridges with each bridge supporting a 64-bit data bus as well as separate PCI-X operational modes and independent transfer rates. Each bridge supports up to five PCI masters that include clock, request and grant signals. The 8132 tunnel connects to the processors and through them to system memory. It also interfaces directly with the Serial ATA and Ethernet controllers.

HyperTransport Technology

HyperTransport technology is a high-speed, low latency point to point link that was designed to increase the communication speed by a factor of up to 48x between integrated circuits. This is done partly by reducing the number of buses in the chipset to reduce bottlenecks and by enabling a more efficient use of memory in multi-processor systems. The end result is a significant increase in bandwidth within the chipset.

1-3 PC Health Monitoring

This section describes the PC health monitoring features of the H8DM3-2/H8DMi-2. The serverboard has an onboard System Hardware Monitor chip that supports PC health monitoring.

Onboard Voltage Monitors for two CPU cores, 3.3V, +5Vin, +12Vin, +5V standby and battery

The onboard voltage monitor will scan these voltages continuously. Once a voltage becomes unstable, it will give a warning or send an error message to the screen. Users can adjust the voltage thresholds to define the sensitivity of the voltage monitor. Real time readings of these voltage levels are all displayed in BIOS.

Fan Status Monitor with Firmware/Software Speed Control

The PC health monitor can check the RPM status of the cooling fans. The onboard fans are controlled by thermal management via BIOS.

CPU Overheat/Fan Fail LED and Control

This feature is available when the user enables the CPU overheat/Fan Fail warning function in the BIOS. This allows the user to define an overheat temperature. When this temperature is exceeded or when a fan failure occurs, then, the Overheat/Fan Fail warning LED is triggered.

Auto-Switching Voltage Regulator for the CPU Core

The 3-phase-switching voltage regulator for the CPU core can support up to 80A and auto-sense voltage IDs ranging from 0.8 V to 1.55V. This will allow the regulator to run cooler and thus make the system more stable.

1-4 Power Configuration Settings

This section describes the features of your serverboard that deal with power and power settings.

Microsoft OnNow

The OnNow design initiative is a comprehensive, system-wide approach to system and device power control. OnNow is a term for a PC that is always on but appears to be off and responds immediately to user or other requests.

Slow Blinking LED for Suspend-State Indicator

When the CPU goes into a suspend state, the chassis power LED will start blinking to indicate that the CPU is in suspend mode. When the user presses any key, the CPU will wake-up and the LED will automatically stop blinking and remain on.

BIOS Support for USB Keyboard

If a USB keyboard is the only keyboard in the system, it will function like a normal keyboard during system boot-up.

Main Switch Override Mechanism

When an ATX power supply is used, the power button can function as a system suspend button. When the user depresses the power button, the system will enter a SoftOff state. The monitor will be suspended and the hard drive will spin down. Depressing the power button again will cause the whole system to wake-up. During the SoftOff state, the ATX power supply provides power to keep the required circuitry in the system alive. In case the system malfunctions and you want to turn off the power, just depress and hold the power button for 4 seconds. The power will turn off and no power will be provided to the serverboard.

Wake-On-LAN (JWOL)

Wake-On-LAN is defined as the ability of a management application to remotely power up a computer that is powered off. Remote PC setup, up-dates and access tracking can occur after hours and on weekends so that daily LAN traffic is kept to a minimum and users are not interrupted. The serverboard has a 3-pin header (JWOL) to connect to the 3-pin header on a Network Interface Card (NIC) that has WOL capability. Wake-On-LAN must be enabled in BIOS. Note that Wake-On-LAN can only be used with an ATX 2.01 (or above) compliant power supply.

Wake-On-Ring Header (JWOR)

Wake-up events can be triggered by a device such as the external modem ringing when the system is in the SoftOff state. Note that external modem ring-on can only be used with an ATX 2.01 (or above) compliant power supply.

1-5 Power Supply

As with all computer products, a stable power source is necessary for proper and reliable operation. It is even more important for processors that have high CPU clock rates.

The H8DM3-2/H8DMi-2 accommodates 12V ATX power supplies. Although most power supplies generally meet the specifications required by the CPU, some are inadequate. A 2 amp current supply on a 5V Standby rail is strongly recommended.

It is strongly recommended that you use a high quality power supply that meets 12V ATX power supply Specification 1.1 or above. Additionally, in areas where noisy power transmission is present, you may choose to install a line filter to shield the computer from noise. It is recommended that you also install a power surge protector to help avoid problems caused by power surges.

Warning: To prevent the possibility of explosion, do not use the wrong type of onboard CMOS battery or install it upside down.

1-6 Super I/O

The disk drive adapter functions of the Super I/O chip include a floppy disk drive controller that is compatible with industry standard 82077/765, a data separator, write pre-compensation circuitry, decode logic, data rate selection, a clock generator, drive interface control logic and interrupt and DMA logic. The wide range of functions integrated onto the Super I/O greatly reduces the number of components required for interfacing with floppy disk drives. The Super I/O supports two 360 K, 720 K, 1.2 M, 1.44 M or 2.88 M disk drives and data transfer rates of 250 Kb/s, 500 Kb/s or 1 Mb/s.

It also provides two high-speed, 16550 compatible serial communication ports (UARTs), one of which supports serial infrared communication. Each UART includes a 16-byte send/receive FIFO, a programmable baud rate generator, complete modem control capability and a processor interrupt system. Both UARTs provide legacy speed with baud rate of up to 115.2 Kbps as well as an advanced speed with baud rates of 250 K, 500 K, or 1 Mb/s, which support higher speed modems.

The Super I/O supports one PC-compatible printer port (SPP), Bi-directional Printer Port (BPP) , Enhanced Parallel Port (EPP) or Extended Capabilities Port (ECP).

The Super I/O provides functions that comply with ACPI (Advanced Configuration and Power Interface), which includes support of legacy and ACPI power management through a SMI or SCI function pin. It also features auto power management to reduce power consumption.

The IRQs, DMAs and I/O space resources of the Super I/O can be flexibly adjusted to meet ISA PnP requirements, which support ACPI and APM (Advanced Power Management).

Notes

Chapter 2

Installation

2-1 Static-Sensitive Devices

Electrostatic Discharge (ESD) can damage electronic components. To prevent damage to your system board, it is important to handle it very carefully. The following measures are generally sufficient to protect your equipment from ESD.

Precautions

- Use a grounded wrist strap designed to prevent static discharge.
- Touch a grounded metal object before removing the board from the antistatic bag.
- Handle the board by its edges only; do not touch its components, peripheral chips, memory modules or gold contacts.
- When handling chips or modules, avoid touching their pins.
- Put the serverboard and peripherals back into their antistatic bags when not in use.
- For grounding purposes, make sure your computer chassis provides excellent conductivity between the power supply, the case, the mounting fasteners and the serverboard.
- Use only the correct type of CMOS onboard battery as specified by the manufacturer. Do not install the CMOS onboard battery upside down, which may result in a possible explosion.

Unpacking

The serverboard is shipped in antistatic packaging to avoid static damage. When unpacking the board, make sure the person handling it is static protected.

Installation Procedures

Follow the procedures as listed below to install the serverboard into a chassis:

1. Install the processor(s) and the heatsink(s).
2. Install the serverboard in the chassis.
3. Install the memory and add-on cards.
4. Finally, connect the cables and install the drivers.

2-2 Processor and Heatsink Installation



Exercise extreme caution when handling and installing the processor. Always connect the power cord last and always remove it before adding, removing or changing any hardware components.

Installing the CPU Backplates

Two CPU backplates (BKT-0011L) have been preinstalled to the serverboard to prevent the CPU area of the serverboard from bending and to provide a base for attaching the heatsink retention modules.

Installing the Processor (install to the CPU#1 socket first)

1. Begin by removing the cover plate that protects the CPU. Lift the lever on CPU socket #1 until it points straight up. With the lever raised, lift open the silver CPU retention plate.

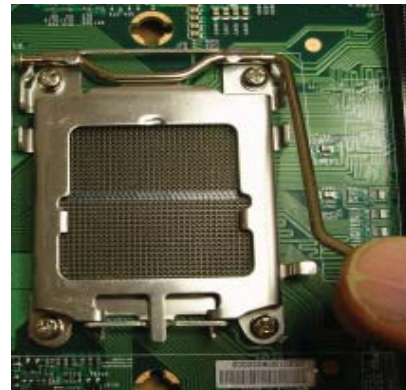

2. Use your thumb and your index finger to hold the CPU. Locate and align pin 1 of the CPU socket with pin 1 of the CPU. Both are marked with a triangle.

Triangles



3. Align pin 1 of the CPU with pin 1 of the socket. Once aligned, carefully place the CPU into the socket. *Do not drop the CPU on the socket, move the CPU horizontally or vertically or rub the CPU against the socket or against any pins of the socket, which may damage the CPU and/or the socket.*



4. With the CPU inserted into the socket, inspect the four corners of the CPU to make sure that it is properly installed and flush with the socket. Then, gently lower the silver CPU retention plate into place.



5. Carefully press the CPU socket lever down until it locks into its retention tab. For a dual-processor system, repeat these steps to install another CPU into the CPU#2 socket.

Note: if using a single processor, only the CPU1 DIMM slots are addressable for a maximum of 16 GB memory.



Installing the Heatsink Retention Modules

Two heatsink retention modules (BKT-0012L) and four screws are included in the retail box. Once installed, these are used to help attach the heatsinks to the CPUs. To install, align the module with the standoffs of the preinstalled CPU backplate and with the four feet on the module contacting the serverboard. Secure the retention module to the backplate with two of the screws provided. See Figure 2-1. Repeat for the second CPU socket.

Note: BKT-0012L is included for use with non-proprietary heatsinks only. When installing Supermicro heatsinks, only BKT-0011L (the CPU backplate) is needed. The BKT-0012L retention module was designed to provide compatibility with clip-and-cam type heatsinks from third parties.

Figure 2-1. CPU Heatsink Retention Module Installation

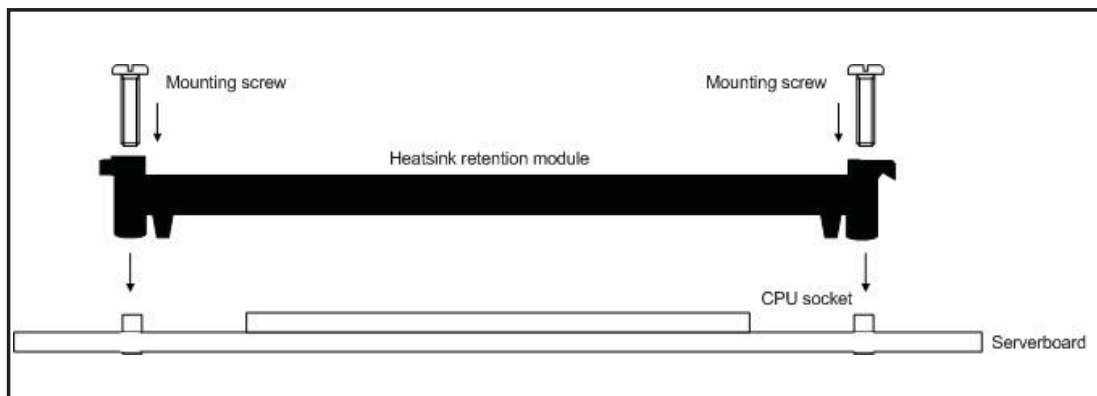

Installing the Heatsink

The use of active type heatsinks are recommended (except for 1U systems). Connect the heatsink fans to the appropriate fan headers on the serverboard. To install the heatsinks, please follow the installation instructions included with your heatsink package (not included).

2-3 Mounting the Serverboard into a Chassis

All serverboards and motherboards have standard mounting holes to fit different types of chassis. Make sure that the locations of all the mounting holes for both the serverboard and the chassis match. Although a chassis may have both plastic and metal mounting fasteners, metal ones are highly recommended because they ground the serverboard to the chassis. Make sure that the metal standoffs click in or are screwed in tightly.

1. Check the compatibility of the serverboard ports and the I/O shield

The H8DM3-2/H8DMi-2 serverboard requires a chassis that can support extended ATX boards of 12" x 13.05" in size. Make sure that the I/O ports on the serverboard align with their respective holes in the I/O shield at the rear of the chassis.

2. Mounting the serverboard onto the mainboard tray in the chassis

Carefully mount the serverboard onto the mainboard tray by aligning the serverboard mounting holes with the raised metal standoffs in the tray. Insert screws into all the mounting holes in the serverboard that line up with the standoffs. Then use a screwdriver to secure the serverboard to the mainboard tray - tighten until just snug (if too tight you might strip the threads). Metal screws provide an electrical contact to the serverboard ground to provide a continuous ground for the system.

2-4 Installing Memory

CAUTION

Exercise extreme care when installing or removing memory modules to prevent any possible damage.

1. Insert each memory module vertically into its slot, paying attention to the notch along the bottom of the module to prevent inserting the module incorrectly (see Figure 2-2). See support information below.

2. Gently press down on the memory module until it snaps into place.

Note: each processor has its own built-in memory controller, so the CPU2 DIMMs cannot be addressed if only a single CPU is installed. 128 MB, 256 MB, 512 MB, 1 GB, 2 GB and 4 GB memory modules are supported. It is highly recommended that you remove the power cord from the system before installing or changing any memory modules.

Support

The H8DM3-2/H8DMi-2 supports single or dual-channel, DDR2-667/533/400 registered ECC SDRAM.

Both interleaved and non-interleaved memory are supported, so you may populate any number of DIMM slots (see note on previous page and charts on following page). The CPU2 DIMM slots can only be accessed when two CPUs are installed (however, the CPU2 DIMM slots are not required to be populated when two CPUs are installed).

Populating two adjacent slots at a time with memory modules of the same size and type will result in interleaved (128-bit) memory, which is faster than non-interleaved (64-bit) memory. See charts on following page.

Optimizing memory performance

If two processors are installed, it is better to stagger pairs of DIMMs across both sets of CPU DIMM slots, e.g. first populate CPU1 slots 1A and 1B, then CPU2 slots 1A, and 1B, then the next two CPU1 slots, etc. This balances the load over both CPUs to optimize performance.

Maximum memory: 64 GB of DDR2-667 or 32 GB of DDR2-533/400 registered ECC SDRAM. If only one CPU is installed, maximum supported memory is halved (16 GB).

Figure 2-2. Side and Top Views of DDR Installation

To Install:

Insert module vertically and press down until it snaps into place. The release tabs should close - if they do not you should close them yourself.

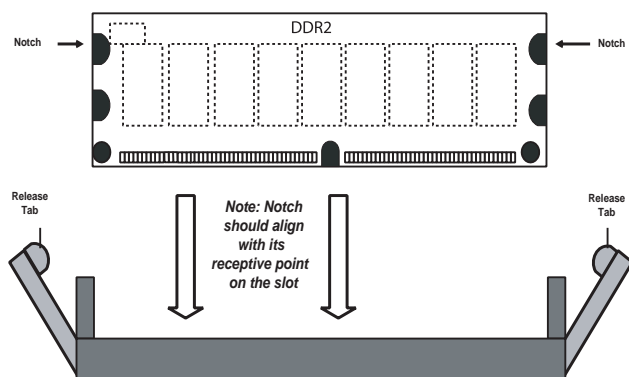

Note the notch in the slot and on the bottom of the DIMM. These prevent the DIMM from being installed incorrectly.

To Remove:

Use your thumbs to gently push each release tab outward to release the DIMM from the slot.

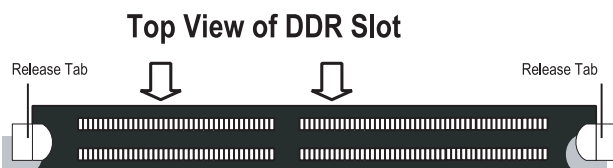

Populating Memory Banks for 128-bit Operation							
CPU1 DIMM1A	CPU1 DIMM1B	CPU1 DIMM2A	CPU1 DIMM2B	CPU2 DIMM1A	CPU2 DIMM1B	CPU2 DIMM2A	CPU2 DIMM2B
X	X						
X	X			X	X		
X	X					X	X
X	X			X	X	X	X
X	X	X	X				
X	X	X	X	X	X		
X	X	X	X			X	X
X	X	X	X	X	X	X	X
		X	X				
		X	X	X	X		
		X	X			X	X
		X	X	X	X	X	X

Notes: X indicates a populated DIMM slot. If adding at least four DIMMs (with two CPUs installed), the configurations with DIMMs spread over both CPUs (and not like the configuration in row 5) will result in optimized performance. Note that the first two DIMMs must be installed in the CPU1 memory slots.

Populating Memory Banks for 64-bit Operation							
CPU1 DIMM1A	CPU1 DIMM1B	CPU1 DIMM2A	CPU1 DIMM2B	CPU2 DIMM1A	CPU2 DIMM1B	CPU2 DIMM2A	CPU2 DIMM2B
X							
		X					
X		X					
X				X			
X						X	
		X		X			
		X				X	

2-5 I/O Port and Control Panel Connections

The I/O ports are color coded in conformance with the PC99 specification to make setting up your system easier. See Figure 2-3 below for the colors and locations of the various I/O ports.

Figure 2-3. I/O Port Locations and Definitions

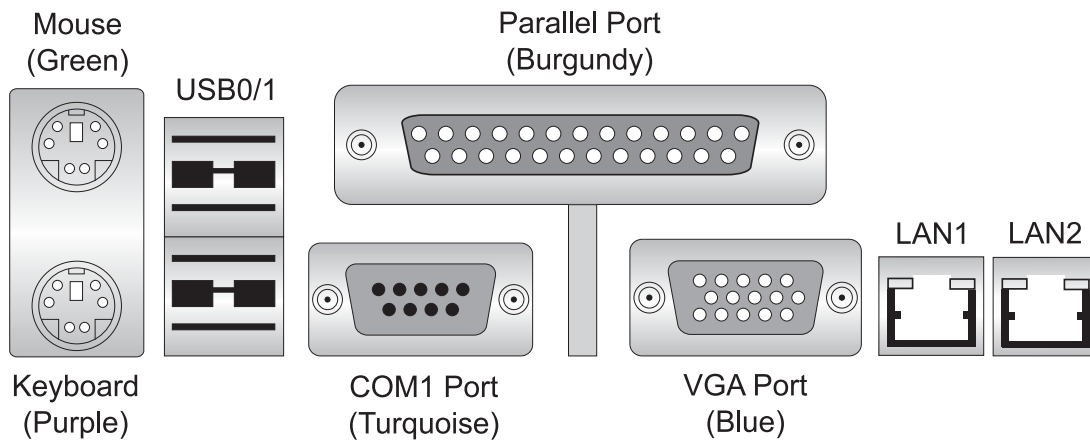

Front Control Panel

JF1 contains header pins for various front control panel connectors. See Figure 2-4 for the pin definitions of the various connectors. Refer to Section 2-6 for details.

Figure 2-4. JF1: Front Control Panel Header (JF1)

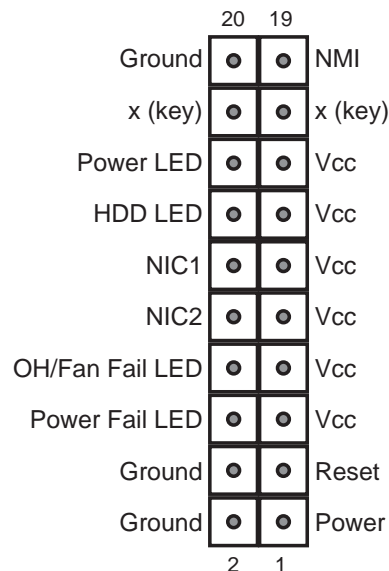

2-6 Connecting Cables

ATX Power Connector

The primary ATX power supply connector (J1B1) meets the SSI (Super-set ATX) 24-pin specification. Refer to the table on the right for the pin definitions of the ATX 24-pin power connector. This connection supplies power to the chipset, fans and memory.

Note: You must also connect the 8-pin (JPW1) and 4-pin (JPW2) power connectors to your power supply (see below).

ATX Power 24-pin Connector Pin Definitions (J1B1)			
Pin#	Definition	Pin #	Definition
13	+3.3V	1	+3.3V
14	-12V	2	+3.3V
15	COM	3	COM
16	PS_ON	4	+5V
17	COM	5	COM
18	COM	6	+5V
19	COM	7	COM
20	Res (NC)	8	PWR_OK
21	+5V	9	5VSB
22	+5V	10	+12V
23	+5V	11	+12V
24	COM	12	+3.3V

Processor Power Connector

In addition to the primary ATX power connector (above), the 12v, 8-pin processor power connector at JPW1 must also be connected to your power supply. This connection supplies power to the CPUs. See the table on the right for pin definitions.

Processor Power Connector Pin Definitions (JPW1)	
Pins	Definition
1 through 4	Ground
5 through 8	+12V

Required Connection

Auxiliary Power Connector

The 4-pin auxiliary power connector at JPW2 must also be connected to your power supply. This connection supplies extra power that may be needed for high loads. See the table on the right for pin definitions.

Auxiliary Power Connector Pin Definitions (JPW2)	
Pins	Definition
1 & 2	Ground
3 & 4	+12V

Required Connection

Power LED

The Power LED connection is located on pins 15 and 16 of JF1. Refer to the table on the right for pin definitions.

Power LED Pin Definitions (JF1)	
Pin#	Definition
15	Vcc
16	Control

HDD LED

The HDD (IDE Hard Disk Drive) LED connection is located on pins 13 and 14 of JF1. Attach the IDE hard drive LED cable to display disk activity. Refer to the table on the right for pin definitions.

HDD LED Pin Definitions (JF1)	
Pin#	Definition
13	Vcc
14	HD Active

NIC1 LED

The NIC1 (Network Interface Controller) LED connection is located on pins 11 and 12 of JF1. Attach the NIC1 LED cable to display network activity. Refer to the table on the right for pin definitions.

NIC1 LED Pin Definitions (JF1)	
Pin#	Definition
11	Vcc
12	NIC1 Active

NIC2 LED

The NIC2 (Network Interface Controller) LED connection is located on pins 9 and 10 of JF1. Attach the NIC2 LED cable to display network activity. Refer to the table on the right for pin definitions.

NIC2 LED Pin Definitions (JF1)	
Pin#	Definition
9	Vcc
10	NIC2 Active

Overheat/Fan Fail LED

Connect an LED to the OH connection on pins 7 and 8 of JF1 to provide advanced warning of chassis overheating. Refer to the table on the right for pin definitions and status indicators.

OH/Fan Fail LED Pin Definitions (JF1)		OH/Fan Fail LED Status	
Pin#	Definition	State	Indication
7	Vcc	Solid	Overheat
8	Control	Blinking	Fan fail

Power Fail LED

The Power Fail LED connection is located on pins 5 and 6 of JF1. Refer to the table on the right for pin definitions. This feature is only available for systems with redundant power supplies.

Power Fail LED Pin Definitions (JF1)	
Pin#	Definition
5	Vcc
6	Control

Reset Button

The Reset Button connection is located on pins 3 and 4 of JF1. Attach it to the hardware reset switch on the computer case. Refer to the table on the right for pin definitions.

Reset Button Pin Definitions (JF1)	
Pin#	Definition
3	Reset
4	Ground

Power Button

The Power Button connection is located on pins 1 and 2 of JF1. Momentarily contacting both pins will power on/off the system. This button can also be configured to function as a suspend button (see the Power Button Mode setting in BIOS). To turn off the power when set to suspend mode, depress the button for at least 4 seconds. Refer to the table on the right for pin definitions.

Power Button Pin Definitions (JF1)	
Pin#	Definition
1	PW_ON
2	Ground

Universal Serial Bus Ports (USB0/1)

Two Universal Serial Bus ports (USB2.0) are located beside the LAN1/2 ports. See the table on the right for pin definitions.

Universal Serial Bus Ports Pin Definitions (USB0/1)			
USB0		USB1	
Pin #	Definition	Pin #	Definition
1	+5V	1	+5V
2	PO-	2	PO-
3	PO+	3	PO+
4	Ground	4	Ground

USB Headers

Four additional USB2.0 headers (USB2/3 and USB4/5) are included on the serverboard. These may be connected to provide front side access. A USB cable (not included) is needed for the connection. See the table on the right for pin definitions.

Universal Serial Bus Headers Pin Definitions (USB2/3/4/5)			
USB2		USB3/4	
Pin #	Definition	Pin #	Definition
1	+5V	1	+5V
2	PO-	2	PO-
3	PO+	3	PO+
4	Ground	4	Ground
5	Key	5	No connection

ATX PS/2 Keyboard and PS/2 Mouse Ports

The ATX PS/2 keyboard and the PS/2 mouse ports are located on the IO backplane. The mouse is the top (green) port. See the table on the right for pin definitions.

PS/2 Keyboard and Mouse Port Pin Definitions	
Pin#	Definition
1	Data
2	NC
3	Ground
4	VCC
5	Clock
6	NC

Serial Ports

The COM1 port is located under the parallel port. COM2 is a header located beside the SATA5 port. See the serverboard layout for locations and the table on the right for pin definitions.

Serial Port Pin Definitions (COM1/COM2)			
Pin #	Definition	Pin #	Definition
1	DCD	6	DSR
2	RXD	7	RTS
3	TXD	8	CTS
4	DTR	9	RI
5	Ground	10	NC

Note: NC indicates no connection.

Fan Headers

The H8DM3-2/H8DMi-2 has eight fan headers, which are designated FAN1 through FAN8. FAN7 and FAN8 are for 4-pin Pulse Width Modulated (PWM) fans and are to be connected to the CPU heatsink fans. Their speed is controlled via Thermal Management with a BIOS setting. FAN1 through FAN6 are 3-pin, non-PWM fans. See the tables on the right for pin definitions.

Note: The nFAN1 header connects to the heatsink fan on the nVidia MCP 55 Pro chip. Do not disconnect this fan or the chipset may overheat. See the table on the right for pin definitions.

4-pin Fan Header Pin Definitions (FAN7/FAN8)	
Pin#	Definition
1	Ground (Black)
2	+12V (Red)
3	Tachometer
4	PWM Control

3-pin Fan Header Pin Definitions (FAN1-FAN6)	
Pin#	Definition
1	Ground (Black)
2	+12V (Red)
3	Tachometer

Power LED/Speaker/Keylock

On JF2, pins 2, 4, and 6 are for the power LED, pins 1, 3, 5 and 7 are for the speaker and pins 8 and 10 are for the keylock. See the tables on the right for pin definitions.

Note: The speaker connector pins are for use with an external speaker. If you wish to use the onboard speaker, you should close pins 5 and 7 with a jumper. Utilizing the keylock header allows you to inhibit any actions made on the keyboard, effectively "locking" it.

PWR LED Connector Pin Definitions (JF2)	
Pin#	Definition
2	+Vcc
4	Control
6	Control

Speaker Connector Pin Definitions (JF2)	
Pin#	Definition
1	Red wire, +5V
3	No connection
5	Buzzer signal
7	Speaker data

Overheat LED

Connect an LED to the JOH1 header to provide warning of chassis overheating. See the table on the right for pin definitions.

Overheat LED Pin Definitions (JOH1)	
Pin#	Definition
1	3.3V
2	OH Active

Chassis Intrusion

A Chassis Intrusion header is located at JL1. Attach the appropriate cable to inform you of a chassis intrusion.

Chassis Intrusion Pin Definitions (JL1)	
Pin#	Definition
1	Battery voltage
2	Intrusion signal

Wake-On-LAN

The Wake-On-LAN header is designated JWOL. See the table on the right for pin definitions. You must have a LAN card with a Wake-On-LAN connector and cable to use the Wake-On-LAN feature.

(Note: Wake-On-LAN from S3, S4, S5 are supported by LAN1. LAN2 supports Wake-On-LAN from S1 only.)

Wake-On-LAN Pin Definitions (JWOL)	
Pin#	Definition
1	+5V Standby
2	Ground
3	Wake-up

Wake-On-Ring

The Wake-On-Ring header is designated JWOR. This function allows your computer to receive and "wake-up" by an incoming call to the modem when in suspend state. See the table on the right for pin definitions. You must have a Wake-On-Ring card and cable to use this feature.

Wake-On-Ring Pin Definitions (JWOR)	
Pin#	Definition
1	Ground (Black)
2	Wake-up

Power Supply I²C Header

The JPI²C header is for I²C, which may be used to monitor the status of the power supply, fans and system temperature. See the table on the right for pin definitions.

I ² C Header Pin Definitions (JPI ² C)	
Pin#	Definition
1	Clock
2	Data
3	PWR Fail
4	Gnd
5	+3.3V

LAN1/2 (Ethernet Ports)

Two Gigabit Ethernet ports (designated LAN1 and LAN2) are located beside the VGA port. These Ethernet ports accept RJ45 type cables.



Power Supply Fail Alarm Reset Header

Connect JAR to the alarm reset button on your chassis (if available) or to a microswitch to allow you to turn off the alarm that sounds when a power supply module fails. See the table on the right for pin definitions.

Alarm Reset Header Pin Definitions (JAR)	
Pin#	Definition
1	Ground
2	Reset Signal

Power Supply Fail Alarm Header

Connect a cable from your power supply to JPWF to provide you with warning of a power supply failure. The warning signal is passed through the PWR_LED pin to indicate a power failure. See the table on the right for pin definitions.

Power Supply Fail Alarm Header Pin Definitions (JPWF)	
Pin#	Definition
1	P/S 1 Fail Signal
2	P/S 2 Fail Signal
3	P/S 3 Fail Signal
4	Reset (from MB)

Note: This feature is only available when using redundant power supplies.

Compact Flash Power Header

A Compact Flash Card Power header is located at JWF1. For the Compact Flash Card to work properly, you will first need to connect the device's power cable to JWF1 and correctly set the Compact Flash Jumper (JCF1).

Compact Flash Power Header Pin Definitions (JWF1)	
Pin#	Definition
1	+5V
2	Ground
3	Signal

SGPIO

SGPIO1 and SGPIO2 (Serial General Purpose Input/Output) provide a bus between the SATA controller and the SATA drive backplane to provide SATA enclosure management functions. Connect the appropriate cables from the backplane to the SGPIO1 and SGPIO2 header(s) to utilize SATA management functions on your system.

SGPIO Header Pin Definitions (SGPIO1, SGPIO2)			
Pin#	Definition	Pin #	Definition
1	NC	2	NC
3	Ground	4	Data
5	Load	6	Ground
7	NC	8	NC

Note: NC indicates no connection.

2-7 Jumper Settings

Explanation of Jumpers

To modify the operation of the serverboard, jumpers can be used to choose between optional settings. Jumpers create shorts between two pins to change the function of the connector. Pin 1 is identified with a square solder pad on the printed circuit board. See the diagram at right for an example of jumping pins 1 and 2. Refer to the serverboard layout page for jumper locations.

Note: On two-pin jumpers, "Closed" means the jumper is on and "Open" means the jumper is off the pins.

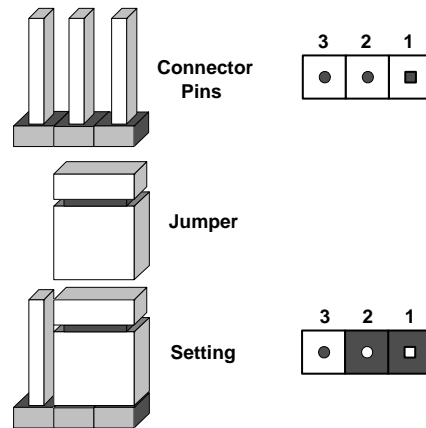

CMOS Clear

JBT1 is used to clear CMOS and will also clear any passwords. Instead of pins, this jumper consists of contact pads to prevent accidentally clearing the contents of CMOS.

To clear CMOS,

- 1) First power down the system and unplug the power cord(s).
- 2) With the power disconnected, short the CMOS pads with a metal object such as a small screwdriver for at least four seconds.
- 3) Remove the screwdriver (or shorting device).
- 4) Reconnect the power cord(s) and power on the system.

Notes:

Do not use the PW ON connector to clear CMOS.

The onboard battery does not need to be removed when clearing CMOS, however you must short JBT1 for at least four seconds.



JBT1 contact pads

I²C to PCI-X Enable/Disable

The JI²C1/2 pair of jumpers allows you to connect the System Management Bus to the PCI-X expansion slots. The default setting is disabled. Both connectors must be set the same (JI²C1 is for data and JI²C2 is for the clock). See the table on right for jumper settings.

I ² C to PCI-X Enable/Disable Jumper Settings (JI ² C1/2)	
Jumper Setting	Definition
Pins 1-2	Enabled
Pins 2-3	Disabled

I²C to PCI-E Enable/Disable

The JI²C3/4 pair of jumpers allows you to connect the System Management Bus to the PCI-Express expansion slots. The default setting is disabled. Both connectors must be set the same (JI²C3 is for data and JI²C4 is for the clock). See the table on right for jumper settings.

I ² C to PCI-E Enable/Disable Jumper Settings (JI ² C3/4)	
Jumper Setting	Definition
Pins 1-2	Enabled
Pins 2-3	Disabled

Watch Dog

JWD controls Watch Dog, a system monitor that takes action when a software application freezes the system. Jumping pins 1-2 will cause WD to reset the system if an application is hung up. Jumping pins 2-3 will generate a non-maskable interrupt signal for the application that is hung up. See the table on the right for jumper settings. Watch Dog must also be enabled in BIOS.

Watch Dog Jumper Settings (JWD)	
Jumper Setting	Definition
Pins 1-2	Reset
Pins 2-3	NMI
Open	Disabled

VGA Enable/Disable

JPG1 allows you to enable or disable the VGA port. The default position is on pins 1 and 2 to enable VGA. See the table on the right for jumper settings.

VGA Enable/Disable Jumper Settings (JPG1)	
Jumper Setting	Definition
Pins 1-2	Enabled
Pins 2-3	Disabled

PCI-X Slot Speed

Jumper JPXA1 on the H8DM3-2/H8DMi-2 is used to change the speed of PCI-X slots #1 & 2. Jumper JPXB1 is used to change the speed of PCI-X slot #3. See the tables on the right for jumper settings.

Note: JPXA1 controls the speed for PCI-X slots #1 and #2. JPXB1 controls the speed for PCI-X slot #3. The default setting for both is Open (Auto).

PCI-X Slot Speed Jumper Settings (JPX1A/JPX1B)	
Jumper Setting	Definition
Open	Auto
Pins 1-2	PCI-X 66 MHz
Pins 2-3	PCI 66 MHz

Compact Flash Master/Slave

The JCF1 jumper allows you to assign either master or slave status a compact flash card installed in IDE1. See the table on the right for jumper settings.

Compact Flash Master/Slave Jumper Settings (JCF1)	
Jumper Setting	Definition
Closed	Master
Open	Slave

Power Supply Fail Detect Enable/Disable

The system can notify you in the event of a power supply failure. This feature assumes that redundant power supply modules are installed in the chassis. If you only have a single power supply installed, you should disable this function with J3P to prevent false alarms. See the table on the right for jumper settings.

Power Supply Fail Detect Jumper Settings (J3P)	
Jumper Setting	Definition
Open	Disabled
Closed	Enabled

SAS RAID Select

JPS1 allows you to select between SR RAID, which is the default and enables SAS RAID, or IT RAID, which treats SAS drives as non-RAID drives and requires a firmware flash. See the table on the right for jumper settings and the following page for the IT firmware flash procedure.

SAS RAID Select Jumper Settings (JPS1)	
Jumper Setting	Definition
Open	IT RAID
Closed	SR RAID

Note: SR = Software RAID IT = Integrate Target mode. IR mode is not supported.

Flashing IT Firmware

1. Download the appropriate IT firmware from the web site:
ftp://ftp.supermicro.com/driver/SAS/LSI/Firmware/IT/
2. Unzip it to a bootable floppy or USB pen.
3. With JPS1 on (closed) boot to the device with the unzipped firmware and type "clear" to erase the SR firmware.
4. Remove AC power and open JPS1.
5. Boot to the disk again and type "H8DM32".
6. When prompted for the SAS address, type in the 16-digit SAS address labeled on the board.
7. Power off the system before restarting.

2-8 Onboard Indicators

LAN1/LAN2 LEDs

The Ethernet ports (located beside the VGA port) have two LEDs. On each Gb LAN port, one LED indicates activity when blinking while the other LED may be amber or off to indicate the speed of the connection. See the table on the right for the functions associated with the connection speed LED.

JLAN LED (Connection Speed Indicator)	
LED Color	Definition
Off	10/100 MHz
Amber	1 GHz

Onboard Power LED

DP2 is an Onboard Power LED. When this LED is lit, it means power is present on the serverboard. In suspend mode this LED will blink on and off. Be sure to turn off the system and unplug the power cord(s) before removing or installing components.

2-9 Floppy, IDE, SATA and SAS Drive Connections

Use the following information to connect the floppy and hard disk drive cables.

- The floppy disk drive cable has seven twisted wires.
- A red mark on a wire typically designates the location of pin 1.
- A single floppy disk drive ribbon cable has 34 wires and two connectors to provide for two floppy disk drives. The connector with twisted wires always connects to drive A, and the connector that does not have twisted wires always connects to drive B.
- The 80-wire ATA133 IDE hard disk drive cable that came with your system has two connectors to support two drives. This special cable should be used to take advantage of the speed this new technology offers. The blue connector connects to the onboard IDE connector interface and the other connector(s) to your hard drive(s). Consult the documentation that came with your disk drive for details on actual jumper locations and settings for the hard disk drive.

Floppy Connector

The floppy connector is located beside the IDE connector. See the table on the right for pin definitions.

Floppy Drive Connector Pin Definitions (Floppy)			
Pin#	Definition	Pin #	Definition
1	GND	2	FDHDIN
3	GND	4	Reserved
5	Key	6	FDEDIN
7	GND	8	Index-
9	GND	10	Motor Enable
11	GND	12	Drive Select B-
13	GND	14	Drive Select A-
15	GND	16	Motor Enable
17	GND	18	DIR-
19	GND	20	STEP-
21	GND	22	Write Data-
23	GND	24	Write Gate-
25	GND	26	Track 00-
27	GND	28	Write Protect-
29	GND	30	Read Data-
31	GND	32	Side 1 Select-
33	GND	34	Diskette

IDE Connector

There are no jumpers to configure the onboard IDE#1 connector unless using it for a compact flash device. See the table on the right for pin definitions.

IDE Drive Connectors Pin Definitions (IDE#1)			
Pin#	Definition	Pin #	Definition
1	Reset IDE	2	Ground
3	Host Data 7	4	Host Data 8
5	Host Data 6	6	Host Data 9
7	Host Data 5	8	Host Data 10
9	Host Data 4	10	Host Data 11
11	Host Data 3	12	Host Data 12
13	Host Data 2	14	Host Data 13
15	Host Data 1	16	Host Data 14
17	Host Data 0	18	Host Data 15
19	Ground	20	Key
21	DRQ3	22	Ground
23	I/O Write	24	Ground
25	I/O Read	26	Ground
27	IOCHRDY	28	BALE
29	DACK3	30	Ground
31	IRQ14	32	IOCS16
33	Addr1	34	Ground
35	Addr0	36	Addr2
37	Chip Select 0	38	Chip Select 1
39	Activity	40	Ground

SATA Ports

There are no jumpers to configure the SATA ports, which are designated SATA0 through SATA5. See the table on the right for pin definitions.

SATA Drive Ports Pin Definitions (SATA0-SATA5)	
Pin #	Definition
1	Ground
2	TXP
3	TXN
4	Ground
5	RXN
6	RXP
7	Ground

SAS Ports (H8DM3-2)

There are two SAS port connectors located near the IDE and floppy connectors. One is for the SAS0~3 ports and the other is for SAS4-7 ports. See the table on the right for pin definitions.

Note: SAS is enabled in BIOS (refer to Chapter 4). See LSI's SAS manual for details on creating and working with SAS RAID arrays.

SAS Ports Pin Definitions (SAS0~3/SAS4~7)			
Pin#	Definition	Pin #	Definition
1	Rx0+	2	Rx0-
3	Rx1+	4	Rx1-
5	Rx2+	6	Rx2-
7	Rx3+	8	Rx3-
9	Tx3-	10	Tx3+
11	Tx2-	12	Tx2+
13	Tx1-	14	Tx1+
15	Tx0-	16	Tx0+

2-10 Enabling SATA RAID

Now that the hardware is set up, you can install the operating system and the SATA RAID drivers, if you wish to utilize SATA RAID. The installation procedure differs depending on whether you wish to have the operating system installed on a RAID array or on a separate non-RAID drive. See the instructions below for details.

Notes: See the LSI SAS manual (included on the Supermicro CD) for SAS RAID. IR mode is not supported.

Serial ATA (SATA)

Serial ATA (SATA) is a physical storage interface that employs a single cable with a minimum of four wires to create a point-to-point connection between devices. This connection is a serial link that supports a SATA transfer rate from 150 MBps. The serial cables used in SATA are thinner than the traditional cables used in Parallel ATA (PATA) and can extend up to one meter in length, compared to only 40 cm for PATA cables. Overall, SATA provides better functionality than PATA.

Installing the OS/SATA Driver

Before installing the OS (operating system) and SATA RAID driver, you must decide if you wish to have the operating system installed as part of a bootable RAID array or installed to a separate non-RAID hard drive. If on a separate drive, you may install the driver either during or after the OS installation. If you wish to have the OS on a SATA RAID array, you must follow the procedure below and install the driver during the OS installation.

Building a Driver Diskette

You must first build a driver diskette from the Supermicro CD-ROM that was included with the system. (You will have to create this disk on a computer that is already running and with the OS installed.) Insert the CD into your CD-ROM drive and start the system. A display as shown in Figure 2-5 will appear. Click on the icon labeled "Build Driver Diskettes and Manuals" and follow the instructions to create a floppy disk with the driver on it. Once it's been created, remove the floppy and insert the installation CD for the Windows Operating System you wish to install into the CD-ROM drive of the new system you are about to configure.

Enabling SATA RAID in the BIOS

Before installing the Windows Operating System, you must change some settings in BIOS. Boot up the system and hit the key to enter the BIOS Setup Utility. After the Setup Utility loads,

1. Use the arrow keys to move to the Exit menu. Scroll down with the arrow keys to the "Load Optimal Defaults setting and press <Enter>. Select "OK" to confirm, then <Enter> to load the default settings.
2. Use the arrow keys to move to Advanced > Floppy/IDE/SATA Configuration > Serial ATA Devices and then the nVidia RAID Setup settings. Use these settings to enable the SATA and RAID functions. Enable the SATA devices and channels you will be using.
3. Hit the <Esc> key twice and scroll to the Exit menu. Select "Save Changes and Exit" and hit <enter>, then hit <Enter> again to verify.
4. After exiting the BIOS Setup Utility, the system will reboot. When prompted during the startup, press the <F10> key when prompted to run the nVidia RAID Utility program.

Using the nVidia RAID Utility

The nVidia RAID Utility program is where you can define the drives you want to include in the RAID array and the mode and type of RAID. Two main windows are shown in the utility. The "Free Disks" window on the left will list all available drives. Use the arrow keys to select and move drives to the window on the right, which lists all drives that are to become part of the RAID array.

Once you have finished selecting the drives and type of RAID you wish to use for your RAID array, press the <F7> key. You will be prompted to verify your choice; if you want to continue with your choices, select "Yes". Note that selecting "Yes" will clear all previous data from the drives you selected to be a part of the array. You are then given the choice of making the RAID array bootable by pressing the the key. After you have finished, press the <Ctrl> and <X> keys simultaneously.

Installing the OS and Drivers

With the Windows OS installation CD in the CD-ROM drive, restart the system. When you see the prompt, hit the <F6> key to enter Windows setup. Eventually a blue screen will appear with a message that begins "Windows could not determine the type of one or more storage devices . . ." When you see the screen, hit the <S> key to "Specify Additional Device", then insert the driver diskette you just created into the floppy drive. Highlight "Manufacturer Supplied Hardware Support Disk" and hit the <Enter> key. Highlight the first "nVidia RAID" driver shown and press the <Enter> key to install it. Soon a similar blue screen will appear again. Again hit the <S> key, then highlight the second item, "nForce Storage Controller" and press the <Enter> key, then <Enter> again to continue with the Windows setup.

2-11 Installing Additional Drivers

The CD that came bundled with the system contains software drivers, some of which must be installed, such as the chipset driver. After inserting this CD into your CD-ROM drive, the display shown in Figure 2-5 should appear. (If this display does not appear, click on the My Computer icon and then on the icon representing your CD-ROM drive. Finally, double click on the S "Setup" icon.)

Figure 2-5. Driver/Tool Installation Display Screen

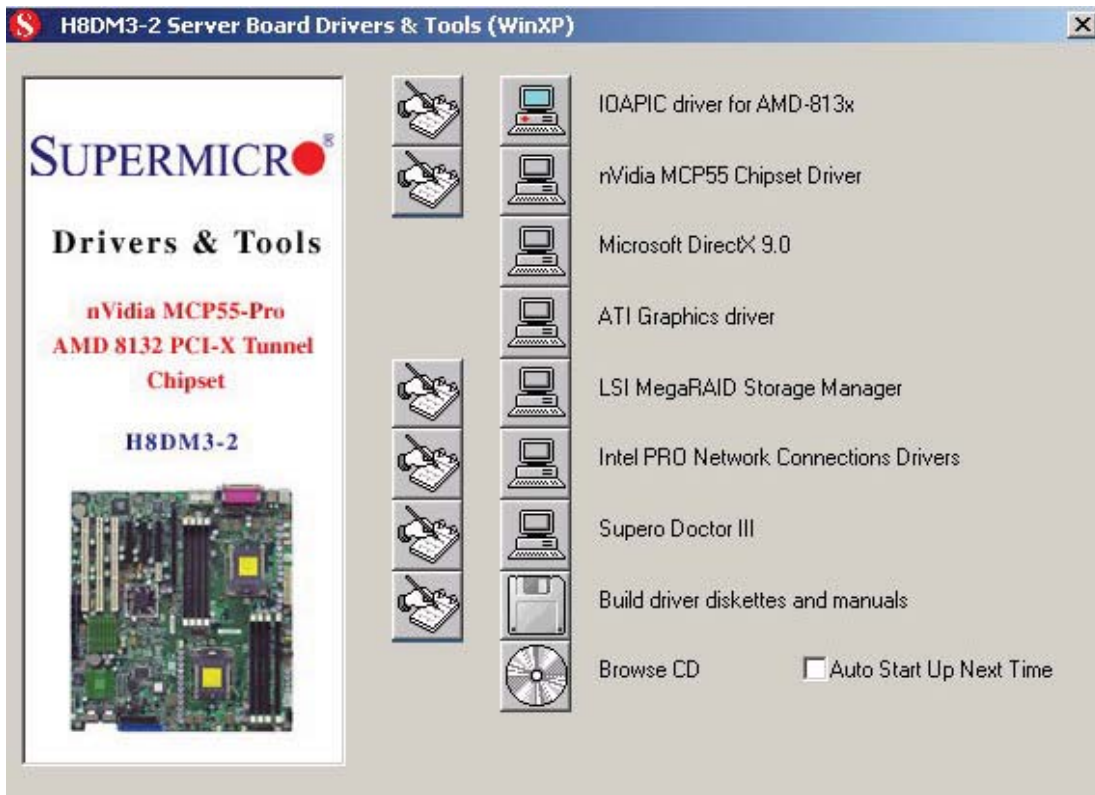

Click the icons showing a hand writing on paper to view the readme files for each item. Click the computer icons to the right of these items (from top to the bottom) one at a time. **After installing each item, you should reboot the system before moving on to the next item on the list.** The bottom icon with a CD on it allows you to view the entire contents of the CD.

Notes

Chapter 3

Troubleshooting

3-1 Troubleshooting Procedures

Use the following procedures to troubleshoot your system. If you have followed all of the procedures below and still need assistance, refer to the 'Technical Support Procedures' and/or 'Returning Merchandise for Service' section(s) in this chapter. Always disconnect the AC power cord before adding, changing or installing any hardware components.

Before Power On

1. Check that the onboard power LED (DP2) is lit.
2. Make sure that the main ATX power connector at J1B1, the 8-pin connector at JPW1 and the 4-pin connector at JPW2 are all connected to your power supply.
3. Make sure that no short circuits exist between the serverboard and chassis.
4. Disconnect all ribbon/wire cables from the serverboard, including those for the keyboard and mouse.
5. Remove all add-on cards.
6. Install a CPU and heatsink (making sure it is fully seated) and connect the internal (chassis) speaker and the power LED to the serverboard. Check all jumper settings as well.
7. Use the correct type of onboard CMOS battery as recommended by the manufacturer. To avoid possible explosion, do not install the CMOS battery upside down.

No Power

1. Make sure that no short circuits exist between the serverboard and the chassis.
2. Verify that all jumpers are set to their default positions.
3. Check that the 115V/230V switch on the power supply is properly set.
4. Turn the power switch on and off to test the system.
5. The battery on your serverboard may be old. Check to verify that it still supplies ~3VDC. If it does not, replace it with a new one.

No Video

1. If the power is on but you have no video, remove all the add-on cards and cables.
2. Use the speaker to determine if any beep codes exist. Refer to Appendix A for details on beep codes.

NOTE

If you are a system integrator, VAR or OEM, a POST diagnostics card is recommended. For I/O port 80h codes, refer to App. B.

Memory Errors

1. Make sure that the DIMM modules are properly and fully installed.
2. You should be using registered ECC DDR-2 memory (see next page). Also, it is recommended that you use the same memory type and speed for all DIMMs in the system. See Section 2-4 for memory details and limitations.
3. Check for bad DIMM modules or slots by swapping modules between slots and noting the results.
4. Check the power supply voltage 115V/230V switch.

Losing the System's Setup Configuration

1. Make sure that you are using a high quality power supply. A poor quality power supply may cause the system to lose the CMOS setup information. Refer to Section 1-6 for details on recommended power supplies.
2. The battery on your serverboard may be old. Check to verify that it still supplies ~3VDC. If it does not, replace it with a new one.
3. If the above steps do not fix the setup configuration problem, contact your vendor for repairs.

3-2 Technical Support Procedures

Before contacting Technical Support, please take the following steps. Also, note that as a serverboard manufacturer, we do not sell directly to end-users, so it is best to first check with your distributor or reseller for troubleshooting services. They should know of any possible problem(s) with the specific system configuration that was sold to you.

1. Please review the 'Troubleshooting Procedures' and 'Frequently Asked Questions' (FAQs) sections in this chapter or see the FAQs on our web site before contacting Technical Support.
2. BIOS upgrades can be downloaded from our web site.

Note: Not all BIOS can be flashed depending on the modifications to the boot block code.

3. If you still cannot resolve the problem, include the following information when contacting us for technical support:

- Serverboard model and PCB revision number
- BIOS release date/version (this can be seen on the initial display when your system first boots up)
- System configuration

An example of a Technical Support form is posted on our web site.

4. Distributors: For immediate assistance, please have your account number ready when contacting our technical support department by e-mail.

3-3 Frequently Asked Questions

Question: What type of memory does my serverboard support?

Answer: The H8DM3-2/H8DMi-2 supports up to 64 GB of DDR2-667 or 32 GB of DDR2-533/400 registered ECC SDRAM with two CPUs installed. With only one CPU installed the maximum memory support is halved. Memory can be installed in interleaved or non-interleaved configurations. See Section 2-4 for details on installing memory.

Question: How do I update my BIOS?

Answer: It is recommended that you **not** upgrade your BIOS if you are not experiencing problems with your system. Updated BIOS files are located on our web site. Please check our BIOS warning message and the information on how to update your BIOS on our web site. Also, check the current BIOS revision and make sure it is newer than your current BIOS before downloading.

Select your mainboard model on the web page and download the corresponding BIOS file to your computer. Unzip the BIOS update file, in which you will find the readme.txt (flash instructions), the afudos.exe (BIOS flash utility) and the BIOS image (xxx.rom) files. Copy these files to a bootable floppy disk, insert the disk into drive A and reboot the system. At the DOS prompt after rebooting, enter the command "flash" (without quotation marks) then type in the BIOS file that you want to update with (xxxx.rom).

Question: What's on the CD that came with my serverboard?

Answer: The supplied compact disc has quite a few drivers and programs that will greatly enhance your system. We recommend that you review the CD and install the applications you need. Applications on the CD include chipset drivers for Windows and security and audio drivers.

Question: Why can't I turn off the power using the momentary power on/off switch?

Answer: The instant power off function is controlled in BIOS by the Power Button Mode setting. When the On/Off feature is enabled, the serverboard will have instant off capabilities as long as the BIOS has control of the system. When the Standby or Suspend feature is enabled or when the BIOS is not in control such as during memory count (the first screen that appears when the system is turned on), the momentary on/off switch must be held for more than four seconds to shut down the system. This feature is required to implement the ACPI features on the serverboard.

Question: How do I connect the ATA133 cable to my IDE device?

Answer: The 80-wire/40-pin high-density ATA133 IDE cable that came with your system is a special cable that must be used to take advantage of the speed the ATA133 technology offers. **Connect the blue connector to the onboard IDE header and the other connectors to your hard drives.** Consult the documentation that came with your disk drive for details on jumper locations and settings.

3-4 Returning Merchandise for Service

A receipt or copy of your invoice marked with the date of purchase is required before any warranty service will be rendered. You can obtain service by calling your vendor for a Returned Merchandise Authorization (RMA) number. When returning to the manufacturer, the RMA number should be prominently displayed on the outside of the shipping carton, and mailed prepaid or hand-carried. Shipping and handling charges will be applied for all orders that must be mailed when service is complete.

For faster service, RMA authorizations may be requested online (<http://www.supermicro.com/support/rma/>).

This warranty only covers normal consumer use and does not cover damages incurred in shipping or from failure due to the alteration, misuse, abuse or improper maintenance of products.

During the warranty period, contact your distributor first for any product problems.

Chapter 4

BIOS

4-1 Introduction

This chapter describes the AMIBIOS™ Setup utility for the H8DM3-2/H8DMi-2. The AMI ROM BIOS is stored in a flash chip and can be easily upgraded using a floppy disk-based program.

Note: Due to periodic changes to the BIOS, some settings may have been added or deleted and might not yet be recorded in this manual. Please refer to the Manual Download area of our web site for any changes to BIOS that may not be reflected in this manual.

Starting the Setup Utility

To enter the BIOS Setup Utility, hit the <Delete> key while the system is booting-up. (In most cases, the <Delete> key is used to invoke the BIOS setup screen. There are a few cases when other keys are used, such as <F1>, <F2>, etc.) Each main BIOS menu option is described in this manual.

The Main BIOS screen has two main frames. The left frame displays all the options that can be configured. “Grayed-out” options cannot be configured. The right frame displays the key legend. Above the key legend is an area reserved for a text message. When an option is selected in the left frame, it is highlighted in white. Often a text message will accompany it. (Note that BIOS has default text messages built in. We retain the option to include, omit, or change any of these text messages.) Settings printed in **Bold** are the default values.

A "▶" indicates a submenu. Highlighting such an item and pressing the <Enter> key will open the list of settings within that submenu.

The BIOS setup utility uses a key-based navigation system called hot keys. Most of these hot keys (<F1>, <F10>, <Enter>, <ESC>, <Arrow> keys, etc.) can be used at any time during the setup navigation process.

4-2 Main Menu

When you first enter AMI BIOS Setup Utility, you will see the Main Menu screen. You can always return to the Main Menu by selecting the **Main** tab on the top of the screen with the arrow keys.

The Main Menu screen provides you with a system overview, which includes the version, built date and ID of the AMIBIOS, the type, speed and number of the processors in the system and the amount of memory installed in the system.

System Time/System Date

You can edit this field to change the system time and date. Highlight *System Time* or *System Date* using the <Arrow> keys. Enter new values through the keyboard. Press the <Tab> key or the <Arrow> keys to move between fields. The date must be entered in DAY/MM/DD/YYYY format. The time is entered in HH:MM:SS format. Please note that time is in a 24-hour format. For example, 5:30 A.M. appears as 05:30:00 and 5:30 P.M. as 17:30:00.

4-3 Advanced Settings Menu

► Boot Features

Quick Boot

If Enabled, this option will skip certain tests during POST to reduce the time needed for the system to boot up. The options are **Enabled** and Disabled.

Quiet Boot

If **Disabled**, normal POST messages will be displayed on boot-up. If Enabled, this display the OEM logo instead of POST messages.

Add-On ROM Display Mode

Set this option to display add-on ROM (read-only memory) messages. The default setting is **Force BIOS**. Select Force BIOS to allow the computer system to force a third party BIOS to display during system boot. Select Keep Current to allow the computer system to display the BIOS information during system boot. The options are **Force BIOS** and Keep Current.

Boot up Num-Lock

Set this value to allow the Number Lock setting to be modified during boot up. The options are **On** and Off.

PS/2 Mouse Support

Set this value to modify support for a PS/2 mouse. The options are **Auto**, Enabled and Disabled.

Wait for 'F1' If Error

Select Enable to activate the Wait for F1 if Error function. The options are **Enabled** and Disabled.

Hit 'DEL' Message Display

Select Enabled to display message to hit the DEL key to enter Setup. The options are **Enabled** and Disabled.

Interrupt 19 Capture

Select Enabled to allow ROMs to trap Interrupt 19. The options are **Enabled** and Disabled.

OS Installation

Change this setting if using a 64-bit Linux operating system. The available options are **Other** and Linux.

ACPI Configuration

ACPI Version Features

Use this setting to determine which ACPI version to use. Options are **ACPI v1.0**, ACPI v2.0 and ACPI v3.0.

ACPI APIC Support

Determines whether to include the ACPI APIC table pointer in the RSDT pointer list. The available options are **Enabled** and Disabled.

AMI OEMB Table

Determines whether to include the AMI APIC table pointer in the RSDT pointer list. The available options are **Enabled** and Disabled.

Headless Mode

Use this setting to Enable or **Disable** headless operation mode through ACPI.

MCP55 ACPI HPET Table

Use this setting to either **Enable** or Disable the MCP55 ACPI HPET table.

Power Configuration

Power Button Mode

Allows the user to change the function of the power button. Options are **On/Off** and Suspend.

Restore on AC Power Loss

This setting allows you to choose how the system will react when power returns after an unexpected loss of power. The options are Power Off, Power On and **Last State**.

Watch Dog Timer

This setting is used to Enable or **Disable** the Watch Dog Timer function. It must be used in conjunction with the Watch Dog jumper (see Chapter 2 for details).

MPS Configuration

MPS Revision

This setting allows the user to select the MPS revision level. The options are 1.1 and **1.4**.

Smbios Configuration

Smbios Smi Support

This setting allows SMI wrapper support for PnP function 50h-54h. The options are **Enabled** and Disabled.

► CPU Configuration

The submenu lists CPU information and the following settings:

GART Error Reporting

This setting is used for testing only (setting should be **disabled**).

Microcode Update

This setting is used to **Enable** or Disable updating the microcode.

Secure Virtual Machine Mode

This setting is used to **Enable** or Disable SVM.

Power Now

This setting is used to Enable or **Disable** the AMD Power Now feature.

ACPI SRAT Table

This setting is used to **Enable** or Disable the building of the ACPI SRAT table.

Thermal Throttling

This setting is used to Enable or **Disable** Thermal Throttling.

CPU Page Translation Table

This setting is used to **Enable** or Disable the CPU Page Translation Table.

► Floppy/IDE/SATA Configuration

Floppy A

Move the cursor to these fields via up and down <arrow> keys to select the floppy type. The options are Disabled, 360 KB 5 1/4", 1.2 MB 5 1/4", 720 KB 3 1/2", **1.44 MB 3 1/2"**, and 2.88 MB 3 1/2".

Floppy B

Move the cursor to these fields via up and down <arrow> keys to select the floppy type. The options are **Disabled**, 360 KB 5 1/4", 1.2 MB 5 1/4", 720 KB 3 1/2", 1.44 MB 3 1/2", and 2.88 MB 3 1/2".

Onboard Floppy Controller

Use this setting to **Enable** or Disable the onboard floppy controller.

Onboard IDE Controller

There is a single floppy controller on the motherboard, which may be **Enabled** or Disabled with this setting.

Serial ATA Devices

This setting is used to determine if SATA drives will be used and how many. Options are Disabled, Device 0, Device 0/1 and **Device 0/1/2**.

nVidia RAID Function

This setting is used to Enable or **Disable** the nVidia ROM.

Primary IDE Master/Slave

Highlight one of the items above and press <Enter> to access the submenu for that item.

Type

Select the type of device connected to the system. The options are Not Installed, **Auto**, CDROM and ARMD.

LBA/Large Mode

LBA (Logical Block Addressing) is a method of addressing data on a disk drive. The options are Disabled and **Auto**.

Block (Multi-Sector Transfer)

Block mode boosts IDE drive performance by increasing the amount of data transferred. Only 512 bytes of data can be transferred per interrupt if block mode is not used. Block mode allows transfers of up to 64 KB per interrupt. Select "Disabled" to allow the data to be transferred from and to the device one sector at a time. Select "Auto" to allow the data transfer from and to the device occur multiple sectors at a time if the device supports it. The options are **Auto** and Disabled.

PIO Mode

PIO (Programmable I/O) mode programs timing cycles between the IDE drive and the programmable IDE controller. As the PIO mode increases, the cycle time decreases. The options are **Auto**, 0, 1, 2, 3, and 4. Select Auto to allow AMI BIOS to auto detect the PIO mode. Use this value if the IDE disk drive support cannot be determined. Select 0 to allow AMI BIOS to use PIO mode 0. It has a data transfer rate of 3.3 MBs. Select 1 to allow AMI BIOS to use PIO mode 1. It has a data transfer rate of 5.2 MBs. Select 2 to allow AMI BIOS to use PIO mode 2. It has a data transfer rate of 8.3 MBs. Select 3 to allow AMI BIOS to use PIO mode 3. It has a data transfer rate of 11.1 MBs. Select 4 to allow AMI BIOS to use PIO mode 4. It has a data transfer rate of 16.6 MBs. This setting generally works with all hard disk drives manufactured after 1999. For other disk drives, such as IDE CD-ROM drives, check the specifications of the drive.

DMA Mode

Selects the DMA Mode. Options are **Auto**, SWDMA0, SWDMA1, SWDMA2, MWDMA0, MDWDMA1, MWDMA2, UDMA0, UDMA1, UDMA2, UDMA3, UDMA4 and UDMA5. (SWDMA=Single Word DMA, MWDMA=Multi Word DMA, UDMA=UltraDMA.)

S.M.A.R.T.

Self-Monitoring Analysis and Reporting Technology (SMART) can help predict impending drive failures. Select "Auto" to allow BIOS to auto detect hard disk drive support. Select "Disabled" to prevent AMI BIOS from using the S.M.A.R.T. Select "Enabled" to allow AMI BIOS to use the S.M.A.R.T. to support hard drive disk. The options are Disabled, Enabled, and **Auto**.

32-Bit Data Transfer

Select "Enabled" to activate the function of 32-Bit data transfer. Select "Disabled" to deactivate the function. The options are Enabled and **Disabled**.

Serial ATA0/1/2 Primary/Secondary Channel

Highlight one of the items above and press <Enter> to access the submenu for that item. If a drive is present, information on that drive will be displayed here.

LBA/Large Mode

LBA (Logical Block Addressing) is a method of addressing data on a disk drive. The options are Disabled and **Auto**.

Block (Multi-Sector Transfer)

Block mode boosts IDE drive performance by increasing the amount of data transferred. Only 512 bytes of data can be transferred per interrupt if block mode is not used. Block mode allows transfers of up to 64 KB per interrupt. Select "Disabled" to allow the data to be transferred from and to the device one sector at a time. Select "Auto" to allow the data transfer from and to the device occur multiple sectors at a time if the device supports it. The options are **Auto** and Disabled.

PIO Mode

PIO (Programmable I/O) mode programs timing cycles between the IDE drive and the programmable IDE controller. As the PIO mode increases, the cycle time decreases. The options are **Auto**, 0, 1, 2, 3, and 4. Select Auto to allow AMI BIOS to auto detect the PIO mode. Use this value if the IDE disk drive support cannot be determined. Select 0 to allow AMI BIOS to use PIO mode 0. It has a data transfer rate of 3.3 MBs. Select 1 to allow AMI BIOS to use PIO mode 1. It has a data transfer rate of 5.2 MBs. Select 2 to allow AMI BIOS to use PIO mode 2. It has a data transfer rate of 8.3 MBs. Select 3 to allow AMI BIOS to use PIO mode 3. It has a data transfer rate of 11.1 MBs. Select 4 to allow AMI BIOS to use PIO mode 4. It has a data transfer rate of 16.6 MBs. This setting generally works with all hard disk drives manufactured after 1999. For other disk drives, such as IDE CD-ROM drives, check the specifications of the drive.

DMA Mode

Selects the DMA Mode. Options are **Auto**, SWDMA0, SWDMA1, SWDMA2, MWDMA0, MDWDMA1, MWDMA2, UDMA0, UDMA1, UDMA2, UDMA3, UDMA4 and UDMA5. (SWDMA=Single Word DMA, MWDMA=Multi Word DMA, UDMA=UltraDMA.)

S.M.A.R.T.

Self-Monitoring Analysis and Reporting Technology (SMART) can help predict impending drive failures. Select "Auto" to allow BIOS to auto detect hard disk drive support. Select "Disabled" to prevent AMI BIOS from using the S.M.A.R.T. Select "Enabled" to allow AMI BIOS to use the S.M.A.R.T. to support hard drive disk. The options are Disabled, Enabled, and **Auto**.

32-Bit Data Transfer

Select "Enabled" to activate the function of 32-Bit data transfer. Select "Disabled" to deactivate the function. The options are Enabled and **Disabled**.

Hard Disk Write Protect

Select Enabled to enable the function of Hard Disk Write Protect to prevent data from being written to HDD. The options are Enabled or **Disabled**.

IDE Detect Time Out (Sec)

This feature allows the user to set the time-out value for detecting ATA, ATA PI devices installed in the system. The options are 0 (sec), 5, 10, 15, 20, 25, 30 and 35.

ATA(PI) 80Pin Cable Detection

This setting allows AMI BIOS to auto-detect the 80-Pin ATA(PI) cable. The options are **Host & Device**, Host and Device.

▶ PCI/PnP Configuration

Clear NVRAM

Select Yes to clear NVRAM during boot-up. The options are Yes and **No**.

Plug & Play OS

Select Yes to allow the OS to configure Plug & Play devices. (This is not required for system boot if your system has an OS that supports Plug & Play.) Select **No** to allow AMIBIOS to configure all devices in the system.

PCI Latency Timer

This option sets the latency of all PCI devices on the PCI bus. Select a value to set the PCI latency in PCI clock cycles. Options are 32, **64**, 96, 128, 160, 192, 224 and 248.

Allocate IRQ to PCI VGA

Set this value to allow or restrict the system from giving the VGA adapter card an interrupt address. The options are **Yes** and No.

Palette Snooping

Select "Enabled" to inform the PCI devices that an ISA graphics device is installed in the system in order for the graphics card to function properly. The options are Enabled and **Disabled**.

PCI IDE BusMaster

Set this value to allow or prevent the use of PCI IDE busmastering. Select "Enabled" to allow AMI BIOS to use PCI busmaster for reading and writing to IDE drives. The options are **Disabled** and Enabled.

Offboard PCI/ISA IDE Card

This option allows the user to assign a PCI slot number to an Off-board PCI/ISA IDE card in order for it to function properly. The options are **Auto**, PCI Slot1, PCI Slot2, PCI Slot3, PCI Slot4, PCI Slot5, and PCI Slot6.

IRQ3/IRQ4/IRQ5/IRQ7/IRQ9/IRQ10/IRQ11/IRQ14/IRQ15

This feature specifies the availability of an IRQ to be used by a PCI/PnP device. Select Reserved for the IRQ to be used by a Legacy ISA device. The options are **Available** and Reserved.

DMA Channel 0/1/3/5/6/7

This feature specifies the availability of a DMA channel. The options are **Available** and Reserved.

Reserved Memory Size

This setting sets the size of the memory block to reserve for Legacy ISA devices. The options are **Disabled**, 16k, 32k and 64k.

Onboard SAS Controller

This setting is used to **Enable** or Disable the onboard SAS controller.

► Super IO Configuration

Serial Port1 Address

This option specifies the base I/O port address and Interrupt Request address of serial port 1. Select "Disabled" to prevent the serial port from accessing any system resources. When this option is set to *Disabled*, the serial port physically becomes unavailable. Select "3F8/IRQ4" to allow the serial port to use 3F8 as its I/O port address and IRQ 4 for the interrupt address. The options are Disabled, **3F8/IRQ4**, 3E8/IRQ4 and 2E8/IRQ3.

Serial Port2 Address

This option specifies the base I/O port address and Interrupt Request address of serial port 2. Select "Disabled" to prevent the serial port from accessing any system

resources. When this option is set to "Disabled", the serial port physically becomes unavailable. Select "2F8/IRQ3" to allow the serial port to use 2F8 as its I/O port address and IRQ 3 for the interrupt address. The options are Disabled, **2F8/IRQ3**, 3E8/IRQ4 and 2E8/IRQ3.

Serial Port 2 Mode

Tells BIOS which mode to select for serial port 2. The options are **Normal**, IrDA and ASKIR.

Parallel Port Address

This option specifies the I/O address used by the parallel port. Select Disabled to prevent the parallel port from accessing any system resources. When the value of this option is set to Disabled, the printer port becomes unavailable. Select **378** to allow the parallel port to use 378 as its I/O port address. The majority of parallel ports on computer systems use IRQ7 and I/O Port 378H as the standard setting. Select 278 to allow the parallel port to use 278 as its I/O port address. Select 3BC to allow the parallel port to use 3BC as its I/O port address.

Parallel Port Mode

Specify the parallel port mode. The options are **Normal**, Bi-directional, EPP and ECP.

Parallel Port IRQ

Select the IRQ (interrupt request) for the parallel port. The options are IRQ5 and **IRQ7**.

- ▶ **Chipset Configuration**
- ▶ **NorthBridge Configuration**
- ▶ **Memory Configuration**

Bank Interleaving

Select Auto to automatically enable a bank-interleaving memory scheme when this function is supported by the processor. The options are **Auto** and Disabled.

Channel Interleaving

Selects the channel-interleaving memory scheme when this function is supported by the processor. The options are Disabled, Address Bits 6, Address Bits 12, **XOR of Address Bits [20:16, 6]** and XOR of Address Bits [20:16, 9].

Enable Clock to All Dimms

Use this setting to enable unused clocks to all DIMMSs, even if some DIMM slots are unpopulated. Options are Enabled and **Disabled**.

Mem Clk Tristate C3/ALTVID

Use this setting to Enable or **Disable** memory clock tristate during C3 and ALT VID.

Memory Hole Remapping

When "Enabled", this feature enables hardware memory remapping around the memory hole. Options are **Enabled** and Disabled.

CS Sparing

This setting will reserve a spare memory rank in each node when enabled. Options are Enable and **Disable**.

DCT Unganged Mode

This setting enables unganged DRAM mode (64-bit). Options are Auto (ganged mode) and **Always** (unganged mode).

Power Down Enable

This setting enables or disables DDR power down mode. Options are **Enabled** and Disabled.

Power Down Mode

This sets the power down mode. Options are **Channel** and Chip Select.

▶ **ECC Configuration**

DRAM ECC Enable

DRAM ECC allows hardware to report and correct memory errors automatically. Options are **Enabled** and Disabled.

DRAM Scrub Redirect

Allows system to correct DRAM ECC errors immediately, even with background scrubbing on. Options are Enabled and **Disabled**.

4-Bit ECC Mode

Allows the user to enable 4-bit ECC mode (also known as ECC Chipkill). Options are Enabled and **Disabled**.

DRAM BG Scrub

Corrects memory errors so later reads are correct. Options are **Disabled** and various times in nanoseconds and microseconds.

L2 Cache BG Scrub

Allows L2 cache RAM to be corrected when idle. Options are **Disabled** and various times in nanoseconds and microseconds.

L3 Cache BG Scrub

Allows L3 cache RAM to be corrected when idle. Options are **Disabled** and various times in nanoseconds and microseconds.

DRAM Timing Configuration Memory Clock Mode

This setting specifies the memory clock mode. Options are **Auto**, Limit and Manual.

DRAM Timing Mode

This setting specifies the DRAM timing mode. Options are **Auto**, DCT0, DCT1 and Both.

Power Down Control

Allows DIMMs to enter power down mode by deasserting the clock enable signal when DIMMs are not in use. Options are **Auto** and Disabled.

Alternate VID

Specify the alternate VID while in low power states. Options are **Auto** and various voltages from .800V to 1.050V in increments of .025V.

► **SouthBridge Configuration**

CPU/LDT Spread Spectrum

Enables spread spectrum for the CPU/LDT. Options are **Center Spread**, Down Spread or Disabled.

PCIE Spread Spectrum

Allows you to **Enable** or Disable spread spectrum for PCI-Express..

SATA Spread Spectrum

Enables spread spectrum for the SATA. Options are **Enabled** and Disabled.

Primary Graphics Adapter

Options are **PCI Express --> PCI** and **PCI --> PCI Express**.

USB 1.1 Controller

Enable or disable the USB 1.1 controller.

USB 2.0 Controller

Enable or disable the USB 2.0 controller.

MAC0 LAN0

Settings are **Auto** and Disabled for MAC0 LAN0.

MAC1 LAN1

Settings are **Auto** and Disabled for MAC1 LAN1.

Legacy USB Support

Select "Enabled" to enable the support for USB Legacy. Disable Legacy support if there are no USB devices installed in the system. "Auto" disabled Legacy support if no USB devices are connected. The options are Disabled, **Enabled** and Auto.

USB 2.0 Controller Mode

Select the controller mode for your USB ports. Options are **HiSpeed** and **FullSpeed**. (HiSpeed=480 Mbps, FullSpeed=12 Mbps).

BIOS EHCI Hand-Off

Enable or **Disable** a workaround for OS's without EHCI hand-off support.

► Event Log Configuration

View Event Log

Highlight this item and press <Enter> to view the contents of the event log.

Mark All Events as Read

Highlight this item and press <Enter> to mark all events as read.

Clear Event Log

Select **Yes** and press <Enter> to clear all event logs. The options are **Yes** and **No** to verify.

► PCI Express Configuration

Active State Power Management

Used to **Enable** or **Disable** the PCI-Express L0 and L1 link power states.

► Remote Access Configuration

Remote Access

Allows you to **Enable** or **Disable** remote access. If enabled, the settings below will appear.

Serial Port Number

Selects the serial port to use for console redirection. Options are **COM1** and **COM2**.

Serial Port Mode

Selects the serial port settings to use. Options are **(115200 8, n, 1)**, (57600 8, n, 1), (38400 8, n, 1), (19200 8, n, 1) and (09600 8, n, 1).

Flow Control

Selects the flow control to be used for console redirection. Options are **None**, **Hardware** and **Software**.

Redirection After BIOS POST

Options are Disable (no redirection after BIOS POST), Boot Loader (redirection during POST and during boot loader) and **Always** (redirection always active). Note that some OS's may not work with this set to Always.

Terminal Type

Selects the type of the target terminal. Options are **ANSI**, VT100 and VT-UTF8.

VT-UTF8 Combo Key Support

Allows you to **Enable** or Disable VT-UTF8 combination key support for ANSI/VT100 terminals.

Sredir Memory Display Delay

Use this setting to set the delay in seconds to display memory information. Options are **No Delay**, 1 sec, 2 secs and 4 secs.

► System Health Monitor

CPU Overheat Alarm

Use the "+" and "-" keys to set the CPU temperature threshold to between 65° and 90° C. When this threshold is exceeded, the overheat LED on the chassis will light up and an alarm will sound. The LED and alarm will turn off once the CPU temperature has dropped to 5 degrees below the threshold set. The default setting is **72° C**.

The submenu includes monitor displays for the following information:

CPU1 Temperature, CPU2 Temperature (for dual CPU systems), System Temperature, VCore1, VCore2 (for dual CPU systems), 3.3V, +5Vin, +12Vin, 5V stby and battery voltage.

► System Fan Monitor

Fan Speed Control Modes

This feature allows the user to determine how the system will control the speed of the onboard fans. Select "Workstation" if your system is used as a Workstation. Select "Server" if your system is used as a Server. Select "Disable" to disable the fan speed control function to allow the onboard fans to continuously run at full speed (12V). The options are **1) Disabled (Full Speed)** 2) Server Mode and 3) Workstation Mode.

FAN1 Speed through FAN8 Reading

The speeds of the onboard fans (in rpm) are displayed here.

4-4 Boot Menu

This feature allows the user to configure the following items:

▶ Boot Device Priority

This feature allows the user to prioritize the boot sequence from the available devices.

▶ Removable Drives

This feature allows the user to specify the Boot sequence from available removable drives.

4-5 Security Menu

AMI BIOS provides a Supervisor and a User password. If you use both passwords, the Supervisor password must be set first.

Change Supervisor Password

Select this option and press <Enter> to access the sub menu, and then type in the password.

Change User Password

Select this option and press <Enter> to access the sub menu, and then type in the password.

Boot Sector Virus Protection

This option is near the bottom of the Security Setup screen. Select "Disabled" to deactivate the Boot Sector Virus Protection. Select "Enabled" to enable boot sector protection. When "Enabled", AMI BIOS displays a warning when any program (or virus) issues a Disk Format command or attempts to write to the boot sector of the hard disk drive. The options are Enabled and **Disabled**.

4-6 Exit Menu

Select the Exit tab from AMI BIOS Setup Utility screen to enter the Exit BIOS Setup screen.

Save Changes and Exit

When you have completed the system configuration changes, select this option to leave BIOS Setup and reboot the computer, so the new system configuration parameters can take effect. Select Save Changes and Exit from the Exit menu and press <Enter>.

Discard Changes and Exit

Select this option to quit BIOS Setup without making any permanent changes to the system configuration and reboot the computer. Select Discard Changes and Exit from the Exit menu and press <Enter>.

Discard Changes

Select this option and press <Enter> to discard all the changes and return to AMI BIOS Utility Program.

Load Optimal Defaults

To set this feature, select Load Optimal Defaults from the Exit menu and press <Enter>. Then Select "OK" to allow BIOS to automatically load the Optimal Defaults as the BIOS Settings. The Optimal settings are designed for maximum system performance, but may not work best for all computer applications.

Load Fail-Safe Defaults

To set this feature, select Load Fail-Safe Defaults from the Exit menu and press <Enter>. The Fail-Safe settings are designed for maximum system stability, but not maximum performance.

Appendix A

BIOS Error Beep Codes

During the POST (Power-On Self-Test) routines, which are performed each time the system is powered on, errors may occur.

Non-fatal errors are those which, in most cases, allow the system to continue the boot-up process. The error messages normally appear on the screen.

Fatal errors are those which will not allow the system to continue the boot-up procedure. If a fatal error occurs, you should consult with your system manufacturer for possible repairs.

These fatal errors are usually communicated through a series of audible beeps. The numbers on the fatal error list, on the following page, correspond to the number of beeps for the corresponding error. All errors listed, with the exception of Beep Code 8, are fatal errors.

POST codes may be read on the debug LEDs located beside the LAN port on the serverboard backplane. See the description of the Debug LEDs (LED1 and LED2) in Chapter 5.

A-1 AMIBIOS Error Beep Codes

Beep Code	Error Message	Description
1 beep	Refresh	Circuits have been reset. (Ready to power up.)
5 short, 1 long	Memory error	No memory detected in system
8 beeps	Display memory read/write error	Video adapter missing or with faulty memory

Notes

Appendix B

BIOS POST Checkpoint Codes

When AMIBIOS performs the Power On Self Test, it writes checkpoint codes to I/O port 0080h. If the computer cannot complete the boot process, diagnostic equipment can be attached to the computer to read I/O port 0080h.

B-1 Uncompressed Initialization Codes

The uncompressed initialization checkpoint codes are listed in order of execution:

Checkpoint	Code Description
D0h	The NMI is disabled. Power on delay is starting. Next, the initialization code checksum will be verified.
D1h	Initializing the DMA controller, performing the keyboard controller BAT test, starting memory refresh and entering 4 GB flat mode next.
D3h	Starting memory sizing next.
D4h	Returning to real mode. Executing any OEM patches and setting the Stack next.
D5h	Passing control to the uncompressed code in shadow RAM at E000:0000h. The initialization code is copied to segment 0 and control will be transferred to segment 0.

B-2 Bootblock Recovery Codes

The bootblock recovery checkpoint codes are listed in order of execution:

Checkpoint	Code Description
E0h	The onboard floppy controller if available is initialized. Next, beginning the base 512 KB memory test.
E1h	Initializing the interrupt vector table next.
E2h	Initializing the DMA and Interrupt controllers next.
E6h	Enabling the floppy drive controller and Timer IRQs. Enabling internal cache memory.
Edh	Initializing the floppy drive.
Eeh	Looking for a floppy diskette in drive A:.. Reading the first sector of the diskette.
Efh	A read error occurred while reading the floppy drive in drive A:..
F0h	Next, searching for the AMIBOOT.ROM file in the root directory.
F1h	The AMIBOOT.ROM file is not in the root directory.
F2h	Next, reading and analyzing the floppy diskette FAT to find the clusters occupied by the AMIBOOT.ROM file.
F3h	Next, reading the AMIBOOT.ROM file, cluster by cluster.
F4h	The AMIBOOT.ROM file is not the correct size.
F5h	Next, disabling internal cache memory.
FBh	Next, detecting the type of flash ROM.
FCh	Next, erasing the flash ROM.
FDh	Next, programming the flash ROM.
FFh	Flash ROM programming was successful. Next, restarting the system BIOS.

B-3 Uncompressed Initialization Codes

The following runtime checkpoint codes are listed in order of execution.

These codes are uncompressed in F0000h shadow RAM.

Checkpoint	Code Description
03h	The NMI is disabled. Next, checking for a soft reset or a power on condition.
05h	The BIOS stack has been built. Next, disabling cache memory.
06h	Uncompressing the POST code next.
07h	Next, initializing the CPU and the CPU data area.
08h	The CMOS checksum calculation is done next.
0Ah	The CMOS checksum calculation is done. Initializing the CMOS status register for date and time next.
0Bh	The CMOS status register is initialized. Next, performing any required initialization before the keyboard BAT command is issued.
0Ch	The keyboard controller input buffer is free. Next, issuing the BAT command to the keyboard controller.
0Eh	The keyboard controller BAT command result has been verified. Next, performing any necessary initialization after the keyboard controller BAT command test.
0Fh	The initialization after the keyboard controller BAT command test is done. The keyboard command byte is written next.
10h	The keyboard controller command byte is written. Next, issuing the Pin 23 and 24 blocking and unblocking command.
11h	Next, checking if <End or <Ins> keys were pressed during power on. Initializing CMOS RAM if the Initialize CMOS RAM in every boot AMIBIOS POST option was set in AMIBCP or the <End> key was pressed.
12h	Next, disabling DMA controllers 1 and 2 and interrupt controllers 1 and 2.
13h	The video display has been disabled. Port B has been initialized. Next, initializing the chipset.
14h	The 8254 timer test will begin next.
19h	Next, programming the flash ROM.
1Ah	The memory refresh line is toggling. Checking the 15 second on/off time next.
2Bh	Passing control to the video ROM to perform any required configuration before the video ROM test.
2Ch	All necessary processing before passing control to the video ROM is done. Looking for the video ROM next and passing control to it.
2Dh	The video ROM has returned control to BIOS POST. Performing any required processing after the video ROM had control
23h	Reading the 8042 input port and disabling the MEGAKEY Green PC feature next. Making the BIOS code segment writable and performing any necessary configuration before initializing the interrupt vectors.
24h	The configuration required before interrupt vector initialization has completed. Interrupt vector initialization is about to begin.

Checkpoint	Code Description
25h	Interrupt vector initialization is done. Clearing the password if the POST DIAG switch is on.
27h	Any initialization before setting video mode will be done next.
28h	Initialization before setting the video mode is complete. Configuring the monochrome mode and color mode settings next.
2Ah	Bus initialization system, static, output devices will be done next, if present. See the last page for additional information.
2Eh	Completed post-video ROM test processing. If the EGA/VGA controller is not found, performing the display memory read/write test next.
2Fh	The EGA/VGA controller was not found. The display memory read/write test is about to begin.
30h	The display memory read/write test passed. Look for retrace checking next.
31h	The display memory read/write test or retrace checking failed. Performing the alternate display memory read/write test next.
32h	The alternate display memory read/write test passed. Looking for alternate display retrace checking next.
34h	Video display checking is over. Setting the display mode next.
37h	The display mode is set. Displaying the power on message next.
38h	Initializing the bus input, IPL, general devices next, if present. See the last page of this chapter for additional information.
39h	Displaying bus initialization error messages. See the last page of this chapter for additional information.
3Ah	The new cursor position has been read and saved. Displaying the Hit message next.
3Bh	The Hit message is displayed. The protected mode memory test is about to start.
40h	Preparing the descriptor tables next.
42h	The descriptor tables are prepared. Entering protected mode for the memory test next.
43h	Entered protected mode. Enabling interrupts for diagnostics mode next.
44h	Interrupts enabled if the diagnostics switch is on. Initializing data to check memory wraparound at 0:0 next.
45h	Data initialized. Checking for memory wraparound at 0:0 and finding the total system memory size next.
46h	The memory wraparound test is done. Memory size calculation has been done. Writing patterns to test memory next.
47h	The memory pattern has been written to extended memory. Writing patterns to the base 640 KB memory next.
48h	Patterns written in base memory. Determining the amount of memory below 1 MB next.
49h	The amount of memory below 1 MB has been found and verified.
4Bh	The amount of memory above 1 MB has been found and verified. Checking for a soft reset and clearing the memory below 1 MB for the soft reset next. If this is a power on situation, going to checkpoint 4Eh next.

Checkpoint	Code Description
4Ch	The memory below 1 MB has been cleared via a soft reset. Clearing the memory above 1 MB next.
4Dh	The memory above 1 MB has been cleared via a soft reset. Saving the memory size next. Going to checkpoint 52h next.
4Eh	The memory test started, but not as the result of a soft reset. Displaying the first 64 KB memory size next.
4Fh	The memory size display has started. The display is updated during the memory test. Performing the sequential and random memory test next.
50h	The memory below 1 MB has been tested and initialized. Adjusting the displayed memory size for relocation and shadowing next.
51h	The memory size display was adjusted for relocation and shadowing.
52h	The memory above 1 MB has been tested and initialized. Saving the memory size information next.
53h	The memory size information and the CPU registers are saved. Entering real mode next.
54h	Shutdown was successful. The CPU is in real mode. Disabling the Gate A20 line, parity, and the NMI next.
57h	The A20 address line, parity, and the NMI are disabled. Adjusting the memory size depending on relocation and shadowing next.
58h	The memory size was adjusted for relocation and shadowing. Clearing the Hit message next.
59h	The Hit message is cleared. The <WAIT...> message is displayed. Starting the DMA and interrupt controller test next.
60h	The DMA page register test passed. Performing the DMA Controller 1 base register test next.
62h	The DMA controller 1 base register test passed. Performing the DMA controller 2 base register test next.
65h	The DMA controller 2 base register test passed. Programming DMA controllers 1 and 2 next.
66h	Completed programming DMA controllers 1 and 2. Initializing the 8259 interrupt controller next.
67h	Completed 8259 interrupt controller initialization.
7Fh	Extended NMI source enabling is in progress.
80h	The keyboard test has started. Clearing the output buffer and checking for stuck keys. Issuing the keyboard reset command next.
81h	A keyboard reset error or stuck key was found. Issuing the keyboard controller interface test command next.
82h	The keyboard controller interface test completed. Writing the command byte and initializing the circular buffer next.
83h	The command byte was written and global data initialization has completed. Checking for a locked key next.
84h	Locked key checking is over. Checking for a memory size mismatch with CMOS RAM data next.
85h	The memory size check is done. Displaying a soft error and checking for a password or bypassing WINBIOS Setup next.

Checkpoint	Code Description
86h	The password was checked. Performing any required programming before WINBIOS Setup next.
87h	The programming before WINBIOS Setup has completed. Uncompressing the WINBIOS Setup code and executing the AMIBIOS Setup or WINBIOS Setup utility next.
88h	Returned from WINBIOS Setup and cleared the screen. Performing any necessary programming after WINBIOS Setup next.
89h	The programming after WINBIOS Setup has completed. Displaying the power on screen message next.
8Ch	Programming the WINBIOS Setup options next.
8Dh	The WINBIOS Setup options are programmed. Resetting the hard disk controller next.
8Fh	The hard disk controller has been reset. Configuring the floppy drive controller next.
91h	The floppy drive controller has been configured. Configuring the hard disk drive controller next.
95h	Initializing the bus option ROMs from C800 next. See the last page of this chapter for additional information.
96h	Initializing before passing control to the adaptor ROM at C800.
97h	Initialization before the C800 adaptor ROM gains control has completed. The adaptor ROM check is next.
98h	The adaptor ROM had control and has now returned control to BIOS POST. Performing any required processing after the option ROM returned control.
99h	Any initialization required after the option ROM test has completed. Configuring the timer data area and printer base address next.
9Ah	Set the timer and printer base addresses. Setting the RS-232 base address next.
9Bh	Returned after setting the RS-232 base address. Performing any required initialization before the Coprocessor test next.
9Ch	Required initialization before the Coprocessor test is over. Initializing the Coprocessor next.
9Dh	Coprocessor initialized. Performing any required initialization after the Coprocessor test next.
9Eh	Initialization after the Coprocessor test is complete. Checking the extended keyboard, keyboard ID, and Num Lock key next. Issuing the keyboard ID command next.
A2h	Displaying any soft errors next.
A3h	The soft error display has completed. Setting the keyboard typematic rate next.
A4h	The keyboard typematic rate is set. Programming the memory wait states next.
A5h	Memory wait state programming is over. Clearing the screen and enabling parity and the NMI next.
A7h	NMI and parity enabled. Performing any initialization required before passing control to the adaptor ROM at E000 next.
A8h	Initialization before passing control to the adaptor ROM at E000h completed. Passing control to the adaptor ROM at E000h next.

Checkpoint	Code Description
A9h	Returned from adaptor ROM at E000h control. Performing any initialization required after the E000 option ROM had control next.
Aah	Initialization after E000 option ROM control has completed. Displaying the system configuration next.
Abh	Uncompressing the DMI data and executing DMI POST initialization next.
B0h	The system configuration is displayed.
B1h	Copying any code to specific areas.
00h	Code copying to specific areas is done. Passing control to INT 19h boot loader next.

Notes