

**SUPER**  <sup>®</sup>

C7Q67-H

**USER'S MANUAL**

Revision 1.0

---

The information in this User's Manual has been carefully reviewed and is believed to be accurate. The vendor assumes no responsibility for any inaccuracies that may be contained in this document, makes no commitment to update or to keep current the information in this manual, or to notify any person or organization of the updates. **Please Note: For the most up-to-date version of this manual, please see our web site at [www.supermicro.com](http://www.supermicro.com).**

Super Micro Computer, Inc. ("Supermicro") reserves the right to make changes to the product described in this manual at any time and without notice. This product, including software and documentation, is the property of Supermicro and/or its licensors, and is supplied only under a license. Any use or reproduction of this product is not allowed, except as expressly permitted by the terms of said license.

IN NO EVENT WILL SUPER MICRO COMPUTER, INC. BE LIABLE FOR DIRECT, INDIRECT, SPECIAL, INCIDENTAL, SPECULATIVE OR CONSEQUENTIAL DAMAGES ARISING FROM THE USE OR INABILITY TO USE THIS PRODUCT OR DOCUMENTATION, EVEN IF ADVISED OF THE POSSIBILITY OF SUCH DAMAGES. IN PARTICULAR, SUPER MICRO COMPUTER, INC. SHALL NOT HAVE LIABILITY FOR ANY HARDWARE, SOFTWARE, OR DATA STORED OR USED WITH THE PRODUCT, INCLUDING THE COSTS OF REPAIRING, REPLACING, INTEGRATING, INSTALLING OR RECOVERING SUCH HARDWARE, SOFTWARE, OR DATA.

Any disputes arising between manufacturer and customer shall be governed by the laws of Santa Clara County in the State of California, USA. The State of California, County of Santa Clara shall be the exclusive venue for the resolution of any such disputes. Supermicro's total liability for all claims will not exceed the price paid for the hardware product.

FCC Statement: This equipment has been tested and found to comply with the limits for a Class B digital device pursuant to Part 15 of the FCC Rules. These limits are designed to provide reasonable protection against harmful interference in a residential installation. This equipment generates, uses, and can radiate radio frequency energy and, if not installed and used in accordance with the manufacturer's instruction manual, may cause interference with radio communications. However, there is no guarantee that interference will not occur in a particular installation. If this equipment does cause harmful interference to radio or television reception, which can be determined by turning the equipment off and on, you are encouraged to try to correct the interference by one or more of the following measures:

- Reorient or relocate the receiving antenna.
- Increase the separation between the equipment and the receiver.
- Connect the equipment into an outlet on a circuit different from that to which the receiver is connected.
- Consult the dealer or an experienced radio/television technician for help.

California Best Management Practices Regulations for Perchlorate Materials: This Perchlorate warning applies only to products containing CR (Manganese Dioxide) Lithium coin cells. "Perchlorate Material-special handling may apply. See [www.dtsc.ca.gov/hazardouswaste/perchlorate](http://www.dtsc.ca.gov/hazardouswaste/perchlorate)".

**WARNING: Handling of lead solder materials used in this product may expose you to lead, a chemical known to the State of California to cause birth defects and other reproductive harm.**

---

Manual Revision 1.0

Release Date: March 19, 2012

Unless you request and receive written permission from Super Micro Computer, Inc., you may not copy any part of this document. Information in this document is subject to change without notice. Other products and companies referred to herein are trademarks or registered trademarks of their respective companies or mark holders.

Copyright © 2012 by Super Micro Computer, Inc. All rights reserved.

**Printed in the United States of America**

## Preface

This manual is written for system integrators, PC technicians and knowledgeable PC users. It provides information for the installation and use of the **SUPER** C7Q67-H motherboard.

### About This Motherboard

The **SUPER** C7Q67-H supports a single 2nd generation Intel® Core™ i7/i5/i3 DT processor in an LGA 1155 socket. With the Intel® Q67 Express chipset built in, the C7Q67-H motherboard offers substantial enhancement in system performance and storage capability for high performance system platforms in a sleek package. Please refer to our website (<http://www.supermicro.com/products/>) for processor and memory support updates. This product is intended to be installed and serviced by professional technicians.

### Manual Organization

**Chapter 1** describes the features, specifications and performance of the motherboard, and provides detailed information on the Intel Q67 Express chipset.

**Chapter 2** provides hardware installation instructions. Read this chapter when installing the processor, memory modules and other hardware components into the system. If you encounter any problems, see **Chapter 3**, which describes troubleshooting procedures for video, memory and system setup stored in the CMOS.

**Chapter 4** includes an introduction to the BIOS, and provides detailed information on running the CMOS Setup utility.

**Appendix A** provides BIOS Error Beep Codes.

**Appendix B** lists software program installation instructions.

**Appendix C** contains UEFI BIOS Recovery instructions.

## Conventions Used in the Manual:

Special attention should be given to the following symbols for proper installation and to prevent damage done to the components or injury to yourself:



**Danger/ Caution:** Instructions to be strictly followed to prevent catastrophic system failure or to avoid bodily injury



**Warning:** Critical information to prevent damage to the components or data loss.



**Important:** Important information given to ensure proper system installation or to relay safety precautions.



**Note:** Additional Information given to differentiate various models or provides information for correct system setup.

## Contacting Supermicro

### Headquarters

Address: Super Micro Computer, Inc.  
980 Rock Ave.  
San Jose, CA 95131 U.S.A.

Tel: +1 (408) 503-8000

Fax: +1 (408) 503-8008

Email: marketing@supermicro.com (General Information)  
support@supermicro.com (Technical Support)

Web Site: www.supermicro.com

### Europe

Address: Super Micro Computer B.V.  
Het Sterrenbeeld 28, 5215 ML  
's-Hertogenbosch, The Netherlands

Tel: +31 (0) 73-6400390

Fax: +31 (0) 73-6416525

Email: sales@supermicro.nl (General Information)  
support@supermicro.nl (Technical Support)  
rma@supermicro.nl (Customer Support)

### Asia-Pacific

Address: Super Micro Computer, Inc.  
4F, No. 232-1, Liancheng Rd.  
Chung-Ho 235, Taipei County  
Taiwan, R.O.C.

Tel: +886-(2) 8226-3990

Fax: +886-(2) 8226-3991

Web Site: www.supermicro.com.tw

Technical Support:

Email: support@supermicro.com.tw

Tel: +886-(2) 8226-5990

# Table of Contents

## **Preface**

About This Motherboard.....	iii
Manual Organization .....	iii
Conventions Used in the Manual:.....	iv
Contacting Supermicro.....	v

## **Chapter 1**

### **Introduction**

1-1 Overview .....	1-1
Checklist.....	1-1
Motherboard Features.....	1-6
1-2 Chipset Overview .....	1-9
Intel Q67 Express Chipset Features.....	1-9
1-3 Special Features .....	1-10
Recovery from AC Power Loss.....	1-10
1-4 PC Health Monitoring.....	1-10
Fan Status Monitor with Firmware Control .....	1-10
Environmental Temperature Control .....	1-10
System Resource Alert .....	1-10
1-5 ACPI Features.....	1-11
Slow Blinking LED for Suspend-State Indicator .....	1-11
1-6 Power Supply.....	1-11
1-7 Super I/O.....	1-12

## **Chapter 2**

### **Installation**

2-1 Static-Sensitive Devices.....	2-1
Precautions .....	2-1
Unpacking .....	2-1
2-2 Processor and Heatsink Installation.....	2-2
Installing the LGA1155 Processor .....	2-2
Installing an Active CPU Heatsink with Fan .....	2-5
Removing the Heatsink.....	2-7
2-3 Installing DDR3 Memory.....	2-8
DIMM Installation .....	2-8
Removing Memory Modules .....	2-8
Memory Support.....	2-9

---

---

	Memory Population Guidelines .....	2-9
2-4	Motherboard Installation.....	2-11
	Tools Needed .....	2-11
	Location of Mounting Holes .....	2-11
	Installing the Motherboard .....	2-12
2-5	Connectors/IO Ports.....	2-13
	Backplane I/O Panel .....	2-13
	ATX PS/2 Keyboard/Mouse Ports .....	2-14
	Universal Serial Bus (USB).....	2-15
	Ethernet Ports .....	2-16
	Back Panel High Definition Audio (HD Audio) .....	2-16
	Front Accessible Audio Header.....	2-17
	HDMI Port.....	2-18
	VGA Port .....	2-18
	Serial Port (COM1).....	2-18
	Front Control Panel.....	2-19
	Front Control Panel Pin Definitions.....	2-20
	Power LED .....	2-20
	HDD LED.....	2-20
	NIC1/NIC2 (LAN1/LAN2).....	2-21
	Overheat (OH)/Fan Fail.....	2-21
	Reset Button .....	2-22
	Power Button .....	2-22
2-6	Connecting Cables.....	2-23
	ATX Main PWR & CPU PWR Connectors (JPW1 & JPW2) .....	2-23
	Fan Headers (Fan 1 ~ Fan 4).....	2-24
	Chassis Intrusion (JL1) .....	2-24
	Internal Buzzer (SP1).....	2-25
	Speaker (JD1) .....	2-25
	Onboard Power LED (JLED).....	2-26
	Serial Ports (COM1 ~ COM4).....	2-26
	DOM PWR Connector (JSD1).....	2-27
	Wake-On-LAN (JWOL).....	2-27
	Wake-On-Ring (JWOR).....	2-28
	SPDIF IN / SPDIF OUT (JSPDIF_IN/JSPDIF_OUT) .....	2-28
2-7	Jumper Settings .....	2-29
	Explanation of Jumpers .....	2-29
	LAN Port Enable/Disable (JPL2).....	2-29

---

	CMOS Clear (JBT1).....	2-30
	PCI Slot SMB Enable (I <sup>2</sup> C1/I <sup>2</sup> C2).....	2-30
	ME Recovery Enable (JPME1) .....	2-31
	HD FP Audio/AC' 97 FP Audio Select (JHD AC1).....	2-31
	Audio Enable (JPAC1).....	2-32
2-8	Onboard Indicators.....	2-33
	LAN 1/LAN 2 LEDs .....	2-33
	Onboard Power LED (LED1) .....	2-33
2-9	SATA Connections.....	2-34
	SATA Connections (I-SATA0~I-SATA5).....	2-34

### **Chapter 3**

#### **Troubleshooting**

3-1	Troubleshooting Procedures .....	3-1
	Before Power On .....	3-1
	No Power .....	3-1
	No Video .....	3-2
	Memory Errors .....	3-2
	Losing the System's Setup Configuration.....	3-2
3-2	Technical Support Procedures.....	3-2
3-3	Frequently Asked Questions.....	3-3
3-4	Battery Removal and Installation.....	3-5
	Battery Removal.....	3-5
	Proper Battery Disposal.....	3-5
3-5	Returning Merchandise for Service.....	3-6
	Battery Installation.....	3-6

### **Chapter 4**

#### **BIOS**

4-1	Introduction.....	4-1
	Starting BIOS Setup Utility.....	4-1
	How To Change the Configuration Data .....	4-1
	How to Start the Setup Utility .....	4-2
4-2	Main Setup.....	4-2
	System Overview .....	4-3
	System Time/System Date .....	4-3
	Supermicro C7Q67-H.....	4-3
	BIOS Version.....	4-3
	ME Firmware Version.....	4-3

	Build Date.....	4-3
	Processor .....	4-3
	Type of Processor .....	4-3
	Speed .....	4-3
	Physical Count .....	4-3
	Logical Count .....	4-3
	System Memory .....	4-3
	Size.....	4-3
4-3	Advanced Setup Configurations.....	4-4
	▶ Boot Feature.....	4-4
	Quiet Boot .....	4-4
	AddOn ROM Display Mode.....	4-4
	Bootup Num-Lock.....	4-4
	Wait For 'F1' If Error.....	4-4
	Interrupt 19 Capture .....	4-4
	▶ Power Configuration.....	4-5
	Power Button Function.....	4-5
	Restore on AC Power Loss.....	4-5
	Resume on RTC Alarm .....	4-5
	▶ Processor & Clock Options .....	4-5
	Clock Spread Spectrum .....	4-5
	Hardware Prefetcher .....	4-5
	Adjacent Cache Line Prefetch .....	4-6
	Intel® Virtualization Technology .....	4-6
	Execute-Disable Bit Capability .....	4-6
	Intel® Hyper Threading Technology.....	4-6
	Active Processor Cores.....	4-6
	Power Technology .....	4-6
	▶ Turbo Boost Technology	
	Factory Long Duration Power Limit.....	4-7
	Long Duration Power Limit.....	4-7
	Factory Long Duration Maintained .....	4-7
	Long Duration Maintained .....	4-7
	Recommended Short Duration Power Limit.....	4-8
	Short duration power limit .....	4-8
	Chipset Configuration.....	4-8
	Memory Frequency .....	4-8
	VT-d.....	4-8

PCI Express Port.....	4-9
PEG Force Gen1.....	4-9
Detect Non-Compliant Device.....	4-9
Initiate Graphics Adapter.....	4-9
IGD Memory.....	4-9
Render Standby.....	4-9
IGD Multi-Monitor.....	4-9
GbE Controller.....	4-9
Wake on LAN from S5.....	4-10
Legacy USB Support.....	4-10
Port 60/64 Emulation.....	4-10
BIOS EHCI Hand-Off.....	4-10
Azalia HD Audio.....	4-10
Azalia Internal HDMI Codec.....	4-10
Frontside Audio Mode.....	4-10
PCH IO Port 80 Decoding.....	4-11
Deep Sx.....	4-11
ASMedia 1061 SATA Controller.....	4-11
ASMedia XHCI Controller.....	4-11
Spread Spectrum Clocking.....	4-11
Port A / Port B Battery Charge.....	4-11
USB 3.0 Legacy Support.....	4-11
XHCI Hand-off.....	4-11
Port 0 ~ Port 5.....	4-12
Read Pacing.....	4-12
▶ IDE/SATA Configuration.....	4-12
SATA Mode.....	4-12
▶ PCIe/PCI/PnP Configuration.....	4-13
PCI ROM Priority.....	4-13
PCI Latency Timer.....	4-13
Active State Power Management.....	4-13
PCIe Max Read Request Size.....	4-14
PCI Slot 1 & 2 Option ROM.....	4-14
PCIe Slot 3, 4, 5, & 7 Option ROM.....	4-14
Onboard LAN1/LAN2 Option ROM.....	4-14
▶ Super IO Device Configuration.....	4-14
Nuvoton LPC I/O - NCT6776F.....	4-14
Serial Port 1 / Serial Port 2.....	4-14
Serial Port 1 / Serial Port 2 Settings.....	4-14

---

---

	PS2 KB/MS Wake up.....	4-14
	ITE LPC I/O - IT8760.....	4-15
	Serial Port 3 / Serial Port 4.....	4-15
	Serial Port 3 / Serial Port 4 Settings.....	4-15
	▶Hardware Health Configuration.....	4-15
	Fan Speed Control Mode.....	4-15
	CPU Temperature.....	4-16
	System Temperature / Peripheral Temperature .....	4-16
	Fan 1 ~ Fan 4 Reading.....	4-16
	VCORE, 12V, VDIMM, 5VCC, VTT_CPU, AVCC, 3.3VCC, VSB, VBAT .....	4-16
	▶ACPI Configuration.....	4-16
	High Precision Event Timers.....	4-16
	Suspend Mode .....	4-17
	▶AMT Configuration .....	4-17
	AMT .....	4-17
	Unconfigure AMT/ME .....	4-17
	Watch Dog Timer.....	4-17
4-3	Security Settings .....	4-18
	Administrator Password .....	4-18
	User Password:.....	4-18
	Boot Sector Virus Protection.....	4-18
4-4	Boot Settings .....	4-19
	Setup Prompt Timeout .....	4-19
	Boot Option #1, Boot option #2, Boot Option #3, etc.....	4-19
	Hard Disk Drives .....	4-19
4-5	Exit Options.....	4-20
	Save Changes and Exit .....	4-20
	Discard Changes and Exit .....	4-20
	Discard Changes.....	4-20
	Restore Defaults.....	4-21
	Save As User Defaults .....	4-21
	Restore User Defaults.....	4-21
	Boot Override .....	4-21
	Launch EFI Shell from filesystem device.....	4-21
	▶Reset System with ME disabled Mode .....	4-21

---

**Appendix A**

**BIOS Error Beep Codes**

A-1 BIOS Error Beep Codes .....A-1

**Appendix B**

**Software Installation Instructions**

B-1 Installing Drivers.....B-1  
B-2 Configuring SuperDoctor<sup>®</sup> III .....B-2

**Appendix C**

**UEFI BIOS Recovery Instructions**

C-1 An Overview to the UEFI BIOS .....C-1  
C-2 How to Recover the UEFI BIOS Image (-the Main BIOS Block).....C-1  
C-3 To Recover the Boot Sector Using a USB-Attached Device .....C-1

# Chapter 1

## Introduction

### 1-1 Overview

#### Checklist

Congratulations on purchasing your computer motherboard from an acknowledged leader in the industry. Supermicro boards are designed with the utmost attention to detail to provide you with the highest standards in quality and performance.

Please check that the following items have all been included with your motherboard. If anything listed here is damaged or missing, contact your retailer.

The following items are included in the retail box.

- One (1) Supermicro Motherboard
- Two (2) SATA cables
- One (1) I/O shield
- One (1) Supermicro CD containing drivers and utilities
- One (1) User's Manual

SUPER C7Q67-H Motherboard Image

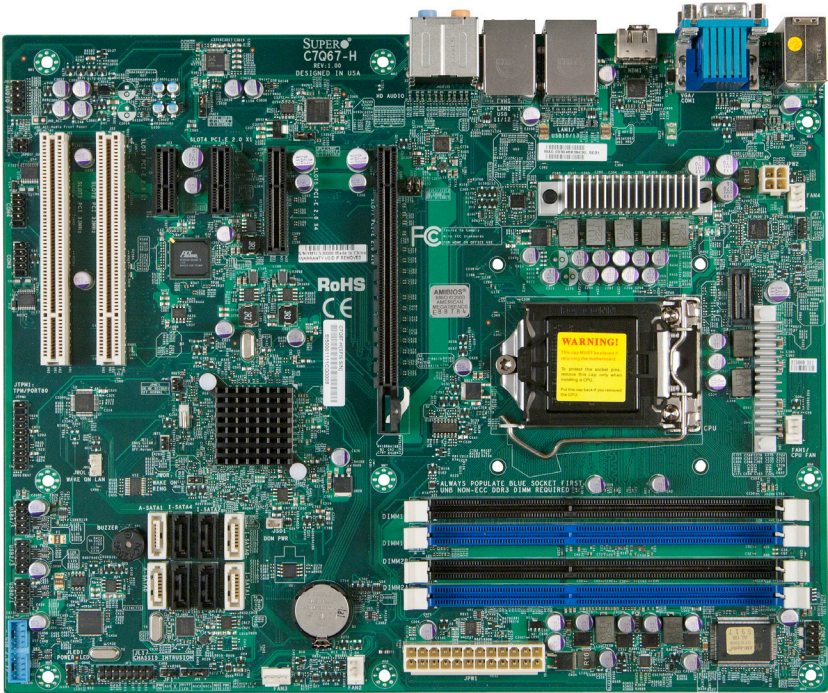

**Note:** All graphics shown in this manual were based upon the latest PCB Revision available at the time of publishing of the manual. The motherboard you've received may or may not look exactly the same as the graphics shown in this manual.

## C7Q67-H Motherboard Layout

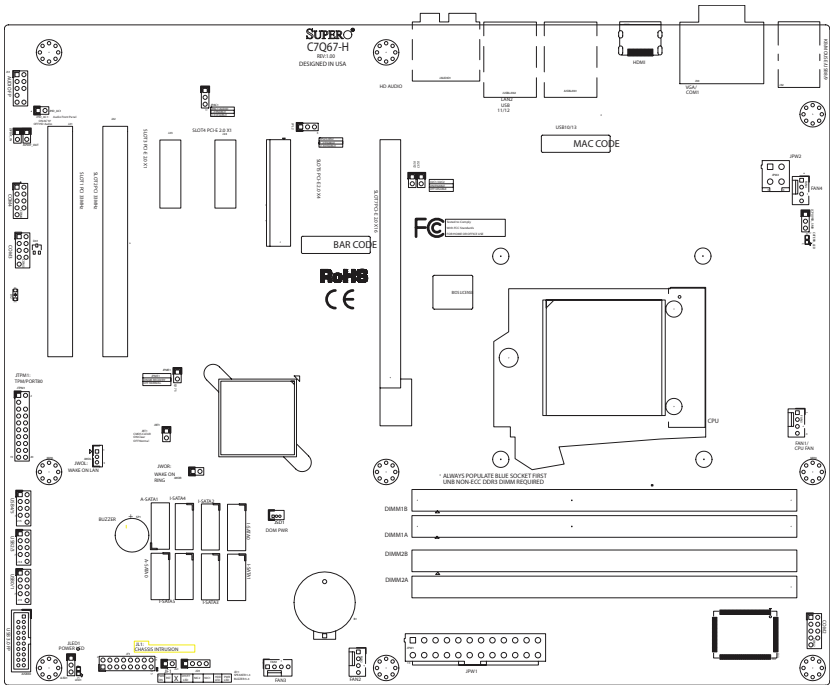

### Important Notes to the User

- See Chapter 2 for detailed information on jumpers, I/O ports and JF1 front panel connections.
- "■" indicates the location of "Pin 1".
- Jumpers not indicated are for testing only.
- When LED1 (Onboard Power LED Indicator) is on, system power is on. Unplug the power cable before installing or removing any components.

C7Q67-H Quick Reference

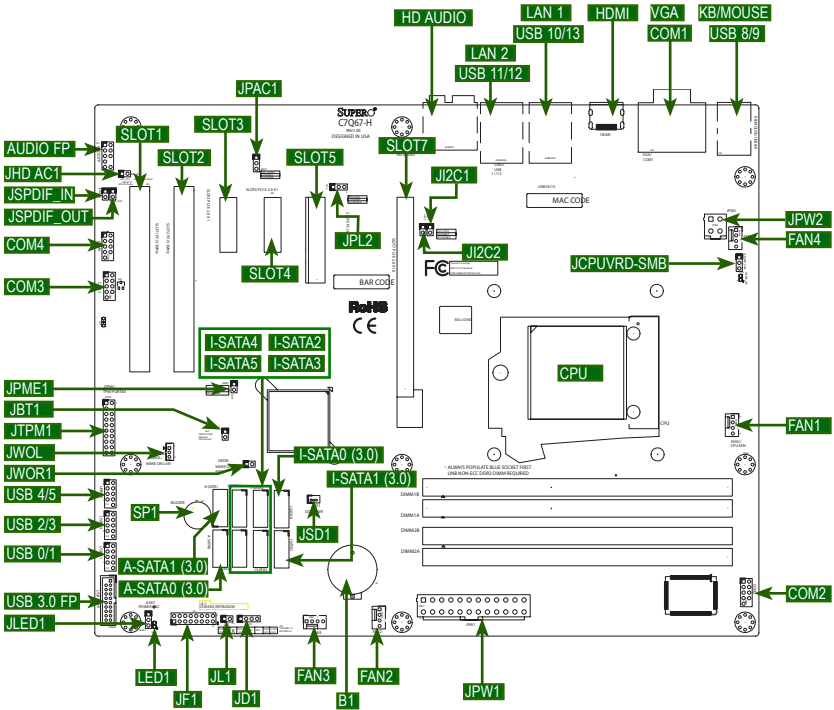

C7Q67-H Jumpers

Jumper	Description	Default
JBT1	CMOS Clear	(See Chpt. 2)
JHD_AC1	High Definition Front Panel Audio/AC 97' FP Audio Select	(See Chpt. 2)
J12C1/J12C2	SMB to PCI Slots	Off (Disabled)
JPAC1	Audio Enable	Pins 1-2 (Enabled)
JPL2	LAN2 Disable/Enable	Pins 1-2 (Enabled)
JPME1	Intel ME Mode Select	Off (Normal)

<b>C7Q67-H Headers/Connectors</b>	
Connector	Description
Audio FP	Front Panel Audio Header
HD AUDIO	High-Definition Audio Connectors (on the I/O back panel)
B1, SP1	Onboard Battery, Internal Speaker/Buzzer
COM1/COM2/COM3/COM4	COM1 Port (Back Panel) COM 2/3/4 Serial Port Headers
Fan1~Fan4	System/CPU Fan Headers (Fan1: CPU Fan)
JCPUVRD SMB	PWM SMB programming header(for debugging only)
JD1	Speaker/buzzer (Pins 1-2: Buzzer, Pins 1~4: External Speaker)
JF1	Front Panel Control Header
JL1	Chassis Intrusion Header
JLED1	Power LED Indicator Header
JPW1	24-pin ATX Main Power Connector (Required)
JPW2	+12V 4-pin CPU power Connector (Required)
KB/Mouse	Keyboard/Mouse Connectors
LAN1/LAN2	Gigabit (RJ45) Ports (LAN1/2)
JSPDIF_In/JSPDIF_OUT	SPDIF_(Sony/Philips Digital Interface)_In/ SPDIF_Out Headers
JSD1	SATA DOM (Device_On_Module) Power Connector
JWOL	Wake_On_LAN Header
JWOR1	Wake_On-Ring Header
Slot 7	PCI-Express 2.0 x16 Slot
Slot 3, Slot 4	PCI-Express 2.0 x1 Slot
Slot 1, Slot 2	PCI 33MHz Slot (5V)
Slot 5	PCI-Express 2.0 x4 Slot
A-SATA0 / A-SATA1	(ASMedia) Serial ATA (SATA 3.0) Ports 0/1 (6Gb/sec)
I-SATA0 / I-SATA1	(Intel Q67) Serial ATA (SATA 3.0) Ports 0/1 (6Gb/sec)
I-SATA 2~I-SATA5	(Intel Q67) Serial ATA (SATA 2.0) Ports 2~5 (3Gb/sec)
USB 8/9	Backpanel USB 2.0 8/9
USB 11/12, 10/13	Backpanel USB 2.0 Ports 11/12, and Ports 10/13
USB 0/1, USB 2/3, USB 4/5	Front Panel Accessible USB 2.0 Headers 0/1, 2/3, 4/5
USB 3.0 FP	Front Panel Accessible USB 3.0 Header 0/1
HDMI	Backpanel HDMI Port
VGA	Backpanel VGA Port

<b>C7Q67-H LED Indicators</b>			
LED	Description	Color/State	Status
LED1	Onboard Standby PWR LED	Green: Solid on	Power On

## Motherboard Features

<b>CPU</b>	Single 2nd Generation Intel® Core™ i7/i5/i3 DT processor in an LGA1155 socket.	
<b>Memory</b>	Four (4) SDRAM slots support up to 32 GB of DDR3 Unbuffered, Non-ECC 1333/1066 memory	
	Supports dual-channel memory bus	
	<b>DIMM sizes</b>	
	UDIMM	1 GB, 2 GB, 4GB, and 8GB
<b>Chipset</b>	Intel® Q67 Express	
<b>Expansion Slots</b>	Two (2) PCI Express 2.0 x1 slot	
	One (1) PCI Express 2.0 x4 slot	
	One (1) PCI Express 2.0 x16 slot	
	Two (2) PCI 33 MHz slots (5 Volts)	
<b>Network Connections</b>	Two (2) Gigabit Ethernet Controllers: LAN1: Intel 82579LM PHY LAN2: Intel 82574L	
	Two (2) RJ-45 Rear I/O Panel Connectors with Link and Activity LEDs	
<b>I/O Devices</b>	<b>SATA Connections</b>	
	SATA 3.0 (6Gb/s)	Two (2) A-SATA 0~1, via ASMedia
		RAID 0, 1
	SATA 3.0 (6Gb/s)	Two (2) I-SATA 0~1, via Intel Q67
		RAID 0, 1
	SATA 2.0 (3Gb/s)	Four (4) I-SATA 2~5, via Intel Q67
		RAID 0, 1, 5, 10 (MS Windows®)
		RAID 0, 1, 10 (Linux)
	<b>USB Devices</b>	
	Six (6) USB 2.0 ports on the rear I/O panel	
	Six (6) Front Accessible USB 2.0 ports on three headers, and Two (2) Front Accessible USB 3.0 ports on one header	
	<b>Keyboard/Mouse</b>	
	One shared PS/2 Keyboard/Mouse port on the I/O backpanel	
	<b>Serial (COM) Ports</b>	
	Three (3) front accessible Serial Port headers (COM2, COM3, COM4)	
One (1) Serial Port on the back panel (COM1)		

	<b>Audio</b> Five (5) Female Mini Jacks for High Definition Audio on the Back Panel Front Panel Audio Header One (1) SP/DIF Optical Out on the back panel SP/DIF In and SP/DIF Out Headers <b>Super I/O</b> Nuvoton NCT6776F
<b>BIOS</b>	64 Mb AMI BIOS® SPI Flash BIOS Play and Plug (PnP0, DMI 2.3, PCI 2.3, ACPI 1.0/2.0/3.0, USB Keyboard and SMBIOS 2.5)
<b>Power Configuration</b>	ACPI/ACPM Power Management Main Switch Override Mechanism Keyboard Wake-up from Soft-Off Internal/External Modem Ring-On Power-on mode for AC power recovery
<b>PC Health Monitoring</b>	<b>CPU Monitoring</b> Onboard voltage monitors for CPU core, +3.3V, +5V, +12V, +3.3V Stdby, VBAT, Memory, VCORE for CPU CPU 4-phase switching voltage regulator CPU/System overheat LED and control CPU Thermal Trip support Thermal Monitor 2 (TM2) support <b>Fan Control</b> Fan status monitoring with firmware 4-pin (Pulse Width Modulation) fan speed control Low noise fan speed control
<b>System Management</b>	PECl (Platform Environment Configuration Interface) 2.0 support System resource alert via SuperDoctor® III SuperDoctor III, Watch Dog, NMI Chassis Intrusion header and detection
<b>CD Utilities</b>	BIOS flash upgrade utility Drivers and software for Intel® Q67 Express chipset utilities
<b>Other</b>	ROHS 6/6 (Full Compliance, Lead Free)
<b>Dimensions</b>	ATX form factor (12.0" x 9.6")

C7Q67-H Block Diagram

C7Q67-H  
BLOCK DIAGRAM  
RoHS 6/6

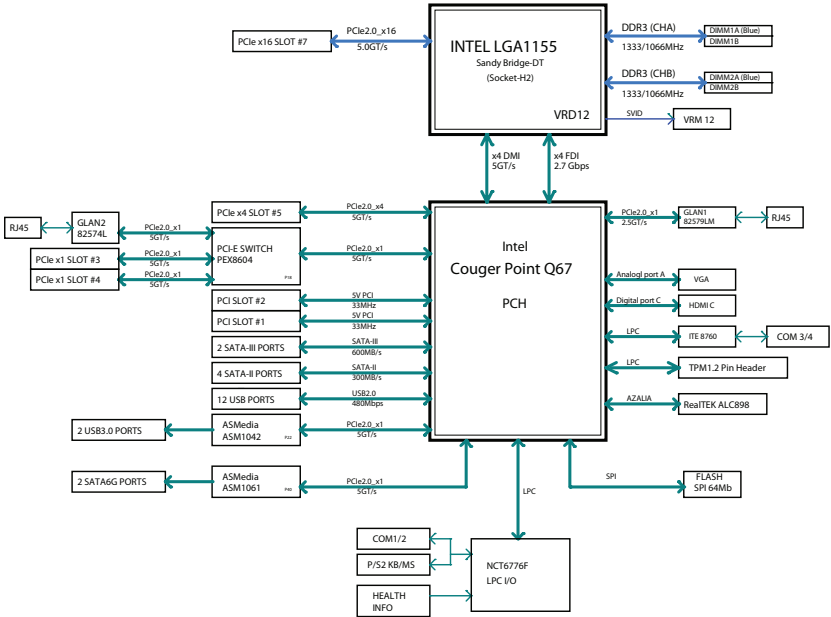

System Block Diagram



**Note:** This is a general block diagram and may not exactly represent the features on your motherboard. See the Motherboard Features pages for the actual specifications of each motherboard.

## 1-2 Chipset Overview

The C7Q67-H supports a single 2nd generation Intel® Core i7/i5/i3 DT processor in the LGA 1155 Socket. Built upon the functionality and the capability of the Q67 Express chipset, the motherboard provides substantial enhancement to system performance and storage capability for high performance platforms in a sleek package.

The high-speed Direct Media Interface (DMI) featured in the Intel Q67 Express chipset supports high-speed Direct Media Interface (DMI) for chip-to-chip true isochronous communication, providing up to 10 Gb/s of software-transparent data transfer rate on each read/write direction. In addition, the C7Q67-H also features a TCO timer which allows the system to recover from a software/hardware lock and perform tasks, including Function Disable and Intruder Detect.

### Intel Q67 Express Chipset Features

- Direct Media Interface (up 10 Gb/s transfer, Full Duplex)
- Intel® Matrix Storage Technology and Intel Rapid Storage Technology
- Dual NAND Interface
- Intel I/O Virtualization (VT-d) Support
- Intel Trusted Execution Technology Support
- PCI Express 2.0 Interface (up to 5.0 GT/s)
- SATA Controller (up to 6Gb/sec)
- Advanced Host Controller Interface (AHCI)

## 1-3 Special Features

### Recovery from AC Power Loss

Basic I/O System (BIOS) provides a setting for you to determine how the system will respond when AC power is lost and then restored to the system. You can choose for the system to remain powered off, (in which case you must press the power switch to turn it back on), or for it to automatically return to a power-on state. See the Advanced BIOS Setup section to change this setting. The default setting is **Last State**.

## 1-4 PC Health Monitoring

This section describes the PC health monitoring features of the board. All have an onboard System Hardware Monitoring chip that supports PC health monitoring. An onboard voltage monitor will scan these onboard voltages continuously: CPU Vcore, 12V, 1.5V, 3.3V, 3.3VSB, and Battery Voltage. Once a voltage becomes unstable, a warning is given, or an error message is sent to the screen. The user can adjust the voltage thresholds to define the sensitivity of the voltage monitor.

### Fan Status Monitor with Firmware Control

PC health monitoring in the BIOS can check the RPM status of the cooling fans. The onboard CPU and chassis fans are controlled by Thermal Management via BIOS (under the Hardware Monitoring section in the Advanced Setting).

### Environmental Temperature Control

The thermal control sensor monitors the CPU temperature in real time and will turn on the thermal control fan whenever the CPU temperature exceeds a user-defined threshold. The overheat circuitry runs independently from the CPU. Once the thermal sensor detects that the CPU temperature is too high, it will automatically turn on the thermal fans to prevent the CPU from overheating. The onboard chassis thermal circuitry can monitor the overall system temperature and alert the user when the chassis temperature is too high.



**Note:** To avoid possible system overheating, please be sure to provide adequate airflow to your system.

### System Resource Alert

This feature is available when the system is used with Supero Doctor III in the Windows OS environment or used with Supero Doctor II in Linux. Supero

Doctor is used to notify the user of certain system events. For example, you can also configure Supero Doctor to provide you with warnings when the system temperature, CPU temperatures, voltages and fan speeds go beyond predefined thresholds.

## 1-5 ACPI Features

ACPI stands for Advanced Configuration and Power Interface. The ACPI specification defines a flexible and abstract hardware interface that provides a standard way to integrate power management features throughout a PC system, including its hardware, operating system and application software. This enables the system to automatically turn on and off peripherals such as CD-ROMs, network cards, hard disk drives and printers.

In addition to enabling operating system-directed power management, ACPI also provides a generic system event mechanism for Plug and Play, and an operating system-independent interface for configuration control. ACPI leverages the Plug and Play BIOS data structures, while providing a processor architecture-independent implementation that is compatible with Windows XP, Windows Vista, and Windows 2008 Operating Systems.

### Slow Blinking LED for Suspend-State Indicator

When the CPU goes into a suspend state, the chassis power LED will start to blink to indicate that the CPU is in suspend mode. When the user presses any key, the CPU will "wake up", and the LED will automatically stop blinking and remain on.

## 1-6 Power Supply

As with all computer products, a stable power source is necessary for proper and reliable operation. It is even more important for processors that have high CPU clock rates.

This motherboard accommodates 24-pin ATX power supplies. Although most power supplies generally meet the specifications required by the CPU, some are inadequate. In addition, the 12V 4-pin power connector located at JPW2 is also required to ensure adequate power supply to the system. Also your power supply must supply 1.5A for the Ethernet ports.



**Warning!** 1. To prevent damage to the power supply or motherboard, please use a power supply that contains a 24-pin and a 8-pin power connectors. Be sure to connect these connectors to the 24-pin (JPW1) and the 4-pin (JPW2) power connectors on the motherboard. Failure in doing so will void the manufacturer warranty on your power supply and motherboard.

2. To provide adequate power to SATA devices, please connect the SATA DOM PWR connector (JWF1) to the power supply.

It is strongly recommended that you use a high quality power supply that meets ATX power supply Specification 2.02 or above. It must also be SSI compliant. (For more information, please refer to the web site at <http://www.ssiforum.org/>). Additionally, in areas where noisy power transmission is present, you may choose to install a line filter to shield the computer from noise. It is recommended that you also install a power surge protector to help avoid problems caused by power surges.

## **1-7 Super I/O**

The Super I/O supports two high-speed, 16550 compatible serial communication ports (UARTs). Each UART includes a 16-byte send/receive FIFO, a programmable baud rate generator, complete modem control capability and a processor interrupt system. Both UARTs provide legacy speed with baud rate of up to 115.2 Kbps as well as an advanced speed with baud rates of 250 K, 500 K, or 1 Mb/s, which support higher speed modems.

The Super I/O provides functions that comply with ACPI (Advanced Configuration and Power Interface), which includes support of legacy and ACPI power management through an SMI or SCI function pin. It also features auto power management to reduce power consumption.

## Chapter 2

### Installation

#### 2-1 Static-Sensitive Devices

Electrostatic-Discharge (ESD) can damage electronic components. To avoid damaging your system board, it is important to handle it very carefully. The following measures are generally sufficient to protect your equipment from ESD.

##### **Precautions**

- Use a grounded wrist strap designed to prevent static discharge.
- Touch a grounded metal object before removing the board from the antistatic bag.
- Handle the board by its edges only; do not touch its components, peripheral chips, memory modules or gold contacts.
- When handling chips or modules, avoid touching their pins.
- Put the motherboard and peripherals back into their antistatic bags when not in use.
- For grounding purposes, make sure your computer chassis provides excellent conductivity between the power supply, the case, the mounting fasteners and the motherboard.
- Use only the correct type of onboard CMOS battery. Do not install the onboard battery upside down to avoid possible explosion.

##### **Unpacking**

The motherboard is shipped in antistatic packaging to avoid static damage. When unpacking the board, make sure that the person handling it is static protected.

## 2-2 Processor and Heatsink Installation



**Warning:** When handling the processor package, avoid placing direct pressure on the label area of the fan.



**Important:**

Always connect the power cord last, and always remove it before adding, removing or changing any hardware components. Make sure that you install the processor into the CPU socket before you install the CPU heatsink.

If you buy a CPU separately, make sure that you use an Intel-certified multi-directional heatsink only.

Make sure to install the system board into the chassis before you install the CPU heatsink.

When receiving a server board without a processor pre-installed, make sure that the plastic CPU socket cap is in place and none of the socket pins are bent; otherwise, contact your retailer immediately.

Refer to the Supermicro website for updates on CPU support.

### Installing the LGA1155 Processor

1. Press the load lever to release the load plate, which covers the CPU socket, from its locking position.

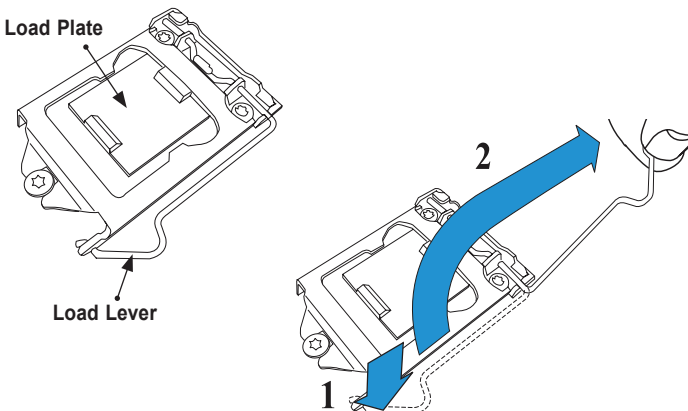

2. Gently lift the load lever to open the load plate. Remove the plastic cap.

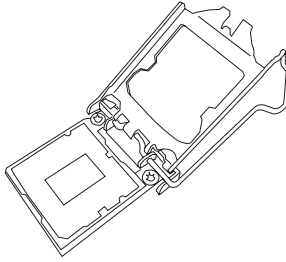

3. Use your thumb and your index finger to hold the CPU at the North center edge and the South center edge of the CPU.

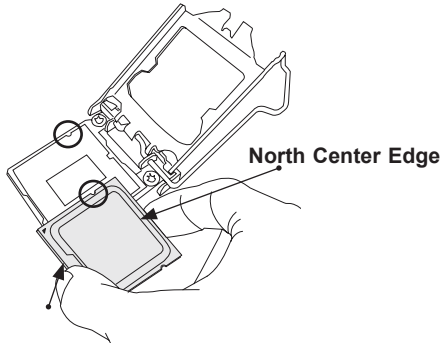

**South Center Edge**

4. Align the CPU key that is the semi-circle cutouts against the socket keys. Once it is aligned, carefully lower the CPU straight down into the socket. (Do not drop the CPU on the socket. Do not move the CPU horizontally or vertically.)

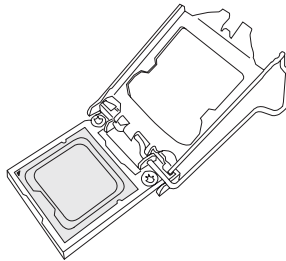

5. Do not rub the CPU against the surface or against any pins of the socket to avoid damaging the CPU or the socket.)

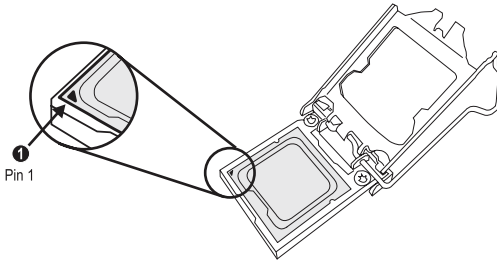

6. With the CPU inside the socket, inspect the four corners of the CPU to make sure that the CPU is properly installed.
7. Use your thumb to gently push the load lever down to the lever lock.

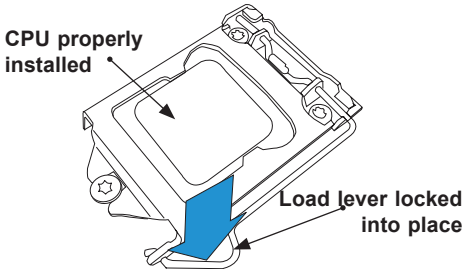

**Warning:** You can only install the CPU inside the socket only in one direction. Make sure that it is properly inserted into the CPU socket before closing the load plate. If it doesn't close properly, do not force it as it may damage your CPU. Instead, open the load plate again and double-check that the CPU is aligned properly.

## Installing an Active CPU Heatsink with Fan

1. Locate the CPU Fan power connector on the motherboard. (Refer to the layout on the right for the CPU Fan location.)
2. Position the heatsink so that the heatsink fan wires are closest to the CPU fan power connector and are not interfered with other components.
3. Inspect the CPU Fan wires to make sure that the wires are routed through the bottom of the heatsink.
4. Remove the thin layer of the protective film from the heatsink.



**Warning:** CPU overheat may occur if the protective film is not removed from the heatsink.

5. Apply the proper amount of thermal grease on the CPU.



**Note:** if your heatsink came with a thermal pad, please ignore this step.

6. If necessary, rearrange the wires to make sure that the wires are not pinched between the heatsink and the CPU. Also make sure to keep clearance between the fan wires and the fins of the heatsink.

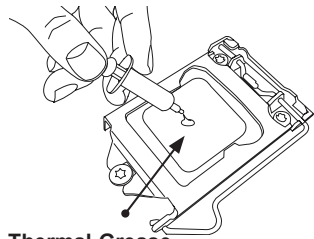

**Thermal Grease**

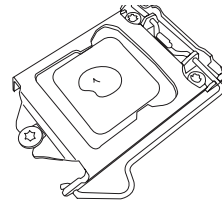

**Heatsink Fins**

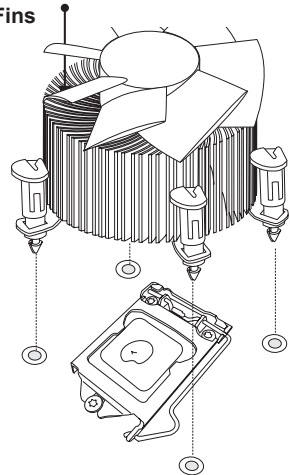

**Recommended Supermicro heatsink:  
SNK-P0046A4 active heatsink**

7. Align the four heatsink fasteners with the mounting holes on the motherboard. Gently push the pairs of diagonal fasteners (#1 & #2, and #3 & #4) into the mounting holes until you hear a click. Also, make sure to orient each fastener so that the narrow end of the groove is pointing outward.

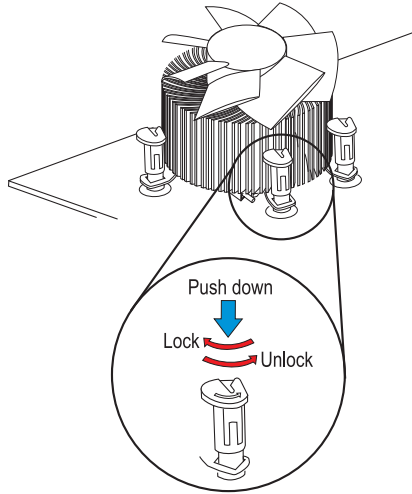

8. Repeat Step 7 to insert all four heatsink fasteners into the mounting holes.
9. Once all four fasteners are securely inserted into the mounting holes, and the heatsink is properly installed on the motherboard, connect the heatsink fan wires to the CPU Fan connector.



## Removing the Heatsink



**Warning:** We do not recommend that the CPU or the heatsink be removed. However, if you do need to remove the heatsink, please follow the instructions below to remove the heatsink and to prevent damage done to the CPU or other components.

### Active Heatsink Removal

1. Unplug the power cord from the power supply.
2. Disconnect the heatsink fan wires from the CPU fan header.
3. Use your finger tips to gently press on the fastener cap and turn it counterclockwise to make a 1/4 (90°) turn, and pull the fastener upward to loosen it.
4. Repeat Step 3 to loosen all fasteners from the mounting holes.
5. With all fasteners loosened, remove the heatsink from the CPU.

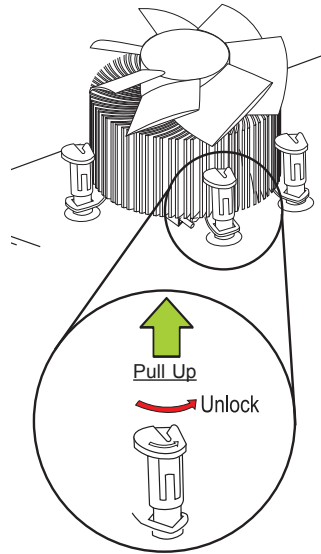
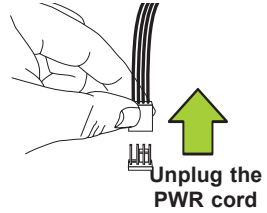

## 2-3 Installing DDR3 Memory



**Note:** Check the Supermicro website for recommended memory modules.

### CAUTION



Exercise extreme care when installing or removing DIMM modules to prevent any possible damage.

### DIMM Installation

1. Insert the desired number of DIMMs into the memory slots, starting with DIMM1A (Slot A, Channel 1, see the next page for the location). For best performance, please use the memory modules of the same type and speed in the same bank.
2. Push the release tabs outwards on both ends of the DIMM slot to unlock it.
3. Align the key of the DIMM module with the receptive point on the memory slot.
4. Align the notches on both ends of the module against the receptive points on the ends of the slot.
5. Use two thumbs together to press the notches on both ends of the module straight down into the slot until the module snaps into place.
6. Press the release tabs to the lock positions to secure the DIMM module into the slot.

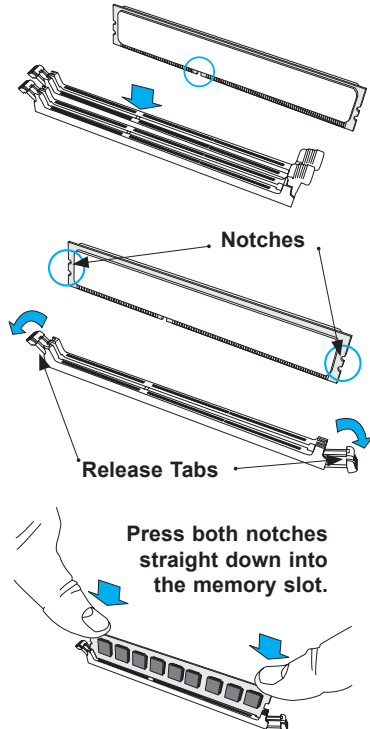
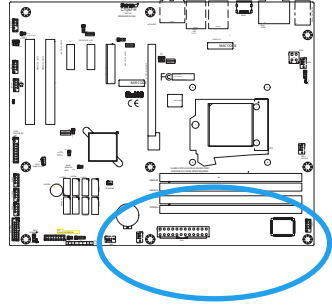

### Removing Memory Modules

Reverse the steps above to remove the DIMM modules from the motherboard.

## Memory Support

The C7Q67-H supports up to 32GB of Unbuffered (UDIMM) DDR3 Non-ECC 1333/1066 MHz in 4 memory slots. Populating these DIMM modules with a pair of memory modules of the same type and same size will result in interleaved memory, which will improve memory performance. Please refer to the table below:

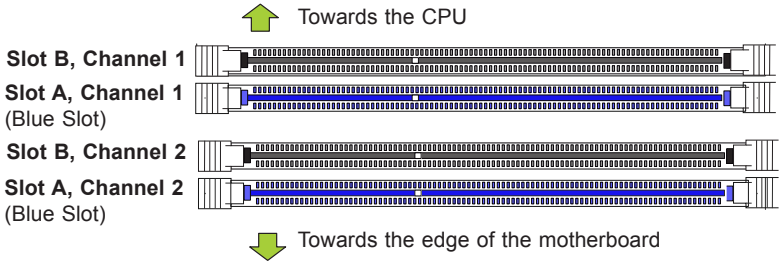

## Memory Population Guidelines

Please follow the table below when populating the C7Q67-H.

DDR3 Unbuffered Non-ECC (UDIMM) Memory				
DIMM Slots per Channel	DIMMs Populated per Channel	DIMM Type	POR Speeds	Ranks per DIMM (any combination)
2	1	Unbuffered DDR3	1066, 1333	Single Rank, Dual Rank
2	2	Unbuffered DDR3	1066, 1333	Single Rank, Dual Rank



### Notes

- Due to memory allocation to system devices, the amount of memory that remains available for operational use will be reduced when 4 GB of RAM is used. The reduction in memory availability is disproportional. See the following table for details.
- For Microsoft Windows users: Microsoft implemented a design change in the Windows XP with Service Pack 2 (SP2) and Windows Vista. This change is specific to the behavior of Physical Address Extension (PAE) mode which improves driver compatibility. For more information, please read the following article at Microsoft's Knowledge Base website at: <http://support.microsoft.com/kb/888137>.

<b>Possible System Memory Allocation &amp; Availability</b>		
<b>System Device</b>	<b>Size</b>	<b>Physical Memory Remaining (-Available) (4 GB Total System Memory)</b>
Firmware Hub flash memory (System BIOS)	1 MB	3.99
Local APIC	4 KB	3.99
Area Reserved for the chipset	2 MB	3.99
I/O APIC (4 Kbytes)	4 KB	3.99
PCI Enumeration Area 1	256 MB	3.76
PCI Express (256 MB)	256 MB	3.51
PCI Enumeration Area 2 (if needed) -Aligned on 256-MB boundary-	512 MB	3.01
VGA Memory	16 MB	2.85
TSEG	1 MB	2.84
Memory available to OS and other applications		2.84

## 2-4 Motherboard Installation

All motherboards have standard mounting holes to fit different types of chassis. Make sure that the locations of all the mounting holes for both motherboard and chassis match. Although a chassis may have both plastic and metal mounting fasteners, metal ones are highly recommended because they ground the motherboard to the chassis. Make sure that the metal standoffs click in or are screwed in tightly. Then use a screwdriver to secure the motherboard onto the motherboard tray.

### Tools Needed



Philips Screwdriver



Philips Screws



Standoffs  
Only if Needed

### Location of Mounting Holes

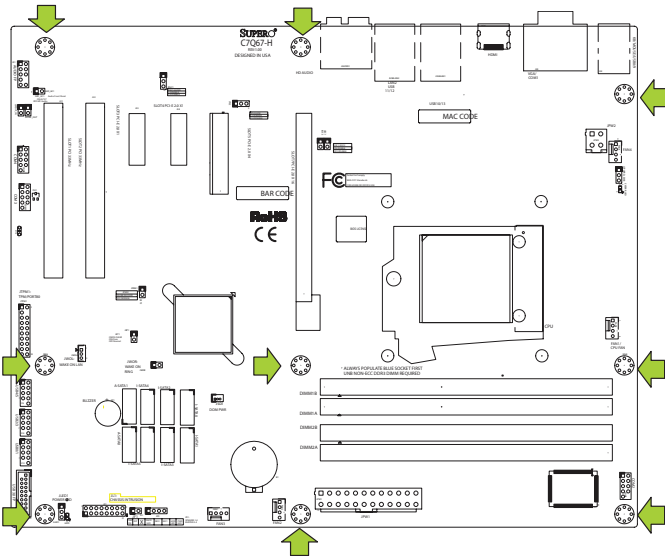

**Caution:** 1) To avoid damaging the motherboard and its components, please do not use a force greater than 8 lb/inch on each mounting screw during motherboard installation. 2) Some components are very close to the mounting holes. Please take precautionary measures to avoid damaging these components when installing the motherboard to the chassis.

## Installing the Motherboard

1. Install the I/O shield into the back of the chassis.

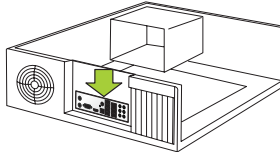

2. Locate the mounting holes on the motherboard. (See the previous page.)
3. Locate the matching mounting holes on the chassis. Align the mounting holes on the motherboard against the mounting holes on the chassis.
4. Install standoffs in the chassis as needed.

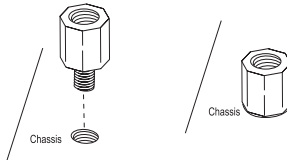

5. Install the motherboard into the chassis carefully to avoid damaging other motherboard components.
6. Using the Philips screwdriver, insert a Philips head #6 screw into a mounting hole on the motherboard and its matching mounting hole on the chassis.

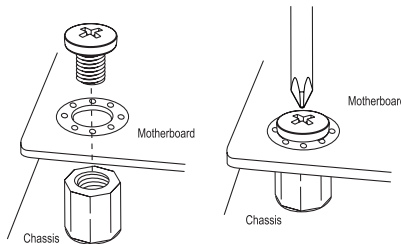

7. Repeat Step 5 to insert #6 screws into all mounting holes.
8. Make sure that the motherboard is securely placed in the chassis.



**Note:** Images displayed are for illustration only. Your chassis or components might look different from those shown in this manual.

## 2-5 Connectors/I/O Ports

The I/O ports are color coded in conformance with the PC 99 specification. See the figure below for the colors and locations of the various I/O ports.

### Backplane I/O Panel

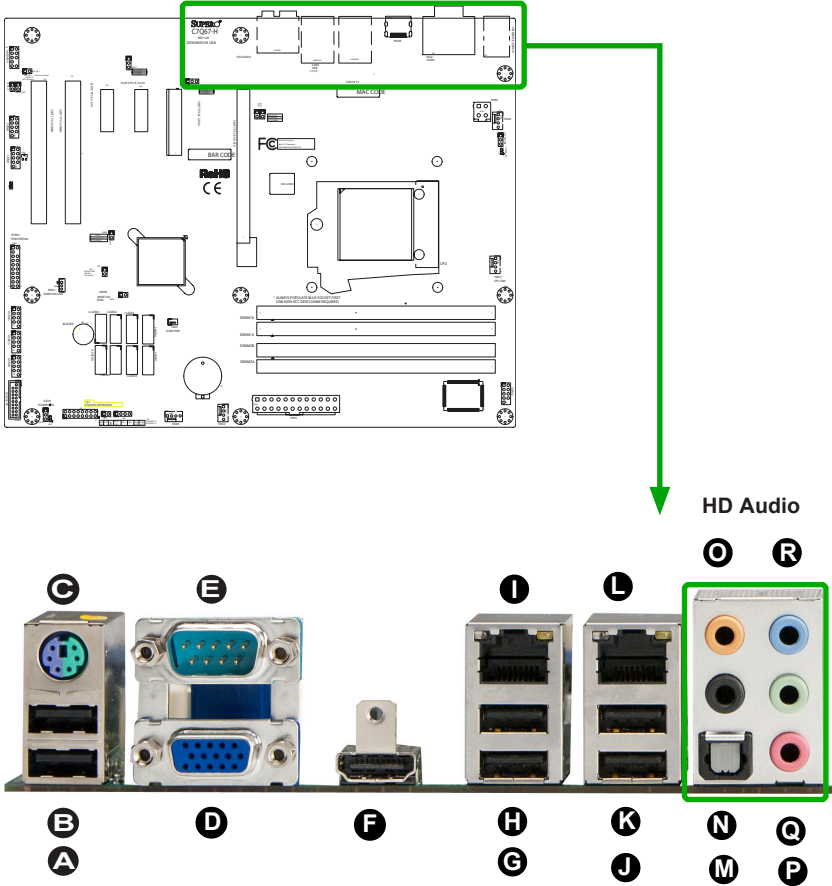

Backplane I/O Panel		
A. USB 2.0 Port 9	G. USB 2.0 Port 10	M. SPDIF Out
B. USB 2.0 Port 8	H. USB 2.0 Port 13	N. Surround Out
C. Keyboard/Mouse	I. Gb LAN Port 1	O. Center/LFE Out
D. VGA Port	J. USB 2.0 Port 11	P. Mic In
E. Serial Port (COM1)	K. USB 2.0 Port 12	Q. Line Out
F. HDMI Port	L. Gb LAN Port 2	R. Line In

HD Audio

**ATX PS/2 Keyboard/Mouse Ports**

The ATX PS/2 keyboard and PS/2 mouse are located next to the Back Panel USB Ports 8/9 on the motherboard. See the table at right for pin definitions.

PS/2 Keyboard/Mouse Pin Definitions			
PS2 Keyboard		PS2 Mouse	
Pin#	Definition	Pin#	Definition
1	KB Data	1	Mouse Data
2	No Connection	2	No Connection
3	Ground	3	Ground
4	Mouse/KB VCC (+5V)	4	Mouse/KB VCC (+5V)
5	KB Clock	5	Mouse Clock
6	No Connection	6	No Connection

VCC: with 1.5A PTC (current limit)



**Note:**

This motherboard offers three Keyboard/Mouse connection options as shown in the graphic below.

- **A.** Plug in a PS/2 keyboard or PS/2 Mouse cable to the PS2 Keyboard/Mouse port.
- **B.** Plug in a Y cable that that includes a keyboard cable and mouse cable to the PS/2 Keyboard/Mouse port..
- **C.** Connect a USB keyboard cable or a USB mouse cable to any USB port.

**Keyboard/Mouse**  
 (For a PS/2 keyboard cable, a PS/2 Mouse cable or a PS/2 Y cable) (optional)

**C** (For a USB keyboard cable or a USB mouse cable, in any USB port) (optional)

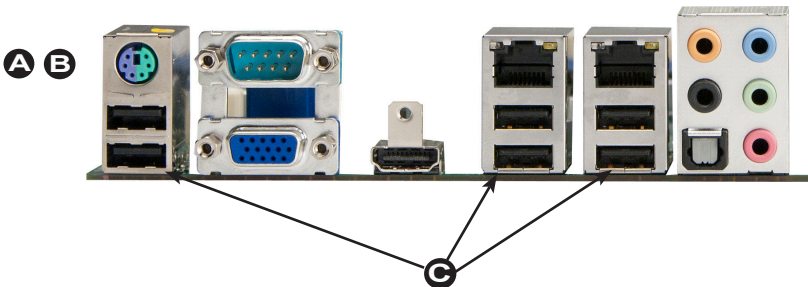

## Universal Serial Bus (USB)

Six Universal Serial Bus 2.0 ports (8/9, 10/13, 11/12) are located on the I/O back panel. USB 2.0 headers 0/1, 2/3, 4/5 and USB 3.0 header 0/1 (JUSB30) are used to provide front chassis access using USB cables (not included). See the tables below for pin definitions.

Front Panel USB (2.0) #0/1, 2/3, 4/5 Pin Definitions			
Pin #	Definition	Pin #	Definition
1	+5V	2	+5V
3	USB_PN2	4	USB_PN3
5	USB_PP2	6	USB_PP3
7	Ground	8	Ground
9	Key	10	Ground

Back Panel USB (2.0) #8/9, 10/13, 11/12 Pin Definitions			
Pin#	Definition	Pin#	Definition
1	+5V	5	+5V
2	USB_PN1	6	USB_PN0
3	USB_PP1	7	USB_PP0
4	Ground	8	Ground

Front Panel USB (3.0) #0/1 Pin Definitions			
Pin#	Pin#	Signal Name	Description
1	10	VBUS	Power
2	11	D-	USB 2.0 Differential Pair
3	12	D+	
4	13	Ground	Ground of PWR Return
5	14	StdA_SSRX-	SuperSpeed Receiver
6	15	StdA_SSRX+	Differential Pair
7	16	GND_DRAIN	Ground for Signal Return
8	17	StdA_SSTX-	SuperSpeed Transmitter
9	18	StdA_SSTX+	Differential Pair

- A. Backpanel USB 2.0 #9
- B. Backpanel USB 2.0 #8
- C. Backpanel USB 2.0 #10
- D. Backpanel USB 2.0 #13
- E. Backpanel USB 2.0 #12
- F. Backpanel USB 2.0 #11
- G. Front Panel USB 2.0 #4/5
- H. Front Panel USB 2.0 #2/3
- I. Front Panel USB 2.0 #0/1
- J. Front Panel USB 3.0 #0/1

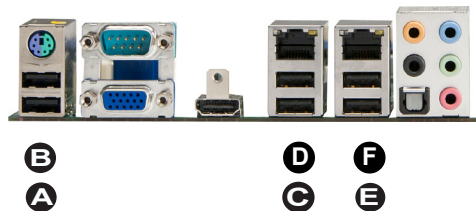
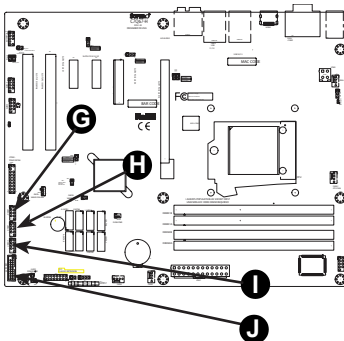

**Ethernet Ports**

Two Gigabit Ethernet ports (LAN1/LAN2) are located next to the HD Audio Connector on the I/O Backpanel to provide network connections. These ports accept RJ45 type cables.



**Note**

Please refer to the LED Indicator Section for LAN LED information.

LAN Ports Pin Definition			
Pin#	Definition		
1	P2V5SB	10	SGND
2	TD0+	11	Act LED
3	TD0-	12	P3V3SB
4	TD1+	13	Link 100 LED (Green, +3V3SB)
5	TD1-	14	Link 1000 LED (Yellow, +3V3SB)
6	TD2+	15	Ground
7	TD2-	16	Ground
8	TD3+	17	Ground
9	TD3-	88	Ground

(NC: No Connection)

A. LAN1

B. LAN2

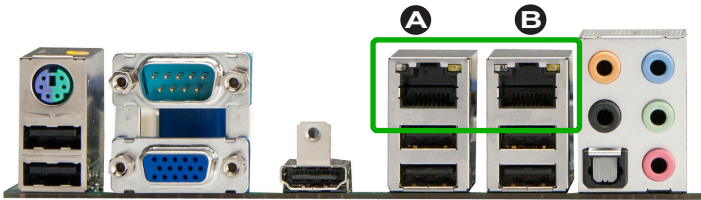

**Back Panel High Definition Audio (HD Audio)**

This motherboard features a 7.1+2 Channel High Definition Audio (HDA) codec that provides 10 DAC channels. The HD Audio connections simultaneously supports multiple-streaming 7.1 sound playback with 2 channels of independent stereo output through the front panel stereo out for front, rear, center and subwoofer speakers. Use the Advanced software included in the CD-ROM with your motherboard to enable this function.

(BP) HD Audio	
Conn#	Signal
A	SPDIF_Out
B	Surround_Out
C	CEN/LFE_Out
D	Mic_In
E	Line_Out
F	Line_In

**HD Audio**

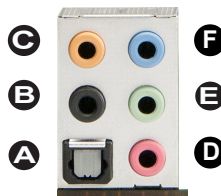

- A. SPDIF\_Out
- B. Surround\_Out
- C. CEN/LFE\_Out
- D. Mic\_In
- E. Line\_Out
- F. Line\_In

## Front Accessible Audio Header

A 10-pin Audio header is also located on the motherboard. This header allows you to use the on-board sound for audio playback. Connect an audio cable to the audio header to use this feature. See the tables at right for pin definitions for these headers.

10-in Audio Pin Definitions	
Pin#	Signal
1	Microphone_Left
2	Audio_Ground
3	Microphone_Right
4	Audio_Detect
5	Line_2_Right
6	Ground
7	Jack_Detect
8	Key
9	Line_2_Left
10	Ground

### A. Audio Header

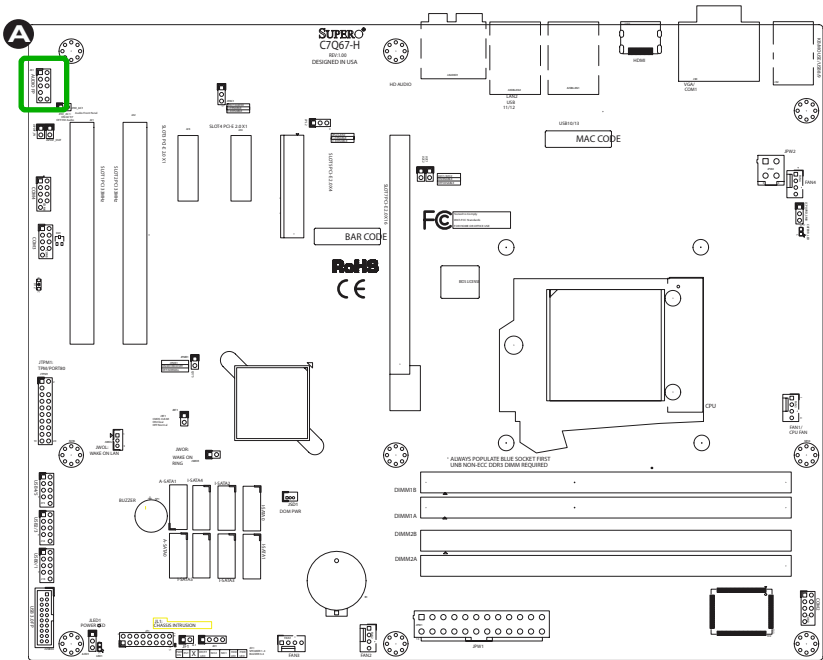

**HDMI Port**

One HDMI (High-Definition Multimedia Interface) Port is located next to the VGA port on the I/O backpanel. This connector is used to display both high definition video and digital sound through an HDMI-capable display, using a single HDMI cable (not included).

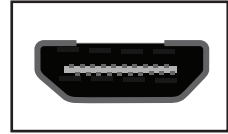

**VGA Port**

A VGA port is located next to the USB ports on the I/O backpanel. Use this port to connect to a compatible VGA display.

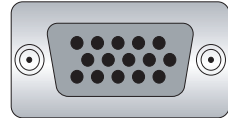

**Serial Port (COM1)**

Serial port COM1 is located on the I/O backpanel. There are three other Serial port headers on the motherboard for COM2, COM3 and COM4, see page 2-26 for more information. See the table on the right for pin definitions.

Pin #	Definition	Pin #	Definition
1	DCD	6	DSR
2	RXD	7	RTS
3	TXD	8	CTS
4	DTR	9	RI
5	Ground	10	N/A

A. HDMI Port

B. VGA Port

C. COM1 Port

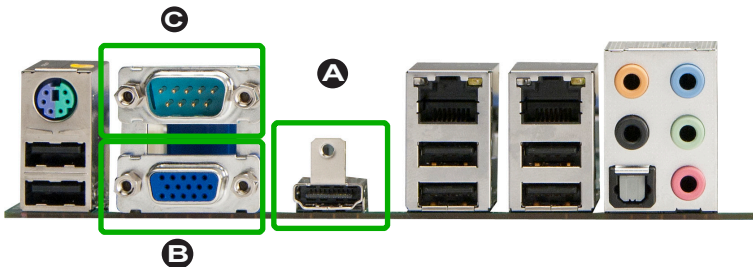

## Front Control Panel

JF1 contains header pins for various buttons and indicators that are normally located on a control panel at the front of the chassis. These connectors are designed specifically for use with Supermicro chassis. See the figure below for the descriptions of the front control panel buttons and LED indicators. Refer to the following section for descriptions and pin definitions.

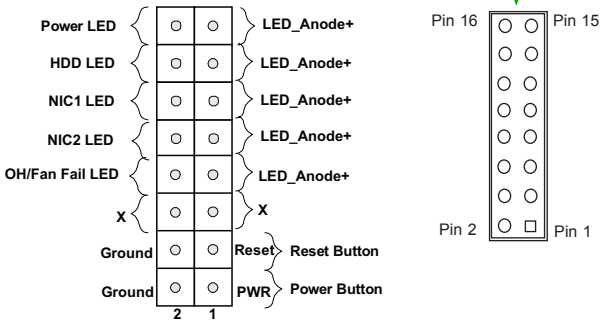
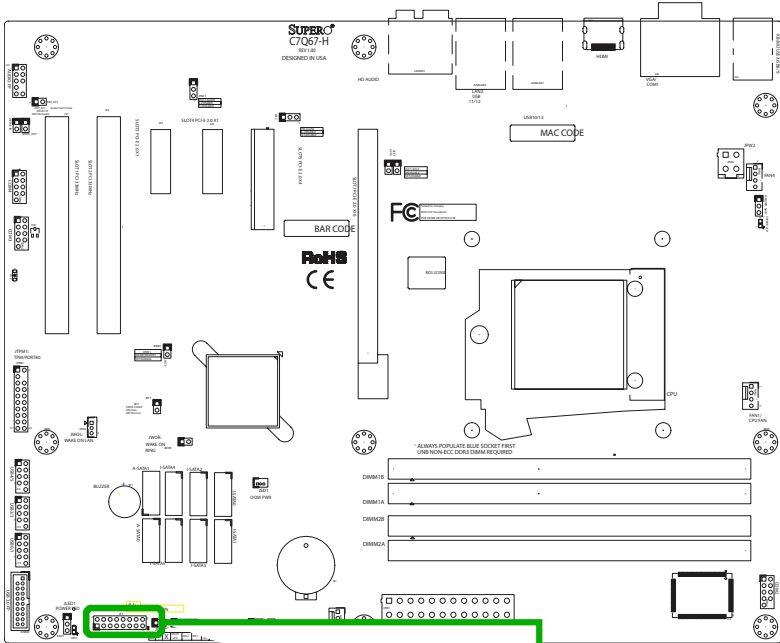

JF1 Header Pins

## Front Control Panel Pin Definitions

### Power LED

The Power LED connection is located on pins 15 and 16 of JF1. Refer to the table on the right for pin definitions.

Power LED Pin Definitions (JF1)	
Pin#	Definition
15	+5V
16	Ground

### HDD LED

The HDD LED connection is located on pins 13 and 14 of JF1. Attach a cable here to indicate the status of HDD-related activities, including IDE, SATA activities. See the table on the right for pin definitions.

HDD LED Pin Definitions (JF1)	
Pin#	Definition
13	+5V
14	HD Active

A. PWR LED

B. HDD LED

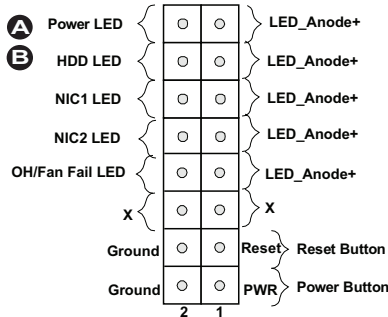

## NIC1/NIC2 (LAN1/LAN2)

The NIC (Network Interface Controller) LED connection for LAN port 1 is located on pins 11 and 12 of JF1, and the LED connection for LAN Port 2 is on Pins 9 and 10. NIC1 LED and NIC2 LED are 2-pin NIC LED headers. Attach NIC LED cables to NIC1 and NIC2 LED indicators to display network activities. Refer to the table on the right for pin definitions.

LAN1/LAN2 LED Pin Definitions (JF1)	
Pin#	Definition
9/11	Vcc
10/12	Ground

## Overheat (OH)/Fan Fail

Connect an LED cable to OH/Fan Fail connections on pins 7 and 8 of JF1 to provide warnings for chassis overheat/fan failure. Refer to the table on the right for pin definitions.

OH/Fan Fail LED Pin Definitions (JF1)	
Pin#	Definition
7	Vcc/Blue UID LED
8	OH/Fan Fail LED

OH/Fan Fail Indicator Status	
State	Definition
Off	Normal
On	Overheat
Flash- ing	Fan Fail

A. NIC1 LED

B. NIC2 LED

C. OH/Fan Fail

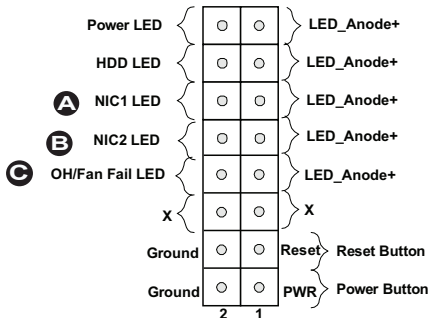

### Reset Button

The Reset Button connection is located on pins 3 and 4 of JF1. Attach it to a hardware reset switch on the computer case to reset the system. Refer to the table on the right for pin definitions.

Reset Button Pin Definitions (JF1)	
Pin#	Definition
3	Reset
4	Ground

### Power Button

The Power Button connection is located on pins 1 and 2 of JF1. Momentarily contacting both pins will power on/off the system. This button can also be configured to function as a suspend button (with a setting in the BIOS - see Chapter 4). To turn off the power in the suspend mode, press the button for at least 4 seconds. Refer to the table on the right for pin definitions.

Power Button Pin Definitions (JF1)	
Pin#	Definition
1	Signal
2	+3V Standby

A. Reset Button

B. PWR Button

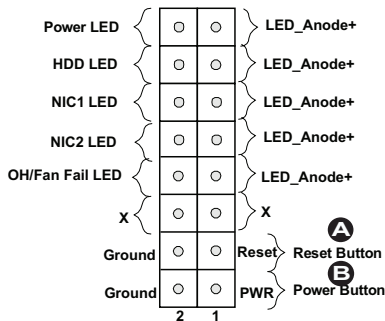

## 2-6 Connecting Cables

This section provides brief descriptions and pin-out definitions for onboard headers and connectors. Be sure to use the correct cable for each header or connector. For information on Backpanel USB and Front Panel USB ports, refer to Page 2-17. For Front Panel Audio, please refer to Page 2-19.

### ATX Main PWR & CPU PWR Connectors (JPW1 & JPW2)

The 24-pin main power connector (JPW1) is used to provide power to the motherboard. The 4-pin CPU PWR connector (JPW2) is also required for the processor. These power connectors meet the SSI EPS 12V specification. See the table on the right for pin definitions.

ATX Power 24-pin Connector Pin Definitions (JPW1)			
Pin#	Definition	Pin #	Definition
13	+3.3V	1	+3.3V
14	-12V	2	+3.3V
15	COM	3	COM
16	PS_ON	4	+5V
17	COM	5	COM
18	COM	6	+5V
19	COM	7	COM
20	Res (NC)	8	PWR_OK
21	+5V	9	5VSB
22	+5V	10	+12V
23	+5V	11	+12V
24	COM	12	+3.3V

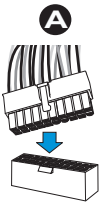

24-Pin Main PWR



4-Pin Processor PWR

12V 8-pin Power Connector Pin Definitions	
Pins	Definition
1 through 4	Ground
5 through 8	+12V

(Required)

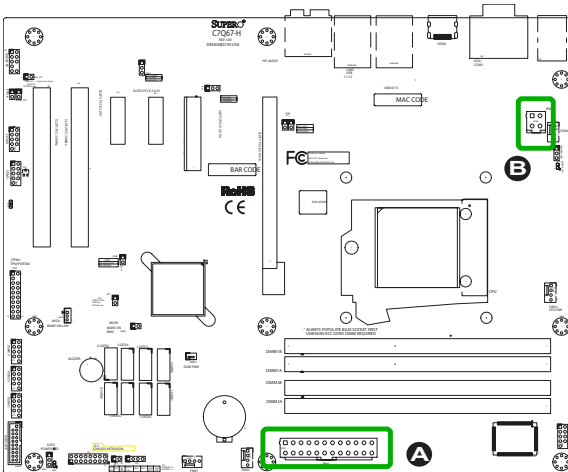

A. 24-Pin ATX Main PWR

B. 4-Pin Processor PWR

**Fan Headers (Fan 1 ~ Fan 4)**

The C7Q67-H has four fan headers (Fan 1~Fan 4). These fans are 4-pin fan headers. Although pins 1-3 of the fan headers are backward compatible with the traditional 3-pin fans, we recommend the use 4-pin fans to take advantage of the fan speed control in the BIOS Hardware Monitoring section. This allows the BIOS to automatically adjust fan speeds based on the motherboard's detected system temperature. Refer to the table on the right for pin definitions.

Fan Header Pin Definitions	
Pin#	Definition
1	Ground (Black)
2	2.5A/+12V (Red)
3	Tachometer
4	PWM_Control

**Chassis Intrusion (JL1)**

A Chassis Intrusion header is located at JL1 on the motherboard. Attach the appropriate cable from the chassis to inform you of a chassis intrusion when the chassis is opened.

Chassis Intrusion Pin Definitions (JL1)	
Pin#	Definition
1	Intrusion Input
2	Ground

- A. Fan 1 (CPU Fan)
- B. Fan 2
- C. Fan 3
- D. Fan 4
- E. Chassis Intrusion

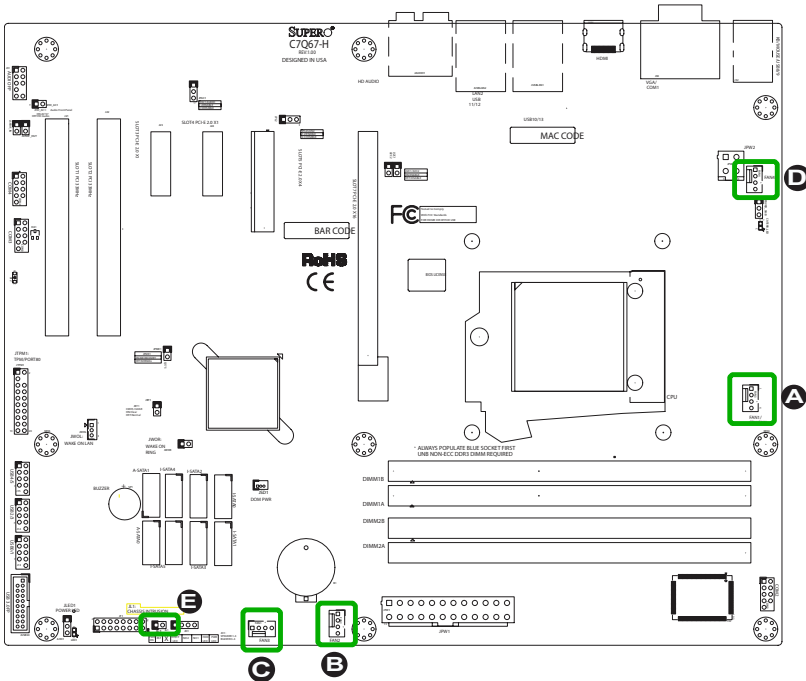

### Internal Buzzer (SP1)

The Internal Buzzer (SP1) can be used to provide audible indications for various beep codes. See the table on the right for pin definitions.

Internal Buzzer Pin Definition		
Pin#	Definitions	
Pin 1	Pos. (+)	Beep In
Pin 2	Neg. (-)	Alarm Speaker

### Speaker (JD1)

On the JD1 header, Pins 3~4 are used for internal speaker. Close Pins 3~4 with a cap to use the onboard speaker. If you wish to use an external speaker, close Pins 1~4 with a cable. See the table on the right for pin definitions.

Speaker Connector Pin Definitions	
Pin Setting	Definition
Pins 3~4	Internal Speaker
Pins 1~4	External Speaker

A. Internal Buzzer

B. Speaker Header

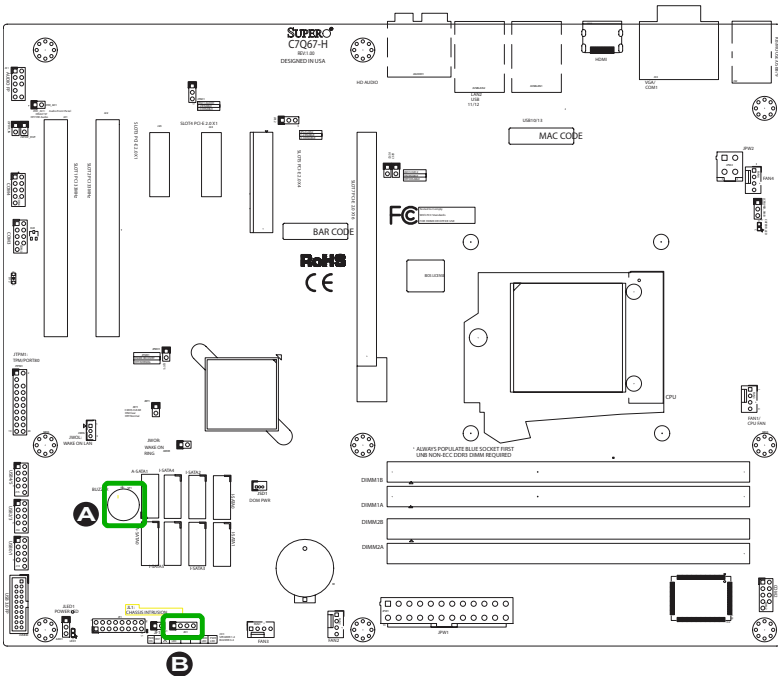

**Onboard Power LED (JLED)**

An onboard Power LED header is located at JLED. This Power LED header is connected to Front Control Panel located at JF1 to indicate the status of system power. See the table on the right for pin definitions.

Onboard PWR LED Pin Definitions	
Pin#	Definition
1	VCC
2	No Connection
3	Connection to PWR LED in JF1

**Serial Ports (COM1 ~ COM4)**

In addition to COM1, which is located on the I/O back panel, there are three Serial port headers on the motherboard for COM2, COM3 and COM4. See the table on the right for pin definitions.

Serial Ports-COM2/COM3/COM4 Pin Definitions			
Pin #	Definition	Pin #	Definition
1	DCD	6	DSR
2	RXD	7	RTS
3	TXD	8	CTS
4	DTR	9	RI
5	Ground	10	N/A

- A. PWR LED
- B. COM2
- C. COM3
- D. COM4
- E. COM1

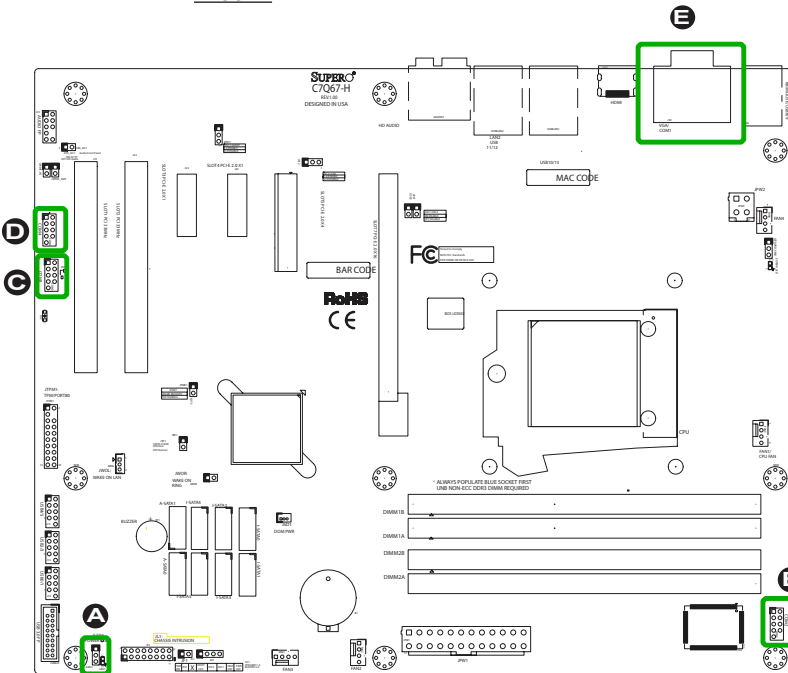

### DOM PWR Connector (JSD1)

The Disk-On-Module (DOM) power connector, located at JSD1, provides 5V (Gen1/Gen) power to a solid state DOM storage device connected to one of the SATA ports. See the table on the right for pin definitions.

DOM PWR Pin Definitions	
Pin#	Definition
1	5V
2	Ground
3	Ground

### Wake-On-LAN (JWOL)

The Wake-On-LAN header is located at JWOL on the motherboard. See the table on the right for pin definitions. (You must also have a LAN card with a Wake-On-LAN connector and cable to use this feature.)

Wake-On-LAN Pin Definitions (JWOL)	
Pin#	Definition
1	+5V Standby
2	Ground
3	Wake-up

A. DOM PWR

B. JWOL

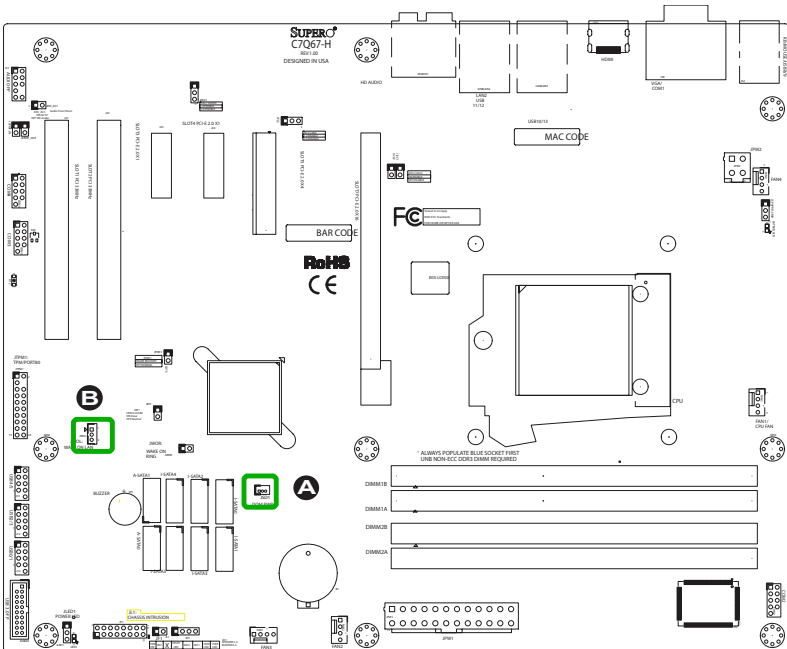

### Wake-On-Ring (JWOR)

The Wake-On-Ring header is located at JWOR. This function allows your computer to wake up when receiving an incoming call to the modem while in the suspend state. This header is provided to support legacy devices. See the table on the right for pin definitions.

Wake-On-Ring Pin Definitions	
Pin#	Definition
1	Ground
2	Wake-up

### SPDIF IN / SPDIF OUT (JSPDIF\_IN/ JSPDIF\_OUT)

The SP/DIF In (JSPDIF\_IN) and SP/DIF Out (JSPDIF\_OUT) are used for digital audio. You will also need the appropriate cables to use these features.

SPDIF_In Pin Definitions	
Pin#	Definition
1	S/PDIF_In
2	Ground

SPDIF_Out Pin Definitions	
Pin#	Definition
1	S/PDIF_Out
2	Ground

A. JWOR

B. SPDIF\_IN

C. SPDIF\_OUT

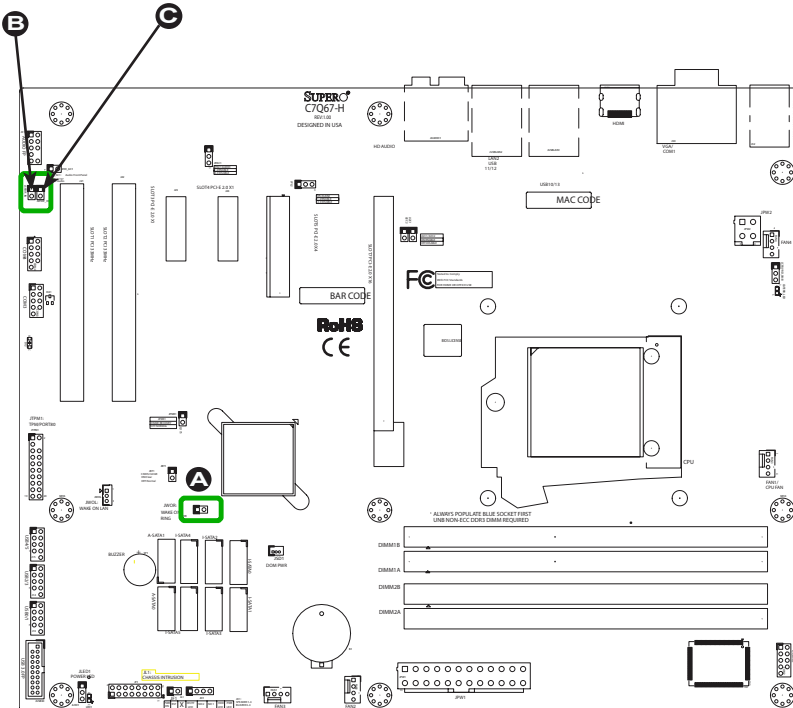

## 2-7 Jumper Settings

### Explanation of Jumpers

To modify the operation of the motherboard, jumpers can be used to choose between optional settings. Jumpers create shorts between two pins to change the function of the connector. Pin 1 is identified with a square solder pad on the printed circuit board.



**Note:** On two pin jumpers, "Closed" means the jumper is on, and "Open" means the jumper is off the pins.

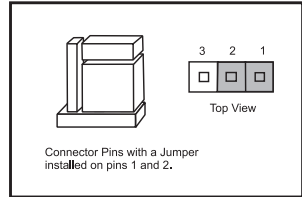
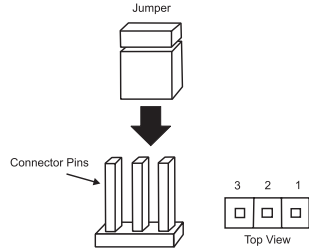

### LAN Port Enable/Disable (JPL2)

Jumper JPL2 enables or disables LAN Port 2 on the motherboard. See the table on the right for jumper settings. The default setting is enabled.

GLAN Enable Jumper Settings	
Pin#	Definition
1-2	Enabled (default)
2-3	Disabled

#### A. LAN Port 2 Enable

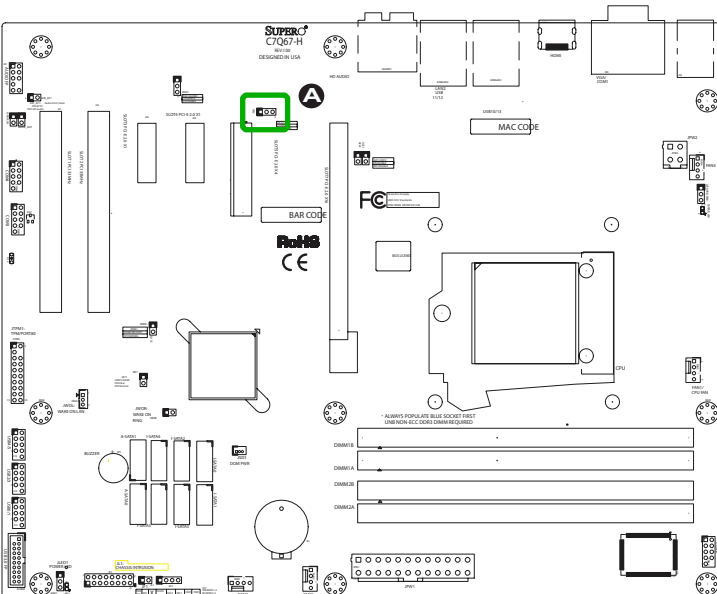

### CMOS Clear (JBT1)

JBT1 is used to clear the saved system setup stored in the CMOS chip. To clear the contents of the CMOS, completely shut down the system, remove the AC power cord and then short JBT1 with a jumper. Remove the jumper before powering on the system again. This will erase all user settings and revert everything to their factory-set defaults.

### PCI Slot SMB Enable (I<sup>2</sup>C1/I<sup>2</sup>C2)

Use Jumpers I<sup>2</sup>C1/I<sup>2</sup>C2 to enable PCI SMB (System Management Bus) support to improve system management for the PCI slots. See the table on the right for jumper settings.

PCI Slot_SMB Enable Jumper Settings	
Jumper Setting	Definition
Short	Enabled
Open (Default)	Disabled

A. Clear CMOS

B. JI<sup>2</sup>C1

C. JI<sup>2</sup>C2

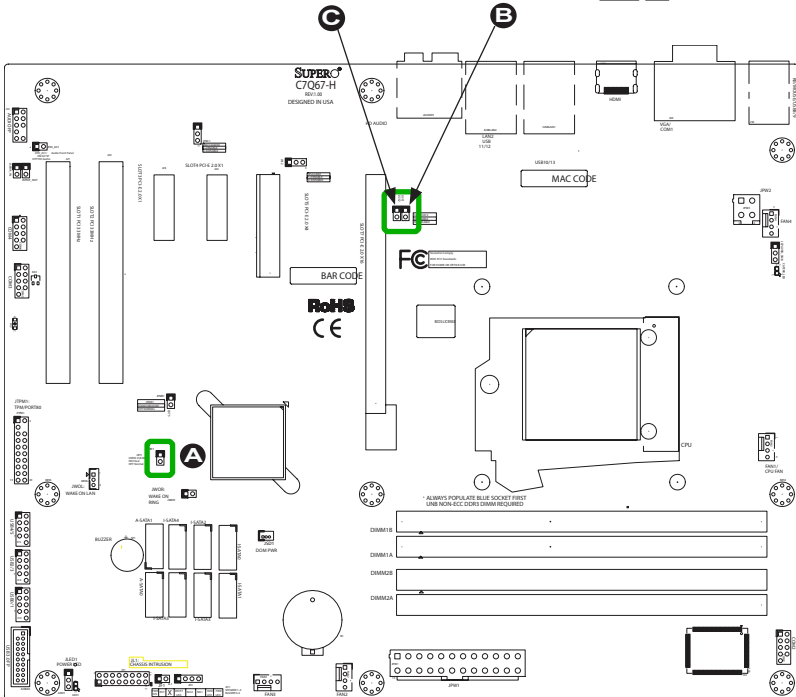

### ME Recovery Enable (JPME1)

Close JPME1 to enable ME (Manufacture Mode) Recovery. See the table on the right for jumper settings.

ME Recovery Jumper Settings	
Settings	Definition
On	Enabled
Off	Normal (Default)

### HD FP Audio/AC' 97 FP Audio Select (JHD AC1)

Jumper JHD AC1 allows the user to select between High-Definition Front Panel Audio and AC' 97 Front Panel Audio support. See the table on the right for jumper settings.

HD Audio/AC' 97 Audio Select Jumper Settings	
Settings	Definition
On	AC'97 Audio Front Panel
Off	HD Audio Front Panel (Default)

A. ME Recovery

B. HD Audio/AC'97 Audio Select

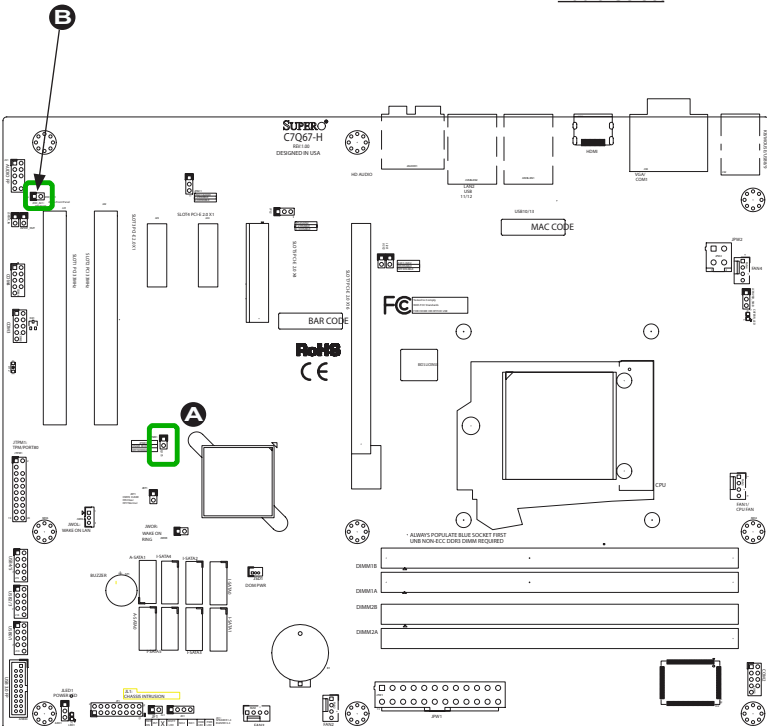

### Audio Enable (JPAC1)

JPAC1 allows you to enable or disable the onboard audio support. The default position is on pins 1 and 2 to enable onboard audio connections. See the table on the right for jumper settings.

Audio Enable/Disable Jumper Settings	
Both Jumpers	Definition
Pins 1-2	Enabled
Pins 2-3	Disabled

#### A. Audio Enable

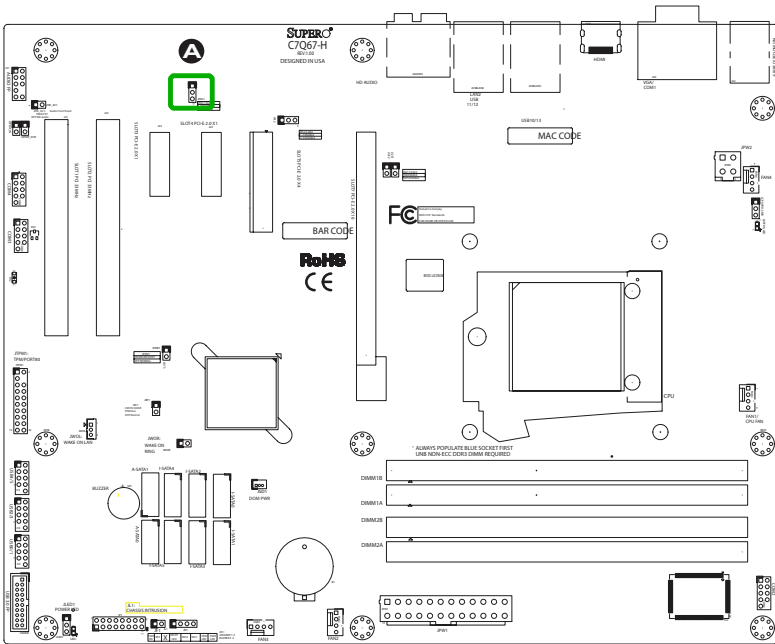

## 2-8 Onboard Indicators

### LAN 1/LAN 2 LEDs

Two LAN ports (LAN 1/LAN 2) are located on the I/O backplane of the motherboard. Each Ethernet LAN port has two LEDs. The yellow LED indicates activity, while the Link LED may be green, amber, or off to indicate the speed of the connections. See the tables at right for more information.

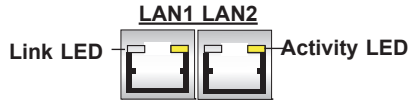

LAN 1/LAN 2 Link LEDs (Green/Amber/Off)	
LED Color	Definition
Off	No Connection or 10 Mbps
Green	100 Mbps
Amber	1 Gbps

### Onboard Power LED (LED1)

An Onboard Power LED is located at LED1 on the motherboard. When LED1 is on, the AC power cable is connected. Make sure to disconnect the power cable before removing or installing any component. See the layout below for the LED location.

Onboard PWR LED Indicator LED Status	
Status	Definition
Off	System Off
On	System on, or System off and PWR Cable Connected

- A. LAN Port 1
- B. LAN Port 2
- C. PWR LED

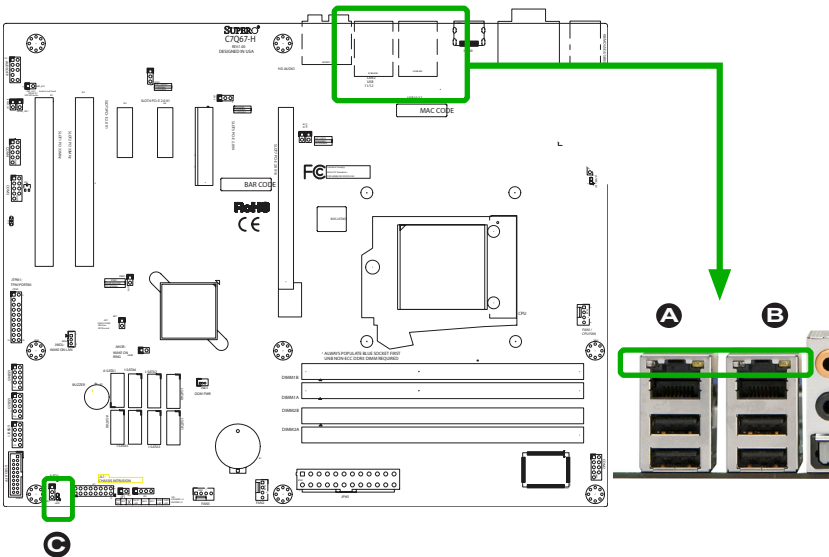

## 2-9 SATA Connections

### SATA Connections (I-SATA0~I-SATA5)

Four Serial ATA (SATA) 3.0 connectors (I-SATA 0/1, A-SATA 0/1) are located on the motherboard. In addition, four SATA 2.0 (I-SATA 2~5) connectors are also located on the board. The SATA 2.0 ports are supported by the Intel Q67 PCH chip; while SATA 3.0 ports are supported by the Intel PCH and ASMedia SATA Controllers. The SATA 3.0 ports support RAID 0, 1 while the SATA 2.0 ports support RAID 0, 1, 5 & 10. These Serial Link connections provide faster data transmission than legacy Parallel ATA. See the table on the right for pin definitions.

C7Q67-H SATA Connector Types	
Port#	Connection Type
I-SATA 0/1,	SATA 3.0
I-SATA 2/3/4/5	SATA 2.0
A-SATA 0/1	SATA 3.0

SATA 2.0/3.0 Connectors Pin Definitions	
Pin#	Signal
1	Ground
2	SATA_TXP
3	SATA_TXN
4	Ground
5	SATA_RXN
6	SATA_RXP
7	Ground

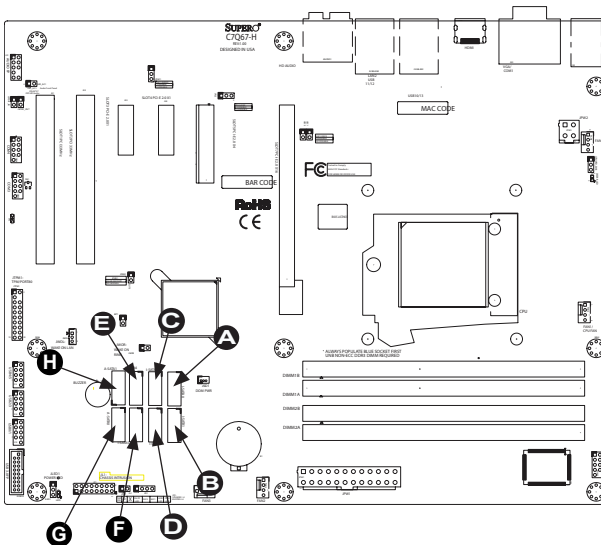

- A. I-SATA 3.0 #0
- B. I-SATA 3.0 #1
- C. I-SATA 2.0 #2
- D. I-SATA 2.0 #3
- E. I-SATA 2.0 #4
- F. I-SATA 2.0 #5
- G. A-SATA 3.0 #0
- H. A-SATA 3.0 #1

## Chapter 3

# Troubleshooting

### 3-1 Troubleshooting Procedures

Use the following procedures to troubleshoot your system. If you have followed all of the procedures below and still need assistance, refer to the 'Technical Support Procedures' and/or 'Returning Merchandise for Service' section(s) in this chapter. Always disconnect the AC power cord before adding, changing or installing any hardware components.

#### Before Power On

1. Make sure that the Standby PWR LED is not on. (**Note:** If it is on, the onboard power is on. Be sure to unplug the power cable before installing or removing the components.)
2. Make sure that there are no short circuits between the motherboard and chassis.
3. Disconnect all ribbon/wire cables from the motherboard, including those for the keyboard and mouse. Also, be sure to remove all add-on cards.
4. Install a CPU and heatsink (-be sure that it is fully seated) and then connect the chassis speaker and the power LED to the motherboard. Check all jumper settings as well.

#### No Power

1. Make sure that there are no short circuits between the motherboard and chassis.
2. Make sure that all jumpers are set to their default positions.
3. Check if the 115V/230V switch on the power supply is properly set.
4. Turn the power switch on and off to test the system.
5. The battery on your motherboard may be old. Check to make sure that it still supplies ~3VDC. If it does not, replace it with a new one.

## No Video

1. If the power is on, but you have no video--in this case, you will need to remove all the add-on cards and cables first.
2. Use the speaker to determine if any beep codes exist. (Refer to Appendix A for details on beep codes.)
3. Remove all memory modules and turn on the system. (If the alarm is on, check the specs of memory modules, reset the memory or try a different one.)

## Memory Errors

1. Make sure that the DIMM modules are properly installed and fully seated in the slots.
2. You should be using unbuffered Non-ECC DDR3 (1.5V) 1333/1066 MHz memory (recommended by the manufacturer). Also, it is recommended that you use the memory modules of the same type and speed for all DIMMs in the system. Do not use memory modules of different sizes, different speeds and different types on the same motherboard.
3. Check for bad DIMM modules or slots by swapping modules between slots to see if you can locate the faulty ones.
4. Check the switch of 115V/230V power supply.

## Losing the System's Setup Configuration

1. Please be sure to use a high quality power supply. A poor quality power supply may cause the system to lose CMOS setup information. Refer to Section 1-5 for details on recommended power supplies.
2. The battery on your motherboard may be old. Check to verify that it still supplies ~3VDC. If it does not, replace it with a new one.
3. If the above steps do not fix the Setup Configuration problem, contact your vendor for repairs.

## 3-2 Technical Support Procedures

Before contacting Technical Support, please make sure that you have followed all the steps listed below. Also, Note that as a motherboard manufacturer, Supermicro

---

does not sell directly to end users, so it is best to first check with your distributor or reseller for troubleshooting services. They should know of any possible problem(s) with the specific system configuration that was sold to you.

1. Please go through the 'Troubleshooting Procedures' and 'Frequently Asked Question' (FAQ) sections in this chapter or see the FAQs on our website (<http://www.supermicro.com/support/faqs/>) before contacting Technical Support.
2. BIOS upgrades can be downloaded from our website at (<http://www.supermicro.com/support/bios/>).



**Note:** Not all BIOS can be flashed. Some cannot be flashed; it depends on the boot block code of the BIOS.

3. If you've followed the instructions above to troubleshoot your system, and still cannot resolve the problem, then contact Supermicro's technical support and provide them with the following information:
  - Motherboard model and PCB revision number
  - BIOS release date/version (this can be seen on the initial display when your system first boots up)
  - System configuration
  - An example of a Technical Support form is on our website at (<http://www.supermicro.com/support/contact.cfm>).
4. Distributors: For immediate assistance, please have your account number ready when placing a call to our technical support department. We can be reached by e-mail at [support@supermicro.com](mailto:support@supermicro.com), by phone at: (408) 503-8000, option 2, or by fax at (408)503-8019.

### 3-3 Frequently Asked Questions

**Question:** What type of memory does my motherboard support?

**Answer:** The C7Q67-H supports up to 32GB of unbuffered Non-ECC DDR3 SDRAM (1.5V, 1333/1066 MHz). See Section 2-3 for details on installing memory.

**Question:** How do I update my BIOS?

**Answer:** We do NOT recommend that you upgrade your BIOS if you are not experiencing any problems with your system. Updated BIOS files are located on

our website at <http://www.supermicro.com/support/bios/>. Please check our BIOS warning message and the information on how to update your BIOS on our web site. Select your motherboard model and download the BIOS ROM file to your computer. Also, check the current BIOS revision to make sure that it is newer than your BIOS before downloading. You may choose the zip file or the .exe file. If you choose the zipped BIOS file, please unzip the BIOS file onto a bootable device or a USB pen/thumb drive. To flash the BIOS, run the batch file named "ami.bat" with the new BIOS ROM file from your bootable device or USB pen/thumb drive. Use the following format:

```
F:\> ami.bat BIOS-ROM-filename.xxx <Enter>
```



**Note:** Always use the file named "ami.bat" to update the BIOS, and insert a space between "ami.bat" and the filename. The BIOS-ROM-filename will bear the motherboard name (i.e., C7Q67-H) and build version as the extension. For example, "C7Q67-H0.115". When completed, your system will automatically reboot.

If you choose the .exe file, please run the .exe file under Windows to create the BIOS flash floppy disk. Insert the floppy disk into the system you wish to flash the BIOS. Then, boot the system to the floppy disk. The BIOS utility will automatically flash the BIOS without any prompts. Please note that this process may take a few minutes to complete. Do not be concerned if the screen is paused for a few minutes.

When the BIOS flashing screen is completed, the system will reboot and will show "Press F1 or F2". At this point, you will need to load the BIOS defaults. Press <F1> to go to the BIOS setup screen, and press <F9> to load the default settings. Next, press <F10> to save and exit. The system will then reboot.



**Warning:** Do not shut down or reset the system while updating the BIOS to prevent possible system boot failure!



**Important:** The SPI BIOS chip installed on this motherboard is not removable. To repair or replace a damaged BIOS chip, please send your motherboard to RMA at Supermicro for service.

**Question:** I think my BIOS is corrupted. How can I recover my BIOS?

**Answer:** Please see Appendix C-BIOS Recovery for detailed instructions.

**Question:** What's on the CD that came with my motherboard?

**Answer:** The supplied compact disc has quite a few drivers and programs that will greatly enhance your system. We recommend that you review the CD and install the applications you need. Applications on the CD include chipset drivers for Windows, security programs, and audio drivers.

**Question:** Why do I get an error message "IASTOR.SYS read error" and "press F6 to install Intel RAID driver" when installing Windows on my motherboard?

**Answer:** To solve this issue, disable the IPMI jumper. Another solution is to use a USB floppy drive instead of the onboard floppy drive. For the IPMI jumper location, please check Chapter 1.

**Question:** What is the heatsink part number for my C7Q67-H motherboard?

**Answer:** For the 1U passive heatsink, ask for SNK-P0046P (back plate is included). For the 2U active heatsink, use SNK-P0046A4.

**Question:** Why can't I recover the BIOS even when I've followed the instructions in the user's manual for the motherboard?

**Answer:** Please disable the IPMI jumper and try it again. For the jumper location, please check Chapter 1.

## 3-4 Battery Removal and Installation

### Battery Removal

To remove the onboard battery, follow the steps below:

1. Power off your system and unplug your power cable.
2. Locate the onboard battery as shown below.
3. Using a tool such as a pen or a small screwdriver, push the battery lock outwards to unlock it. Once unlocked, the battery will pop out from the holder.
4. Remove the battery.

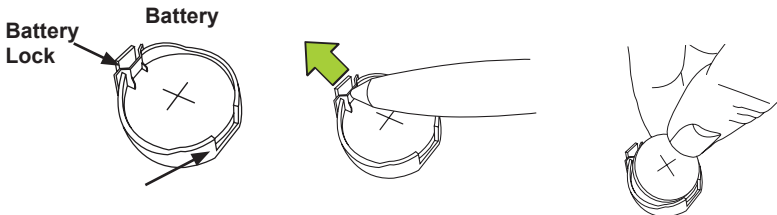

### Proper Battery Disposal



**Warning!** Please handle used batteries carefully. Do not damage the battery in any way; a damaged battery may release hazardous materials into the environment. Do not discard a used battery in the garbage or a public landfill. Please comply with the regulations set up by your local hazardous waste management agency to dispose of your used battery properly.

## Battery Installation

1. To install an onboard battery, follow the steps 1& 2 above and continue below:
2. Identify the battery's polarity. The positive (+) side should be facing up.
3. Insert the battery into the battery holder and push it down until you hear a click to ensure that the battery is securely locked.



**Warning:** When replacing a battery, be sure to only replace it with the same type.

### Battery Holder

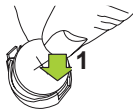
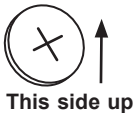

## 3-5 Returning Merchandise for Service

A receipt or copy of your invoice marked with the date of purchase is required before any warranty service will be rendered. You can obtain service by calling your vendor for a Returned Merchandise Authorization (RMA) number. For faster service, you may also obtain RMA authorizations online (<http://www.supermicro.com/support/rma/>). When you return the motherboard to the manufacturer, the RMA number should be prominently displayed on the outside of the shipping carton, and mailed prepaid or hand-carried. Shipping and handling charges will be applied for all orders that must be mailed when service is complete.

This warranty only covers normal consumer use and does not cover damages incurred in shipping or from failure due to the alteration, misuse, abuse or improper maintenance of products.

During the warranty period, contact your distributor first for any product problems.

---

---

## Chapter 4

### BIOS

#### 4-1 Introduction

This chapter describes the AMI BIOS Setup Utility for the C7Q67-H. The ROM BIOS is stored in a Flash EEPROM and can be easily updated. This chapter describes the basic navigation of the AMI BIOS Setup Utility setup screens.



**Note:** For AMI BIOS Recovery, please refer to the UEFI BIOS Recovery Instructions in Appendix C.

#### Starting BIOS Setup Utility

To enter the AMI BIOS Setup Utility screens, press the <Delete> key while the system is booting up.



**Note:** In most cases, the <Delete> key is used to invoke the AMI BIOS setup screen. There are a few cases when other keys are used, such as <F1>, <F2>, etc.

Each main BIOS menu option is described in this manual. The Main BIOS setup menu screen has two main frames. The left frame displays all the options that can be configured. Grayed-out options cannot be configured. Options in blue can be configured by the user. The right frame displays the key legend. Above the key legend is an area reserved for a text message. When an option is selected in the left frame, it is highlighted in white. Often a text message will accompany it. (**Note:** the AMI BIOS has default text messages built in. Supermicro retains the option to include, omit, or change any of these text messages.)

The AMI BIOS Setup Utility uses a key-based navigation system called "hot keys". Most of the AMI BIOS setup utility "hot keys" can be used at any time during the setup navigation process. These keys include <F1>, <F10>, <Enter>, <ESC>, arrow keys, etc.



**Note:** Options printed in **Bold** are default settings.

#### How To Change the Configuration Data

The configuration data that determines the system parameters may be changed by entering the AMI BIOS Setup utility. This Setup utility can be accessed by pressing <Del> at the appropriate time during system boot.

## How to Start the Setup Utility

Normally, the only visible Power-On Self-Test (POST) routine is the memory test. As the memory is being tested, press the <Delete> key to enter the main menu of the AMI BIOS Setup Utility. From the main menu, you can access the other setup screens. An AMI BIOS identification string is displayed at the left bottom corner of the screen, below the copyright message.



**Warning!** Do not upgrade the BIOS unless your system has a BIOS-related issue. Flashing the wrong BIOS can cause irreparable damage to the system. In no event shall Supermicro be liable for direct, indirect, special, incidental, or consequential damages arising from a BIOS update. If you have to update the BIOS, do not shut down or reset the system while the BIOS is updating. This is to avoid possible boot failure.

## 4-2 Main Setup

When you first enter the AMI BIOS Setup Utility, you will enter the Main setup screen. You can always return to the Main setup screen by selecting the Main tab on the top of the screen. The Main BIOS Setup screen is shown below.

Aptio Setup Utility - Copyright (C) 2011 American Megatrends, Inc.

Main Advanced Security Boot Exit

<b>System Overview</b>		Set the time. Use tab to switch between Time elements.
System Time	[12:10:24]	
System Date	[Thu 02/09/2012]	
Supermicro C7Q67-H		
BIOS Version	1.00	
ME Firmware Version	7.0.10.1203	
Build Date	12/29/2011	
<b>Processor</b>		
Intel(R) Core(TM) i3-2120 CPU@ 3.30GHz	3300MHz	←+ : Select Screen
Speed		F1 : Select Item
Physical Count	1	Enter: Select
Logical Count	4	+/- : Change Opt.
<b>System Memory</b>		
Size	2048MB	F1 : General Help
		F2 : Previous Values
		F3 : Optimized Defaults
		F4 : Save & Exit
		ESC : Exit

Version 2.11.1210. Copyright (C) 2011 American Megatrends, Inc.

**System Overview:** The following BIOS information will be displayed:

### **System Time/System Date**

Use this option to change the system time and date. Highlight *System Time* or *System Date* using the arrow keys. Enter new values through the keyboard. Press the <Tab> key or the arrow keys to move between fields. The date must be entered in Day MM/DD/YY format. The time is entered in HH:MM:SS format.



**Note:** The time is in the 24-hour format. For example, 5:30 P.M. appears as 17:30:00.

The following BIOS items will also be displayed:

### **Supermicro C7Q67-H**

#### **BIOS Version**

#### **ME Firmware Version**

#### **Build Date**

#### **Processor**

The AMI BIOS will automatically display the status of the processor used in the motherboard as shown below:

#### **Type of Processor**

#### **Speed**

#### **Physical Count**

#### **Logical Count**

#### **System Memory**

This displays the size of memory available in the system:

#### **Size**

## 4-3 Advanced Setup Configurations

Use the arrow keys to select Boot Setup and press <Enter> to access the submenu items:

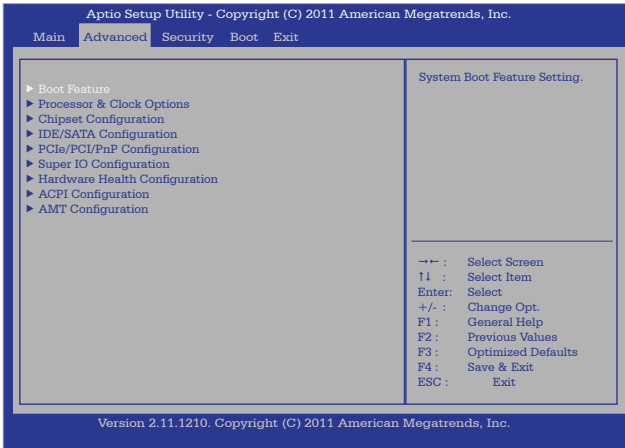

### ► Boot Feature

#### Quiet Boot

Use this feature to select the screen display between POST messages or the OEM logo at bootup. Select Disabled to display the POST messages. Select Enabled to display the OEM logo instead of the normal POST messages. The options are **Enabled** and Disabled.

#### AddOn ROM Display Mode

Use this feature to set the display mode for Option ROM. The options are **Force BIOS** and Keep Current.

#### Bootup Num-Lock

This feature selects the Power-on state for the Numlock key. The options are Off and **On**.

#### Wait For 'F1' If Error

This forces the system to wait until the 'F1' key is pressed if an error occurs. The options are Disabled and **Enabled**.

#### Interrupt 19 Capture

Interrupt 19 is the software interrupt that handles the boot disk function. When this item is set to Enabled, the ROM BIOS of the host adaptors will "capture" Interrupt 19 at bootup and allow the drives that are attached to these host adaptors to function

---

as bootable disks. If this item is set to Disabled, the ROM BIOS of the host adaptors will not capture Interrupt 19, and the drives attached to these adaptors will not function as bootable devices. The options are **Enabled** and Disabled.

## ►Power Configuration

### Power Button Function

This feature controls how the system shuts down when the power button is pressed. Select `4_Seconds_Override` for the user to power off the system after pressing and holding the power button for 4 seconds or longer. Select `Instant Off` to instantly power off the system as soon as the user presses the power button. The options are `4 Second Override` and **Instant Off**.

### Restore on AC Power Loss

Use this feature to set the power state after a power outage. Select `Power-Off` for the system power to remain off after a power loss. Select `Power-On` for the system power to be turned on after a power loss. Select `Last State` to allow the system to resume its last power state before a power loss. The options are `Power-On`, `Power-Off` and **Last State**.

### Resume on RTC Alarm

This feature enables or disables system resume on RTC (Real Time Clock) alarm. The options are **Disabled** and Disabled.

## ►Processor & Clock Options



**Warning:** Take Caution when changing the Advanced settings. An incorrect value, a very high DRAM frequency or an incorrect DRAM timing setting may cause system to become unstable. When this occurs, revert to the setting to its manufacture default setting.

### Clock Spread Spectrum

If Enabled, the BIOS will monitor the level of Electromagnetic Interference caused by the components and will attempt to decrease the interference whenever needed. The options are Enabled and **Disabled**.

### Hardware Prefetcher (Available when supported by the CPU)

If set to Enabled, the hardware prefetcher will prefetch streams of data and instructions from the main memory to the L2 cache to improve CPU performance. The options are Disabled and **Enabled**.

### Adjacent Cache Line Prefetch (Available when supported by the CPU)

Select Enabled for the CPU to prefetch both cache lines for 128 bytes as comprised. Select Disabled for the CPU to prefetch both cache lines for 64 bytes. The options are Disabled and **Enabled**.

### Intel<sup>®</sup> Virtualization Technology (Available when supported by the CPU)

Select Enabled to use the Intel Virtualization Technology to allow one platform to run multiple operating systems and applications in independent partitions, creating multiple "virtual" systems in one physical computer. The options are **Enabled** and Disabled.



**Note:** If there is any change to this setting, you will need to power off and restart the system for the change to take effect. Please refer to Intel's web site for detailed information.

### Execute-Disable Bit Capability (Available when supported by the OS and the CPU)

Set to Enabled to enable the Execute Disable Bit which will allow the processor to designate areas in the system memory where an application code can execute and where it cannot, thus preventing a worm or a virus from flooding illegal codes to overwhelm the processor or damage the system during an attack. The default is **Enabled**. (Refer to Intel and Microsoft Web Sites for more information.)

### Intel<sup>®</sup> Hyper Threading Technology (Available when supported by the OS and the CPU)

Select Enabled to enable Hyper\_Threading support to increase CPU performance. The options are **Enabled** and Disabled.

### Active Processor Cores

Enables selection of the number of the processor's core to activate. (Please refer to Intel's web site for more information.) The options are **All**, and 1.

### Power Technology

Use this feature to select a power-saving scheme for the motherboard. The options are Disabled, **Energy Efficient** and Custom. If Custom is selected, the following options become available:

#### EIST

EIST (Enhanced Intel SpeedStep Technology) allows the system to automatically adjust processor voltage and core frequency in an effort to reduce power

consumption and heat dissipation. **Please refer to Intel's web site for detailed information.** The options are Disabled and **Enabled**.

#### **P-STATE Coordination**

This feature selects the type of coordination for the P-State of the processor. P-State is a processor operational state that reduces the processor's voltage and frequency. This makes the processor more energy efficient, resulting in further energy gains. The options are **HW\_ALL**, **SW\_ALL** and **SW-ANY**.

#### **CPU C3 Report**

Select Enabled for the CPU to report C3 (ACPI C2) state to the operating system. The options are **Disabled** and **Enabled**.

#### **CPU C6 Report**

Select Enabled for the CPU to report C6 (ACPI C3) state to the operating system. The options are Disabled and **Enabled**.

#### **Package C-State limit**

Select Auto for the AMI BIOS to automatically set the limit on the C-State package register. The options are C0, C1, C6, C7 and **No Limit**.

### **►Turbo Boost Technology (Available when Intel® EIST technology is Enabled)**

This feature allows processor cores to run faster than marked frequency in specific conditions.

#### **Factory Long Duration Power Limit**

This feature displays the value of the processor power consumption limit (in Watts) set by the manufacturer for a long duration time window.

#### **Long Duration Power Limit**

Use this feature to set the processor power consumption limit (in Watts) value for a long duration time window.

#### **Factory Long Duration Maintained**

This feature displays the manufacture-preset time value in milliseconds when the Long Duration Power Limit is maintained.

#### **Long Duration Maintained**

Use this feature to set the time value when the Long Duration Power Limit is maintained.

### Recommended Short Duration Power Limit

The system's power consumption may exceed the processor's default power setting and the Short Duration Power Limit when operating in the turbo mode. This feature displays the Short Duration Power Limit value recommended by the manufacturer for turbo mode operation. By increasing this value, the processor can provide better performance for a short duration operation. The default setting is **1.25\* Long Duration** (that means, 1.25 times the value of Long Duration Power Limit indicated above.)

### Short duration power limit

The system's power consumption may exceed the processor's default power setting and the Short Duration Power Limit when operating in the turbo mode. By increasing this value, the processor can provide better performance for a short duration operation.

## Chipset Configuration

**WARNING:** Setting the wrong values in the following sections may cause the system to malfunction.

### ►CPU Bridge Configuration

This item displays the current CPU Revision, Current CPU1 Memory Frequency, Memory Type and Memory Reference Code Revision.

#### Memory Frequency

This feature allows the user to select the memory speed. Under normal conditions, please set this to Auto. The options are **Auto**, Force DDR-800, Force DDR-1066, and Force DDR-1333.

### ►System Agent Configuration

This item displays the current North Bridge Revision.

#### VT-d

Select Enabled to enable Intel's Virtualization Technology support for Direct I/O VT-d by reporting the I/O device assignments to VMM through the DMAR ACPI Tables. This feature offers fully-protected I/O resource-sharing across the Intel platforms, providing the user with greater reliability, security and availability in networking and data-sharing. The settings are Enabled and **Disabled**.

---

**PCI Express Port**

This feature can force to enable or disable the onboard PCI Express port. The options are Disabled, Enabled and **Auto**.

**PEG Force Gen1**

This feature forces Gen1 support on the PCI Express Graphics (PEG) port. The options are **Disabled**, and Enabled.

**Detect Non-Compliant Device**

This feature enables or disables the detection of a non-compliant device that is attached to the PCI Express Graphics (PEG) port. The options are **Disabled**, and Enabled.

**Initiate Graphics Adapter**

This feature selects which graphics controller to use as a boot device. The options are IGD, PCI/IGD, PCI/PEG, **PEG/IGD** and PEG/PCI. .



**Note:** IGD = Integrated Graphics Device.

**IGD Memory**

This feature selects the amount of memory for the Integrated Graphics Device (IGD). The options are Disabled, 32M, **64M** and 128M.

**Render Standby**

This feature enables or disables render standby by the Internal Graphics Device (IGD). The options are Disabled and **Enabled**.

**IGD Multi-Monitor**

This feature enables or disables multi-monitor support by the Internal Graphics Device (IGD). The options are **Disabled** and Enabled.

**Memory Remap**

This feature enables or disables the memory above 4GB. The options are **Enabled** and Disabled.

**►South Bridge Configuration**

This item displays the current South Bridge configuration.

**GbE Controller**

Select Enabled to enable the onboard gigabit Ethernet controller. The settings are **Enabled** and Disabled.

### Wake on LAN from S5

Select Enabled to enable the capability to 'wake-up' the system from the S5 power state (Soft Off State) through the Ethernet controller. The settings are **Enabled** and Disabled.

### USB Functions

This feature will enable or disable the motherboard's USB functions. The options are **Enabled** and Disabled. If enabled, the following options are available:

#### Legacy USB Support

This feature enables support for legacy USB devices. Select Auto to disable legacy support if USB devices are not present. Select Disable to have USB devices available only for EFI applications. The options are **Enabled**, Disabled and Auto.

#### Port 60/64 Emulation

This feature enables or disables I/O port 60h/64h emulation support. This should be enabled for complete USB keyboard legacy support for non-USB-aware Operating Systems. The options are Disabled and **Enabled**.

#### BIOS EHCI Hand-Off

This item is for Operating Systems that does not support Enhanced Host Controller Interface (EHCI) hand-off. When enabled, EHCI ownership change will be claimed by the EHCI driver. The settings are **Enabled** and Disabled.

### Azalia HD Audio

Select Enabled to enable the Azalia High Definition Audio feature. The settings are **Enabled** and Disabled.

### Azalia Internal HDMI Codec

Select Enabled to enable the internal HDMI CODEC (Coder-Decoder) for Azalia. The settings are **Enabled** and Disabled.

### Frontside Audio Mode

This feature selects the type of audio output on the frontside audio header/interface. Select **HD Audio** for High Definition, otherwise select AC '97 for legacy audio.

**PCH IO Port 80 Decoding**

Selects Port 80 Decoding between LPC or PCI for debug purposes. The settings are **PCI** and **LPC**.

**Deep Sx**

Select Enabled to enable Deep Sleep State support. The settings are Enabled and **Disabled**.

**►On Board Chip Configuration**

This item displays the On Board Chip options.

**►ASMedia 1061 SATA Controller****ASMedia 1061 SATA Controller**

Select Enabled to activate the on board ASMedia SATA controller. The settings are **Enabled** and **Disabled**.

**►ASMedia 1042 XHCI Controller****ASMedia XHCI Controller**

Select Enabled to activate the on board ASMedia XHCI controller. The settings are **Enabled** and **Disabled**.

**Spread Spectrum Clocking**

Select Enabled to activate Spread Spectrum Clocking. The settings are Enabled and **Disabled**.

**Port A / Port B Battery Charge**

Select Enabled to activate the battery charging function on the USB ports. The settings are Enabled and **Disabled**.

**USB 3.0 Legacy Support**

This feature enables support for legacy USB devices on the USB 3.0 ports. The options are **Enabled** and **Disabled**.

**XHCI Hand-off**

Select Enabled for Operating Systems without XHCI hand-off support. The XHCI ownership change will be claimed by the XHCI driver. The settings are **Enabled** and **Disabled**.

► **PLX PEX8604-BA PCIe Gen2 Switch**

**Port 0 ~ Port 5**

This feature activates the specified PEX8604 PCIe port. The options are **Enabled** and **Disabled**.

**Read Pacing**

This feature activates Read Pacing on PEX8604 chip. The options are **Enabled** and **Disabled**.

► **IDE/SATA Configuration**

When this submenu is selected, the AMI BIOS automatically detects the presence of the IDE Devices and displays the following items:

**SATA Mode**

This item selects the mode for the installed drives. The options are **Disabled**, **IDE Mode**, **AHCI Mode** and **RAID Mode**.

**AHCI Mode**

The following items are displayed when AHCI Mode is selected:

**Aggressive Link Power Management**

This feature Enables or Disables Aggressive Link Power Management support for Cougar Point B0 stepping and later. The options are **Enabled** and **Disabled**.

**SATA Port0~Port5**

This item displays the information detected on the installed SATA drives on the particular SATA port.

**Staggered Spin Up**

Set this item to **Enabled** to enable Staggered Spin-up support. The options are **Enabled** and **Disabled**.

**Hot Plug**

Set this item to **Enabled** to enable hot-plugging. The options are **Enabled** and **Disabled**.

## IDE Mode

The following items are displayed when IDE Mode is selected:

### Serial-ATA Controller 0~1

This feature is used to activate/deactivate the SATA controller, and sets the compatibility mode. The options are Enhanced and **Compatible**. The default of Serial-ATA Controller 1 is **Enhanced**.

### SATA Port0~Port5

This item displays the information detected on the installed SATA drives on the particular SATA port.

## RAID Mode

The following items are displayed when RAID Mode is selected:

### SATA Port0~Port5

This item displays the information detected on the installed SATA drives on the particular SATA port.

### Hot Plug

Set this item to Enabled to enable hot-plugging. The options are Enabled and **Disabled**.

## ►PCIe/PCI/PnP Configuration

This feature allows the user to set the PCI/PnP configurations for the following items:

### PCI ROM Priority

When there are multiple Option ROMs (Legacy and EFI compatible), this feature specifies what Option ROM to launch. The options are **Legacy ROM** and EFI Compatible ROM.

### PCI Latency Timer

This feature sets the latency Timer of each PCI device installed on a PCI bus. Select 64 to set the PCI latency to 64 PCI bus clock cycles. The options are 32 PCI Bus Clocks, **64 PCI Bus Clocks**, 96 PCI Bus Clocks, 128 PCI Bus Clocks, 160 PCI Bus Clocks, 192 PCI Bus Clocks, 224 PCI Bus Clocks and 248 PCI Bus Clocks.

### Active State Power Management

Select Enabled to enable Active-State Power Management for signal transactions between L0 and L1 Links on the PCI Express Bus in order to maximize power-saving and transaction speeds. The options are Enabled and **Disabled**.

### PCIe Max Read Request Size

This item manually sets the maximum read request size of the PCI Express device or allows the system BIOS to choose the value (Auto). The options are **Auto**, 128 Bytes, 256 Bytes, 512 Bytes, 1024 Bytes, 2048 Bytes and 4096 Bytes

### PCI Slot 1 & 2 Option ROM

Use this feature to enable or disable PCI slot Option ROMs. The options are Disabled and **Enabled**.

### PCIe Slot 3, 4, 5, & 7 Option ROM

Use this feature to enable or disable PCIe slot Option ROMs. The options are Disabled and **Enabled**.

### Onboard LAN1/LAN2 Option ROM

This feature enables or disables the onboard ROM option for LAN1 and LAN2. The options are **Disabled** and Enabled.

## ► Super IO Device Configuration

### Nuvoton LPC I/O - NCT6776F

#### Serial Port 1 / Serial Port 2

Select Enabled to enable the onboard serial port. The options are **Enabled** and Disabled.

#### Serial Port 1 / Serial Port 2 Settings

This option specifies the base I/O port address and the Interrupt Request address of Serial Port 1 ~ 2. Select Auto to let the BIOS automatically assign the base I/O and IRQ address.

The options for Serial Port 1 are **Auto**, (IO=3F8h; IRQ=4), (IO=3F8h; IRQ=3, 4, 10, 11), (IO=2F8h; IRQ=3, 4, 10, 11), (IO=3E8h; IRQ=3, 4, 10, 11) and (IO=2E8h; IRQ=3, 4, 10, 11).

The options for Serial Port 2 are **Auto**, (IO=2F8h; IRQ=3), (IO=3F8h; IRQ=3, 4, 10, 11), (IO=2F8h; IRQ=3, 4, 10, 11), (IO=3E8h; IRQ=3, 4, 10, 11) and (IO=2E8h; IRQ=3, 4, 10, 11).

#### PS2 KB/MS Wake up

This feature is used to awaken the system from Standby mode by a PS/2 mouse or PS/2 keyboard. This must be enabled in the system level and Operating System (O/S) as well, if supported).

**S1 (OS Control)** - Enables system wake up from S1 (default).

S5 (OS Control) - Enables system wake up from S1/S3/S4/S5.

Force Enable - Wake up support is always enabled regardless whether it is disabled in the O/S.

Force Disable - Wake up support is always disabled regardless whether it is enabled in the O/S.

## ITE LPC I/O - IT8760

### Serial Port 3 / Serial Port 4

Select Enabled to enable the onboard serial port. The options are **Enabled** and Disabled.

### Serial Port 3 / Serial Port 4 Settings

This option specifies the base I/O port address and the Interrupt Request address of Serial Port 1 ~ 2. Select Auto to let the BIOS automatically assign the base I/O and IRQ address.

The options for Serial Port 3 are **Auto**, (IO=3E8h; IRQ=11), (IO=3F8h; IRQ=3, 4, 10, 11), (IO=2F8h; IRQ=3, 4, 10, 11), (IO=3E8h; IRQ=3, 4, 10, 11) and (IO=2E8h; IRQ=3, 4, 10, 11).

The options for Serial Port 4 are **Auto**, (IO=2E8h; IRQ=10), (IO=3F8h; IRQ=3, 4, 10, 11), (IO=2F8h; IRQ=3, 4, 10, 11), (IO=3E8h; IRQ=3, 4, 10, 11) and (IO=2E8h; IRQ=3, 4, 10, 11).

## ►Hardware Health Configuration

### Fan Speed Control Mode

This feature allows the user to decide how the system controls the speeds of the onboard fans. The CPU temperature and the fan speed are correlative. When the CPU on-die temperature increases, the fan speed will also increase for effective system cooling. Select "Full Speed" to allow the onboard fans to run at full speed (of 100% Pulse Width Modulation Duty Cycle) for maximum cooling. This setting is recommended for special system configuration or debugging. Select "Standard" for the onboard fans to run at 50% of the Initial PWM Cycle in order to balance the needs between system cooling and power saving. This setting is recommended for regular systems with normal hardware configurations. The options are Full Speed (@100% of PWM Cycle), and **Standard** (@50% of PWM Cycle).

## **CPU Temperature**

This feature displays the CPU temperature status in text ("Low", "Medium" or "High"):

Low – This level is considered as the 'normal' operating state. The CPU temperature is well below the CPU 'Temperature Tolerance'. The motherboard fans and CPU will run normally as configured in the BIOS (Fan Speed Control).

User intervention: No action required.

Medium – The processor is running warmer. This is a 'precautionary' level and generally means that there may be factors contributing to this condition, but the CPU is still within its normal operating state and below the CPU 'Temperature Tolerance'. The motherboard fans and CPU will run normally as configured in the BIOS. The fans may adjust to a faster speed depending on the Fan Speed Control settings.

User intervention: No action is required. However, consider checking the CPU fans and the chassis ventilation for blockage.

High – The processor is running hot. This is a 'caution' level since the CPU's 'Temperature Tolerance' has been reached (or has been exceeded) and may activate an overheat alarm:

The information provided above is for your reference only. For more information on thermal management, please refer to Intel's Web site at [www.Intel.com](http://www.Intel.com).

## **System Temperature / Peripheral Temperature**

This feature displays the temperature readings from the system sensor (chassis) and peripheral devices.

### **Fan 1 ~ Fan 4 Reading**

This feature displays the fan speed readings from fan interfaces Fan1 through Fan4.

### **VCORE, 12V, VDIMM, 5VCC, VTT\_CPU, AVCC, 3.3VCC, VSB, VBAT**

This feature displays the current voltages of the above voltage monitors.

## **►ACPI Configuration**

Use this feature to configure Advanced Configuration and Power Interface (ACPI) power management settings for your system.

### **High Precision Event Timers**

Select Enabled to activate the High Performance Event Timer (HPET) that produces periodic interrupts at a much higher frequency than a Real-time Clock (RTC) does in

synchronizing multimedia streams, providing smooth playback and reducing the dependency on other timestamp calculation devices, such as an x86 RDTSC Instruction embedded in the CPU. The High Performance Event Timer is used to replace the 8254 Programmable Interval Timer. The options are **Enabled** and Disabled.

### **Suspend Mode**

This setting allows you to configure the ACPI (Advanced Configuration and Power Interface) sleep state for your system when it is in the Suspend mode. The options are Suspend Disabled, **S1 (POS)**, and S3 (STR). S3 (STR) is the deepest sleep state in these options.

## **► AMT Configuration**

### **AMT**

This option enables Intel AMT support. The options are **Enabled** and Disabled.

### **Unconfigure AMT/ME**

This option allows the Intel AMT/ME to be unconfigured without password operation. The options are Enabled and **Disabled**.

### **Watch Dog Timer**

Allows AMT to reset or power down the system if the operating system or BIOS hangs or crashes. The options are **Disabled**, and Enabled.

#### **OS WatchDog Timer / BIOS WatchDog Timer**

These options appear if Watch Dog Timer (above) is enabled. This is a timed delay in seconds, before a system power down or reset after a BIOS or operating system failure is detected. Directly enter the value, in seconds.

## 4-3 Security Settings

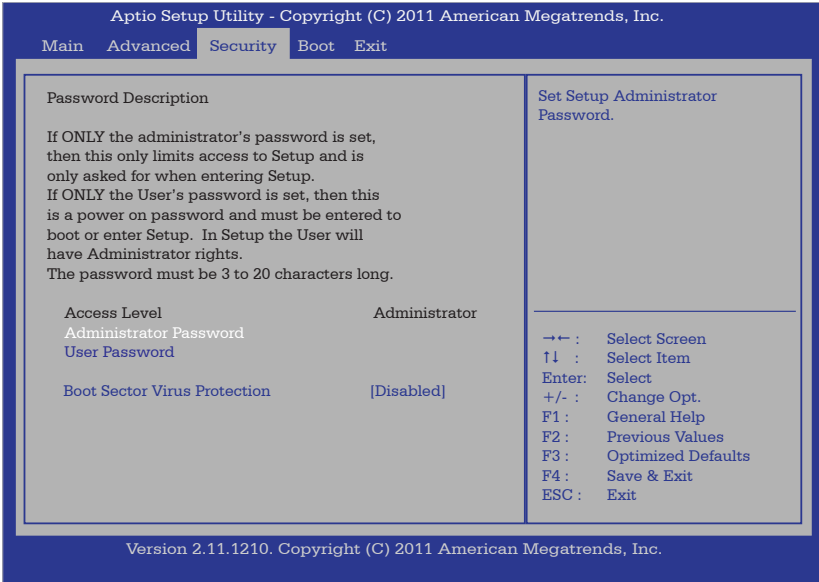

- If the Administrator password is defined ONLY - this controls access to the BIOS setup ONLY.
- If the User's password is defined ONLY - this password will need to be entered during each system startup or boot, and will also have Administrator rights in the setup.
- Passwords must be at least 3 and up to 20 characters long.

### Administrator Password

Press Enter to create a new, or change an existing Administrator password.

### User Password:

Press Enter to create a new, or change an existing User password.

### Boot Sector Virus Protection

When Enabled, the BIOS displays a warning when any program (or virus) issues a Disk Format command or attempts to write to the boot sector of the hard disk drive. The options are Enabled and **Disabled**.

## 4-4 Boot Settings



### Setup Prompt Timeout

Number of seconds to wait for setup activation key. Enter 65535 (0xFFFF) to wait indefinitely.

### ▶ Boot Options Priority

This feature allows the user to specify which devices are boot devices and the order of priority from which the systems boots from during startup.

### Boot Option #1, Boot option #2, Boot Option #3, etc

The settings are **Built-in EFI Shell**, [any detected boot device] and Disabled.

### Hard Disk Drives

Boot Option #1, Boot option #2, Boot Option #3, etc

### ▶ Delete Boot Option

This feature allows the removal of a boot device and the order of priority from which the systems boots from during startup.

## 4-5 Exit Options

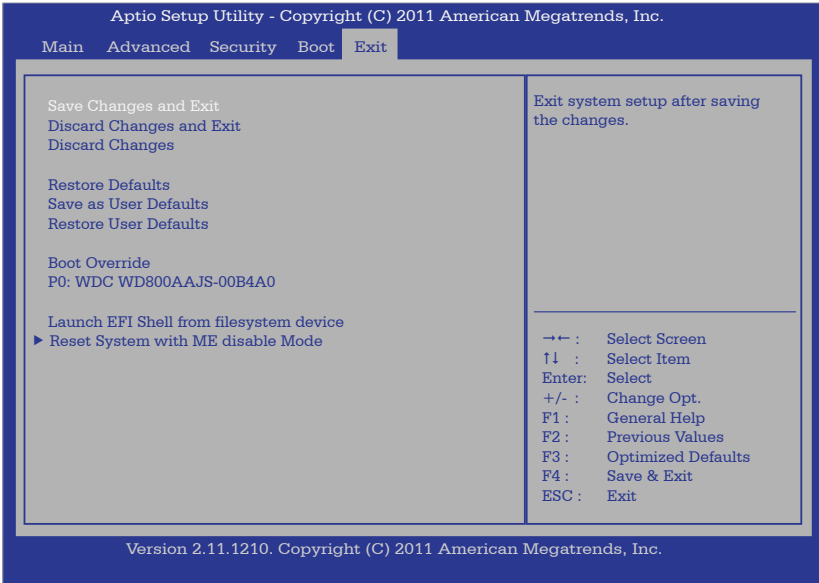

Select the Exit tab from the BIOS Setup Utility screen to enter the Exit BIOS Setup screen.

### Save Changes and Exit

When you have completed the system configuration changes, select this option to leave the BIOS Setup Utility and reboot the computer, so the new system configuration parameters can take effect. Select Save Changes and Exit from the Exit menu and press <Enter>.

### Discard Changes and Exit

Select this option to quit the BIOS Setup without making any permanent changes to the system configuration, and reboot the computer. Select Discard Changes and Exit from the Exit menu and press <Enter>.

### Discard Changes

Select this option and press <Enter> to discard all the changes and return to the AMI BIOS Utility Program.

**Restore Defaults**

To set this feature, select Restore Defaults from the Exit menu and press <Enter>. These are factory settings designed for maximum system stability, but not for maximum performance.

**Save As User Defaults**

To set this feature, select Save as User Defaults from the Exit menu and press <Enter>. This enables the user to save any changes to the BIOS setup for future use

**Restore User Defaults**

To set this feature, select Restore User Defaults from the Exit menu and press <Enter>. Use this feature to retrieve user-defined settings that were saved previously.

**Boot Override**

Set this feature to override a previously defined boot device. The available devices will be listed below.

**Launch EFI Shell from filesystem device**

This feature when initiated, will attempt to launch an EFI shell application (shellx64.efi) from one of the available file system devices. Press <Enter> to activate.

**►Reset System with ME disabled Mode**

If this feature is activated, the system will reset and temporarily disable ME. Press <Enter> to activate.

## Notes

---

---

## Appendix A

### BIOS Error Beep Codes

During the POST (Power-On Self-Test) routines, which are performed each time the system is powered on, errors may occur.

**Non-fatal errors** are those which, in most cases, allow the system to continue with bootup. The error messages normally appear on the screen.

**Fatal errors** will not allow the system to continue to bootup. If a fatal error occurs, you should consult with your system manufacturer for possible repairs.

These fatal errors are usually communicated through a series of audible beeps. The numbers on the fatal error list correspond to the number of beeps for the corresponding error.

#### A-1 BIOS Error Beep Codes

BIOS Error Beep Codes		
Beep Code/LED	Error Message	Description
1 beep	Refresh	Circuits have been reset. (Ready to power up)
5 short beeps + 1 long beep	Memory error	No memory detected in the system
8 beeps	Display memory read/write error	Video adapter missing or with faulty memory
OH LED On	System OH	System Overheat

## Notes

## Appendix B

### Software Installation Instructions

#### B-1 Installing Drivers

After you've installed the Windows Operating System, a screen as shown below will appear. You are ready to install software programs and drivers that have not yet been installed. To install these software programs and drivers, click the icons to the right of these items. (**Note:** To install the Windows Operating System, please refer to the instructions posted on our website at <http://www.supermicro.com/support/manuals/>.)

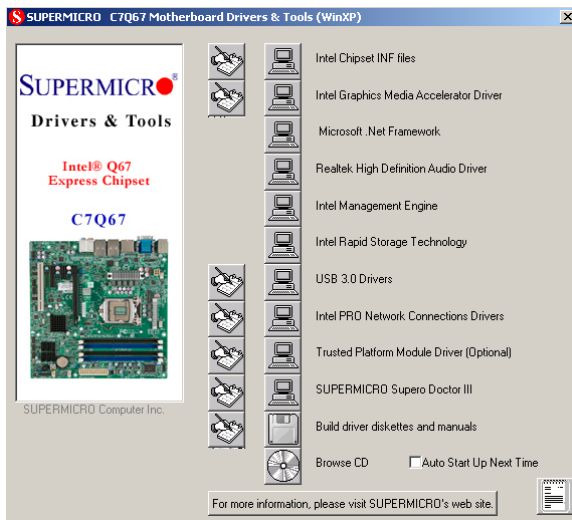

#### Driver/Tool Installation Display Screen



**Note 1.** Click the icons showing a hand writing on the paper to view the readme files for each item. Click on a computer icon to the right of an item to install this item (from top to the bottom), one at a time. After installing each item, you must reboot the system before proceeding with the next item on the list. The bottom icon with a CD on it allows you to view the entire contents of the CD.

**Note 2.** When making a storage driver diskette by booting into a Driver CD, please set the SATA Configuration to "Compatible Mode" and configure SATA as IDE in the BIOS Setup. After making the driver diskette, be sure to change the SATA settings back to your original settings.

## B-2 Configuring SuperDoctor® III

The SuperDoctor III program is a Web-based management tool that supports remote management capability. It includes Remote and Local Management tools. The local management tool is called the SD III Client. The SuperDoctor III program included on the CDROM that came with your motherboard allows you to monitor the environment and operations of your system. SuperDoctor III displays crucial system information such as CPU temperature, system voltages and fan status. See the Figure below for a display of the SuperDoctor III interface.

**Note:** 1 The default user name and password are ADMIN.



**Note 2:** In the Windows OS environment, the SuperDoctor III settings take precedence over the BIOS settings. When first installed, SuperDoctor III adopts the temperature threshold settings previously set in BIOS. Any subsequent changes to these thresholds must be made within SuperDoctor, since the settings override the BIOS settings. For the Windows OS to adopt the BIOS temperature threshold settings, please change the SD III Client settings to be the same as those set in BIOS.

SuperDoctor III Interface Display Screen-I (Health Information)

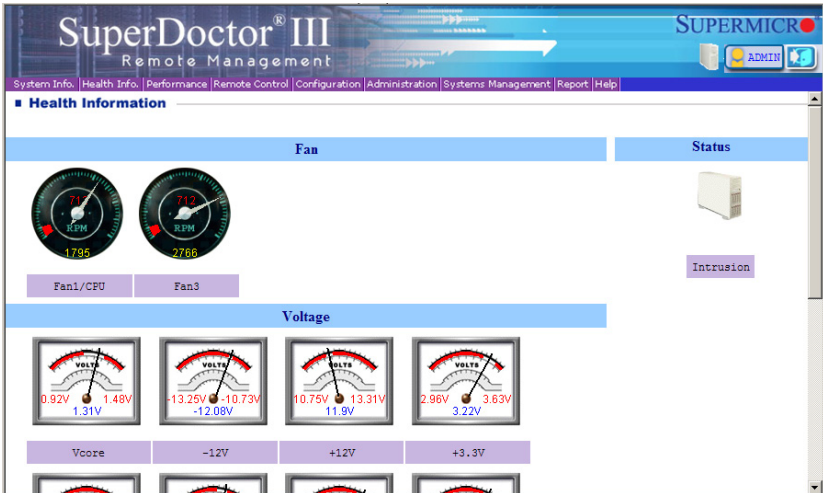

**SuperDoctor III Interface Display Screen-II (Remote Control)**

**Remote Control**

Graceful Power Control  
Open Console  
Power Control

**Graceful power control (cancelable)**

Super Doctor III allows a user to inform the OS to reboot or shut down the system within 30 seconds. On the system console, a pop-up window will appear with a message telling the local user to save his working files. Before the system reboots or shuts down, it's allowed to cancel the action either locally or remotely.

**Power control (noncancelable)**

Super Doctor III allows a user to inform the OS to reboot or shut down the system right away. The system will reboot or shut down without any warning messages. It's not allowed to cancel the action.



**Note:** The SuperDoctor III software and manual may be downloaded from our Website at:

<http://www.supermicro.com/products/accessories/software/SuperDoctorIII.cfm>.

For Linux, we still recommend that you use SuperDoctor II, this version is also available for download at the link above.

## Notes

## Appendix C

### UEFI BIOS Recovery Instructions



**Warning!** Do not upgrade the BIOS unless your system has a BIOS-related issue. Flashing the wrong BIOS can cause irreparable damage to the system. In no event shall Supermicro be liable for direct, indirect, special, incidental, or consequential damages arising from a BIOS update. If you need to update the BIOS, do not shut down or reset the system while the BIOS is updating to avoid possible boot failure.

#### C-1 An Overview to the UEFI BIOS

The Unified Extensible Firmware Interface (UEFI) specification provides a software-based interface between the operating system and the platform firmware in the pre-boot environment. The UEFI specification supports an architecture-independent mechanism for add-on card initialization to allow the UEFI OS loader, which is stored in the add-on card, to boot up the system. UEFI offers a clean, hand-off control to a computer system at bootup.

#### C-2 How to Recover the UEFI BIOS Image (-the Main BIOS Block)

An AMIBIOS flash chip consists of a boot sector block and a main BIOS code block (a main BIOS image). The boot sector block contains critical BIOS codes, including memory detection and recovery codes for the user to flash a new BIOS image if the original BIOS image is corrupted. When the system power is on, the boot sector codes execute first. Once it is completed, the main BIOS code will continue with system initialization and bootup.



**Note:** Follow the BIOS Recovery instructions below for BIOS recovery when the main BIOS block crashes. However, when the BIOS Boot sector crashes, you will need to send the motherboard back to Supermicro for RMA repair.

#### C-3 To Recover the Boot Sector Using a USB-Attached Device

This feature allows the user to recover a BIOS image using a USB-attached device without additional utilities used. A USB flash device such as a USB Flash Drive, or

a USB CD/DVD ROM/RW device can be used for this purpose. However, a USB Hard Disk drive cannot be used for BIOS recovery at this time.

To perform UEFI BIOS recovery using a USB-attached device, follow the instructions below.

1. Using a different machine, copy the "Super.ROM" binary image file into the disc Root "\\" Directory of a USB device or a writeable CD/DVD.



**Note:** If you cannot locate the "Super.ROM" file in your driver disk, visit our website at [www.supermicro.com](http://www.supermicro.com) to download the BIOS image into a USB flash device and rename it to "Super ROM" for BIOS recovery use.

2. Insert the USB device that contains the new BIOS image ("Super.ROM") into your USB drive and power on the system
3. While powering on the system, keep pressing <Ctrl> and <Home> simultaneously on your PS2 keyboard until your hear two short beeps. This may take from a few seconds to one minute.
4. After locating the new BIOS binary image, the system will enter the BIOS Recovery menu as shown below.

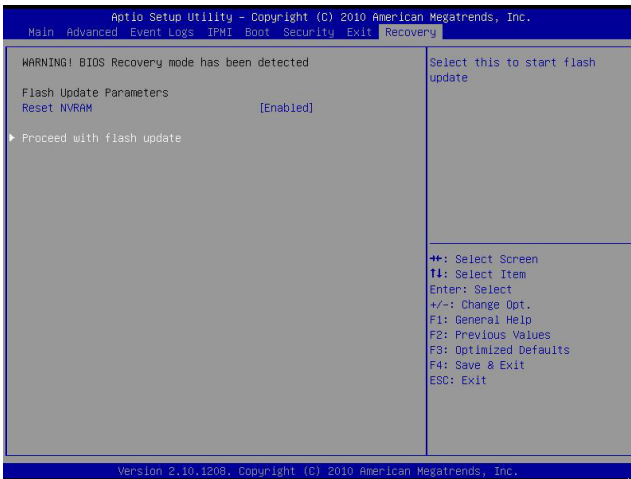

**Note:** At this point, you may decide if you want to start with BIOS Recovery. If you decide to proceed with BIOS Recovery, follow the procedures below.

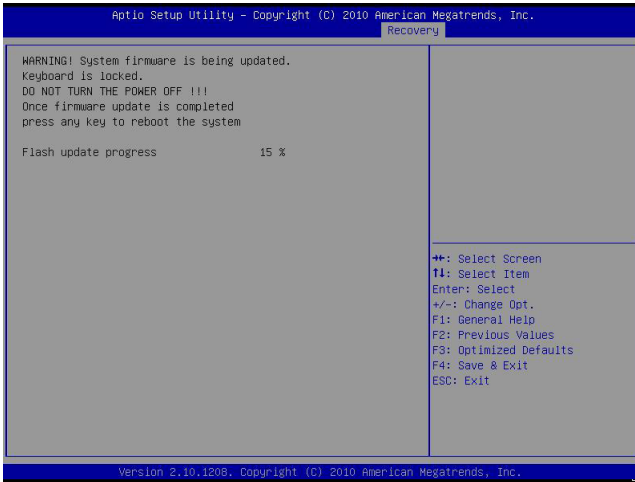

- When the screen as shown above displays, using the arrow key, select the item- "Proceed with flash update" and press the <Enter> key. You will see the progress of BIOS Recovery as shown in the screen below.

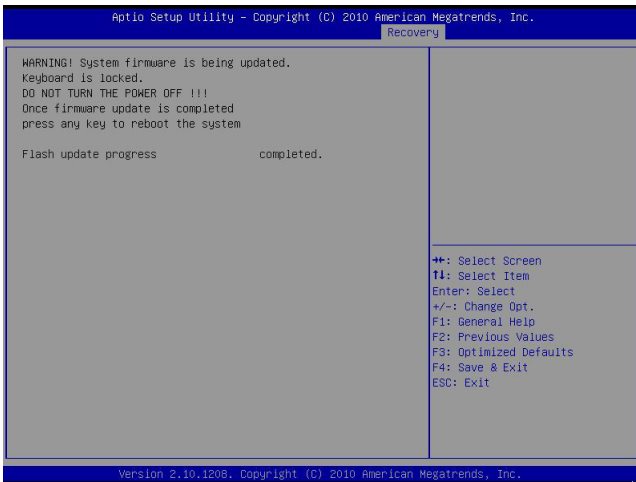

**Note:** Do not interrupt the process of BIOS flashing until it is completed.

- After the process of BIOS Recovery is complete, press any key to reboot the system.
- Using a different system, extract the BIOS package into a bootable USB flash drive.

8. When a DOS prompt appears, enter AMI.BAT BIOSname.### at the prompt.



**Note:** Do not interrupt this process until BIOS flashing is completed.

9. After seeing the message that BIOS update is completed, unplug the AC power cable from the power supply to clear CMOS, and then plug the AC power cable in the power supply again to power on the system.
10. Press <Del> continuously to enter the BIOS Setup utility.
11. Press <F3> to load default settings.
12. After loading default settings, press <F4> to save the settings and exit the BIOS Setup utility.

(Disclaimer Continued)

The products sold by Supermicro are not intended for and will not be used in life support systems, medical equipment, nuclear facilities or systems, aircraft, aircraft devices, aircraft/emergency communication devices or other critical systems whose failure to perform be reasonably expected to result in significant injury or loss of life or catastrophic property damage. Accordingly, Supermicro disclaims any and all liability, and should buyer use or sell such products for use in such ultra-hazardous applications, it does so entirely at its own risk. Furthermore, buyer agrees to fully indemnify, defend and hold Supermicro harmless for and against any and all claims, demands, actions, litigation, and proceedings of any kind arising out of or related to such ultra-hazardous use or sale.