



X12SCZ-TLN4F/QF/F

USER'S MANUAL

Revision 1.1

The information in this user's manual has been carefully reviewed and is believed to be accurate. The manufacturer assumes no responsibility for any inaccuracies that may be contained in this document, and makes no commitment to update or to keep current the information in this manual, or to notify any person or organization of the updates. **Please Note: For the most up-to-date version of this manual, please see our website at [www.supermicro.com](http://www.supermicro.com).**

Super Micro Computer, Inc. ("Supermicro") reserves the right to make changes to the product described in this manual at any time and without notice. This product, including software and documentation, is the property of Supermicro and/or its licensors, and is supplied only under a license. Any use or reproduction of this product is not allowed, except as expressly permitted by the terms of said license.

IN NO EVENT WILL Super Micro Computer, Inc. BE LIABLE FOR DIRECT, INDIRECT, SPECIAL, INCIDENTAL, SPECULATIVE OR CONSEQUENTIAL DAMAGES ARISING FROM THE USE OR INABILITY TO USE THIS PRODUCT OR DOCUMENTATION, EVEN IF ADVISED OF THE POSSIBILITY OF SUCH DAMAGES. IN PARTICULAR, SUPER MICRO COMPUTER, INC. SHALL NOT HAVE LIABILITY FOR ANY HARDWARE, SOFTWARE, OR DATA STORED OR USED WITH THE PRODUCT, INCLUDING THE COSTS OF REPAIRING, REPLACING, INTEGRATING, INSTALLING OR RECOVERING SUCH HARDWARE, SOFTWARE, OR DATA.

Any disputes arising between manufacturer and customer shall be governed by the laws of Santa Clara County in the State of California, USA. The State of California, County of Santa Clara shall be the exclusive venue for the resolution of any such disputes. Supermicro's total liability for all claims will not exceed the price paid for the hardware product.

FCC Statement: This equipment has been tested and found to comply with the limits for a Class A digital device pursuant to Part 15 of the FCC Rules. These limits are designed to provide reasonable protection against harmful interference when the equipment is operated in a commercial environment. This equipment generates, uses, and can radiate radio frequency energy and, if not installed and used in accordance with the manufacturer's instruction manual, may cause harmful interference with radio communications. Operation of this equipment in a residential area is likely to cause harmful interference, in which case you will be required to correct the interference at your own expense.

California Best Management Practices Regulations for Perchlorate Materials: This Perchlorate warning applies only to products containing CR (Manganese Dioxide) Lithium coin cells. "Perchlorate Material-special handling may apply. See [www.dtsc.ca.gov/hazardouswaste/perchlorate](http://www.dtsc.ca.gov/hazardouswaste/perchlorate)".



**WARNING:** This product can expose you to chemicals including lead, known to the State of California to cause cancer and birth defects or other reproductive harm. For more information, go to [www.P65Warnings.ca.gov](http://www.P65Warnings.ca.gov).

The products sold by Supermicro are not intended for and will not be used in life support systems, medical equipment, nuclear facilities or systems, aircraft, aircraft devices, aircraft/emergency communication devices or other critical systems whose failure to perform be reasonably expected to result in significant injury or loss of life or catastrophic property damage. Accordingly, Supermicro disclaims any and all liability, and should buyer use or sell such products for use in such ultra-hazardous applications, it does so entirely at its own risk. Furthermore, buyer agrees to fully indemnify, defend and hold Supermicro harmless for and against any and all claims, demands, actions, litigation, and proceedings of any kind arising out of or related to such ultra-hazardous use or sale.

Manual Revision 1.1

Release Date: March 19, 2024

Unless you request and receive written permission from Super Micro Computer, Inc., you may not copy any part of this document. Information in this document is subject to change without notice. Other products and companies referred to herein are trademarks or registered trademarks of their respective companies or mark holders.

Copyright © 2024 by Super Micro Computer, Inc.  
All rights reserved.

**Printed in the United States of America**

---

---

# Preface

## About This Manual

This manual is written for system integrators, IT technicians and knowledgeable end users. It provides information for the installation and use of the X12SCZ-TLN4F/QF/F motherboard.

## About This Motherboard

The X12SCZ series comes in different model variations with different CPU support. The X12SCZ-TLN4F/F supports Intel® Xeon W-1200 series, 10th/11th Generation Core i9/i7/i5/i3, Pentium, and Celeron processors in an LGA1200 socket, while the X12SCZ-QF supports Intel 10th/11th Generation Core i9/i7/i5/i3, Pentium, and Celeron processors in an LGA1200 socket. The X12SCZ-TLN4F/F features the W480E chipset and support for ECC and Non-ECC DDR4 UDIMM memory, while the X12SCZ-QF features the Q470E chipset and support for Non-ECC only. The X12SCZ series motherboards include the PCI Express 3.0 interface, four SATA 3.0 ports, IPMI 2.0, 12V DC power source, GPU add-on card power connector, dual 10GbE LAN option (on -TLN4F), HD Graphic outputs, and a combination of USB 2.0 and 3.2 ports. The motherboards also provide security-enhancing technologies such as Intel Software Guard Extensions (Intel SGX), Intel vPro, and Intel Trusted Execution Technology (TXT). The X12SCZ-TLN4F/QF/F offers exceptional system performance for entry server, data storage, network security, and embedded applications.

## Conventions Used in the Manual

Special attention should be given to the following symbols for proper installation and to prevent damage done to the components or injury to yourself:



**Warning!** Indicates important information given to prevent equipment/property damage or personal injury.



**Warning!** Indicates high voltage may be encountered while performing a procedure.



**Important:** Important information given to ensure proper system installation or to relay safety precautions.



**Note:** Additional Information given to differentiate various models or provides information for proper system setup.

## Contacting Supermicro

### Headquarters

Address: Super Micro Computer, Inc.  
980 Rock Ave.  
San Jose, CA 95131 U.S.A.

Tel: +1 (408) 503-8000

Fax: +1 (408) 503-8008

Email: [Marketing@supermicro.com](mailto:Marketing@supermicro.com) (General Information)  
[Sales-USA@supermicro.com](mailto:Sales-USA@supermicro.com) (Sales Inquiries)  
[Government\\_Sales-USA@supermicro.com](mailto:Government_Sales-USA@supermicro.com) (Gov. Sales Inquiries)  
[Support@supermicro.com](mailto:Support@supermicro.com) (Technical Support)  
[RMA@supermicro.com](mailto:RMA@supermicro.com) (RMA Support)  
[Webmaster@supermicro.com](mailto:Webmaster@supermicro.com) (Webmaster)

Website: [www.supermicro.com](http://www.supermicro.com)

### Europe

Address: Super Micro Computer B.V.  
Het Sterrenbeeld 28, 5215 ML  
's-Hertogenbosch, The Netherlands

Tel: +31 (0) 73-6400390

Fax: +31 (0) 73-6416525

Email: [Sales\\_Europe@supermicro.com](mailto:Sales_Europe@supermicro.com) (General Information)  
[Support\\_Europe@supermicro.com](mailto:Support_Europe@supermicro.com) (Technical Support)  
[RMA\\_Europe@supermicro.com](mailto:RMA_Europe@supermicro.com) (RMA Support)

Website: [www.supermicro.nl](http://www.supermicro.nl)

### Asia-Pacific

Address: Super Micro Computer, Inc.  
3F, No. 150, Jian 1st Rd.  
Zhonghe Dist., New Taipei City 235  
Taiwan (R.O.C)

Tel: +886-(2) 8226-3990

Fax: +886-(2) 8226-3992

Email: [Sales-Asia@supermicro.com.tw](mailto:Sales-Asia@supermicro.com.tw) (Sales Inquiry)  
[Support@supermicro.com.tw](mailto:Support@supermicro.com.tw) (Technical Support)  
[RMA@supermicro.com.tw](mailto:RMA@supermicro.com.tw) (RMA Support)

Website: [www.supermicro.com.tw](http://www.supermicro.com.tw)

# Table of Contents

## **Chapter 1 Introduction**

1.1 Checklist.....	8
Quick Reference .....	11
Quick Reference Table.....	12
Motherboard Features.....	14
1.2 Processor and Chipset Overview.....	18
1.3 Special Features .....	19
Recovery from AC Power Loss.....	19
1.4 System Health Monitoring.....	19
Onboard Voltage Monitors .....	19
Fan Status Monitor with Firmware Control .....	19
Environmental Temperature Control .....	19
System Resource Alert.....	20
1.5 ACPI Features.....	20
1.6 Power Supply .....	20
1.7 Serial Port.....	21

## **Chapter 2 Installation**

2.1 Static-Sensitive Devices.....	22
Precautions .....	22
Unpacking .....	22
2.2 Processor and Heatsink Installation.....	23
Installing the LGA1200 Processor .....	23
Installing an Active CPU Heatsink with Fan .....	25
Removing the Heatsink.....	27
2.3 Motherboard Installation.....	28
Tools Needed .....	28
Location of Mounting Holes .....	28
Installing the Motherboard.....	29
2.4 Memory Support and Installation .....	30
Memory Support.....	30
DIMM Module Population Configuration .....	30

General Guidelines for Optimizing Memory Performance .....	31
DIMM Installation .....	32
DIMM Removal .....	32
2.5 Rear I/O Ports .....	33
2.6 Front Control Panel .....	39
2.7 Connectors .....	44
Power Connections .....	44
Headers .....	47
2.8 Jumper Settings .....	58
How Jumpers Work .....	58
2.9 LED Indicators .....	65
<b>Chapter 3 Troubleshooting</b>	
3.1 Troubleshooting Procedures .....	67
Before Power On .....	67
No Power .....	67
No Video .....	68
System Boot Failure .....	68
Memory Errors .....	68
Losing the System's Setup Configuration .....	69
When the System Becomes Unstable .....	69
3.2 Technical Support Procedures .....	71
3.3 Frequently Asked Questions .....	72
3.4 Battery Removal and Installation .....	73
Battery Removal .....	73
Proper Battery Disposal .....	73
Battery Installation .....	73
3.5 Returning Merchandise for Service .....	74
<b>Chapter 4 UEFI BIOS</b>	
4.1 Introduction .....	75
4.2 Main Setup .....	76
4.3 Advanced Setup Configurations .....	78
4.4 Event Logs .....	111
4.5 IPMI .....	113

---

---

4.6 Security.....	116
4.7 Boot.....	123
4.8 Save & Exit.....	126
<b><i>Appendix A BIOS Codes</i></b>	
A.1 BIOS Error POST (Beep) Codes .....	128
A.2 Additional BIOS POST Codes.....	129
<b><i>Appendix B Software</i></b>	
B.1 Microsoft Windows OS Installation.....	130
B.2 Driver Installation.....	132
B.3 SuperDoctor® 5.....	133
B.4 IPMI .....	134
<b><i>Appendix C Standardized Warning Statements</i></b>	
<b><i>Appendix D UEFI BIOS Recovery</i></b>	
D.1 Overview.....	138
D.2 Recovering the UEFI BIOS Image.....	138
D.3 Recovering the BIOS Block with a USB Device .....	138

# Chapter 1

## Introduction

Congratulations on purchasing your computer motherboard from an industry leader. Supermicro motherboards are designed to provide you with the highest standards in quality and performance.

In addition to the motherboard, several important parts that are included in the retail box are listed below. If anything listed is damaged or missing, please contact your retailer.

### 1.1 Checklist

Main Parts List		
Description	Part Number	Quantity
Supermicro Motherboard	X12SCZ-TLN4F/QF/F	1
I/O Shield	MCP-260-00093-0N	1
SATA Cables	CBL-0044L	4
<a href="#">Quick Reference Guide</a>	MNL-2257-QRG	1

### Important Links

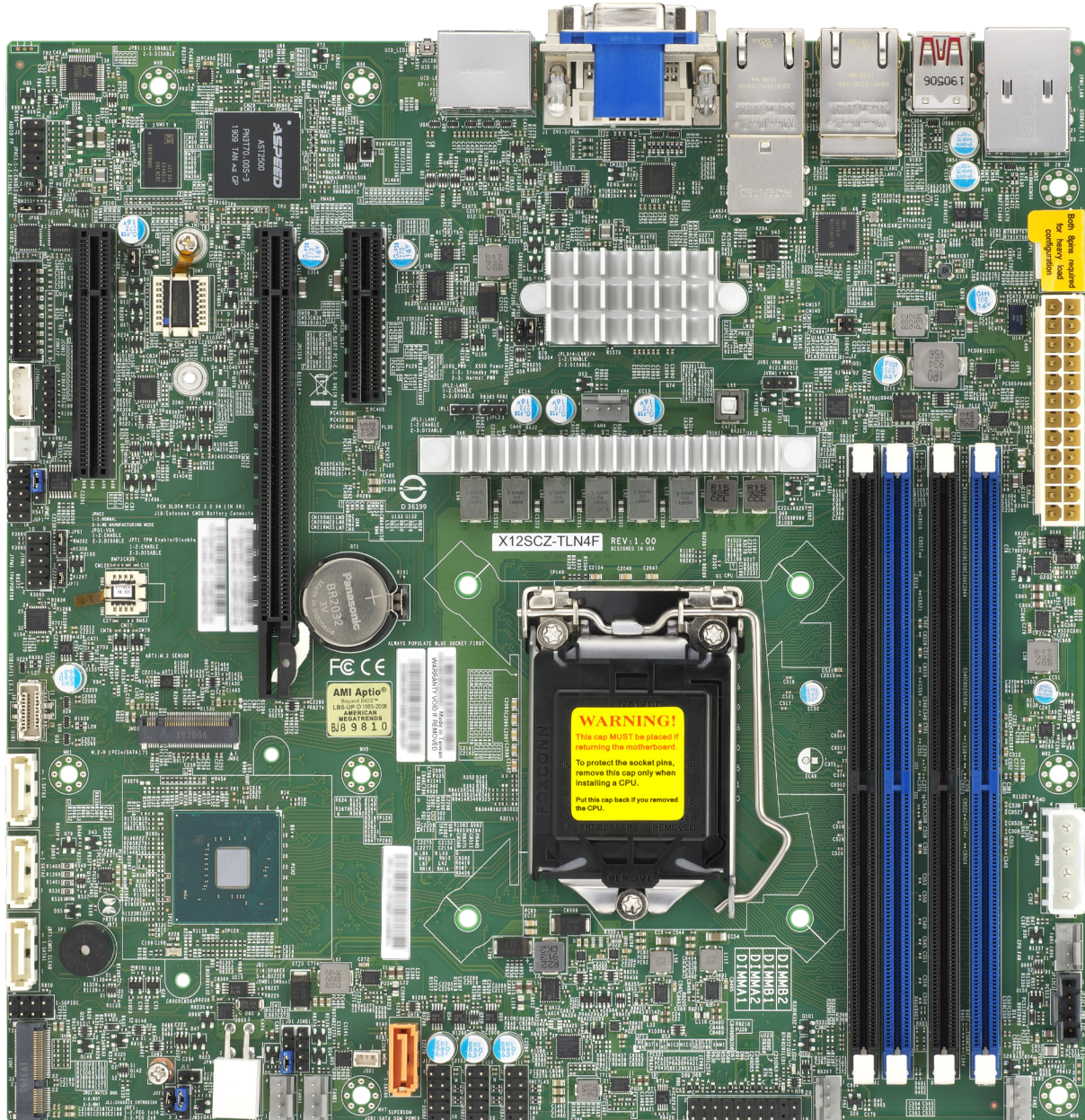
For your system to work properly, please follow the links below to download all necessary drivers/utilities and the user's manual for your server.


- Supermicro product manuals: <http://www.supermicro.com/support/manuals/>
- Product drivers and utilities: <https://www.supermicro.com/wdl/driver>
- Product safety info: [http://www.supermicro.com/about/policies/safety\\_information.cfm](http://www.supermicro.com/about/policies/safety_information.cfm)
- A secure data deletion tool designed to fully erase all data from storage devices can be found at our website: [https://www.supermicro.com/wftp/utility/Lot9\\_Secure\\_Data\\_Deletion\\_Utility/](https://www.supermicro.com/wftp/utility/Lot9_Secure_Data_Deletion_Utility/)
- If you have any questions, please contact our support team at: [support@supermicro.com](mailto:support@supermicro.com)

This manual may be periodically updated without notice. Please check the Supermicro website for possible updates to the manual revision level.

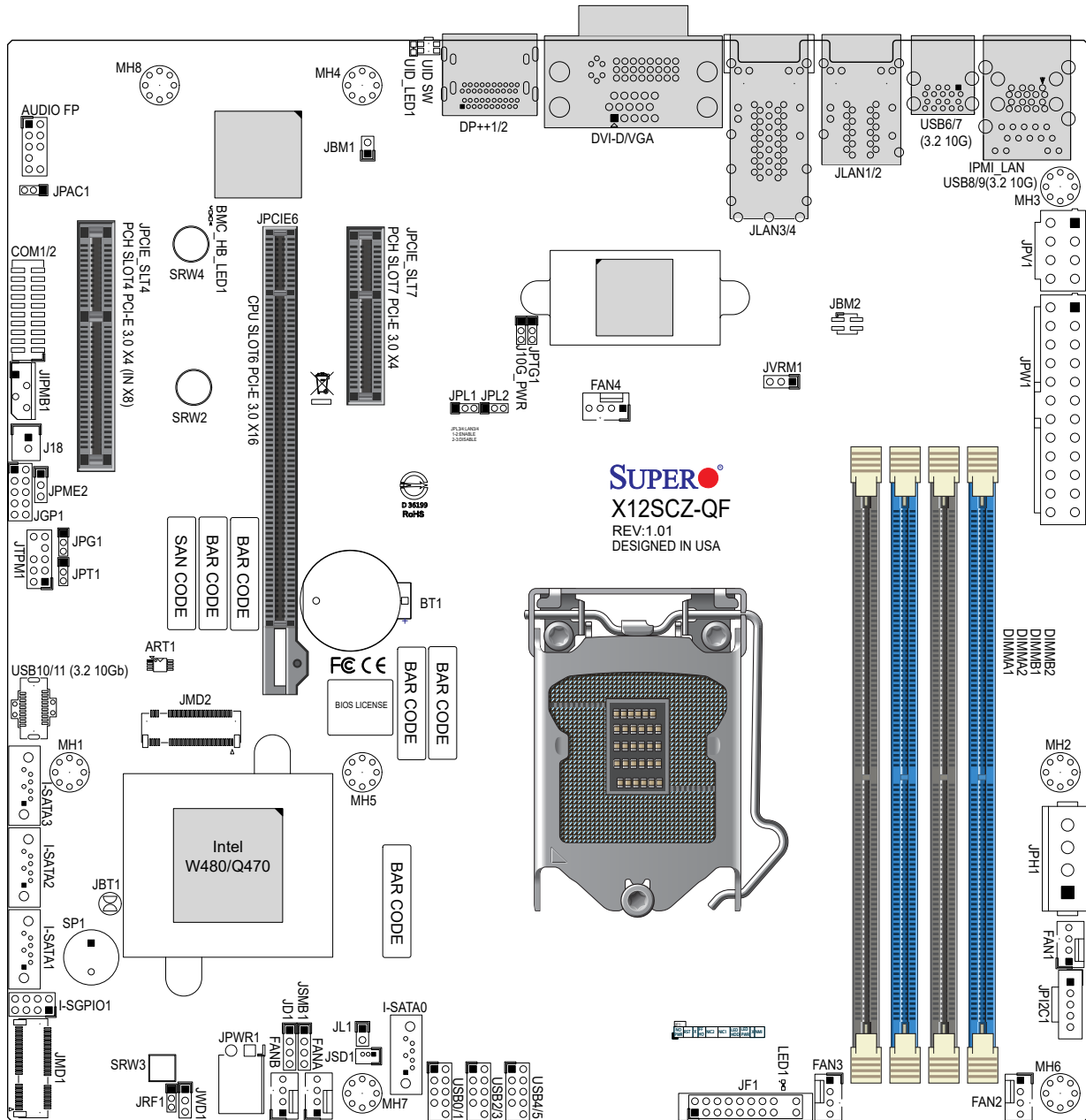


Figure 1-1. X12SCZ-TLN4F Motherboard Image



 **Note:** All graphics shown in this manual were based upon the latest PCB revision available at the time of publication of the manual. The motherboard you received may or may not look exactly the same as the graphics shown in this manual.

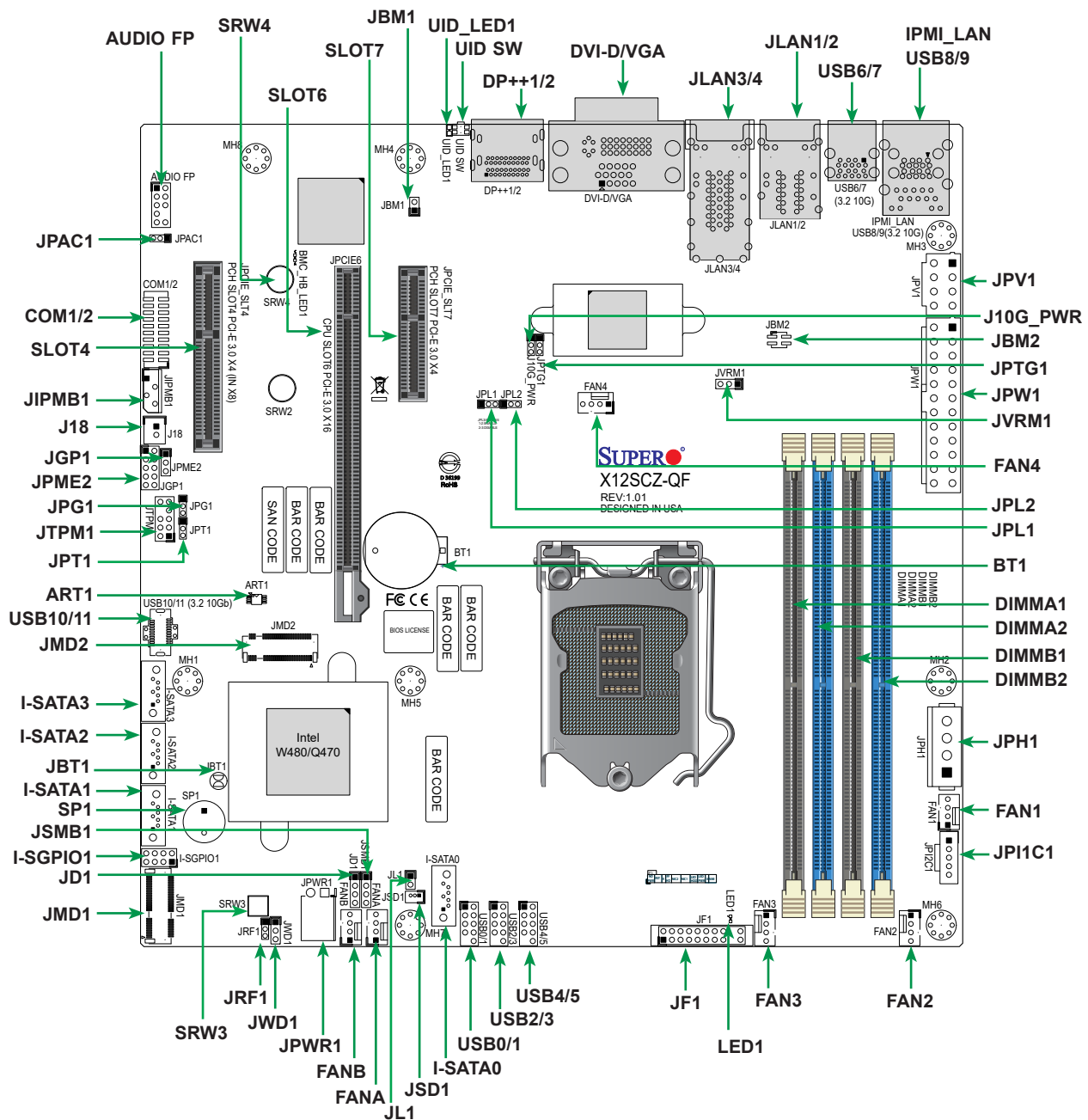
**Figure 1-2. X12SCZ-QF Motherboard Layout**  
(not drawn to scale)



**Note 1:** LAN ports 3 and 4 are only available on X12SCZ-TLN4F

**Note 2:** Components not documented are for internal testing only.

## Quick Reference



### Notes:

- See [Chapter 2](#) for detailed information on jumpers, I/O ports, and JF1 front panel connections.
- "■" indicates the location of Pin 1.
- Jumpers/LED indicators not indicated are used for testing only.
- Use only the correct type of onboard CMOS battery as specified by the manufacturer. Do not install the onboard battery upside down to avoid possible explosion.

## Quick Reference Table



Jumper	Description	Default Setting (*)
J10G_PWR	LAN3/LAN4 Power Option	*Pins 1–2 (Standby Power) Pins 2–3 (Normal Power)
JBM1	IPMI Share LAN Feature	Pins 1–2 Open (Enabled)
JBM2	IPMI LAN Enable/Disable	*Pins 1–3 Short (Enabled) Pins 1–2 Short (Disabled)
JBT1	CMOS Clear	Open (Normal)
JPAC1	Front Panel Audio Enable/Disable	Pins 1–2 (Enabled)
JPG1	VGA Enable/Disable	Pins 1–2 (Enabled)
JPL1	LAN1 Enable/Disable	Pins 1–2 (Enabled)
JPL2	LAN2 Enable/Disable	Pins 1–2 (Enabled)
JPME2	Manufacturing Mode Select	Pins 1–2 (Normal)
JRF1	Slot6 PCIe Bifurcation Option	*Pins 1–2 (x16) Pins 2–3 (x8x8)
JPT1	Onboard TPM Module Enable/Disable	Pins 2–3 (Disabled)
JPTG1	LAN3/LAN4 Enable/Disable	Pins 1–2 (Enabled)
JWD1	Watchdog Timer	Pins 1–2 (Reset)
LED	Description	Status
BMC_HB_LED1	BMC Heartbeat LED	Blinking Green: BMC Normal
UID_LED1	Unit Identifier (UID) LED	Solid Blue: Unit Identified
LED1	Power LED	Solid Green: Power On Blinking Green: S3 Status
Connector	Description	
ART1	M.2 M-Key Temperature Sensor	
AUDIO_FP	Front Panel Audio Header	
BT1	Onboard Battery	
COM1/2	COM Header (supports RS-232)	
DP++ 1/2	DisplayPorts 1 and 2	
DVI-D/VGA	DVI-D/VGA port	
FAN1–FAN4, FANA, FANB	CPU/System Fan Headers (FAN1: CPU Fan)	
IPMI_LAN	Dedicated IPMI LAN Port	
I-SATA0–I-SATA3	Intel PCH SATA 3.0 Ports (I-SATA0: SATA DOM)	
I-SGPIO1	Serial Link General Purpose I/O Header	
J18	Extended CMOS Battery Connector	
JD1	Speaker Header (Pins 1–4: Speaker, Pins 3–4: Buzzer)	
JF1	Front Control Panel Header	
JGP1	General Purpose I/O Header	




**Note:** Table is continued on the next page.

Connector	Description
JIPMB1	4-pin BMC External I <sup>2</sup> C Header (for an IPMI card)
JL1	Chassis Intrusion Header
JLAN1/2	1 G Base-T LAN Ports
JLAN3/4	10 G Base-T LAN Ports
JMD1	M.2 E-Key 2230 (CNVi/CNV) Slot
JMD2	M.2 M-Key 2280/22110 Slot
JPCIE_SLT4	PCH PCIe 3.0 x4 (in x8) Slot
JPCIE6	CPU PCIe 3.0 x16 Slot
JPCIE_SLT7	PCH PCIe 3.0 x4 Slot
JPH1	4-pin HDD Power Connector
JPI <sup>2</sup> C1	Power System Management Bus (SMB) I <sup>2</sup> C Header
JPV1	8-pin 12 V DC Power Connector for CPU (Required) or alternative single power for special enclosure when the 24-pin ATX power is not in use
JPW1	24-pin ATX Power Connector
JPWR1	4-pin 12 V Power Connector for GPU card requiring extra 12 V power (up to 75 W)
JSD1	SATA DOM Power Connector
JSMB1	System Management Bus Header
JTPM1	Trusted Platform Module/Port 80 Connector
JVRM1	VRM Bus Header
SP1	Internal Buzzer/Speaker
SRW2	M.2 Holding Screws for M-Key Type 2280
SRW3	M.2 Holding Screws for E-Key Type 2230
SRW4	M.2 Holding Screws for M-Key Type 22110
UID SW	Unit Identifier Switch
USB0/1, 2/3, 4/5	Front Accessible USB 2.0 Ports
USB6/7, 8/9	Back Panel USB 3.2 (10 Gb) Ports (S5 wake up support)
USB10/11	USB 3.2 (10 Gb) Type-A Header

## Motherboard Features

<b>Motherboard Features</b>	
<b>CPU</b>	
<ul style="list-style-type: none"> <li>X12SCZ-TLN4F/F: Intel 10th/11th Generation Core i9/i7/i5/i3, Pentium, Celeron, and Xeon W-1200 series processors in an LGA1200 socket.</li> <li>X12SCZ-QF: Intel 10th/11th Generation Core i9/i7/i5/i3, Pentium, and Celeron processor in an LGA1200 socket.</li> </ul>	<p> <b>Note:</b> The X12SCZ motherboard series does not support the Intel 10th/11th generation processor 2M cache SKUs. These processors will not boot with the latest BIOS version.</p>
<b>Memory</b>	
<ul style="list-style-type: none"> <li>X12SCZ-TLN4F/F: Integrated memory controller supports up to 128 GB Unbuffered ECC/Non-ECC UDIMM, DDR4-2933 MT/s, in four DIMM slots.</li> <li>X12SCZ-QF: Integrated memory controller supports up to 128 GB Unbuffered Non-ECC UDIMM, DDR4-2933 MT/s, in four DIMM slots.</li> </ul>	
<b>DIMM Size</b>	
<ul style="list-style-type: none"> <li>4 GB, 8 GB, 16 GB, 32 GB at 1.2 V</li> </ul>	<p> <b>Note:</b> For the latest CPU/memory updates, please refer to our website at <a href="http://www.supermicro.com/products/motherboard">http://www.supermicro.com/products/motherboard</a>.</p>
<b>Chipset</b>	
<ul style="list-style-type: none"> <li>X12SCZ-F/TLN4F: Intel PCH W480E</li> <li>X12SCZ-QF: Intel PCH Q470E</li> </ul>	
<b>Expansion Slots</b>	
<ul style="list-style-type: none"> <li>One PCIe 3.0 x4 Slot (IN x8) (PCH SLOT4)</li> <li>One PCIe 3.0 x16 Slot (CPU SLOT6) (Supports PCIe x8x8 bifurcation by riser card)</li> <li>One PCIe 3.0 x4 Slot (PCH SLOT7)</li> </ul>	
<b>Network</b>	
<ul style="list-style-type: none"> <li>Intel I219LM Gigabit Ethernet PHY (LAN1): Intel AMT Management Port</li> <li>Intel I210-AT Gigabit Ethernet Controller (LAN2): IPMI Shared LAN Port</li> <li>Intel X550 Dual 10 GbE Ethernet Controller (LAN3/4, TLN4F SKU Only)</li> </ul>	
<b>Baseboard Management Controller (BMC)</b>	
<ul style="list-style-type: none"> <li>ASpeed AST 2500 Baseboard Controller (BMC) supports IPMI 2.0</li> <li>One Dedicated IPMI LAN located on the rear IO back panel</li> </ul>	
<b>Graphics</b>	
<ul style="list-style-type: none"> <li>Intel HD Graphics (DVI-D, DisplayPort1/DisplayPort2 Version 1.4) with three independent displays</li> <li>Graphics controller via ASpeed 2500 BMC (VGA)</li> </ul>	

 **Note:** The table above is continued on the next page.

<b>Motherboard Features</b>	
<b>I/O Devices</b>	
<ul style="list-style-type: none"> <li>• Serial (COM) Header</li> <li>• I-SATA 3.0</li> <li>• Video (VGA) Port</li> <li>• DVI-D</li> <li>• DisplayPort</li> <li>• Audio</li> </ul>	<ul style="list-style-type: none"> <li>• One front accessible serial header (COM1/2)</li> <li>• Four SATA 3.0 ports with lock (I-SATA0 – I-SATA3)</li> <li>• One VGA connection on the rear I/O panel</li> <li>• One Digital Visual Interface (Digital Signal only)</li> <li>• Two DisplayPorts</li> <li>• One Audio Front Panel</li> </ul>
<b>USB</b>	
<ul style="list-style-type: none"> <li>• Four Back Panel USB 3.1 ports (USB6/7, USB8/9)</li> <li>• Three Front Accessible USB 2.0 headers (USB0/1, USB2/3, USB4/5)</li> <li>• One USB 3.2 (10 Gb) Type-A header (USB10/11)</li> </ul>	
<b>BIOS</b>	
<ul style="list-style-type: none"> <li>• 256 Mb AMI BIOS® SPI Flash BIOS</li> <li>• ACPI 6.0, Plug and Play (PnP), riser card auto detection support, SPI dual/quad speed support, and Real Time Clock (RTC) wakeup</li> </ul>	
<b>Power Management</b>	
<ul style="list-style-type: none"> <li>• ACPI power management</li> <li>• S3, S4, S5</li> <li>• Power button override mechanism</li> <li>• Power-on mode for AC power recovery</li> <li>• Wake-on-LAN (JWOL)</li> <li>• Power supply monitoring</li> </ul>	
<b>System Health Monitoring</b>	
<ul style="list-style-type: none"> <li>• Onboard voltage monitoring for +12 V, +5 V, +3.3 V, +5 V stdby, +3.3 V stdby, Vcore, CPU temperature, PCH temperature, system temperature, M.2 NVMe (M-Key) temperature and memory temperature</li> <li>• 5 CPU switch phase voltage regulator</li> <li>• CPU thermal trip support</li> <li>• Platform Environment Control Interface (PECI)/TSI</li> </ul>	
<b>Fan Control</b>	
<ul style="list-style-type: none"> <li>• Fan status monitoring via IPMI connections</li> <li>• Low-noise fan speed control</li> <li>• Six 4-pin fan headers</li> </ul>	
<b>System Management</b>	
<ul style="list-style-type: none"> <li>• IPMI Vieww, SMCIPMITOOL, IPMICFG</li> <li>• Trusted Platform Module (TPM) support</li> <li>• SuperDoctor® 5</li> <li>• Redundant power supply unit detection sensor</li> <li>• Chassis intrusion header and detection (<b>Note:</b> Connect a cable from the Chassis Intrusion header at JD1 to the chassis to receive an alert via IPMI.)</li> <li>• Client Platform Service</li> </ul>	



**Note:** The table above is continued on the next page.

## Motherboard Features

### LED Indicators

- CPU/system overheat LED
- Power/suspend-state indicator LED
- Fan failed LED
- UID/remote UID
- HDD activity LED
- LAN activity LED

### Dimensions

- uATX 9.6" (W) x 9.6" (L) (243.84 mm x 243.84 mm)

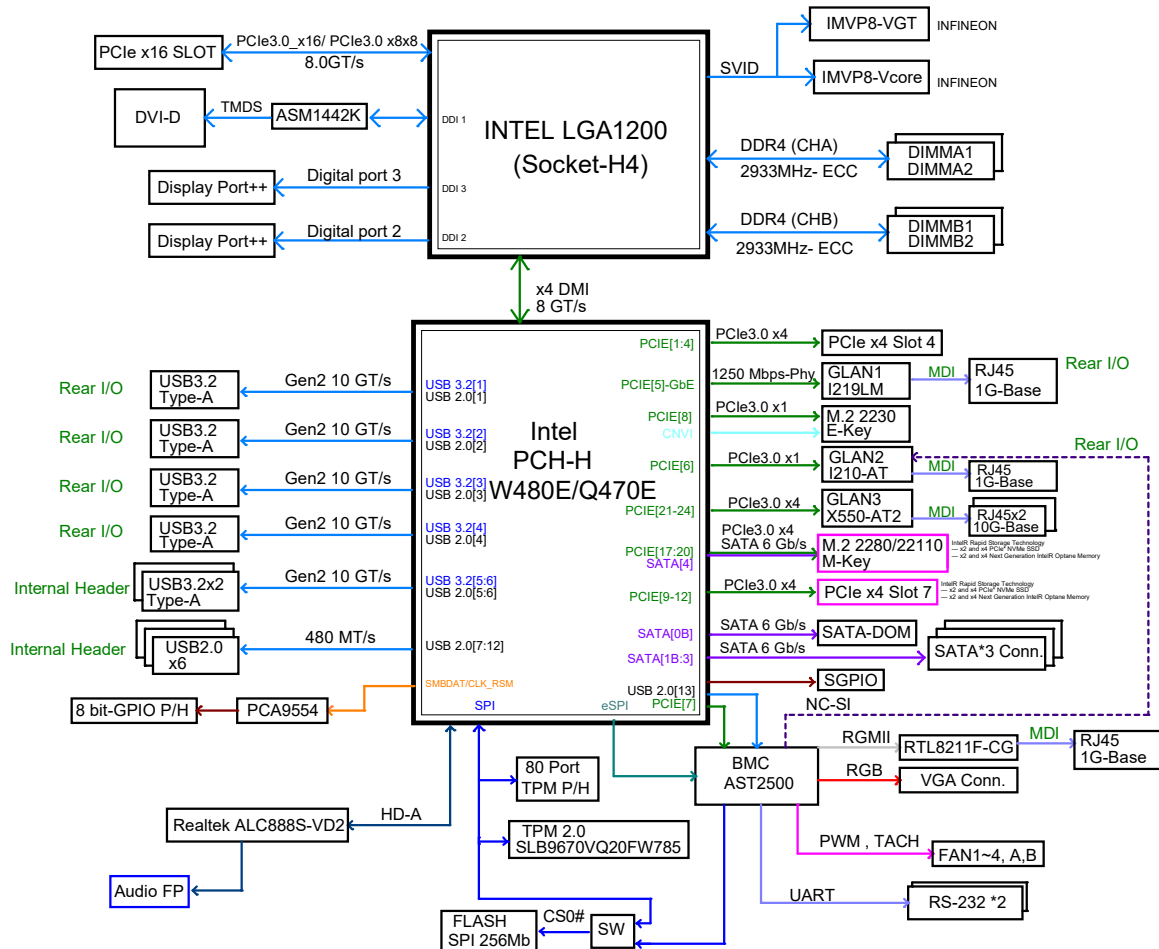



**Note 1:** The CPU maximum thermal design power (TDP) is subject to chassis and heatsink cooling restrictions. For proper thermal management, please check the chassis and heatsink specifications for proper CPU TDP sizing.

**Note 2:** For IPMI configuration instructions, please refer to the Embedded IPMI Configuration User's Guide available at <http://www.supermicro.com/support/manuals/>.



**Figure 1-3.**  
**System Block Diagram**



 **Note 1:** This is a general block diagram and may not exactly represent the features on your motherboard. See the previous pages for the actual specifications of your motherboard.

**Note 2:** The dual 10G LAN ports are only available on -TLN4F.

## 1.2 Processor and Chipset Overview

The X12SCZ series comes in different model variations with different CPU support. The X12SCZ-TLN4F/F supports Intel Xeon W-1200 series, 10th/11th Generation Core i9/i7/i5/i3, Pentium, and Celeron processors in an LGA1200 socket, while the X12SCZ-QF supports Intel 10th/11th Generation Core i9/i7/i5/i3, Pentium, and Celeron processors in an LGA1200 socket. The X12SCZ-TLN4F/F features the W480E chipset and support for ECC and Non-ECC DDR4 UDIMM memory, while the X12SCZ-QF features the Q470E chipset and support for Non-ECC only. The X12SCZ series motherboards include the PCI Express 3.0 interface, four SATA 3.0 ports, IPMI 2.0, 12 V DC power source, GPU add-on card power connector, dual 10GbE LAN option, HD Graphic outputs, and a combination of USB 2.0 and 3.2 ports. The motherboards also provide security-enhancing technologies such as Intel Software Guard Extensions (Intel SGX), Intel vPro, and Intel Trusted Execution Technology (TXT). The X12SCZ-TLN4F/QF/F offers exceptional system performance for entry server, data storage, network security, embedded applications, and cloud computing platforms.

The Intel PCH W480E chipset in conjunction with the new Intel Xeon W-1200 series processor, and the Intel Q470E chipset in conjunction with the new Intel 10th/11th Generation Core i series supports the following features:

- Intel Rapid Storage Technology
- Intel Rapid Storage Technology enterprise (Intel RST)
- Support for Management Engine (ME)
- Improved I/O capabilities to high-storage-capacity configurations
- Intel Virtualization Technology (Intel VT) and Trusted Execution Technology (Intel TXT)
- Intel Streaming SIMD Extensions 4.2 (Intel SSE 4.2), Intel AVX2, and Advanced Encryption Standard New Instructions (Intel AES-NI)
- Intel 64 Architecture, Execute Disable Bit, Turbo Boost Technology 2.0, Hyper-Threading Technology (Intel HT Technology)
- PCI Express 3.0, SATA 3.0, USB 3.2



**Note:** The X12SCZ motherboard series does not support the Intel 10th/11th generation processor 2 M cache SKUs. These processors will not boot with the latest BIOS version.

## 1.3 Special Features

### Recovery from AC Power Loss

The Basic I/O System (BIOS) provides a setting that determines how the system will respond when AC power is lost and then restored to the system. You can choose for the system to remain powered off (in which case you must press the power switch to turn it back on), or for it to automatically return to the power-on state. See the Advanced BIOS Setup section for this setting. The default setting is **Last State**.

## 1.4 System Health Monitoring

This section describes the health monitoring features of the X12SCZ-TLN4F/QF/F motherboard. The motherboard has an onboard System Hardware Monitoring chip that supports system health monitoring.

### Onboard Voltage Monitors

An onboard voltage monitor will scan the voltages of the onboard chipset, memory, CPU, and battery continuously. Once a voltage becomes unstable, a warning is given, or an error message is sent to the screen. The user can adjust the voltage thresholds to define the sensitivity of the voltage monitor.

### Fan Status Monitor with Firmware Control

The system health monitor embedded in the BMC chip can check the RPM status of the cooling fans. The CPU and chassis fans are controlled via IPMI.

### Environmental Temperature Control

System Health sensors monitor temperatures and voltage settings of onboard processors and the system in real time via the IPMI interface. Whenever the temperature of the CPU or the system exceeds a user-defined threshold, system/CPU cooling fans will be turned on to prevent the CPU or the system from overheating.



**Note:** To avoid possible system overheating, please be sure to provide adequate air-flow to your system.

## System Resource Alert

This feature is available when used with SuperDoctor 5® in the Windows OS or in the Linux environment. SuperDoctor is used to notify the user of certain system events. For example, you can configure SuperDoctor to provide you with warnings when the system temperature, CPU temperatures, voltages and fan speeds go beyond a predefined range.

## 1.5 ACPI Features

The Advanced Configuration and Power Interface (ACPI) specification defines a flexible and abstract hardware interface that provides a standard way to integrate power management features throughout a computer system, including its hardware, operating system and application software. This enables the system to automatically turn on and off peripherals such as CD-ROMs, network cards, hard disk drives and printers.


In addition to enabling operating system-directed power management, ACPI also provides a generic system event mechanism for Plug and Play, and an operating system-independent interface for configuration control. ACPI leverages the Plug and Play BIOS data structures, while providing a processor architecture-independent implementation that is compatible with appropriate Windows operating systems. For detailed information regarding OS support, please refer to the Supermicro website.

## 1.6 Power Supply

As with all computer products, a stable power source is necessary for proper and reliable operation. It is even more important for processors that have high CPU clock rates where noisy power transmission is present.

This motherboard accommodates a 24-pin ATX power supply. Although most power supplies generally meet the specifications required by the CPU, some are inadequate. In addition, one 12 V 8-pin power connection is also required to ensure adequate power supply to the system.

**Warning:** To avoid damaging the power supply or the motherboard, be sure to use a power supply that contains a 24-pin and an 8-pin power connector. Be sure to connect the power supplies to the 24-pin power connector (JPW1), and the 8-pin power connector (JPV1) on the motherboard. Failure in doing so may void the manufacturer warranty on your power supply and motherboard.

 **Note 1:** The X12SCZ Series motherboard alternatively supports an 8-pin 12 V DC input power only at JPV1 for embedded applications. The 12 V DC input is limited to 30 A by design. It provides up to 360 W power input to the motherboard. Please keep the onboard power usage within the power limits specified above. Overcurrent power usage may cause damage to the motherboard.



**Note 2:** Please connect both the 8-pin DC power at JPV1 to make sure the CPU receives enough power for normal operation when using the ATX power supply.

It is strongly recommended that you use a high quality power supply that meets ATX power supply Specification 2.02 or above.

## 1.7 Serial Port

This motherboard supports two serial communication connections. COM headers 1 and 2 can be used for input/output. The UART provides legacy speeds with a baud rate of up to 115.2 Kbps as well as an advanced speed with baud rates of 250 K, 500 K, or 1 Mb/s, which support high-speed serial communication devices.

## Chapter 2

# Installation

### 2.1 Static-Sensitive Devices

Electrostatic Discharge (ESD) can damage electronic components. To avoid damaging your system board, it is important to handle it very carefully. The following measures are generally sufficient to protect your equipment from ESD.

#### Precautions

- Use a grounded wrist strap designed to prevent static discharge.
- Touch a grounded metal object before removing the board from the antistatic bag.
- Handle the motherboard by its edges only; do not touch its components, peripheral chips, memory modules or gold contacts.
- When handling chips or modules, avoid touching their pins.
- Put the motherboard and peripherals back into their antistatic bags when not in use.
- For grounding purposes, make sure that your computer chassis provides excellent conductivity between the power supply, the case, the mounting fasteners and the motherboard.
- Use only the correct type of onboard CMOS battery. Do not install the onboard battery upside down to avoid possible explosion.


#### Unpacking

The motherboard is shipped in antistatic packaging to avoid static damage. When unpacking the motherboard, make sure that the person handling it is static protected.

## 2.2 Processor and Heatsink Installation

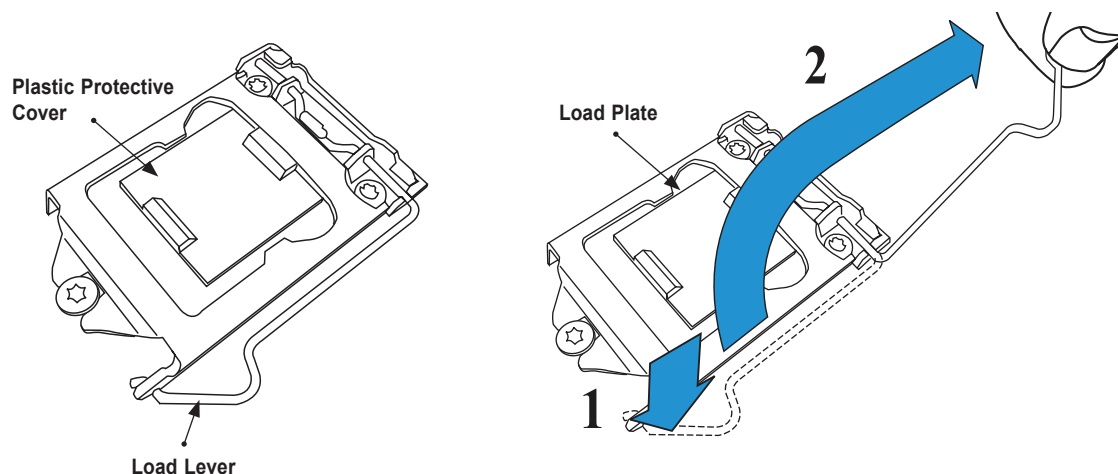
**Warning:** When handling the processor package, avoid placing direct pressure on the label area of the fan.

### Important:

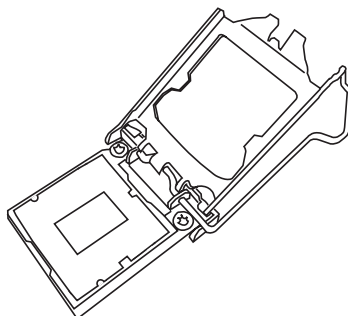
-  ESD protection.
- Unplug the AC power cord from all power supplies after shutting down the system.
- Check that the plastic protective cover is on the CPU socket and none of the socket pins are bent. If they are, contact your retailer.
- When handling the processor, avoid touching or placing direct pressure on the LGA lands (gold contacts). Improper installation or socket misalignment can cause serious damage to the processor or CPU socket, which may require manufacturer repairs.
- Thermal grease is pre-applied on a new heatsink. No additional thermal grease is needed.
- Refer to the Supermicro website for updates on processor support.
- All graphics in this manual are for illustrations only. Your components may look different.

### Installing the LGA1200 Processor

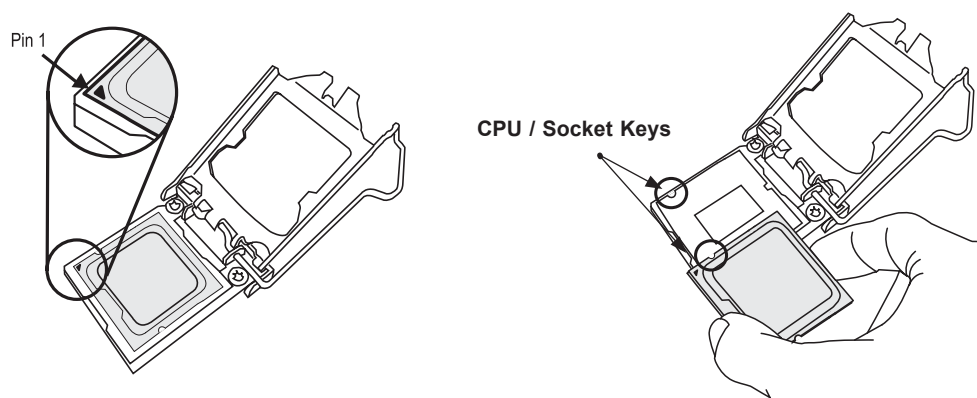
1. Press the load lever down to release the load plate from its locking position.



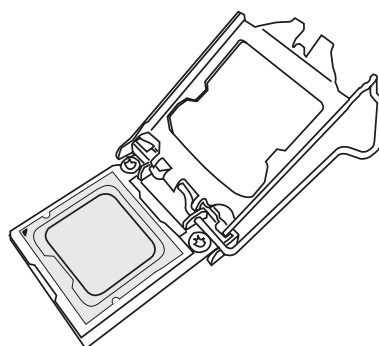
2. Gently lift the load lever to open the load plate. Remove the plastic protective cover. Do not touch the CPU socket contacts.



3. Locate the triangle on the CPU and CPU socket, which indicates the location of Pin 1. Holding the CPU by the edges with your thumb and index finger, align the triangle on the CPU with the triangle on the socket. The CPU keys (the semi-circle cutouts) may also be aligned against the socket keys as a guide.

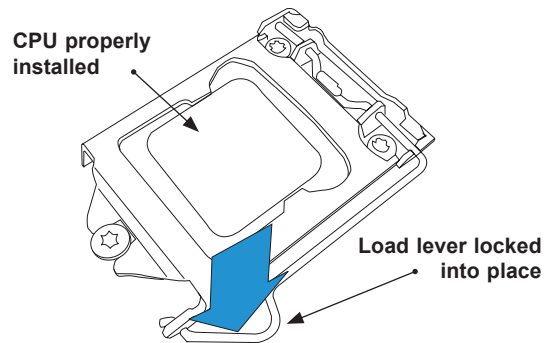



4. Carefully lower the CPU straight down into the socket. Do not drop the CPU on the socket, or move it horizontally or vertically to avoid damaging the CPU or socket. Inspect the four corners of the CPU to make sure that the CPU is properly installed.





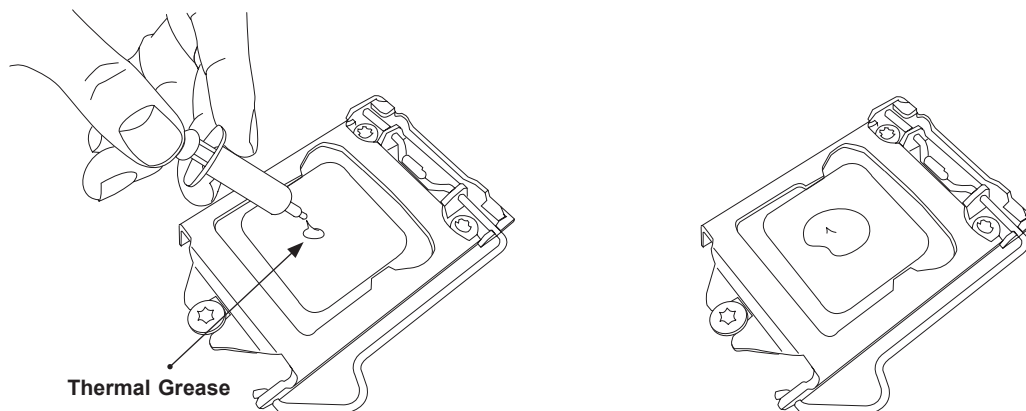
5. Close the load plate, then gently push down the load lever into its locking position.



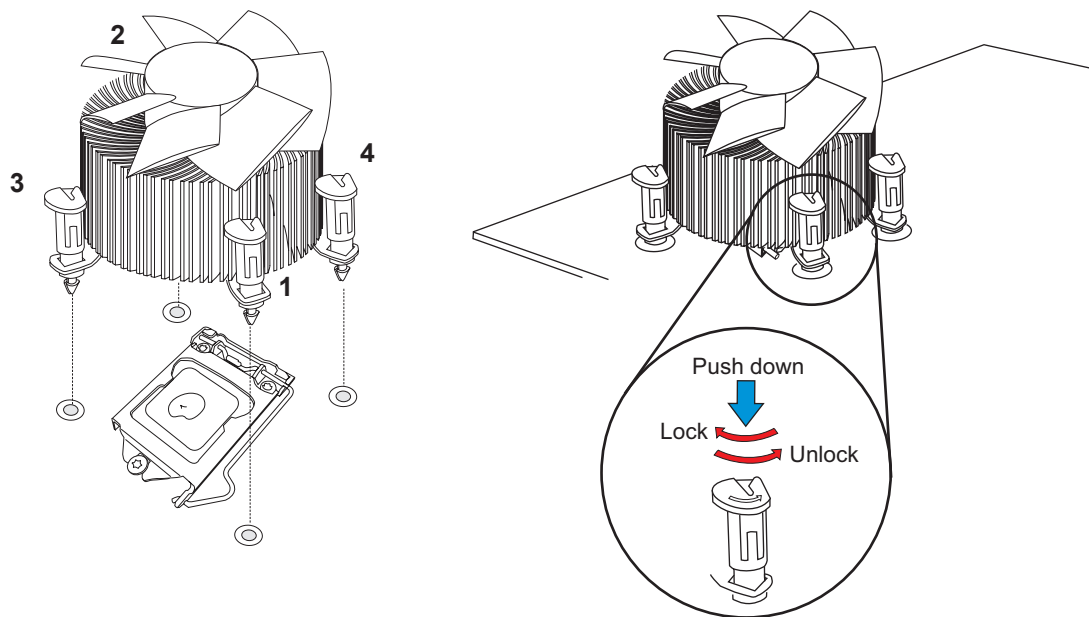
 **Note:** You can only install the CPU in one direction. Make sure it is properly inserted into the socket before closing the load plate. If it doesn't close properly, do not force it as it may damage your CPU. Instead, open the load plate again and double-check that the CPU is properly aligned.

## Installing an Active CPU Heatsink with Fan

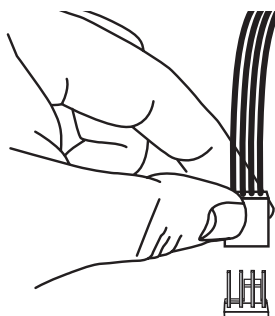
1. Locate the CPU fan header on the motherboard (FAN1: CPU FAN).
2. Position the heatsink so that the heatsink fan wires are closest to the CPU fan header and are not interfering with other components.
3. Inspect the CPU fan wires to make sure they are routed through the bottom of the heatsink.
4. Remove the thin layer of protective film from the heatsink. CPU overheating may occur if the protective film is not removed from the heatsink.
5. Apply the proper amount of thermal grease on the CPU. If your heatsink came with a thermal pad, please ignore this step.




- Align the four heatsink fasteners with the mounting holes on the motherboard. Gently push down the fasteners in a diagonal order (Example: #1 and #2, then #3 and #4) into the mounting holes until you hear a click. Then lock the fasteners by turning each one 90° clockwise.



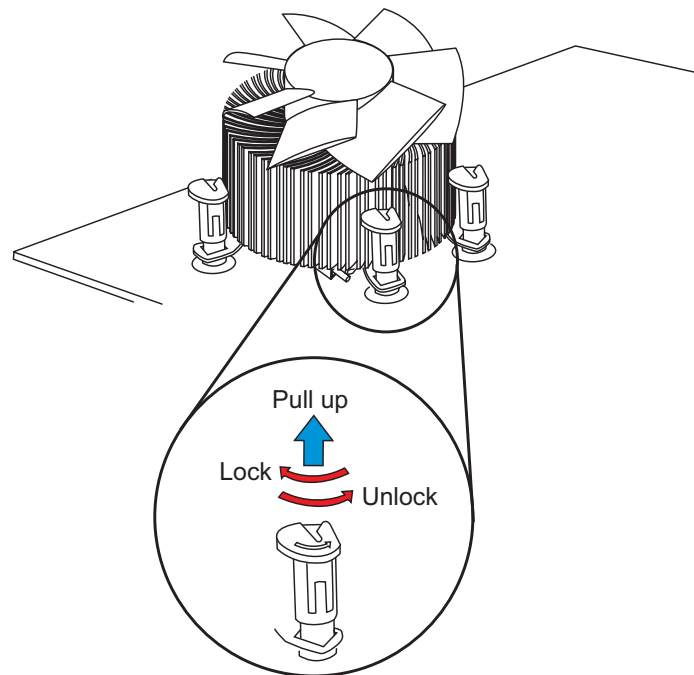
- Once all four fasteners are secured, connect the heatsink fan wire connector to the CPU fan header.



## Removing the Heatsink

 **Note:** We do not recommend that the CPU or heatsink be removed. However, if you do need to remove the heatsink, please follow the instructions below to remove the heatsink and prevent damage done to the CPU or other components.

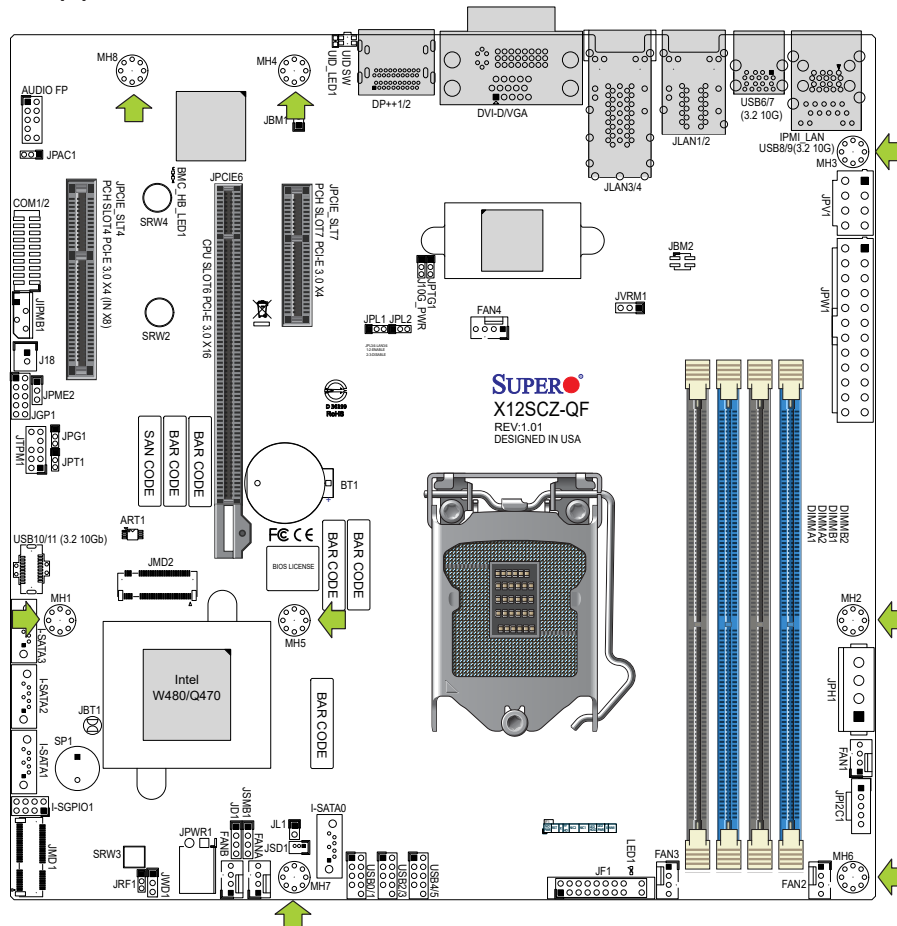
1. Unplug the power connector from the power supply.
2. Disconnect the heatsink fan connector from the CPU fan header.
3. Gently press down each fastener cap and turn them 90° counter clockwise, then pull the fasteners upwards to loosen them.
4. Remove the heatsink from the CPU.




## 2.3 Motherboard Installation

All motherboards have standard mounting holes to fit different types of chassis. Make sure that the locations of all the mounting holes for both the motherboard and the chassis match. Although a chassis may have both plastic and metal mounting fasteners, metal ones are highly recommended because they ground the motherboard to the chassis. Make sure that the metal standoffs click in or are screwed in tightly.

### Tools Needed

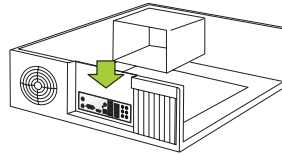


### Location of Mounting Holes

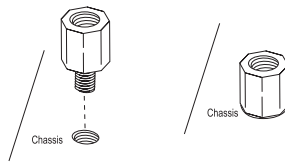
-  **Note:** 1) To avoid damaging the motherboard and its components, please do not use a force greater than 8 lbf-in on each mounting screw during motherboard installation. 2) Some components are very close to the mounting holes. Please take precautionary measures to avoid damaging these components when installing the motherboard to the chassis.

## Installing the Motherboard

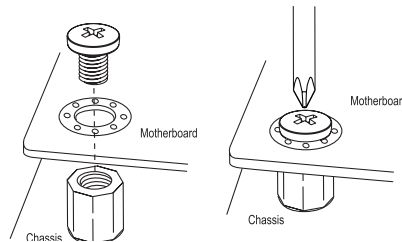
1. Install the I/O shield into the back of the chassis, if applicable.




2. Locate the mounting holes on the motherboard. See the previous page for the location.



3. Locate the matching mounting holes on the chassis. Align the mounting holes on the motherboard against the mounting holes on the chassis.



4. Install standoffs in the chassis as needed.
5. Install the motherboard into the chassis carefully to avoid damaging other motherboard components.
6. Using the Phillips screwdriver, insert a pan head #6 screw into a mounting hole on the motherboard and its matching mounting hole on the chassis.
7. Repeat Step 5 to insert #6 screws into all mounting holes.
8. Make sure that the motherboard is securely placed in the chassis.

 **Note:** Images displayed are for illustration only. Your chassis or components might look different from those shown in this manual.

## 2.4 Memory Support and Installation



**Note:** Check the Supermicro website for recommended memory modules.



**Important:** Exercise extreme care when installing or removing DIMM modules to prevent any possible damage.

### Memory Support

The X12SCZ-TLN4F/F supports up to 128 GB of ECC or Non-ECC DDR4 UDIMM memory with speeds of up to 2933 MT/s in four memory slots. The X12SCZ-QF does not support ECC memory. Refer to the tables below for the recommended DIMM population order and additional memory information.

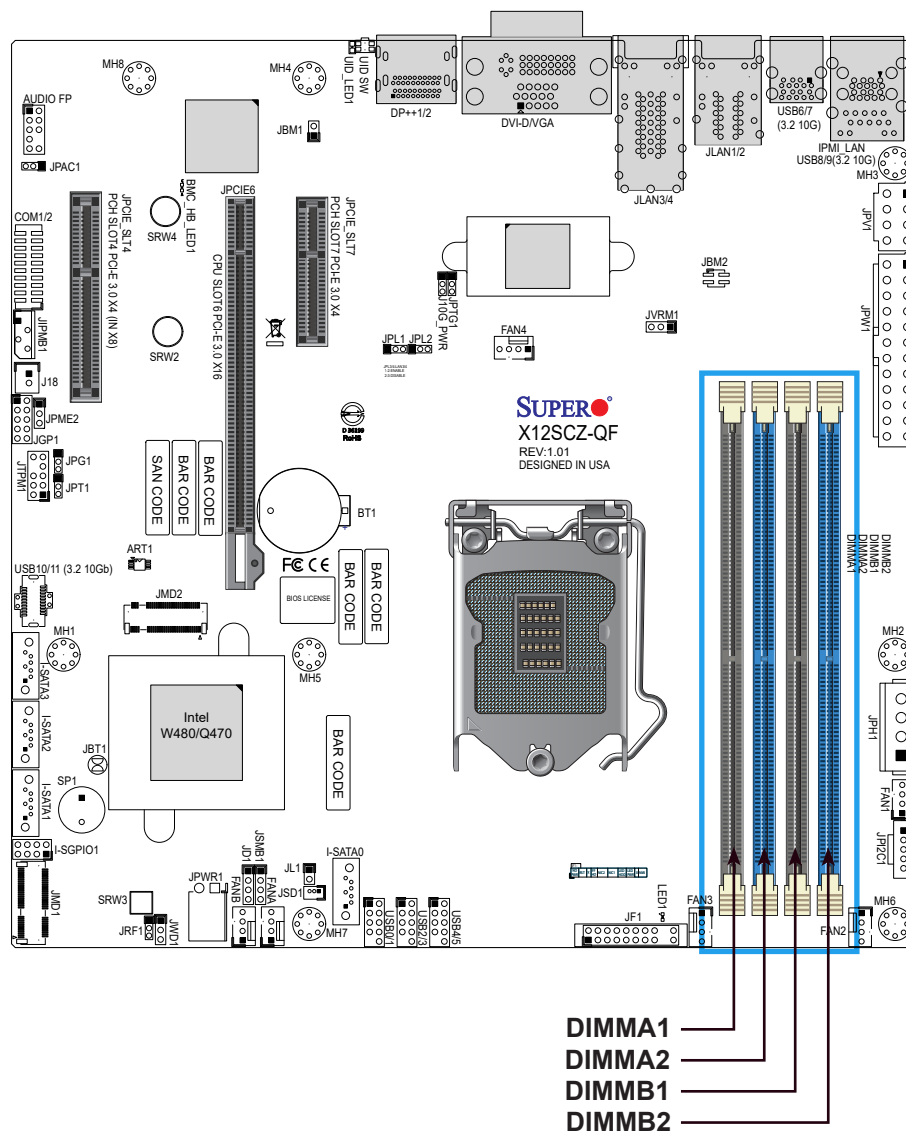
### DIMM Module Population Configuration

For optimal memory performance, follow the table below when populating memory.

Recommended Population (Balanced)				
DIMMA1	DIMMB1	DIMMA2	DIMMB2	Total System Memory
		4 GB	4 GB	8 GB
4 GB	4 GB	4 GB	4 GB	16 GB
		8 GB	8 GB	16 GB
8 GB	8 GB	8 GB	8 GB	32 GB
		16 GB	16 GB	32 GB
16 GB	16 GB	16 GB	16 GB	64 GB
		32 GB	32 GB	64 GB
32 GB	32 GB	32 GB	32 GB	128 GB

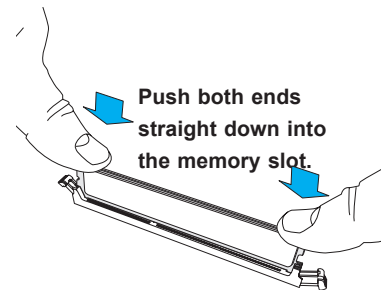
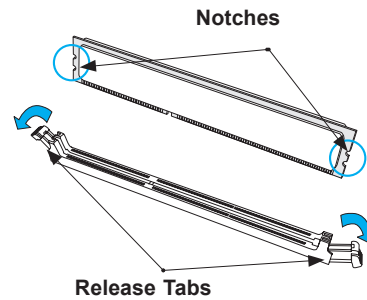
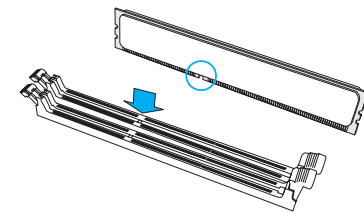
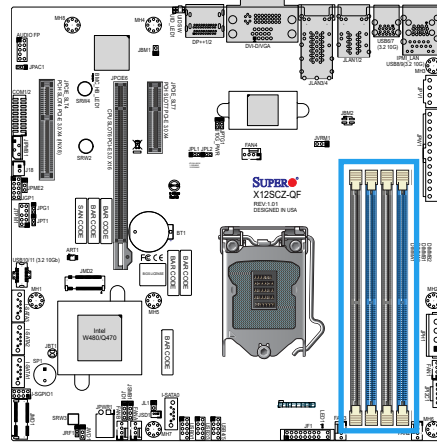
## General Guidelines for Optimizing Memory Performance

- The blue slots must be populated first. DIMM slots must be populated in the following order: DIMMA2, DIMMB2, then DIMMA1, DIMMB1.
- It is recommended to use DDR4 memory of the same type, size, and speed.
- Mixed DIMM speeds can be installed. However, all DIMMs will run at the speed of the slowest DIMM.
- The motherboard will support odd-numbered modules (one or three modules installed). However, to achieve the best memory performance, a balanced memory population is recommended.



## DIMM Installation

1. Insert DIMM modules in the following order: DIMMB2, DIMMA2, then DIMMB1, DIMMA1. For the system to work properly, please use memory modules of the same type and speed.
2. Push the release tabs outwards on both ends of the DIMM slot to unlock it.
3. Align the key of the DIMM module with the receptive point on the memory slot.
4. Align the notches on both ends of the module against the receptive points on the ends of the slot.
5. Push both ends of the module straight down into the slot until the module snaps into place.
6. Press the release tabs to the lock positions to secure the DIMM module into the slot.



## DIMM Removal

Press both release tabs on the ends of the DIMM module to unlock it. Once the DIMM module is loosened, remove it from the memory slot.



## 2.5 Rear I/O Ports

See Figure 2-1 below for the locations and descriptions of the various I/O ports on the rear of the motherboard.

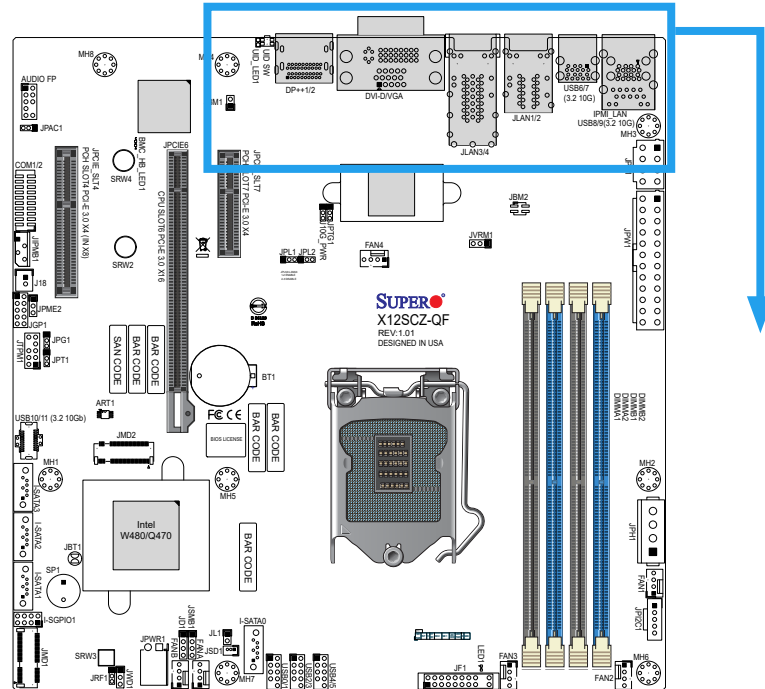
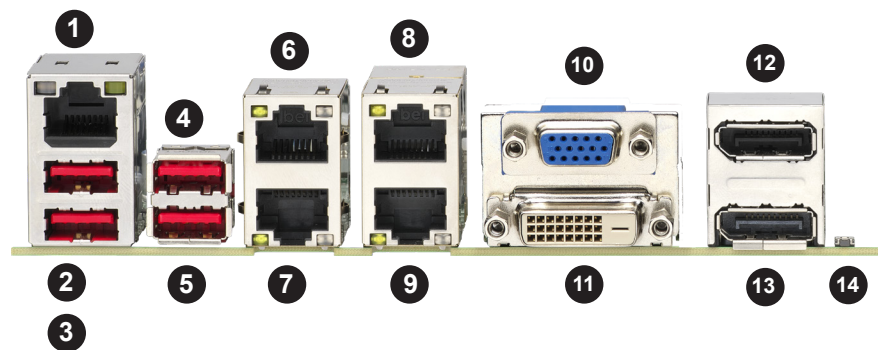


Figure 2-1. I/O Port Locations and Definitions



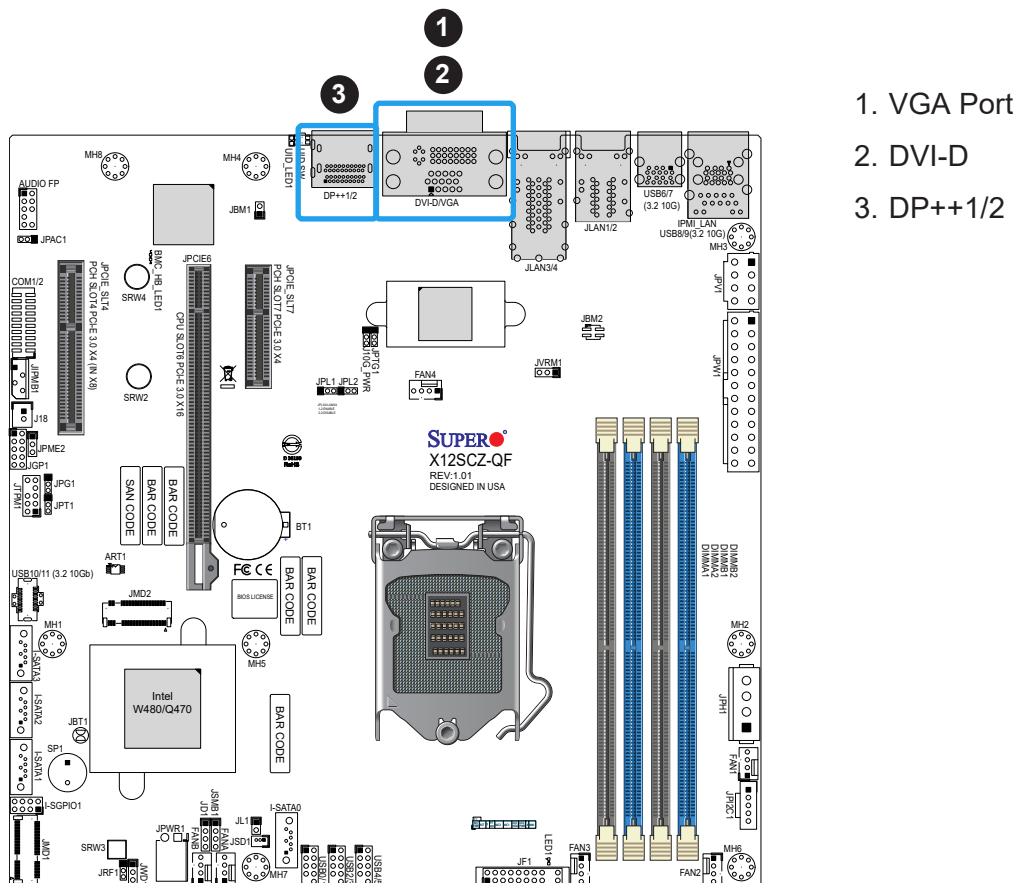
Rear I/O Ports					
#	Description	#	Description	#	Description
1	IPMI LAN	6	LAN2	11	DVI-D
2	USB9 (3.2)	7	LAN1	12	DisplayPort 2
3	USB8 (3.2)	8	LAN4 (-TLN4F Only)	13	DisplayPort 1
4	USB7 (3.2)	9	LAN3 (-TLN4F Only)	14	UID Switch
5	USB6 (3.2)	10	VGA		

### VGA/DVI-D Port

A VGA port and a DVI-D port are located next to DisplayPorts 1/2 on the I/O back panel. Use these connections for VGA and DVI displays. The VGA connector is on top and the DVI-D is on the bottom.

### DP++ (DisplayPort)

There are two DisplayPorts located on the rear I/O back panel. DisplayPort, developed by the VESA consortium, delivers digital display and fast refresh rate. It can connect to virtually any display using a DisplayPort adaptor for devices such as VGA, DVI, or HDMI.

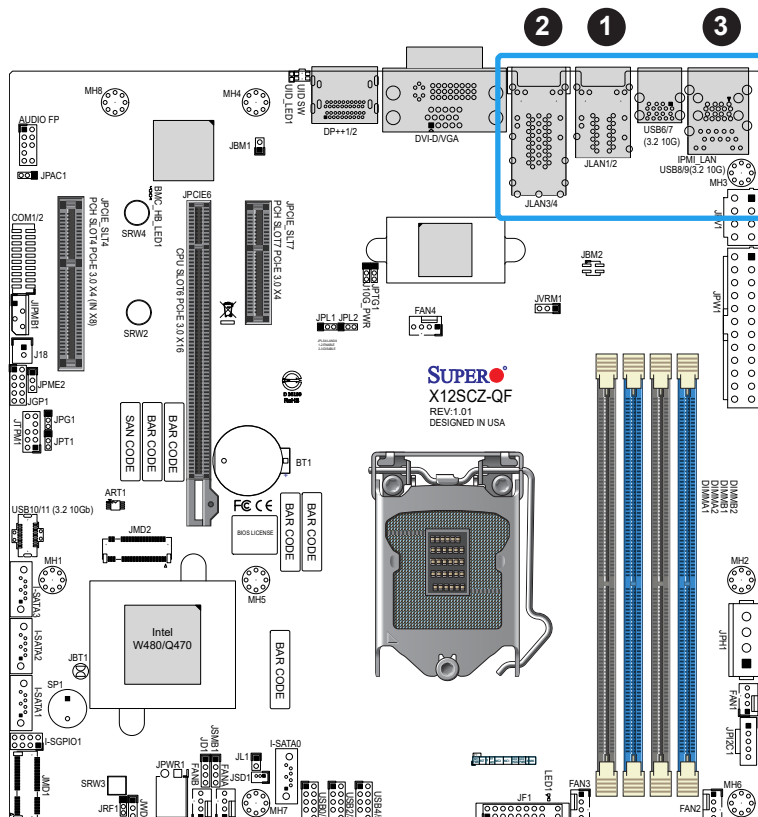


## LAN Ports

Two Gigabit (JLAN1/2) and two 10 Gigabit (JLAN3/4 - TLN4F SKU only) Ethernet ports are located on the I/O back panel. In addition, a dedicated IPMI LAN is located above the USB8/9 ports on the back panel. All of these ports accept RJ45 cables. Please refer to the LED Indicator section for LAN LED information.

LAN Port Pin Definition			
Pin#	Definition	Pin#	Definition
1	TRCT2	13	IETCT
2	TRD2+	14	IET+
3	TRD2-	15	IET-
4	TRD3+	16	
5	TRD3-	17	L1-GRE-
6	TRCT3	18	L1-GRE+
7	TRCT1	19	L2-YEL-
8	TRD1+	20	COMMON
9	TRD1-	21	L2-GRE-
10	TRD4+	22	CG1
11	TRD4-	23	CG2
12	TRCT4		

IPMI LAN Pin Definition			
Pin#	Definition	Pin#	Definition
9	VCC	19	YEL-
10	TX1+	20	YEL+
11	TX1-	21	ORG+/GRN-
12	TX2+	22	ORG-/GRN+
13	TX2-	23	SGND
14	TX3+	24	SGND
15	TX3-	25	SGND
16	TX4+	26	SGND
17	TX4-		
18	GND		



1. LAN1/2
2. LAN3/4 (-TLN4F)
3. IPMI LAN

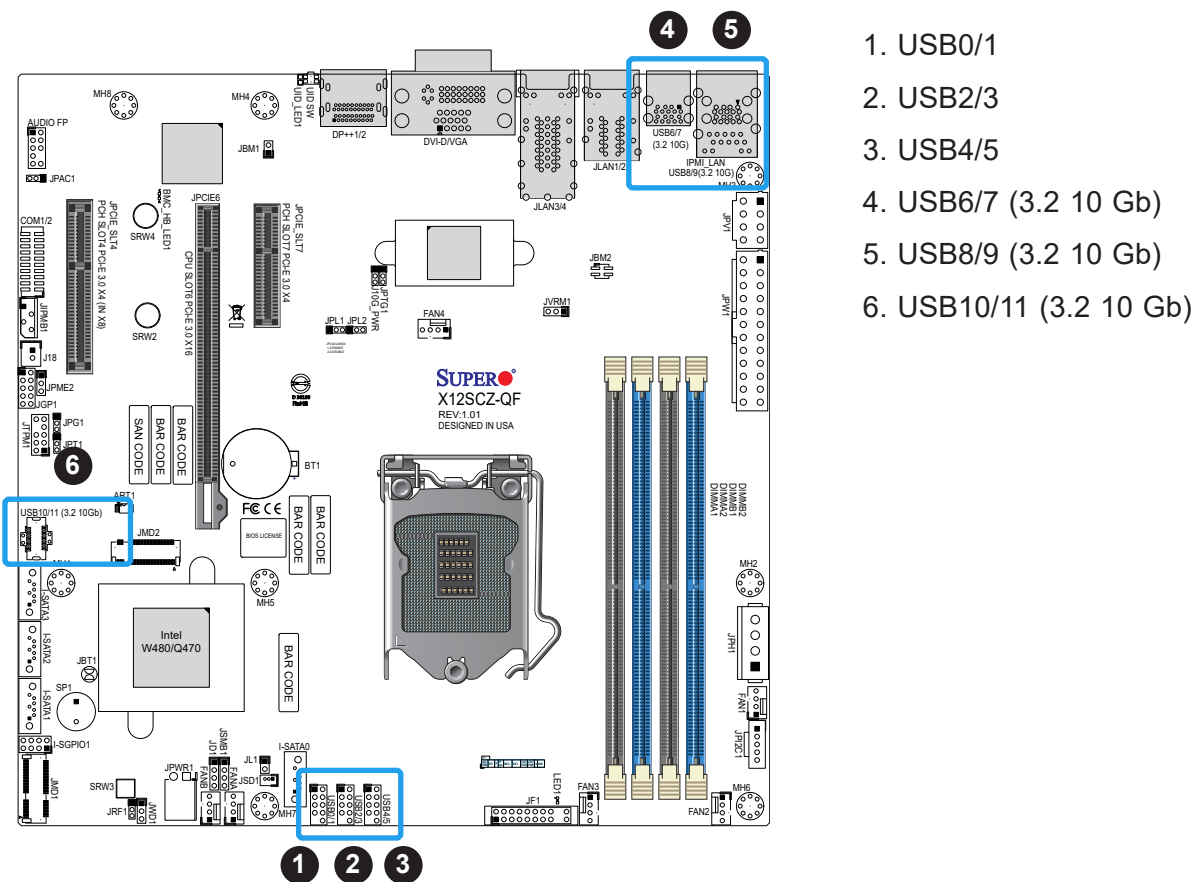
## Universal Serial Bus (USB) Ports

There are four USB 3.2 (10 Gb) ports (USB6/7 and USB8/9) located on the I/O back panel. The motherboard also has six front access USB 2.0 headers (USB0/1, USB2/3, and USB4/5). The USB10/11 header is USB 3.2 (10 Gb) Type-A. The onboard headers can be used to provide front side USB access with a cable (not included). Pin definition tables for USB ports and headers are on this page and the next.

Front Panel USB 0/1, 2/3, 4/5 (2.0) Pin Definitions			
Pin#	Definition	Pin#	Definition
1	+5 V	2	+5 V
3	USB_N	4	USB_N
5	USB_P	6	USB_P
7	Ground	8	Ground
9	Key	10	NC

Back Panel USB 6/7*, 8/9* (3.2) Pin Definitions			
Pin#	Definition	Pin#	Definition
A1	VBUS	B1	Power
A2	D-	B2	USB_N
A3	D+	B3	USB_P
A4	GND	B4	GND
A5	Stda_SSRX-	B5	USB3_RN
A6	Stda_SSRX+	B6	USB3_RP
A7	GND	B7	GND
A8	Stda_SSTX-	B8	USB3_TN
A9	Stda_SSTX+	B9	USB3_TP

\*S5 wake up support




**Universal Serial Bus (USB) Ports (continued)**

<b>Front Panel Type A USB 10/11 (3.2) Pin Definitions</b>			
Pin#	Definition	Pin#	Definition
1	GND	11	GND
2	SS_TX_P5_CON	12	SS_TX_N6_CON
3	SS_TX_N5_CON	13	SS_TX_P6_CON
4	GND	14	GND
5	SS_RX_P5_CON	15	SS_RX_N6_CON
6	SS_RX_N5_CON	16	SS_RX_P6_CON
7	GND	17	GND
8	USB_CON_P6	18	USB_CON_P5
9	USB_CON_N6	19	USB_CON_N5
10	VBUS	20	VBUS

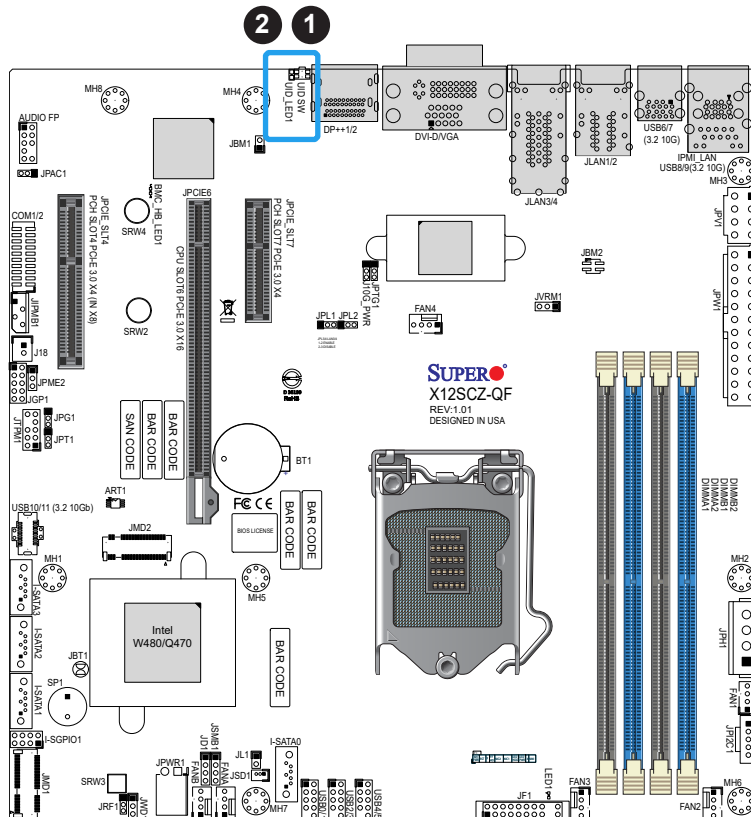
### Unit Identifier Switch/UID LED Indicator

A Unit Identifier (UID) switch and an LED Indicator are located on the motherboard. The UID switch is located at UID SW, which is next to the Display Port on the back panel. The UID LED is located next to the UID switch. When you press the UID switch, the UID LED will be turned on. Press the UID switch again to turn off the LED indicator. The UID Indicator provides easy identification of a system unit that may be in need of service.

 **Note:** UID can also be triggered via IPMI on the motherboard. For more information on IPMI, please refer to the IPMI User's Guide posted on our website at <https://www.supermicro.com/support/manuals/>.

UID Switch Pin Definitions	
Pin#	Definition
1	Ground
2	Ground
3	Button In
4	Button In

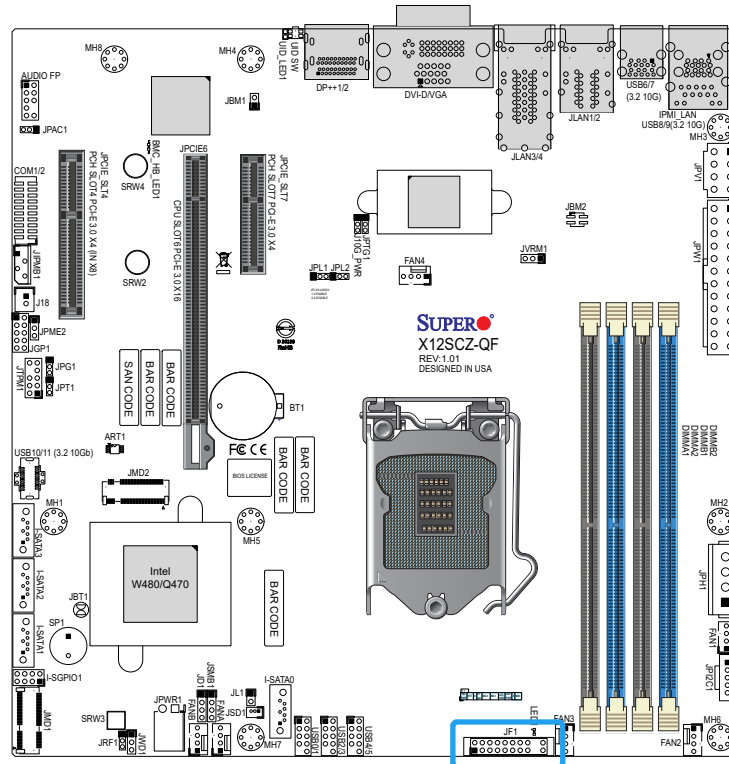
UID LED Pin Definitions	
Color	Status
Blue	On
Unit Identified	Unit Identified



- 1. UID Switch
- 2. UID LED

## 2.6 Front Control Panel

JF1 contains header pins for various buttons and indicators that are normally located on a control panel at the front of the chassis. These connectors are designed specifically for use with Supermicro chassis. See the figure below for the descriptions of the front control panel buttons and LED indicators.



	1	2	
<b>PWR</b> } Power Button	○	○	Ground
<b>Reset</b> } Reset Button	○	○	Ground
3.3V	○	○	Power Fail LED
UID LED	○	○	OH/Fan Fail LED
NIC2 Activity LED	○	○	NIC2 Link LED
NIC1 Activity LED	○	○	NIC1 Link LED
3.3V Stby	○	○	HDD LED
3.3V Stby	○	○	PWR LED
X	○	○	X
NMI	○	○	Ground
	19	20	

Figure 2-2. JF1 Header Pins

### Power Button

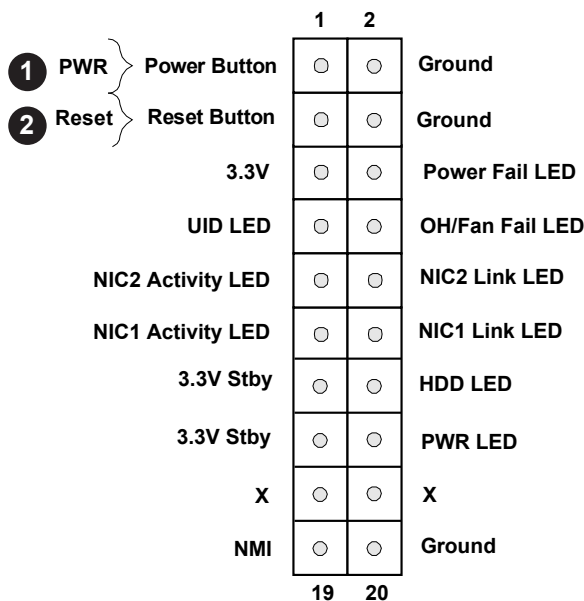
The Power Button connection is located on pins 1 and 2 of JF1. Momentarily contacting both pins will power on/off the system. This button can also be configured to function as a suspend button (with a setting in the BIOS - see Chapter 4). To turn off the power when the system is in suspend mode, press the button for four seconds or longer. Refer to the table below for pin definitions.

Power Button Pin Definitions (JF1)	
Pin#	Definition
1	Signal
2	Ground

### Reset Button

The Reset Button connection is located on pins 3 and 4 of JF1. Attach it to a hardware reset switch on the computer case to reset the system. Refer to the table below for pin definitions.

Reset Button Pin Definitions (JF1)	
Pin#	Definition
3	Reset
4	Ground



1. PWR Button
2. Reset Button



## Power Fail LED

The Power Fail LED connection is located on pins 5 and 6 of JF1. Refer to the table below for pin definitions.

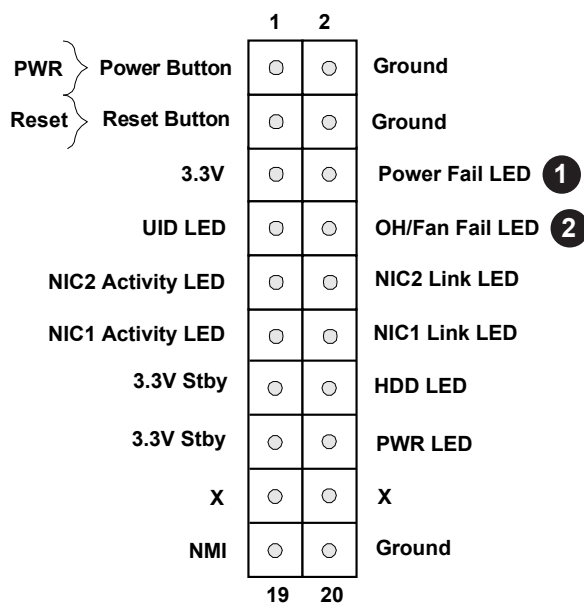
Power Fail LED Pin Definitions (JF1)	
Pin#	Definition
5	3.3 V
6	Power Fail LED

## Overheat (OH)/Fan Fail

Connect an LED cable to pins 7 and 8 of the Front Control Panel to use the Overheat/Fan Fail LED connections. The LED on pin 8 provides warnings of overheating or fan failure. Refer to the tables below for pin definitions.

OH/Fan Fail Indicator Status	
State	Definition
Off	Normal
On	Overheat
Flashing	Fan Fail

OH/Fan Fail LED Pin Definitions (JF1)	
Pin#	Definition
7	Blue UID LED
8	OH/Fan Fail LED



1. Power Fail LED
2. OH/Fan Fail LED

### NIC1/NIC2 (LAN1/LAN2)

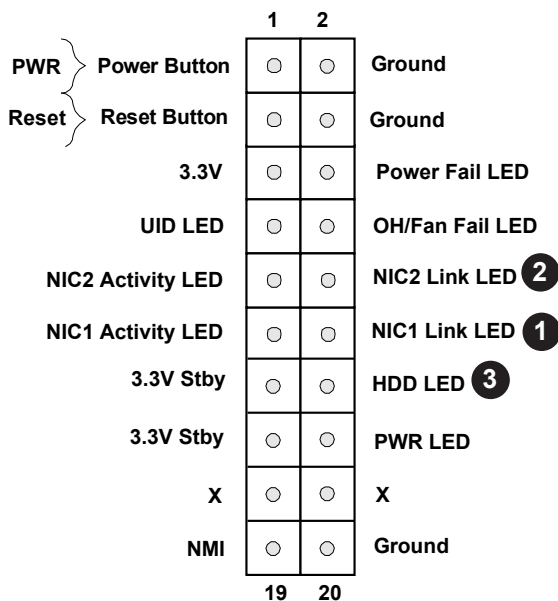
The NIC (Network Interface Controller) LED connection for LAN port 1 is located on pins 11 and 12 of JF1, and LAN port 2 is on pins 9 and 10. Attach the NIC LED cables here to display network activity. Refer to the table below for pin definitions.

NIC1/NIC2 LED Pin Definitions (JF1)	
Pin#	Definition
9	NIC 2 Activity LED
10	NIC 2 Link LED
11	NIC 1 Activity LED
12	NIC 1 Link LED

### HDD LED

The HDD LED connection is located on pins 13 and 14 of JF1. Attach a cable to pin 14 to show hard drive activity status. Refer to the table below for pin definitions.

HDD LED Pin Definitions (JF1)	
Pins	Definition
13	3.3 V Stdby
14	HDD Active



1. NIC1 LED
2. NIC2 LED
3. HDD LED

## Power LED

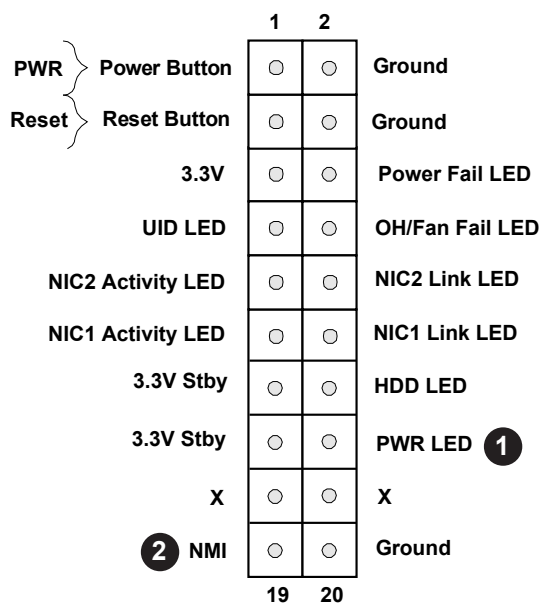
The Power LED connection is located on pins 15 and 16 of JF1. Refer to the table below for pin definitions.

Power LED Pin Definitions (JF1)	
Pins	Definition
15	3.3 Stby
16	PWR LED

## NMI Button

The non-maskable interrupt (NMI) button header is located on pins 19 and 20 of JF1. Refer to the table below for pin definitions.

NMI Button Pin Definitions (JF1)	
Pins	Definition
19	Control
20	Ground



1. Power LED
2. NMI



## 8-Pin Power Connector

JPV1 is an 8-pin 12V DC power input for CPU or alternative single power source for a special enclosure when the 24-pin ATX power is not in use. Refer to the table below for pin definitions.

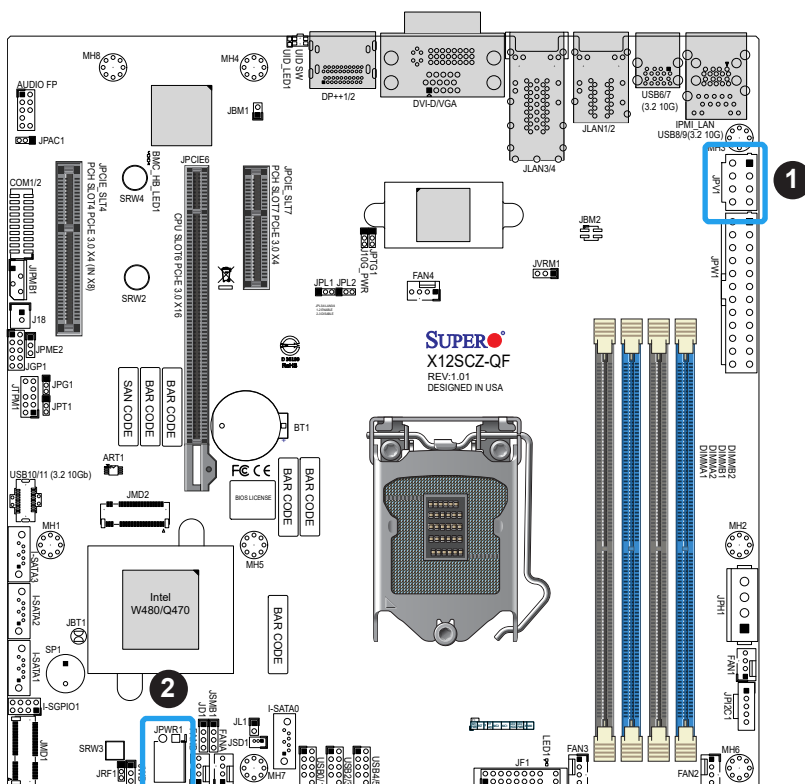
8-pin Power Pin Definitions	
Pin#	Definition
1 - 4	Ground
5 - 8	P12 V (12 V Power)

### Required Connection

## 4-pin 12V Power Connector

JPWR1 is a 4-pin connector that provides 12 V DC power (up to 75 W) from the motherboard for a GPU add-on card or various peripherals. Please keep the power usage for JPWR1 within the power limits of up to 75 W. Overcurrent DC power usage may cause damage to the motherboard. Refer to the table below for pin definitions.

4-pin Power Pin Definitions	
Pin#	Definition
1 - 2	Ground
3 - 4	+12 V



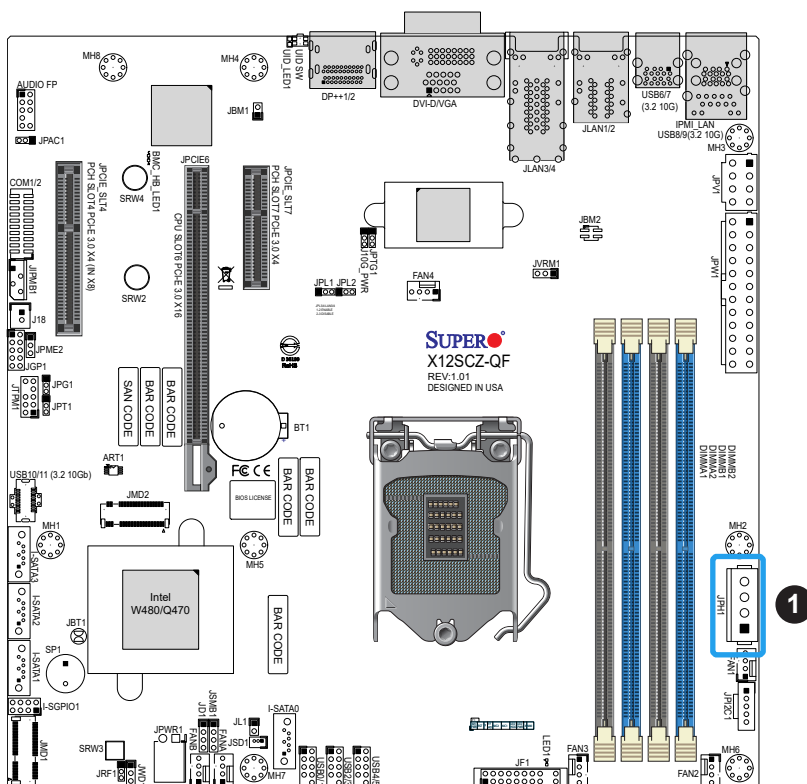
1. 8-pin 12 V DC Power
2. 4-pin 12 V Power

### 4-pin HDD Power Connector

JPH1 is a 4-pin power connector that provides power to onboard HDD devices. Refer to the table below for pin definitions.

4-pin HDD Power Pin Definitions	
Pin#	Definition
1	12 V
2	GND
3	GND
4	5 V

1. 4-pin HDD Power

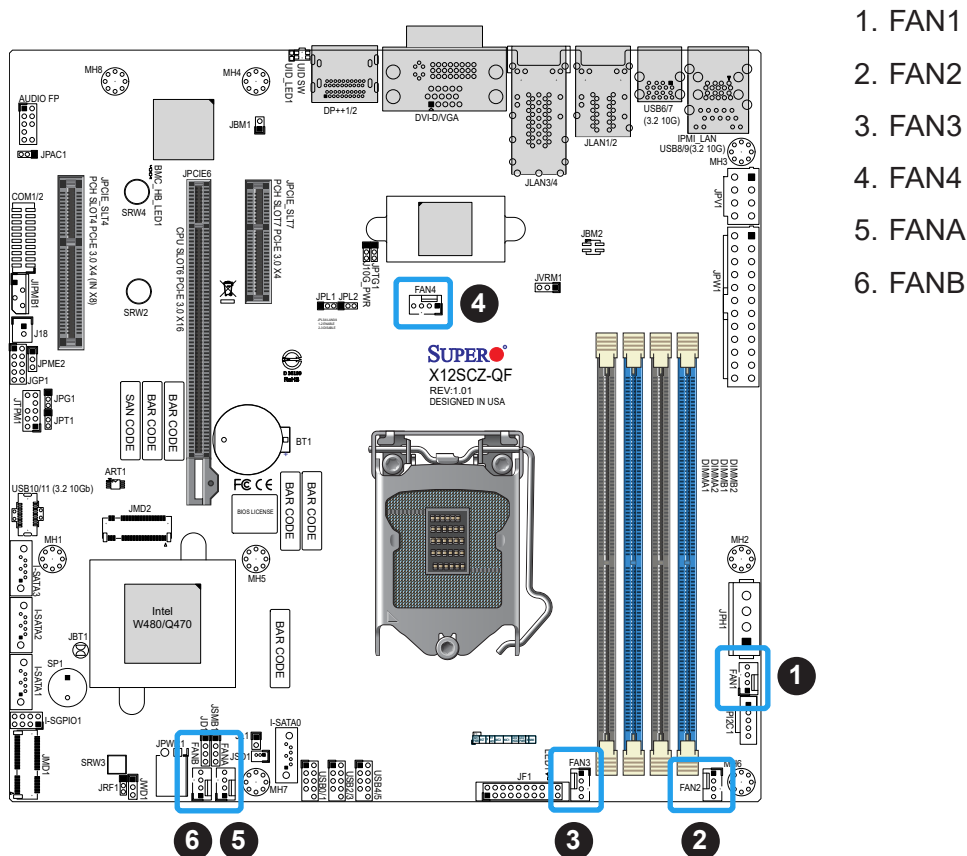


## Headers

### Fan Headers

There are six 4-pin fan headers (FAN1–FAN4, FANA1 and FANB1) on the motherboard. All these 4-pin fan headers are backwards compatible with the traditional 3-pin fans. However, fan speed control is available for 4-pin fans only by Thermal Management via the IPMI 2.0 interface. Refer to the table below for pin definitions.

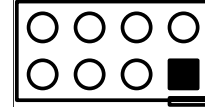
Fan Header Pin Definitions	
Pin#	Definition
1	Ground (Black)
2	2.5 A/+12 V (Red)
3	Tachometer
4	PWM_Control



### SGPIO Headers

There is one Serial Link General Purpose Input/Output (I-SGPIO1) header located on the motherboard. I-SGPIO is for SATA use. Refer to the tables below for pin definitions.

SGPIO Header Pin Definitions			
Pin#	Definition	Pin#	Definition
1	NC	2	NC
3	Ground	4	Data
5	Load	6	Ground
7	Clock	8	NC



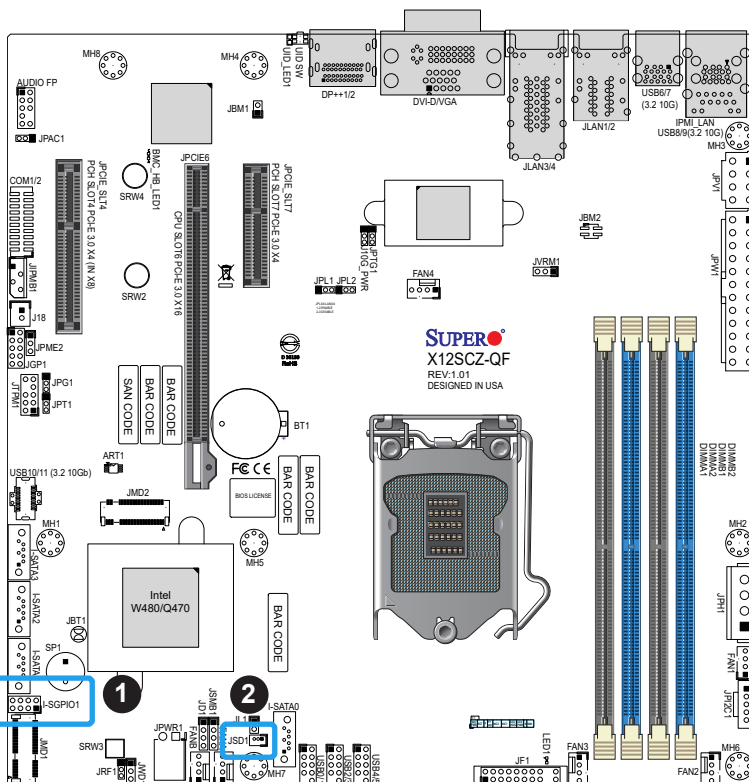
Pin 8	Pin 6	Pin 4	Pin 2
Pin 7	Pin 5	Pin 3	Pin 1

NC = No Connection

### Disk-On-Module Power Connector

One power connector for SATA Disk-On-Module (DOM) devices is located at JSD1. Connect appropriate cables here to provide power support for your Serial Link DOM devices.

DOM Power Pin Definitions	
Pin#	Definition
1	5 V
2	Ground
3	Ground



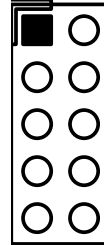
1. SGPIO Header
2. DOM Power



### General Purpose I/O Header

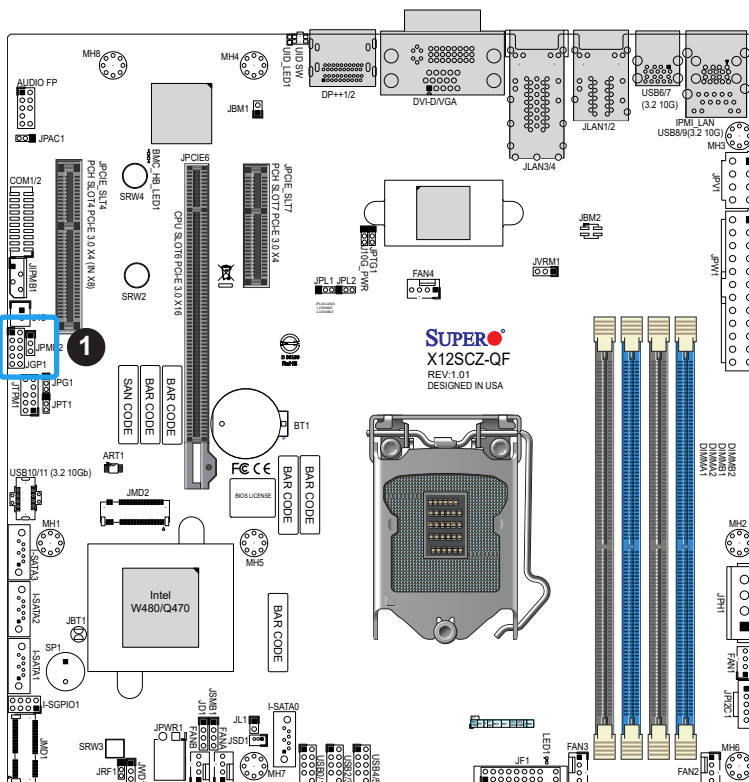
The JGP1 (General Purpose Input/Output) header is a general purpose I/O expander on a pin header via the SMBus. Refer to the table below for pin definitions.

General Purpose I/O Header Pin Definitions			
Pin#	Definition	Pin#	Definition
1	NC	2	GND
3	JGP1_0	4	JGP1_1
5	JGP1_2	6	JGP1_3
7	JGP1_4	8	JGP1_5
9	JGP1_6	10	JGP1_7



Pin 1	Pin 2
Pin 3	Pin 4
Pin 5	Pin 6
Pin 7	Pin 8
Pin 9	Pin 10

### 1. General Purpose Header

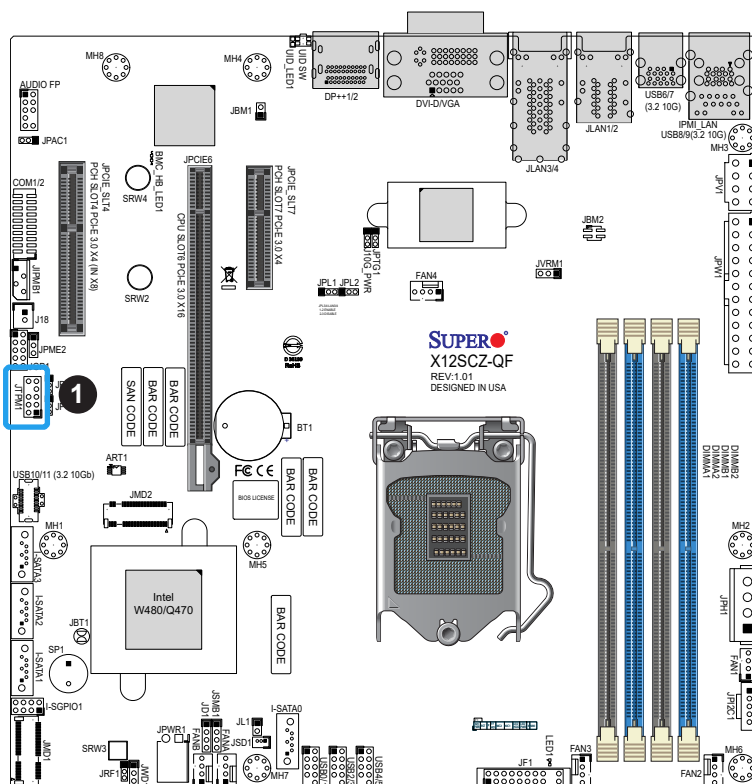


### TPM/Port 80 Header

A Trusted Platform Module (TPM)/Port 80 header is located at JTPM1 to provide TPM support and Port 80 connection. Use this header to enhance system performance and data security. Refer to the table below for pin definitions. Please go to the following link for more information on the TPM: <http://www.supermicro.com/manuals/other/TPM.pdf>.

Trusted Platform Module Header Pin Definitions			
Pin#	Definition	Pin#	Definition
1	+3.3 V	2	SPI_CS#
3	RESET#	4	SPI_MISO
5	SPI_CLK	6	GND
7	SPI_MOSI	8	NC
9	+3.3 V Stdbby	10	SPI_IRQ#

### 1. TPM Header



## System Management Bus Header

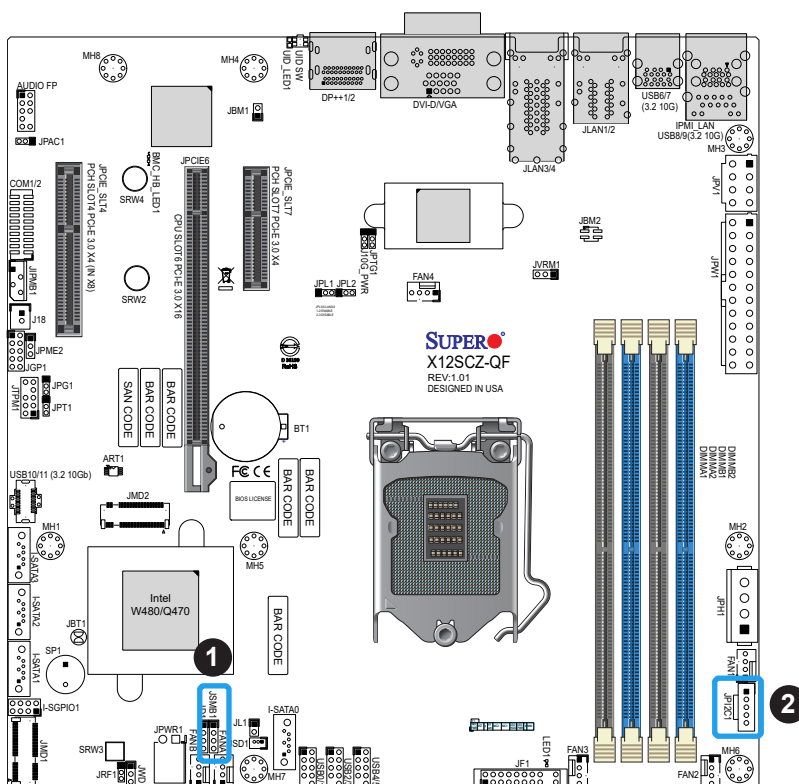
A System Management Bus header for additional slave devices or sensors is located at JSMB1. Refer to the table below for pin definitions.

SMBus Header Pin Definitions	
Pin#	Definition
1	Data
2	Ground
3	Clock

## Power SMB (I<sup>2</sup>C) Header

The Power System Management Bus (I<sup>2</sup>C) connector (JPI<sup>2</sup>C1) monitors the power supply, fan, and system temperatures. Refer to the table below for pin definitions.

Power SMB Header Pin Definitions	
Pin#	Definition
1	Clock
2	Data
3	PMBUS_Alert
4	Ground
5	+3.3 V



1. SMBus Header
2. Power SMBus Header

### 4-pin BMC External I<sup>2</sup>C Header

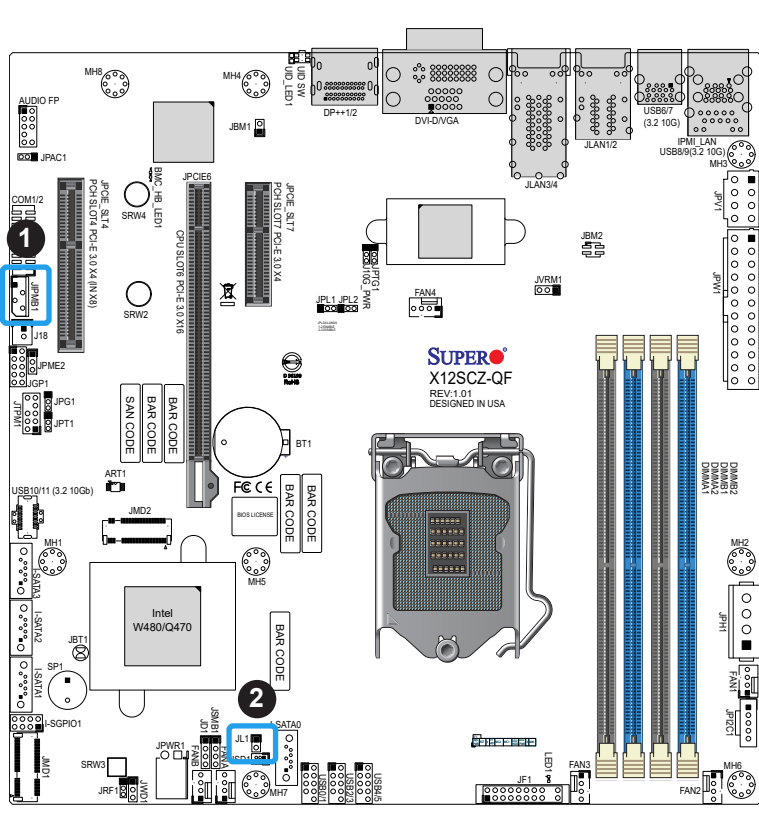
A System Management Bus header for IPMI 2.0 is located at JIPMB1. Connect the appropriate cable here to use the IPMB I<sup>2</sup>C connection on your system. Refer to the table below for pin definitions.

External I <sup>2</sup> C Header Pin Definitions	
Pin#	Definition
1	Data
2	Ground
3	Clock
4	No Connection

### Chassis Intrusion

A Chassis Intrusion header is located at JL1 on the motherboard. Attach the appropriate cable from the chassis to inform you of a chassis intrusion when the chassis is opened. Refer to the table below for pin definitions.

Chassis Intrusion Pin Definitions	
Pin#	Definition
1	Intrusion Input
2	Ground



1. External I<sup>2</sup>C Header
2. Chasis Intrusion



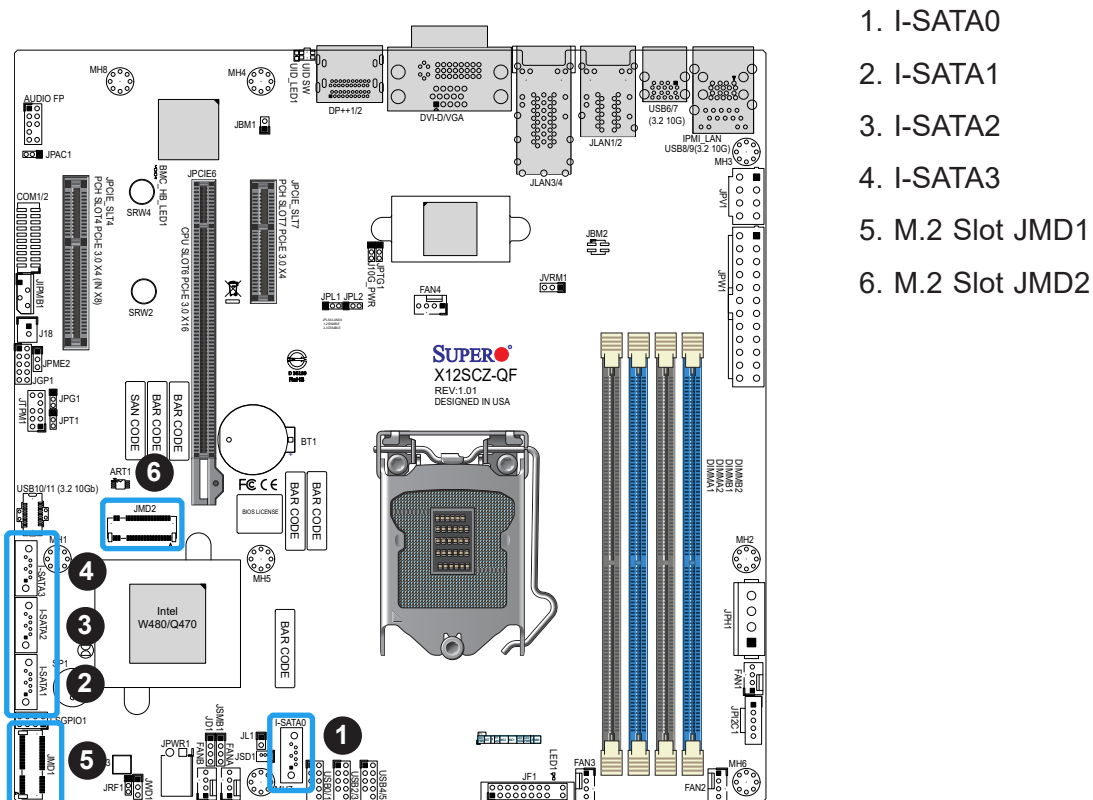
## SATA Ports

Four SATA 3.0 ports are located on the motherboard supported by the W480/Q470 chipset. These SATA ports support RAID 0, 1, 5, and 10. SATA ports provide serial-link signal connections, which are faster than the connections of Parallel ATA.

**Note:** For more information on the SATA HostRAID configuration, please refer to the Intel SATA HostRAID user's guide posted on our website at <https://www.supermicro.com/support/manuals/>.

## M.2 Slot

The motherboard has two M.2 slots (JMD1 and JMD2). M.2 was formerly known as Next Generation Form Factor (NGFF) and serves to replace mini PCIe. M.2 allows for a variety of card sizes, increased functionality, and spatial efficiency. JMD1 supports an E-Key CNVi/PCIe 3.0 x1 device in the 2230 form factor, whereas JMD2 supports an M-Key SATA/PCIe 3.0 x4 device in the 2280 and 22110 form factors.



## Extended CMOS Battery Connector

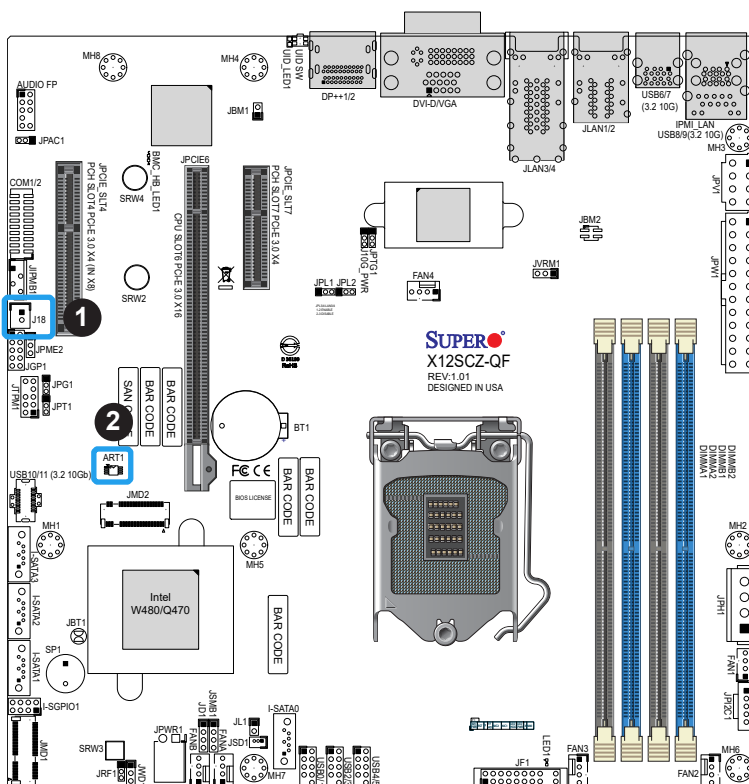
J18 is a power connector that provides additional power to maintain the CMOS data with an external battery. Refer to the table below for pin definitions.

CMOS Battery Connector Pin Definitions	
Pin#	Definition
1	VBAT
2	Ground

### Required Connection

## M.2 M-Key Temperature Sensor

ART1 is the M-Key temperature sensor.



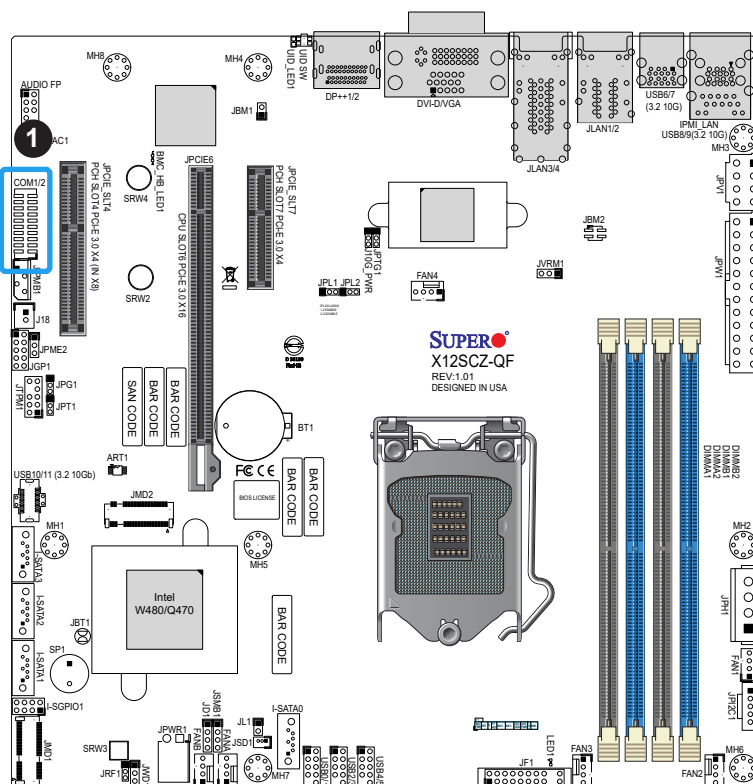
1. Extended CMOS Battery
2. M.2 Temperature Sensor

## COM Header

The motherboard has one COM header that provides two serial connections (COM1/2) and supports RS-232 function, utilizing Supermicro PN: CBL-CDAT-0604 (not included).

COM Header (COM1/2) Pin Definitions			
Pin#	Definition	Pin#	Definition
1	DCD3	2	DSR3
3	RXD3	4	RTS3
5	TXD3	6	CTS3
7	DTR3	8	RI3_N
9	GND	10	N/A
11	DCD4	12	DSR4
13	RXD4	14	RTS4
15	TXD4	16	CTS4
17	DTR4	18	RI4_N
19	GND	20	N/A

### 1. COM1/2 Header



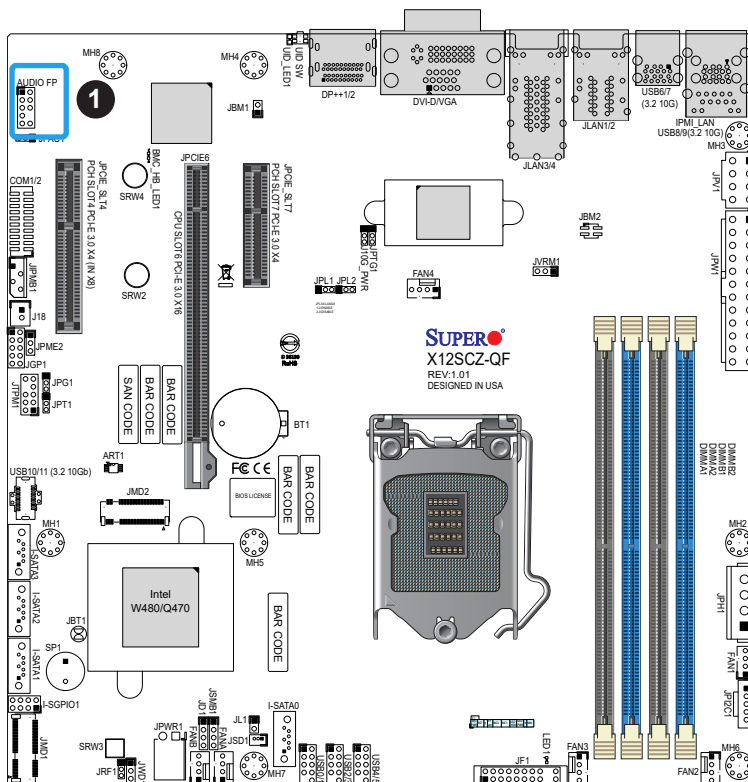


## Front Panel Audio Header

A 10-pin audio header located at AUDIO FP allows you to use the onboard for audio playback. Connect an audio cable to this header to use this feature. Refer to the table below for pin definitions.

Audio Header Pin Definitions			
Pin#	Definition	Pin#	Definition
1	Mic_2_Left	2	Audio_Ground
3	Mic_2_Right	4	Audio_Ground
5	Line_2_Right	6	Mic_2_JD
7	Jack_Detect	8	Key
9	Line_2_left	10	Line_2_JD


### 1. Front Panel Audio Header

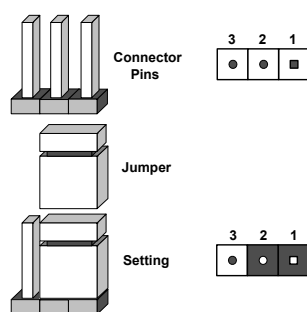


## 2.8 Jumper Settings

### How Jumpers Work

To modify the operation of the motherboard, jumpers can be used to choose between optional settings. Jumpers create shorts between two pins to change the function of the connector. Pin 1 is identified with a square solder pad on the printed circuit board. See the diagram below for an example of jumping pins 1 and 2. Refer to the motherboard layout page for jumper locations.

 **Note:** On two-pin jumpers, "Closed" means the jumper is on and "Open" means the jumper is off the pins.




### CMOS Clear

JBT1 is used to clear CMOS, which will also clear any passwords. Instead of pins, this jumper consists of contact pads to prevent accidentally clearing the contents of CMOS.

*To Clear CMOS*

1. First power down the system and unplug the power cord(s).
2. Remove the cover of the chassis to access the motherboard.
3. Remove the onboard battery from the motherboard.
4. Short the CMOS pads with a metal object such as a small screwdriver for at least four seconds.
5. Remove the screwdriver (or shorting device).
6. Replace the cover, reconnect the power cord(s), and power on the system.

 **Note:** Clearing CMOS will also clear all passwords.

Do not use the PW\_ON connector to clear CMOS.



JBT1 contact pads

## Watchdog Time

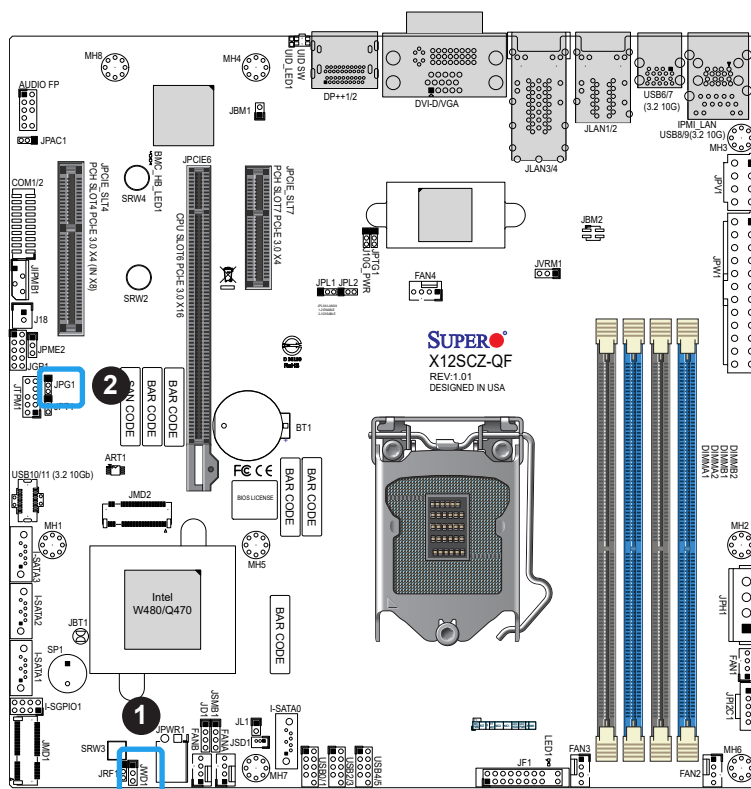
Watchdog (JWD1) is a system monitor that can reboot the system when a software application hangs. Close pins 1–2 to reset the system if an application hangs. Close pins 2–3 to generate a non-maskable interrupt (NMI) signal for the application that hangs. Refer to the table below for jumper settings. The Watchdog must also be enabled in the BIOS.

Watch Dog Jumper Settings	
Jumper Setting	Definition
Pins 1–2	Reset
Pins 2–3	NMI
Open	Disabled

## VGA Enable/Disable

Jumper JPG1 allows the user to enable the onboard VGA connector. The default setting is pins 1–2 to enable the connection. Refer to the table below for jumper settings.

VGA Enable/Disable Jumper Settings	
Jumper Setting	Definition
Pins 1–2	Enabled
Pins 2–3	Disabled



### LAN1/LAN2 Enable/Disable

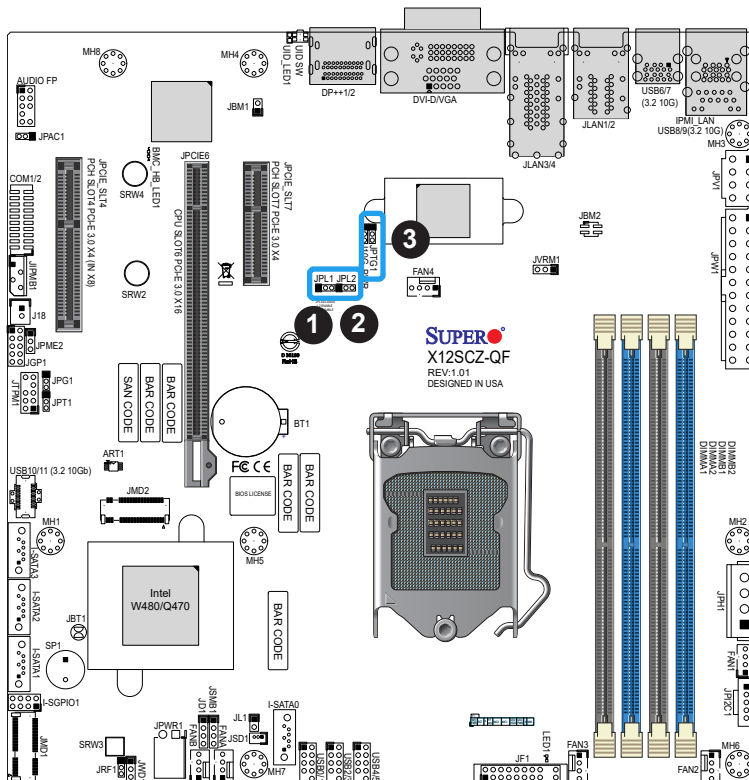
Use jumper JPL1 to enable or disable LAN port 1 and JPL2 to enable or disable LAN port 2.

LAN1/2 Enable/Disable Jumper Settings	
Jumper Setting	Definition
Pins 1–2	Enabled (Default)
Pins 2–3	Disabled

### LAN3/LAN4 Enable/Disable

Use jumper JPTG1 to enable or disable LAN ports 3 and 4.

LAN3/4 Enable/Disable Jumper Settings	
Jumper Setting	Definition
Pins 1–2	Enabled (Default)
Pins 2–3	Disabled



1. LAN1 Enable/Disable
2. LAN2 Enable/Disable
- 3/ LAN3/4 Enable/Disable

## Front Panel Audio Enable

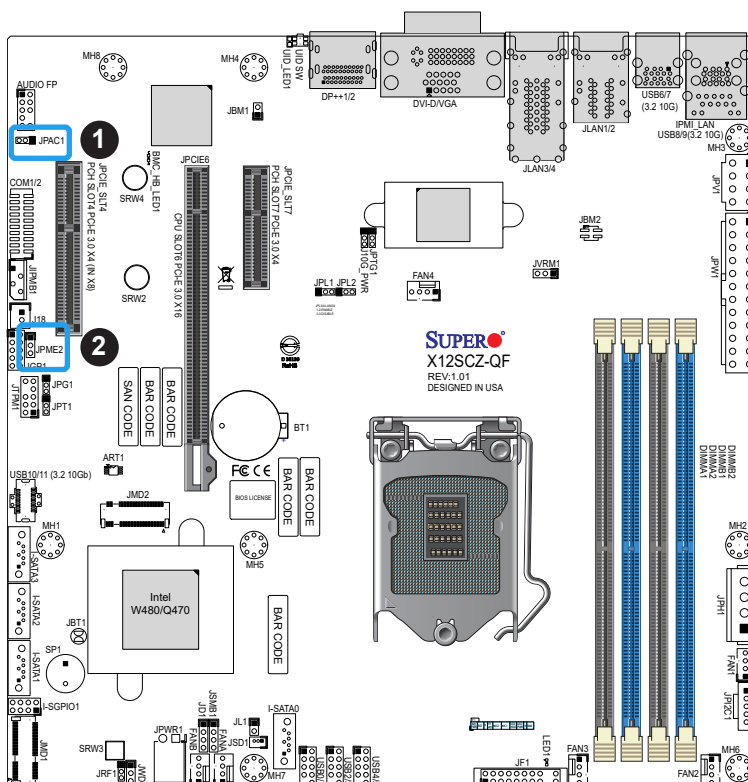
JPAC1 allows you to enable or disable the onboard audio support. The default position is on pins 1 and 2 to enable onboard audio connections. Refer to the table below for jumper settings.

Front Panel Audio Enable Jumper Settings	
Jumper Setting	Definition
Pins 1–2	Enabled (Default)
Pins 2–3	Disabled

## ME Manufacturing Mode

Close pins 2–3 of jumper JPME2 to bypass SPI flash security and force the system to operate in the manufacturing mode, which will allow the user to flash the system firmware from a host server for system setting modifications. Refer to the table below for jumper settings.

ME Manufacturing Mode Jumper Settings	
Jumper Setting	Definition
Pins 1–2	Normal (Default)
Pins 2–3	Manufacturing Mode



1. Front Panel Audio Enable
2. Manufacturing Mode

### IPMI Share LAN Feature

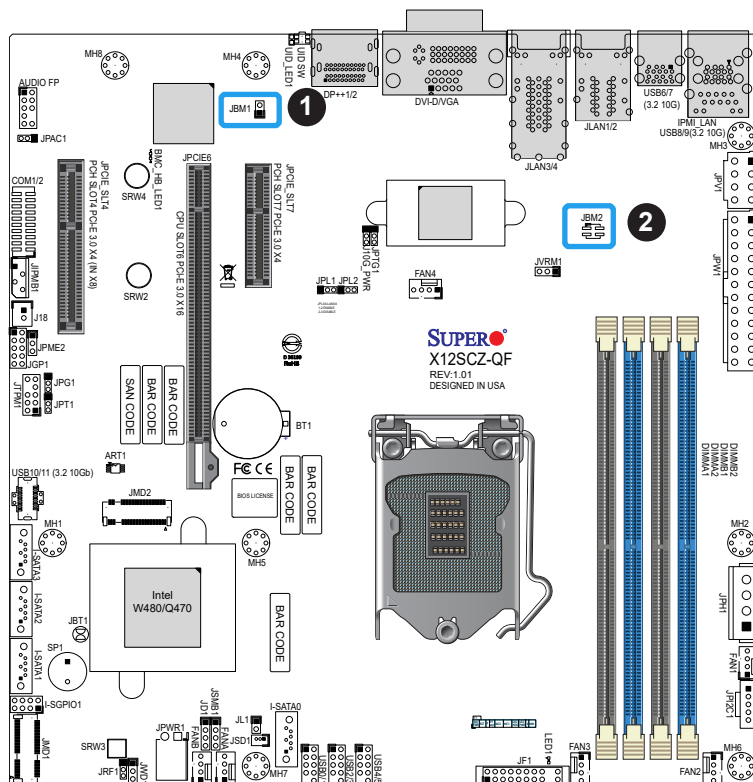
Set the JBM1 jumper to enable or disable IPMI shared access on LAN1 (Intel I210-AT).

IPMI Share LAN Enable/Disable Jumper Settings	
Jumper Setting	Definition
Pins 1-2 (Open)	Enabled (Default)
Pins 1-2 (Short)	Disabled

### IPMI LAN Enable/Disable

Use JBM2 to enable or disable IPMI remote access. Refer to the table below for jumper settings.

IPMI LAN Enable/Disable Jumper Settings	
Jumper Setting	Definition
Pins 1-3 (Short)	Enabled (Default)
Pins 1-2 (Short)	Disabled



1. IPMI Share LAN Feature
2. IPMI LAN Enable/Disable

## Slot6 PCIe Bifurcation Option

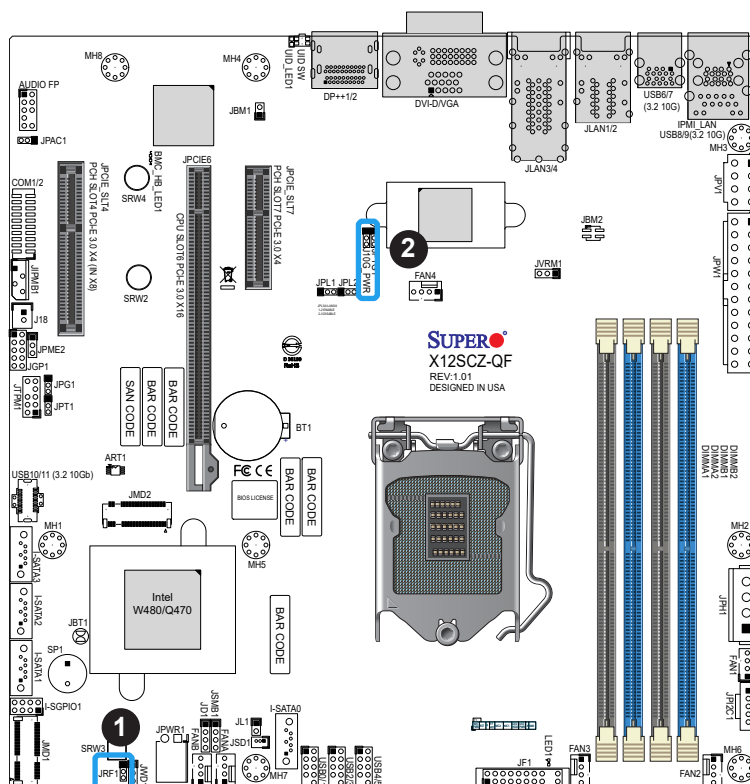
Set the JRF1 jumper to set Slot 6's PCIe lanes to either x16 or x8x8.

PCIe Bifurcation Jumper Settings	
Jumper Setting	Definition
Pins 1-2	x16 (Default)
Pins 2-3	x8x8

## LAN3/LAN4 Power Option

Use J10G\_PWR jumper to set the power option for LAN3 and LAN4 (Intel X550).

LAN3/LAN4 Power Jumper Settings	
Jumper Setting	Definition
Pins 1-2	Standby Power (Default)
Pins 2-3	Normal Power



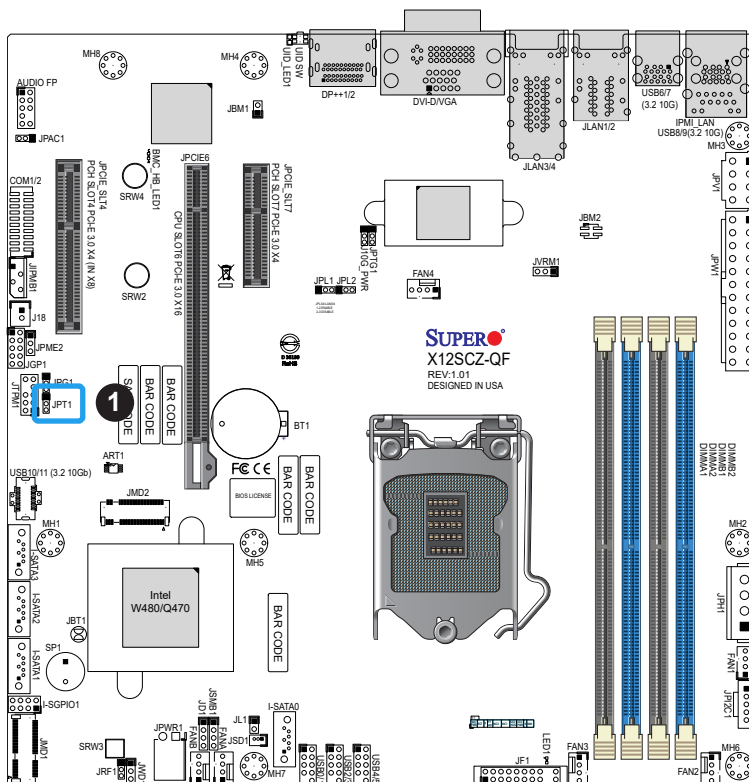
1. Slot6 PCIe Bifurcation
2. LAN3/LAN4 Power Option

## TPM Enable

Use JPT1 to enable or disable the onboard TPM 2.0. Refer to the table below for jumper settings.

TPM Enable/Disable Jumper Settings	
Jumper Setting	Definition
Pins 1–2	Enabled
Pins 2–3	Disabled (Default)

### 1. TPM Enable/Disable





## 2.9 LED Indicators

### LAN LEDs

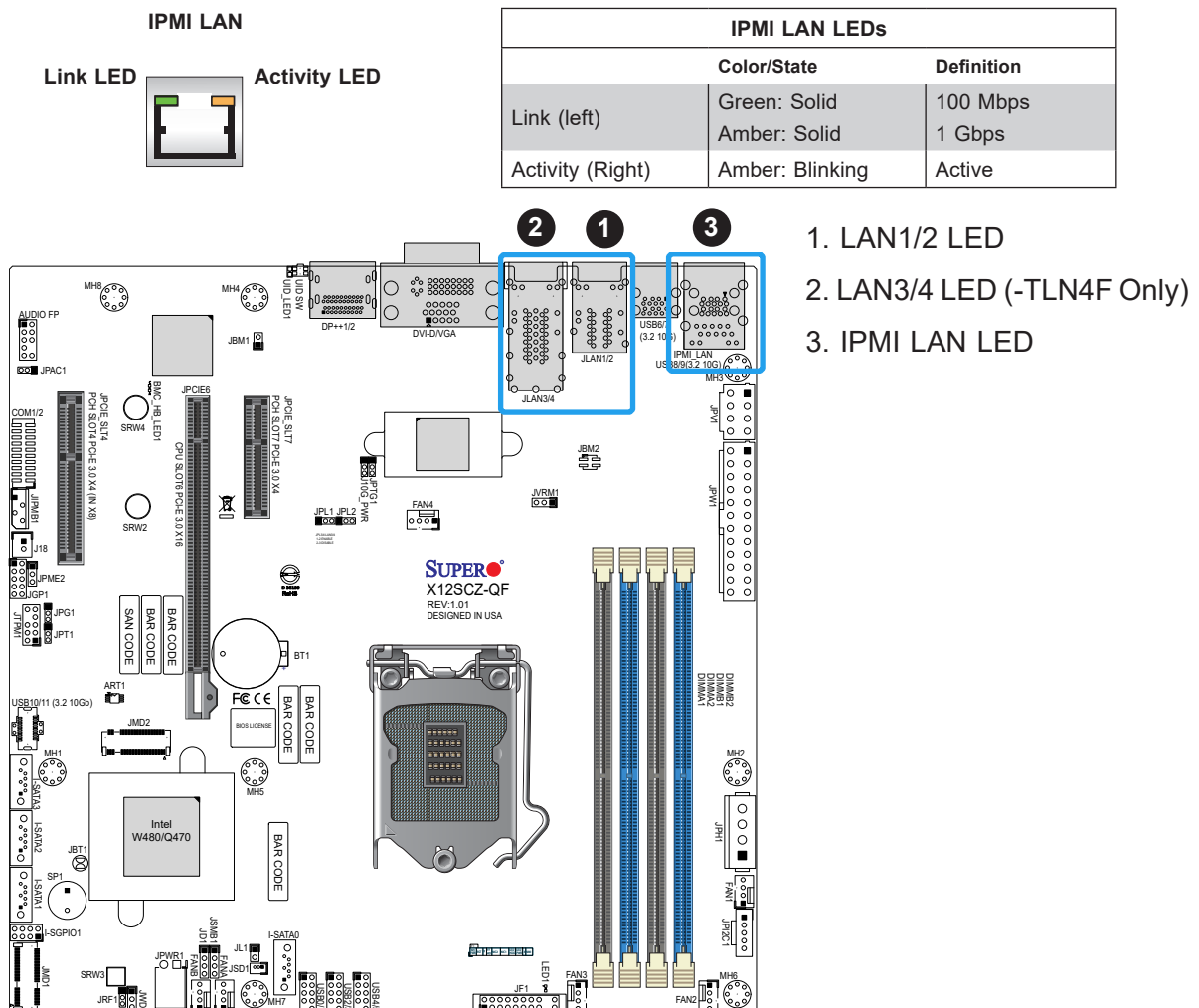
Four LAN ports (JLAN 1/2 and JLAN 3/4) are located on the I/O back panel of the motherboard. Each Ethernet LAN port has two LEDs. The green LED indicates activity, while the other Link LED may be green, amber, or off to indicate the speed of the connection. Refer to the tables below for more information.

LAN Activity LED (Right) LED State		
Color	Status	Definition
Yellow	Flashing	Active

LAN Link LED (Left) LED State	
LED Color	Definition
Green	100 Mbps
Orange/Amber	1 Gbps

### IPMI LAN LEDs

In addition to the four LAN ports, an IPMI LAN is also located on the I/O back panel. The amber LED on the right indicates activity, while the green LED on the left indicates the speed of the connection. Refer to the table below for more information.



### Power LED

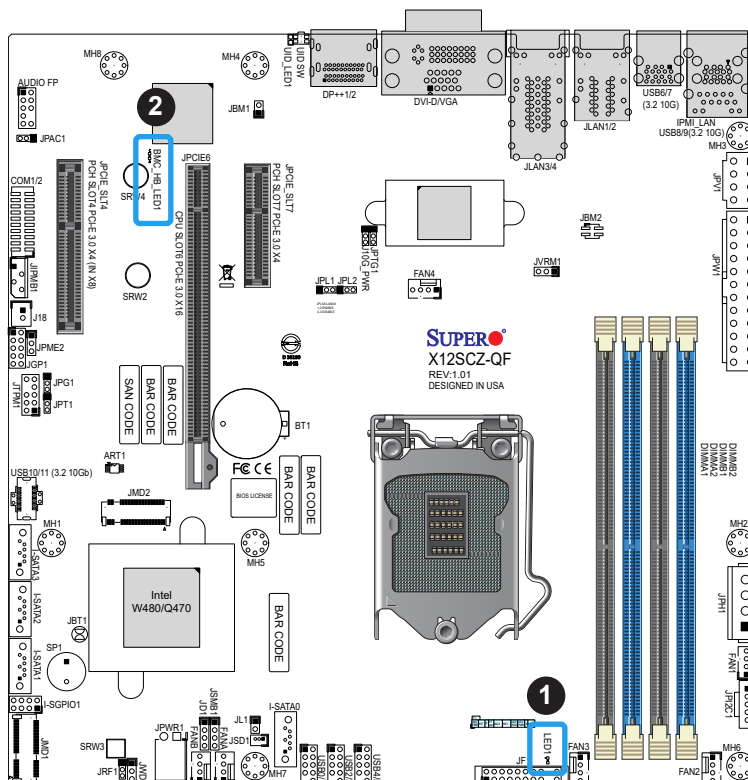
LED1 is the Power LED. When this LED is lit, it means power is present on the motherboard. In suspend mode, this LED will blink on and off. Be sure to turn off the system and unplug the power cord(s) before removing or installing components.

Power LED Indicator	
LED Color	Definition
Off	System Off (power cable not connected)
Green	System On

### BMC Heartbeat LED

BMC\_HB\_LED1 is the BMC heartbeat LED. When the LED is blinking green, BMC is functioning normally. Refer to the table below for the LED status.

BMC Heartbeat LED Indicator	
LED Color	Definition
Green: Blinking	BMC Normal



1. Power LED
2. BMC Heartbeat LED

# Chapter 3

## Troubleshooting

### 3.1 Troubleshooting Procedures

Use the following procedures to troubleshoot your system. If you have followed all of the procedures below and still need assistance, refer to the 'Technical Support Procedures' and/or 'Returning Merchandise for Service' section(s) in this chapter. Always disconnect the AC power cord before adding, changing or installing any non hot-swap hardware components.

#### Before Power On

1. Make sure that there are no short circuits between the motherboard and chassis.
2. Disconnect all ribbon/wire cables from the motherboard, including those for the keyboard and mouse.
3. Remove all add-on cards.
4. Install the CPU (making sure it is fully seated) and connect the front panel connectors to the motherboard.

#### No Power

1. Make sure that there are no short circuits between the motherboard and the chassis.
2. Make sure that the ATX power connectors are properly connected.
3. Check that the 115 V/230 V switch, if available, on the power supply is properly set.
4. Turn the power switch on and off to test the system, if applicable.
5. The battery on your motherboard may be old. Check to verify that it still supplies approximately 3 VDC. If it does not, replace it with a new one.

## No Video

1. If the power is on, but you have no video, remove all add-on cards and cables.
2. Use the speaker to determine if any beep codes are present. Refer to Appendix A for details on beep codes.
3. Remove all memory modules and turn on the system (if the alarm is on, check the specs of memory modules, reset the memory or try a different one).

## System Boot Failure

If the system does not display Power-On-Self-Test (POST) or does not respond after the power is turned on, check the following:

1. Check for any error beep from the motherboard speaker.
  - If there is no error beep, try to turn on the system without DIMM modules installed. If there is still no error beep, replace the motherboard.
  - If there are error beeps, clear the CMOS settings by unplugging the power cord and contacting both pads on the CMOS clear jumper (JBT1). Refer to Section 2.8 in Chapter 2.
2. Remove all components from the motherboard, especially the DIMM modules. Make sure that system power is on and that memory error beeps are activated.
3. Turn on the system with only one DIMM module installed. If the system boots, check for bad DIMM modules or slots by following the Memory Errors Troubleshooting procedure in this chapter.

## Memory Errors

When a no-memory beep code is issued by the system, check the following:

1. Make sure that the memory modules are compatible with the system and are properly installed. See Chapter 2 for installation instructions. (For memory compatibility, refer to the "Tested Memory List" link on the motherboard's product page to see a list of supported memory.)
2. Check if different speeds of DIMMs have been installed. It is strongly recommended that you use the same RAM type and speed for all DIMMs in the system.
3. Make sure that you are using the correct type of ECC DDR4 modules recommended by the manufacturer.

4. Check for bad DIMM modules or slots by swapping a single module among all memory slots and check the results.

## Losing the System's Setup Configuration

1. Make sure that you are using a high-quality power supply. A poor-quality power supply may cause the system to lose the CMOS setup information. Refer to Chapter 2 for details on recommended power supplies.
2. The battery on your motherboard may be old. Check to verify that it still supplies approximately 3 VDC. If it does not, replace it with a new one.
3. If the above steps do not fix the setup configuration problem, contact your vendor for repairs.

## When the System Becomes Unstable

**A. If the system becomes unstable during or after OS installation, check the following:**

1. CPU/BIOS support: Make sure that your CPU is supported and that you have the latest BIOS installed in your system.
2. Memory support: Make sure that the memory modules are supported by testing the modules using memtest86 or a similar utility.



**Note:** Click on the "Tested Memory List" link on the motherboard's product page to see a list of supported memory.

3. HDD support: Make sure that all hard disk drives (HDDs) work properly. Replace the bad HDDs with good ones.
4. System cooling: Check the system cooling to make sure that all heatsink fans and CPU/system fans, etc., work properly. Check the hardware monitoring settings in the IPMI to make sure that the CPU and system temperatures are within the normal range. Also check the front panel Overheat LED and make sure that it is not on.
5. Adequate power supply: Make sure that the power supply provides adequate power to the system. Make sure that all power connectors are connected. Please refer to our website for more information on the minimum power requirements.
6. Proper software support: Make sure that the correct drivers are used.

***B. If the system becomes unstable before or during OS installation, check the following:***

1. Source of installation: Make sure that the devices used for installation are working properly, including boot devices such as a USB flash or media drive.
2. Cable connection: Check to make sure that all cables are connected and working properly.
3. Use the minimum configuration for troubleshooting: Remove all unnecessary components (starting with add-on cards first), and use the minimum configuration (but with the CPU and a memory module installed) to identify the trouble areas. Refer to the steps listed in Section A above for proper troubleshooting procedures.
4. Identify bad components by isolating them: If necessary, remove a component in question from the chassis, and test it in isolation to make sure that it works properly. Replace a bad component with a good one.
5. Check and change one component at a time instead of changing several items at the same time. This will help isolate and identify the problem.
6. To find out if a component is good, swap this component with a new one to see if the system will work properly. If so, then the old component is bad. You can also install the component in question in another system. If the new system works, the component is good and the old system has problems.

## 3.2 Technical Support Procedures

Before contacting Technical Support, please take the following steps. Also, please note that as a motherboard manufacturer, Supermicro also sells motherboards through its channels, so it is best to first check with your distributor or reseller for troubleshooting services. They should know of any possible problems with the specific system configuration that was sold to you.

1. Please go through the Troubleshooting Procedures and Frequently Asked Questions (FAQ) sections in this chapter or see the FAQs on our website (<http://www.supermicro.com/FAQ/index.php>) before contacting Technical Support.
2. BIOS upgrades can be downloaded from our website ([http://www.supermicro.com/ResourceApps/BIOS\\_IPMI\\_Intel.html](http://www.supermicro.com/ResourceApps/BIOS_IPMI_Intel.html)).
3. If you still cannot resolve the problem, include the following information when contacting Supermicro for technical support:
  - Motherboard model and PCB revision number
  - BIOS release date/version (This can be seen on the initial display when your system first boots up.)
  - System configuration
4. An example of a Technical Support form is on our website at <http://www.supermicro.com/RmaForm/>.
5. Distributors: For immediate assistance, please have your account number ready when placing a call to our Technical Support department. We can be reached by email at [support@supermicro.com](mailto:support@supermicro.com).

## 3.3 Frequently Asked Questions

**Question: What type of memory does my motherboard support?**

**Answer:** The motherboard supports ECC (-F/TLN4F) and Non-ECC (-F/QF/TLN4F) DDR4 UDIMM modules. To enhance memory performance, do not mix memory modules of different speeds and sizes. Please follow all memory installation instructions given on Section 2.4 in Chapter 2.

**Question: How do I update my BIOS?**

**Answer:** It is recommended that you do not upgrade your BIOS if you are not experiencing any problems with your system. Updated BIOS files are located on our website at [http://www.supermicro.com/ResourceApps/BIOS\\_IPMI\\_Intel.html](http://www.supermicro.com/ResourceApps/BIOS_IPMI_Intel.html). Please check our BIOS warning message and the information on how to update your BIOS on our website. Select your motherboard model and download the BIOS file to your computer. Also, check the current BIOS revision to make sure that it is newer than your BIOS before downloading. Please unzip the BIOS file onto a bootable USB device. Run the batch file using the format FLASH.BAT filename.rom from your bootable USB device to flash the BIOS. Then, your system will automatically reboot.

**Warning:** Do not shut down or reset the system while updating the BIOS to prevent possible system boot failure!



**Note:** The SPI BIOS chip used on this motherboard cannot be removed. Send your motherboard back to our RMA Department at Supermicro for repair. For BIOS Recovery instructions, please refer to the AMI BIOS Recovery Instructions posted at <http://www.supermicro.com/support/manuals/>.



## 3.4 Battery Removal and Installation

### Battery Removal

To remove the onboard battery, follow the steps below:

1. Power off your system and unplug your power cable.
2. Locate the onboard battery as shown below.
3. Using a tool such as a pen or a small screwdriver, push the battery lock outwards to unlock it. Once unlocked, the battery will pop out from the holder.
4. Remove the battery.

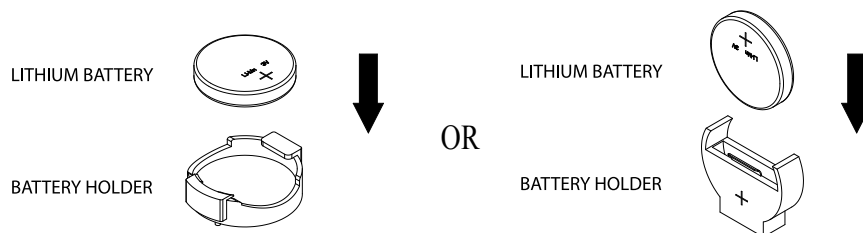
### Proper Battery Disposal

**Warning:** Please handle used batteries carefully. Do not damage the battery in any way; a damaged battery may release hazardous materials into the environment. Do not discard a used battery in the garbage or a public landfill. Please comply with the regulations set up by your local hazardous waste management agency to dispose of your used battery properly.

### Battery Installation

1. To install an onboard battery, follow steps 1 and 2 above and continue below:
2. Identify the battery's polarity. The positive (+) side should be facing up.
3. Insert the battery into the battery holder and push it down until you hear a click to ensure that the battery is securely locked.

**Warning:** When replacing a battery, be sure to only replace it with the same type.



### 3.5 Returning Merchandise for Service

A receipt or copy of your invoice marked with the date of purchase is required before any warranty service will be rendered. You can obtain service by calling your vendor for a Returned Merchandise Authorization (RMA) number. When returning the motherboard to the manufacturer, the RMA number should be prominently displayed on the outside of the shipping carton, and the shipping package is mailed prepaid or hand-carried. Shipping and handling charges will be applied for all orders that must be mailed when service is complete. For faster service, you can also request a RMA authorization online (<http://www.supermicro.com/RmaForm/>).

This warranty only covers normal consumer use and does not cover damages incurred in shipping or from failure due to the alternation, misuse, abuse or improper maintenance of products.

During the warranty period, contact your distributor first for any product problems.

# Chapter 4

## UEFI BIOS

### 4.1 Introduction

This chapter describes the AMIBIOS™ Setup utility for the motherboard. The BIOS is stored on a chip and can be easily upgraded using a flash program.



**Note:** Due to periodic changes to the BIOS, some settings may have been added or deleted and might not yet be recorded in this manual. Please refer to the Manual Download area of our website for any changes to the BIOS that may not be reflected in this manual.

#### Starting the Setup Utility

To enter the BIOS Setup Utility, hit the <Delete> key while the system is booting up. (In most cases, the <Delete> key is used to invoke the BIOS setup screen. There are a few cases when other keys are used, such as <F1>, <F2>, etc.) Each main BIOS menu option is described in this manual.

The Main BIOS screen has two main frames. The left frame displays all the options that can be configured. “Grayed-out” options cannot be configured. The right frame displays the key legend. Above the key legend is an area reserved for a text message. When an option is selected in the left frame, it is highlighted in white. Often a text message will accompany it. (Note that the BIOS has default text messages built in. We retain the option to include, omit, or change any of these text messages.) Settings printed in **Bold** are the default values.

A " ►" indicates a submenu. Highlighting such an item and pressing the <Enter> key will open the list of settings within that submenu.

The BIOS setup utility uses a key-based navigation system called hot keys. Most of these hot keys (<F1>, <F2>, <F3>, <Enter>, <ESC>, <Arrow> keys, etc.) can be used at any time during the setup navigation process.


## 4.2 Main Setup

When you first enter the AMI BIOS setup utility, you will enter the Main setup screen. You can always return to the Main setup screen by selecting the Main tab on the top of the screen. The Main BIOS setup screen is shown below and the following items will be displayed:



### System Date/System Time

Use this option to change the system date and time. Highlight *System Date* or *System Time* using the arrow keys. Enter new values using the keyboard. Press the <Tab> key or the arrow keys to move between fields. The date must be entered in MM/DD/YYYY format. The time is entered in HH:MM:SS format.

 **Note:** The time is in the 24-hour format. For example, 5:30 P.M. appears as 17:30:00. The date's default value is the BIOS build date after RTC reset.

### Supermicro X12SCZ

#### BIOS Version

This item displays the version of the BIOS ROM used in the system.

#### Build Date

This item displays the date when the version of the BIOS ROM used in the system was built.

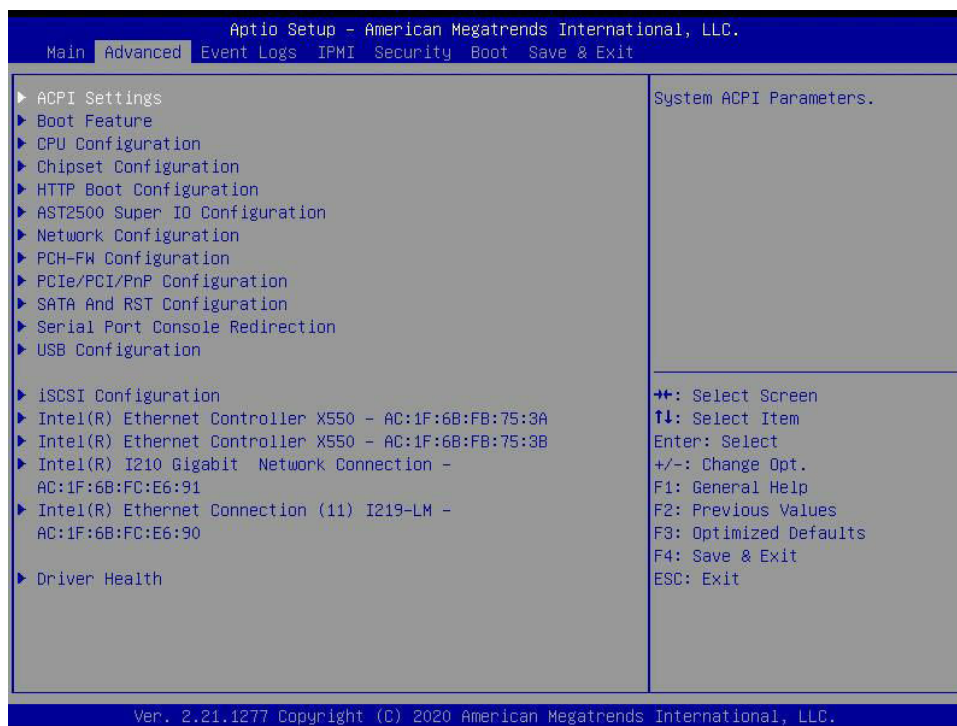
## **Memory Information**

### **Total Memory**

This item displays the total size of memory available in the system.

## 4.3 Advanced Setup Configurations

Use the arrow keys to select the Advanced menu and press <Enter> to access the menu items.



**Warning:** Take caution when changing the Advanced settings. An incorrect value, a very high DRAM frequency, or an incorrect DRAM timing setting may make the system unstable. When this occurs, revert to default manufacturer settings.

### ▶ ACPI Settings

#### ACPI Sleep State

Use this feature to select the ACPI Sleep State that the system will enter into when the suspend button is activated. The options are Suspend Disabled and **S3 (Suspend to RAM)**.

#### WHEA Support

Select Enabled to support the Windows Hardware Error Architecture (WHEA) platform and provide a common infrastructure for the system to handle hardware errors within the Windows OS environment to reduce system crashes and to enhance system recovery and health monitoring. The options are Disabled and **Enabled**.

### High Precision Event Timer

Select Enabled to activate the High Precision Event Timer (HPET) that produces periodic interrupts at a much higher frequency than a Real-time Clock (RTC) does in synchronizing multimedia streams, providing smooth playback and reducing the dependency on other timestamp calculation devices, such as an x86 RDTSC Instruction embedded in the CPU. The High Performance Event Timer is used to replace the 8254 Programmable Interval Timer. The options are Disabled and **Enabled**.

### Native PCIE Enable

Enable this feature to grant control of PCI Express Native hot plug, PCI Express Power Management Events, and PCI Express Capability Structure Control. The options are Disabled and **Enabled**.

### Native ASPM

Select Enabled for the operating system to control the ASPM, or Disabled for the BIOS to control the ASPM. The options are Auto, Enabled, and **Disabled**.

## ► Boot Feature

### Fast Boot

Enable this feature to reduce the time the computer takes to boot up. The computer will boot with a minimal set of required devices. This feature does not have an effect on BBS boot options in the Boot tab. The options are **Disabled** and Enabled.

### Quiet Boot

Use this feature to select the screen display between the POST messages and the OEM logo upon bootup. Select Disabled to display the POST messages. Select Enabled to display the OEM logo instead of the normal POST messages. The options are Disabled and **Enabled**.

### Option ROM Messages

Use this feature to set the display mode for the Option ROM. Select Keep Current to display the current AddOn ROM setting. Select Force BIOS to use the Option ROM display set by the system BIOS. The options are **Force BIOS** and Keep Current.

### Bootup NumLock State

Use this feature to set the Power-on state for the <Numlock> key. The options are **On** and Off.

### Wait For "F1" If Error

Use this feature to force the system to wait until the "F1" key is pressed if an error occurs. The options are Disabled and **Enabled**.

### **Re-try Boot**

If this feature is enabled, the BIOS will automatically reboot the system from a specified boot device after its initial boot failure. The options are **Disabled**, Legacy Boot, and EFI Boot.

### **Power Configuration**

#### **Watch Dog Function**

If enabled, the Watch Dog Timer will allow the system to reset or generate NMI based on jumper settings when it is expired for more than five minutes. The options are **Disabled** and Enabled.

#### **Restore on AC Power Loss**

Use this feature to set the power state after a power outage. Select Stay Off for the system power to remain off after a power loss. Select Power On for the system power to be turned on after a power loss. Select Last State to allow the system to resume its last power state before a power loss. The options are Stay Off, Power On, and **Last State**.

#### **Power Button Function**

This feature controls how the system shuts down when the power button is pressed. Select 4 Seconds Override for you to power off the system after pressing and holding the power button for four seconds or longer. Select Instant Off to instantly power off the system as soon as you press the power button. The options are **Instant Off** and 4 Seconds Override.

## **►Connectivity Configuration**

This submenu becomes configurable when a CNVi device is plugged into the motherboard.

### **CNVi present**

This feature displays the status of wireless connections.

### **CNVi Configuration**

#### **CNVi WiFi&BT**

Use this feature to enable CNVi WiFi and Bluetooth support. The options are Disabled and **Enabled**.

## **►CPU Configuration**

The following CPU information will display:

- CPU Signature
- Microcode Patch



- Max CPU Speed
- Min CPU Speed
- CPU Speed
- Processor Cores
- Hyper Threading Technology
- VMX
- SMX/TXT
- 64-bit
- EIST Technology
- CPU C3 state
- CPU C6 state
- CPU C7 state
- CPU C8 state
- CPU C9 state
- CPU C10 state
- L1 Data Cache
- L1 Instruction Cache
- L2 Cache
- L3 Cache
- L4 Cache

**C6DRAM (Available when supported by the CPU)**

This feature enables moving DRAM contents to PRM memory when the CPU is in a C6 state. The options are Disabled and **Enabled**.

### **Hardware Prefetcher**

If set to Enable, the hardware prefetcher will prefetch streams of data and instructions from the main memory to the L2 cache to improve CPU performance. The options are Disable and **Enable**.

### **Adjacent Cache Prefetch**

The CPU prefetches the cache line for 64 bytes if this feature is set to Disabled. The CPU prefetches both cache lines for 128 bytes as comprised if this feature is set to Enable. The options are **Enable** and Disable.

### **Intel (VMX) Virtualization Technology (Available when supported by the CPU)**

Use this feature to enable the Vanderpool Technology. This technology allows the system to run several operating systems simultaneously. The options are Disabled and **Enabled**.

### **Active Processor Cores**

This feature determines how many CPU cores will be activated for each CPU. When all is selected, all cores in the CPU will be activated. The options are **All** and 1, 2, 3, 4, and 5.

### **Hyper-Threading (Available when supported by the CPU)**

Select Enable to support Intel Hyper-threading Technology to enhance CPU performance. The options are Disable and **Enable**.

### **AES (Available when supported by the CPU)**

Select Enabled for Intel CPU Advanced Encryption Standard (AES) instructions support to enhance data integrity. The options are Disabled and **Enabled**.

### **Boot Performance Mode**

This feature allows you to select the performance state that the BIOS will set before the operating system handoff. The options are Power Saving, **Max Non-Turbo Performance**, and Turbo Performance.

### **Intel® SpeedStep™C (Available when supported by the CPU)**

Intel SpeedStep Technology allows the system to automatically adjust processor voltage and core frequency to reduce power consumption and heat dissipation. The options are Disabled and **Enabled**.

### **Intel® Speed Shift Technology**

Use this feature to enable or disable Intel Speed Shift Technology support. When this feature is enabled, the Collaborative Processor Performance Control (CPPC) version 2 interface will be available to control CPU P-States. The options are Disabled and **Enabled**.

**Turbo Mode (Available when supported by the CPU)**

Select Enable for processor cores to run faster than the frequency specified by the manufacturer. The options are Disable and **Enable**.

**Power Limit 1 Override (Available when supported by the CPU)**

Use this feature to enable or disable Power Limit 1 override. The options are **Disabled** and Enabled.

**Power Limit 1**

Use this feature to set the power limit 1, in milliwatts. When the limit is exceeded, the CPU ratio is lowered after a period of time (see Power Limit 1 Time Window below). A lower limit can save power and protect the CPU, while a higher limit improves performance. This value must be between Min Power Limit TDP limit. Use the number keys on your keyboard to enter the value. The default setting is **0**.

**Power Limit 1 Time Window**

This feature determines how long the time window over which the TDP value is maintained. Use the number keys on your keyboard to enter the value. The default setting is **0**. This value may vary between 0 and 128.

**Power Limit 2 Override (Available when supported by the CPU)**

Use this feature to enable or disable Power Limit 2 override. The options are Disabled and **Enabled**.

**Power Limit 2**

Use this feature to set the power limit 2. Use the number keys on your keyboard to enter the value. The default setting is **0**.

**C-States**

Use this feature to enable the C-State of the CPU. The options are Disabled and **Enabled**.

**Enhanced C-states**

Use this feature to enable the enhanced C-State of the CPU. The options are Disabled and **Enabled**.

**C-State Auto Demotion**

Use this feature to prevent unnecessary excursions into the C-states to improve latency. The options are Disabled, C1, C3, and **C1 and C3**.

**C-State Un-Demotion**

This feature allows you to enable or disable the un-demotion of C-State. The options are Disabled, C1, C3, and **C1 and C3**.

### **Package C-State Demotion**

Use this feature to enable or disable the Package C-State demotion. The options are **Disabled** and **Enabled**.

### **Package C-State Un-Demotion**

Use this feature to enable or disable the Package C-State un-demotion. The options are **Disabled** and **Enabled**.

### **CState Pre-Wake**

This feature allows you to enable or disable the C-State Pre-Wake. The options are **Disabled** and **Enabled**.

### **Package C State Limit**

Use this feature to set the Package C-State limit. The options are C0/C1, C2, C3, C6, C7, C7s, C8, C9, Cpu Default, and **Auto**.

## **► Chipset Configuration**

**Warning:** Setting the wrong values in the following features may cause the system to malfunction.

### **► System Agent (SA) Configuration**

The following information will display:

- SA PCIe Code Version: 7.0.53.66
- VT-d: Supported

### **► Memory Configuration**

#### **Memory Configuration**

- Memory RC Version
- Memory Frequency
- Memory Timing (tCL-tRCD-tRP-tRAS)
- DIMMA1
- DIMMA2
- DIMMB1
- DIMMB2

### Maximum Memory Frequency

Use this feature to set the maximum memory frequency for onboard memory modules. The options are **Auto**, 1067, 1200, 1333, 1400, 1600, 1800, 1867, 2000, 2133, 2200, 2400, 2600, 2667, 2800, and 2933.

### Max TOLUD

This feature sets the maximum TOLUD value, which specifies the "Top of Low Usable DRAM" memory space to be used by internal graphics devices, GTT Stolen Memory, and TSEG, respectively, if these devices are enabled. The options are **Dynamic**, 1 GB, 1.25 GB, 1.5 GB, 1.75 GB, 2 GB, 2.25 GB, 2.5 GB, 2.75 GB, 3 GB, 3.25 GB, and 3.5 GB.

### Memory Scrambler

Use this feature to enable or disable memory scrambler support. The options are Disabled and **Enabled**.

### Force ColdReset

Use this feature to enable or disable a cold boot during a MRC execution. The options are Enabled and **Disabled**.

### Force Single Rank

Select enabled to use only Rank 0 in each DIMM. The options are **Disabled** and Enabled.

### Memory Remap

Use this feature to enable or disable memory remap above 4GB. The options are **Enabled** and Disabled.

### MRC Fast Boot

Use this feature to enable or disable fast path through the memory reference code. The options are Disabled and **Enabled**.

## ▶ Graphics Configuration

### Graphics Configuration

- IGFX VBIOS Version
- IGFX GOP Version

### Graphics Turbo IMON Current

Use this feature to set the graphics turbo IMON value. The default is **31**.

### **Skip Scanning of External Gfx Card**

If set to enabled, the system will not scan for an external graphics card on PEG and PCIe slots. The options are **Disabled** and Enabled.

### **Primary Display**

Use this feature to select the primary video display. The options are **Auto**, IGFX, PEG, and PCI.

### **Internal Graphics**

Select Auto to keep an internal graphics device installed on an expansion slot supported by the CPU to be automatically enabled. The options are **Auto**, Disable, and Enable.

### **GTT Size**

Use this feature to set the memory size to be used by the graphics translation table (GTT). The options are 2MB, 4MB, and **8MB**.

### **Aperture Size**

Use this feature to set the Aperture size, which is the size of system memory reserved by the BIOS for graphics device use. The options are 128MB, **256MB**, 512MB, 1024MB, and 2048MB.

### **DVMT Pre-Allocated**

Dynamic Video Memory Technology (DVMT) allows dynamic allocation of system memory to be used for video devices to ensure best use of available system memory based on the DVMT 5.0 platform. The options are 0M, **32M**, 64M, 4M, 8M, 12M, 16M, 20M, 24M, 28M, 32M/F7, 36M, 40M, 44M, 48M, 52M, 56M, and 60M.

### **DVMT Total Gfx Mem**

Use this feature to set the total memory size to be used by internal graphics devices based on the DVMT 5.0 platform. The options are 128MB, **256MB**, and MAX.

### **PM Support**

Enable this feature to activate Power Management BIOS support. The options are **Enable** and Disable.

### **PAVP Enable**

Protected Audio Video Path (PAVP) decodes Intel integrated graphics encrypted video. The options are Disable and **Enable**.

### **Cdynmax Clamping Enable**

Enable this feature to activate Cdynmax Clamping. The options are **Enable** and Disable.

### **Graphics Clock Frequency**

Use this feature to set the internal graphics clock frequency. The options are 337.5 Mhz, 450 Mhz, 540 Mhz, and **675 Mhz**.

### **Skip CD Clock Init in S3 resume**

Use this feature to enable skipping of the full CD initialization. If set to Disabled, the full CD clock will initialize. The options are Enabled and **Disabled**.

## **► DMI/OPI Configuration**

The following DMI information will display:

DMI: X4 Gen3

### **DMI Link ASPM Control**

Use this feature to set the ASPM (Active State Power Management) state on the SA (System Agent) side of the DMI Link. The options are Disable, L0s, L1, and **L0sL1**.

### **DMI Extended Sync Control**

Use this feature to enable or disable the DMI extended synchronization. The options are Enable and **Disable**.

## **► PEG Configuration**

### **CPU SLOT6 PCIe 3.0 X16**

#### **Enable Root Port**

Use this feature to enable or disable the PCI Express Graphics (PEG) device in the specified port. The options are Disable, Enable, and **Auto**.

#### **Max Link Speed**

Use this feature to select PCIe support for the device installed on SLOT7. The options are **Auto**, Gen 1, Gen 2, and Gen 3.

## **► GT - Power Management Control**

### **RC6 (Render Standby)**

Use this feature to enable render standby support. The options are Disabled and **Enabled**.

### Maximum GT frequency

Use this feature to define the Maximum GT frequency. Choose between 33MHz (RPN) and 1200MHz (RP0). Any value beyond this range will be clipped to its min/max supported by the CPU. The options are **Default Max Frequency**, 100MHz, 150MHz, 200MHz, 250MHz, 300MHz, 350MHz, 400MHz, 450MHz, 500MHz, 550MHz, 600MHz, 650MHz, 700MHz, 750MHz, 800MHz, 8520MHz, 900MHz, 950MHz, 1000MHz, 1050MHz, 1100MHz, 1150MHz, and 1200MHz.

### Disable Turbo GT frequency

Use this feature to disable Turbo GT frequency. If set to Enabled, Turbo GT frequency becomes disabled. If set to Disabled, GT frequency limiters will be removed. The options are Enabled and **Disabled**.

### VT-d

Select Enabled to activate Intel Virtualization Technology support for Direct I/O VT-d by reporting the I/O device assignments to VMM through the DMAR ACPI Tables. This feature offers fully-protected I/O resource-sharing across the Intel platforms, providing you with greater reliability, security and availability in networking and data-sharing. The options are Disabled and **Enabled**.

### SW Guard Extensions (SGX)

Select Enabled to activate the Software Guard Extensions (SGX). The options are Disabled, Enabled, and **Software Controlled**.

### GNA Device (B0:D8:F0)

Use this feature to enable SA GNA device. The options are **Enabled** and Disabled.

***\*If the feature SGX is set to Enabled, the following features below will be available for configuration:***

### Select Owner EPOCH Input Type

There are three Owner EPOCH modes (each EPOCH is 64 bit). The options are **No Change in Owner EPOCHs**, Change to New Random Owner EPOCH, and Manual User Defined Owner EPOCHs.

***\*If the feature Select Owner EPOCH Input Type is set to Manual User Defined Owner EPOCHs, the following features below will be available for configuration:***

### Software Guard Extensions Epoch 0

Enter a numeric value for this feature. The default is **0**.

### Software Guard Extensions Epoch 1

Enter a numeric value for this feature. The default is **0**.



## PRMRR Size

The BIOS must reserve a contiguous region of Processor Reserved Memory (PRM) in the Processor Reserved Memory Range Register (PRMRR). The options are 32MB, 64MB, and **128MB**.

## ► PCH-IO Configuration

### PCH-IO Configuration

- PCH SKU Name
- Stepping

## ► PCI Express Configuration

### DMI Link ASPM Control

Use this feature to set the ASPM (Active State Power Management) state on the SA (System Agent) side of the DMI Link. The options are Disabled, L0s, L1, L0sL1, and **Auto**.

### Peer Memory Write Enable

Use this feature to enable or disable peer memory write. The options are **Disabled** and Enabled.

- PCH SLOT4 PCIe 3.0 X4 (IN X8)
- PCIe M.2-E1
- PCH SLOT7 PCIe 3.0 X4
- PCIe M.2-M1

### ASPM

Use this feature to activate the Active State Power Management (ASPM) level for a PCIe device. Select Auto for the system BIOS to automatically set the ASPM level based on the system configuration. Select Disabled to disable ASPM support. The options are Disabled, L0s, L1, L0sL1, and **Auto**.

### L1 Substates

Use this feature to set the PCI Express L1 Substates. The options are Disabled, L1.1, and **L1.1 & L1.2**.

### PCIe Speed

Use this feature to select the PCI Express port speed. The options are **Auto**, Gen1, Gen2, and Gen3.

## PCIe PLL SSC

Use this feature to enable or disable PCIe PLL SSC. The options are **Disabled** and Enabled.

## ▶HDD Security Configuration

### HDD Security Configuration

The following HDD information will display:

**P0**

**Security Supported**

**Security Enabled**

**Security Locked**

**Security Frozen**

**HDD User Pwd Status**

**HDD Master Pwd Status**

**Set User Password**

Press Enter to create a new, or change an existing HDD password.

## ▶HTTP Boot Configuration

### HTTP BOOT Configuration

#### HTTP Boot One Time

Use this feature to create the HTTP boot option. The options are **Disabled** and Enabled.

#### Input The Description

Highlight the feature and press enter to create a description.

#### Boot URI

Highlight the feature and press enter to create a boot URI.

## ▶AST2500 Super IO Configuration

The following Super IO information will display:

- Super IO Chip AST2500

## ► Serial Port 1 Configuration

### Serial Port 1

Select Enabled to enable the selected onboard serial port. The options are Disabled and Enabled.

### Device Settings

This feature displays the status of the serial port.

### Change Settings

This feature specifies the base I/O port address and the Interrupt Request address of the specified serial port. Select Auto to allow the BIOS to automatically assign the base I/O and IRQ address. The options are **Auto**, (IO=3F8h; IRQ=4;), (IO=2F8h; IRQ=4;), (IO=3E8h; IRQ=4;), and (IO=2E8h; IRQ=4;).

## ► Serial Port 2 Configuration

### Serial Port 2

Select Enabled to enable the selected onboard serial port. The options are Disabled and Enabled.

### Device Settings

This feature displays the status of the serial port.

### Change Settings

This feature specifies the base I/O port address and the Interrupt Request address of the specified serial port. Select Auto to allow the BIOS to automatically assign the base I/O and IRQ address. The options are **Auto**, (IO=3F8h; IRQ=3;), (IO=2F8h; IRQ=3;), (IO=3E8h; IRQ=3;), and (IO=2E8h; IRQ=3;).

### Serial Port 2 Attribute (Available for Serial Port 2 only)

Select SOL to use COM Port 2 as a Serial Over LAN (SOL) port for console redirection. The options are **SOL** and COM.

## ► Network Configuration

### ► MAC:XXXXXXXXXX-IPv4 Network Configuration

#### Configured

This feature indicates whether a network address is configured successfully or not. The default is **Unchecked**.

***\*If the feature above is set to Checked, the following features below will be available for configuration:***

**Enable DHCP**

Use this feature to set the DHCP. The default is **Unchecked**.

***\*If the feature above is set to Unchecked, the following features below will be available for configuration:***

**Local IP Address**

Enter an IP address in dotted decimal notation.

**Local Netmask**

Enter a NetMask address in dotted decimal notation.

**Local Gateway**

Enter a Gateway in dotted decimal notation.

**Local DNS Servers**

Enter a DNS server in dotted decimal notation.

**Save Changes and Exit**

Select this feature to save changes you have made and return to the upper configuration page.

**▶ MAC:XXXXXXXXXX-HTTP Boot Configuration**

This submenu is available for configuration when IPv4 HTTP Support and IPv6 HTTP Support are set to Enabled.

**Input the description**

This feature is an input field that, when the HTTP boot option is created, can be used to enter text to describe or identify the HTTP connection.

**Internet Protocol**

Select the version of Internet Protocol. The options are subject to change depending on the features enabled in IPv4 HTTP Support and IPv6 HTTP Support.

**Boot URI**

This feature is an input field used to enter a web or network address to point to the HTTP boot files. This supports the HTTP or HTTPS protocols only.

---

---

## ▶ **MAC:XXXXXXXXXX-IPv6 Network Configuration**

The following information is displayed:

**Interface Name**

**Interface Type**

**MAC Address**

**Host Addresses**

**Route Table**

**Gateway addresses**

**DNS addresses**

**Interface ID**

Enter an ID for the device.

**DAD Transmit Count**

Enter a value for Duplicate Address Detection (DAD) Transmit Count. A value of zero indicates the DAD is not performed. The default is **1**.

**Policy**

Use this feature to set the Policy. The options are **Automatic** and Manual.

***\*If the feature above is set to Manual, the following features below will be available for configuration:***

**Advanced Configuration**

**New IPv6 Addresses**

Enter a new IPv6 Gateway address.

**New DNS Addresses**

Enter a new DNS address.

**Commit Changes and Exit**

Select this feature to save the changes you have made and return to the upper configuration page.

**Saves Changes and Exit**

Select this feature to save the changes you have made and return to the upper configuration page.

## ► Enter Configuration Menu

**Interface Name**

**Interface Type**

**MAC address**

**Host addresses**

**Route Table**

**Gateway addresses**

**DNS addresses**

**Interface ID**

This feature shows the interface ID for the specified network device.

**DAD Transmit Count**

This feature sends Neighbor Solicitation messages while performing a Duplicate Address Detection (DAD) to make sure there is no IP address duplication. A value of zero means a DAD has not been performed.

**Policy**

Use this feature to select an automatic or manual policy. The options are **Automatic** and **Manual**.

**Save Changes And Exit**

When you have completed the changes for this section, select this option to save all changes made and exit.

## ► PCH-FW Configuration

**ME Firmware Version: 14**

**ME Firmware Mode: Normal Mode**

**ME Firmware SKU: Corporate SKU**

**ME FW Image Re-Flash**

Use this feature to update the Management Engine firmware. The options are **Disabled** and **Enabled**.

## ▶ AMT Configuration

### USB Provisioning of AMT

Use this feature to enable or disable USB provisioning. The options are **Disabled** and Enabled.

## ▶ CIRCA Configuration

### Activate Remote Assistance Process

Use this feature to activate Remote Assistance. Enabling this feature will also trigger the CIRCA boot. The options are **Disabled** and Enabled.

*\*If the feature above is set to Enabled, the feature below will be available for configuration:*

### CIRCA Timeout

Use this feature to set the timeout value for MPS connection. Use 0 for the default timeout value of 60 seconds.

## ▶ ASF Configuration

### PET Progress

Use this feature to enable or disable PET Events Progress to receive PET Events alerts. The options are Disabled and **Enabled**.

### WatchDog

Select Enabled to allow AMT to reset or power down the system if the operating system or BIOS hangs or crashes. The options are **Disabled** and Enabled.

### OS Timer / BIOS Timer

These options appear if Watch Dog (above) is enabled. This is a timed delay in seconds, before a system power down or reset after a BIOS or operating system failure is detected. Enter the value in seconds.

### ASF Sensors Table

Enable this feature for the ASF Sensor Table to be added into the ASF! ACPI table. The options are **Disabled** and Enabled.

## ▶ Secure Erase Configuration

### Secure Erase mode

Select Real to securely erase a solid state drive. The options are **Simulated** and Real.

### **Force Secure Erase**

Select Enabled to force a secure erase of the solid state drive on the next boot. The options are **Disabled** and Enabled.

## **► OEM Flags Settings**

### **MEBx hotkey Pressed**

Use this feature to specify whether the MEBx hotkey should be enabled during the system boot. The options are **Disabled** and Enabled.

### **MEBx Selection Screen**

Use this feature to select the type of MEBx selection screen. Press 1 to enter the ME Configuration screen and 2 to initiate a remote connection. Network access must be activated for a remote connection. The options are **Disabled** and Enabled.

### **Hide Unconfigure ME Confirmation Prompt**

Use this feature to hide the unconfigure ME confirmation prompt. The options are **Disabled** and Enabled.

### **MEBx OEM Debug Menu Enable**

Use this feature to enable or disable the OEM debug menu in MEBx. The options are **Disabled** and Enabled.

### **Unconfigure ME**

Use this feature to reset the MEBx password to default. The options are **Disabled** and Enabled.

## **► MEBx Resolution Settings**

### **Non-UI Mode Resolution**

Use this feature to specify the resolution for the non-UI text mode. The options are **Auto**, 80x25, and 100x31.

### **UI Mode Resolution**

Use this feature to specify the resolution for the UI text mode. The options are **Auto**, 80x25, and 100x31.

### **Graphics Mode Resolution**

Use this feature to specify the resolution for the graphics mode. The options are **Auto**, 640x480, 800x600, and 1024x768.



## ► PCIe/PCI/PnP Configuration

### Option ROM execution

#### Video

Use this feature to select the execution of the video OpROM. The options are Do not launch and **EFI**. The Legacy option is hidden when the Boot mode is EFI. The EFI option is hidden when the Boot mode is Legacy.

#### PCI PERR/SERR Support

Use this feature to enable or disable the runtime event for PCI errors. The options are **Disabled** and Enabled.

#### Above 4GB MMIO BIOS Assignment

Select Enable for remapping of BIOS above 4GB. The options are Enabled and **Disabled**.

#### SR-IOV Support

Use this feature to enable or disable Single Root IO Virtualization Support. The options are **Disabled** and Enabled.

#### BME DMA Mitigation

Enable this feature to help block DMA attacks. The options are Enabled and **Disabled**.

#### Onboard Video Option ROM

Use this feature to select which firmware function to be loaded for LAN1 used for system boot. The options are Disabled, Legacy, and **EFI**. The Legacy option is hidden when the Boot mode is EFI. The EFI option is hidden when the Boot mode is Legacy.

#### NVMe Firmware Source

The feature determines which type of NVMe firmware should be used in your system. The options are **Vendor Defined Firmware** and AMI Native Support.

#### Consistent Device Name Support

This feature controls the device naming for network devices and slots. The options are **Disabled** and Enabled.

#### PCIe/PCI/PnP Configuration

##### PCH SLOT4 PCIe 3.0 X4 (IN X8) OPROM

Use this feature to select which firmware type to be loaded for the add-on card in this slot. The options are Disabled, Legacy, and **EFI**. The Legacy option is hidden when the Boot mode is EFI. The EFI option is hidden when the Boot mode is Legacy.

### **CPU SLOT6 PCIe 3.0 X16 OPROM**

Use this feature to select which firmware type to be loaded for the add-on card in this slot. The options are Disabled, Legacy, and **EFI**. The Legacy option is hidden when the Boot mode is EFI. The EFI option is hidden when the Boot mode is Legacy.

### **PCH SLOT7 PCIe 3.0 X4 OPROM**

Use this feature to select which firmware type to be loaded for the add-on card in this slot. The options are Disabled, Legacy, and **EFI**. The Legacy option is hidden when the Boot mode is EFI. The EFI option is hidden when the Boot mode is Legacy.

### **PCIe M.2-M1 OPROM**

Use this feature to select which firmware type to be loaded for the add-on card in this slot. The options are Disabled, Legacy, and **EFI**. The Legacy option is hidden when the Boot mode is EFI. The EFI option is hidden when the Boot mode is Legacy.

### **PCIe M.2-E1 OPROM**

Use this feature to select which firmware type to be loaded for the add-on card in this slot. The options are Disabled, Legacy, and **EFI**. The Legacy option is hidden when the Boot mode is EFI. The EFI option is hidden when the Boot mode is Legacy.

### **Onboard LAN1 Option ROM**

Use this feature to select which firmware function to be loaded for LAN1 used for system boot. The options are Disabled, Legacy and **EFI**. The Legacy option is hidden when the Boot mode is EFI. The EFI option is hidden when the Boot mode is Legacy.

*\*These options are subject to change depending on the feature of Boot Mode Select.*

### **Onboard LAN2 Option ROM**

Use this feature to select a desired firmware function to be loaded for onboard LAN1. The options are Disabled, Legacy, and **EFI**. The Legacy option is hidden when the Boot mode is EFI. The EFI option is hidden when the Boot mode is Legacy.

### **Network Stack**

Select Enabled to enable Preboot Execution Environment(PXE) or Unified Extensible Firmware Interface (UEFI) for network stack support. The options are Disabled and **Enabled**.

#### **IPv4 PXE Support**

Select Enabled to enable IPv4 PXE boot support. The options are Disabled and **Enabled**.

#### **IPv4 HTTP Support**

Select Enabled to enable IPv4 HTTP boot support. The options are **Disabled** and Enabled.

#### **IPv6 PXE Support**

Select Enabled to enable IPv6 PXE boot support. The options are Disabled and **Enabled**.

### IPv6 HTTP Support

Select Enabled to enable IPv6 HTTP boot support. The options are **Disabled** and Enabled.

### PXE Boot Wait Time

Use this option to specify the wait time to press the ESC key to abort the PXE boot. Press "+" or "-" on your keyboard to change the value. The default setting is **0**.

### Media Detect Count

Use this option to specify the number of times media will be checked. Press "+" or "-" on your keyboard to change the value. The default setting is **1**.

## ▶ SATA And RST Configuration

### SATA Controller(s)

This feature enables or disables the onboard SATA controller supported by the Intel PCH chip. The options are **Enabled** and Disabled.

### SATA Mode Selection

Use this feature to select the SATA mode. The options are **AHCI** and Intel RST Premium With Intel Optane System Acceleration.

***\*If the feature above is set to Intel RST Premium With Intel Optane System Acceleration, the next four features will be available for configuration:***

### SATA Interrupt Selection

Use this feature to select the SATA interrupt. The options are Msix, **Msi**, and Legacy.

### PCIe M.2-M1

The feature shown here is dependent on the M.2 device plugged into the motherboard. This feature appears if an M.2 device is plugged in and RAID is selected in the SATA Mode Selection feature. Use this feature to enable or disable RST PCIe storage remapping. The options are RST Controlled and **Not RST Controlled**.

### RAID Device ID

Use this feature to select the RAID device ID. The options are **iRST Mode** and Alternate.

### Storage Option ROM/UEFI Driver

Select UEFI to load the EFI driver for system boot. Select Legacy to load a legacy driver for system boot. The options are Do not Launch, **EFI**, and Legacy.

### Teton Glacier Mode

Use this feature to enable or disable Intel Optane memory with solid state storage. The options are Dynamic Configuration for Hybrid Storage Device Enable and **Disabled**.

### **Aggressive LPM Support**

When this feature is set to Enable, the SATA AHCI controller manages the power usage of the SATA link. The controller will put the link in a low power mode during extended periods of I/O inactivity, and will return the link to an active state when I/O activity resumes. The options are Disabled and **Enabled**.

### **Serial ATA Port 0-3**

This feature displays the information detected on the installed SATA drive on the particular SATA port.

- Software Preserve Support

### **SATA Port 0-3 Hot Plug**

Set this feature to Enable for hot plug support, which will allow you to replace a SATA drive without shutting down the system. The options are Disabled and **Enabled**.

### **SATA Port 0-3 Spin Up Device**

Set this feature to enable or disable the PCH to initialize the device. The options are **Disabled** and Enabled.

### **SATA Port 0-3 SATA Device Type**

Use this feature to specify if the SATA port should be connected to a Solid State Drive or a Hard Disk Drive. The options are **Hard Disk Drive** and Solid State Drive.

## **► Serial Port Console Redirection**

### **COM1 Console Redirection**

Select Enabled to enable console redirection support for the serial port. The options are Enabled and **Disabled**.

***\*If the feature above is set to Enabled, the following features will be available for configuration:***

### **► COM1 Console Redirection Settings**

Use this feature to specify how the host computer will exchange data with the client computer, which is the remote computer.

### **COM1 Terminal Type**

This feature allows you to select the target terminal emulation type for Console Redirection. Select VT100 to use the ASCII Character set. Select VT100+ to add color and function key support. Select ANSI to use the Extended ASCII Character Set. Select VT-UTF8 to use UTF8 encoding to map Unicode characters into one or more bytes. The options are VT100, **VT100+**, VT-UTF8, and ANSI.

**COM1 Bits Per Second**

Use this feature to set the transmission speed for a serial port used in Console Redirection. Make sure that the same speed is used in the host computer and the client computer. A lower transmission speed may be required for long and busy lines. The options are 9600, 19200, 38400, 57600, and **115200** (bits per second).

**COM1 Data Bits**

Use this feature to set the data transmission size for Console Redirection. The options are 7 Bits and **8 Bits**.

**COM1 Parity**

A parity bit can be sent along with regular data bits to detect data transmission errors. Select Even if the parity bit is set to 0, and the number of 1's in data bits is even. Select Odd if the parity bit is set to 0, and the number of 1's in data bits is odd. Select None if you do not want to send a parity bit with your data bits in transmission. Select Mark to add a mark as a parity bit to be sent along with the data bits. Select Space to add a Space as a parity bit to be sent with your data bits. The options are **None**, Even, Odd, Mark, and Space.

**COM1 Stop Bits**

A stop bit indicates the end of a serial data packet. Select 1 Stop Bit for standard serial data communication. Select 2 Stop Bits if slower devices are used. The options are **1** and **2**.

**COM1 Flow Control**

Use this feature to set the flow control for Console Redirection to prevent data loss caused by buffer overflow. Send a "Stop" signal to stop sending data when the receiving buffer is full. Send a "Start" signal to start sending data when the receiving buffer is empty. The options are **None** and Hardware RTS/CTS.

**COM1 VT-UTF8 Combo Key Support**

Select Enabled to enable VT-UTF8 Combination Key support for ANSI/VT100 terminals. The options are Disabled and **Enabled**.

**COM1 Recorder Mode**

Select Enabled to capture the data displayed on a terminal and send it as text messages to a remote server. The options are **Disabled** and Enabled.

**COM1 Resolution 100x31**

Select Enabled for extended-terminal resolution support. The options are Disabled and **Enabled**.

### COM1 Putty KeyPad

This feature selects the settings for Function Keys and KeyPad used for Putty, which is a terminal emulator designed for the Windows OS. The options are **VT100**, LINUX, XTERMR6, SC0, ESCN, and VT400.

### COM1 Legacy OS Redirection Resolution

Use this feature to select the number of rows and columns used in Console Redirection for legacy OS support. The options are 80x24 and **80x25**.

### COM1 Redirection After BIOS POST

Use this feature to enable or disable legacy console redirection after BIOS POST. When set to Bootloader, legacy console redirection is disabled before booting the OS. When set to Always Enable, legacy console redirection remains enabled when booting the OS. The options are **Always Enable** and Bootloader.

### SOL/COM2 Console Redirection

Select Enabled to use the SOL port for Console Redirection. The options are Disabled and **Enabled**.

***\*If the feature above is set to Enabled, the following features will become available for configuration:***

#### ► SOL/COM2 Console Redirection Settings

Use this feature to specify how the host computer will exchange data with the client computer, which is the remote computer.

#### SOL/COM2 Terminal Type

Use this feature to select the target terminal emulation type for Console Redirection. Select VT100 to use the ASCII Character set. Select VT100+ to add color and function key support. Select ANSI to use the Extended ASCII Character Set. Select VT-UTF8 to use UTF8 encoding to map Unicode characters into one or more bytes. The options are VT100, **VT100+**, VT-UTF8, and ANSI.

#### SOL/COM2 Bits per second

Use this feature to set the transmission speed for a serial port used in Console Redirection. Make sure that the same speed is used in the host computer and the client computer. A lower transmission speed may be required for long and busy lines. The options are 9600, 19200, 38400, 57600, and **115200** (bits per second).

#### SOL/COM2 Data Bits

Use this feature to set the data transmission size for Console Redirection. The options are 7 Bits and **8 Bits**.

### **SOL/COM2 Parity**

A parity bit can be sent along with regular data bits to detect data transmission errors. Select Even if the parity bit is set to 0, and the number of 1's in data bits is even. Select Odd if the parity bit is set to 0, and the number of 1's in data bits is odd. Select None if you do not want to send a parity bit with your data bits in transmission. Select Mark to add a mark as a parity bit to be sent along with the data bits. Select Space to add a Space as a parity bit to be sent with your data bits. The options are **None**, Even, Odd, Mark, and Space.

### **SOL/COM2 Stop Bits**

A stop bit indicates the end of a serial data packet. Select 1 Stop Bit for standard serial data communication. Select 2 Stop Bits if slower devices are used. The options are **1** and **2**.

### **SOL/COM2 Flow Control**

Use this feature to set the flow control for Console Redirection to prevent data loss caused by buffer overflow. Send a "Stop" signal to stop sending data when the receiving buffer is full. Send a "Start" signal to start sending data when the receiving buffer is empty. The options are **None** and Hardware RTS/CTS.

### **SOL/COM2 VT-UTF8 Combo Key Support**

Select Enabled to enable VT-UTF8 Combination Key support for ANSI/VT100 terminals. The options are Disabled and **Enabled**.

### **SOL/COM2 Recorder Mode**

Select Enabled to capture the data displayed on a terminal and send it as text messages to a remote server. The options are **Disabled** and Enabled.

### **SOL/COM2 Resolution 100x31**

Select Enabled for extended-terminal resolution support. The options are Disabled and **Enabled**.

### **SOL/COM2 Legacy OS Redirection Resolution**

Use this feature to select the number of rows and columns used in Console Redirection for legacy OS support. The options are 80x24 and **80x25**.

### **SOL/COM2 Putty KeyPad**

This feature selects Function Keys and KeyPad settings for Putty, which is a terminal emulator designed for the Windows OS. The options are **VT100**, LINUX, XTERMR6, SCO, ESCN, and VT400.

### **SOL/COM2 Redirection After BIOS POST**

Use this feature to enable or disable legacy Console Redirection after BIOS POST. When set to Bootloader, legacy Console Redirection is disabled before booting the OS. When set to Always Enable, legacy Console Redirection remains enabled when booting the OS. The options are **Always Enable** and Bootloader.

## ▶ AMT SOL Console Redirection Settings

### AMT SOL Terminal Type

Use this feature to select the target terminal emulation type for Console Redirection. Select VT100 to use the ASCII Character set. Select VT100+ to add color and function key support. Select ANSI to use the Extended ASCII Character Set. Select VT-UTF8 to use UTF8 encoding to map Unicode characters into one or more bytes. The options are VT100, **VT100+**, VT-UTF8, and ANSI.

### AMT SOL Bits per second

Use this feature to set the transmission speed for a serial port used in Console Redirection. Make sure that the same speed is used in the host computer and the client computer. A lower transmission speed may be required for long and busy lines. The options are 9600, 19200, 38400, 57600, and **115200** (bits per second).

### AMT SOL Data Bits

Use this feature to set the data transmission size for Console Redirection. The options are 7 Bits and **8 Bits**.

### AMT SOL Parity

A parity bit can be sent along with regular data bits to detect data transmission errors. Select Even if the parity bit is set to 0, and the number of 1's in data bits is even. Select Odd if the parity bit is set to 0, and the number of 1's in data bits is odd. Select None if you do not want to send a parity bit with your data bits in transmission. Select Mark to add a mark as a parity bit to be sent along with the data bits. Select Space to add a Space as a parity bit to be sent with your data bits. The options are **None**, Even, Odd, Mark, and Space.

### AMT SOL Stop Bits

A stop bit indicates the end of a serial data packet. Select 1 Stop Bit for standard serial data communication. Select 2 Stop Bits if slower devices are used. The options are **1** and 2.

### AMT SOL Flow Control

Use this feature to set the flow control for Console Redirection to prevent data loss caused by buffer overflow. Send a "Stop" signal to stop sending data when the receiving buffer is full. Send a "Start" signal to start sending data when the receiving buffer is empty. The options are **None** and Hardware RTS/CTS.

### AMT SOL VT-UTF8 Combo Key Support

Select Enabled to enable VT-UTF8 Combination Key support for ANSI/VT100 terminals. The options are Disabled and **Enabled**.

### AMT SOL Recorder Mode

Select Enabled to capture the data displayed on a terminal and send it as text messages to a remote server. The options are **Disabled** and Enabled.



**AMT SOL Resolution 100x31**

Select Enabled for extended-terminal resolution support. The options are Disabled and **Enabled**.

**AMT SOL Putty KeyPad**

This feature selects Function Keys and KeyPad settings for Putty, which is a terminal emulator designed for the Windows OS. The options are **VT100**, LINUX, XTERMR6, SCO, ESCN, and VT400.

**AMT SOL Legacy OS Redirection Resolution**

Use this feature to select the number of rows and columns used in Console Redirection for legacy OS support. The options are 80x24 and **80x25**.

**AMT SOL Redirection After BIOS POST**

Use this feature to enable or disable legacy Console Redirection after BIOS POST. When set to Bootloader, legacy Console Redirection is disabled before booting the OS. When set to Always Enable, legacy Console Redirection remains enabled when booting the OS. The options are **Always Enable** and Bootloader.

**► Legacy Console Redirection Settings****Redirection COM Port**

Use this feature to select a COM port to display redirection of Legacy OS and Legacy OPRM messages. The options are **COM1**, SOL/COM2, and AMT SOL.

**EMS (Emergency Management Services) Console Redirection**

Select Enabled to use a COM port for EMS Console Redirection. The options are Enabled and **Disabled**.

***\*If the feature above is set to Enabled, the following features will become available for configuration:***

**► EMS Console Redirection Settings**

This feature allows you to specify how the host computer will exchange data with the client computer, which is the remote computer.

**Out-of-Band Mgmt Port**

The feature selects a serial port in a client server to be used by the Microsoft Windows Emergency Management Services (EMS) to communicate with a remote host server. The options are **COM1**, SOL/COM2, and AMT SOL.

### Terminal Type

Use this feature to select the target terminal emulation type for Console Redirection. Select VT100 to use the ASCII character set. Select VT100+ to add color and function key support. Select ANSI to use the extended ASCII character set. Select VT-UTF8 to use UTF8 encoding to map Unicode characters into one or more bytes. The options are VT100, VT100+, **VT-UTF8**, and ANSI.

### Bits Per Second

This feature sets the transmission speed for a serial port used in Console Redirection. Make sure that the same speed is used in the host computer and the client computer. A lower transmission speed may be required for long and busy lines. The options are 9600, 19200, 57600, and **115200** (bits per second).

### Flow Control

Use this feature to set the flow control for Console Redirection to prevent data loss caused by buffer overflow. Send a "Stop" signal to stop sending data when the receiving buffer is full. Send a "Start" signal to start sending data when the receiving buffer is empty. The options are **None**, Hardware RTS/CTS, and Software Xon/Xoff.

### Data Bits, Parity, Stop Bits

## ► Trusted Computing

The motherboard supports TPM 2.0. The following Trusted Platform Module (TPM) information will display if a TPM 2.0 module is detected:

- Vendor Name
- Firmware Version

### Security Device Support

If this feature and the TPM jumper on the motherboard are both set to Enabled, onboard security devices will be enabled for TPM (Trusted Platform Module) support to enhance data integrity and network security. Please reboot the system for a change on this setting to take effect. The options are Disable and **Enable**.

- Active PCR Bank
- Available PCR banks
- SHA256 PCR Bank

***\*If the feature above is set to Enable, "SHA-1 PCR Bank" and "SHA256 PCR Bank" will become available for configuration:***

**SHA-1 PCR Bank**

Use this feature to disable or enable the SHA-1 Platform Configuration Register (PCR) bank for the installed TPM device. The options are Disabled and **Enabled**.

**SHA256 PCR Bank**

Use this feature to disable or enable the SHA256 Platform Configuration Register (PCR) bank for the installed TPM device. The options are Disabled and **Enabled**.

**Pending Operation**

Use this feature to schedule a TPM-related operation to be performed by a security device for system data integrity. Your system will reboot to carry out a pending TPM operation. The options are **None** and TPM Clear.

**Platform Hierarchy**

Use this feature to disable or enable platform hierarchy for platform protection. The options are Disabled and **Enabled**.

**Storage Hierarchy**

Use this feature to disable or enable storage hierarchy for cryptographic protection. The options are Disabled and **Enabled**.

**Endorsement Hierarchy**

Use this feature to disable or enable endorsement hierarchy for privacy control. The options are Disabled and **Enabled**.

**TPM 20 Interface Type****PH Randomization**

Use this feature to disable or enable Platform Hierarchy (PH) Randomization. The options are **Disabled** and Enabled.

**Disable Block sid**

Select Enabled to allow SID authentication be performed in TCG Storage devices. The options are **Enabled** and Disabled.

**Intel Trusted Execution Support**

Intel Trusted Execution Technology (TXT) helps protect against software-based attacks and ensures protection, confidentiality, and integrity of data stored or created on the system. Use this feature to enable or disable TXT Support. The options are **Disabled** and Enabled.

**Current Status Information**

The following information will be displayed:

**TPM Enabled Status**

**TPM Active Status**

**TPM Owner Status**

## ▶ **USB Configuration**

**USB Configuration**

**USB Module Version: 21**

**USB Controllers: 2 XHCIs**

**USB Devices:**

**Legacy USB Support**

Select Enabled to support onboard legacy USB devices. Select Auto to disable legacy support if there are no legacy USB devices present. Select Disable to have all USB devices available for EFI applications only. The options are **Enabled**, Disabled, and Auto.

**XHCI Hand-off**

This is a work-around solution for operating systems that do not support XHCI (Extensible Host Controller Interface) hand-off. The XHCI ownership change should be claimed by the XHCI driver. The settings are **Enabled** and Disabled.

**USB Mass Storage Driver Support**

Select Enabled for USB mass storage device support. The options are Disabled and **Enabled**.

## ▶ **iSCSI Configuration**

### ▶ **Attempt Priority**

**Attempt Priority**

Use this feature to set the attempt priorities. The options are **Host Attempt**, Redfish Attempt, and Rsd Attempt.

**Commit Changes and Exit**

Select this item to save the changes and exit.

### ▶ **Host iSCSI Configuration**

**iSCSI Initiator Name**

This feature allows you to enter the unique name of the iSCSI Initiator in IQN format. Once the name of the iSCSI Initiator is entered into the system, configure the proper settings for the following items.

- ▶ Add an Attempt
- ▶ Delete Attempts
- ▶ Change Attempt Order

- ▶ Intel(R) Ethernet Controller X550 - AC:1F:6B:FB:75:3A
- ▶ Intel(R) Ethernet Controller X550 - AC:1F:6B:FB:75:3B
- ▶ Intel(R) I210 Gigabit Network Connection - AC:1F:6B:FC:E6:91
- ▶ NIC Configuration

#### Link Speed

Use this feature to specify the port speed used for the selected boot protocol. The options are **Auto Negotiated**, 10 Mbps Half, 10 Mbps Full, 100 Mbps Half, and 100 Mbps Full.

#### Wake On LAN

Select Enabled for wake on LAN support, which will allow the system to wake up when an onboard LAN device receives an incoming signal. The options are Disabled and **Enabled**.

#### Blink LEDs

Use this feature to identify the physical network port by blinking the associated LED. Use the keyboard to select a value.

#### UEFI Driver

#### Adapter PBA

#### Device Name

#### Chip Type

#### PCI Device ID

#### PCI Address

#### Link Status

#### MAC Address

#### Virtual MAC Address

### ▶ Intel(R) Ethernet Connection (11) I219-LM - AC:1F:6B:FC:E6:90

#### PORT CONFIGURATION INFORMATION

#### UEFI Driver

#### Adapter PBA

**PCI Device ID**

**PCI Address**

**MAC Address**

## ▶ **Intel(R) Rapid Storage Technology**

This submenu will only appear if the following requirements are met when entering the BIOS: Set the Boot Mode Select to **DUAL** or **UEFI**. Set the SATA Mode Selection to **Intel RST Premium With Intel Optane System Acceleration**. Set the Storage Option ROM/UEFI Driver to **EFI**.

Information for installed storage drives will be viewable in this submenu when the settings above are completed

## ▶ **Driver Health**

This feature provides the health status for the network drivers and controllers.

### ▶ **Intel(R) PRO/1000 6.7.05 PCIe**

**Controller 97d46818 Child 0**

**Intel(R) I210 Gigabit Network Connection**

### ▶ **Intel(R) Gigabit 0.0.29**

**Controller 97d44b18 Child 0**

### ▶ **Intel(R) 10GbE Driver 6.9.04 x64**

**Controller 97d47718 Child 0**

**Intel(R) Ethernet Controller X550**

### ▶ **Intel(R) 10GbE Driver 6.9.04 x64**

**Controller 97d46a18 Child 0**

**Intel(R) Ethernet Controller X550**

## 4.4 Event Logs

Use this menu to configure Event Log settings.



### ► Change SMBIOS Event Log Settings

#### Enabling/Disabling Options

##### SMBIOS Event Log

Change this feature to enable or disable all features of the SMBIOS Event Logging during system boot. The options are Disabled and **Enabled**.

#### Erasing Settings

##### Erase Event Log

If No is selected, data stored in the event log will not be erased. Select Yes, Next Reset, data in the event log will be erased upon next system reboot. Select Yes, Every Reset, data in the event log will be erased upon every system reboot. The options are **No**, Yes, Next reset, and Yes, Every reset.

##### When Log is Full

Select Erase Immediately for all messages to be automatically erased from the event log when the event log memory is full. The options are **Do Nothing** and Erase Immediately.

##### SMBIOS Event Log Standard Settings

### **Log System Boot Event**

This option toggles the System Boot Event logging to enabled or disabled. The options are **Disabled** and **Enabled**.

### **MECI**

The Multiple Event Count Increment (MECI) counter counts the number of occurrences that a duplicate event must happen before the MECI counter is incremented. This is a numeric value. The default value is **1**.

### **METW**

The Multiple Event Time Window (METW) defines the number of minutes that must pass between duplicate log events before MECI is incremented. This is in minutes, from 0 to 99. The default value is **60**.



**Note:** After making changes on a setting, reboot the system for the changes to take effect.

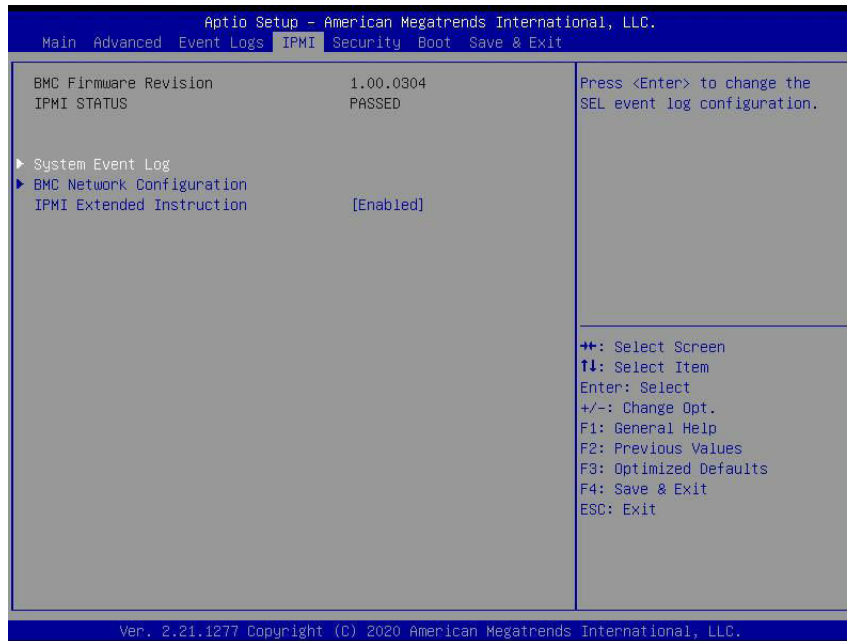
## **►View SMBIOS Event Log**

Select this submenu and press enter to see the contents of the SMBIOS event log. The following categories will be displayed: Date/Time/Error Codes/Severity.



## 4.5 IPMI

Use this menu to configure Intelligent Platform Management Interface (IPMI) settings.



### BMC Firmware Revision

This item indicates the IPMI firmware revision used in your system.

### IPMI STATUS (Baseboard Management Controller)

This item indicates the status of the IPMI firmware installed in your system.

## ▶ System Event Log

### Enabling/Disabling Options

#### SEL Components

Select Enabled for all system event logging at bootup. The options are **Enabled** and Disabled.

#### Erasing Settings

##### Erase SEL

Select Yes, On next reset to erase all system event logs upon next system reboot. Select Yes, On every reset to erase all system event logs upon each system reboot. Select No to keep all system event logs after each system reboot. The options are **No**, Yes, On next reset, and Yes, On every reset.

### When SEL is Full

This feature allows you to decide what the BIOS should do when the system event log is full. Select Erase Immediately to erase all events in the log when the system event log is full. The options are **Do Nothing** and Erase Immediately.



**Note:** After making changes on a setting, reboot the system for the changes to take effect.

## ► BMC Network Configuration

### BMC Network Configuration

#### Update IPMI LAN Configuration

Select Yes for the BIOS to implement all IP/MAC address changes at the next system boot. The options are **No** and Yes.

***\*If the feature above is set to Yes, Configuration Address Source, VLAN, and IPv6 Support available for configuration:***

#### Configure IPv4 Support

#### IPMI LAN Selection

#### IPMI Network Link Status

#### Configuration Address Source

This feature allows you to select the source of the IP address for this computer. If Static is selected, you will need to know the IP address of this computer and enter it to the system manually in the field. If DHCP is selected, the BIOS will search for a Dynamic Host Configuration Protocol (DHCP) server in the network that is attached to and request the next available IP address for this computer. The options are **DHCP** and Static.

***\*If the feature above is set to Static, the following features are available for configuration:***

#### Station IP Address

This features displays the Station IP address for this computer. The address can be manually entered. This should be in decimal and in dotted quad form (i.e., 192.168.10.253).

#### Subnet Mask

This feature displays the sub-network that this computer belongs to. The address can be manually entered. The value of each three-digit number separated by dots should not exceed 255.

#### Station MAC Address

**Gateway IP Address**

This feature displays the Gateway IP address for this computer. The address can be manually entered. This should be in decimal and in dotted quad form (i.e., 172.31.0.1).

**VLAN**

This feature displays the virtual LAN settings. The options are Disabled and Enabled.

**VLAN ID**

This feature is enabled if VLAN is enabled.

**Configure IPv6 Support****IPv6 Address Status****IPv6 Support**

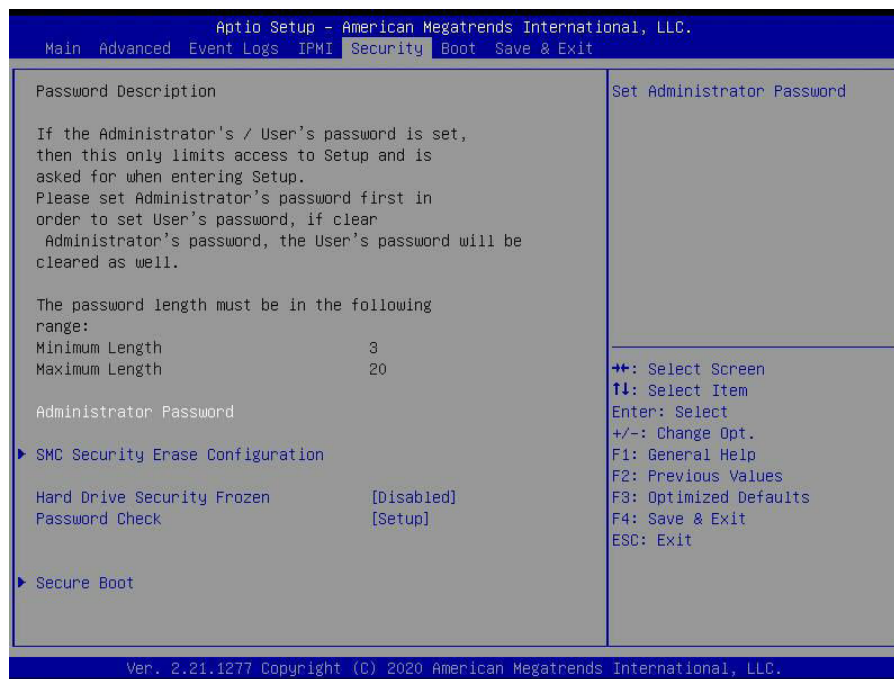
Use this feature to enable IPv6 support. The options are **Enabled** and Disabled.

**Configuration Address Source****Station IPv6 Address****Prefix Length****IPv6 Router1 IP Address****IPMI Extended Instruction**

Use this feature to enable IPMI support. The options are **Enabled** and Disabled. When Disabled, the system powers on quickly by removing BIOS support for extended IPMI features. The Disable option is for applications that require faster power on time without using Supermicro Update Manager (SUM) or extended IPMI features. The BMC network configuration in the BIOS setup is also invalid when IPMI Function Support is disabled. The general BMC function and motherboard health monitor such as fan control are still functioning even when this option is disabled.

## 4.6 Security

Use this menu to configure the following security settings for the system.



### Administrator Password

Press Enter to create a new, or change an existing, Administrator password.

### ► SMC Security Erase Configuration

This submenu becomes configurable when a storage device has been plugged into the motherboard. The options are Enabled and **Disabled**.

#### HDD Name

#### HDD Serial Number

#### Security Erase Mode

#### Estimated Time

#### HDD PserPwd Status

#### Security Function

Use this feature to set Security Function. The options are **Disabled**, Security Erase, and Set Password.

#### Password

Enter a numeric value to set the password.

### **Hard Drive Security Frozen**

Use this feature to enable or disable the BIOS security frozen command for SATA and NVMe devices. The options are Enabled and **Disabled**.

### **Password Check**

Select Setup for the system to check for a password at Setup. Select Always for the system to check for a password at bootup or upon entering the BIOS Setup utility. The options are **Setup** and Always.

### **Lockdown Mode**

This feature is grayed out when the DCMS Key is not installed.

## **▶ Secure Boot**

This section displays the contents of the following secure boot features:

- System Mode
- Secure Boo

### **Secure Boot**

Use this feature to enable secure boot. The options are **Disabled** and Enabled.

### **Secure Boot Mode**

Use this item to configure Secure Boot variables without authentication. The options are Standard and **Custom**.

### **CSM Support**

This feature is for manufacturing debugging purposes.

### **Enter Audit Mode**

This submenu can only be used if current System Mode is set to User (refer to Exit Deployed Mode). The PK variable will be erased on transition to Audit Mode.

### **Enter Deployed Mode**

Press <Enter> button to transition between Deployment and User Mode.

### **Exit Deployed Mode**

Press <Enter> button to switch between Deployment and User Mode.

## **▶ Key Management**

This submenu allows you to configure the following Key Management settings.

### ▶ Restore Factory Keys

Force System to User Mode. Install factory default Secure Boot key databases.

### ▶ Reset to Setup Mode

This feature deletes all Secure Boot key databases from NVRAM.

### ▶ Export Secure Boot variables

This feature allows you to copy NVRAM content of Secure boot variables to files in a root folder on a file system device.

### ▶ Enroll EFI Image

This feature allows the image to run in Secure Boot Mode. Enroll SHA256 Hash Certificate of the image into the Authorized Signature Database.

## Device Guard Ready

### ▶ Remove 'UEFI CA' from DB

This feature allows you to decide if all secure boot variables should be saved.

### ▶ Restore DB defaults

Select Yes to restore the DB defaults.

## Secure Boot Variable

### ▶ Platform Key (PK)

#### Details

Review details on current settings of the platform keys.

#### Export

This feature allows you to export Platform Keys to an available file system.

#### Update

Select Yes to load the new Platform Keys (PK) from the manufacturer's defaults. Select No to load the Platform Keys from a file.

**Delete**

Select OK to confirm deletion of the Platform Key from NVRAM.

**▶ Key Exchange Key****Details**

Review details on current settings of the Key Exchange Keys.

**Export**

This feature allows you to export Key Exchange Keys to an available file system.

**Update**

Select Yes to load the KEK from the manufacturer's defaults. Select No to load the Key Exchange Keys from a file.

**Append**

Select Yes to add the KEK from the manufacturer's defaults list to the existing KEK. Select No to load the KEK from a file.

**Delete**

Select Yes delete the Key.

**▶ Authorized Signatures****Details**

Review details on current settings of the Authorized Signatures.

**Export**

This feature allows you to export Authorized Signatures to an available file system.

**Update**

Select Yes to load the DB from the manufacturer's defaults. Select No to load the DB from a file.

**Append**

Select Yes to add the DB from the manufacturer's defaults list to the existing DB. Select No to load the DB from a file.

**Delete**

Select Yes to delete the Authorized Signatures key database. Select No to delete only a certificate from the key database.

## ► Forbidden Signatures

### Details

Review details on current settings of the Forbidden Signatures.

### Export

This feature allows you to export Forbidden Signatures to an available file system.

### Update

Select Yes to load the DBX from the manufacturer's defaults. Select No to load the DBX from a file.

### Append

Select Yes to add the DBX from the manufacturer's defaults list to the existing DBX. Select No to load the DBX from a file.

### Delete

Select Yes to delete the Forbidden Signatures key database. Select No to delete only a certificate from the key database.

## ► Authorized TimeStamps

### Details

Review details on current settings of the Authorized TimeStamps.

### Export

This feature allows you to export Authorized TimeStamps to an available file system.

### Update

Select Yes to load the DBT from the manufacturer's defaults. Select No to load the DBT from a file.

### Append

Select Yes to add the DBT from the manufacturer's defaults list to the existing DBT. Select No to load the DBT from a file.

### Delete

Select Yes to delete the Authorized TimeStamps key database. Select No to delete only a certificate from the key database.



## ► OsRecovery Signature

### Details

Review details on current settings of the OsRecovery Signatures.

### Export

This feature allows you to export OsRecovery Signatures to an available file system.

### Update

Select Yes to load the DBR from the manufacturer's defaults. Select No to load the DBR from a file.

### Append

Select Yes to add the DBR from the manufacturer's defaults list to the existing DBR. Select No to load the DBR from a file.

### Delete

Select Yes to delete the OsRecovery Signatures key database. Select No to delete only a certificate from the key database.

## ► TCG Storage Device Security Configuration

### Storage Device

The feature shown here is dependent on the storage device plugged into the motherboard.

### Password Configuration:

The following information is displayed:

#### Password

#### Security Subsystem Class

#### Security Supported

#### Security Enabled

#### Security Locked

#### Security Frozen

#### User Pwd Status

#### Admin Pwd Status

#### Set Admin Password

Press <Enter> to create a new admin password.

### **Set User Password**

Press <Enter> to create a new user password.

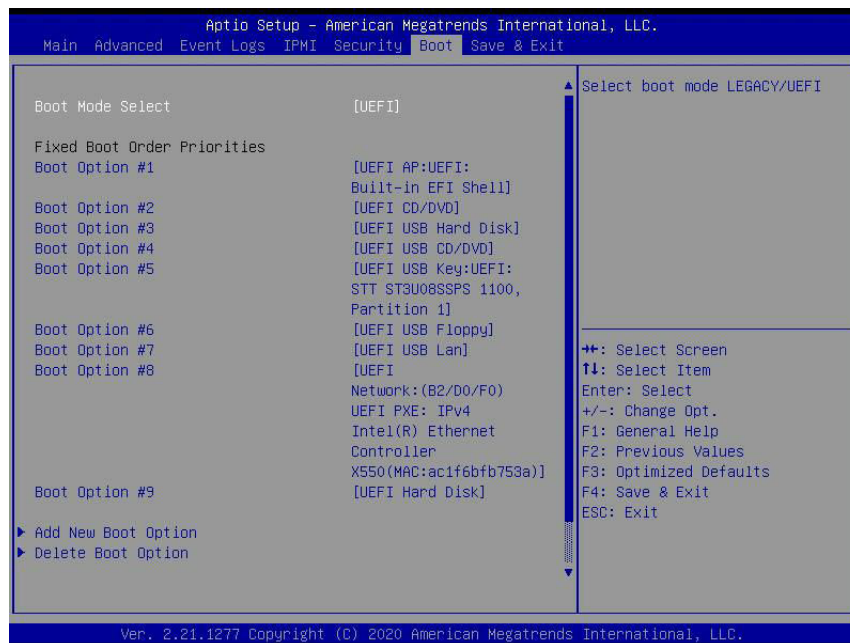
*\*The next feature is available when the Admin Password has been activated.*

### **Device Reset**

Reset the device using a 32 byte Physical Security Identification (PSID) value of the device.

## 4.7 Boot

Use this menu to configure Boot settings.



### Boot Mode Select

Use this item to select the type of device that the system is going to boot from. The options are Legacy, **UEFI**, and DUAL.

### Fixed Boot Order Priorities

This option prioritizes the order of bootable devices that the system boots from. Press <Enter> on each entry from top to bottom to select devices.

***\*If the feature "Boot Mode Select" is set to Legacy, UEFI, or Dual, the following items will be displayed:***

- Boot Option #1
- Boot Option #2
- Boot Option #3
- Boot Option #4
- Boot Option #5
- Boot Option #6
- Boot Option #7
- Boot Option #8

- Boot Option #9
- Boot Option #10
- Boot Option #11
- Boot Option #12
- Boot Option #13
- Boot Option #14
- Boot Option #15

### ▶ Add New Boot Option

This feature allows you to add a new boot option to the boot priority features for your system.

#### **Add Boot Option**

Use this feature to specify the name for the new boot option.

#### **Path for Boot Option**

Use this feature to enter the path for the new boot option in the format fsx:\path\filename.efi.

#### **Boot Option File Path**

Use this feature to specify the file path for the new boot option.

#### **Create**

Use this feature to set the name and the file path of the new boot option.

### ▶ Delete Boot Option

This feature allows you to select a boot device to delete from the boot priority list.

#### **Delete Boot Option**

Use this item to remove an EFI boot option from the boot priority list.

- ▶ UEFI Hard Disk Drive BBS Priorities
- ▶ UEFI CD/DVD Drive BBS Priorities
- ▶ UEFI Application Boot Priorities
- ▶ UEFI USB Hard Disk Drive BBS Priorities
- ▶ UEFI USB CD/DVD Drive BBS Priorities
- ▶ UEFI USB Key Drive BBS Priorities
- ▶ UEFI USB Floppy Drive BBS Priorities
- ▶ UEFI USB LAN Drive BBS Priorities
- ▶ UEFI NETWORK Drive BBS Priorities

- ▶ **Hard Disk Drive BBS Priorities**
- ▶ **CD/DVD Drive BBS Priorities**
- ▶ **USB Hard Disk Drive BBS Priorities**
- ▶ **USB CD/DVD Drive BBS Priorities**
- ▶ **USB Key Drive BBS Priorities**
- ▶ **USB Floppy Drive BBS Priorities**
- ▶ **USB LAN Drive BBS Priorities**
- ▶ **NETWORK Drive BBS Priorities**

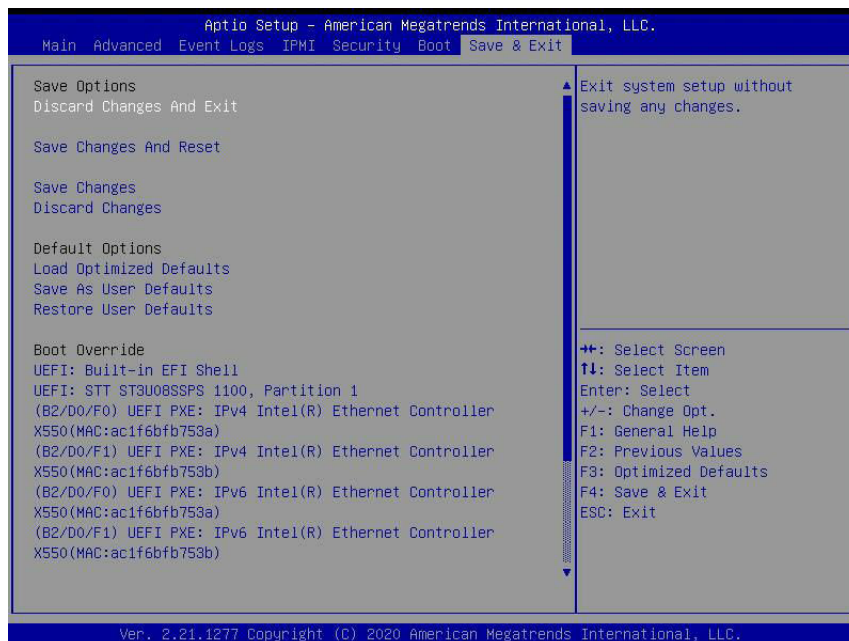
These submenus are subject to change depending on the feature of Boot Mode Select and the devices installed on this motherboard.

### **Boot Option #1 - X**

Use this feature to set the system boot order. The number of X is depending on the devices installed on the motherboard.

## 4.8 Save & Exit

Use this menu to save settings and exit from the BIOS.



### Save Options

#### Discard Changes and Exit

Select this option to quit the BIOS Setup without making any permanent changes to the system configuration, and reboot the computer. Select Discard Changes and Exit from the Save & Exit menu and press <Enter>.

#### Save Changes and Reset

After completing the system configuration changes, select this option to save the changes you have made. This will not reset (reboot) the system.

#### Save Changes

When you have completed the system configuration changes, select this option to leave the BIOS setup utility and reboot the computer for the new system configuration parameters to take effect. Select Save Changes from the Save & Exit menu and press <Enter>.

#### Discard Changes

Select this option and press <Enter> to discard all the changes and return to the AMI BIOS utility program.

## **Default Options**

### **Load Optimized Defaults**

To set this feature, select Restore Defaults from the Save & Exit menu and press <Enter>. These are factory settings designed for maximum system stability, but not for maximum performance.

### **Save As User Defaults**

To set this feature, select Save as User Defaults from the Save & Exit menu and press <Enter>. This enables you to save any changes to the BIOS setup for future use.

### **Restore User Defaults**

To set this feature, select Restore User Defaults from the Save & Exit menu and press <Enter>. Use this feature to retrieve user-defined settings that were saved previously.

### **Boot Override**

This feature allows you to override the Boot priorities sequence in the Boot menu, and immediately boot the system with a device specified by you instead of the one specified in the boot list. This is an one-time override.

### **UEFI: Built-in EFI Shell**

### **Intel(R) Ethernet Controller X550**

# Appendix A

## BIOS Codes

### A.1 BIOS Error POST (Beep) Codes

During the POST (Power-On Self-Test) routines, which are performed each time the system is powered on, errors may occur.

Non-fatal errors are those which, in most cases, allow the system to continue the boot-up process. The error messages normally appear on the screen.

**Fatal errors** are those which will not allow the system to continue the boot-up procedure. If a fatal error occurs, you should consult with your system manufacturer for possible repairs.

These fatal errors are usually communicated through a series of audible beeps. The table shown below lists some common errors and their corresponding beep codes encountered by users.

BIOS Beep (POST) Codes		
Beep Code	Error Message	Description
1 beep	Refresh	Circuits have been reset (Ready to power up)
5 short, 1 long	Memory error	No memory detected in system
5 long, 2 short	Display memory read/write error	Video adapter missing or with faulty memory
1 long continuous	System OH	System overheat condition



## A.2 Additional BIOS POST Codes

The AMI BIOS supplies additional checkpoint codes, which are documented online at <http://www.supermicro.com/support/manuals/> ("AMI BIOS POST Codes User's Guide").

For information on AMI updates, please refer to <http://www.ami.com/products/>.

## Appendix B

### Software

After the hardware has been installed, you can install the Operating System (OS), configure RAID settings and install the drivers.

#### B.1 Microsoft Windows OS Installation

If you will be using RAID, you must configure RAID settings before installing the Windows OS and the RAID driver. Refer to the RAID Configuration User Guides posted on our website at [www.supernmicro.com/support/manuals](http://www.supernmicro.com/support/manuals).

##### *Installing the OS*

1. Create a method to access the MS Windows installation ISO file. That can be a USB flash or media drive.
2. Retrieve the proper RST/RSTe driver. Go to the Supermicro web page for your motherboard and click on "Download the Latest Drivers and Utilities", select the proper driver, and copy it to a USB flash drive.
3. Boot from a bootable device with Windows OS installation. You can see a bootable device list by pressing **F11** during the system startup.

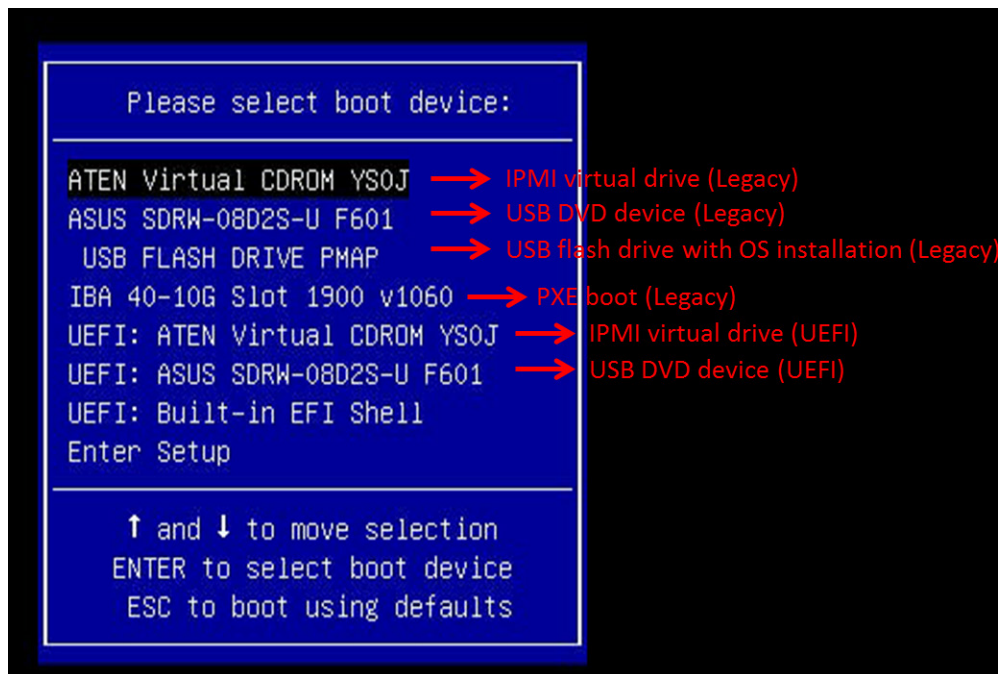
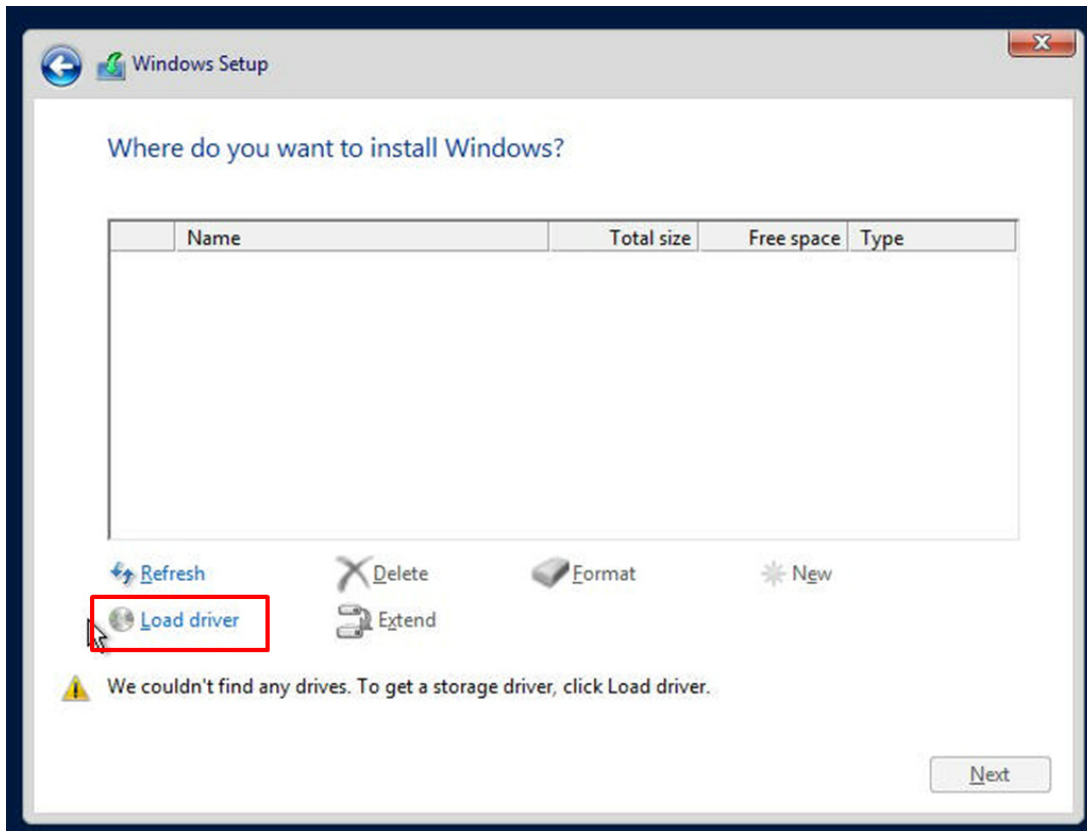


Figure B-1. Select Boot Device

4. During Windows Setup, continue to the dialog where you select the drives on which to install Windows. If the disk you want to use is not listed, click on “Load driver” link at the bottom left corner.



**Figure B-2. Load Driver Link**

To load the driver, browse the USB flash drive for the proper driver files.

- For RAID, choose the SATA/sSATA RAID driver indicated then choose the storage drive on which you want to install it.
  - For non-RAID, choose the SATA/sSATA AHCI driver indicated then choose the storage drive on which you want to install it.
5. Once all devices are specified, continue with the installation.
  6. After the Windows OS installation has completed, the system will automatically reboot multiple times.

## B.2 Driver Installation

The Supermicro website contains drivers and utilities for your system at <https://www.supermicro.com/wdl/driver>. Some of these must be installed, such as the chipset driver.

After accessing the website, go into the CDR\_Images (in the parent directory of the above link) and locate the ISO file for your motherboard. Download this file to a USB flash or media drive. (You may also use a utility to extract the ISO file if preferred.)

Another option is to go to the Supermicro website at <http://www.supermicro.com/products/>. Find the product page for your motherboard, and "Download the Latest Drivers and Utilities."

Insert the flash drive or disk and the screenshot shown below should appear.

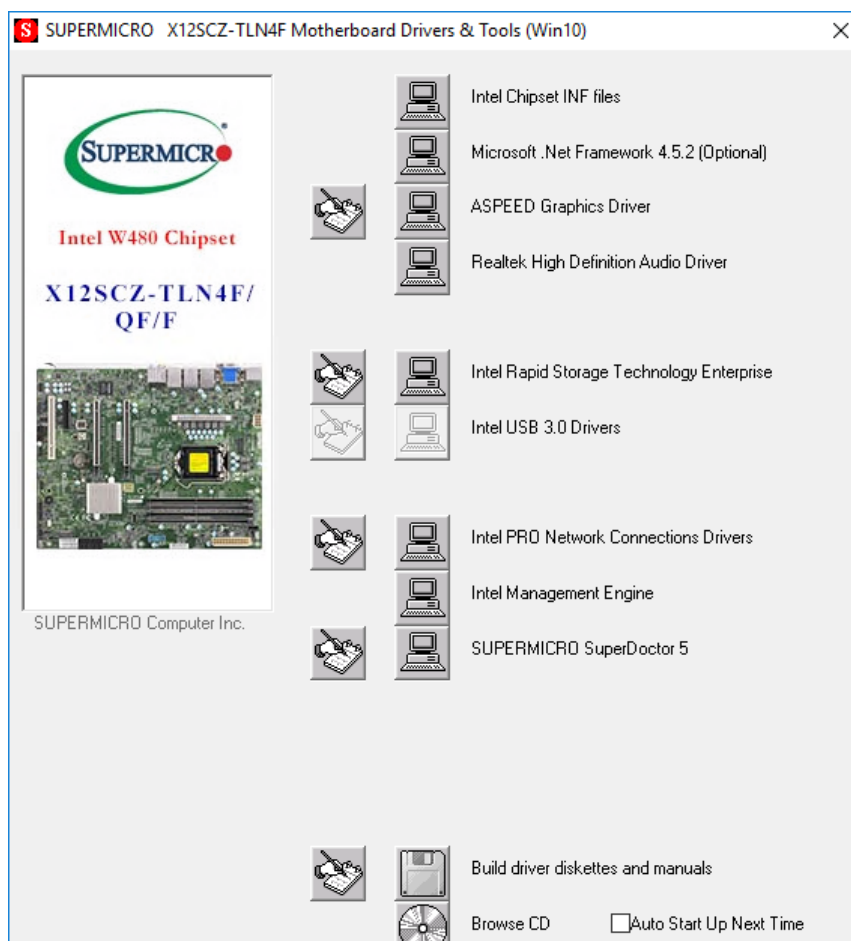


Figure B-3. Driver & Tool Installation Screen

**Note:** Click the icons showing a hand writing on paper to view the readme files for each item. Click the computer icons to the right of these items to install each item (from top to bottom) one at a time. **After installing each item, you must reboot the system before moving on to the next item on the list.** The bottom icon with a CD on it allows you to view the entire contents.

## B.3 SuperDoctor® 5

The Supermicro SuperDoctor 5 is a program that functions in a command-line or web-based interface for Windows and Linux operating systems. The program monitors such system health information as CPU temperature, system voltages, system power consumption, fan speed, and provides alerts via email or Simple Network Management Protocol (SNMP).

SuperDoctor 5 comes in local and remote management versions and can be used with Nagios to maximize your system monitoring needs. With SuperDoctor 5 Management Server (SSM Server), you can remotely control power on/off and reset chassis intrusion for multiple systems with SuperDoctor 5 or IPMI. SuperDoctor 5 Management Server monitors HTTP, FTP, and SMTP services to optimize the efficiency of your operation.

**Note:** The default User Name and Password for SuperDoctor 5 is ADMIN / ADMIN.

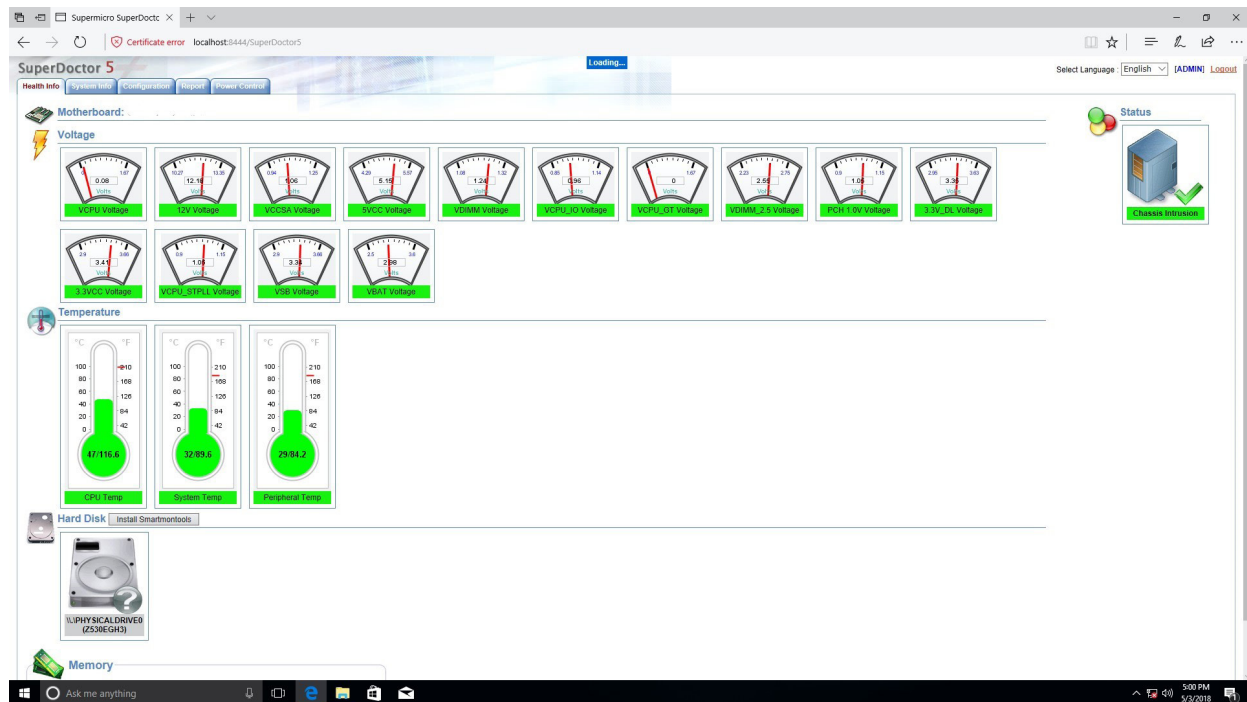


Figure B-4. SuperDoctor 5 Interface Display Screen (Health Information)

## B.4 IPMI

The X12SCZ-TLN4F/QF/F supports the Intelligent Platform Management Interface (IPMI). IPMI is used to provide remote access, monitoring and management. There are several BIOS settings that are related to IPMI.

Supermicro ships standard products with a unique password for the BMC ADMIN user. This password can be found on a label on the motherboard. For general documentation and information on IPMI, please visit our website at: <http://www.supermicro.com/products/nfo/IPMI.cfm>.

## Appendix C

### Standardized Warning Statements

The following statements are industry standard warnings, provided to warn the user of situations which have the potential for bodily injury. Should you have questions or experience difficulty, contact Supermicro's Technical Support department for assistance. Only certified technicians should attempt to install or configure components.

Read this section in its entirety before installing or configuring components.

These warnings may also be found on our website at [http://www.supermicro.com/about/policies/safety\\_information.cfm](http://www.supermicro.com/about/policies/safety_information.cfm).

#### Battery Handling



**Warning!** There is the danger of explosion if the battery is replaced incorrectly. Replace the battery only with the same or equivalent type recommended by the manufacturer. Dispose of used batteries according to the manufacturer's instructions

#### 電池の取り扱い

電池交換が正しく行われなかった場合、破裂の危険性があります。交換する電池はメーカーが推奨する型、または同等のものを使用下さい。使用済電池は製造元の指示に従って処分して下さい。

#### 警告

電池更換不當會有爆炸危險。請只使用同類電池或制造商推薦的功能相當的電池更換原有電池。請按製造商的說明處理廢舊電池。

#### 警告

電池更換不當會有爆炸危險。請使用製造商建議之相同或功能相當的電池更換原有電池。請按照製造商的說明指示處理廢棄舊電池。

#### Warnung

Bei Einsetzen einer falschen Batterie besteht Explosionsgefahr. Ersetzen Sie die Batterie nur durch den gleichen oder vom Hersteller empfohlenen Batterietyp. Entsorgen Sie die benutzten Batterien nach den Anweisungen des Herstellers.

#### Attention

Danger d'explosion si la pile n'est pas remplacée correctement. Ne la remplacer que par une pile de type semblable ou équivalent, recommandée par le fabricant. Jeter les piles usagées conformément aux instructions du fabricant.

#### ¡Advertencia!

Existe peligro de explosión si la batería se reemplaza de manera incorrecta. Reemplazar la batería exclusivamente con el mismo tipo o el equivalente recomendado por el fabricante. Desechar las baterías gastadas según las instrucciones del fabricante.

#### אזהרה!

קיימת סכנת פיצוץ של הסוללה במידה והוחלפה בדרך לא תקינה. יש להחליף את הסוללה בסוג התואם מחברת יצרן מומלצת. סילוק הסוללות המשומשות יש לבצע לפי הוראות היצרן.

هناك خطر من انفجار في حالة اسبدال البطارية بطريقة غير صحيحة فعلياً  
اسبدال البطارية  
فقط بنفس النوع أو ما يعادلها مما أوصت به الشركة المصنعة  
جخلص من البطاريات المسحمة وفقاً لتعليمات الشركة الصانعة

#### 경고!

배터리가 올바르게 교체되지 않으면 폭발의 위험이 있습니다. 기존 배터리와 동일하거나 제조사에서 권장하는 동등한 종류의 배터리로만 교체해야 합니다. 제조사의 안내에 따라 사용된 배터리를 처리하여 주십시오.

#### Waarschuwing

Er is ontploffingsgevaar indien de batterij verkeerd vervangen wordt. Vervang de batterij slechts met hetzelfde of een equivalent type die door de fabrikant aanbevolen wordt. Gebruikte batterijen dienen overeenkomstig fabrieksvoorschriften afgevoerd te worden.



## Product Disposal



**Warning!** Ultimate disposal of this product should be handled according to all national laws and regulations.

### 製品の廃棄

この製品を廃棄処分する場合、国の関係する全ての法律・条例に従い処理する必要があります。

### 警告

本产品的废弃处理应根据所有国家的法律和规章进行。

### 警告

本產品的廢棄處理應根據所有國家的法律和規章進行。

### Warnung

Die Entsorgung dieses Produkts sollte gemäß allen Bestimmungen und Gesetzen des Landes erfolgen.

### ¡Advertencia!

Al deshacerse por completo de este producto debe seguir todas las leyes y reglamentos nacionales.

### Attention

La mise au rebut ou le recyclage de ce produit sont généralement soumis à des lois et/ou directives de respect de l'environnement. Renseignez-vous auprès de l'organisme compétent.

סילוק המוצר

אזהרה!

סילוק סופי של מוצר זה חייב להיות בהתאם להנחיות וחוקי המדינה.

عند التخلص النهائي من هذا المنتج ينبغي التعامل معه وفقا لجميع القوانين واللوائح الوطنية

### 경고!

이 제품은 해당 국가의 관련 법규 및 규정에 따라 폐기되어야 합니다.

### Waarschuwing

De uiteindelijke verwijdering van dit product dient te geschieden in overeenstemming met alle nationale wetten en reglementen.

## Appendix D

# UEFI BIOS Recovery

**Warning:** Do not upgrade the BIOS unless your system has a BIOS-related issue. Flashing the wrong BIOS can cause irreparable damage to the system. In no event shall Supermicro be liable for direct, indirect, special, incidental, or consequential damages arising from a BIOS update. If you need to update the BIOS, do not shut down or reset the system while the BIOS is updating to avoid possible boot failure.

### D.1 Overview

The Unified Extensible Firmware Interface (UEFI) provides a software-based interface between the operating system and the platform firmware in the pre-boot environment. The UEFI specification supports an architecture-independent mechanism that will allow the UEFI OS loader stored in an add-on card to boot the system. The UEFI offers clean, hands-off management to a computer during system boot.

### D.2 Recovering the UEFI BIOS Image

A UEFI BIOS flash chip consists of a recovery BIOS block and a main BIOS block (a main BIOS image). The recovery block contains critical BIOS codes, including memory detection and recovery codes for the user to flash a healthy BIOS image if the original main BIOS image is corrupted. When the system power is first turned on, the boot block codes execute first. Once this process is completed, the main BIOS code will continue with system initialization and the remaining Power-On Self-Test (POST) routines.



**Note 1:** Follow the BIOS recovery instructions below for BIOS recovery when the main BIOS block crashes.

**Note 2:** When the BIOS recovery block crashes, you will need to follow the procedures to make a Returned Merchandise Authorization (RMA) request. (For a RMA request, please see section 3.5 for more information). Also, you may use the Supermicro Update Manager (SUM) Out-of-Band (OOB) ([https://www.supermicro.com.tw/products/nfo/SMS\\_SUM.cfm](https://www.supermicro.com.tw/products/nfo/SMS_SUM.cfm)) to reflash the BIOS.


### D.3 Recovering the BIOS Block with a USB Device

This feature allows the user to recover the main BIOS image using a USB-attached device without additional utilities used. A USB flash or media drive can be used for this purpose. However, a USB Hard Disk drive cannot be used for BIOS recovery at this time.

The file system supported by the recovery block is FAT (including FAT12, FAT16, and FAT32), which is installed on a bootable or non-bootable USB-attached device. However, the BIOS might need several minutes to locate the SUPER.ROM file if the media size becomes too large due to the huge volumes of folders and files stored in the device.

To perform UEFI BIOS recovery using a USB-attached device, follow the instructions below:

1. Using a different machine, copy the "Super.ROM" binary image file into the disc Root "\\" directory of a USB flash or media drive.

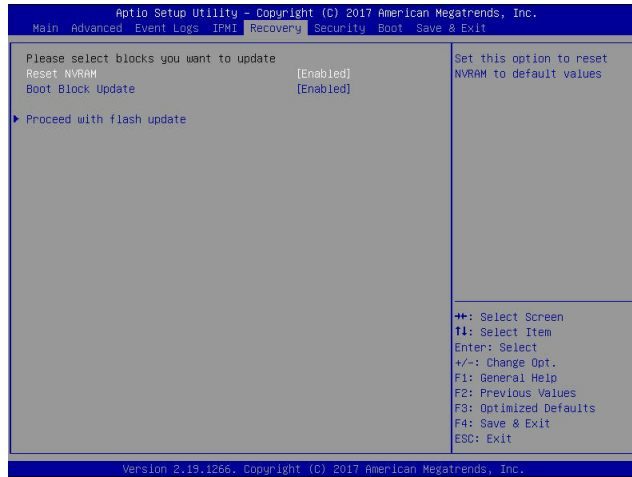
 **Note 1:** If you cannot locate the "Super.ROM" file in your driver disk, visit our website at [www.supermicro.com](http://www.supermicro.com) to download the BIOS package. Extract the BIOS binary image into a USB flash device and rename it "Super.ROM" for the BIOS recovery use.


**Note 2:** Before recovering the main BIOS image, confirm that the "Super.ROM" binary image file you download is the same version or a close version meant for your motherboard.

2. Insert the USB device that contains the new BIOS image ("Super.ROM") into your USB port and reset the system until the following screen appears:




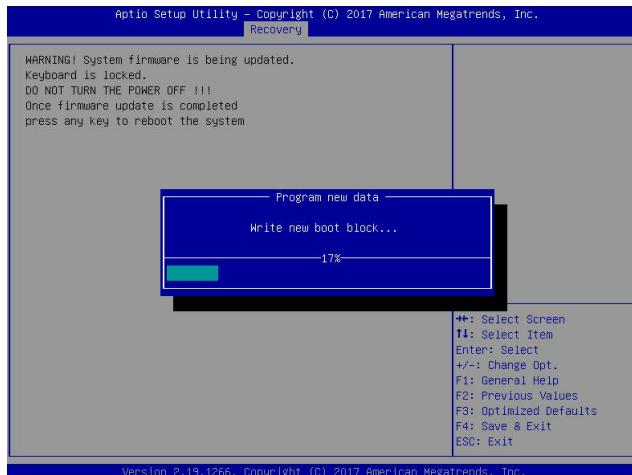
3. After locating the new BIOS binary image, the system will enter the BIOS Recovery menu as shown below:



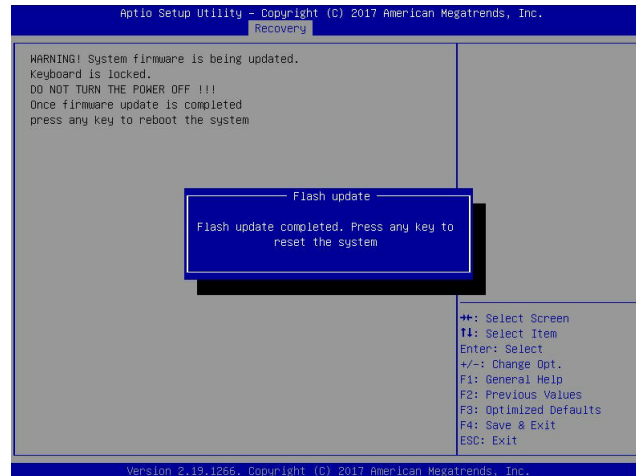
 **Note:** At this point, you may decide if you want to start the BIOS recovery. If you decide to proceed with BIOS recovery, follow the procedures below.

4. When the screen as shown above displays, use the arrow keys to select the item "Proceed with flash update" and press the <Enter> key. You will see the BIOS recovery progress as shown in the screen below:

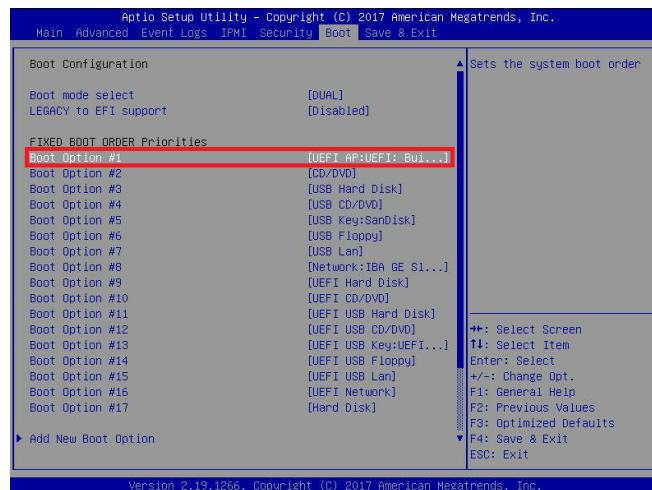
 **Note:** Do not interrupt the BIOS flashing process until it has completed.



5. After the BIOS recovery process is completed, press any key to reboot the system.
6. Using a different system, extract the BIOS package into a USB flash drive.



7. Press <Del> during system boot to enter the BIOS Setup utility. From the top of the tool bar, select Boot to enter the submenu. From the submenu list, select Boot Option #1 as shown below. Then, set Boot Option #1 to [UEFI AP:UEFI: Built-in EFI Shell]. Press <F4> to save the settings and exit the BIOS Setup utility.



- When the UEFI Shell prompt appears, type `fs#` to change the device directory path. Go to the directory that contains the BIOS package you extracted earlier from Step 6. Enter `flash.nsh BIOSname.###` at the prompt to start the BIOS update process.

```

UEFI Interactive Shell v2.1
EDK II
UEFI v2.50 (American Megatrends, 0x0005000C)
Mapping table
  FS0: Alias(s):HD0:0B:BLK1:
      PciRoot(0x0)/Pci(0x14,0x0)/USB(0x11,0x0)/HD(1,MBR,0x37901D72,0x800,0x1
DR9592)
  BLK0: Alias(s):
      PciRoot(0x0)/Pci(0x14,0x0)/USB(0x11,0x0)
Press F8 in 1 seconds to skip startup.nsh or any other key to continue.
Shell> fs0:
FS0:\> cd \NFUDOS
FS0:\NFUDOS> cd SHJPM2_03162017
FS0:\NFUDOS\SHJPM2_03162017> flash.nsh X110PU7_314
    
```

```

Done.
[ Access Cross Port Ex ]
<read>
Index 0x51: 0x1B
Done.
*****
* Program BIOS and ME (including FDT) regions...
*****
| AMI Firmware Update Utility v5.09.01.1317 |
| Copyright (C)2017 American Megatrends Inc. All Rights Reserved. |
*****
CPUID = 50652
Reading flash ..... done
- ME Data Size checking - ok
- FFS checksums ..... ok
- Check RomLayout ..... Ok.
Erasing Boot Block ..... done
Updating Boot Block ..... done
Verifying Boot Block ..... done
_Erasing Main Block ..... 0x00132000 (0X)
    
```

```

Verifying NCB Block ..... done
- Update success for FDR
- Update success for IE
- Successful Update Recovery Loader to OPRxII
- Successful Update MFSBII-
- Successful Update FTPII-
- Successful Update MFS_IvB1 and IVB2!!
- Successful Update FLOS and UTOXII
- ME Entire Image update success !!
WARNING : System must power-off to have the changes take effect!
Moving FS0:\NFUDOS\SHJPM2_03162017\Fdtx64.efi -> FS0:\NFUDOS\SHJPM2_03162017\F
dt.smc
- [OK]
Moving FS0:\NFUDOS\SHJPM2_03162017\afuef1x64.efi -> FS0:\NFUDOS\SHJPM2_0316201
7\afuef1.smc
- [OK]
*****
* Please ignore this "Shell: Cannot read from file - Device Error"
* warning message due to it does not impact flashing process.
*****
Deleting "FS0:\afuef1.smc"
Delete successful.
FS0:\>
    
```



**Note:** Do not interrupt this process until the BIOS flashing is complete.

- The screen above indicates that the BIOS update process is complete. When you see the screen above, unplug the AC power cable from the power supply, clear CMOS, and plug the AC power cable in the power supply again to power on the system.
- Press `<Del>` to enter the BIOS Setup utility.
- Press `<F3>` to load the default settings.
- After loading the default settings, press `<F4>` to save the settings and exit the BIOS Setup utility.