



X12SDV-4C/8C/14C/16C/20C-
SPT8F

USER'S MANUAL

Revision 1.0c

The information in this user's manual has been carefully reviewed and is believed to be accurate. The manufacturer assumes no responsibility for any inaccuracies that may be contained in this document, and makes no commitment to update or to keep current the information in this manual, or to notify any person or organization of the updates. **Please Note: For the most up-to-date version of this manual, please see our website at www.supermicro.com.**

Super Micro Computer, Inc. ("Supermicro") reserves the right to make changes to the product described in this manual at any time and without notice. This product, including software and documentation, is the property of Supermicro and/or its licensors, and is supplied only under a license. Any use or reproduction of this product is not allowed, except as expressly permitted by the terms of said license.

IN NO EVENT WILL Super Micro Computer, Inc. BE LIABLE FOR DIRECT, INDIRECT, SPECIAL, INCIDENTAL, SPECULATIVE OR CONSEQUENTIAL DAMAGES ARISING FROM THE USE OR INABILITY TO USE THIS PRODUCT OR DOCUMENTATION, EVEN IF ADVISED OF THE POSSIBILITY OF SUCH DAMAGES. IN PARTICULAR, SUPER MICRO COMPUTER, INC. SHALL NOT HAVE LIABILITY FOR ANY HARDWARE, SOFTWARE, OR DATA STORED OR USED WITH THE PRODUCT, INCLUDING THE COSTS OF REPAIRING, REPLACING, INTEGRATING, INSTALLING OR RECOVERING SUCH HARDWARE, SOFTWARE, OR DATA.

Any disputes arising between manufacturer and customer shall be governed by the laws of Santa Clara County in the State of California, USA. The State of California, County of Santa Clara shall be the exclusive venue for the resolution of any such disputes. Supermicro's total liability for all claims will not exceed the price paid for the hardware product.

FCC Statement: This equipment has been tested and found to comply with the limits for a Class A digital device pursuant to Part 15 of the FCC Rules. These limits are designed to provide reasonable protection against harmful interference when the equipment is operated in a commercial environment. This equipment generates, uses, and can radiate radio frequency energy and, if not installed and used in accordance with the manufacturer's instruction manual, may cause harmful interference with radio communications. Operation of this equipment in a residential area is likely to cause harmful interference, in which case you will be required to correct the interference at your own expense.

California Best Management Practices Regulations for Perchlorate Materials: This Perchlorate warning applies only to products containing CR (Manganese Dioxide) Lithium coin cells. "Perchlorate Material-special handling may apply. See www.dtsc.ca.gov/hazardouswaste/perchlorate".



WARNING: This product can expose you to chemicals including lead, known to the State of California to cause cancer and birth defects or other reproductive harm. For more information, go to www.P65Warnings.ca.gov.

The products sold by Supermicro are not intended for and will not be used in life support systems, medical equipment, nuclear facilities or systems, aircraft, aircraft devices, aircraft/emergency communication devices or other critical systems whose failure to perform be reasonably expected to result in significant injury or loss of life or catastrophic property damage. Accordingly, Supermicro disclaims any and all liability, and should buyer use or sell such products for use in such ultra-hazardous applications, it does so entirely at its own risk. Furthermore, buyer agrees to fully indemnify, defend and hold Supermicro harmless for and against any and all claims, demands, actions, litigation, and proceedings of any kind arising out of or related to such ultra-hazardous use or sale.

Manual Revision 1.0c

Release Date: May 02, 2025

Unless you request and receive written permission from Super Micro Computer, Inc., you may not copy any part of this document. Information in this document is subject to change without notice. Other products and companies referred to herein are trademarks or registered trademarks of their respective companies or mark holders.

Copyright © 2025 by Super Micro Computer, Inc.
All rights reserved.

Printed in the United States of America

Preface

About This Manual

This manual is written for system integrators, IT technicians and knowledgeable end users. It provides information for the installation and use of the motherboard.

About This Motherboard

The Supermicro X12SDV-4C/8C/14C/16C/20C-SPT8F series motherboard is built with an Intel® Xeon D-2700 Processor with up to 20 cores and a thermal design power (TDP) of 65 W-120 W. This is a high performance, low power and small form factor motherboard featuring up to 256 GB of ECC RDIMM or up to 512 GB LRDIMM memory, SATA 3.0 ports, M.2 M-Key, OcuLink (PCIe 3.0 x4), SlimSAS (PCIe 4.0 x8), one PCIe 4.0 x16 slot, NVMe and eight LAN ports including two 25G SFP28, two 10G Base-T, and four 1GbE ports. The Trusted Platform Module (TPM) 2.0 onboard with header is designed for hardware based security function support. Note that this motherboard is intended to be installed and serviced by professional technicians only. For processor/memory updates, refer to our website at <http://www.supermicro.com/products/>.

Conventions Used in the Manual

Special attention should be given to the following symbols for proper installation and to prevent damage done to the components or injury to yourself:



Warning! Indicates important information given to prevent equipment/property damage or personal injury.



Warning! Indicates high voltage may be encountered while performing a procedure.



Important: Important information given to ensure proper system installation or to relay safety precautions.



Note: Additional Information given to differentiate various models or to provide information for proper system setup.

Contacting Supermicro

Headquarters

Address: Super Micro Computer, Inc.
980 Rock Ave.
San Jose, CA 95131 U.S.A.

Tel: +1 (408) 503-8000

Fax: +1 (408) 503-8008

Email: Marketing@supermicro.com (General Information)
Sales-USA@supermicro.com (Sales Inquiries)
Government_Sales-USA@supermicro.com (Gov. Sales Inquiries)
Support@supermicro.com (Technical Support)
RMA@supermicro.com (RMA Support)
Webmaster@supermicro.com (Webmaster)

Website: www.supermicro.com

Europe

Address: Super Micro Computer B.V.
Het Sterrenbeeld 28, 5215 ML
's-Hertogenbosch, The Netherlands

Tel: +31 (0) 73-6400390

Fax: +31 (0) 73-6416525

Email: Sales_Europe@supermicro.com (General Information)
Support_Europe@supermicro.com (Technical Support)
RMA_Europe@supermicro.com (RMA Support)

Website: www.supermicro.nl

Asia-Pacific

Address: Super Micro Computer, Inc.
3F, No. 150, Jian 1st Rd.
Zhonghe Dist., New Taipei City 235
Taiwan (R.O.C)

Tel: +886-(2) 8226-3990

Fax: +886-(2) 8226-3992

Email: Sales-Asia@supermicro.com.tw (Sales Inquiry)
Support@supermicro.com.tw (Technical Support)
RMA@supermicro.com.tw (RMA Support)

Website: www.supermicro.com.tw

Table of Contents

Chapter 1 Introduction

1.1 Checklist.....	8
Quick Reference	11
Quick Reference Table.....	13
Motherboard Features.....	15
1.2 Processor and Chipset Overview.....	18
1.3 Special Features	18
Recovery from AC Power Loss.....	18
1.4 System Health Monitoring.....	19
Onboard Voltage Monitors	19
Fan Status Monitor with Firmware Control	19
Environmental Temperature Control	19
System Resource Alert.....	19
1.5 ACPI Features.....	19
1.6 Power Supply.....	20
1.7 Serial Port.....	20

Chapter 2 Installation

2.1 Static-Sensitive Devices.....	21
Precautions	21
Unpacking	21
2.2 Motherboard Installation.....	22
Tools Needed	22
Location of Mounting Holes	22
Installing the Motherboard.....	23
2.3 Memory Support and Installation	24
Memory Support.....	24
DDR4 Memory Support.....	24
General Guidelines for Optimizing Memory Performance	25
DIMM Installation	26
DIMM Removal	26

2.4 Rear I/O Ports	27
2.5 Front Control Panel	31
2.6 Connectors	36
Power Connections	36
Headers	37
2.7 Jumper Settings	47
How Jumpers Work	47
2.8 LED Indicators	53

Chapter 3 Troubleshooting

3.1 Troubleshooting Procedures	56
Before Power On	56
No Power	56
System Boot Failure	57
Memory Errors	57
Losing the System's Setup Configuration	57
When the System Becomes Unstable	58
3.2 Technical Support Procedures	60
3.3 Frequently Asked Questions	61
3.4 Battery Removal and Installation	62
Battery Removal	62
Proper Battery Disposal	62
Battery Installation	62
3.5 Returning Merchandise for Service	63

Chapter 4 UEFI BIOS

4.1 Introduction	64
4.2 Main Setup	65
4.3 Advanced	67
4.4 Event Logs	103
4.5 BMC	105
4.6 Security	108
4.7 Boot	112
4.8 Save & Exit	114

Appendix A BIOS Codes

Appendix B Software

Appendix C Standardized Warning Statements

Appendix D UEFI BIOS Recovery

Chapter 1

Introduction

Congratulations on purchasing your computer motherboard from an industry leader. Supermicro motherboards are designed to provide you with the highest standards in quality and performance.

In addition to the motherboard, several important parts that are included in the retail box are listed below. If anything listed is damaged or missing, contact your retailer.

1.1 Checklist

Main Parts List		
Description	Part Number	Quantity
Supermicro Motherboard	X12SDV-4C/8C/14C/16C/20C-SPT8F	1
I/O Shield	MCP-260-00098-0N	1
SATA Cables	CBL-0044L	2
COM Port Cable	CBL-CDAT-0605	1
OCuLink to four SATA Cable	CBL-SAST-0933	1
OCuLink to U.2 Cable	CBL-SAST-0956	1
Quick Reference Guide	MNL-2440-QRG	1

Important Links

For your system to work properly, please follow the links below to download all necessary drivers/utilities and the user's manual for your server.

- Supermicro product manuals: <http://www.supermicro.com/support/manuals/>
- Product drivers and utilities: <https://www.supermicro.com/wdl/driver/>
- Product safety info: http://www.supermicro.com/about/policies/safety_information.cfm
- Frequently Asked Questions: <https://www.supermicro.com/FAQ/index.php>
- A secure data deletion tool designed to fully erase all data from storage devices can be found at our website: https://www.supermicro.com/about/policies/disclaimer.cfm?url=/wdl/utility/Lot9_Secure_Data_Deletion_UTILITY/
- If you have any questions, contact our support team at: support@supermicro.com

This manual may be periodically updated without notice. Check the Supermicro website for possible updates to the manual revision level.

Figure 1-1. X12SDV-16C-SPT8F Motherboard Image

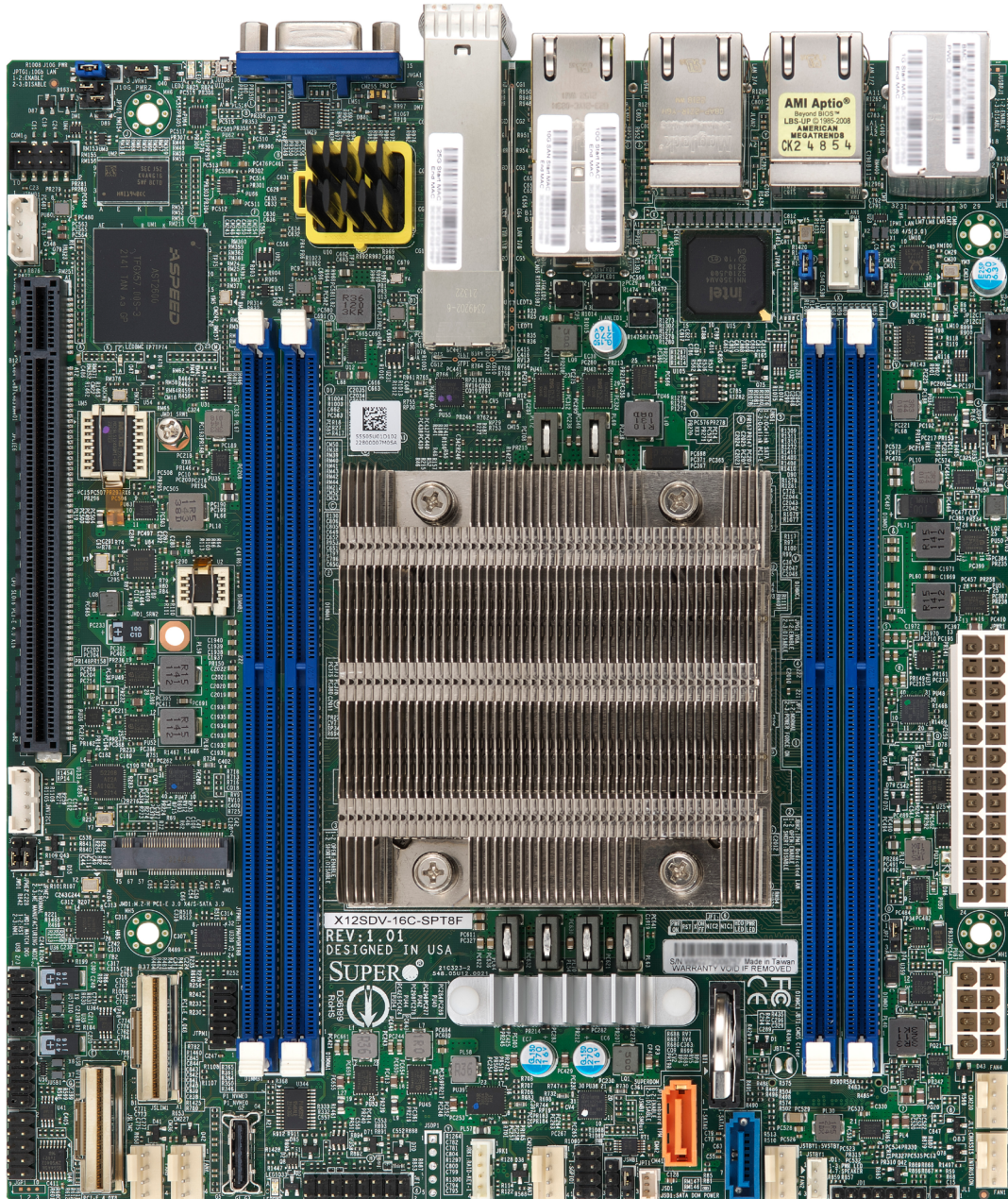

Note: All graphics shown in this manual were based upon the latest PCB revision available at the time of publication of the manual. The motherboard you received may or may not look exactly the same as the graphics shown in this manual.

Quick Reference

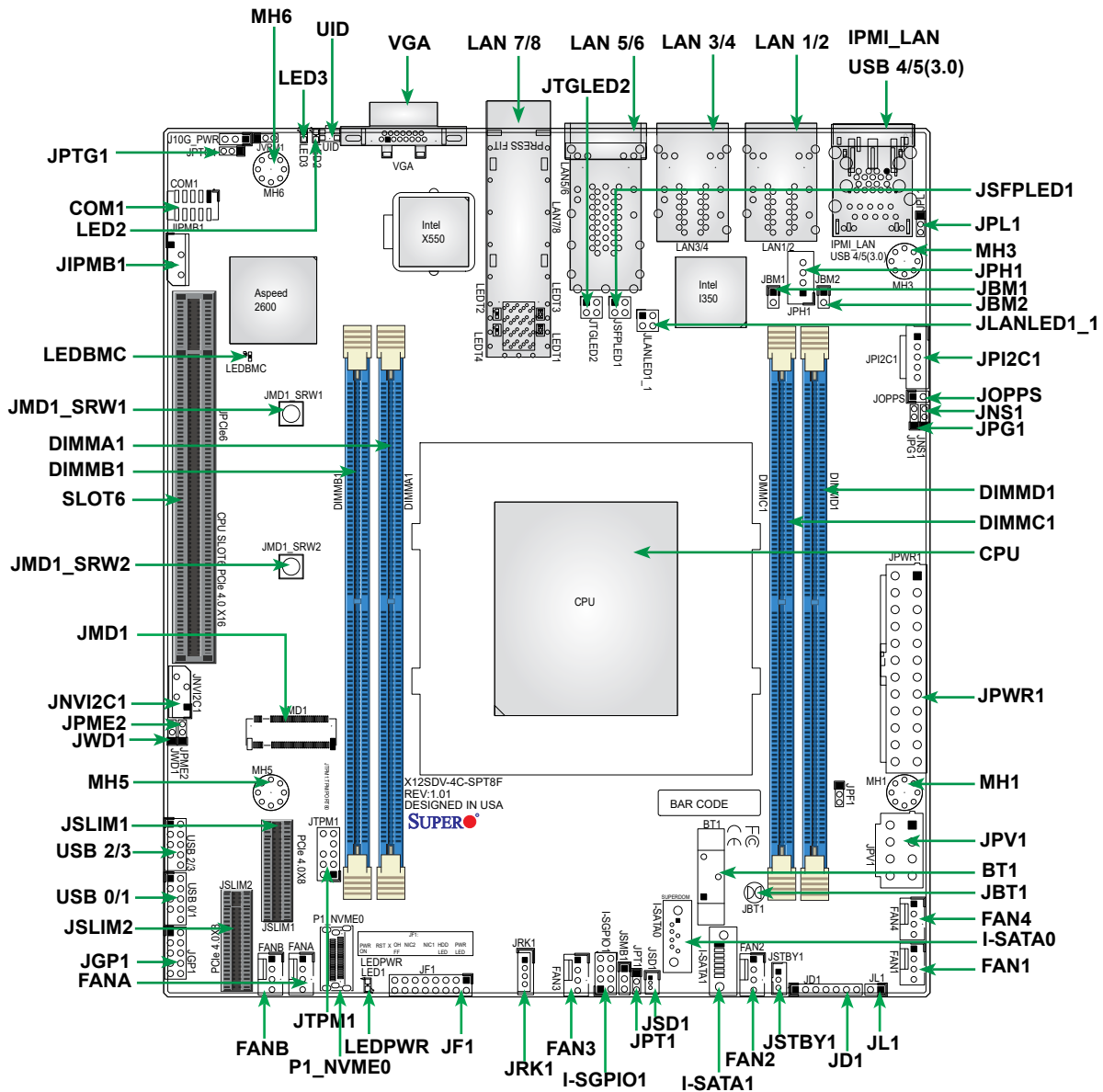

Notes:

- See [Chapter 2](#) for detailed information on jumpers, I/O ports, and JF1 front panel connections.
- "■" indicates the location of Pin 1.
- Jumpers/LED indicators not indicated are used for testing only.
- Use only the correct type of onboard CMOS battery as specified by the manufacturer. Do not install the onboard battery upside down to avoid possible explosion.

Figure 1-3. X12SDV-SPT8F Series Motherboard Model Variation Table

Motherboard Model Name	X12SDV-4C-SPT8F	X12SDV-8C-SPT8F	X12SDV-14C-SPT8F	X12SDV-16C-SPT8F	X12SDV-20C-SPT8F
Processor Name	D-2712T	D-2733NT	D-2766NT	D-2775TE	D-2796NT
Number of Cores	4	8	14	16	20
Cache	15 MB	15 MB	20 MB	25 MB	30 MB
SoC TDP	65 W	80 W	97 W	100 W	120 W
Processor Base Frequency	1.90 GHz	2.10 GHz	2.00 GHz	2.00 GHz	2.00 GHz
Intel® Turbo Boost Technology	Yes	Yes	Yes	Yes	Yes
Number of Memory Channels	4	4	4	4	4
Max. DDR Frequency	2667 MT/s	2667 MT/s	2667 MT/s	2933 MT/s	2933 MT/s
Intel® QuickAssist Technology	No	Yes	Yes	No	Yes
Intel® Virtualization Technology (VT-x)	Yes	Yes	Yes	Yes	Yes
Intel® Virtualization Technology for Directed I/O (VT-d)	Yes	Yes	Yes	Yes	Yes
CPU Heatsink with FAN	No	No	No	No	No



Note: For better compatibility with the motherboard, it is recommended to use 5VSB 4A or more for the ATX power supply.

Quick Reference Table

Jumper	Description	Default Setting
JBM1	IPMI Share LAN Enable/Disable	Pins 1-2 Open (Enabled)
JBM2	IPMI Dedicated LAN Enable/Disable	Pins 1-2 Open (Enabled)
JBT1	CMOS Clear	Open (Normal)
JNS1	OCuLink to SATA3.0 or PCIe 3.0 Selection	Pins 2-3 (PCIe x4)
JPG1	VGA Enable/Disable	Pins 1-2 (Enabled)
JPL1	LAN1 - LAN4 Enable/Disable	Pins 1-2 (Enabled)
JPME2	ME Manufacturing Mode	Pins 1-2 (Normal)
JPT1	Onboard TPM Enable/Disable	Pins 1-2 (Enabled)
JPTG1	LAN5/6 (10GbE) Enable/Disable	Pins 1-2 (Enabled)
JWD1	Watch Dog Timer	Pins 1-2 (Reset)
LED	Description	Status
LED2	UID LED	Solid Blue: Unit Identified
LED3	Overheat (OH)/Power Fail/Fan Fail LED	Solid Red: Overheat Blinking Red: Power fail or Fan fail
LEDBMC	BMC Heartbeat	Blinking Green: BMC Normal
LEDPWR	Onboard Power LED	Solid Green: Power On
Connector	Description	
BT1	Onboard Battery	
COM1	COM Header	
FAN1–FAN4, FANA, FANB	CPU/System Fan Headers	
IPMI LAN	Dedicated IPMI LAN Port	
I-SATA0, I-SATA1	Intel PCH SATA 3.0 Ports (I-SATA0 has built-in SATA DOM Power on Pin 8)	
I-SGPIO1	Serial Link General Purpose I/O Header	
JD1	Speaker/Power LED Indicator (Pins 1-3: Power LED, Pins 4-7: Speaker)	
JF1	Front Control Panel Header	
JGP1	General Purpose I/O Header	
JIPMB1	System Management Bus Header (for IPMI only)	
JL1	Chassis Intrusion Header	
JLANLED1_1	LAN3/4 Activity LED Header	
JMD1	M.2 M-Key 2242/2280 (PCIe x4/SATA) Slot	
JMD1_SRW1, JMD1_SRW2	M.2 Holding Screws	
JNVI ² C1	Non-Volatile Memory (NVMe) I ² C Header	
JOPPS	Reserved for One Pulse Per Second	
JPH1	4-pin HDD Power Connector	
JPI ² C1	Power I ² C System Management Bus (Power SMB) Header	



Note: Table is continued on the next page.

Connector	Description
JPWR1	24-pin ATX Power Connector (Required)
JPV1	8-pin CPU Power Connector (Required)
JRK1	Intel RAID Key Header
JSD1	SATA DOM Power Connectors
JSFPLED1	LAN7/8 Activity LED Header
JSLIM1, JSLIM2	PCIe 4.0 x8 SlimSAS Connector
JSTBY1	Standby Power Header
JTGLED2	LAN5/6 Activity LED Header
JTPM1	Trusted Platform Module/Port 80 Connector
LAN1/2, LAN3/4	1GbE RJ45 LAN Ports
LAN5/6	10G Base-T RJ45 LAN Ports
LAN7/8	25G SFP28 LAN Ports
P1_NVME0	OCuLink Connector (to 4x SATA 3.0 or PCIe 3.0 x4)
SLOT6	CPU1 PCIe 4.0 x16 Slot
UID	Unit Identifier Switch
USB0/1, USB2/3	Front Accessible USB 2.0 Headers
USB4/5	Back Panel USB 3.0 Ports
VGA	VGA Port

Motherboard Features

Motherboard Features	
CPU	<ul style="list-style-type: none"> Supports an Intel Xeon D-2700 series processor with up to 20 cores and a thermal design power (TDP) of 65 W–120 W
Memory	<ul style="list-style-type: none"> Up to 256 GB of ECC RDIMM or up to 512 GB LRDIMM DDR4 memory with speeds of up to 2933 MT/s in four memory slots
DIMM Size	<ul style="list-style-type: none"> Up to 128 GB <p> Note: For the latest CPU/memory updates, refer to our website at http://www.supermicro.com/products/motherboard.</p>
Expansion Slots	<ul style="list-style-type: none"> One PCIe 4.0 x16 Slot (Slot 6) One M.2 M-Key 2242/2280 (SATA 3.0/PCIe 3.0 x4) Slot Two PCIe 4.0 x8 SlimSAS Connectors One OCuLink Connector (to four SATA 3.0/PCIe 3.0 x4)
Baseboard Management Controller	<ul style="list-style-type: none"> Aspeed AST2600
Network	<ul style="list-style-type: none"> Intel i350 Ethernet Controller Intel X550 10G Ethernet Controller 25G Ethernet Controller One Dedicated IPMI LAN located on the rear I/O panel
Graphics	<ul style="list-style-type: none"> Aspeed AST2600
I/O Devices	<ul style="list-style-type: none"> VGA Port: One VGA port on the rear I/O panel Serial (COM) Port: One serial port header (COM1) SATA 3.0 Ports: Two SATA 3.0 ports (I-SATA0, I-SATA1)
Peripheral Devices	<ul style="list-style-type: none"> Two front accessible USB 2.0 headers with two USB connections (USB0/1, USB2/3) Two USB 3.0 ports on the rear I/O panel (USB4/5)
BIOS	<ul style="list-style-type: none"> 256 Mb SPI AMI® BIOS Riser Card Auto Detection Support Real Time Clock (RTC) wakeup



Note: The table above is continued on the next page.

Motherboard Features	
Power Management	
<ul style="list-style-type: none"> • ACPI power management • Power button override mechanism • Power-on mode for AC power recovery • Wake-On-LAN 	
System Health Monitoring	
<ul style="list-style-type: none"> • Onboard voltage monitoring for +3.3 V, +5 V, +12V, +3.3 VStby, +5 Vstby, Vcore, Vmem, CPU temperature, peripheral temperature, system temperature, memory temperature, and NVMe temperature • CPU thermal trip support • Platform Environment Control Interface (PECI)/TSI 	
Fan Control	
<ul style="list-style-type: none"> • Fan speed control • Six 4-pin fan headers • Dual cooling zone 	
System Management	
<ul style="list-style-type: none"> • Trusted Platform Module (TPM) support • SuperDoctor® 5 • Chassis intrusion header and detection 	
LED Indicators	
<ul style="list-style-type: none"> • Overheat/Fan Fail/PWR Fail LED • Power Indicator LED • UID LED • LAN activity LED 	
Dimensions	
<ul style="list-style-type: none"> • 7.5" (W) x 8.5" (L) ATX (190.5 mm x 215.9 mm) 	

 **Note 1:** The CPU maximum thermal design power (TDP) is subject to chassis and heatsink cooling restrictions. For proper thermal management, check the chassis and heatsink specifications for proper CPU TDP sizing.

 **Note 2:** For IPMI configuration instructions, refer to the Embedded IPMI Configuration User's Guide available at <http://www.supermicro.com/support/manuals/>.

Figure 1-3.
System Block Diagram



Note: This is a general block diagram and may not exactly represent the features on your motherboard. See the previous pages for the actual specifications of your motherboard.

1.2 Processor and Chipset Overview

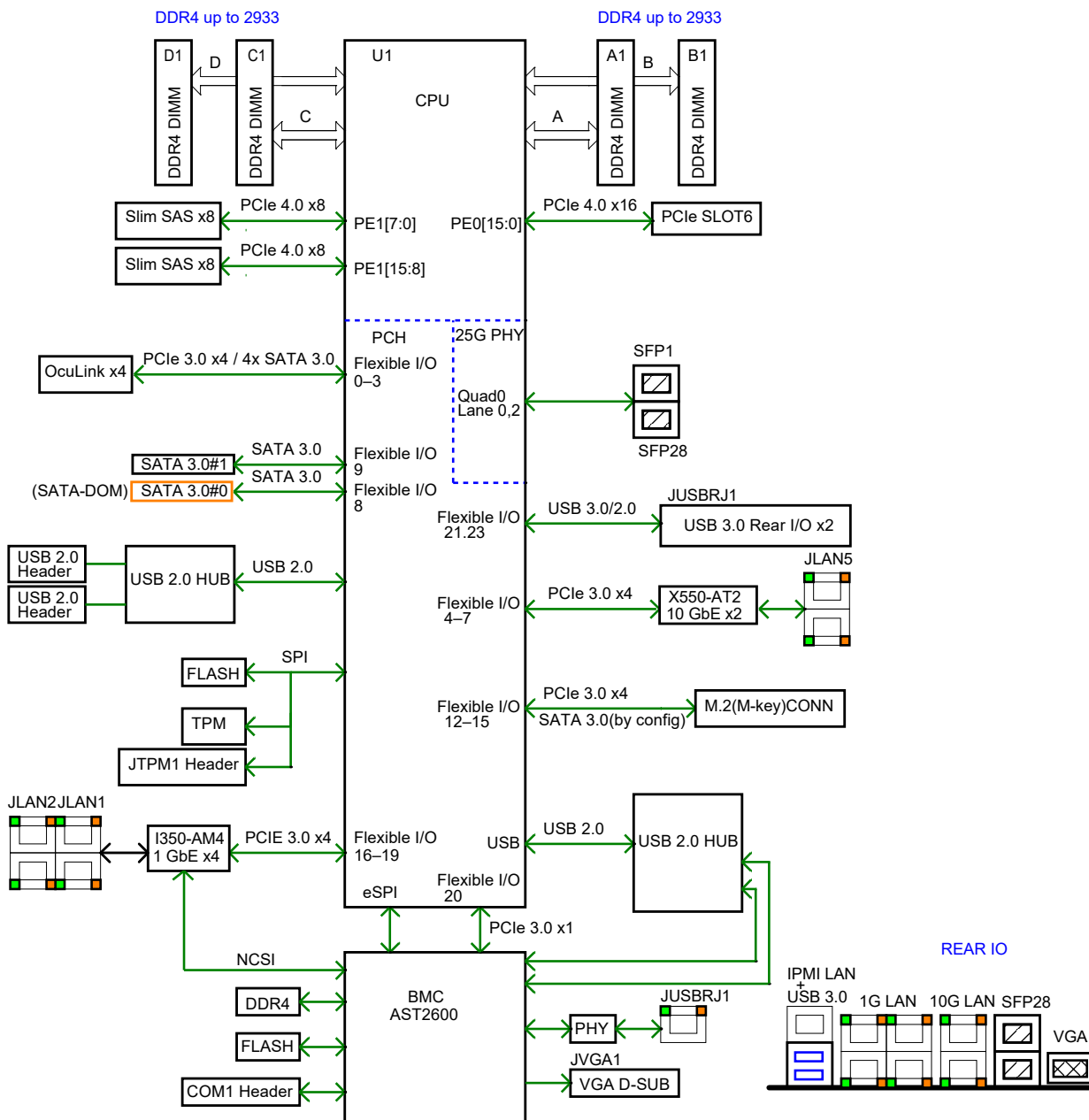
Built upon the functionality and capability of the Intel Xeon D-2700 SoC Processor, the X12SDV-4C/8C/14C/16C/20C-SPT8F motherboard provides system performance, power efficiency, and feature sets to address the needs of next-generation computer users.

The X12SDV-4C/8C/14C/16C/20C-SPT8F dramatically increases system performance for a multitude of server applications and supports:

- Intel Volume Management Device (VMD) 2.0
- Intel Deep Learning Boost (Intel DL Boost) with AVX-512, VNNI
- PCIe 4.0, USB 3.0, SATA 3.0, OCuLink
- 10/25G Ethernet LAN
- Intel Hyper-Threading, Intel VT-D, VT-x
- TSX-NI, AES, SGX
- Intel Turbo Boost Technology
- Up to 256 GB ECC RDIMM or 512 GB LRDIMM DDR4 memory with speeds of up to 2933 MT/s



Note: Node Manager support depends on the power supply used in your system.

1.3 Special Features

Recovery from AC Power Loss

The Basic I/O System (BIOS) provides a setting that determines how the system will respond when AC power is lost and then restored to the system. You can choose for the system to remain powered off (in which case you must press the power switch to turn it back on), or for it to automatically return to the power-on state. See the Advanced BIOS Setup section for this setting. The default setting is **Last State**.

1.4 System Health Monitoring

Onboard Voltage Monitors

An onboard voltage monitor will scan the voltages of the onboard chipset, memory, CPU, and battery continuously. Once a voltage becomes unstable, a warning is given, or an error message is sent to the screen. The user can adjust the voltage thresholds to define the sensitivity of the voltage monitor.

Fan Status Monitor with Firmware Control

The system health monitor embedded in the BMC chip can check the RPM status of the cooling fans. The CPU and chassis fans are controlled via IPMI.

Environmental Temperature Control

System Health sensors monitor temperatures and voltage settings of onboard processors and the system in real time via the IPMI interface. Whenever the temperature of the CPU or the system exceeds a user-defined threshold, system/CPU cooling fans will be turned on to prevent the CPU or the system from overheating.

 **Note:** To avoid possible system overheating, be sure to provide adequate airflow to your system.

System Resource Alert

This feature is available when used with SuperDoctor 5[®] in the Windows OS or in the Linux environment. SuperDoctor is used to notify the user of certain system events. For example, you can configure SuperDoctor to provide you with warnings when the system temperature, CPU temperatures, voltages and fan speeds go beyond a predefined range.

1.5 ACPI Features

The Advanced Configuration and Power Interface (ACPI) specification defines a flexible and abstract hardware interface that provides a standard way to integrate power management features throughout a computer system, including its hardware, operating system and application software. This enables the system to automatically turn on and off peripherals such as CD-ROMs, network cards, hard disk drives and printers.

In addition to enabling operating system-directed power management, ACPI also provides a generic system event mechanism for Plug and Play, and an operating system-independent interface for configuration control. ACPI leverages the Plug and Play BIOS data structures, while providing a processor architecture-independent implementation that is compatible with appropriate Windows operating systems. For detailed information regarding OS support, refer to the Supermicro website.

1.6 Power Supply

As with all computer products, a stable power source is necessary for proper and reliable operation. It is even more important for processors that have high CPU clock rates where noisy power transmission is present.

The X12SDV-4C/8C/14C/16C/20C-SPT8F motherboard accommodates a 24-pin ATX power supply. Although most power supplies generally meet the specifications required by the CPU, some are inadequate. In addition, one 12 V 8-pin power connection is also required to ensure adequate power supply to the system.

Warning: To avoid damaging the power supply or the motherboard, be sure to use a power supply that contains a 24-pin and an 8-pin power connector. Be sure to connect the power supplies to the 24-pin power connector (JPWR1), and the 8-pin power connector (JPV1) on the motherboard. Failure in doing so may void the manufacturer warranty on your power supply and motherboard.

 **Note:** The X12SDV-4C/8C/14C/16C/20C-SPT8F motherboard alternatively supports an 8-pin 12 V DC input power supply for embedded applications. The 12 V DC input is limited to a 36 A design. It provides up to 432 W power input to the motherboard. Keep onboard power use within the power limits specified above. Over current DC power use may cause damage to the motherboard.

It is strongly recommended that you use a high quality power supply that meets ATX power supply Specification 2.02 or above.

1.7 Serial Port

The X12SDV-4C/8C/14C/16C/20C-SPT8F motherboard supports one serial communication connection. COM1 can be used for input/output. The UART provides legacy speeds with a baud rate of up to 115.2 Kbps as well as an advanced speed with baud rates of 250 K, 500 K, or 1 Mb/s, which support high-speed serial communication devices.

Chapter 2

Installation

2.1 Static-Sensitive Devices

Electrostatic Discharge (ESD) can damage electronic components. To avoid damaging your system board, it is important to handle it very carefully. The following measures are generally sufficient to protect your equipment from ESD.

Precautions

- Use a grounded wrist strap designed to prevent static discharge.
- Touch a grounded metal object before removing the board from the antistatic bag.
- Handle the motherboard by its edges only; do not touch its components, peripheral chips, memory modules or gold contacts.
- When handling chips or modules, avoid touching their pins.
- Put the motherboard and peripherals back into their antistatic bags when not in use.
- For grounding purposes, make sure that your computer chassis provides excellent conductivity between the power supply, the case, the mounting fasteners and the motherboard.
- Use only the correct type of onboard CMOS battery. Do not install the onboard battery upside down to avoid possible explosion.

Unpacking

The motherboard is shipped in antistatic packaging to avoid static damage. When unpacking the motherboard, make sure that the person handling it is static protected.

2.2 Motherboard Installation

All motherboards have standard mounting holes to fit different types of chassis. Make sure that the locations of all the mounting holes for both the motherboard and the chassis match. Although a chassis may have both plastic and metal mounting fasteners, metal ones are highly recommended because they ground the motherboard to the chassis. Make sure that the metal standoffs click in or are screwed in tightly.

Tools Needed

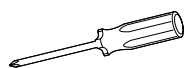

**Phillips
Screwdriver
(1)**



**Phillips Screws
(4)**



**Standoffs (4)
Only if Needed**

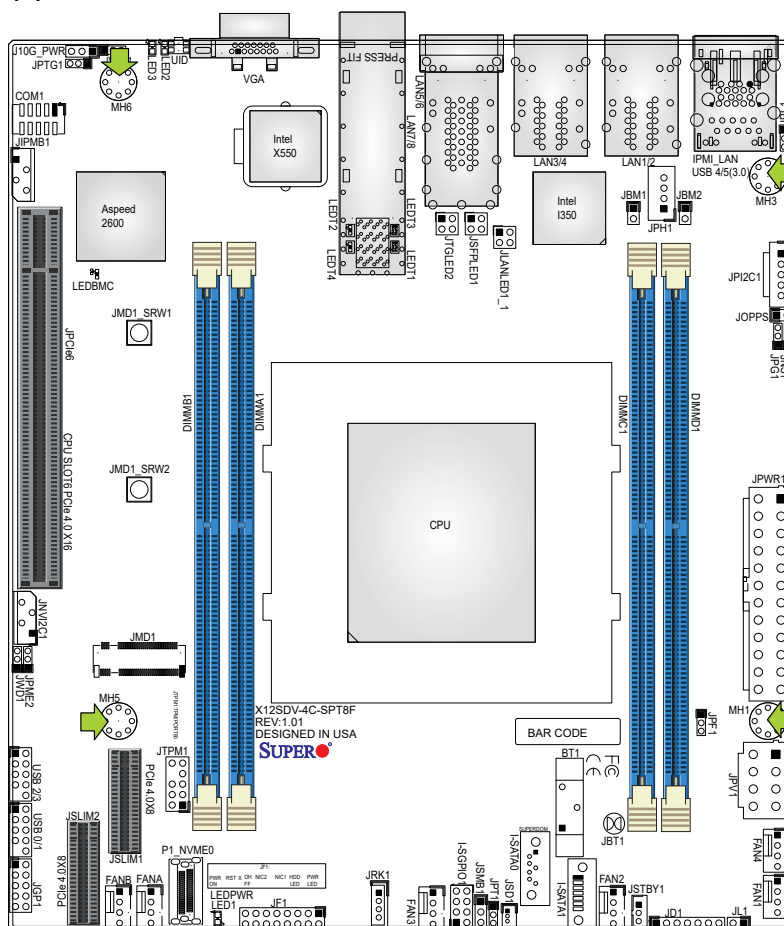

Location of Mounting Holes



Note 1: To avoid damaging the motherboard and its components, do not use a force greater than 8 lbf-in on each mounting screw during motherboard installation.



Note 2: Some components are very close to the mounting holes. Take precautionary measures to avoid damaging these components when installing the motherboard to the chassis.

Installing the Motherboard

1. Install the I/O shield into the back of the chassis, if applicable.

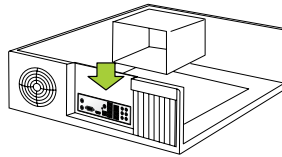

2. Locate the mounting holes on the motherboard. See the previous page for the location.

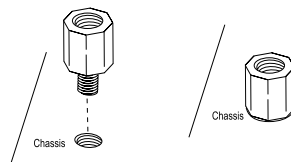

3. Locate the matching mounting holes on the chassis. Align the mounting holes on the motherboard against the mounting holes on the chassis.

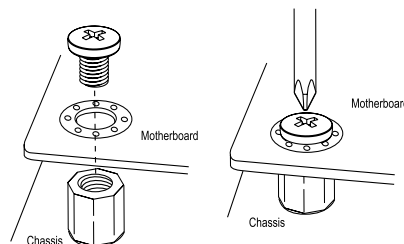

4. Install standoffs in the chassis as needed.
5. Install the motherboard into the chassis carefully to avoid damaging other motherboard components.
6. Using the Phillips screwdriver, insert a pan head #6 screw into a mounting hole on the motherboard and its matching mounting hole on the chassis.
7. Repeat Step 6 to insert #6 screws into all mounting holes.
8. Make sure that the motherboard is securely placed in the chassis.

 **Note:** Images displayed are for illustration only. Your chassis or components might look different from those shown in this manual.

2.3 Memory Support and Installation



Note: Check the Supermicro website for recommended memory modules.



Important: Exercise extreme care when installing or removing DIMM modules to prevent any possible damage.

Memory Support

The X12SDV-4C/8C/14C/16C/20C-SPT8F supports up to up to 256 GB ECC RDIMM or 512 GB LRDIMM DDR4 memory with speeds of up to 2933 MT/s in four memory slots. Refer to the table below for the recommended DIMM population order.

1 CPU, 4 DIMM Slots	
Number of DIMMs	Memory Population Sequence
1	DIMMA1
2	DIMMA1 / DIMMC1
4	DIMMA1 / DIMMB1 / DIMMC1 / DIMMD1

DDR4 Memory Support

Type	Ranks Per DIMM and Data Width	DIMM Capacity (GB)		Speed (MT/s); Voltage (V); Slot Per Channel (SPC) and DIMM Per Channel (DPC) *Data below assumes 2 SPC unless otherwise noted.
		8 Gb	16 Gb	1DPC 1.2V
RDIMM	SRx8	8 GB	16 GB	2933
	SRx4	16 GB	32 GB	
	DRx8	16 GB	32 GB	
	DRx4	32GB	64 GB	
LRDIMM	QRx4	64 GB	128 GB	2933

General Guidelines for Optimizing Memory Performance

- It is recommended to use DDR4 memory of the same type, size, and speed.
- Mixed DIMM speeds can be installed. However, all DIMMs will run at the speed of the slowest DIMM.
- To achieve the best memory performance, a balanced memory population is recommended.

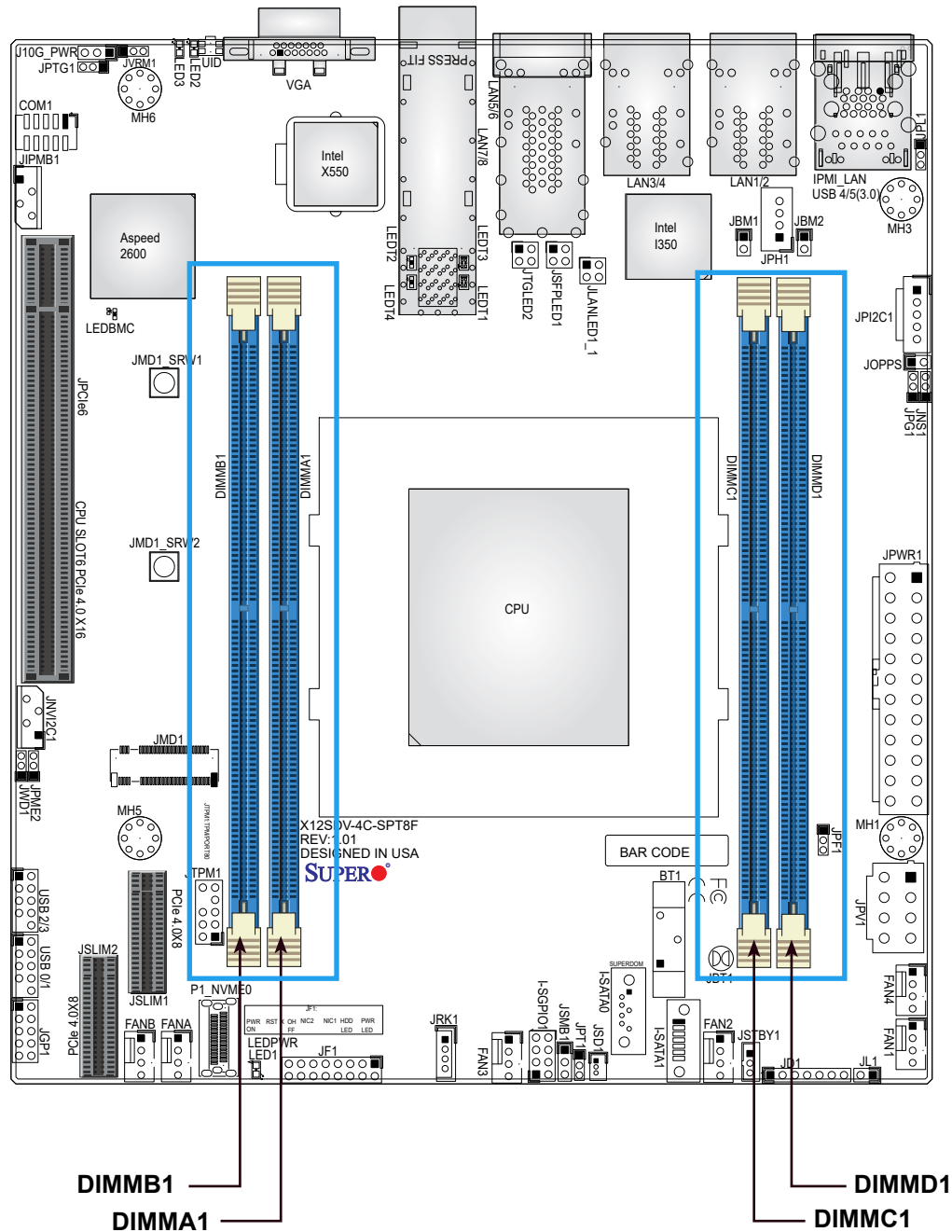

DIMM Installation

1. Insert DIMM modules in the following order: DIMMA1, DIMMC1, DIMMB1, DIMMD1 and insert the desired number of DIMMs into the memory slots based on the Recommended Memory Population Guide table on page 24.
2. Push the release tabs outwards on both ends of the DIMM slot to unlock it.
3. Align the key of the DIMM module with the receptive point on the memory slot.
4. Align the notches on both ends of the module against the receptive points on the ends of the slot.
5. Push both ends of the module straight down into the slot until the module snaps into place.
6. Press the release tabs to the lock positions to secure the DIMM module into the slot.

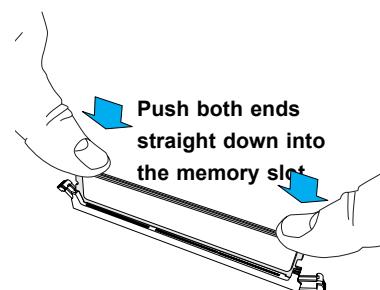
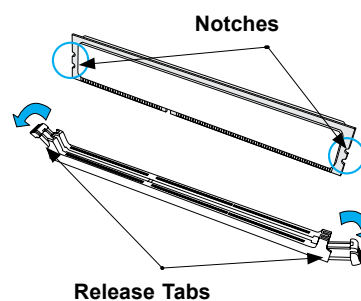
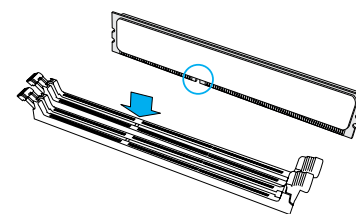
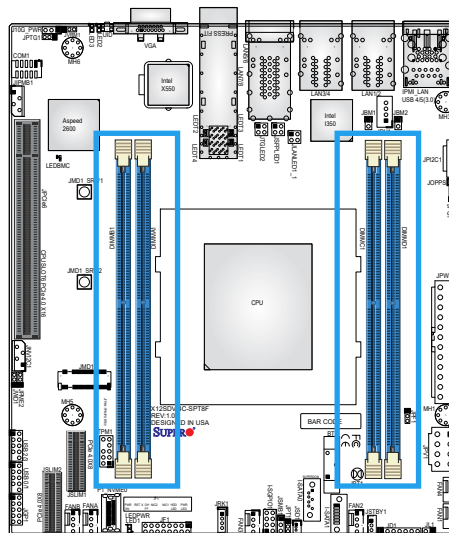

DIMM Removal

Press both release tabs on the ends of the DIMM module to unlock it. Once the DIMM module is loosened, remove it from the memory slot.

2.4 Rear I/O Ports

See Figure 2-1 below for the locations and descriptions of the various I/O ports on the rear of the motherboard.

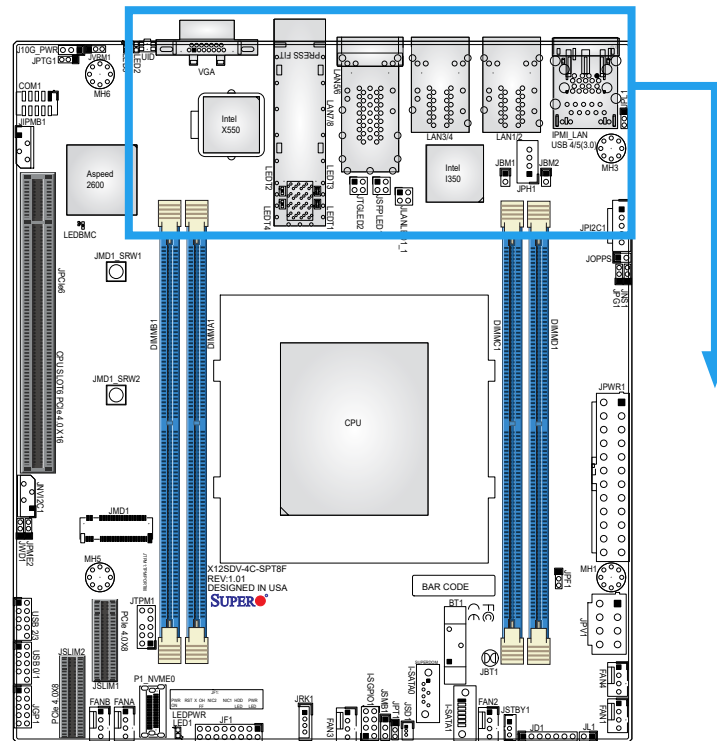
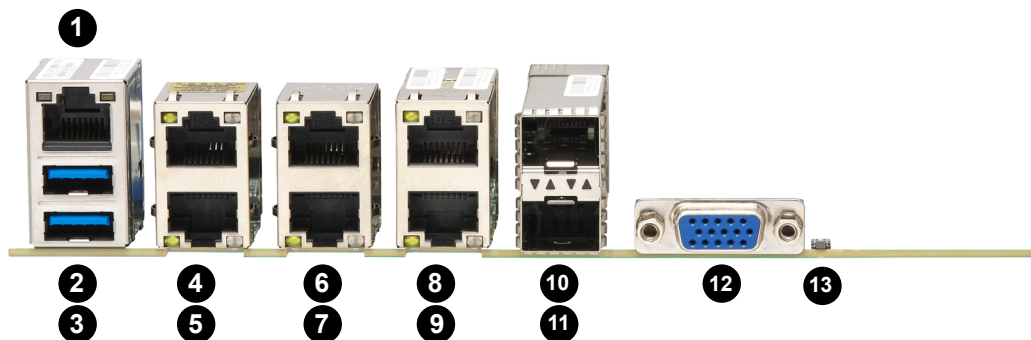

Figure 2-1. I/O Port Locations and Definitions



Rear I/O Ports					
#	Description	#	Description	#	Description
1	IPMI LAN	5	LAN1	9	LAN5
2	USB5	6	LAN4	10	SFP28 LAN8
3	USB4	7	LAN3	11	SFP28 LAN7
4	LAN2	8	LAN6	12	VGA Port
				13	UID Switch

LAN Ports

The motherboard has four 1GbE LAN ports (LAN1/2, LAN3/4), two 10GbE LAN ports (LAN5/6) and two 25G SFP28 LAN ports (LAN7/8) located on the I/O back panel. The four 1GbE LAN ports and two 10GbE LAN ports accept RJ45 cables. In addition to the LAN ports, there is one dedicated IPMI LAN port. Refer to the LED Indicator section for LAN LED information.



Note: LAN5 and LAN6 ports (10G LAN) do not support wake-on-LAN.

VGA Port

A video (VGA) port is located on the I/O back panel. Refer to the board layout below for the location.

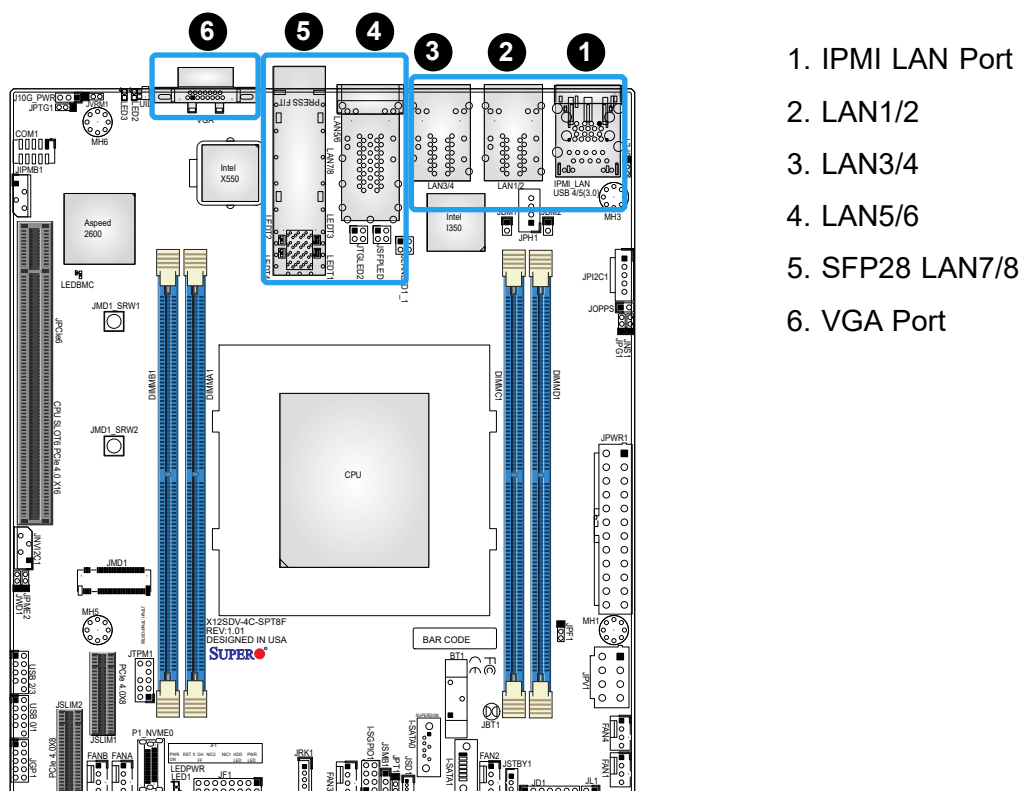

Unit Identifier Switch/UID LED Indicator

A Unit Identifier (UID) switch and an LED Indicator are located on the motherboard. The UID switch is located at JUIDB1, which is next to the VGA port on the back panel. The UID LED (LED2) is located next to the UID switch. When you press the UID switch, the UID LED will be turned on. Press the UID switch again to turn off the LED indicator. The UID Indicator provides easy identification of a system unit that may be in need of service.

 **Note:** UID can also be triggered via IPMI on the motherboard. For more information on IPMI, please refer to the IPMI User's Guide posted on our website at <https://www.supermicro.com/support/manuals/>.

UID Switch Pin Definitions	
Pin#	Definition
1	Ground
2	Ground
3	Button in
4	Button in

UID LED Pin Definitions	
Color	Status
Blue: On	Unit Identified

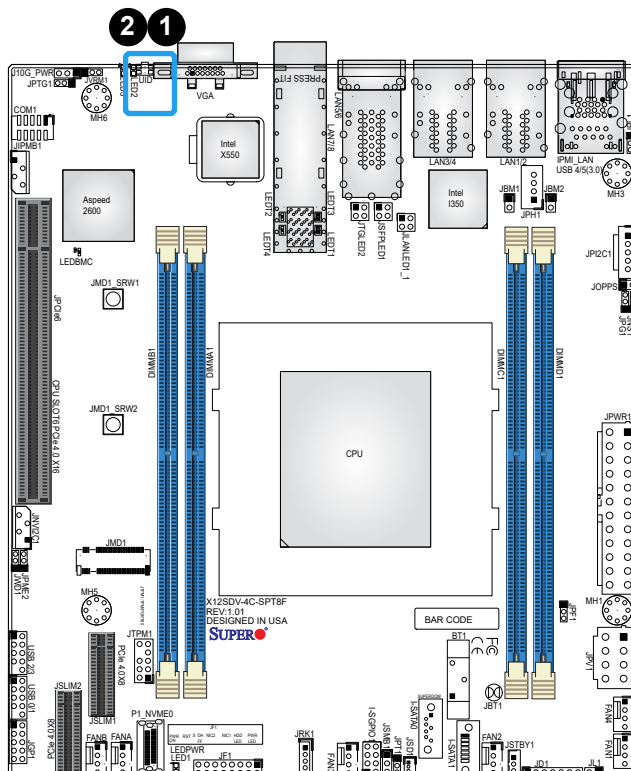

1. UID Switch

2. LED2

Universal Serial Bus (USB) Ports

There are two USB 3.0 ports (USB4/5) on the I/O back panel and two USB 2.0 headers (USB0/1 and USB2/3) on the motherboard. The onboard headers can be used to provide front side USB access with a cable (not included).

Front Panel USB0/1, 2/3 (2.0) Headers Pin Definitions			
Pin#	Definition	Pin#	Definition
1	+5 V	2	+5 V
3	USB_N	4	USB_N
5	USB_P	6	USB_P
7	Ground	8	Ground
9	Key	10	NC

Back Panel USB4/5 (3.0) Pin Definitions			
Pin#	Definition	Pin#	Definition
A1	VBUS	B1	Power
A2	D-	B2	USB_N
A3	D+	B3	USB_P
A4	GND	B4	GND
A5	Stda_SSRX-	B5	USB3_RN
A6	Stda_SSRX+	B6	USB3_RP
A7	GND	B7	GND
A8	Stda_SSTX-	B8	USB3_TN
A9	Stda_SSTX+	B9	USB3_TP

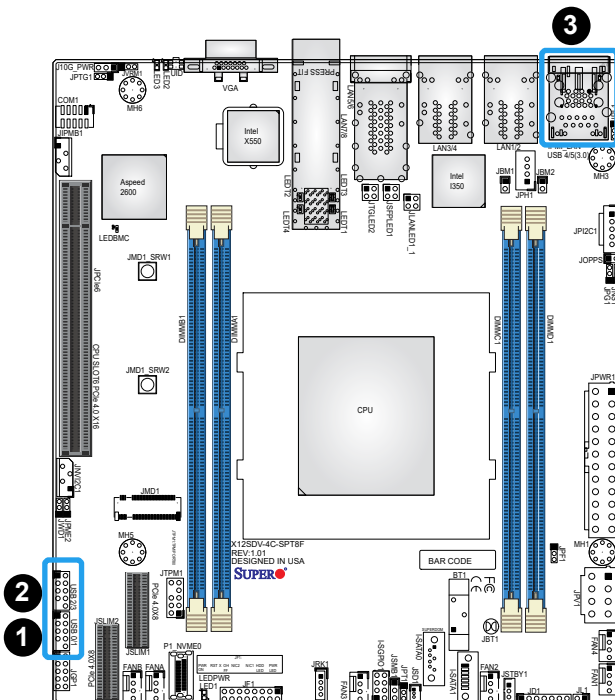

1. USB0/1
2. USB2/3
3. USB4/5

2.5 Front Control Panel

JF1 contains header pins for various buttons and indicators that are normally located on a control panel at the front of the chassis. These connectors are designed specifically for use with a Supermicro chassis. See the figure below for the descriptions of the front control panel buttons and LED indicators.

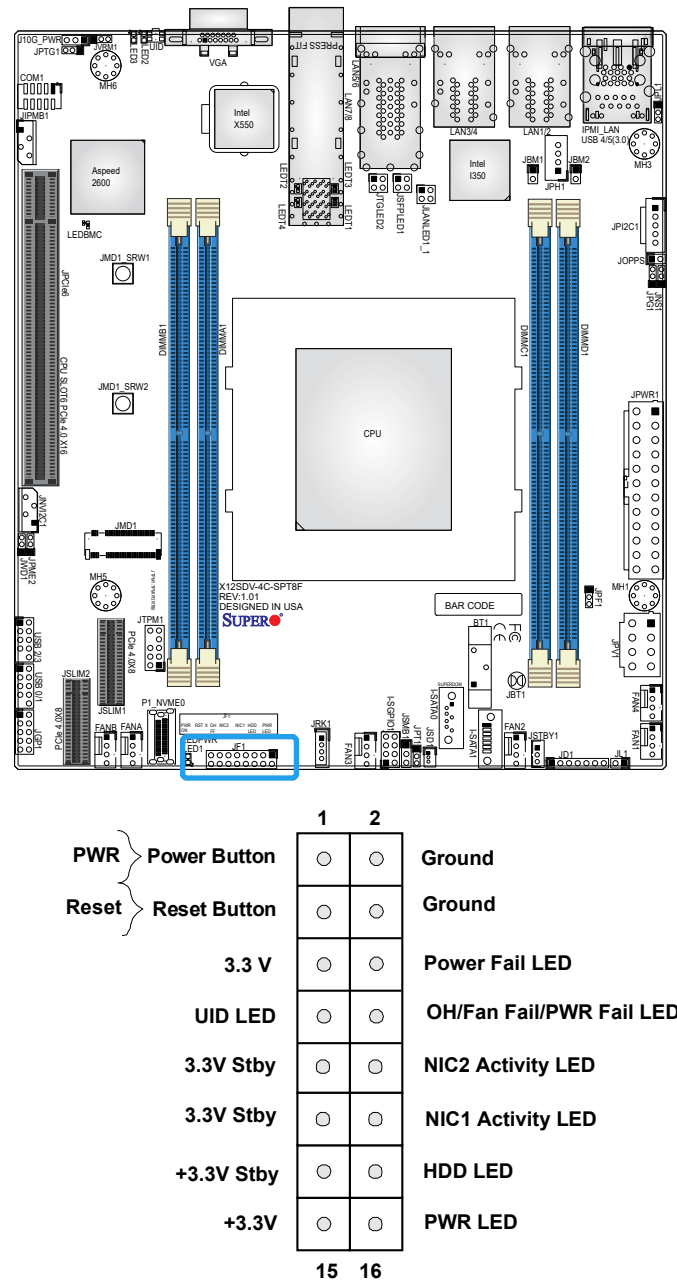

Figure 2-2. JF1 Header Pins

Power Button

The Power Button connection is located on pins 1 and 2 of JF1. Momentarily contacting both pins will power on/off the system. This button can also be configured to function as a suspend button (with a setting in the BIOS - see Chapter 4). To turn off the power when the system is in suspend mode, press the button for 4 seconds or longer. Refer to the table below for pin definitions.

Power Button	
Pin Definitions (JF1)	
Pin#	Definition
1	Signal
2	Ground

Reset Button

The Reset Button connection is located on pins 3 and 4 of JF1. Attach it to a hardware reset switch on the computer case to reset the system. Refer to the table below for pin definitions.

Reset Button	
Pin Definitions (JF1)	
Pin#	Definition
3	Reset
4	Ground

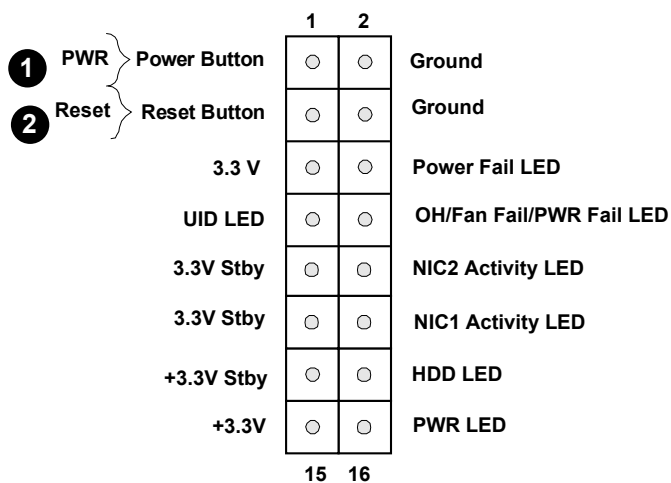

1. PWR Button
2. Reset Button

Power Fail LED

Connect an LED cable to Power Fail connections on pins 5 and 6 of JF1 to provide warnings for a power failure. Refer to the table below for pin definitions.

Power Fail LED Pin Definitions (JF1)	
Pin#	Definition
5	3.3 V
6	PWR Fail LED

Overheat (OH)/Fan Fail/PWR Fail LED

Connect an LED cable to pins 7 and 8 of the Front Control Panel to use the Overheat/Fan Fail LED connections. The LED on pin 8 provides warnings of overheating or fan failure. Refer to the tables below for pin definitions.

OH/Fan Fail/PWR Fail Indicator Status	
State	Definition
Off	Normal
On	Overheat
Flashing	Fan Fail/PWR Fail

OH/Fan Fail/PWR Fail LED Pin Definitions (JF1)	
Pin#	Definition
7	Blue UID LED
8	OH/Fan Fail/PWR Fail LED

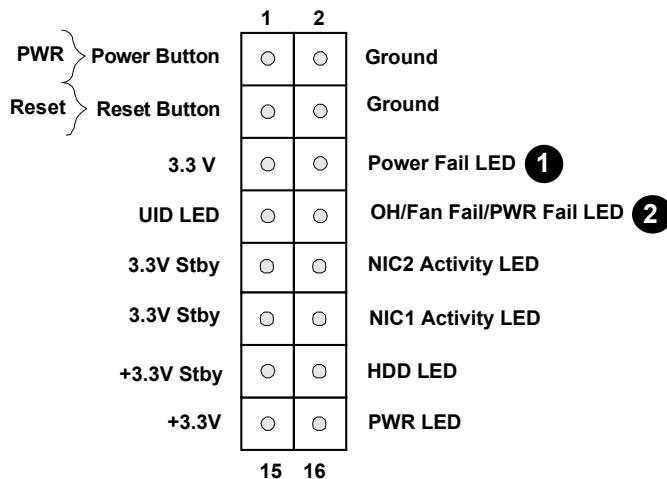

1. Power Fail LED
2. OH/Fan Fail/PWR Fail LED

NIC1/NIC2 (LAN1/LAN2)

The NIC (Network Interface Controller) LED connection for LAN port 1 is located on pins 11 and 12 of JF1, and LAN port 2 is on pins 9 and 10. Attach the NIC LED cables here to display network activity. Refer to the table below for pin definitions.

LAN1/LAN2 LED Pin Definitions (JF1)	
Pin#	Definition
9	3.3 Stby
10	NIC 2 Activity LED
11	3.3 Stby
12	NIC 1 Activity LED

HDD LED

The HDD LED connection is located on pins 13 and 14 of JF1. Attach a cable to pin 14 to show hard drive activity status. Refer to the table below for pin definitions.

HDD LED Pin Definitions (JF1)	
Pins	Definition
13	3.3 V Stby
14	HDD Active

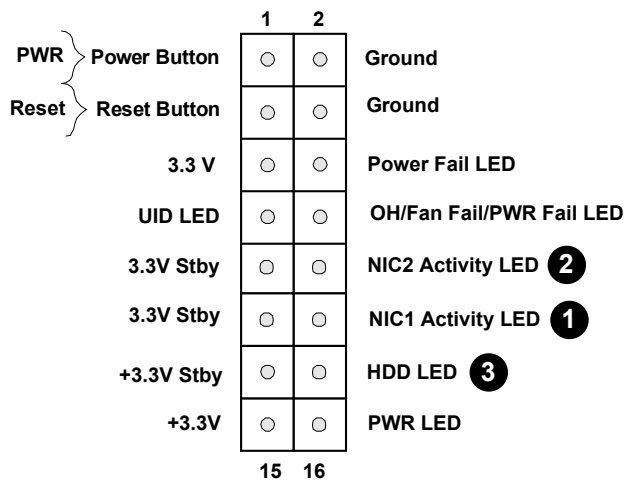

1. NIC1 Activity LED
2. NIC2 Activity LED
3. HDD LED

Power LED

The Power LED connection is located on pins 15 and 16 of JF1. Refer to the table below for pin definitions.

Power LED Pin Definitions (JF1)	
Pins	Definition
15	+3.3 V Stby
16	PWR LED

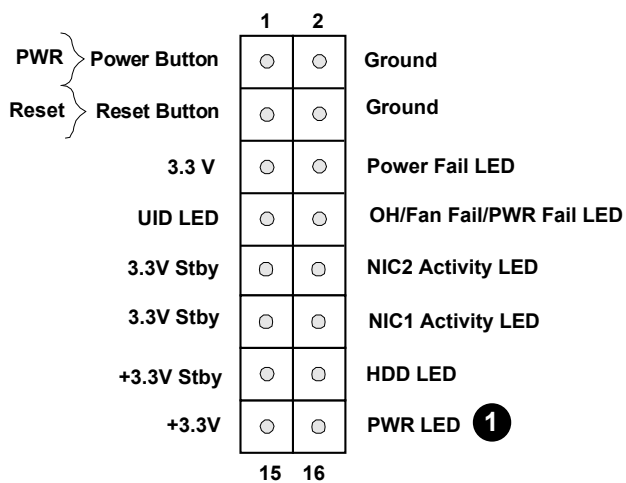

1. Power LED

2.6 Connectors

Power Connections

Power Connectors

JPWR1 is the 24-pin power connector for ATX power source. JPV1 is the 12V DC power connector that provides power to the CPU in conjunction with JPWR1 or it can be used as the sole 12V DC only power input when JPWR1 is not in use. JPH1 is a 4-pin HDD power connector that provides power to onboard HDD devices.

ATX Power 24-pin Connector Pin Definitions			
Pin#	Definition	Pin#	Definition
13	+3.3 V	1	+3.3 V
14	-12 V	2	+3.3 V
15	Ground	3	Ground
16	PS_ON	4	+5 V
17	Ground	5	Ground
18	Ground	6	+5 V
19	Ground	7	Ground
20	Res (NC)	8	PWR_OK
21	+5 V	9	5 VSB
22	+5 V	10	+12 V
23	+5 V	11	+12 V
24	Ground	12	+3.3 V

8-pin CPU Power Pin Definitions	
Pin#	Definition
1-4	GND
5-8	12 V

4-pin HDD Power Pin Definitions	
Pin#	Definition
1	12 V
2-3	Ground
4	5 V

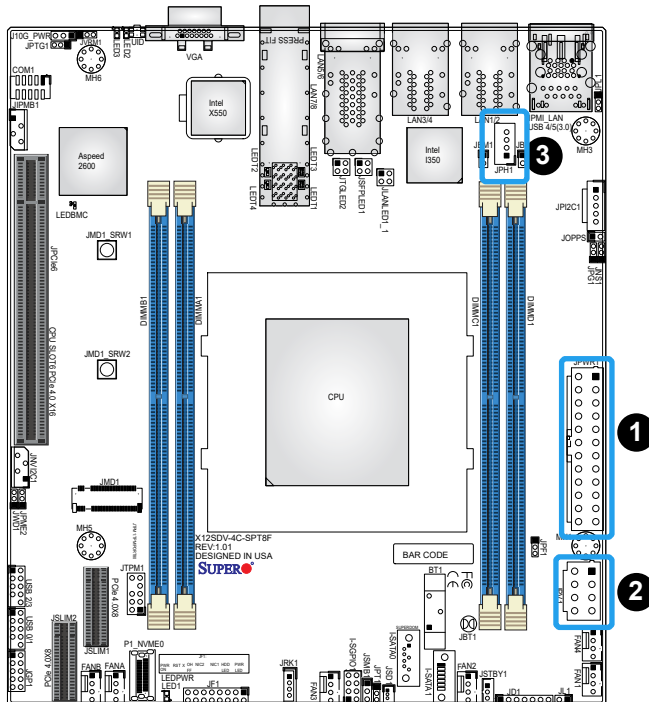

1. 24-Pin ATX Power
2. 8-Pin CPU Power
3. 4-pin HDD Power

Headers

Chassis Intrusion

A Chassis Intrusion header is located at JL1 on the motherboard. Attach the appropriate cable from the chassis to inform you of a chassis intrusion when the chassis is opened. Refer to the table below for pin definitions.

Chassis Intrusion Pin Definitions	
Pin#	Definition
1	Ground
2	Intrusion Input

COM Header

The motherboard has one COM header (COM1) that provides a serial connection.

COM Header (COM1) Pin Definitions			
Pin#	Definition	Pin#	Definition
1	DCD	2	DSR
3	RXD	4	RTS
5	TXD	6	CTS
7	DTR	8	RI
9	Ground	10	N/A

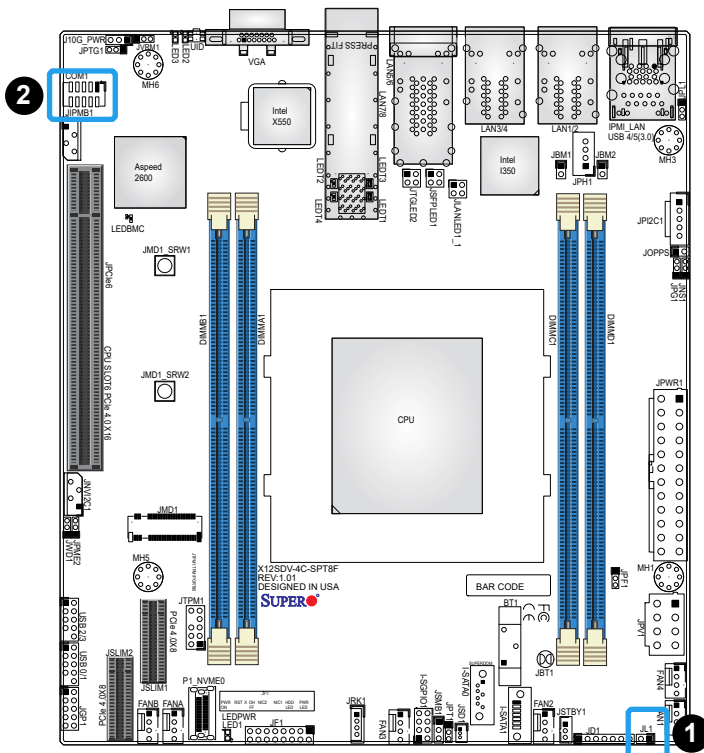

1. Chassis Intrusion
2. COM Header

Disk On Module Power Connector

The Disk On Module (DOM) power connector at JSD1 provides 5V power to a solid-state DOM storage device connected to one of the SATA ports. Refer to the table below for pin definitions.

DOM Power Pin Definitions	
Pin#	Definition
1	5 V
2	Ground
3	Ground

4-pin External BMC I²C Header

A System Management Bus header for IPMI 2.0 is located at JIPMB1. Connect a cable to this header to use the IPMB I²C connection on your system. Refer to the table below for pin definitions.

External I ² C Header Pin Definitions	
Pin#	Definition
1	Data
2	Ground
3	Clock
4	No Connection

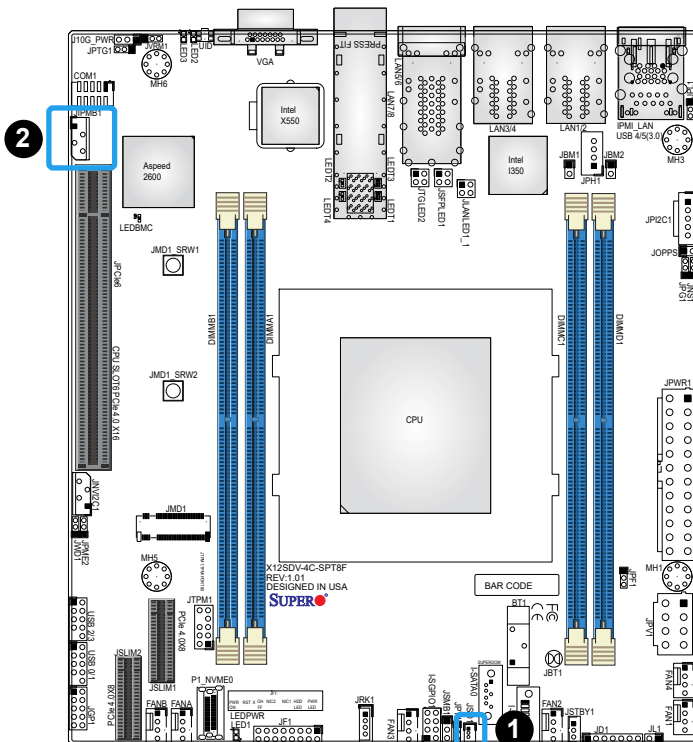

1. Disk On Module Power
2. External BMC I²C Header

Fan Headers

There are six 4-pin fan headers (FAN1–FAN4, FANA, FANB) on the motherboard. All these 4-pin fan headers are backwards compatible with the traditional 3-pin fans. However, fan speed control is available for 4-pin fans only by Thermal Management via the IPMI 2.0 interface. Refer to the table below for pin definitions.

Fan Header Pin Definitions	
Pin#	Definition
1	Ground (Black)
2	4.2 A/+12 V (Red)
3	Tachometer
4	PWM_Control

General Purpose I/O Header

The JGP1 (General Purpose Input/Output) header is an 8-bit general purpose I/O expander on a pin header via the SMBus. Refer to the table below for pin definitions. The base address is 0x70h.

JGP1 Header Pin Definitions		
Pin#	Definition	GPIO Pin
1	+3.3 V	
2	Ground	
3	GP0	GPP_G0
4	GP4	GPP_G4
5	GP1	GPP_G1
6	GP5	GPP_G5
7	GP2	GPP_G2
8	GP6	GPP_G6
9	GP3	GPP_G3
10	GP7	GPP_G7

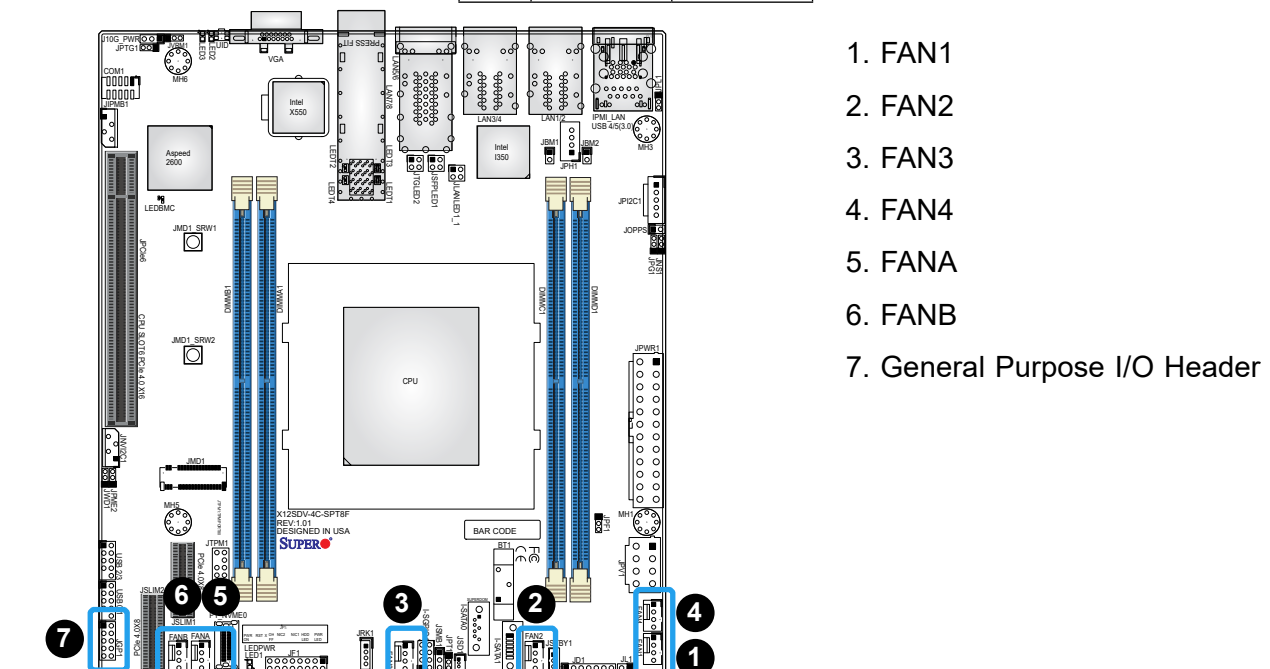

Intel RAID Key Header

The JRK1 header allows you to enable RAID functions for NVMe connections. Refer to the table below for pin definitions.

Intel RAID Key Header Pin Definitions	
Pin#	Definition
1	GND
2	PU 3.3 V Stdby
3	GND
4	PCH RAID KEY

JOPPS

JOPPS is reserved for One Pulse Per Second.

JOPPS Pin Definitions	
Pin#	Definition
1	NAC_OPPTS_OUT
2	NAC_OPPTS_IN

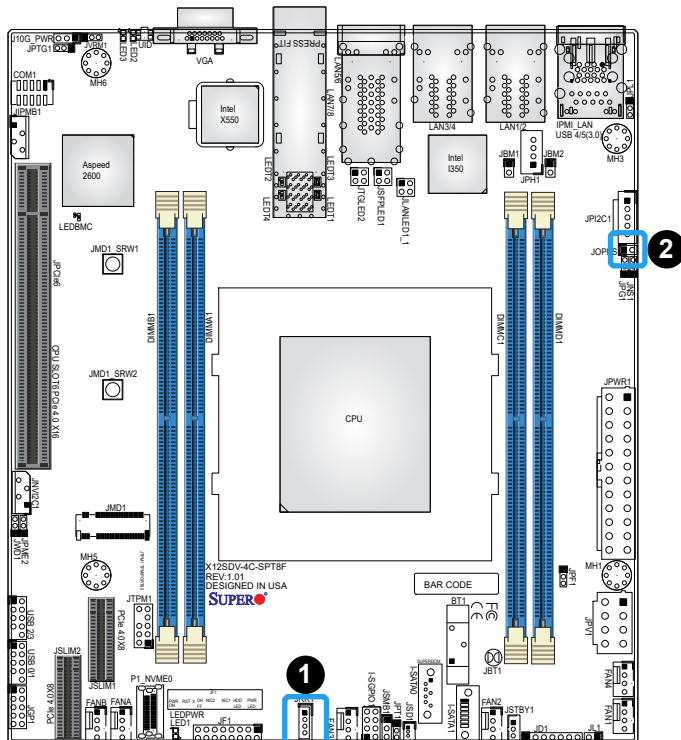

1. Intel RAID Key Header

2. JOPPS

LAN Activity LED Headers

JLANLED1_1 is the activity LED header for LAN3 and LAN4. JSPFLED1 is the activity LED header for LAN7 and LAN8. JTGLEDD2 is the activity LED header for LAN5 and LAN6.

JLANLED1_1/JSPFLED1/JTGLED2 Pin Definitions			
Pin#	Definition	Pin#	Definition
1	+3.3 V Stdbby	2	NIC3 Activity LED
3	+3.3 V Stdbby	4	NIC4 Activity LED

M.2 Slot

This motherboard has one M.2 slot (JMD1). M.2 was formerly known as Next Generation Form Factor (NGFF) and serves to replace mini PCIe. M.2 allows for a variety of card sizes, increased functionality, and spatial efficiency. The M.2 slot on the motherboard supports PCIe 3.0 x4/SATA SSD cards in the 2242 and 2280 form factors.

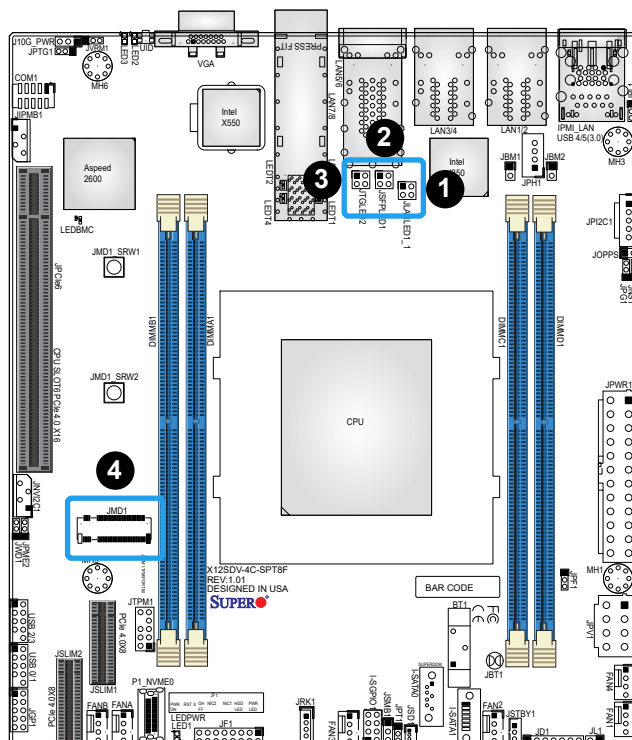

1. JLANLED1_1
2. JSPFLED1
3. JTGLEDD2
4. M.2 Slot

NVMe I²C Header

Connector JNVI²C1 is a management header for the Supermicro AOC NVMe PCIe peripheral cards. Connect the I²C cable to this connector.

OCuLink Connector

One OCuLink connector (P1_NVMe0) is located on the motherboard. Use this connector to attach an OCuLink device.

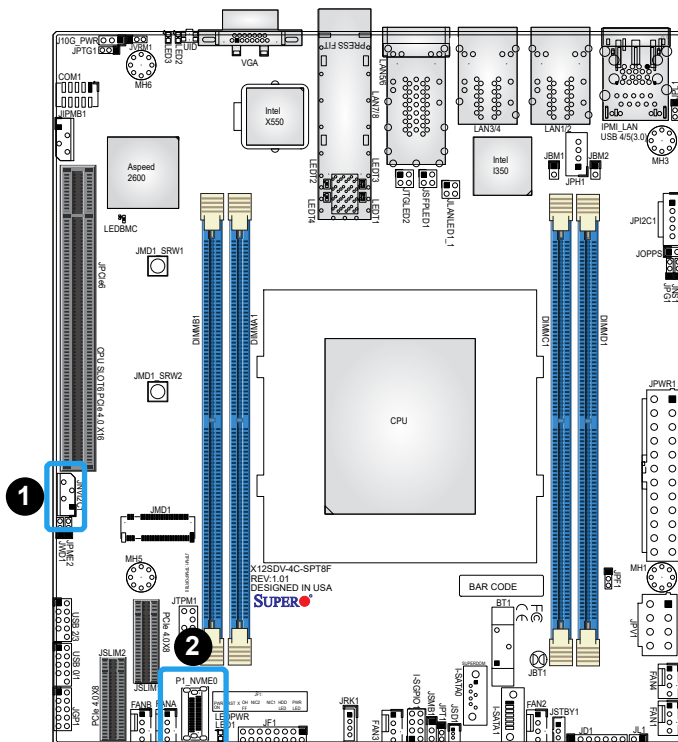

1. NVMe I²C Header
2. OCuLink Connector

Power SMB (I²C) Header

Power System Management Bus (I²C) header at JPI²C1 monitors the power supply, fan and system temperatures. Refer to the table below for pin definitions.

Power SMB Header Pin Definitions	
Pin#	Definition
1	Clock
2	Data
3	Power Fail
4	Ground
5	NC

SATA 3.0 Ports

This motherboard has two SATA 3.0 ports (I-SATA0, I-SATA1). I-SATA0 can be used with Supermicro SuperDOM's SATA DOM connectors with power pins built in, and do not require external power cables. Supermicro SuperDOMs are backward compatible with regular SATA HDDs or SATA DOMs that need external power cables.

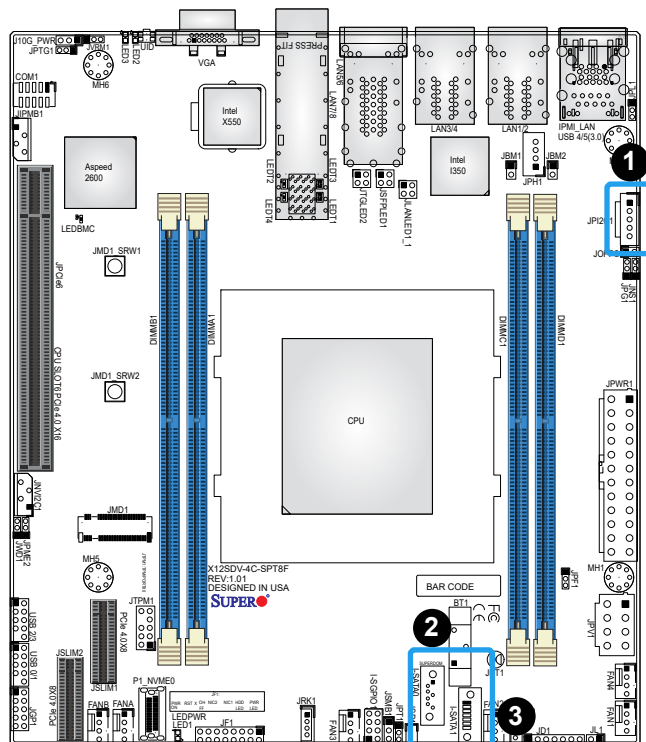

1. Power SMB Header
2. I-SATA0
3. I-SATA1

SGPIO Header

There is one Serial Link General Purpose Input/Output (I-SGPIO1) header located on the motherboard. Refer to the tables below for pin definitions.

SGPIO Header Pin Definitions			
Pin#	Definition	Pin#	Definition
1	NC	2	NC
3	Ground	4	SATA Data
5	SATA Load	6	Ground
7	SATA Clock	8	NC

Slim SAS Connectors

The slim SAS connectors at JSLIM1 and JSLIM2 support PCIe 4.0 x8 devices.

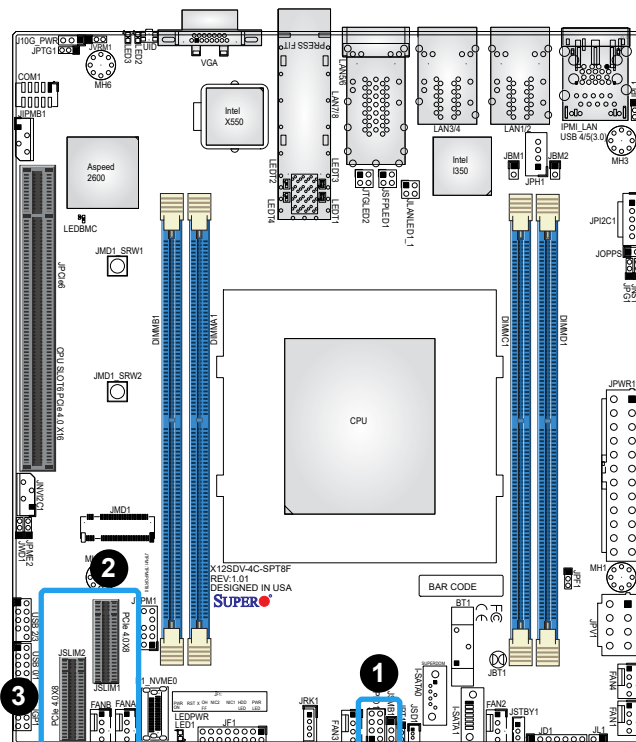

1. SGPIO Header
2. JSLIM1
3. JSLIM2

Speaker/Power LED

Pins 1-3 of JD1 are used for power LED indication, and pins 4-7 are for the speaker. Note that the speaker connector pins are used with an external speaker. Refer to the tables below for pin definitions.

PWR LED Connector Pin Definitions	
Pin#	Signal
1	FP_PWR_LED_P
2	FP_PWR_LED_N
3	FP_PWR_LED_N

Speaker Connector Pin Definitions	
Pin#	Signal
4	P5V
5	NC
6	NC
7	R_SPKRIN

Standby Power

The Standby Power header is located at JSTBY1 on the motherboard. You must have a card with a Standby Power connector and a cable to use this feature. Refer to the table below for pin definitions.

Standby Power Pin Definitions	
Pin#	Definition
1	+5 V Standby
2	Ground
3	No Connection

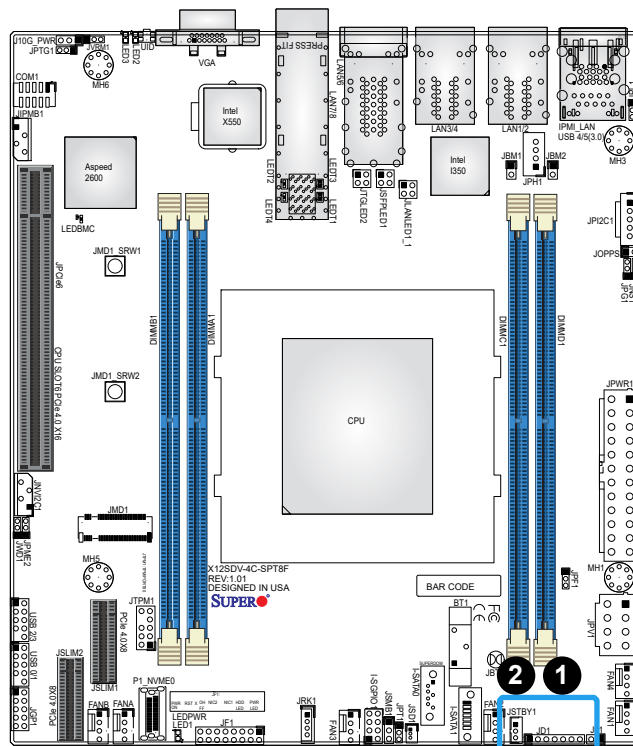

1. Speaker/Power LED

2. Standby Power

TPM/Port 80 Header

A Trusted Platform Module (TPM)/Port 80 header is located at JTPM1 to provide TPM support and Port 80 connection. Use this header to enhance system performance and data security. Refer to the table below for pin definitions. Visit the following link for more information on the TPM: <http://www.supermicro.com/manuals/other/TPM.pdf>.

Trusted Platform Module Header Pin Definitions			
Pin#	Definition	Pin#	Definition
1	+3.3 V	2	SPI_CS#
3	RESET#	4	SPI_MISO
5	SPI_CLK	6	GND
7	SPI_MOSI	8	NC
9	+3.3 V Stdby	10	SPI_IRQ#

1. TPM/Port 80 Header

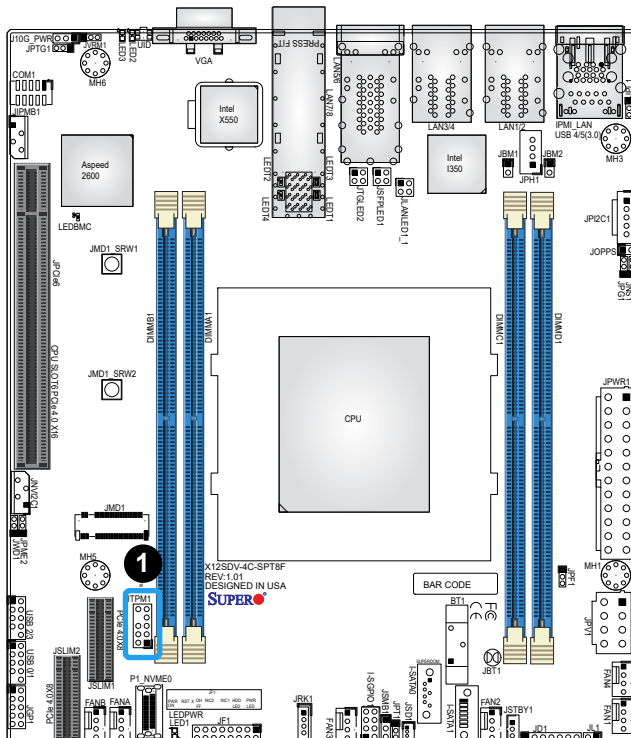

2.7 Jumper Settings

How Jumpers Work

To modify the operation of the motherboard, jumpers can be used to choose between optional settings. Jumpers create shorts between two pins to change the function of the connector. Pin 1 is identified with a square solder pad on the printed circuit board. See the diagram below for an example of jumping pins 1 and 2. Refer to the motherboard layout page for jumper locations.

 **Note:** On two-pin jumpers, Closed means the jumper is on and Open means the jumper is off the pins.

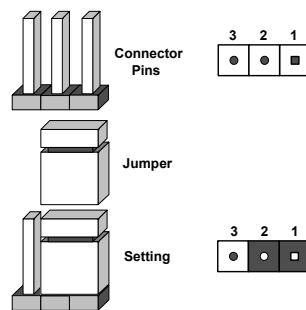

CMOS Clear

JBT1 is used to clear CMOS, which will also clear any passwords. Instead of pins, this jumper consists of contact pads to prevent accidentally clearing the contents of CMOS.

To Clear CMOS

1. First power down the system and unplug the power cord(s).
2. Remove the cover of the chassis to access the motherboard.
3. Remove the onboard battery from the motherboard.
4. Short the CMOS pads with a metal object such as a small screwdriver for at least four seconds.
5. Remove the screwdriver (or shorting device).
6. Replace the cover, reconnect the power cord(s), and power on the system.

 **Note:** Clearing CMOS will also clear all passwords.

Do not use the PW_ON connector to clear CMOS.



IPMI Dedicated LAN Enable/Disable

Use JBM2 to enable or disable the dedicated IPMI LAN port. Refer to the table below for jumper settings.

IPMI Dedicated LAN Enable/Disable Jumper Settings	
Jumper Setting	Definition
Pins 1-2 (Open)	Enabled (Default)
Pins 1-2 (Short)	Disabled

IPMI Share LAN Enable/Disable

Set the JBM1 jumper to enabled to share i350 LAN with IPMI.

IPMI Share LAN Enable/Disable Jumper Settings	
Jumper Setting	Definition
Pins 1-2 (Open)	Enabled (Default)
Pins 1-2 (Short)	Disabled

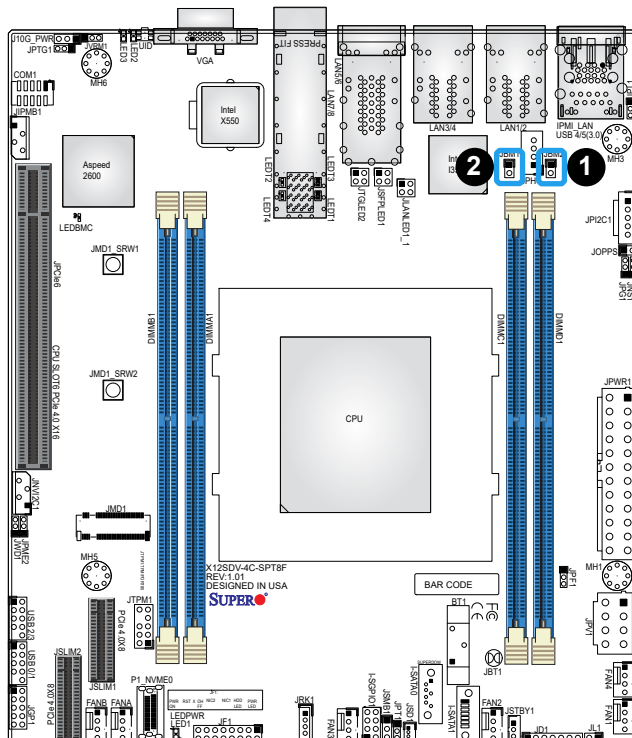

1. IPMI Dedicated LAN Enable/Disable
2. IPMI Share LAN Enable/Disable

10Gb LAN Enable/Disable

Use JPTG1 to enable or disable LAN5/6. The default setting is Enabled.

10Gb LAN Enable/Disable Jumper Settings	
Jumper Setting	Definition
Pins 1-2	Enabled
Pins 2-3	Disabled

LAN Port Enable/Disable

Use JPL1 to enable or disable LAN1–LAN4. The default setting is Enabled.

LAN Port Enable/Disable Jumper Settings	
Jumper Setting	Definition
Pins 1-2	Enabled (Default)
Pins 2-3	Disabled

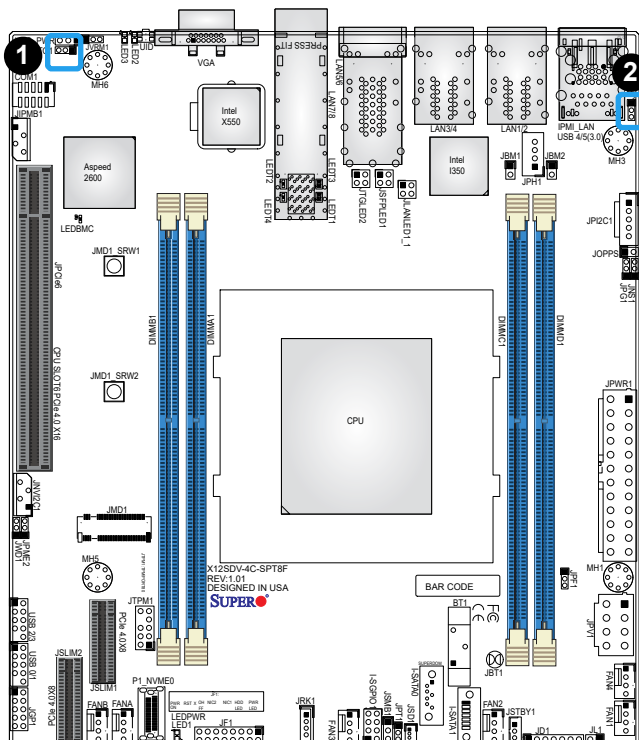

1. 10Gb LAN Enable/Disable
2. LAN Port Enable/Disable

ME Manufacturing Mode

Close pins 2-3 of jumper JPME2 to bypass SPI flash security and force the system to operate in the manufacturing mode, which will allow the user to flash the system firmware from a host server for system setting modifications. Refer to the table below for jumper settings.

ME Manufacturing Mode Jumper Settings	
Jumper Setting	Definition
Pins 1-2	Normal (Default)
Pins 2-3	Manufacturing Mode

OCuLink Selection

Use JNS1 to select the OCuLink lane. Refer to the table below for lane options.

OCuLink Selection Jumper Settings	
Jumper Setting	Definition
Pins 1-2	4x SATA
Pins 2-3	PCIe x4

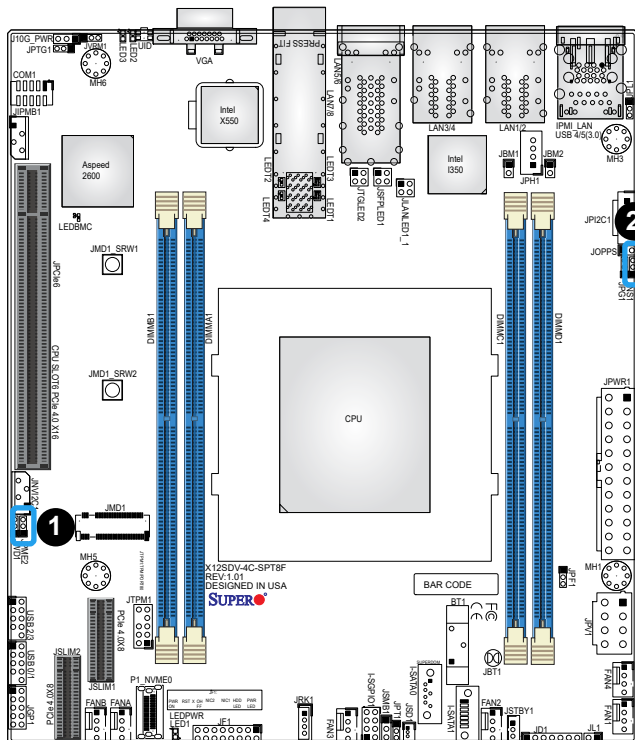

1. ME Manufacturing Mode
2. OCuLink Selection

Onboard TPM Enable/Disable

Use JPT1 to enable or disable the onboard TPM.

Onboard TPM Enable/Disable Jumper Settings	
Jumper Setting	Definition
Pins 1-2	Enabled
Pins 2-3	Disabled

VGA Enable/Disable

JPG1 allows you to enable or disable the VGA port using the onboard graphics controller.

VGA Enable/Disable Jumper Settings	
Jumper Setting	Definition
Pins 1-2	Enabled
Pins 2-3	Disabled

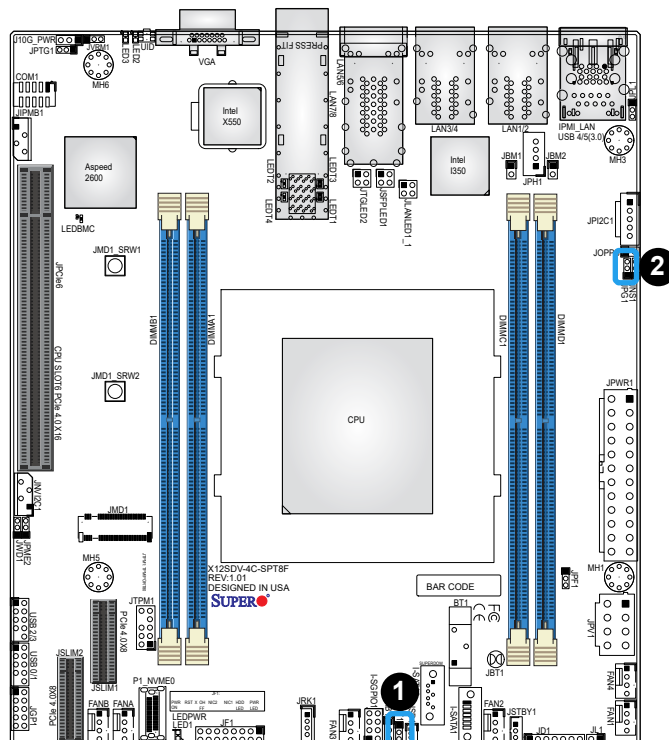

1. Onboard TPM Enable/Disable
2. VGA Enable/Disable

Watchdog

Watchdog (JWD1) is a system monitor that can reboot the system when a software application hangs. Close pins 1-2 to reset the system if an application hangs. Close pins 2-3 to generate a non-maskable interrupt (NMI) signal for the application that hangs. Refer to the table below for jumper settings. The Watchdog must also be enabled in the BIOS.

Watchdog Jumper Settings	
Jumper Setting	Definition
Pins 1-2	Reset (Default)
Pins 2-3	NMI
Open	Disabled

1. Watchdog

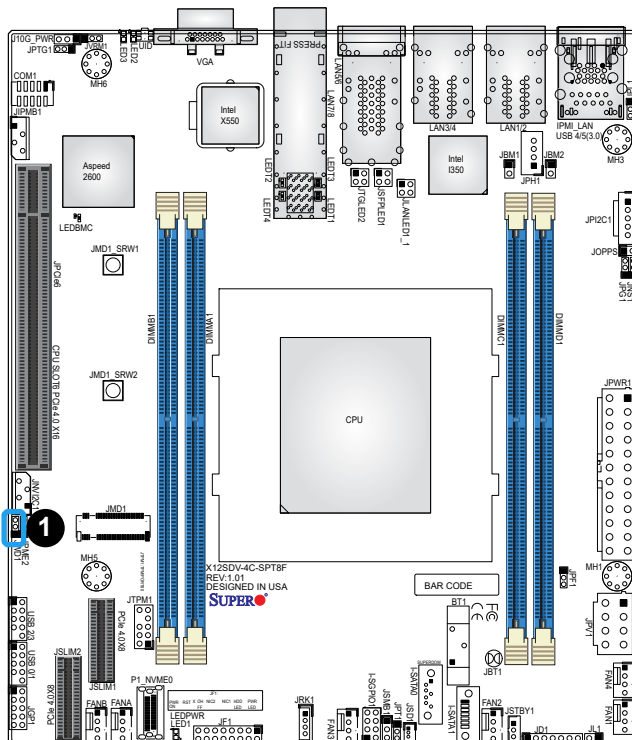

2.8 LED Indicators

BMC Heartbeat LED

LEDBMC is the BMC Heartbeat LED. When the LED is blinking green, BMC is working. Refer to the table below for the LED status.

BMC Heartbeat LED	
LED Color	Definition
Green: Blinking	BMC Normal

RJ45 LAN LEDs

There are six LAN ports (LAN1–LAN6) on the I/O back panel of the motherboard. Each LAN port has two LEDs. The yellow LED indicates activity while the other Link LED may be green, amber, or off to indicate the speed of the connection. Refer to the tables below for more information.

LAN Activity LED for 1GbE (Left)		
LED State		
Color	Status	Definition
Yellow	Flashing	Active

LAN Activity LED for 10GbE (Left)		
LED State		
Color	Status	Definition
Yellow	Flashing	Active

LAN Link LED for 1GbE (Right)	
LED State	
LED Color	Definition
Off	No Connection/10Mbps
Amber	1 Gbps
Green	100 Mbps

LAN Link LED for 10GbE (Right)	
LED State	
LED Color	Definition
Off	100 Mbps
Amber	1 Gbps
Green	10 Gbps

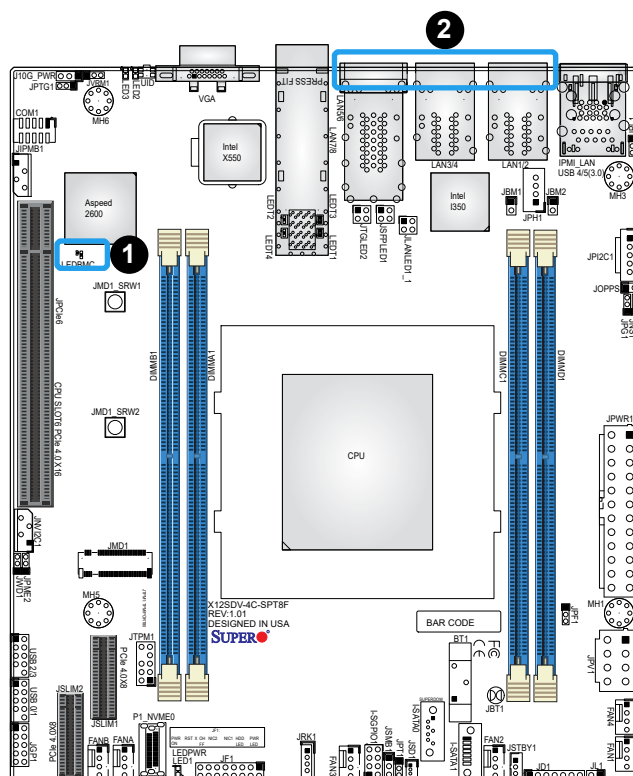

1. BMC Heartbeat LED
2. RJ45 LAN LEDs

SFP28 LAN LEDs

Two 25G LAN ports (LAN7/LAN8) that support SFP28 are also located on the rear I/O panel. Refer to the tables below for the LED status.

LAN Activity LED (Right)		
LED State		
Color	Status	Definition
Green	Flashing	Active

LAN Link LED (Left)	
LED State	
LED Color	Definition
Green	25 Gbps
Yellow	10 Gbps

Overheat/Fan Fail/Power Fail LED

LED3 is the Overheat/Fan Fail/Power Fail LED. Refer to the table below for more information.

Overheat/Fan Fail/Power Fail LED	
LED Color	Definition
Solid Red	System Overheat
Blinking Red	Fan Fail or PWR Fail

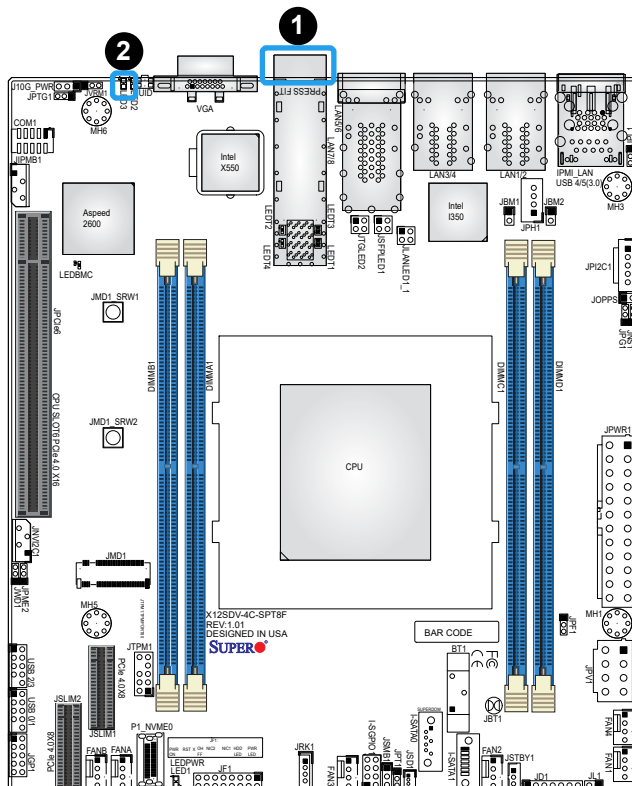

1. SFP28 LAN LEDs
2. Overheat/Fan Fail/PWR Fail LED

Onboard Power LED

LEDPWR is the onboard Power LED. When this LED is on, the system is on. Turn off the system and unplug the power cord before removing or installing components. Refer to the table below for more information.

Onboard Power LED Indicator	
LED Color	Definition
Off	System Off (power cable not connected)
Green	System On

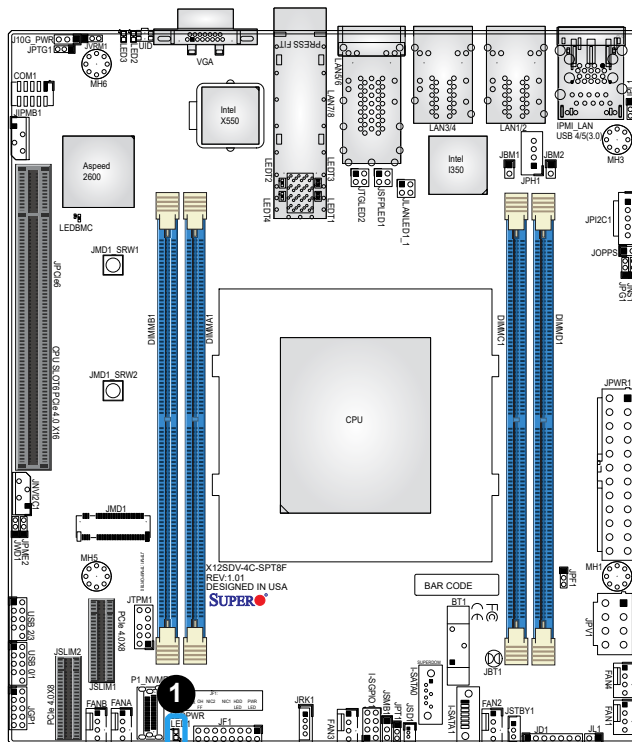

1. Onboard Power LED

Chapter 3

Troubleshooting

3.1 Troubleshooting Procedures

Use the following procedures to troubleshoot your system. If you have followed all of the procedures below and still need assistance, refer to the 'Technical Support Procedures' and/or 'Returning Merchandise for Service' section(s) in this chapter. Always disconnect the AC power cord before adding, changing or installing any non hot-swap hardware components.

Before Power On

1. Make sure that there are no short circuits between the motherboard and chassis.
2. Disconnect all ribbon/wire cables from the motherboard, including those for the keyboard and mouse.
3. Remove all add-on cards.
4. Connect the front panel connectors to the motherboard.

No Power

1. Make sure that there are no short circuits between the motherboard and the chassis.
2. Make sure that the ATX power connectors are properly connected.
3. Check that the 115V/230V switch, if available, on the power supply is properly set.
4. Turn the power switch on and off to test the system, if applicable.
5. The battery on your motherboard may be old. Check to verify that it still supplies approximately 3VDC. If it does not, replace it with a new one.

System Boot Failure

If the system does not display Power-On-Self-Test (POST) or does not respond after the power is turned on, do the following:

1. Check the screen for an error message.
2. Clear the CMOS settings by unplugging the power cord and contacting both pads on the CMOS clear jumper (JBT1). Restart the system. Refer to Section 2-8 in Chapter 2.
3. Remove all components from the motherboard and turn on the system with only one DIMM module installed. If the system boots, turn off the system and repopulate the components back into the system to retest. Add one component at a time to isolate which one may have caused the system boot issue.

Memory Errors

When suspecting faulty memory is causing the system issue, check the following:

1. Make sure that the memory modules are compatible with the system and are properly installed. See Chapter 2 for installation instructions. (For memory compatibility, refer to the "Tested Memory List" link on the motherboard's product page to see a list of supported memory.)
2. Check if different speeds of DIMMs have been installed. It is strongly recommended that you use the same RAM type and speed for all DIMMs in the system.
3. Make sure that you are using the correct type of ECC DDR4 modules recommended by the manufacturer.
4. Check for bad DIMM modules or slots by swapping a single module among all memory slots and check the results.

Losing the System's Setup Configuration

1. Make sure that you are using a high-quality power supply. A poor-quality power supply may cause the system to lose the CMOS setup information. Refer to Chapter 2 for details on recommended power supplies.
2. The battery on your motherboard may be old. Check to verify that it still supplies approximately 3VDC. If it does not, replace it with a new one.
3. If the above steps do not fix the setup configuration problem, contact your vendor for repairs.

When the System Becomes Unstable

A. If the system becomes unstable during or after OS installation, check the following:

1. CPU/BIOS support: Make sure that your CPU is supported and that you have the latest BIOS installed in your system.
2. Memory support: Make sure that the memory modules are supported by testing the modules using memtest86 or a similar utility.



Note: Click on the "Tested Memory List" link on the motherboard's product page to see a list of supported memory.

3. HDD support: Make sure that all hard disk drives (HDDs) work properly. Replace the bad HDDs with good ones.
4. System cooling: Check the system cooling to make sure that all heatsink fans and CPU/system fans, etc., work properly. Check the hardware monitoring settings in the IPMI to make sure that the CPU and system temperatures are within the normal range. Also check the front panel Overheat LED and make sure that it is not on.
5. Adequate power supply: Make sure that the power supply provides adequate power to the system. Make sure that all power connectors are connected. Refer to our website for more information on the minimum power requirements.
6. Proper software support: Make sure that the correct drivers are used.

B. If the system becomes unstable before or during OS installation, check the following:

1. Source of installation: Make sure that the devices used for installation are working properly, including boot devices such as a USB flash or media drives.
2. Cable connection: Check to make sure that all cables are connected and working properly.
3. Use the minimum configuration for troubleshooting: Remove all unnecessary components (starting with add-on cards first), and use the minimum configuration (but with the CPU and a memory module installed) to identify the trouble areas. Refer to the steps listed in Section A above for proper troubleshooting procedures.
4. Identify bad components by isolating them: If necessary, remove a component in question from the chassis, and test it in isolation to make sure that it works properly. Replace a bad component with a good one.
5. Check and change one component at a time instead of changing several items at the same time. This will help isolate and identify the problem.

6. To find out if a component is good, swap this component with a new one to see if the system will work properly. If so, then the old component is bad. You can also install the component in question in another system. If the new system works, the component is good and the old system has problems.

3.2 Technical Support Procedures

Before contacting Technical Support, take the following steps. Also, note that as a motherboard manufacturer, Supermicro also sells motherboards through its channels, so it is best to first check with your distributor or reseller for troubleshooting services. They should know of any possible problems with the specific system configuration that was sold to you.

1. Please go through the Troubleshooting Procedures and Frequently Asked Questions (FAQ) sections in this chapter or see the FAQs on our website (<http://www.supermicro.com/FAQ/index.php>) before contacting Technical Support.
2. BIOS upgrades can be downloaded from our website (http://www.supermicro.com/ResourceApps/BIOS_IPMI_Intel.html).
3. If you still cannot resolve the problem, include the following information when contacting Supermicro for technical support:
 - Motherboard model and PCB revision number
 - BIOS release date/version (This can be seen on the initial display when your system first boots up.)
 - System configuration
4. An example of a Technical Support form is on our website at <http://www.supermicro.com/RmaForm/>.
5. Distributors: For immediate assistance, please have your account number ready when placing a call to our Technical Support department. We can be reached by email at support@supermicro.com.

3.3 Frequently Asked Questions

Question: What type of memory does my motherboard support?

Answer: The motherboard supports up to 256GB of ECC RDIMM or up to 512GB LRDIMM memory DDR4 memory with speeds of up to 2933MT/s in four memory slots. To enhance memory performance, do not mix memory modules of different speeds and sizes. Please follow all memory installation instructions given on Section 2-4 in Chapter 2.

Question: How do I update my BIOS?

Answer: It is recommended that you do not upgrade your BIOS if you are not experiencing any problems with your system. Updated BIOS files are located on our website at http://www.supernmicro.com/ResourceApps/BIOS_IPMI_Intel.html. Please check our BIOS warning message and the information on how to update your BIOS on our website. Select your motherboard model and download the BIOS file to your computer. Also, check the current BIOS revision to make sure that it is newer than your BIOS before downloading.

Unzip the BIOS file onto a bootable USB device and then boot into the built-in UEFI Shell and type "flash.nsh <BIOS filename><BMC Username><BMC Password>" to start the BIOS update. The flash script will invoke the SUM (EFI) tool automatically to perform the BIOS update, beginning with uploading the BIOS image to BMC. After uploading the firmware, the system will reboot to continue the process. The BMC will take over and continue the BIOS update in the background. The process will take 3-5 minutes.

Warning: Do not shut down or reset the system while updating the BIOS to prevent possible system boot failure! Read the X12_AMI_BIOS_Upgrade_README file carefully before you perform the BIOS update.

3.4 Battery Removal and Installation

Battery Removal

To remove the onboard battery, follow the steps below:

1. Power off your system and unplug your power cable.
2. Locate the onboard battery as shown below.
3. Using a tool such as a pen or a small screwdriver, push the battery lock outwards to unlock it. Once unlocked, the battery will pop out from the holder.
4. Remove the battery.

Proper Battery Disposal

Warning: Handle used batteries carefully. Do not damage the battery in any way; a damaged battery may release hazardous materials into the environment. Do not discard a used battery in the garbage or a public landfill. Please comply with the regulations set up by your local hazardous waste management agency to dispose of your used battery properly.

Battery Installation

1. To install an onboard battery, follow steps 1 and 2 above and continue below:
2. Identify the battery's polarity. The positive (+) side should be facing up.
3. Insert the battery into the battery holder and push it down until you hear a click to ensure that the battery is securely locked.

Warning: When replacing a battery, be sure to only replace it with the same type.

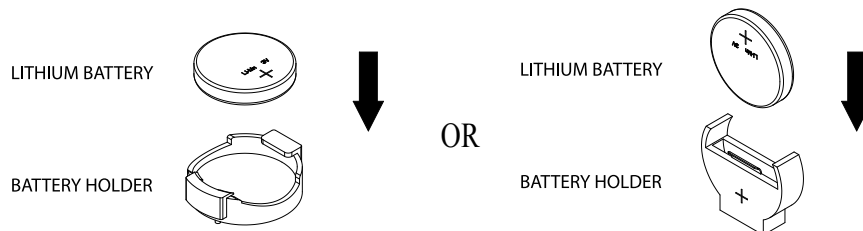

3.5 Returning Merchandise for Service

A receipt or copy of your invoice marked with the date of purchase is required before any warranty service will be rendered. You can obtain service by calling your vendor for a Returned Merchandise Authorization (RMA) number. When returning the motherboard to the manufacturer, the RMA number should be prominently displayed on the outside of the shipping carton, and the shipping package is mailed prepaid or hand-carried. Shipping and handling charges will be applied for all orders that must be mailed when service is complete. For faster service, you can also request a RMA authorization online (<http://www.supermicro.com/RmaForm/>).

This warranty only covers normal consumer use and does not cover damages incurred in shipping or from failure due to the alternation, misuse, abuse or improper maintenance of products.

During the warranty period, contact your distributor first for any product problems.

Chapter 4

UEFI BIOS

4.1 Introduction

This chapter describes the AMIBIOS™ Setup utility for the motherboard. The BIOS is stored on a chip and can be easily upgraded using a flash program.



Note: Due to periodic changes to the BIOS, some settings may have been added or deleted and might not yet be recorded in this manual. Please refer to the Manual Download area of our website for any changes to the BIOS that may not be reflected in this manual.

Starting the Setup Utility

To enter the BIOS Setup Utility, hit the <Delete> key while the system is booting up. (In most cases, the <Delete> key is used to invoke the BIOS setup screen. There are a few cases when other keys are used, such as <F1>, <F2>, etc.) Each main BIOS menu option is described in this manual.

The Main BIOS screen has two main frames. The left frame displays all the options that can be configured. "Grayed-out" options cannot be configured. The right frame displays the key legend. Above the key legend is an area reserved for a text message. When an option is selected in the left frame, it is highlighted in white. Often a text message will accompany it. (Note that the BIOS has default text messages built in. We retain the option to include, omit, or change any of these text messages.) Settings printed in **Bold** are the default values.

A " ►" indicates a submenu. Highlighting such an item and pressing the <Enter> key opens the list of settings within that submenu.

The BIOS setup utility uses a key-based navigation system called hot keys. Most of these hot keys (<F1>, <F2>, <F3>, <Enter>, <ESC>, <Arrow> keys, etc.) can be used at any time during the setup navigation process.

4.2 Main Setup

When you first enter the AMI BIOS setup utility, you will enter the Main setup screen. You can always return to the Main setup screen by selecting the Main tab on the top of the screen. The Main BIOS setup screen is shown below and the following items are displayed:

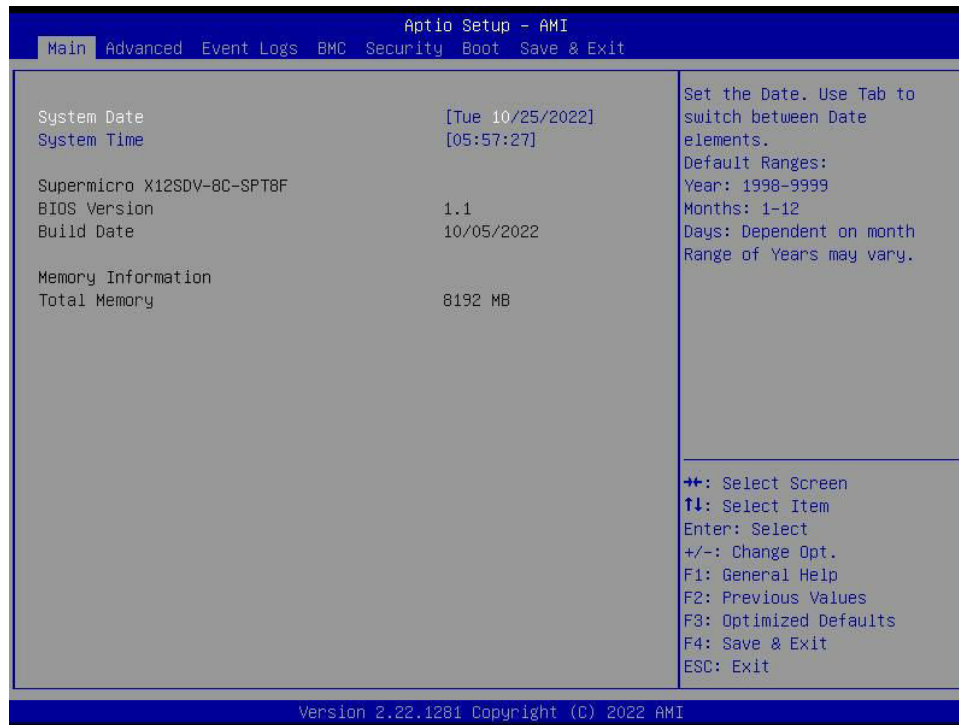

System Date/System Time

Use this option to change the system date and time. Highlight *System Date* or *System Time* using the arrow keys. Enter new values using the keyboard. Press the <Tab> key or the arrow keys to move between fields. The date must be entered in MM/DD/YYYY format. The time is entered in HH:MM:SS format.

 **Note:** The time is in the 24-hour format. For example, 5:30 P.M. appears as 17:30:00. The date's default value is the BIOS build date after RTC reset.

Supermicro X12SDV-8C-SPT8F

BIOS Version

This feature displays the version of the BIOS ROM used in the system.

Build Date

This feature displays the date when the version of the BIOS ROM used in the system was built.

Memory Information

Total Memory

This feature displays the total size of memory available in the system.

4.3 Advanced

Use the arrow keys to select the Advanced menu and press <Enter> to access the menu features.

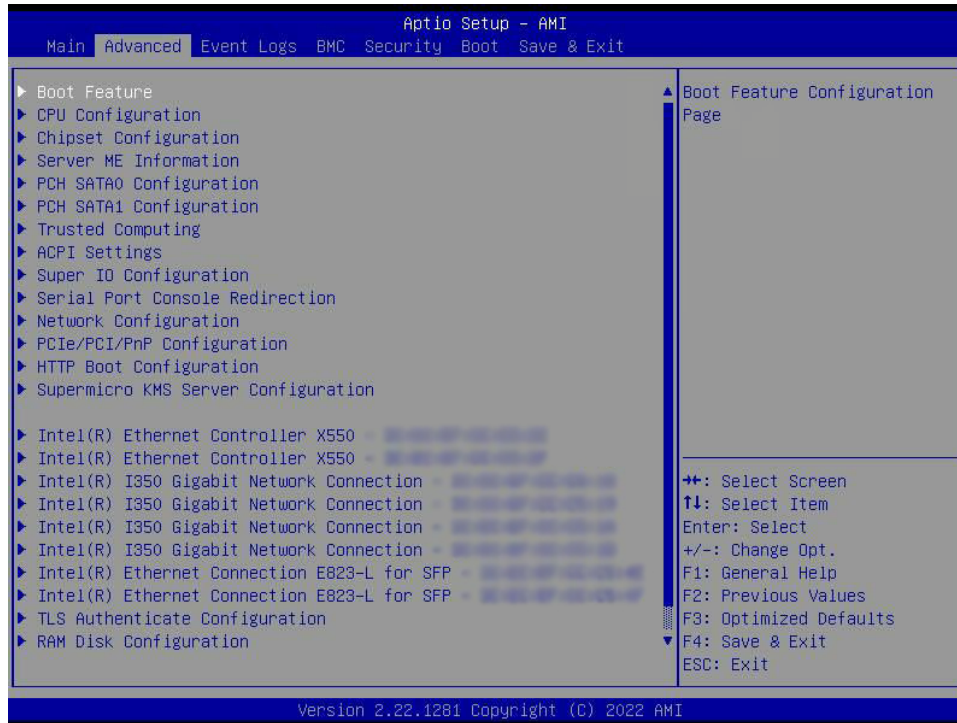

Warning: Take caution when changing the Advanced settings. An incorrect value, a very high DRAM frequency, or an incorrect DRAM timing setting may make the system unstable. When this occurs, revert to default manufacturer settings.

► Boot Feature

Quiet Boot

Use this feature to select the screen display between the POST messages and the OEM logo upon boot up. Select Disabled to display the POST messages. Select Enabled to display the OEM logo instead of the normal POST messages. The options are Disabled and **Enabled**.

Bootup NumLock State

Use this feature to set the Power-on state for the <Numlock> key. The options are **On** and Off.

Wait For "F1" If Error

Use this feature to force the system to wait until the "F1" key is pressed if an error occurs. The options are **Disabled** and Enabled.

Re-try Boot

If this feature is enabled, the BIOS automatically reboots the system from a specified boot device after its initial boot failure. The options are **Disabled**, Legacy Boot, and EFI Boot.

Power Configuration

Watch Dog Function

If enabled, the Watch Dog Timer allows the system to reset or generate NMI based on jumper settings when it is expired for more than five minutes. The options are **Disabled** and Enabled.

Front USB Port(s)

Select Enabled to allow the specific type of USB devices to be used in the front USB ports. Select Enabled (Dynamic) to allow or disallow this particular type of USB devices to be used in the front USB ports without rebooting the system. The options are **Enabled**, Disabled, and Enabled (Dynamic).

Rear USB Port(s)

Select Enabled to allow the specific type of USB devices to be used in the rear USB ports. Select Enabled (Dynamic) to allow or disallow this particular type of USB devices to be used in the rear USB ports without rebooting the system. The options are **Enabled**, Disabled, and Enabled (Dynamic).

Restore on AC Power Loss

Use this feature to set the power state after a power outage. Select Stay Off for the system power to remain off after a power loss. Select Power On for the system power to be turned on after a power loss. Select Last State to allow the system to resume its last power state before a power loss. The options are Stay Off, Power On, and **Last State**.

Power Button Function

This feature controls how the system shuts down when the power button is pressed. Select 4 Seconds Override for you to power off the system after pressing and holding the power button for four seconds or longer. Select Instant Off to instantly power off the system as soon as you press the power button. The options are **Instant Off** and 4 Seconds Override.

► CPU Configuration

Processor Configuration

The following CPU information is displayed:

- Processor BSP Revision
- Processor Socket
- Processor ID

- Processor Frequency
- Processor Max Ratio
- Processor Min Ratio
- Microcode Revision
- L1 Cache RAM (Per Core)
- L2 Cache RAM (Per Core)
- L3 Cache RAM (Per Package)
- Processor 0 Version

▶ CPU1 Core Disable Bitmap

CPU1 Core Disable Bitmap

Available Bitmap

CPU Core Count

CPU1 Cores Enable

Select 0 to enable all cores or 17592186044415 (maximum) to disable all cores. One core must be enabled.

Hyper-Threading (ALL)

Select Enable to support Intel Hyper-threading Technology to enhance CPU performance. The options are Disable and **Enable**.

Hardware Prefetcher

If set to Enable, the hardware prefetcher prefetches streams of data and instructions from the main memory to the L2 cache to improve CPU performance. The options are **Enable** and Disable.

Adjacent Cache Prefetch

The CPU prefetches the cache line for 64 bytes if this feature is set to Disabled. The CPU prefetches both cache lines for 128 bytes as comprised if this feature is set to Enable. The options are **Enable** and Disable.

DCU Streamer Prefetcher (Available when supported by the CPU)

Select Enable to enable the Data Cache Unit (DCU) Streamer Prefetcher, which streams and prefetches data and sends it to the Level 1 data cache to improve data processing and system performance. The options are **Enable** and Disable.

DCU IP Prefetcher (Available when supported by the CPU)

Select Enable for Data Cache Unit (DCU) IP Prefetcher support, which prefetches IP addresses to improve network connectivity and system performance. The options are **Enable** and Disable.

LLC Prefetch

If set to Enable, the hardware prefetcher prefetches streams of data and instructions from the main memory to the L3 cache to improve CPU performance. The options are **Disable** and Enable.

Extended APIC

Select Enable to activate Advanced Programmable Interrupt Controller (APIC) support. The options are **Disable** and Enable.

Enable Intel(R) TXT

Use this feature to enable or disable Intel Trusted Execution Technology support. The options are **Disable** and Enable.

VMX

Use this feature to enable or disable Vanderpool Technology. The options are Disable and **Enable**.

Enable SMX

Use this feature to enable or disable Safer Mode Extensions. The options are **Disable** and Enable.

PPIN Control

Select Unlock/Enable to use the Protected Processor Inventory Number (PPIN) in the system. The options are Lock/Disable and **Unlock/Enable**.

AES-NI

Select Enable to use the Intel Advanced Encryption Standard (AES) New Instructions (NI) to ensure data security. The options are Disable and **Enable**.

TME, TME-MT

Total Memory Encryption (TME)

Use this feature to enable or disable total memory encryption. The options are **Disabled** and Enabled.

Total Memory Encryption Multi-Tenant (TME-MT) (Available when "Memory Encryption (TME)" is set to Enabled)

Use this feature to support tenant-provided (SW-provided) keys. The options are **Disabled** and **Enabled**.

Max TME-MT Keys**Software Guard Extension (SGX)**

SGX cannot be enabled due to unsupported configuration. 1. CPU does not support SGX 2. DIMM population unsupported. Please install one DIMM per channel.

SGX Factory Reset**SW Guard Extensions (SGX)****SGX Package Info In-Band Access**

Software Guard Extension (SGX)

Limit CPU PA to 46 Bits

Use this feature to limit the CPU physical address to 46 bits to support older hyper-v. The options are **Disable** and **Enable**.

▶ Advanced Power Management Configuration**Advanced Power Management Configuration****Power Performance Tuning**

Use this feature to select whether the BIOS or the operating system chooses energy performance tuning. The options are **OS Controls EPB**, and **BIOS Controls EPB**.

****If the feature above is set to BIOS Controls EPB, the next feature is available for configuration:***

ENERGY_PERF_BIAS CFG Mode

Use this feature to set the energy performance bias. The options are **Maximum Performance**, **Performance**, **Balanced Performance**, **Balanced Power**, and **Power**.

► CPU P State Control

CPU P State Control

SpeedStep (P-States)

Intel SpeedStep Technology allows the system to automatically adjust processor voltage and core frequency to reduce power consumption and heat dissipation. The options are Disable and **Enable**.

AVX-P1

Use this feature to select the AVX-P1 level. The options are **Normal**, Level 1, and Level 2.

EIST PSD Funtion

This feature allows you to choose between Hardware and Software to control the processor's frequency and performance (P-state). In HW_ALL mode, the processor hardware is responsible for coordinating the P-state, and the OS is responsible for keeping the P-state request up to date on all Logical Processors. In SW_ALL mode, the OS Power Manager is responsible for coordinating the P-state, and must initiate the transition on all Logical Processors. The options are **HW_ALL** and SW_ALL.

Turbo Mode

This feature enables dynamic control of the processor, allowing it to run above stock frequency. The options are Disable and **Enable**.

► Hardware PM State Control

Hardware PM State Control

Hardware P-States

This setting allows you to select between OS and hardware-controlled P-states. Selecting Native Mode allows the OS to choose a P-state. Selecting Out of Band Mode allows the hardware to autonomously choose a P-state without OS guidance. Selecting Native Mode with No Legacy Support functions as Native Mode with no support for older hardware. The options are **Disable**, Native Mode, Out of Band Mode, and Native Mode with No Legacy Support.

► Frequency Prioritization

Frequency Prioritization

RAPL Prioritization

Use this feature to enable the RAPL balancer. The options are Enable and **Disable**.

► CPU C State Control

CPU C State Control

Enable Monitor MWAIT

Select Enabled to enable the Monitor/Mwait instructions. The Monitor instructions monitors a region of memory for writes, and MWait instructions instruct the CPU to stop until the monitored region begins to write. The options are Disable and **Enable**.

CPU C6 Report

Select Enable to allow the BIOS to report the CPU C6 State (ACPI C3) to the operating system. During the CPU C6 State, the power to all cache is turned off. The options are Disable, Enable, and **Auto**.

Enhanced Halt State (C1E)

Select Enable to use Enhanced Halt State technology, which significantly reduces the CPU's power consumption by reducing its clock cycle and voltage during a Halt-state. The options are Disable and **Enable**.

► Package C State Control

Package C State Control

Package C State

This feature allows you to set the limit on the C State package register. The options are C0/C1 state, C2 state, C6(non Retention) state, and **Auto**.

► CPU T State Control

CPU T State Control

Software Controlled T-States

Use this feature to enable Software Controlled T-States. The options are **Disable** and Enable.

**If the feature above is set to Enable, the next feature is available for configuration:*

T-State Throttle Level

Use this feature to enable or disable CPU throttling, which reduces power consumption. The options are **Disable**, 6.25%, 12.5%, 18.75%, 25.0%, 31.25%, 37.5%, 43.75%, 50.0%, 56.25%, 62.5%, 68.75%, 75.0%, 81.25%, 87.5%, 93.75%.

► Chipset Configuration

Warning: Setting the wrong values in below sections may cause system to malfunction.

► North Bridge

► Uncore Configuration

Uncore Configuration

- Number of CPU
- Number of IIO
- Current UPI Link Speed
- Current UPI Link Frequency
- Global MMIO Low Base / Limit
- Global MMIO High Base / Limit
- PCIe Configuration Base / Size

XPT Prefetch

Use this feature to enable or disable XPT Prefetch support, which allows an LLC request to be duplicated and sent to an appropriate memory controller based on the recent LLC history to reduce latency. The options are Disable, Enable, and **Auto**.

PCIe Remote P2P Relaxed Ordering

Enable peer-to-peer relaxed ordering to optimize system performance. The options are **Disable** and Enable.

Stale AtoS

Use this feature to enable or disable Stale A to S optimization. There are three states in the in-memory directory: invalid (I), snoopAll (A), and shared (S). Data in the I state is clean and does not exist in other sockets. Data in the A state may exist in another exclusive or modified socket. Data in the S state is clean and may be shared across one or more sockets. The options are Disable, Enable, and **Auto**.

LLC Dead Line Alloc

Select Enable to opportunistically fill dead lines in the LLC. Select Disable to never fill dead lines in LLC. The options are Disable, **Enable**, and Auto.

▶ Memory Configuration

Integrated Memory Controller (iMC)

Enforce POR

Select POR (Plan of Record) to enforce POR restrictions on DDR4 frequency and voltage programming. The options are **POR** and Disable.

PPR Type

Use this feature to select the Post Package Repair (PPR) type. The options are PPR Disabled, **Hard PPR**, and Soft PPR.

Memory Frequency

Use this feature to set the maximum memory frequency for onboard memory modules. The options are **Auto**, 2133, 2200, 2400, 2600, 2666, 2800, 2933, 3000, and 3200.

Data Scrambling for DDR4

Use this feature to enable or disable data scrambling for DDR4/5 memory. The options are Disable and **Enable**.

2x Refresh Enable

Use this feature to enable 2x memory refresh support to enhance memory performance. The options are **Auto**, Disable, and Enable.

▶ Memory Topology

This feature displays the information of memory modules detected by the BIOS.

▶ Memory RAS Configuration Setup

Memory RAS Configuration Setup

Enable Pcode WA for SAI PG

Use this feature to enable Pcode Work Around for SAI Policy group for A Step. The options are **Disabled** and Enabled.

Mirror Mode

Correctable Error Threshold

Use this feature to specify the threshold value for correctable memory-error logging, which sets a limit on the maximum number of events that can be logged in the memory error log at a given time. The default setting is **512**.

The following information is displayed:

- Leaky Bucket Low Bit
- Leaky Bucket High Bit

Partial Cache Line Sparing PCLS

Use this feature to enable or disable Partial Cache Line Sparing (PCLS). The options are Disabled and **Enabled**.

ADDDC Sparing

Adaptive Double Device Data Correction (ADDDC) Sparing detects when the predetermined threshold for correctable errors is reached, copying the contents of the failing DIMM to spare memory. The failing DIMM or memory rank will then be disabled. The options are Disabled and **Enabled**.

Patrol Scrub

Patrol Scrubbing is a process that allows the CPU to correct correctable memory errors detected on a memory module and send the correction to the requestor (the original source). When this item is set to Enable, the IO hub reads and writes back one cache line every 16K cycles if there is no delay caused by internal processing. By using this method, roughly 64 GB of memory behind the IO hub is scrubbed every day. The options are Disabled, Enabled, and **Enable at End of POST**.

► IIO Configuration

IIO Configuration

► CPU1 Configuration

CPU Slot6 PCIe 4.0 x16 Bifurcation

Use this feature to configure the bifurcation setting for the PCIe port. The options are **Auto**, x4x4x4x4, x4x4x8, x8x4x4, x8x8, and x16.

► CPU SLOT6 PCIe 4.0 x16

CPU SLOT6 PCIe 4.0 x16

Link Speed

Use this feature to select the link speed for the PCIe port. The options are **Auto**, Gen 1 (2.5 GT/s), Gen 2 (5 GT/s), Gen 3 (8 GT/s), and Gen 4 (16 GT/s).

Override Max Link Width

Use this item to enter a value that overrides the maximum link width set by bifurcation. The options are **Auto**, x1, x2, x4, x8, and x16.

The following information is displayed:

- PCIe Port Link Status
- PCIe Port Link Max
- PCIe Port Link Speed

PCIe Port Max Payload Size

Selecting **Auto** for this feature enables the motherboard to automatically detect the maximum Transaction Layer Packet (TLP) size for the connected PCIe device, allowing for maximum I/O efficiency. Selecting 128B or 256B designates maximum packet size of 128 or 256. The options are 128B, 256B, 512B, and **Auto**.

Non-Transparent Bridge PCIe Port Definition

Select Transparent Bridge to configure the device installed on a PCI slot specified by the user as a transparent bridge (TB) device. Select NTB (Non-Transparent Bridge) to NTB to configure the device installed on a PCI slot specified by the user as a non-transparent bridge (TB) device used to connect to another TB device. The options are **Transparent Bridge**, NTB to NTB, and NTB to RP.



Note: Do not select NTB to RP for legacy IIO on A0 Si.

Imbar2 Size

Use this feature to set the prefetchable Imbar2 size on the primary side of the NTB. The value range is 12–51. The default value is **22**.

Embar1 Size

Use this feature to set the prefetchable Embar1 size on the secondary side of the NTB. The value range is 12–51. The default value is **22**.

Embar2 Size

Use this feature to set the prefetchable Embar2 size on the secondary side of the NTB. The value range is 12–51. The default value is **22**.

▶ IOAT Configuration

Disable TPH

Transparent Huge Pages (TPH) is a Linux memory management system that enables communication in larger blocks (pages). Enabling this feature increases performance. The options are **No** and Yes.

Prioritize TPH

Use this feature to enable Prioritize TPH support. The options are Enable and **Disable**.

Relaxed Ordering

Select Enable to enable Relaxed Ordering support, which allows certain transactions to violate the strict-ordering rules of PCI bus for a transaction to be completed prior to other transactions that have already been enqueued. The options are Yes and **No**.

▶ Intel® VT for Directed I/O (VT-d)

Intel® VT for Directed I/O (VT-d)

Select Yes to use Intel Virtualization Technology for Direct I/O VT-d support by reporting the I/O device assignments to the Virtual Machine Monitor (VMM) through the DMAR ACPI tables. This feature offers fully-protected I/O resource sharing across Intel platforms, providing greater reliability, security and availability in networking and data-sharing. The options are **Enable** and Disable.

ACS Control

Select Yes to program Access Control Services (ACS) to the chipset PCIe root port bridge. Select No to program ACS to all PCIe root port bridges. The options are **Enable** and Disable.

Interrupt Remapping

Use this feature to enable Interrupt Remapping support, which detects and controls external interrupt requests. The options are **Auto**, Enable, and Disable.

▶ Intel® VMD Technology

▶ Intel® VMD for Volume Management Device on CPU1

VMD Config for PCH ports

Enable/Disable VMD

Use this feature to enable or disable the volume management device for this stack. The options are **Disable** and Enable.

If the feature above is set to Enable, the following features are available for configuration:

JMD1:M.2-H PCIe 3.0 X4/S-SATA 3.0 VMD

Enable this feature to allow the VMD to control this root port. The options are **Disable** and Enable.

VMD Config for IOU 0

Enable/Disable VMD

Use this feature to enable or disable the volume management device for this stack. The options are **Disable** and Enable.

If the feature above is set to Enable, the following features are available for configuration:

CPU SLOT6 PCIe 4.0 X16 VMD Port 0 / CPU SLOT6 PCIe 4.0 X16 VMD Port 1 / CPU SLOT6 PCIe 4.0 X16 VMD Port 2 / CPU SLOT6 PCIe 4.0 X16 VMD Port 3

Use this feature to enable or disable the volume management device for this expansion slot. The options are **Disable** and Enable.

Hot Plug Capable

Use this feature to enable or disable hot plug for this port. The options are **Disable** and Enable.

VMD Config for IOU 4

Enable/Disable VMD

Use this feature to enable or disable the volume management device for this stack. The options are **Disable** and Enable.

If the feature above is set to Enable, the following features are available for configuration:

JSLIM1 PCIe 4.0 X8 VMD Port0 / JSLIM1 PCIe 4.0 X8 VMD Port1 / JSLIM2 PCIe 4.0 X8 VMD Port0 / JSLIM2 PCIe 4.0 X8 VMD Port1

Use this feature to enable or disable the volume management device for this expansion slot. The options are **Disable** and **Enable**.

Hot Plug Capable

Use this feature to enable or disable hot plug for this port. The options are **Disable** and **Enable**.

IIO eDPC Support

Use this feature to enable or disable IIO enhanced DPC support. The options are **Disable**, **On Fatal Error**, and **On Fatal and Non-Fatal Errors**.

IIO eDPC Interrupt (Available if "IIO eDPC Support" is set to On Fatal Error or On Fatal and Non-Fatal Errors)

Use this feature to enable or disable IIO enhanced DPC interrupt. The options are **Disable** and **Enable**.

IIO eDPC ERR_COR Message (Available if "IIO eDPC Support" is set to On Fatal Error or On Fatal and Non-Fatal Errors)

Use this feature to enable or disable IIO enhanced DPC error correction message. The options are **Disable** and **Enable**.

PCIe ASPM Support (Global)

Use this feature to enable or disable ASPM support for all downstream devices. The options are **Disable** and **Auto**.

► **South Bridge**

The following USB information is displayed:

- USB Module Version
- USB Devices

XHCI Hand-off

When this feature is disabled, the motherboard will not support USB 3.0. The options are **Enabled** and **Disabled**.

PCIe PLL SSC

Use this feature to enable or disable PCIe PLL SSC. The options are **Disabled** and **Enabled**.

► Server ME Information

The following General ME Configuration is displayed:

- Oper. Firmware Version
- Backup Firmware Version
- Recovery Firmware Version
- ME Firmware Status #1
- ME Firmware Status #2
- Current State
- Error Code

► PCH SATA0 Configuration

PCH SATA Configuration

SATA Controller

This feature enables or disables the onboard SATA controller supported by the Intel PCH chip. The options are Disable and **Enabled**.

SATA Mode Selection

Select AHCI to configure an sSATA drive specified as an AHCI drive. Select RAID to configure an sSATA drive specified as a RAID drive. The options are **AHCI** and RAID.

Support Aggressive Link Power Management

When this feature is set to Enable, the SATA AHCI controller manages the power usage of the SATA link. The controller puts the link in a low power mode during extended periods of I/O inactivity and then returns the link to an active state when I/O activity resumes. The options are **Disabled** and Enable.

SATA Port 0–SATA3

This feature displays the information detected on the installed SATA drive on the particular SATA port.

- Software Preserve Support

SATA Port 0–SATA3 Hot Plug

Set this feature to Enable for hot plug support, which allows you to replace a SATA drive without shutting down the system. The options are Disabled and **Enabled**.

SATA Port 0–SATA3 Spin Up Device

Set this feature to enable or disable the PCH to initialize the device. The options are **Disabled** and Enabled.

SATA Port 0–SATA3 SATA Device Type

Use this feature to specify if the SATA port specified should be connected to a Solid State Drive or a Hard Disk Drive. The options are **Hard Disk Drive** and Solid State Drive.

► PCH SATA1 Configuration

PCH SATA1 Configuration

SATA Controller

This feature enables or disables the onboard SATA controller supported by the Intel PCH chip. The options are **Enabled** and Disable.

SATA Mode Selection

Select AHCI to configure an sSATA drive specified as an AHCI drive. Select RAID to configure an sSATA drive specified as a RAID drive. The options are **AHCI** and RAID.

Support Aggressive Link Power Management

When this feature is set to Enable, the SATA AHCI controller manages the power usage of the SATA link. The controller puts the link in a low power mode during extended periods of I/O inactivity and then returns the link to an active state when I/O activity resumes. The options are **Disabled** and Enabled.

SATA Port 0/1/4/5/6/7

This feature displays the information detected on the installed SATA drive on the particular SATA port.

- Software Preserve Support

SATA Port 0/1/4/5/6/7 Hot Plug

Set this feature to Enable for hot plug support, which allows you to replace a SATA drive without shutting down the system. The options are Disabled and **Enabled**.

SATA Port 0/1/4/5/6/7 Spin Up Device

Set this feature to enable or disable the PCH to initialize the device. The options are **Disabled** and Enabled.

SATA Port 0/1/4/5/6/7 SATA Device Type

Use this feature to specify if the SATA port specified should be connected to a Solid State Drive or a Hard Disk Drive. The options are **Hard Disk Drive** and Solid State Drive.

► Trusted Computing

The motherboard supports TPM 1.2 and 2.0. The following Trusted Platform Module (TPM) information is display if a TPM 2.0 module is detected:

- Firmware Version
- Vendor

Security Device Support

If this feature and the TPM jumper on the motherboard are both set to Enabled, onboard security devices are enabled for Trusted Platform Module (TPM) support to enhance data integrity and network security. Reboot the system for changes to take effect. The options are Disable and **Enable**.

Active PCR Banks

Available PCR Banks

SHA-1 PCR Bank

Use this feature to disable or enable the SHA-1 Platform Configuration Register (PCR) bank for the installed TPM device. The options are Disabled and **Enabled**.

SHA256 PCR Bank

Use this feature to disable or enable the SHA256 Platform Configuration Register (PCR) bank for the installed TPM device. The options are Disabled and **Enabled**.

Pending Operation

Use this feature to schedule a TPM-related operation to be performed by a security device for system data integrity. Your system will reboot to carry out a pending TPM operation. The options are **None** and TPM Clear.

Platform Hierarchy

Use this feature to disable or enable platform hierarchy for platform protection. The options are Disabled and **Enabled**.

Storage Hierarchy

Use this feature to disable or enable storage hierarchy for cryptographic protection. The options are Disabled and **Enabled**.

Endorsement Hierarchy

Use this feature to disable or enable endorsement hierarchy for privacy control. The options are Disabled and **Enabled**.

PH Randomization

Use this feature to disable or enable Platform Hierarchy (PH) Randomization. The options are **Disabled** and Enabled.

Disable Block Sid

Select Enabled to allow SID authentication to be performed in TCG Storage devices. The options are Enabled and **Disabled**.

▶ACPI Settings

ACPI Settings

WHEA Support

Select Enabled to support the Windows Hardware Error Architecture (WHEA) platform and provide a common infrastructure for the system to handle hardware errors within the Windows OS environment to reduce system crashes and to enhance system recovery and health monitoring. The options are Disabled and **Enabled**.

Headless Support

This feature is used to enable the system to function without a keyboard, monitor or mouse attached. The options are **Disabled** and Enabled.

High Precision Event Timer

Select Enabled to activate the High Precision Event Timer (HPET) that produces periodic interrupts at a much higher frequency than a Real-time Clock (RTC) does in synchronizing multimedia streams, providing smooth playback and reducing the dependency on other timestamp calculation devices, such as an x86 RDTSC Instruction embedded in the CPU. The High Performance Event Timer is used to replace the 8254 Programmable Interval Timer. The options are Disabled and **Enabled**.

RTC Wake System From S4/S5

Use this feature to enable or disable the system wake on alarm event.. The options are **Disabled** and Enabled.

► Super IO Configuration

Super IO Configuration

The following Super IO information is display:

- Super IO Chip AST2600

► Serial Port 1 Configuration

Serial Port 1 Configuration

This submenu allows you to configure the settings of Serial Port 1.

Serial Port

Select Enabled to enable the selected onboard serial port. The options are Disabled and **Enabled**.

Device Settings

This feature displays the status of the serial port.

Change Settings

This feature specifies the base I/O port address and the Interrupt Request address of the serial port. Select Auto to allow the BIOS to automatically assign the base I/O and IRQ address. The options are **Auto**, (IO=3F8h; IRQ=4;), (IO=2F8h; IRQ=4;), (IO=3E8h; IRQ=4;), and (IO=2E8h; IRQ=4;).

► Serial Port 2 Configuration

Serial Port 2 Configuration

This submenu allows you to configure the settings of Serial Port 2.

Serial Port

Select Enabled to enable the selected onboard serial port. The options are Disabled and **Enabled**.

Device Settings

This feature displays the status of the serial port.

Change Settings

This feature specifies the base I/O port address and the Interrupt Request address of the serial port. Select Auto to allow the BIOS to automatically assign the base I/O and IRQ address. The options are **Auto**, (IO=3F8h; IRQ=3;), (IO=2F8h; IRQ=3;), (IO=3E8h; IRQ=3;), and (IO=2E8h; IRQ=3;).

► Serial Port Console Redirection

COM1

Console Redirection

Select Enabled to enable console redirection support for the serial port. The options are Enabled and **Disabled**.

**If the feature above is set to Enabled, the following features is available for configuration:*

► COM1 Console Redirection Settings

COM1

Console Redirection Settings

Terminal Type

This feature allows you to select the target terminal emulation type for Console Redirection. Select VT100 to use the ASCII Character set. Select VT100+ to add color and function key support. Select ANSI to use the Extended ASCII Character Set. Select VT-UTF8 to use UTF8 encoding to map Unicode characters into one or more bytes. The options are VT100, **VT100+**, VT-UTF8, and ANSI.

Bits Per Second

Use this feature to set the transmission speed for a serial port used in Console Redirection. Make sure that the same speed is used in the host computer and the client computer. A lower transmission speed may be required for long and busy lines. The options are 9600, 19200, 38400, 57600 and **115200** (bits per second).

Data Bits

Use this feature to set the data transmission size for Console Redirection. The options are 7 Bits and **8 Bits**.

Parity

A parity bit can be sent along with regular data bits to detect data transmission errors. Select Even if the parity bit is set to 0, and the number of 1's in data bits is even. Select Odd if the parity bit is set to 0, and the number of 1's in data bits is odd. Select None if you do not want to send a parity bit with your data bits in transmission. Select Mark to add a mark as a parity bit to be sent along with the data bits. Select Space to add a Space as a parity bit to be sent with your data bits. The options are **None**, Even, Odd, Mark, and Space.

Stop Bits

A stop bit indicates the end of a serial data packet. Select 1 Stop Bit for standard serial data communication. Select 2 Stop Bits if slower devices are used. The options are **1** and **2**.

Flow Control

Use this feature to set the flow control for Console Redirection to prevent data loss caused by buffer overflow. Send a "Stop" signal to stop sending data when the receiving buffer is full. Send a "Start" signal to start sending data when the receiving buffer is empty. The options are **None** and Hardware RTS/CTS.

VT-UTF8 Combo Key Support

Select Enabled to enable VT-UTF8 Combination Key support for ANSI/VT100 terminals. The options are Disabled and **Enabled**.

Recorder Mode

Select Enabled to capture the data displayed on a terminal and send it as text messages to a remote server. The options are **Disabled** and Enabled.

Resolution 100x31

Select Enabled for extended-terminal resolution support. The options are Disabled and **Enabled**.

Putty KeyPad

This feature selects the settings for Function Keys and KeyPad used for Putty, which is a terminal emulator designed for the Windows OS. The options are **VT100**, LINUX, XTERMR6, SC0, ESCN, and VT400.

Redirection After BIOS POST

Use this feature to enable or disable legacy console redirection after BIOS POST. When set to Bootloader, legacy console redirection is disabled before booting the OS. When set to Always Enable, legacy console redirection remains enabled when booting the OS. The options are **Always Enable** and Bootloader.

SOL**SOL Console Redirection**

Select Enabled to use the SOL port for Console Redirection. The options are Disabled and **Enabled**.

****If the feature above is set to Enabled, the following features are available for configuration:***

► SOL Console Redirection Settings

SOL

SOL Console Redirection Settings

Terminal Type

Use this feature to select the target terminal emulation type for Console Redirection. Select VT100 to use the ASCII Character set. Select VT100+ to add color and function key support. Select ANSI to use the Extended ASCII Character Set. Select VT-UTF8 to use UTF8 encoding to map Unicode characters into one or more bytes. The options are ANSI, VT100, **VT100+**, and VT-UTF8.

Bits Per Second

Use this feature to set the transmission speed for a serial port used in Console Redirection. Make sure that the same speed is used in the host computer and the client computer. A lower transmission speed may be required for long and busy lines. The options are 9600, 19200, 38400, 57600 and **115200** (bits per second).

Data Bits

Use this feature to set the data transmission size for Console Redirection. The options are 7 Bits and **8 Bits**.

Parity

A parity bit can be sent along with regular data bits to detect data transmission errors. Select Even if the parity bit is set to 0, and the number of 1's in data bits is even. Select Odd if the parity bit is set to 0, and the number of 1's in data bits is odd. Select None if you do not want to send a parity bit with your data bits in transmission. Select Mark to add a mark as a parity bit to be sent along with the data bits. Select Space to add a Space as a parity bit to be sent with your data bits. The options are **None**, Even, Odd, Mark and Space.

Stop Bits

A stop bit indicates the end of a serial data packet. Select 1 Stop Bit for standard serial data communication. Select 2 Stop Bits if slower devices are used. The options are **1** and **2**.

Flow Control

Use this feature to set the flow control for Console Redirection to prevent data loss caused by buffer overflow. Send a "Stop" signal to stop sending data when the receiving buffer is full. Send a "Start" signal to start sending data when the receiving buffer is empty. The options are **None** and Hardware RTS/CTS.

VT-UTF8 Combo Key Support

Select Enabled to enable VT-UTF8 Combination Key support for ANSI/VT100 terminals. The options are Disabled and **Enabled**.

Recorder Mode

Select Enabled to capture the data displayed on a terminal and send it as text messages to a remote server. The options are **Disabled** and Enabled.

Resolution 100x31

Select Enabled for extended-terminal resolution support. The options are Disabled and **Enabled**.

Putty KeyPad

This feature selects Function Keys and KeyPad settings for Putty, which is a terminal emulator designed for the Windows OS. The options are **VT100**, LINUX, XTERMR6, SCO, ESCN, and VT400.

Redirection After BIOS POST

Use this feature to enable or disable legacy Console Redirection after BIOS POST. When set to Bootloader, legacy Console Redirection is disabled before booting the OS. When set to Always Enable, legacy Console Redirection remains enabled when booting the OS. The options are **Always Enable** and Bootloader.

Serial Port for Out-of-Band Management/Windows Emergency Management Services (EMS)**Console Redirection EMS**

Select Enabled to use a COM port selected by you for EMS Console Redirection. The options are Enabled and **Disabled**.

****If the feature above is set to Enabled, the following features are available for configuration:***

► EMS Console Redirection Settings

This feature allows you to specify how the host computer exchanges data with the client computer, which is the remote computer used by the user.

Out-of-Band Mgmt Port

The feature selects a serial port in a client server to be used by the Microsoft Windows Emergency Management Services (EMS) to communicate with a remote host server. The options are **COM1** and SOL.

Terminal Type

Use this feature to select the target terminal emulation type for Console Redirection. Select VT100 to use the ASCII character set. Select VT100+ to add color and function key support. Select ANSI to use the extended ASCII character set. Select VT-UTF8 to use UTF8 encoding to map Unicode characters into one or more bytes. The options are VT100, VT100+, **VT-UTF8**, and ANSI.

Bits Per Second EMS

This item sets the transmission speed for a serial port used in Console Redirection. Make sure that the same speed is used in the host computer and the client computer. A lower transmission speed may be required for long and busy lines. The options are 9600, 19200, 57600, and **115200** (bits per second).

Flow Control EMS

Use this item to set the flow control for Console Redirection to prevent data loss caused by buffer overflow. Send a "Stop" signal to stop sending data when the receiving buffer is full. Send a "Start" signal to start sending data when the receiving buffer is empty. The options are **None**, Hardware RTS/CTS, and Software Xon/Xoff.

Data Bits EMS

Parity EMS

Stop Bits EMS

► Network Configuration

Network Stack

Select Enabled to enable Preboot Execution Environment (PXE) or Unified Extensible Firmware Interface (UEFI) for network stack support. The options are Disabled and **Enabled**.

IPv4 PXE Support

Select Enabled to enable IPv4 PXE boot support. The options are Disabled and **Enabled**.

IPv4 HTTP Support

Select Enabled to enable IPv4 HTTP boot support. The options are **Disabled** and Enabled.

IPv6 PXE Support

Select Enabled to enable IPv6 PXE boot support. The options are **Disabled** and Enabled.

IPv6 HTTP Support

Select Enabled to enable IPv6 HTTP boot support. The options are **Disabled** and Enabled.

PXE Boot Wait Time

Use this option to specify the wait time to press the ESC key to abort the PXE boot. Press <+> or <-> on your keyboard to change the value. The default setting is **0**.

Media Detect Count

Use this option to specify the number of times media is checked. Press <+> or <-> on your keyboard to change the value. The default setting is **1**.

```

▶ MAC:XXXXXXXXXX-IPv6 Network Configuration
▶ MAC:XXXXXXXXXX-IPv6 Network Configuration
▶ MAC:XXXXXXXXXX-IPv6 Network Configuration
▶ MAC:XXXXXXXXXX-IPv6 Network Configuration
▶ MAC:XXXXXXXXXX-IPv6 Network Configuration
▶ MAC:XXXXXXXXXX-IPv6 Network Configuration
▶ MAC:XXXXXXXXXX-IPv6 Network Configuration
▶ MAC:XXXXXXXXXX-IPv6 Network Configuration

```

▶ Enter Configuration Menu**Interface Name****Interface Type****MAC Address****Host addresses****Route Table****Gateway addresses****DNS addresses****Interface ID**

Use this feature to set the 64-bit alternative interface ID for the device.

DAD Transmit Count

If this set feature is set to 0, the Duplication Address Detection is not performed. Set the value to a preferred selection.

Policy

Use this feature to set the policy to automatic or manual. The options or **automatic** and **manual**.

▶ **Advanced Configuration (Available when "Policy" is set to manual)**

New IPv6 address

Use this feature to enter the IPv6 address for the local machine.

New Gateway address

Use this feature to set the gateway address for the local machine.

New DNS address

Use this feature to set the DNS server address for the local machine.

Commit Changes and Exit

Press <Enter> to save changes and exit. The options are **Yes** and **No**.

Discard Changes and Exit

Press <Enter> to discard changes and exit. The options are **Yes** and **No**.

Save Changes and Exit

Select this feature to save the changes for the features above and exit.

- ▶ **MAC:XXXXXXXXXX-IPv4 Network Configuration**
- ▶ **MAC:XXXXXXXXXX-IPv4 Network Configuration**
- ▶ **MAC:XXXXXXXXXX-IPv4 Network Configuration**
- ▶ **MAC:XXXXXXXXXX-IPv4 Network Configuration**
- ▶ **MAC:XXXXXXXXXX-IPv4 Network Configuration**
- ▶ **MAC:XXXXXXXXXX-IPv4 Network Configuration**
- ▶ **MAC:XXXXXXXXXX-IPv4 Network Configuration**
- ▶ **MAC:XXXXXXXXXX-IPv4 Network Configuration**

Configured

Select Enabled to show whether the network address has been successfully configured. The options are **Disabled** and **Enabled**.

Enable DHCP (Available when "Configured" is set to Enabled)

Select Enabled to support Dynamic Host Configuration Protocol (DHCP). This feature allows the BIOS to search for a DHCP server attached to the network and request the next available IP address for this computer. The options are **Disabled** and **Enabled**.

Local IP Address (Available when "Configured" is set to Enabled and "Enabled DHCP" is set to Disabled)

Use this feature to enter an IP address for the local machine.

Local Network (Available when "Configured" is set to Enabled and "Enabled DHCP" is set to Disabled)

Use this feature to set the network for the local machine.

Local Gateway (Available when "Configured" is set to Enabled and "Enabled DHCP" is set to Disabled)

Use this feature to set the gateway address for the local machine.

Local DNS Servers (Available when "Configured" is set to Enabled and "Enabled DHCP" is set to Disabled)

Use this feature to set the Domain Name System (DNS) server address for the local machine.

Save Changes and Exit

Select this feature to save the changes for the features above and exit.

► PCIe/PCI/PnP Configuration**PCI Bus Driver Version****PCI Devices Common Settings:****Above 4G Decoding (Available if the system supports 64-bit PCI decoding)**

Select Enabled to decode a PCI device that supports 64-bit in the space above 4G Address. The options are Disabled and **Enabled**.

SR-IOV Support

Use this feature to enable or disable Single Root IO Virtualization Support. The options are Disabled and **Enabled**.

ARI Support

Use this feature to enable or disable ARI support. The options are Disabled and **Enabled**.

Bus Master Enable

Use this feature to enable the Bus Master, which enables the Bus Master Attribute for DMA transaction. The options are Disabled and **Enabled**.

Consistent Device Name Support

Use this feature to enable ACPI_DSM device name support for onboard devices and slots. The options are **Disabled** and Enabled.

MMIO High Base

Use this feature to select the base memory size according to memory-address mapping for the IO hub. The options are 56T, 40T, 32T, 24T, 16T, 4T, **2T**, 1T, and 512 G.

MMIO High Granularity Size

Use this feature to select the high memory size according to memory-address mapping for the IO hub. The options are 1G, 4G, 16G, 64G, **256G**, and 1024G.

Maximum Read Request

Use this item to select the Maximum Read Request size of the PCIe device, or select Auto to allow the System BIOS to determine the value. The options are **Auto**, 128 Bytes, 256 Bytes, 512 Bytes, 1024 Bytes, 2048 Bytes, and 4096 Bytes.

MMCFG Base

Use this feature to select the low base address for PCIe adapters to increase base memory. The options are 1G, 1.5G, 1.75G, 2G, 2.25G, 3G, and **Auto**.

NVMe Firmware Source

The feature determines which type of NVMe firmware should be used in your system. The options are **Vendor Defined Firmware** and AMI Native Support.

VGA Priority

Use this feature to select VGA priority when multiple VGA devices are detected. Select Onboard to give priority to your onboard video device. Select Offboard to give priority to your graphics card. The options are **Onboard** and Offboard.

CPU SLOT6 PCIe 4.0 X16 OPROM

Use this feature to select which firmware type to be loaded for the add-on card in this slot. The options are Disabled and **EFI**.

JMD1:M.2-H PCIe 3.0 X4/S-SATA 3.0 OPROM

Use this feature to select which firmware type to be loaded for the add-on card in this slot. The options are Disabled and **EFI**.

Onboard X550 LAN5/6 Option ROM

Use this feature to enable or disable the onboard X550 LAN5/6 device. The options are Disabled and **EFI**.

Onboard I350 LAN1/2/3/4 Option ROM

Use this feature to enable or disable the onboard I350 LAN1/2/3/4 devices. The options are Disabled and **EFI**.

Onboard E823 LAN7/8 Option ROM

Use this feature to enable or disable the onboard E823 LAN1/2/3/4 devices. The options are Disabled and **EFI**.

Onboard Video Option ROM

Use this feature to select which firmware function to be loaded for LAN1 used for system boot. The options are Disabled and **EFI**.

▶ HTTP Boot Configuration

HTTP Boot Configuration

HTTP Boot Policy

Use this feature to select the boot policy. The options are Apply to all LANs, **Apply to each LAN**, and Boot Priority #1 instantly.

HTTPS Boot Checks Hostname

Use this feature to select whether HTTPS Boot checks the hostname of TLS certificates matches the hostname provided by the remote server. The options are **Enabled** and Disabled (WARNING: Security Risk!).

Priority of HTTP Boot:

Instance of Priority 1:

Use this feature to set the rank target port. The default value is **1**.

Select IPv4 or IPv6

Use this feature to select which LAN port to boot from. The options are **IPv4** and IPv6.

Boot Description

Highlight the feature and press enter to create a boot description. The description cannot be more than 75 characters.

Boot URI

Highlight the feature and press enter to create a boot URI.

Instance of Priority 2 - Priority 4:

Use this feature to set the rank target port. The default value is **0**.

▶ Supermicro KMS Server Configuration

Supermicro KMS Server IP address

Enter the IP4 address in dotted-decimal notation (e.g., 255.255.255.255).

Second Supermicro KMS Server IP address

Enter the IP4 address in dotted-decimal notation (e.g., 255.255.255.255).

Supermicro KMS TCP Port number

Enter the KMIP TCP port number (from 100 to 9999) The default is **5696**.

KMS Time Out

Use this feature to determine when the server connection times out. The range is 5 - 30 seconds. The default is **5**.

Supermicro KMS Server Retry Count

Use this feature to test the connection to the Key Manage Server. The range is 0 - 10. 0 means retrying infinitely. The default option is **2**.

TimeZone

Use this feature to select the current time zone.

TCG Nvme KMS Policy

Use this feature to select the Trusted Computing Group (TCG) NVMe KMS policy. The options are Normal Unlock, **Do Nothing**, Reset All Devices, and Deleted Key Id List.

Client UserName

Press Enter to create a client username.

Client Password

Press Enter to create a client username password.

KMS TLS Certificate/Size

▶ CA Certificate

Use this feature to enroll factory defaults or load the CA certificates from a file. The options are **Update**, Delete, and Export.

▶ Client Certificate

Use this feature to enroll factory defaults or load the client certificates from a file. The options are **Update**, Delete, and Export.

▶ Client Private Key

Use this feature to enroll factory defaults or load the client private key from a file. The options are **Update**, Delete, and Export.

▶ Intel(R) Ethernet Controller X550 - XX:XX:XX:XX:XX:XX
▶ Intel(R) Ethernet Controller X550 - XX:XX:XX:XX:XX:XX

▶ Firmware Image Properties

This submenu displays NVM firmware detected by the system.

▶ NIC Configuration

Link Speed

Wake On LAN

Select Enabled for wake on LAN support, which allows the system to wake up when an onboard LAN device receives an incoming signal. The options are Disabled and **Enabled**.

Blink LEDs

Use this feature to identify the physical network port by blinking the associated LED. Use the keyboard to select a value.

UEFI Driver

Adapter PBA

Device Name

Chip Type

PCI Device ID

PCI Address

Link Status

MAC Address

Virtual MAC Address

▶ Intel(R) I350 Gigabit Network Connection - XX:XX:XX:XX:XX:XX
▶ Intel(R) I350 Gigabit Network Connection - XX:XX:XX:XX:XX:XX
▶ Intel(R) I350 Gigabit Network Connection - XX:XX:XX:XX:XX:XX
▶ Intel(R) I350 Gigabit Network Connection - XX:XX:XX:XX:XX:XX

▶ Firmware Image Properties

This submenu displays NVM firmware detected by the system.

▶ NIC Configuration

Link Speed

Use this feature to specify the port speed used for the selected boot protocol. The options are **Auto Negotiated**, 10 Mbps Half, 10 Mbps Full, 100 Mbps Half, and 100 Mbps Full.

Wake On LAN

Select Enabled for wake on LAN support, which allows the system to wake up when an onboard LAN device receives an incoming signal. The options are **Disabled** and Enabled.

Blink LEDs

Use this feature to identify the physical network port by blinking the associated LED. Use the keyboard to select a value.

UEFI Driver

Adapter PBA

Device Name

Chip Type

PCI Device ID

PCI Address

Link Status

MAC Address

Virtual MAC Address

▶ Intel(R) Ethernet Connection E823-L for SFP -
XX:XX:XX:XX:XX:XX

▶▶ Intel(R) Ethernet Connection E823-L for SFP -
XX:XX:XX:XX:XX:XX

▶ Firmware Image Properties

This submenu displays NVM firmware detected by the system.

▶ NIC Configuration

Link Speed

Wake On LAN

Select Enabled for wake on LAN support, which allows the system to wake up when an onboard LAN device receives an incoming signal. The options are Disabled and **Enabled**.

LLDP Agent

Select Enabled to enable the Linked Layer Discovery Protocol Agent. The options are Enabled and **Disabled**.

▶ Device Level Configuration Menu

▶ Port Option Configuration

Port Option

Use this feature to specify the port option of the device. The options are Option0: 4x25G, **Option 1: 4x10G**, Option 2: 4x10G, Option 3: 2x25G, and Option 4: 2x25G.

Port option outlines

▶ Option 0: 4x25G

▶ Option 1: 4x10G

▶ Option 2: 4x10G

▶ Option 3: 2x25G

▶ Option 4: 2x25G

Blink LEDs

Use this feature to identify the physical network port by blinking the associated LED. Use the keyboard to select a value.

UEFI Driver

Adapter PBA

Device Name

Chip Type

PCI Device ID

PCI Address

Link Status

MAC Address

Virtual MAC Address

▶ TLS Authentication Configuration

This submenu allows you to configure Transport Layer Security (TLS) settings.

▶ Server CA Configuration

▶ Enroll Certification

Enroll Certification Using File

Use this feature to enroll certification from a file.

Certification GUID

Use this feature to input the certification GUID.

Commit Changes and Exit

Use this feature to save all changes and exit TLS settings.

Discard Changes and Exit

Use this feature to discard all changes and exit TLS settings.

▶ Delete Certification

Use this feature to delete certification.

▶ Client Certification Configuration

▶ RAM Disk Configuration

This submenu allows you to configure the settings for the RAM disks installed in the system.

Disk Memory Type

This feature specifies the type of memory that is available for you to create a RAM disk. The options are **Boot Service Data** and **Reserved**.

▶ Create raw

This feature allows you to create a raw RAM disk from all available memory modules in the system.

Size (Hex)

Use this feature to set the size of the raw RAM disk. The default setting is **1**.

Create & Exit

Select this feature when you want to exit from this submenu after you've created a raw RAM disk.

Discard & Exit

Select this feature when you want to abandon the changes you've made and to exit from this submenu.

▶ Create from file

This feature allows you to create a RAM disk from a file specified by the user..

Created RAM disk list**Remove selected RAM disk(s).**

Use this feature to delete the RAM disk(s) specified by the user.

▶ Driver Health

This submenu provides the health status for the network drivers and controllers, and all UEFI drivers detected by the system.

▶ Intel(R) PRO/1000 9.3.10 PCIe

Controller 5DE78118 Child 0

Intel(R) I350 Gigabit Network Connection

Controller 5DE77898 Child 0

Intel(R) I350 Gigabit Network Connection

Controller 5DE77598 Child 0

Intel(R) I350 Gigabit Network Connection

Controller 5DE76F18 Child 0

Intel(R) I350 Gigabit Network Connection

▶ Intel(R) 10GbE Driver 8.1.00 x64

Intel(R) Ethernet Controller X550

Intel(R) Ethernet Controller X550

▶ Intel(R) 10GbE Driver 8.1.00 x64

Intel(R) Ethernet Controller X550

Intel(R) Ethernet Controller X550

▶ **Intel(R) 100GbE 3.1.18**

Intel(R) Ethernet Connection E823-L for SFP

Intel(R) Ethernet Connection E823-L for SFP

▶ **Intel(R) 100GbE 3.1.18**

Intel(R) Ethernet Connection E823-L for SFP

Intel(R) Ethernet Connection E823-L for SFP

4.4 Event Logs

Use this menu to configure the Event Log settings.



► Change SMBIOS Event Log Settings

Enabling/Disabling Options

SMBIOS Event Log

Change this feature to enable or disable all features of the SMBIOS Event Logging during system boot. The options are Disabled and **Enabled**.

Erasing Settings

Erase Event Log

If No is selected, data stored in the event log will not be erased. Select Yes, Next Reset, data in the event log will be erased upon next system reboot. Select Yes, Every Reset, data in the event log will be erased upon every system reboot. The options are **No**, Yes, Next reset, and Yes, Every reset.

When Log is Full

Select Erase Immediately for all messages to be automatically erased from the event log when the event log memory is full. The options are **Do Nothing** and Erase Immediately.

SMBIOS Event Log Standard Settings

Log System Boot Event

This option toggles the System Boot Event logging to enabled or disabled. The options are **Disabled** and Enabled.

MECI

The Multiple Event Count Increment (MECI) counter counts the number of occurrences that a duplicate event must happen before the MECI counter is incremented. This is a numeric value. The default value is **1**.

METW

The Multiple Event Time Window (METW) defines the number of minutes that must pass between duplicate log events before MECI is incremented. This is in minutes, from 0 to 99. The default value is **60**.



Note: All values changed here do not take effect until computer is restarted.

►View SMBIOS Event Log

Select this submenu and press enter to see the contents of the SMBIOS event log. The following categories is displayed: Date/Time/Error Codes/Severity.

4.5 BMC

Use this menu to configure BMC settings.

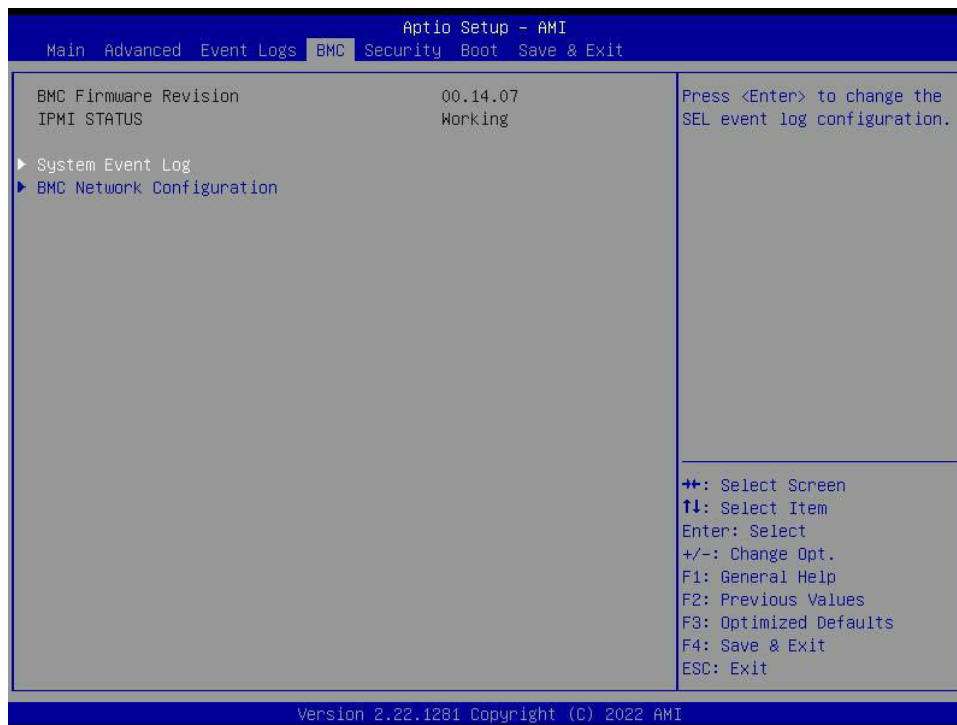

BMC Firmware Revision

This feature displays the IPMI firmware revision used in your system.

IPMI STATUS (Baseboard Management Controller)

This feature displays the status of the IPMI firmware installed in your system.

▶ System Event Log

Enabling/Disabling Options

SEL Components

Select Enabled for all system event logging at boot up. The options are Disabled and **Enabled**.

Erasing Settings

Erase SEL

Select Yes, On next reset to erase all system event logs upon next system reboot. Select Yes, On every reset to erase all system event logs upon each system reboot. Select No to keep all system event logs after each system reboot. The options are **No**, Yes, On next reset, and Yes, On every reset.

When SEL is Full

This feature allows you to decide what the BIOS should do when the system event log is full. Select Erase Immediately to erase all events in the log when the system event log is full. The options are **Do Nothing** and Erase Immediately.



Note: All values changed here do not take effect until computer is restarted.

► BMC Network Configuration

BMC Network Configuration

Update IPMI LAN Configuration

Select Yes for the BIOS to implement all IP/MAC address changes at the next system boot. The options are **No** and Yes.

****If the feature above is set to Yes, Configuration Address Source, VLAN, and IPv6 Support are available for configuration:***

Configure IPv4 Support

IPMI LAN Selection

IPMI Network Link Status

Configuration Address Source

This feature allows you to select the source of the IP address for this computer. If Static is selected, you need to know the IP address of this computer and enter it to the system manually in the field. If DHCP is selected, the BIOS searches for a Dynamic Host Configuration Protocol (DHCP) server in the network that is attached to and request the next available IP address for this computer. The options are Static and **DHC**.

****If the feature above is set to Static, the following features are available for configuration:***

Station IP Address

This feature displays the Station IP address for this computer. The address can be manually entered. This should be in decimal and in dotted quad form (i.e., 192.168.10.253).

Subnet Mask

This feature displays the sub-network that this computer belongs to. The address can be manually entered. The value of each three-digit number separated by dots should not exceed 255.

Station MAC Address

Gateway IP Address

This feature displays the Gateway IP address for this computer. The address can be manually entered. This should be in decimal and in dotted quad form (i.e., 172.31.0.1).

VLAN

This feature displays the virtual LAN settings. The options are **Disable** and **Enable**.

Configure IPv6 Support

IPv6 Address Status

IPv6 Support

Use this feature to enable IPv6 support. The options are **Enabled** and **Disabled**.

****If the feature above is set to Enabled, the following features are available for configuration:***

Configuration Address Source

This feature allows you to select the source of the IP address for this computer. If **Static** is selected, you need to know the IP address of this computer and enter it to the system manually in the field. If **DHCP** is selected, the BIOS searches for a Dynamic Host Configuration Protocol (DHCP) server in the network that is attached to and request the next available IP address for this computer. The options are **DHCP** and **Static**.

****If the feature above is set to Static, the following features are available for configuration:***

Station IPv6 Address

This feature displays the Station IPv6 address for this computer. The address can be manually entered. This should be in decimal and in dotted quad form (i.e., 192.168.10.253).

Prefix Length

Use this feature to set the IPv6 prefix length from the BMC.

IPv6 Router1 IP Address

This feature displays the IPv6 Router1 IP address for this computer. The address can be manually entered. This should be in decimal and in dotted quad form (i.e., 192.168.10.253).

4.6 Security

Use this menu to configure the following security settings for the system.

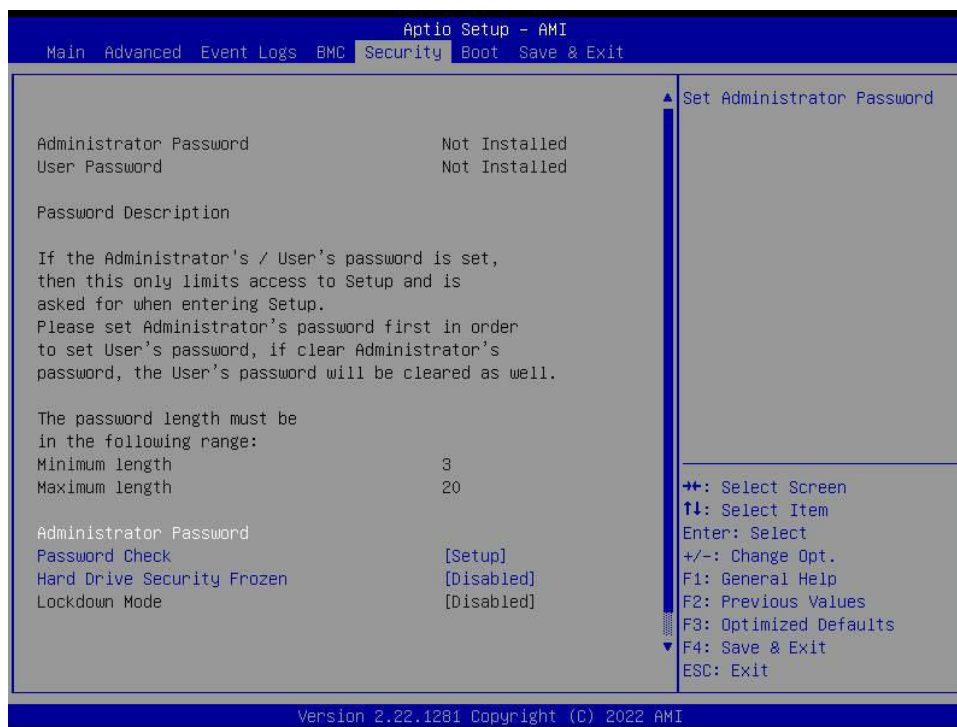

Administrator Password

Press Enter to create a new or change an existing Administrator password.

Password Check

Select Setup for the system to check for a password at Setup. Select Always for the system to check for a password at boot up or upon entering the BIOS Setup utility. The options are **Setup** and **Always**.

Hard Drive Security Frozen

Use this feature to enable or disable the BIOS security frozen command for SATA and NVMe devices. The options are Enabled and **Disabled**.

▶ SMCI Security Erase Configuration

Select this submenu and press enter to see the information to delete the SMCI security configuration.

HDD Name

HDD Serial Number

Security Mode**Security Function**

Enable or Disable this feature to erase the device without a password. The options are **Disable** and Security Erase - Without Password.

HDD Name**HDD Serial Number****Security Mode****Security Function**

Enable or Disable this feature to erase the device without a password. The options are **Disable** and Security Erase - Without Password.

Lockdown Mode

This feature is grayed out when the DCMS Key is not installed.

▶ Secure Boot

This section displays the contents of the following secure boot features:

- System Mode
- Vendor Keys
- Secure Boot

Secure Boot

Use this feature to enable secure boot. The options are **Disabled** and Enabled.

Secure Boot Mode

Use this item to configure Secure Boot variables without authentication. The options are Standard and **Custom**.

Enter Audit Mode

This submenu can only be used if current System Mode is set to User (refer to Exit Deployed Mode). The PK variable will be erased on transition to Audit Mode.

▶ Key Management

This submenu allows you to configure the following Key Management settings.

Vendor Keys

Provision Factory Defaults

Use this feature to install the factory default secure boot keys after the platform has reset and while the system is in Setup mode. The options are **Disabled** and **Enabled**.

▶ Restore Factory Keys

Force System to User Mode. Install factory default Secure Boot key databases.

▶ Reset to Setup Mode

▶ Export Secure Boot variables

▶ Enroll Efi Image

This feature allows the image to run in Secure Boot Mode. Enroll SHA256 Hash Certificate of the image into the Authorized Signature Database.

Device Guard Ready

▶ Remove 'UEFI CA' from DB

▶ Restore DB defaults

Select Yes to restore the DB defaults.

Secure Boot Variable/Size/Keys/Key Source

▶ Platform Key (PK)

Update

Select Yes to load a factory default PK or No to load from a file on an external media.

▶ Key Exchange Key

Update

Select Yes to load a factory default KEK or No to load from a file on an external media.

Append

Select Yes to add the KEK from the manufacturer's defaults list to the existing KEK. Select No to load the KEK from a file. The options are Yes and No.

▶ Authorized Signatures**Update**

Select Yes to load a factory default DB or No to load from a file on an external media.

Append

Select Yes to add the DB from the manufacturer's defaults list to the existing DB. Select No to load the DB from a file. The options are Yes and No.

▶ Forbidden Signatures**Update**

Select Yes to load a factory default DBX or No to load from a file on an external media.

Append

Select Yes to add the DBX from the manufacturer's defaults list to the existing DBX. Select No to load the DBX from a file. The options are Yes and No.

▶ Authorized TimeStamps**Update**

Select Yes to load a factory default DBT or No to load from a file on an external media.

Append

Select Yes to add the DBT from the manufacturer's defaults list to the existing DBT. Select No to load the DBT from a file. The options are Yes and No.

▶ OsRecovery Signature**Update**

Select Yes to load a factory default DBR or No to load from a file on an external media.

Append

Select Yes to add the DBR from the manufacturer's defaults list to the existing DBR. Select No to load the DBR from a file. The options are Yes and No.

4.7 Boot

Use this menu to configure Boot settings.

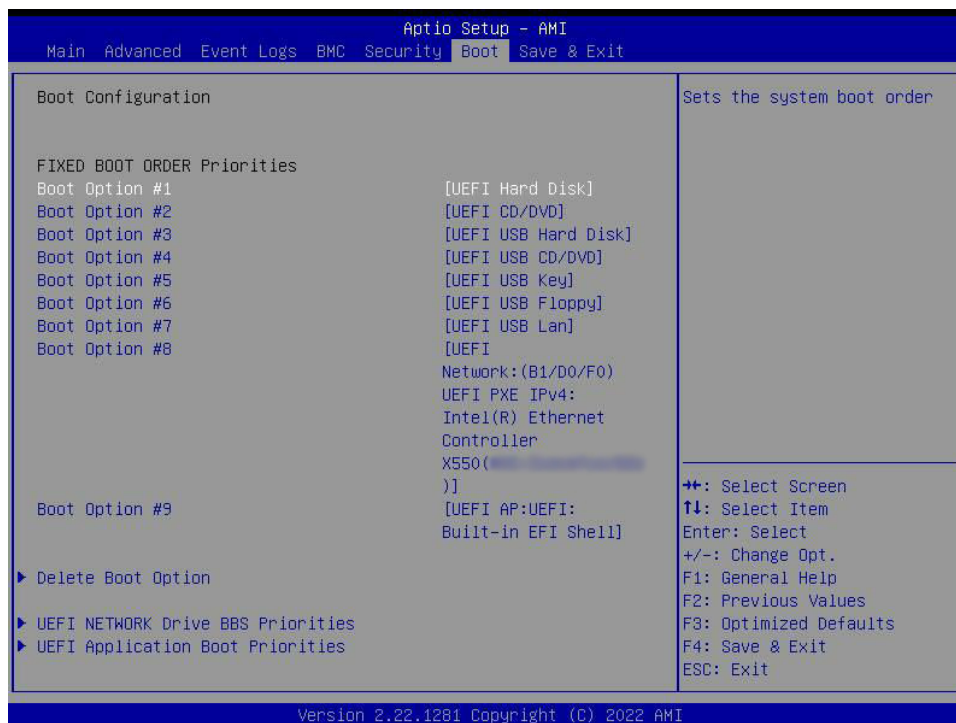

Boot Configuration

FIXED BOOT ORDER Priorities

- Boot Option #1
- Boot Option #2
- Boot Option #3
- Boot Option #4
- Boot Option #5
- Boot Option #6
- Boot Option #7
- Boot Option #8
- Boot Option #9

▶ Delete Boot Option

This feature allows you to select a boot device to delete from the boot priority list.

Delete Boot Option

Delete Boot Option

Use this feature to remove an EFI boot option from the boot priority list.

▶ UEFI NETWORK Drive BBS Priorities

This feature sets the system boot order of detected devices.

- Boot Option #1 - #6

▶ UEFI Application Boot Priorities

This feature sets the system boot order of detected devices.

- Boot Option #1

4.8 Save & Exit

Use this menu to save settings and exit from the BIOS.

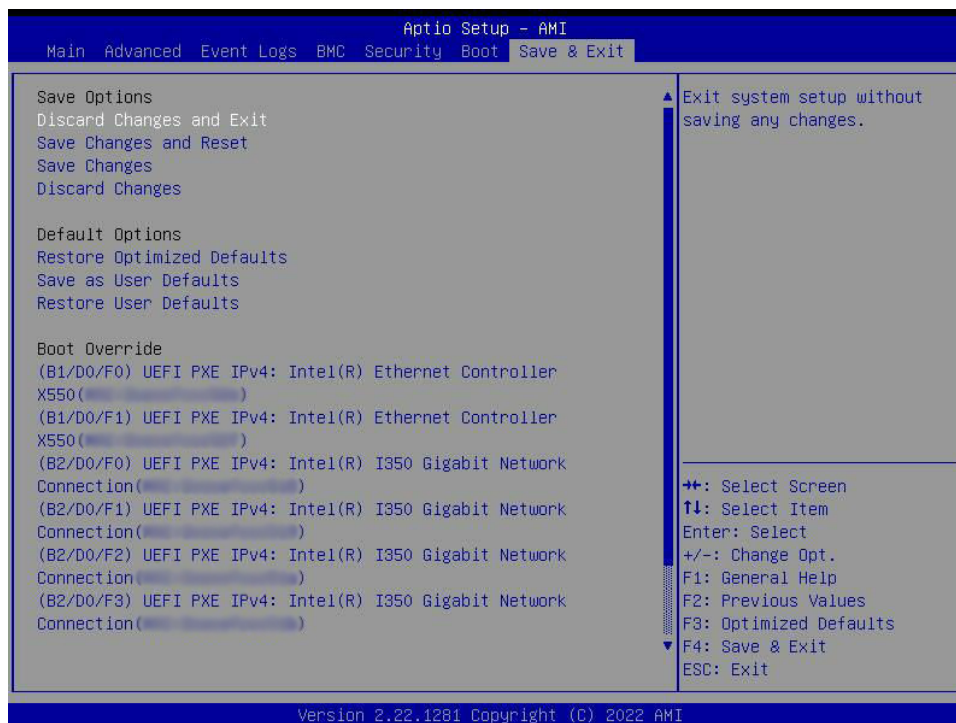

Save Options

Discard Changes and Exit

Select this option to quit the BIOS Setup without making any permanent changes to the system configuration, and reboot the computer. Select Discard Changes and Exit from the Save & Exit menu and press <Enter>.

Save Changes and Reset

After completing the system configuration changes, select this option to save the changes you have made. This will not reboot the system.

Save Changes

When you have completed the system configuration changes, select this option to leave the BIOS setup utility and reboot the computer for the new system configuration parameters to take effect. Select Save Changes from the Save & Exit menu and press <Enter>.

Discard Changes

Select this option and press <Enter> to discard all the changes and return to the AMI BIOS utility program.

Default Options

Restore Optimized Defaults

To set this feature, select Restore Defaults from the Save & Exit menu and press <Enter>. These are factory settings designed for maximum system stability, but not for maximum performance.

Save As User Defaults

To set this feature, select Save as User Defaults from the Save & Exit menu and press <Enter>. This enables you to save any changes to the BIOS setup for future use.

Restore User Defaults

To set this feature, select Restore User Defaults from the Save & Exit menu and press <Enter>. Use this feature to retrieve user-defined settings that were saved previously.

Boot Override

Windows Boot Manager

**(B1/D0/F0) UEFI PXE IPv4: Intel(R) Ethernet Controller X550
(MAC:xxxxxxxxxxxx)**

**(B1/D0/F1) UEFI PXE IPv4: Intel(R) Ethernet Controller X550
(MAC:xxxxxxxxxxxx)**

**(B2/D0/F0) UEFI PXE IPv4: Intel(R) I350 Gigabit Network Connection
(MAC:xxxxxxxxxxxx)**

**(B2/D0/F1) UEFI PXE IPv4: Intel(R) I350 Gigabit Network Connection
(MAC:xxxxxxxxxxxx)**

**(B2/D0/F2) UEFI PXE IPv4: Intel(R) I350 Gigabit Network Connection
(MAC:xxxxxxxxxxxx)**

**(B2/D0/F3) UEFI PXE IPv4: Intel(R) I350 Gigabit Network Connection
(MAC:xxxxxxxxxxxx)**

**(B137/D0/F0) UEFI PXE IPv4: Intel(R) Ethernet Connection E823-L for SFP
(MAC:xxxxxxxxxxxx)**

**(B137/D0/F2) UEFI PXE IPv4: Intel(R) Ethernet Connection E823-L for SFP
(MAC:xxxxxxxxxxxx)**

UEFI: Built-in EFI Shell

Launch EFI Shell from filesystem device

This feature attempts to launch EFI Shell application from one of the available filesystem devices.

Appendix A

BIOS Codes

A.1 BIOS Error POST (Beep) Codes

During the Power-On Self-Test (POST) routines, which are performed each time the system is powered on, errors may occur.

Non-fatal errors are those which, in most cases, allow the system to continue the boot up process. The error messages normally appear on the screen.

Fatal errors are those which will not allow the system to continue the boot up process. If a fatal error occurs, you should consult with your system manufacturer for possible repairs.

These fatal errors are usually communicated through a series of audible beeps that can be heard on an external buzzer connected to JD1. The table shown below lists some common errors and their corresponding beep codes encountered by users.

BIOS Beep (POST) Codes		
Beep Code	Error Message	Description
1 beep	Refresh	Circuits have been reset (Ready to power up)
5 short, 1 long	Memory error	No memory detected in system
5 long, 2 short	Display memory read/write error	Video adapter missing or with faulty memory
1 long continuous	System OH	System overheat condition

A.2 Additional BIOS POST Codes

The AMI BIOS supplies additional checkpoint codes, which are documented online at <http://www.supermicro.com/support/manuals/> ("AMI BIOS POST Codes User's Guide").

When BIOS performs the Power On Self Test, it writes checkpoint codes to I/O port 0080h. For information on AMI updates, refer to <http://www.ami.com/products/>.

Appendix B

Software

After the hardware has been installed, you can install the Operating System (OS), configure RAID settings and install the drivers.

B.1 Microsoft Windows OS Installation

If you will be using RAID, you must configure RAID settings before installing the Windows OS and the RAID driver. Refer to the RAID Configuration User Guides posted on our website at www.supernmicro.com/support/manuals.

Installing the OS

1. Create a method to access the MS Windows installation ISO file. That can be a USB flash or media drive, or the IPMI KVM console.
2. Retrieve the proper RST/RSTe driver. Go to the Supermicro web page for your motherboard and click on "Download the Latest Drivers and Utilities", select the proper driver, and copy it to a USB flash drive.
3. Boot from a bootable device with Windows OS installation. You can see a bootable device list by pressing <F11> during the system startup.

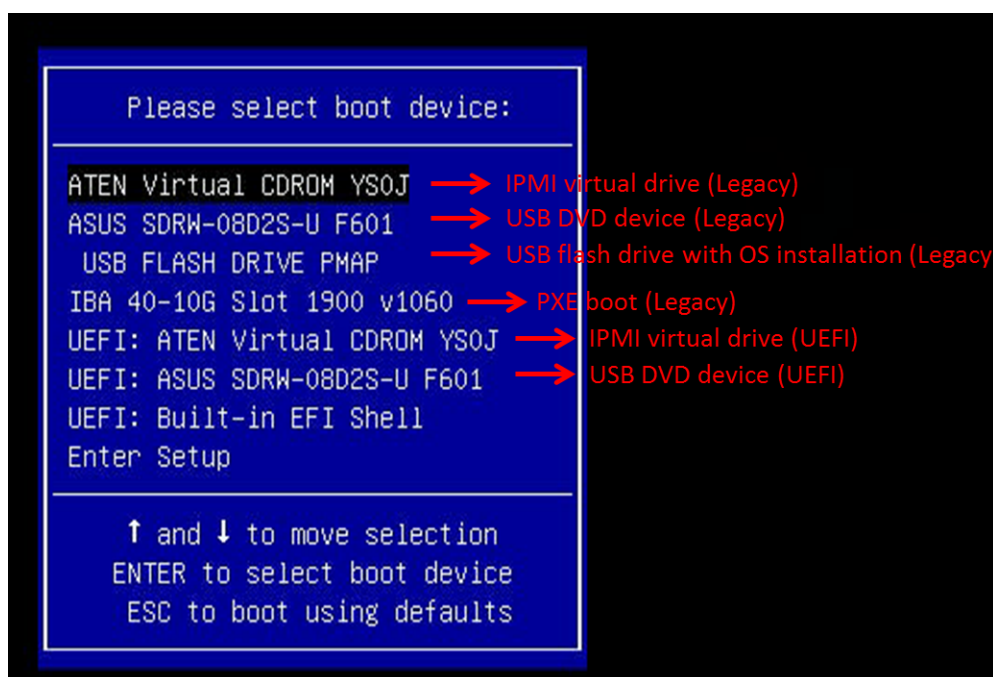

Figure B-1. Select Boot Device

4. During Windows Setup, continue to the dialog where you select the drives on which to install Windows. If the disk you want to use is not listed, click on “Load driver” link at the bottom left corner.

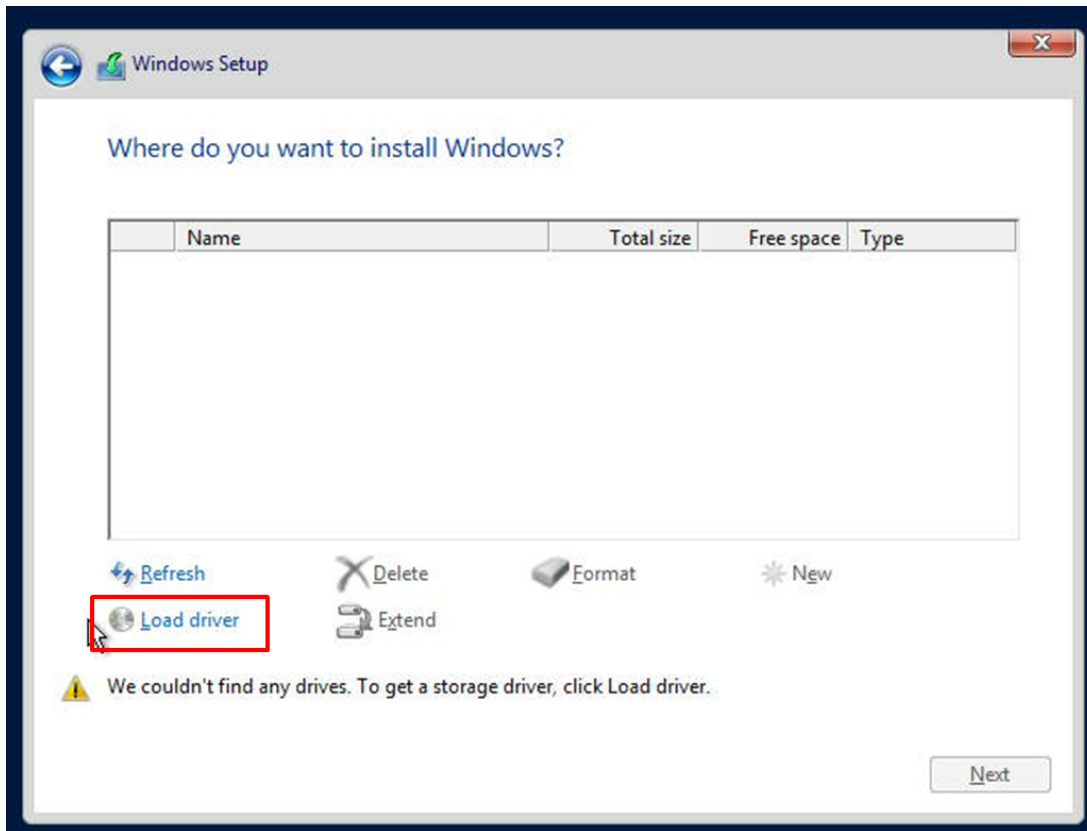

Figure B-2. Load Driver Link

To load the driver, browse the USB flash drive for the proper driver files.

- For RAID, choose the SATA/sSATA RAID driver indicated then choose the storage drive on which you want to install it.
 - For non-RAID, choose the SATA/sSATA AHCI driver indicated then choose the storage drive on which you want to install it.
5. Once all devices are specified, continue with the installation.
 6. After the Windows OS installation has completed, the system will automatically reboot multiple times.

B.2 Driver Installation

The Supermicro website that contains drivers and utilities for your system is at <https://www.supermicro.com/wdl/driver/>. Some of these must be installed, such as the chipset driver.

After accessing the website, go into the CDR_Images (in the parent directory of the above link) and locate the ISO file for your motherboard. Download this file to a USB flash or media drive. (You may also use a utility to extract the ISO file if preferred.)

Another option is to go to the Supermicro website at <http://www.supermicro.com/products/>. Find the product page for your motherboard and download the latest drivers and utilities.

Insert the flash drive or disk and the screenshot shown below should appear.

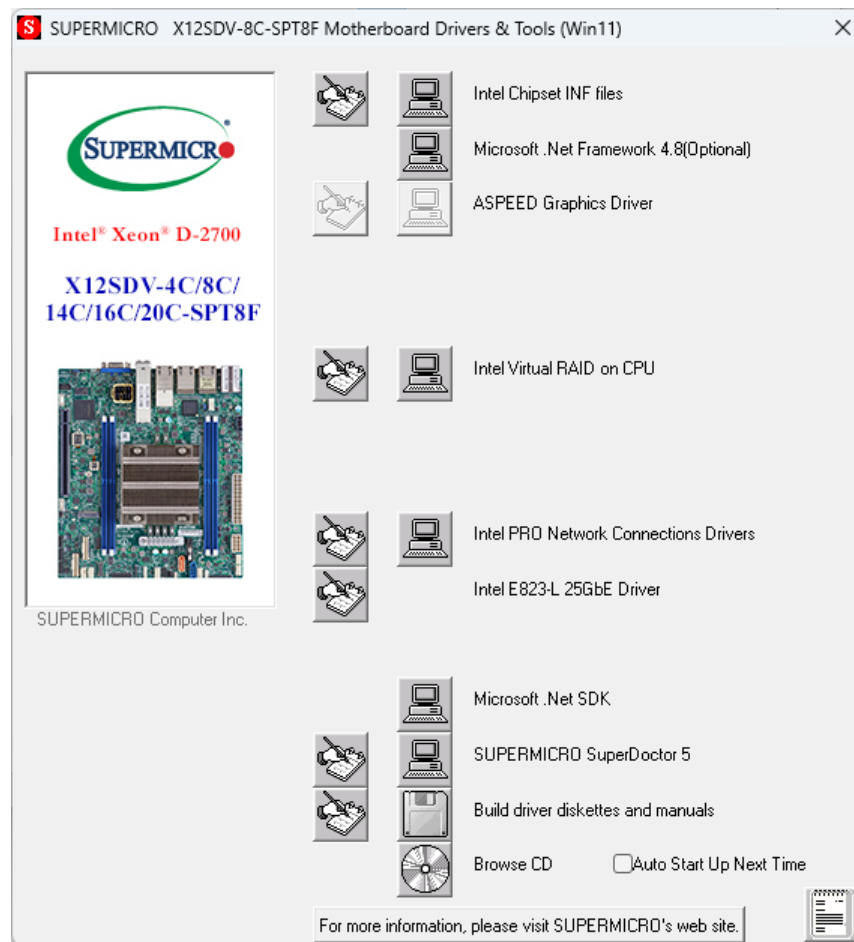



Figure B-3. Driver & Tool Installation Screen

Note: Click the icons showing a hand writing on paper to view the readme files for each item. Click the computer icons to the right of these items to install each item (from top to bottom) one at a time. **After installing each item, you must reboot the system before moving on to the next item on the list.** The bottom icon with a CD on it allows you to view the entire contents.

B.3 SuperDoctor® 5

The Supermicro SuperDoctor 5 is a program that functions in a command-line or web-based interface for Windows and Linux operating systems. The program monitors such system health information as CPU temperature, system voltages, system power consumption, fan speed, and provides alerts via email or Simple Network Management Protocol (SNMP).

SuperDoctor 5 comes in local and remote management versions and can be used with Nagios to maximize your system monitoring needs. With SuperDoctor 5 Management Server (SSM Server), you can remotely control power on/off and reset chassis intrusion for multiple systems with SuperDoctor 5 or IPMI. SuperDoctor 5 Management Server monitors HTTP, FTP, and SMTP services to optimize the efficiency of your operation.

 **Note:** The default User Name and Password for SuperDoctor 5 is ADMIN / ADMIN.

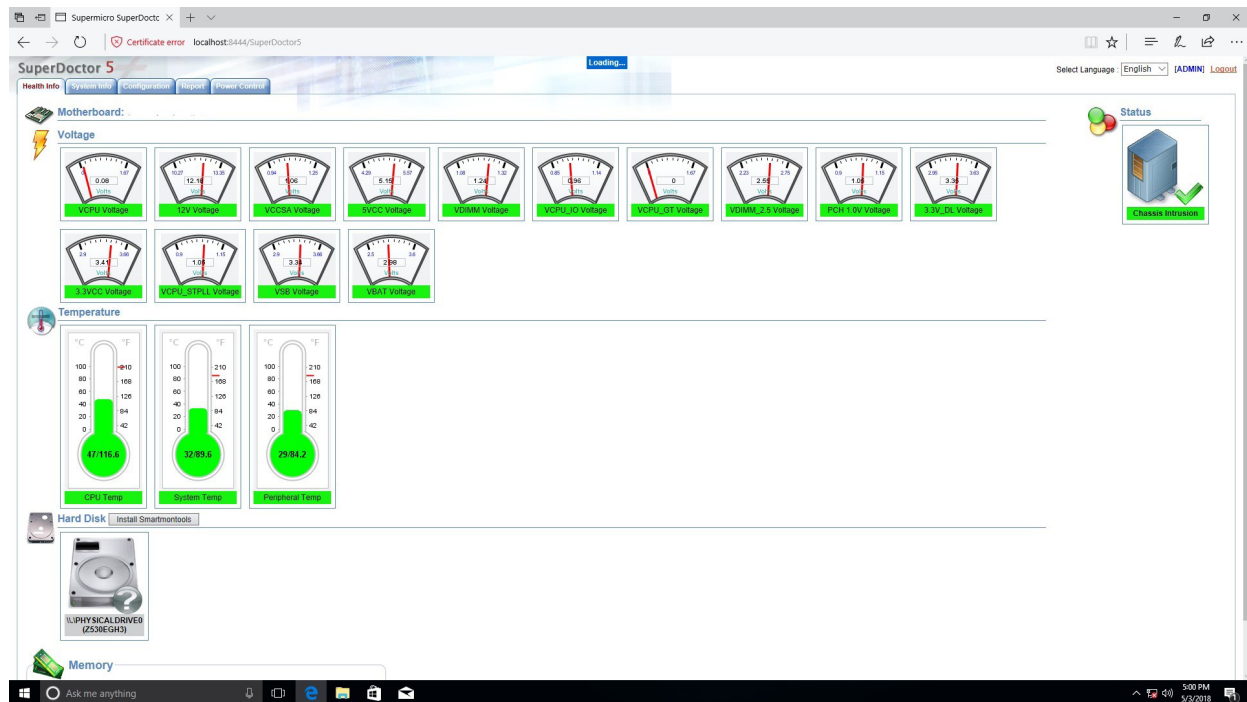

Figure B-4. SuperDoctor 5 Interface Display Screen (Health Information)

B.4 IPMI

The 10th Generation Intel Xeon, Core™ i3, Pentium, Celeron supports the Intelligent Platform Management Interface (IPMI). IPMI is used to provide remote access, monitoring and management. There are several BIOS settings that are related to IPMI.

Supermicro ships standard products with a unique password for the BMC ADMIN user. This password can be found on a label on the motherboard. For general documentation and information on IPMI, visit our website at https://www.supermicro.com/en/support/BMC_Unique_Password.

Appendix C

Standardized Warning Statements

The following statements are industry standard warnings, provided to warn the user of situations which have the potential for bodily injury. Should you have questions or experience difficulty, contact Supermicro's Technical Support department for assistance. Only certified technicians should attempt to install or configure components.

Read this section in its entirety before installing or configuring components.

These warnings may also be found on our website at http://www.supermicro.com/about/policies/safety_information.cfm.

Battery Handling



Warning! There is the danger of explosion if the battery is replaced incorrectly. Replace the battery only with the same or equivalent type recommended by the manufacturer. Dispose of used batteries according to the manufacturer's instructions

電池の取り扱い

電池交換が正しく行われなかった場合、破裂の危険性があります。交換する電池はメーカーが推奨する型、または同等のものを使用下さい。使用済電池は製造元の指示に従って処分して下さい。

警告

電池更換不當會有爆炸危險。請只使用同類電池或製造商推薦的功能相當的電池更換原有電池。請按製造商的說明處理廢舊電池。

警告

電池更換不當會有爆炸危險。請使用製造商建議之相同或功能相當的電池更換原有電池。請按照製造商的說明指示處理廢棄舊電池。

Warnung

Bei Einsetzen einer falschen Batterie besteht Explosionsgefahr. Ersetzen Sie die Batterie nur durch den gleichen oder vom Hersteller empfohlenen Batterietyp. Entsorgen Sie die benutzten Batterien nach den Anweisungen des Herstellers.

Attention

Danger d'explosion si la pile n'est pas remplacée correctement. Ne la remplacer que par une pile de type semblable ou équivalent, recommandée par le fabricant. Jeter les piles usagées conformément aux instructions du fabricant.

¡Advertencia!

Existe peligro de explosión si la batería se reemplaza de manera incorrecta. Reemplazar la batería exclusivamente con el mismo tipo o el equivalente recomendado por el fabricante. Desechar las baterías gastadas según las instrucciones del fabricante.

אזהרה!

קיימת סכנת פיצוץ של הסוללה במידה והוחלפה בדרך לא תקינה. יש להחליף את הסוללה בסוג התואם מחברת יצרן מומלצת. סילוק הסוללות המשומשות יש לבצע לפי הוראות היצרן.

هناك خطر من انفجار في حالة اسبدال البطارية بطريقة غير صحيحة فعلي
اسبدال البطارية فقط بنفس النع أو ما يعادلها مما أوصت به الشركة المصنعة
جخلص من البطاريات المسعملة وفقا لعمليات الشركة الصانعة

경고!

배터리가 올바르게 교체되지 않으면 폭발의 위험이 있습니다. 기존 배터리와 동일하거나 제조사에서 권장하는 동등한 종류의 배터리로만 교체해야 합니다. 제조사의 안내에 따라 사용된 배터리를 처리하여 주십시오.

Waarschuwing

Er is ontploffingsgevaar indien de batterij verkeerd vervangen wordt. Vervang de batterij slechts met hetzelfde of een equivalent type die door de fabrikant aanbevolen wordt. Gebruikte batterijen dienen overeenkomstig fabrieksvoorschriften afgevoerd te worden.

Product Disposal



Warning! Ultimate disposal of this product should be handled according to all national laws and regulations.

製品の廃棄

この製品を廃棄処分する場合、国の関係する全ての法律・条例に従い処理する必要があります。

警告

本产品的废弃处理应根据所有国家的法律和规章进行。

警告

本產品的廢棄處理應根據所有國家的法律和規章進行。

Warnung

Die Entsorgung dieses Produkts sollte gemäß allen Bestimmungen und Gesetzen des Landes erfolgen.

¡Advertencia!

Al deshacerse por completo de este producto debe seguir todas las leyes y reglamentos nacionales.

Attention

La mise au rebut ou le recyclage de ce produit sont généralement soumis à des lois et/ou directives de respect de l'environnement. Renseignez-vous auprès de l'organisme compétent.

סילוק המוצר

אזהרה!

סילוק סופי של מוצר זה חייב להיות בהתאם להנחיות וחוקי המדינה.

عند التخلص النهائي من هذا المنتج ينبغي التعامل معه وفقا لجميع القوانين واللوائح الوطنية

경고!

이 제품은 해당 국가의 관련 법규 및 규정에 따라 폐기되어야 합니다.

Waarschuwing

De uiteindelijke verwijdering van dit product dient te geschieden in overeenstemming met alle nationale wetten en reglementen.

Appendix D

UEFI BIOS Recovery

Warning: Do not upgrade the BIOS unless your system has a BIOS-related issue. Flashing the wrong BIOS can cause irreparable damage to the system. In no event shall Supermicro be liable for direct, indirect, special, incidental, or consequential damages arising from a BIOS update. If you need to update the BIOS, do not shut down or reset the system while the BIOS is updating to avoid possible boot failure.

D.1 Overview

The Unified Extensible Firmware Interface (UEFI) provides a software-based interface between the operating system and the platform firmware in the pre-boot environment. The UEFI specification supports an architecture-independent mechanism that will allow the UEFI OS loader stored in an add-on card to boot the system. The UEFI offers clean, hands-off management to a computer during system boot.

D.2 Recovering the UEFI BIOS Image

A UEFI BIOS flash chip consists of a recovery BIOS block and a main BIOS block (a main BIOS image). The recovery block contains critical BIOS codes, including memory detection and recovery codes for the user to flash a healthy BIOS image if the original main BIOS image is corrupted. When the system power is first turned on, the boot block codes execute first. Once this process is completed, the main BIOS code will continue with system initialization and the remaining POST (Power-On Self-Test) routines.

 **Note 1:** Follow the BIOS recovery instructions below for BIOS recovery when the main BIOS block crashes.

 **Note 2:** When the BIOS recovery block crashes, you will need to follow the procedures to make a Returned Merchandise Authorization (RMA) request. (For a RMA request, see section 3.5 for more information). Also, you may use the Supermicro Update Manager (SUM) Out-of-Band (OOB) (https://www.supermicro.com.tw/products/nfo/SMS_SUM.cfm) to reflash the BIOS.

D.3 Recovering the BIOS Block with a USB Device

This feature allows the user to recover the main BIOS image using a USB-attached device without additional utilities used. A USB flash device such as a USB flash or media drive can be used for this purpose. However, a USB Hard Disk drive cannot be used for BIOS recovery at this time.

The file system supported by the recovery block is FAT (including FAT12, FAT16, and FAT32), which is installed on a bootable or non-bootable USB-attached device. However, the BIOS might need several minutes to locate the SUPER.ROM file if the media size becomes too large due to the huge volumes of folders and files stored in the device.

To perform UEFI BIOS recovery using a USB-attached device, follow the instructions below:

1. Using a different machine, copy the "Super.ROM" binary image file into the disc Root "" directory of a USB flash or media drive.

 **Note 1:** If you cannot locate the "Super.ROM" file in your driver disk, visit our website at www.supermicro.com to download the BIOS package. Extract the BIOS binary image into a USB flash device and rename it "Super.ROM" for the BIOS recovery use.

 **Note 2:** Before recovering the main BIOS image, confirm that the "Super.ROM" binary image file you download is the same version or a close version meant for your motherboard.

2. Insert the USB device that contains the new BIOS image ("Super.ROM") into your USB port and reset the system until the following screen appears:



- After locating the new BIOS binary image, the system will enter the BIOS Recovery menu as shown below:

 **Note:** At this point, you may decide if you want to start the BIOS recovery. If you decide to proceed with BIOS recovery, follow the procedures below.

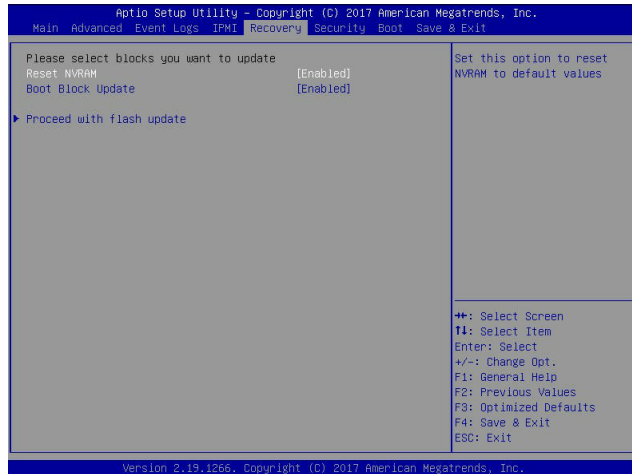

- When the screen as shown above displays, use the arrow keys to select the item "Proceed with flash update" and press the <Enter> key. You will see the BIOS recovery progress as shown in the screen below:

 **Note:** Do not interrupt the BIOS flashing process until it has completed.

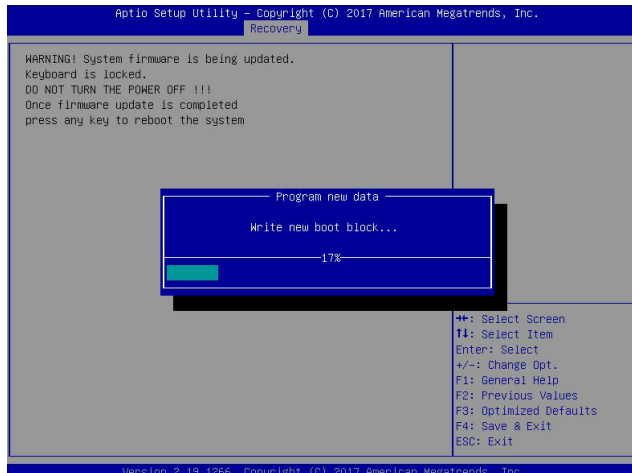

- After the BIOS recovery process is completed, press any key to reboot the system.

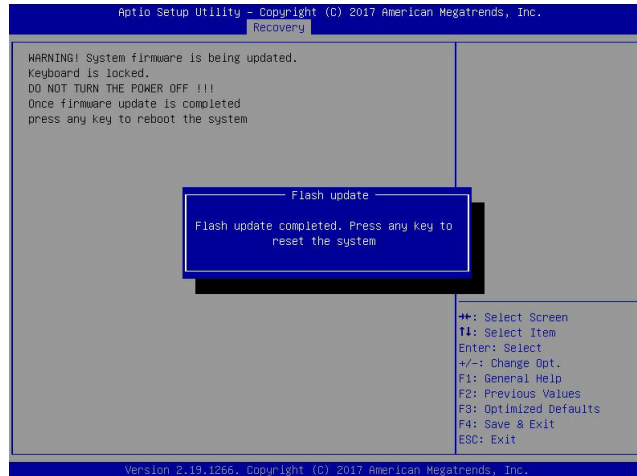

- Using a different system, extract the BIOS package into a USB flash drive.
- Press during system boot to enter the BIOS Setup utility. From the top of the toolbar, select Boot to enter the submenu. From the submenu list, select Boot Option #1 as shown below. Then, set Boot Option #1 to [UEFI AP:UEFI: Built-in EFI Shell]. Press <F4> to save the settings and exit the BIOS Setup utility.

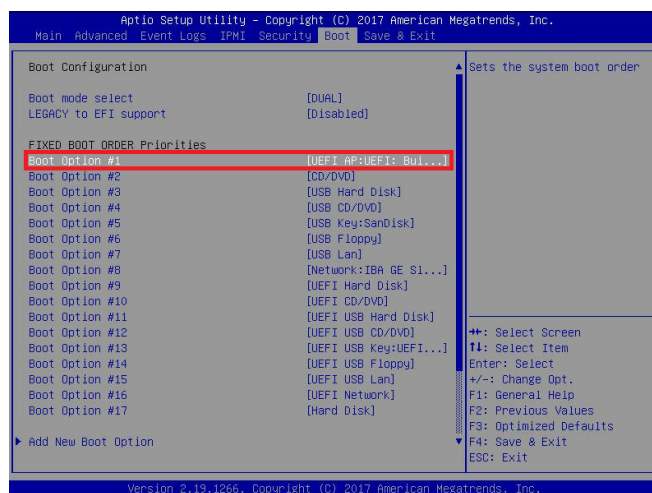

- When the UEFI Shell prompt appears, type `fs#` to change the device directory path. Go to the directory that contains the BIOS package you extracted earlier from Step 6. Enter `flash.nsh BIOSname.###` at the prompt to start the BIOS update process.

```
UEFI Interactive Shell v2.1
EDK II
UEFI v2.50 (American Megatrends, 0x0005000c)
Mapping table
FS0: Alias(s):HD(0)F00:BLK1:
      PciRoot(0x0)/Pci(0x14,0x0)/USB(0x11,0x0)/HD(1,MBR,0x3791072,0x800,0x1
0A9592)
      BLK0: Alias(s):
      PciRoot(0x0)/Pci(0x14,0x0)/USB(0x11,0x0)
Press F8 in 1 seconds to skip startup.nsh or any other key to continue.
Shell> fs#
FS0:\> cd \FUD00
FS0:\FUD00> cd SKJFME2_03162017
FS0:\FUD00\SKJFME2_03162017> flash.nsh X11DPV7.314
```



Note: Do not interrupt this process until the BIOS flashing is complete.

```
Done.
[ Access Chos Port Ex ]
<Read>
Index 0x51: 0x10
Done.
*****
* Program BIOS and ME (Including FDT) regions...
*****
| AMI Firmware Update Utility v5.09.01.1317 |
| Copyright (C)2017 American Megatrends Inc. All Rights Reserved. |
*****
CPUID = 50662
Reading flash ..... done
- ME Data Size checking - ok
- FFS checksums ..... ok
- Check RomLayout ..... Ok
Erasing Boot Block ..... done
Updating Boot Block ..... done
Verifying Boot Block ..... done
Erasing Main Block ..... 0x00132000 (0x)
```

```
Verifying NDB Block ..... done
- Update success for FDR
- Update success for IE
- Successful Update Recovery Loader to OPRx!!
- Successful Update MFSB!!
- Successful Update FTFR!!
- Successful Update MFS, IVB1 and IVB2!!
- Successful Update FLOG and UTOX!!
- ME Entire Image update success !!
WARNING : System must power-off to have the changes take effect!
Moving F50:\FUD00\SKJFME2_03162017\afuef1x64.efi -> F50:\FUD00\SKJFME2_03162017\af
uef1.sec
- [ok]
Moving F50:\FUD00\SKJFME2_03162017\afuef1x64.efi -> F50:\FUD00\SKJFME2_0316201
7\afuef1.sec
- [ok]
*****
* Please ignore this 'Shell: Cannot read from file - Device Error'
* warning message due to it does not impact flashing process.
*****
Deleting "afuef1.sec"
Delete successful.
FS0:\>
```

- The screen above indicates that the BIOS update process is complete. When you see the screen above, unplug the AC power cable from the power supply, clear CMOS, and plug the AC power cable in the power supply again to power on the system.
- Press `` to enter the BIOS Setup utility.
- Press `<F3>` to load the default settings.
- After loading the default settings, press `<F4>` to save the settings and exit the BIOS Setup utility.