



X13SET-G/-GC

USER'S MANUAL

Revision 1.1

The information in this user's manual has been carefully reviewed and is believed to be accurate. The manufacturer assumes no responsibility for any inaccuracies that may be contained in this document, and makes no commitment to update or to keep current the information in this manual, or to notify any person or organization of the updates. **Please Note: For the most up-to-date version of this manual, please see our website at [www.supermicro.com](http://www.supermicro.com).**

Super Micro Computer, Inc. ("Supermicro") reserves the right to make changes to the product described in this manual at any time and without notice. This product, including software and documentation, is the property of Supermicro and/ or its licensors, and is supplied only under a license. Any use or reproduction of this product is not allowed, except as expressly permitted by the terms of said license.

IN NO EVENT WILL Super Micro Computer, Inc. BE LIABLE FOR DIRECT, INDIRECT, SPECIAL, INCIDENTAL, SPECULATIVE OR CONSEQUENTIAL DAMAGES ARISING FROM THE USE OR INABILITY TO USE THIS PRODUCT OR DOCUMENTATION, EVEN IF ADVISED OF THE POSSIBILITY OF SUCH DAMAGES. IN PARTICULAR, SUPER MICRO COMPUTER, INC. SHALL NOT HAVE LIABILITY FOR ANY HARDWARE, SOFTWARE, OR DATA STORED OR USED WITH THE PRODUCT, INCLUDING THE COSTS OF REPAIRING, REPLACING, INTEGRATING, INSTALLING OR RECOVERING SUCH HARDWARE, SOFTWARE, OR DATA.

Any disputes arising between manufacturer and customer shall be governed by the laws of Santa Clara County in the State of California, USA. The State of California, County of Santa Clara shall be the exclusive venue for the resolution of any such disputes. Supermicro's total liability for all claims will not exceed the price paid for the hardware product.

FCC Statement: This equipment has been tested and found to comply with the limits for a Class A digital device pursuant to Part 15 of the FCC Rules. These limits are designed to provide reasonable protection against harmful interference when the equipment is operated in a commercial environment. This equipment generates, uses, and can radiate radio frequency energy and, if not installed and used in accordance with the manufacturer's instruction manual, may cause harmful interference with radio communications. Operation of this equipment in a residential area is likely to cause harmful interference, in which case you will be required to correct the interference at your own expense.

California Best Management Practices Regulations for Perchlorate Materials: This Perchlorate warning applies only to products containing CR (Manganese Dioxide) Lithium coin cells. "Perchlorate Material-special handling may apply. See [www.dtsc.ca.gov/hazardouswaste/perchlorate](http://www.dtsc.ca.gov/hazardouswaste/perchlorate)".



**WARNING:** This product can expose you to chemicals including lead, known to the State of California to cause cancer and birth defects or other reproductive harm. For more information, go to [www.P65Warnings.ca.gov](http://www.P65Warnings.ca.gov).

The products sold by Supermicro are not intended for and will not be used in life support systems, medical equipment, nuclear facilities or systems, aircraft, aircraft devices, aircraft/emergency communication devices or other critical systems whose failure to perform be reasonably expected to result in significant injury or loss of life or catastrophic property damage. Accordingly, Supermicro disclaims any and all liability, and should buyer use or sell such products for use in such ultra-hazardous applications, it does so entirely at its own risk. Furthermore, buyer agrees to fully indemnify, defend and hold Supermicro harmless for and against any and all claims, demands, actions, litigation, and proceedings of any kind arising out of or related to such ultra-hazardous use or sale.

Manual Revision 1.1

Release Date: September 03, 2024

Unless you request and receive written permission from Super Micro Computer, Inc., you may not copy any part of this document. Information in this document is subject to change without notice. Other products and companies referred to herein are trademarks or registered trademarks of their respective companies or mark holders.

Copyright © 2024 by Super Micro Computer, Inc.  
All rights reserved.

**Printed in the United States of America**

# Preface

## About This Manual

This manual is written for system integrators, IT technicians and knowledgeable end users. It provides information for the installation and use of the motherboard.

## About This Motherboard

The Supermicro X13SET-G/-GC motherboard supports the 4<sup>th</sup>/5<sup>th</sup> Generation Intel® Xeon® Scalable Processors (LGA 4677 in Socket E) with up to 60 cores (4<sup>th</sup> Generation) or 64 cores (5<sup>th</sup> Generation) and a thermal design power (TDP) of 350 W. Built with the Intel C741 chipset, X13SET-G/-GC supports 4 TB of 3DS RDIMM ECC DDR5 memory in 16 memory slots. The 4<sup>th</sup> Generation Intel Xeon Scalable Processor memory has speeds of up to 4800 MT/s (4400 MT/s when fully populated), while the 5<sup>th</sup> Generation Intel Xeon Scalable Processor memory has speeds of up to 5600 MT/s (4400 MT/s when fully populated). This motherboard features superior IO expandability, which includes four MCIO PCIe 5.0 x8 connectors, two SlimSAS ports (can support six SATA via PCH for X13SET-G or six SAS3 via onboard SAS3808 for X13SET-GC), and two hybrid M.2 in the 2280 form factor. This motherboard also offers the most advanced data protection capability that encompasses Trusted Platform Module (TPM) and Root of Trust (RoT) support. X13SET-G/-GC is optimized for high-density, high-end computing platforms for big data, virtualization, and enterprise applications. Note that this motherboard is intended to be installed and serviced by professional technicians only. For processor/memory updates, refer to our website at <http://www.supermicro.com/products/>.

## Conventions Used in the Manual

Special attention should be given to the following symbols for proper installation and to prevent damage done to the components or injury to yourself:



**Warning!** Indicates important information given to prevent equipment/property damage or personal injury.



**Warning!** Indicates high voltage may be encountered while performing a procedure.



**Important:** Important information given to ensure proper system installation or to relay safety precautions.



**Note:** Additional Information given to differentiate various models or to provide information for proper system setup.

## Contacting Supermicro

### Headquarters

Address: Super Micro Computer, Inc.  
980 Rock Ave.  
San Jose, CA 95131 U.S.A.

Tel: +1 (408) 503-8000

Fax: +1 (408) 503-8008

Email: [Marketing@supermicro.com](mailto:Marketing@supermicro.com) (General Information)  
[Sales-USA@supermicro.com](mailto:Sales-USA@supermicro.com) (Sales Inquiries)  
[Government\\_Sales-USA@supermicro.com](mailto:Government_Sales-USA@supermicro.com) (Gov. Sales Inquiries)  
[Support@supermicro.com](mailto:Support@supermicro.com) (Technical Support)  
[RMA@supermicro.com](mailto:RMA@supermicro.com) (RMA Support)  
[Webmaster@supermicro.com](mailto:Webmaster@supermicro.com) (Webmaster)

Website: [www.supermicro.com](http://www.supermicro.com)

### Europe

Address: Super Micro Computer B.V.  
Het Sterrenbeeld 28, 5215 ML  
's-Hertogenbosch, The Netherlands

Tel: +31 (0) 73-6400390

Fax: +31 (0) 73-6416525

Email: [Sales\\_Europe@supermicro.com](mailto:Sales_Europe@supermicro.com) (General Information)  
[Support\\_Europe@supermicro.com](mailto:Support_Europe@supermicro.com) (Technical Support)  
[RMA\\_Europe@supermicro.com](mailto:RMA_Europe@supermicro.com) (RMA Support)

Website: [www.supermicro.nl](http://www.supermicro.nl)

### Asia-Pacific

Address: Super Micro Computer, Inc.  
3F, No. 150, Jian 1st Rd.  
Zhonghe Dist., New Taipei City 235  
Taiwan (R.O.C)

Tel: +886-(2) 8226-3990

Fax: +886-(2) 8226-3992

Email: [Sales-Asia@supermicro.com.tw](mailto:Sales-Asia@supermicro.com.tw) (Sales Inquiry)  
[Support@supermicro.com.tw](mailto:Support@supermicro.com.tw) (Technical Support)  
[RMA@supermicro.com.tw](mailto:RMA@supermicro.com.tw) (RMA Support)

Website: [www.supermicro.com.tw](http://www.supermicro.com.tw)

# Table of Contents

## **Chapter 1 Introduction**

1.1 Important Links.....	9
Quick Reference .....	13
Quick Reference Table.....	14
Motherboard Features.....	15
1.2 Processor and Chipset Overview.....	18
1.3 Special Features .....	18
Recovery from AC Power Loss.....	18
1.4 System Health Monitoring.....	19
Onboard Voltage Monitors .....	19
Fan Status Monitor with Firmware Control .....	19
Environmental Temperature Control .....	19
1.5 ACPI Features.....	19
1.6 Power Supply.....	19
1.7 Serial Port.....	20

## **Chapter 2 Installation**

2.1 Static-Sensitive Devices.....	21
Precautions .....	21
Unpacking .....	21
2.2 Processor and Heatsink Installation.....	22
The 4 <sup>th</sup> /5 <sup>th</sup> Generation Intel Xeon Scalable Processor.....	22
Overview of the Processor Carrier Assembly.....	23
Overview of the CPU Socket.....	23
Overview of the Processor Heatsink Module.....	24
Creating the Processor Carrier Assembly.....	25
Assembling the Processor Heatsink Module .....	26
Preparing the CPU Socket for Installation.....	27
Installing the Processor Heatsink Module.....	28
Removing the Processor Heatsink Module.....	29

2.3	Motherboard Installation.....	30
	Tools Needed .....	30
	Location of Mounting Holes .....	30
	Installing the Motherboard.....	31
2.4	Memory Support and Installation .....	32
	Memory Support.....	32
	General Guidelines for Optimizing Memory Performance .....	35
	DIMM Installation .....	36
	DIMM Removal .....	36
2.5	Front I/O Connectors.....	37
2.6	Connectors .....	39
	Power Connections .....	39
	Headers.....	40
2.7	Jumper Settings .....	45
	How Jumpers Work.....	45
2.8	LED Indicators.....	48
<b><i>Chapter 3 Troubleshooting</i></b>		
3.1	Troubleshooting Procedures .....	50
	Before Power On .....	50
	No Power .....	50
	System Boot Failure .....	51
	Memory Errors .....	51
	Losing the System's Setup Configuration.....	51
	When the System Becomes Unstable .....	52
3.2	Technical Support Procedures .....	54
3.3	Frequently Asked Questions .....	55
3.4	Battery Removal and Installation .....	56
	Battery Removal.....	56
	Proper Battery Disposal .....	56
	Battery Installation.....	56
3.5	Returning Merchandise for Service.....	57

**Chapter 4 UEFI BIOS**

4.1 Introduction .....	58
4.2 Main Setup .....	59
4.3 Advanced Setup Configurations .....	61
4.4 Event Logs .....	101
4.5 BMC.....	103
4.6 Security.....	107
4.7 Boot .....	112
4.8 Save & Exit.....	114

**Appendix A Software****Appendix B Standardized Warning Statements**

# Chapter 1

## Introduction

Congratulations on purchasing your computer motherboard from an industry leader. Supermicro motherboards are designed to provide you with the highest standards in quality and performance.



**Note:** This motherboard was designed to be a part of an integrated server solution. No shipping package will be included in the shipment.

### 1.1 Important Links

For your system to work properly, follow the links below to download all necessary drivers/utilities and the user's manual for your server.

- Supermicro product manuals: <http://www.supermicro.com/support/manuals/>
- Product drivers and utilities: <https://www.supermicro.com/wdl/driver/>
- Product safety info: [http://www.supermicro.com/about/policies/safety\\_information.cfm](http://www.supermicro.com/about/policies/safety_information.cfm)
- Frequently Asked Questions: <https://www.supermicro.com/FAQ/index.php>
- A secure data deletion tool designed to fully erase all data from storage devices can be found at our website: [https://www.supermicro.com/about/policies/disclaimer.cfm?url=/wdl/utility/Lot9\\_Secure\\_Data\\_Deletion\\_Utility/](https://www.supermicro.com/about/policies/disclaimer.cfm?url=/wdl/utility/Lot9_Secure_Data_Deletion_Utility/)
- If you have any questions, contact our support team at: [support@supermicro.com](mailto:support@supermicro.com)

This manual may be periodically updated without notice. Check the Supermicro website for possible updates to the manual revision level.

Figure 1-1. X13SET-G Motherboard Image

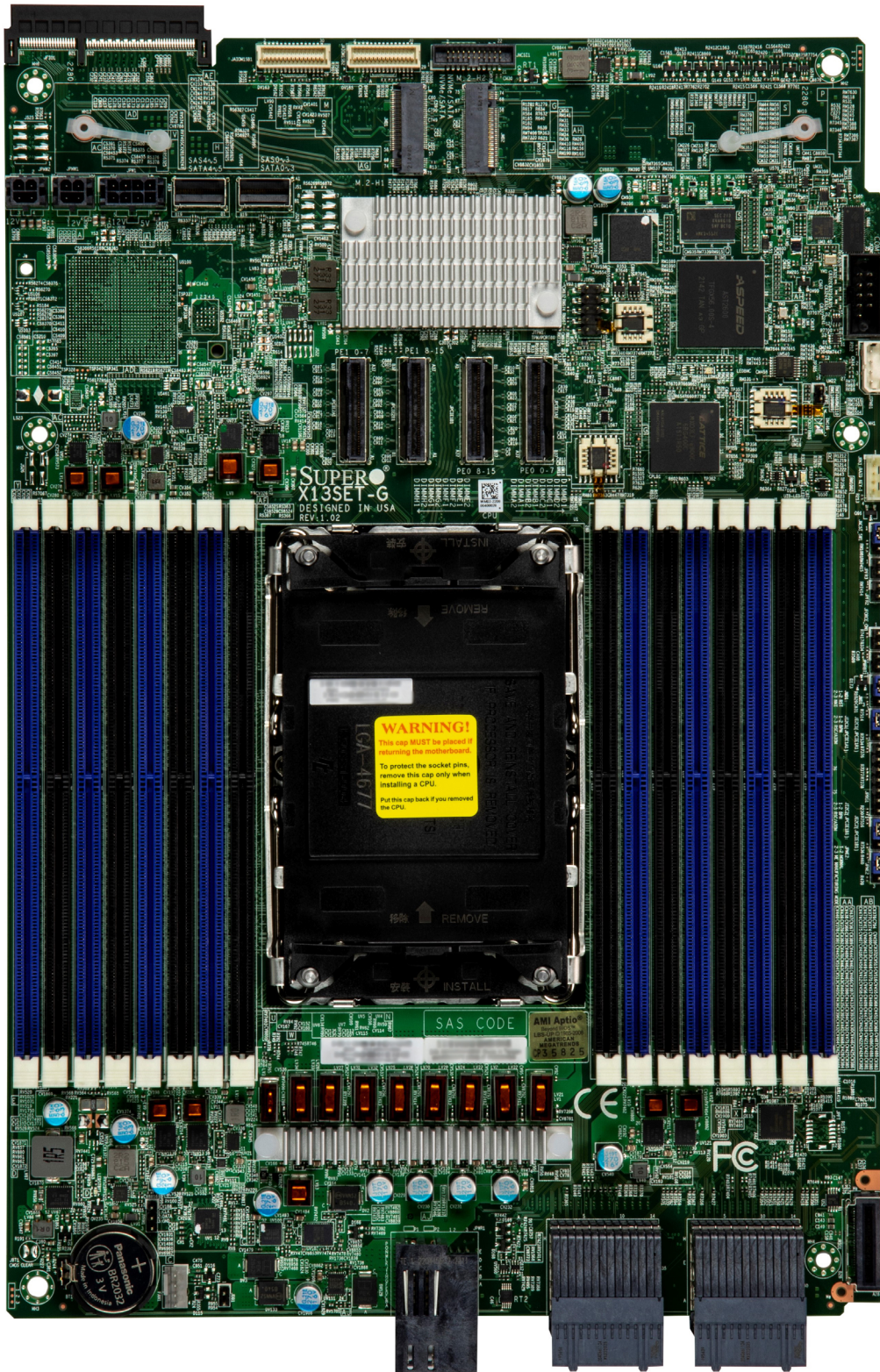



 **Note:** All graphics shown in this manual were based upon the latest PCB revision available at the time of publication of the manual. The motherboard you received may or may not look exactly the same as the graphics shown in this manual.

Figure 1-2. X13SET-GC Motherboard Image

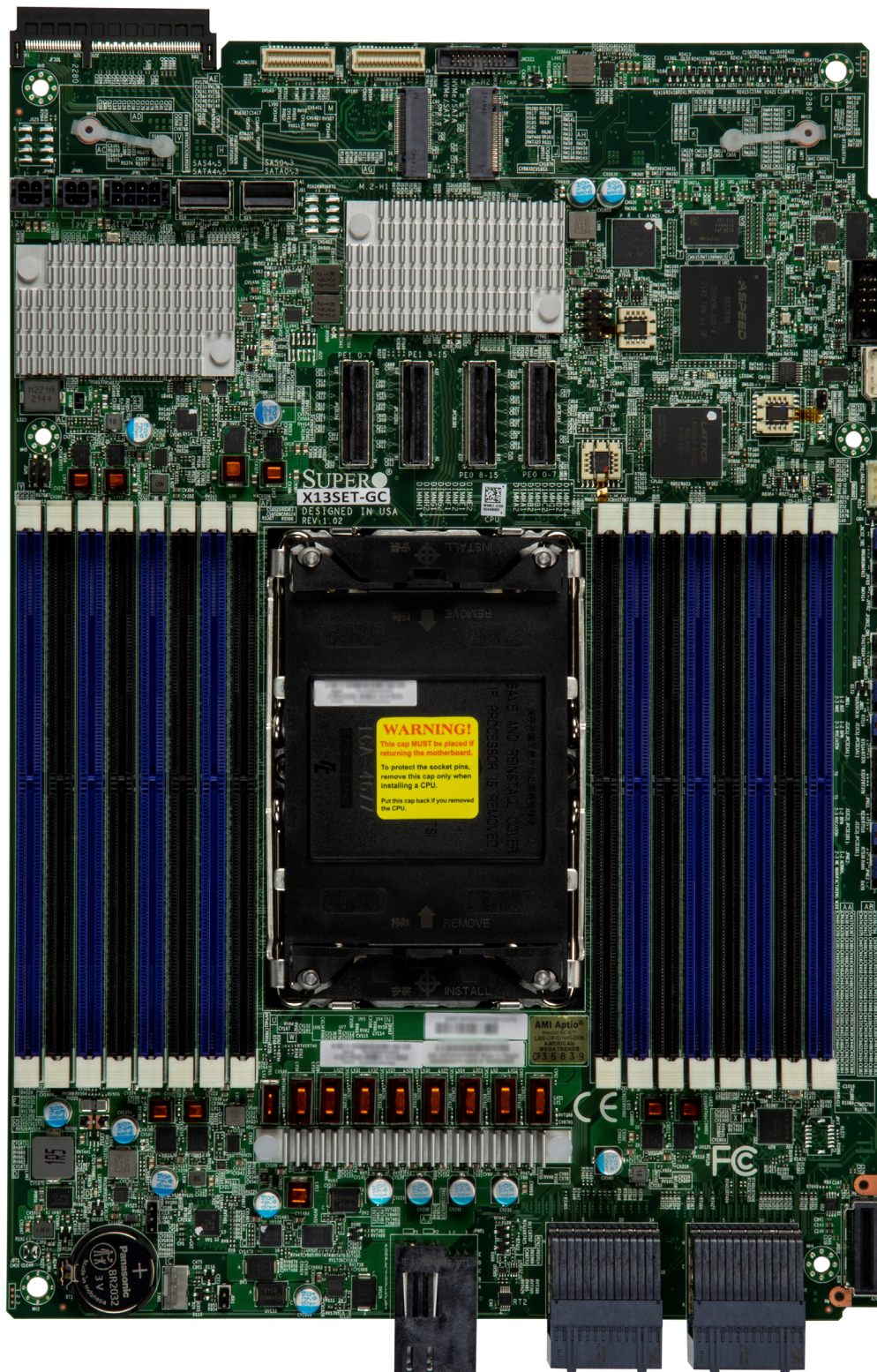

 **Note:** All graphics shown in this manual were based upon the latest PCB revision available at the time of publication of the manual. The motherboard you received may or may not look exactly the same as the graphics shown in this manual.

**Figure 1-3. X13SET-G Motherboard Layout**  
(not drawn to scale)

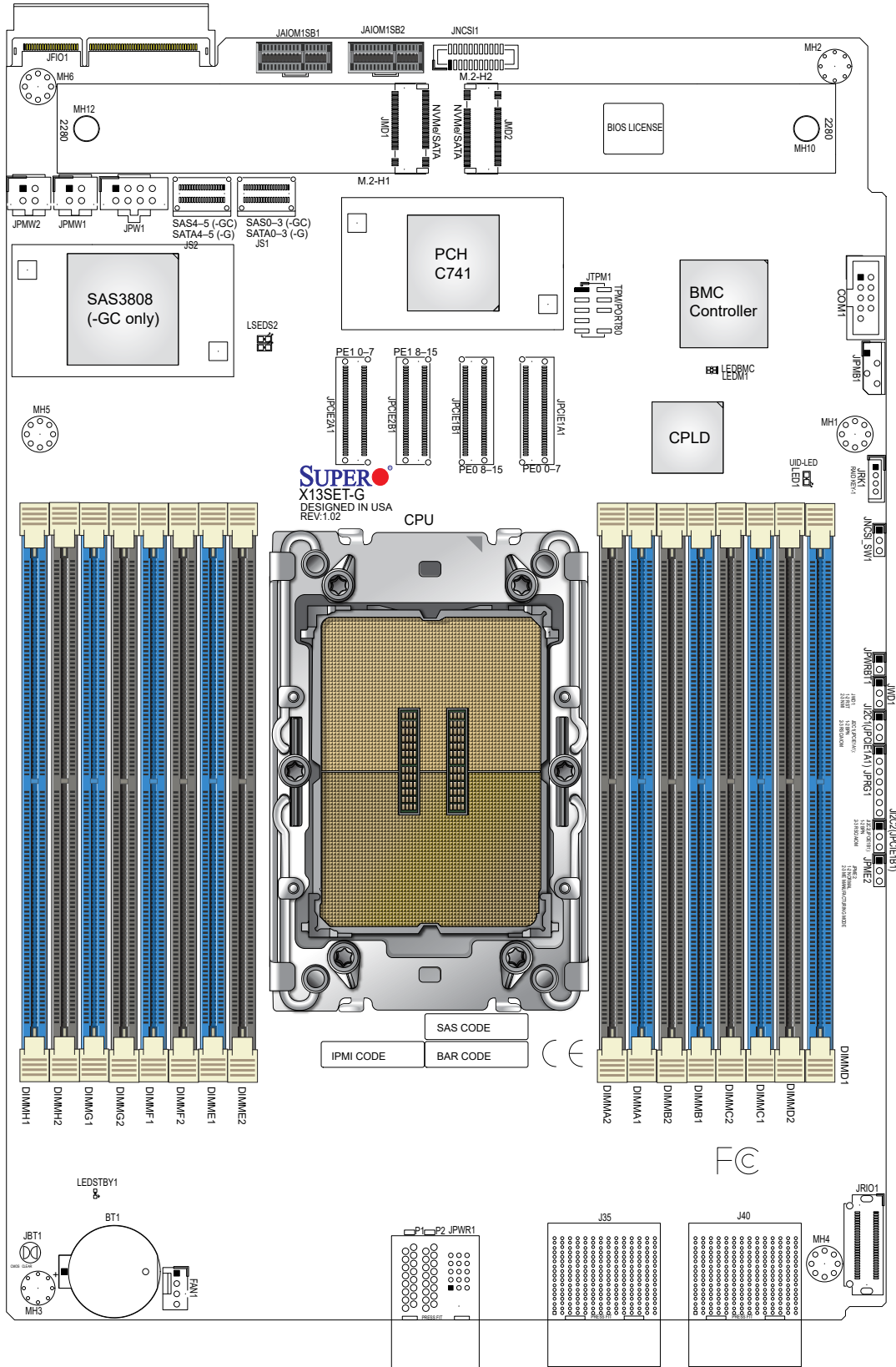

**Note:** Components not documented are for internal testing only.

## Quick Reference

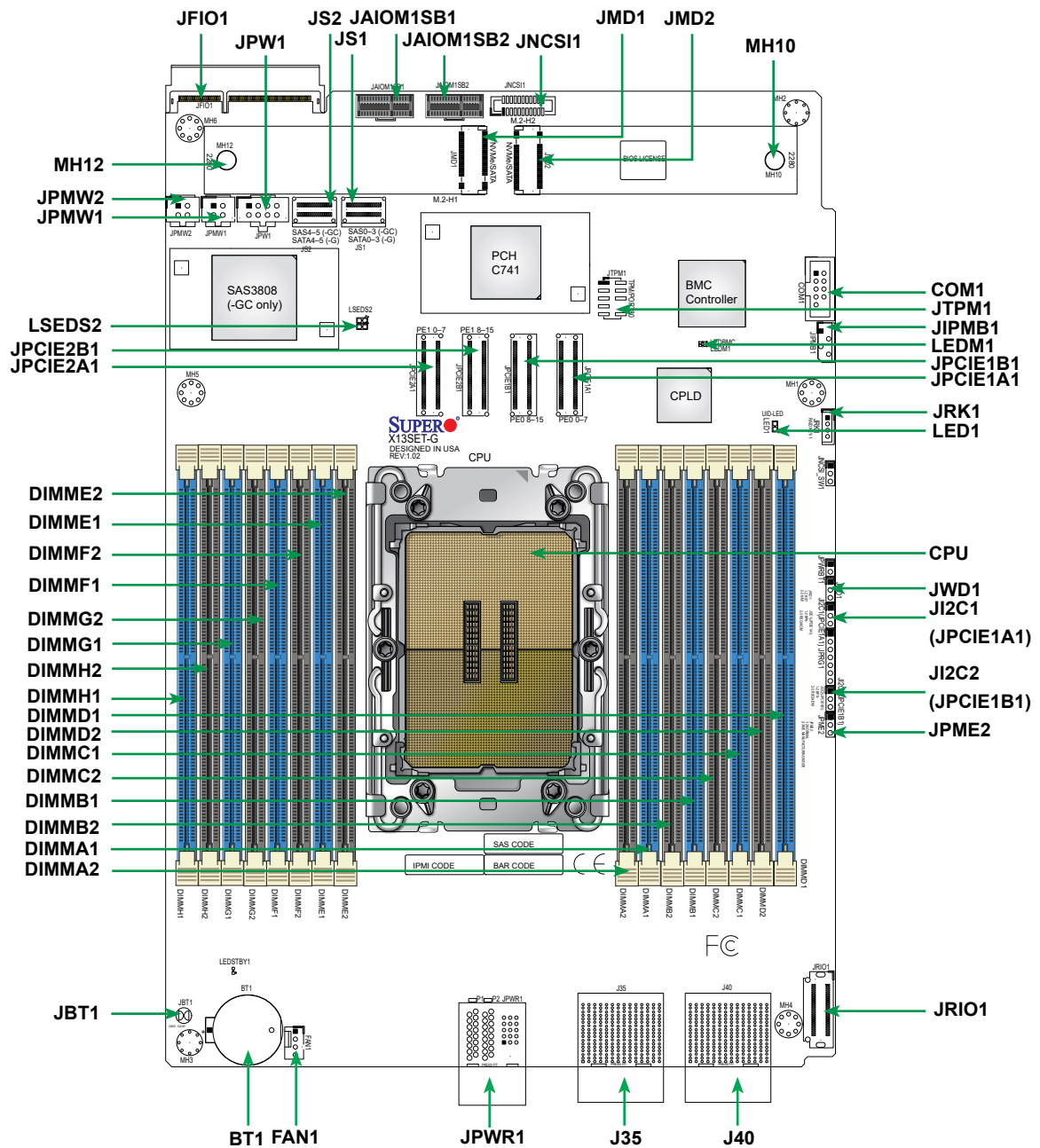

## Notes:

- See [Chapter 2](#) for detailed information on jumpers, I/O ports, and JF1 front panel connections.
- "■" indicates the location of Pin 1.
- Jumpers/LED indicators not indicated are used for testing only.
- Use only the correct type of onboard CMOS battery as specified by the manufacturer. Do not install the onboard battery upside down to avoid possible explosion.

## Quick Reference Table

<b>Jumper</b>	<b>Description</b>	<b>Default Setting</b>
JBT1	CMOS Clear	Open (Normal)
J1°C1, J1°C2	Backplane or Riser Card/AIOM Enable	Pins 1–2 (BPN) Pins 2–3 (RSC/AIOM)
JPME2	ME Manufacturing Mode	Pins 1–2 (Normal)
JWD1	Watchdog Timer	Pins 1–2 (Reset)
<b>LED</b>	<b>Description</b>	<b>Status</b>
LED1	UID LED	Solid Blue: Unit Identified
LEDM1	BMC Heartbeat	Blinking Green: BMC Normal
LSEDS2	SAS Heartbeat	Blinking Green: SAS Active
<b>Connector</b>	<b>Description</b>	
AIOM1SB1	AIOM1 Sideband Signals Header	
AIOM1SB2	AIOM2 Sideband Signals Header	
BT1	Onboard Battery	
COM1	COM Header	
JFIO	Grand Twin Front IPMI And Onboard NIC Module Connector	
FAN1	CPU/System Fan Header (FAN1: CPU Fan)	
J35, J40	Molex Impel Plus Connectors	
JIPMB1	System Management Bus Header (for IPMI only)	
JMD1, JMD2	M.2 PCIe 3.0 x4 Slots and SATA	
JNCSI1	NC-SI (Network Controller Sideband Interface) Connector	
JPCIE1A1	PE0 0–7 PCIe Connector	
JPCIE1B1	PE0 8–15 PCIe Connector	
JPCIE2A1	PE1 0–7 PCIe Connector	
JPCIE2B1	PE1 8–15 PCIe Connector	
JPMW1, JPMW2	Power Connectors for PCIe or GPU	
JPW1	Power Connector for Storage Backplane	
JPWR1	BPN-PDB-GT214 Connector for Power Supply	
JRIO1	Connector for Rear I/O Module	
JRK1	Intel RAID Key Header	
JS1	SAS0–3/SATA0–3	
JS2	SAS4–5/SATA4–5	
JTPM1	Trusted Platform Module/Port 80 Connector	
MH10, MH12	M.2 Mounting Holes	

## Motherboard Features

<b>Motherboard Features</b>	
<b>CPU</b>	
<ul style="list-style-type: none"> <li>Supports the 4<sup>th</sup>/5<sup>th</sup> Generation Intel Xeon Scalable Processors (LGA 4677 in Socket E) with up to 60 cores (4<sup>th</sup> Generation) or 64 cores (5<sup>th</sup> Generation) and a thermal design power (TDP) of up to 350 W</li> </ul>	
<b>Memory</b>	
<ul style="list-style-type: none"> <li>Up to 4 TB of 3DS RDIMM ECC DDR5 DDR5 memory</li> <li>Memory speeds of up to 4800 MT/s (DDR5-4400 MT/s when fully populated) in 16 memory slots (4<sup>th</sup> Generation Intel Xeon)</li> <li>Memory speeds of up to 5600 MT/s (DDR5-4400 MT/s when fully populated) in 16 memory slots (5<sup>th</sup> Generation Intel Xeon)</li> </ul>	
<b>DIMM Size</b>	
<ul style="list-style-type: none"> <li>16 GB, 24 GB, 32 GB, 48 GB, 64 GB, 96 GB, 128 GB, 256 GB</li> </ul>	
 <b>Note:</b> For the latest CPU/memory updates, refer to our website at <a href="http://www.supermicro.com/products/motherboard">http://www.supermicro.com/products/motherboard</a> .	
<b>Chipset</b>	
<ul style="list-style-type: none"> <li>Intel C741 PCH</li> </ul>	
<b>Expansion Slots</b>	
<ul style="list-style-type: none"> <li>One PCIe 5.0 x8 4C customized 124-pin SLIM COOL EDGE connector (for front I/O module)</li> <li>Two PCIe 5.0 x16 Molex Impel Plus connectors</li> <li>Four MCIO PCIe 5.0 x8 connectors</li> <li>Six SAS3 ports via onboard LSI3808 (PCIe 4.0 x8) for X13SET-GC</li> <li>Two M.2 PCIe 3.0 x4 and SATA in 2280</li> </ul>	
<b>Baseboard Management Controller</b>	
<ul style="list-style-type: none"> <li>Aspeed AST2600 BMC with RoT support</li> </ul>	
<b>Graphics</b>	
<ul style="list-style-type: none"> <li>Aspeed AST2600</li> </ul>	
<b>I/O Devices</b>	
<ul style="list-style-type: none"> <li>SATA 3.0: Two SlimSASx4 ports for six SATA via PCH for X13SET-G</li> <li>SAS 3.0: Two SlimSASx4 ports for six SAS via onboard SAS3808 for X13SET-GC</li> <li>One NC-SI header</li> <li>One E1.S connector (reserved for Rear I/O board)</li> <li>One COM header</li> <li>One TPM header</li> <li>One RAID Key header</li> </ul>	



**Note:** The table above is continued on the next page.

## Motherboard Features

### BIOS

- 256 Mb SPI AMI® BIOS
- ACPI 6.0, Plug and Play (PnP), BIOS rescue hot-key, riser card auto detection support, and SMBIOS 3.0 or later
- SPI dual/quad speed support
- Real Time Clock (RTC) wakeup

### Power Management

- ACPI power management
- Wake-on-LAN
- Power-on mode for AC power recovery

### System Health Monitoring

- Onboard voltage monitoring for +3.3 V, +5 V, +12 V, +3.3 V Stb, +5 Stb, Vcore, Vmem, CPU temperature, PCH temperature, system temperature, memory temperature, and peripheral temperature
- CPU thermal trip support
- Platform Environment Control Interface (PECI)/TSI

### Fan Control

- Low-noise fan speed control
- One 4-pin fan header (spare)

### System Management

- Trusted Platform Module (TPM) support
- Server Platform Service
- IPMI View, SMCIPMITOOL, IPMICFG, SDO, SPM, SSM, SUM-OOB

### Dimensions

- 12.42" x 8.52" (315.47 mm x 216.41 mm) (W x L), proprietary FF



**Note 1:** The CPU maximum thermal design power (TDP) is subject to chassis and heatsink cooling restrictions. For proper thermal management, check the chassis and heatsink specifications for proper CPU TDP sizing.



**Note 2:** For IPMI configuration instructions, refer to the Embedded IPMI Configuration User's Guide available at <http://www.supermicro.com/support/manuals/>.

**Figure 1-4.**  
**System Block Diagram**

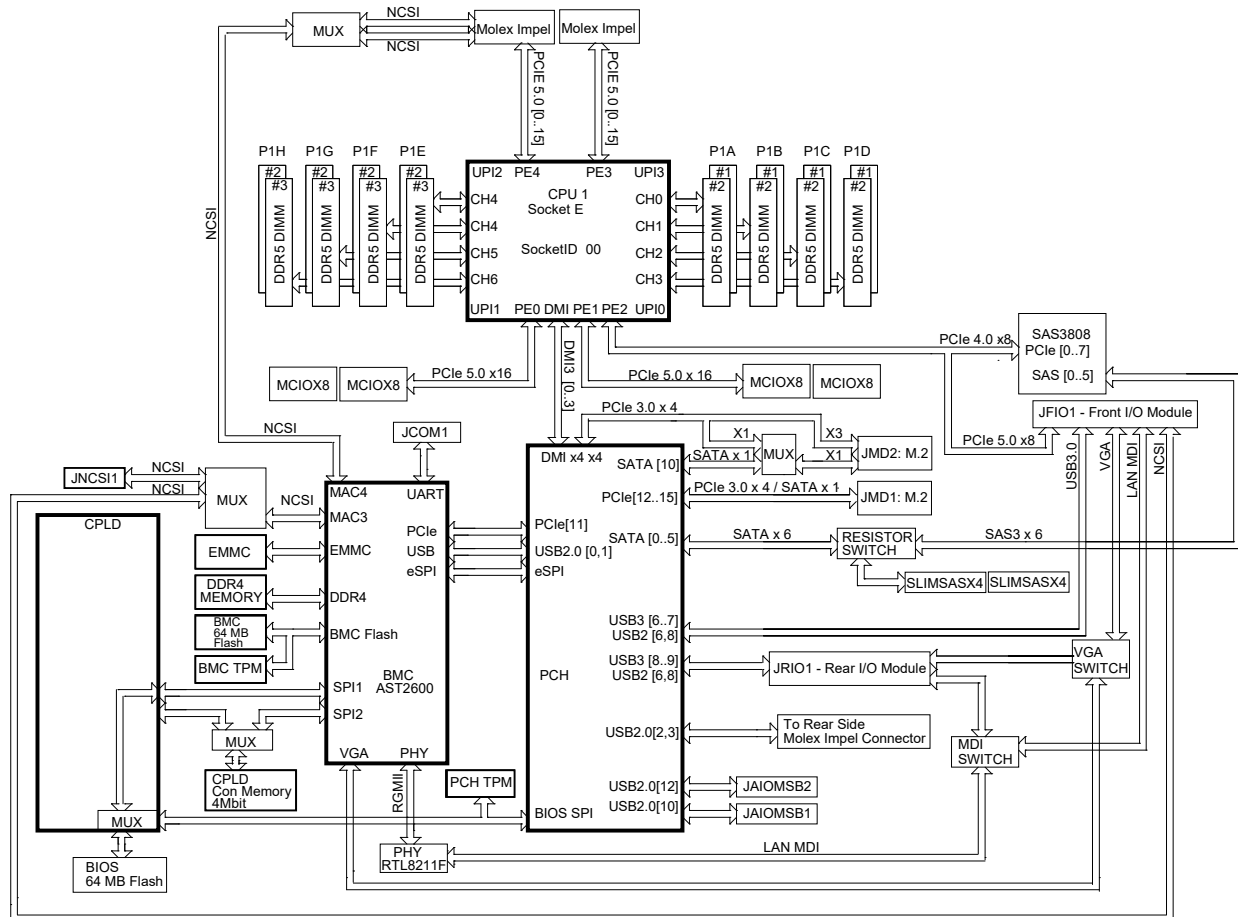

**Note:** This is a general block diagram and may not exactly represent the features on your motherboard. See the previous pages for the actual specifications of your motherboard.

## 1.2 Processor and Chipset Overview

Built upon the functionality and capability of the 4<sup>th</sup>/5<sup>th</sup> Generation Intel Xeon Scalable Processor and the Intel C741 chipset, the X13SET-G/-GC motherboard provides system performance, power efficiency, and feature sets to address the needs of next-generation computer users.

The X13SET-G/-GC dramatically increases system performance for a multitude of server applications and supports:

- Support for Management Engine (ME)
- Support of SMBus speeds of up to 400 KHz for BMC connectivity
- Intel Rapid Storage Technology Enterprise
- Intel Virtualization Technology for Directed I/O (VT-d)
- SPI Enhancements
- Intel Node Manager for advanced power monitoring, capping and management for BMC enhancement (see note below)
- BMC supports remote management, virtualization, and the security package for enterprise platforms



**Note:** Node Manager support depends on the power supply used in your system.

## 1.3 Special Features

### Recovery from AC Power Loss

The Basic I/O System (BIOS) provides a setting that determines how the system will respond when AC power is lost and then restored to the system. You can choose for the system to remain powered off (in which case you must press the power switch to turn it back on), or for it to automatically return to the power-on state. See the Advanced BIOS Setup section for this setting. The default setting is **Last State**.

## 1.4 System Health Monitoring

### Onboard Voltage Monitors

An onboard voltage monitor will scan the voltages of the onboard chipset, memory, CPU, and battery continuously. Once a voltage becomes unstable, a warning is given, or an error message is sent to the screen. The user can adjust the voltage thresholds to define the sensitivity of the voltage monitor.

### Fan Status Monitor with Firmware Control

The system health monitor embedded in the BMC chip can check the RPM status of the cooling fans. The CPU and chassis fans are controlled via IPMI.

### Environmental Temperature Control

System Health sensors monitor temperatures and voltage settings of onboard processors and the system in real time via the IPMI interface. Whenever the temperature of the CPU or the system exceeds a user-defined threshold, system/CPU cooling fans will be turned on to prevent the CPU or the system from overheating.



**Note:** To avoid possible system overheating, be sure to provide adequate airflow to your system.

## 1.5 ACPI Features

The Advanced Configuration and Power Interface (ACPI) specification defines a flexible and abstract hardware interface that provides a standard way to integrate power management features throughout a computer system, including its hardware, operating system and application software. This enables the system to automatically turn on and off peripherals such as CD-ROMs, network cards, hard disk drives and printers.

In addition to enabling operating system-directed power management, ACPI also provides a generic system event mechanism for Plug and Play, and an operating system-independent interface for configuration control. ACPI leverages the Plug and Play BIOS data structures, while providing a processor architecture-independent implementation that is compatible with appropriate Windows operating systems. For detailed information regarding OS support, refer to the Supermicro website.

## 1.6 Power Supply

As with all computer products, a stable power source is necessary for proper and reliable operation. It is even more important for processors that have high CPU clock rates where noisy power transmission is present.

## 1.7 Serial Port

The X13SET-G/-GC motherboard supports one serial communication connection. COM1 can be used for input/output. The UART provides legacy speeds with a baud rate of up to 115.2 Kbps as well as an advanced speed with baud rates of 250 K, 500 K, or 1 Mb/s, which support high-speed serial communication devices.

# Chapter 2

## Installation

### 2.1 Static-Sensitive Devices

Electrostatic Discharge (ESD) can damage electronic components. To avoid damaging your system board, it is important to handle it very carefully. The following measures are generally sufficient to protect your equipment from ESD.

#### Precautions

- Use a grounded wrist strap designed to prevent static discharge.
- Touch a grounded metal object before removing the board from the antistatic bag.
- Handle the motherboard by its edges only; do not touch its components, peripheral chips, memory modules or gold contacts.
- When handling chips or modules, avoid touching their pins.
- Put the motherboard and peripherals back into their antistatic bags when not in use.
- For grounding purposes, make sure that your computer chassis provides excellent conductivity between the power supply, the case, the mounting fasteners and the motherboard.
- Use only the correct type of onboard CMOS battery. Do not install the onboard battery upside down to avoid possible explosion.

#### Unpacking

The motherboard is shipped in antistatic packaging to avoid static damage. When unpacking the motherboard, make sure that the person handling it is static protected.

## 2.2 Processor and Heatsink Installation

The processor (CPU) and processor carrier should be assembled together first to form the processor carrier assembly. This will be attached to the heatsink to form the processor heatsink module (PHM) before being installed onto the CPU socket.

### Notes:

- Use ESD protection.
- Shut down the system and then unplug the AC power cord from all power supplies.
- Check that the plastic protective cover is on the CPU socket and none of the socket pins are bent. If they are, contact your retailer.
- When handling the processor, avoid touching or placing direct pressure on the LGA lands (gold contacts). Improper installation or socket misalignment can cause serious damage to the processor or socket, which may require manufacturer repairs.
- When installing the processor and heatsink, ensure a torque driver set to the correct force is used for each screw.
- Thermal grease is pre-applied on a new heatsink. No additional thermal grease is needed.
- Refer to the Supermicro website for updates on processor support.
- All graphics in this manual are for illustration purposes only. Your components may look different.
- Please order the CPU carrier with the CPU heatsink.

CPU carrier for 4 <sup>th</sup> /5 <sup>th</sup> Generation Intel Xeon Scalable Processors (XCC)	SKT-1333L-0000-FXC
CPU carrier for 4 <sup>th</sup> /5 <sup>th</sup> Generation Intel Xeon Scalable Processors (MCC)	SKT-1424L-001B-FXC
CPU carrier for 4 <sup>th</sup> Generation Intel Xeon Scalable Processors (HBM)	SKT-1425H-001C-FXC

### The 4<sup>th</sup>/5<sup>th</sup> Generation Intel Xeon Scalable Processor

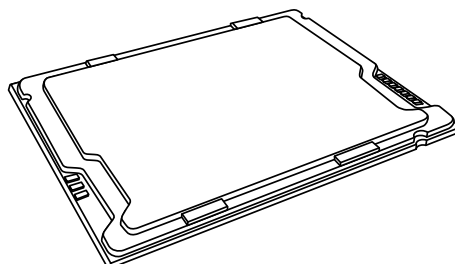

Intel Xeon Processor

## Overview of the Processor Carrier Assembly

The processor carrier assembly contains the Intel Xeon processor and a processor carrier.

### 1. Intel Xeon Processor

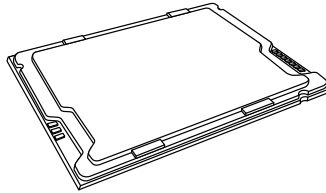

### 2. Processor Carrier

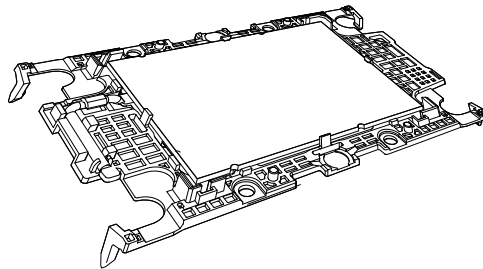

## Overview of the CPU Socket

The CPU socket is protected by a plastic protective cover.

### 1. Plastic Protective Cover

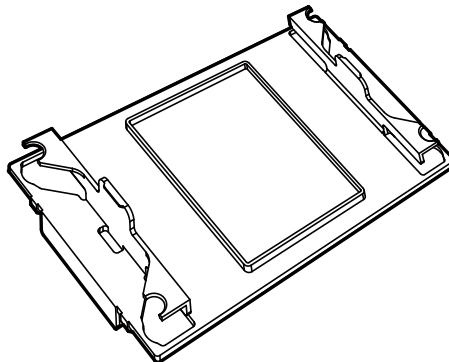

### 2. CPU Socket

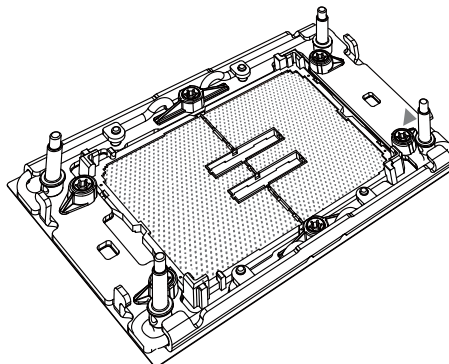

## Overview of the Processor Heatsink Module

The Processor Heatsink Module (PHM) contains a heatsink, a processor carrier, and the Intel Xeon processor.

### 1. Heatsink with Thermal Grease

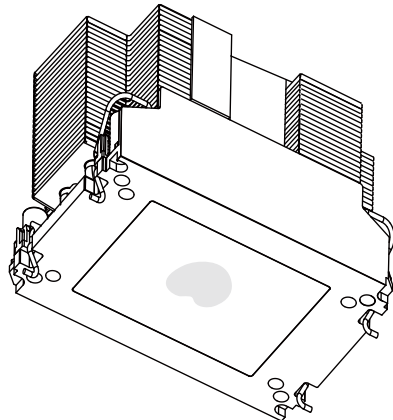

### 2. Processor Carrier

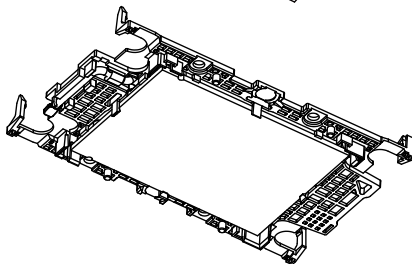

### 3. Intel Xeon Processor

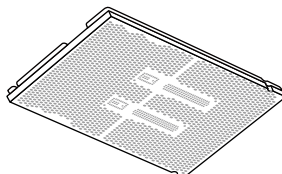

### Processor Heatsink Module (PHM)

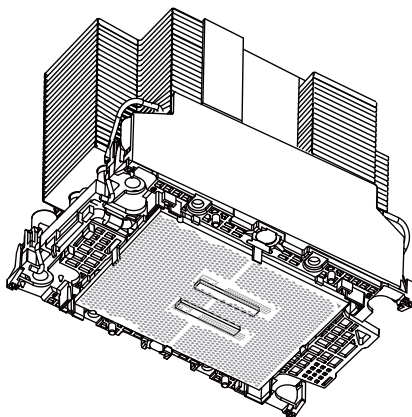

Bottom View

## Creating the Processor Carrier Assembly

To install a processor into the processor carrier, follow the steps below:

1. Before installation, make sure the lever on the processor carrier is pressed down as shown below.
2. Hold the processor with the LGA lands (gold contacts) facing up. Locate the small, gold triangle in the corner of the processor and the corresponding hollowed triangle on the processor carrier. These triangles indicate pin 1. See the images below.
3. Use the triangles as a guide to carefully align and place one end of the processor into the latch marked A, and place the other end of processor into the latch marked B as shown below.
4. Examine all corners to ensure that the processor is firmly attached to the carrier.

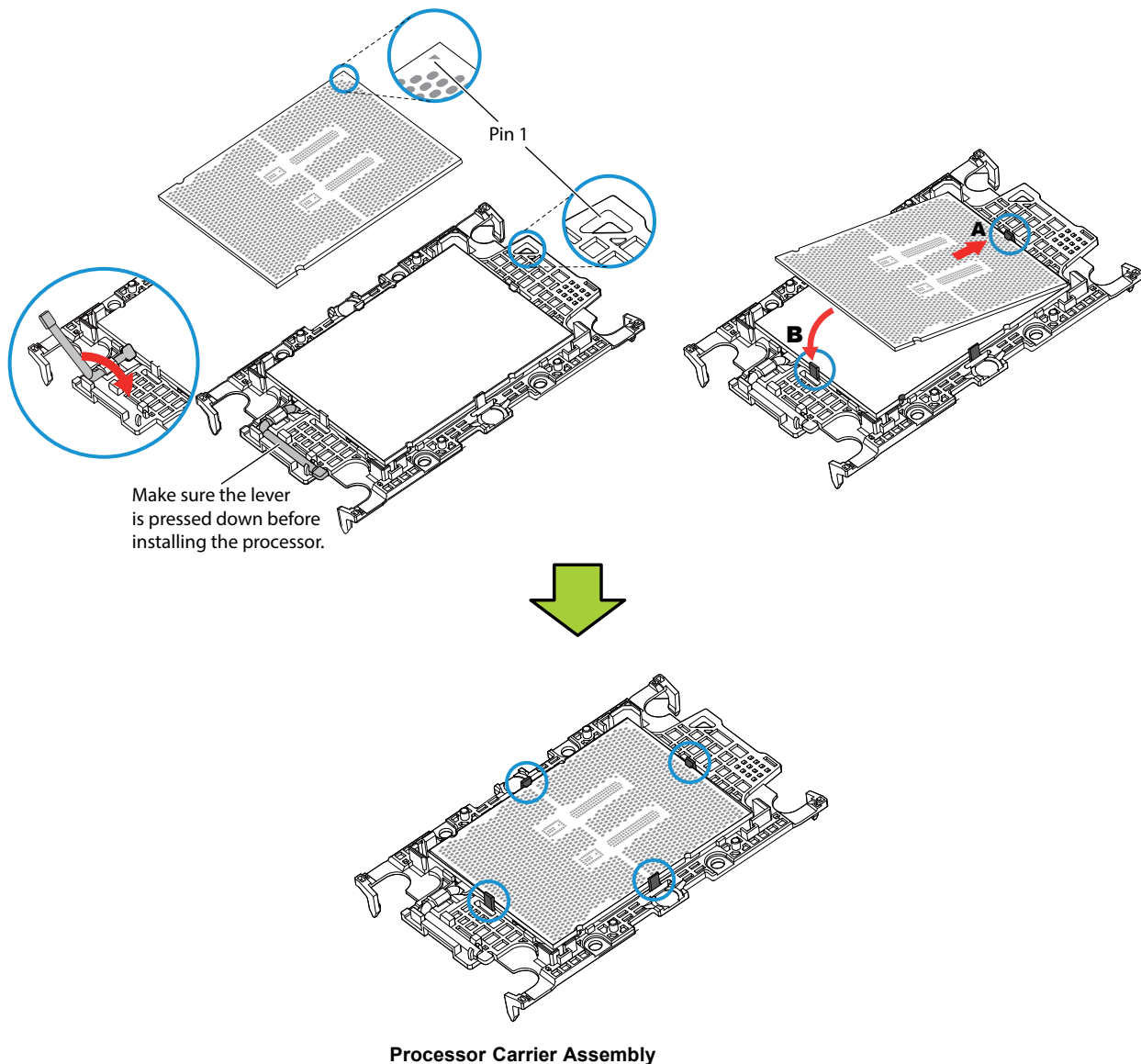

## Assembling the Processor Heatsink Module

After creating the processor carrier assembly for the processor, mount it onto the heatsink to create the processor heatsink module (PHM):

1. Note the label on top of the heatsink, which marks the airflow direction. Turn the heatsink over and orient the heatsink so the airflow arrow is pointing towards the triangle on the processor.
2. If this is a new heatsink, the thermal grease has been pre-applied. Otherwise, apply the proper amount of thermal grease.
3. Hold the processor carrier assembly so the processor's gold contacts are facing up, then align the holes of the processor carrier assembly with the holes on the heatsink. Press the processor carrier assembly down until it snaps into place. The plastic clips of the processor carrier assembly will lock at the four corners.
4. Examine all corners to ensure that the plastic clips on the processor carrier assembly are firmly attached to the heatsink.

Processor Carrier Assembly  
(Upside Down)

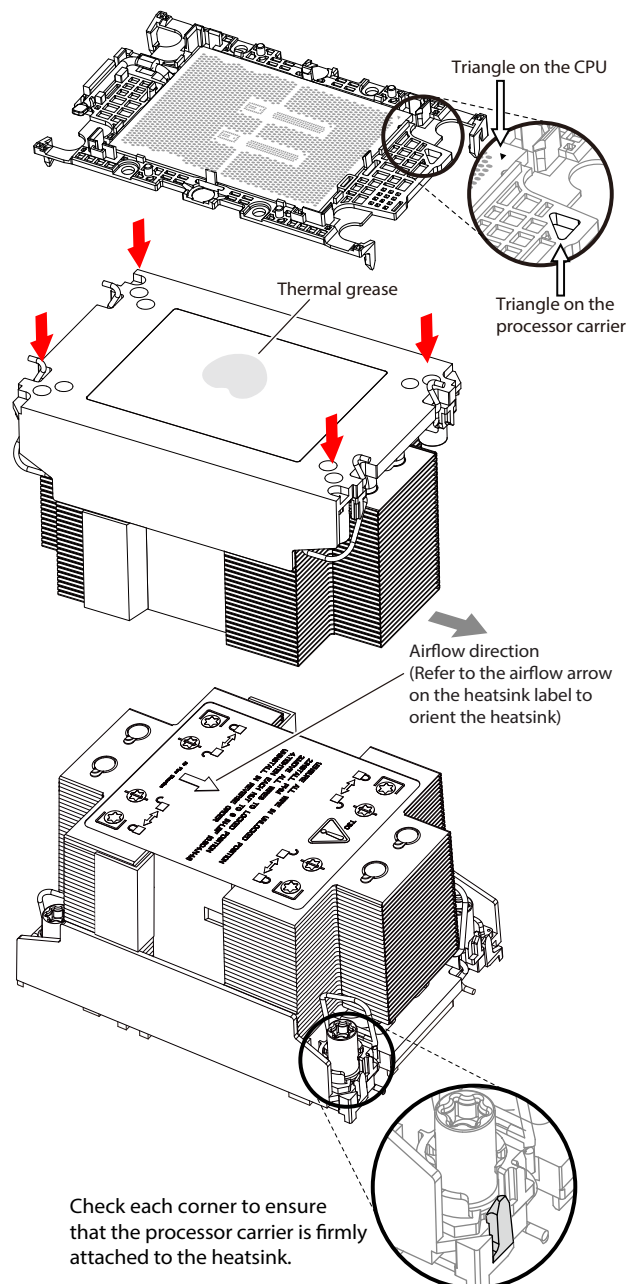

## Preparing the CPU Socket for Installation

This motherboard comes with a plastic protective cover installed on the CPU socket. Remove it from the socket to install the Processor Heatsink Module (PHM). Gently pull up one corner of the plastic protective cover to remove it.

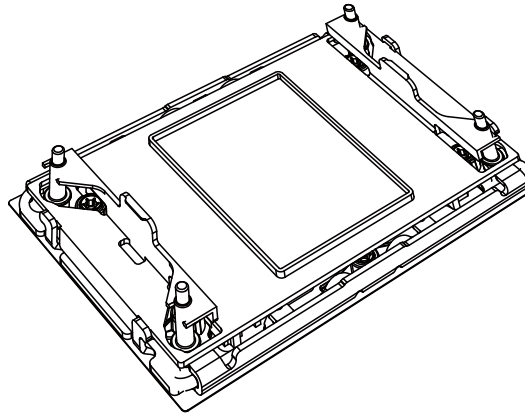

CPU Socket with Plastic Protective Cover

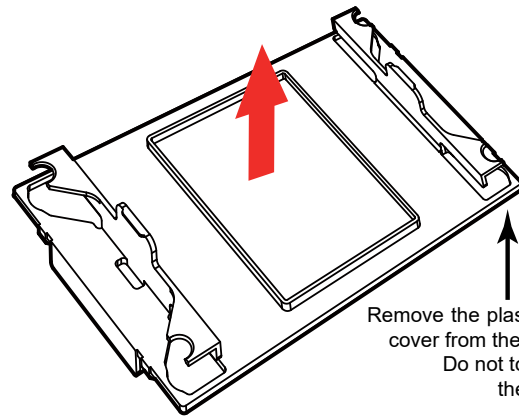

Remove the plastic protective cover from the CPU socket. Do not touch or bend the socket pins.

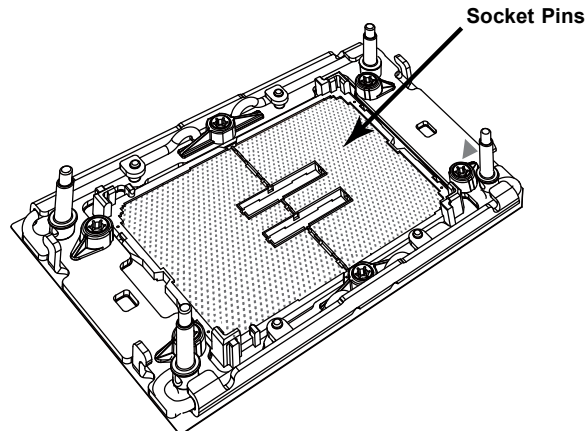

## Installing the Processor Heatsink Module

After assembling the Processor Heatsink Module (PHM), install it onto the CPU socket:

1. Align pin 1 of the PHM with the printed triangle on the CPU socket. See the left image below.
2. Make sure all four holes of the heatsink are aligned with the socket, then gently place the heatsink on top of the CPU socket.
3. Press all four rotating wires outwards and make sure that the heatsink is securely latched into the CPU socket.
4. With a T30 bit torque driver set to a force of 8.0 in-lbf (0.904 N-m), gradually tighten the four screws to ensure even pressure. You can start with any screw, but make sure to tighten the screws in a diagonal pattern.



**Important:** Do not use a force greater than 8.0 in-lbf (0.904 N-m). Exceeding this force may over-torque the screw, causing damage to the processor, heatsink, and screw.

5. Examine all corners to ensure that the PHM is firmly attached to the socket.

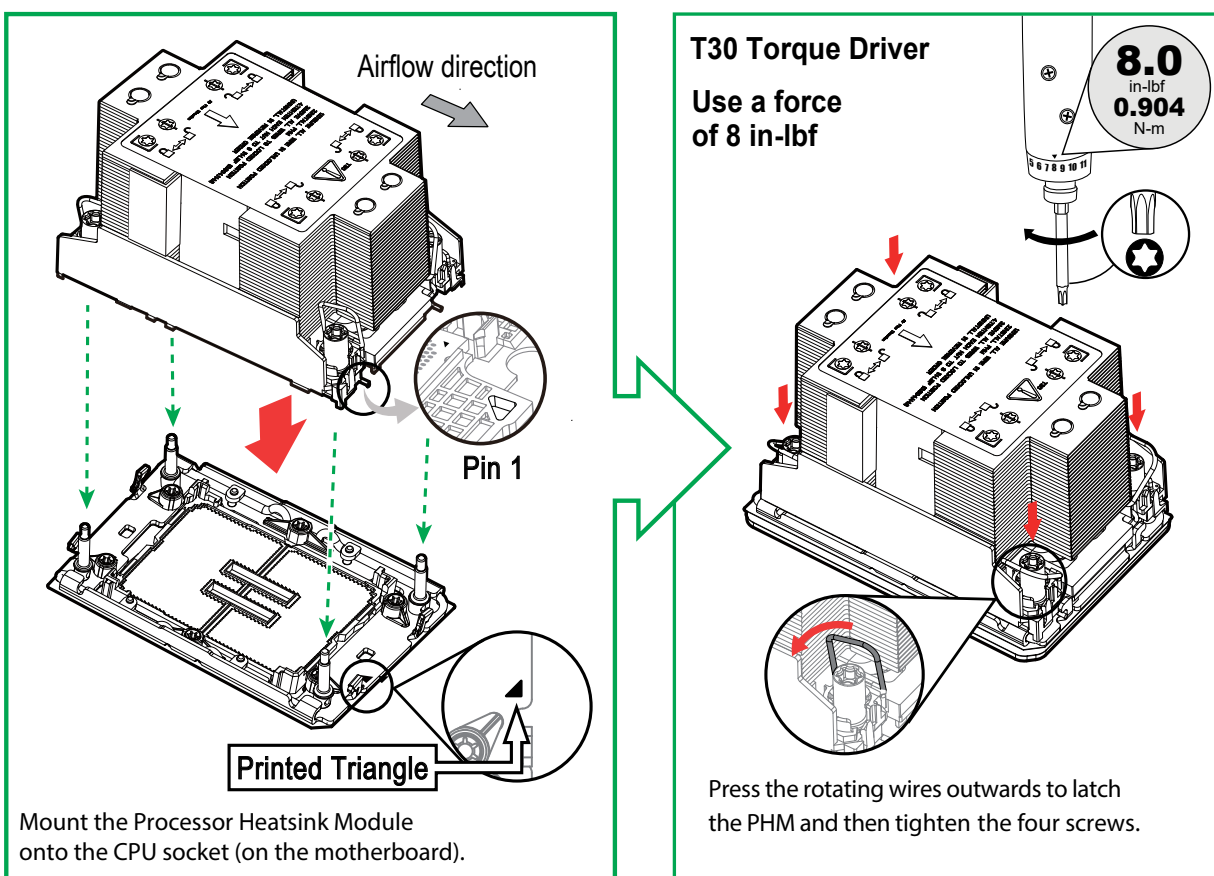

## Removing the Processor Heatsink Module

Before removing the processor heatsink module (PHM) from the motherboard, shut down the system and then unplug the AC power cord from all power supplies.

Then follow the steps below:

1. Use a T30 torx-bit screwdriver to loosen the four screws. You can start with any screw, but make sure to loosen the screws in a diagonal pattern.
2. Press the four rotating wires inwards to unlatch the PHM from the socket.
3. Gently lift the PHM upwards to remove it from the socket.
4. To remove the CPU, move the lever to its unlocked position and gently remove the CPU.

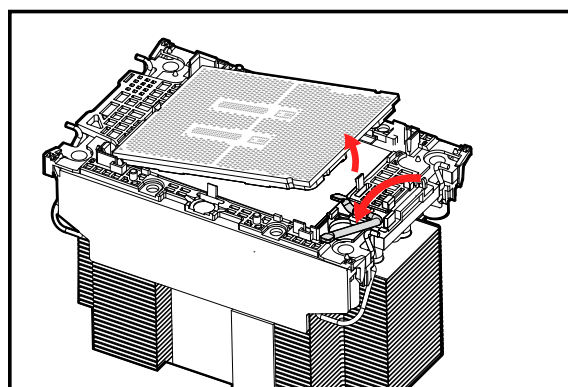
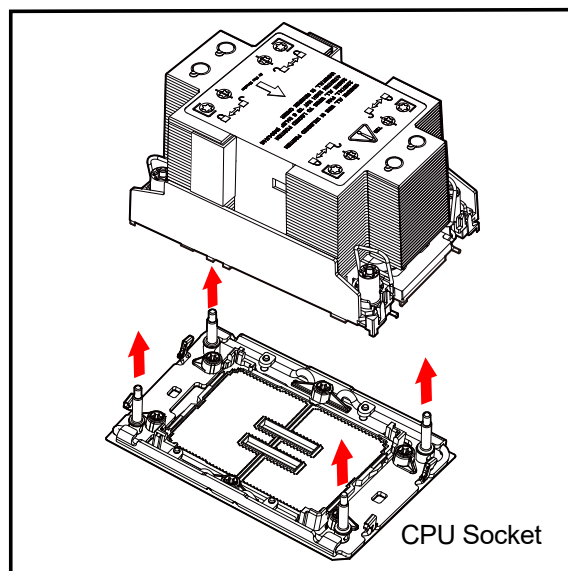
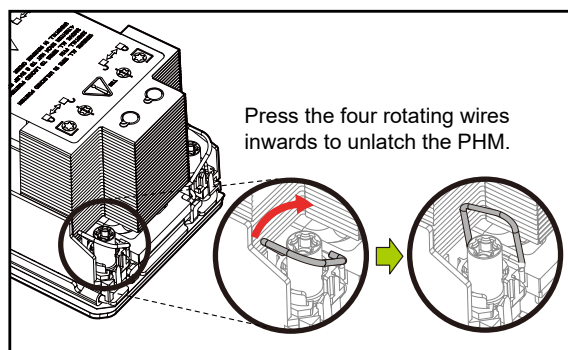
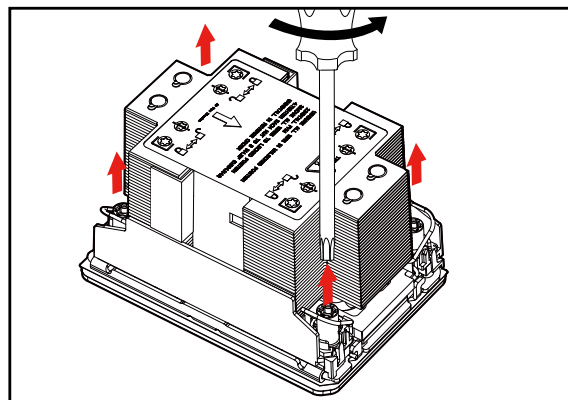

## 2.3 Motherboard Installation

All motherboards have standard mounting holes to fit different types of chassis. Make sure that the locations of all the mounting holes for both the motherboard and the chassis match. Although a chassis may have both plastic and metal mounting fasteners, metal ones are highly recommended because they ground the motherboard to the chassis. Make sure that the metal standoffs click in or are screwed in tightly.

### Tools Needed

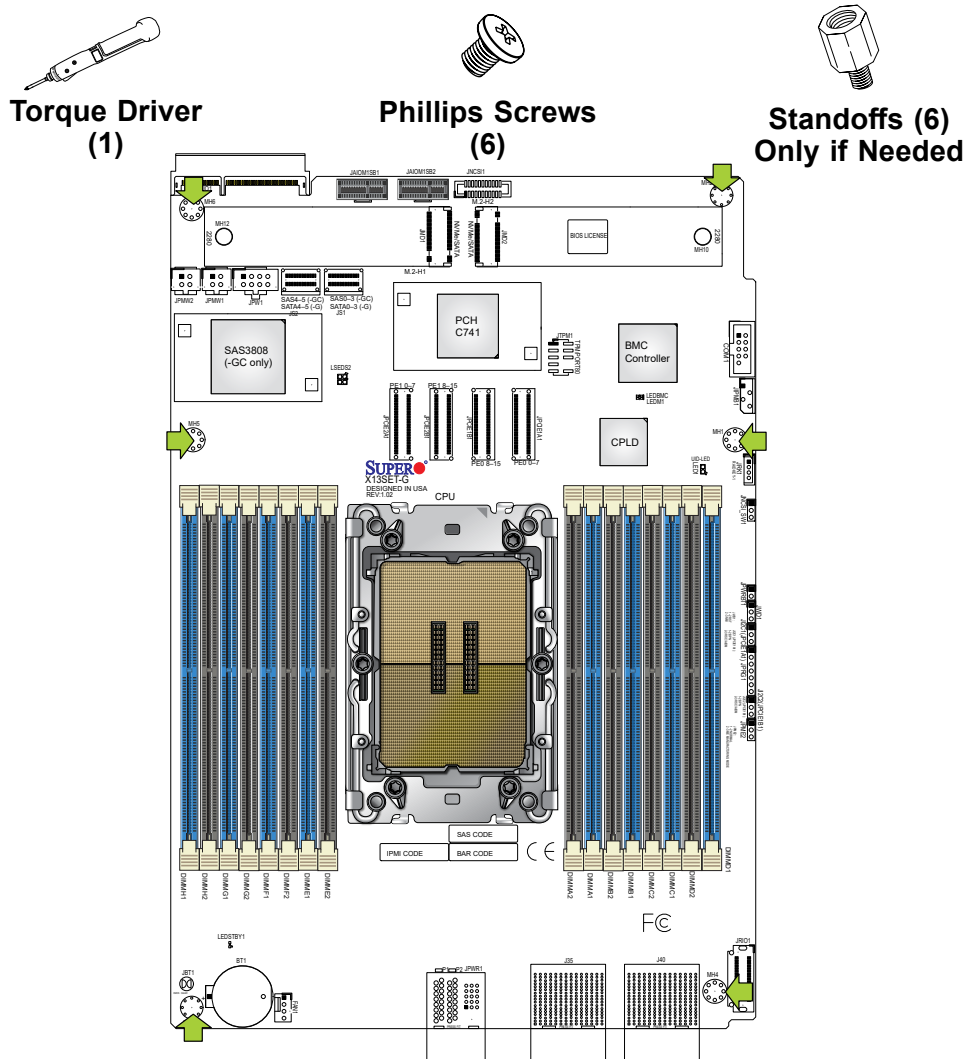

### Location of Mounting Holes

**Note 1:** Do not use a force greater than 8 in-lbf (0.904 N-m) on each mounting screw during motherboard installation. Exceeding this force may over-torque the screw, causing damage to the motherboard and screw.

**Note 2:** Some components are very close to the mounting holes. Take precautionary measures to avoid damaging these components when installing the motherboard to the chassis.

## Installing the Motherboard

1. Install the I/O shield into the back of the chassis, if applicable.

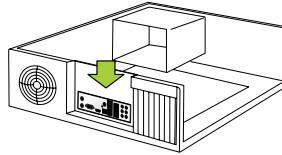

2. Locate the mounting holes on the motherboard. See the previous page for the location.

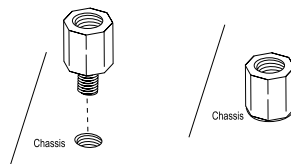

3. Locate the matching mounting holes on the chassis. Align the mounting holes on the motherboard against the mounting holes on the chassis.

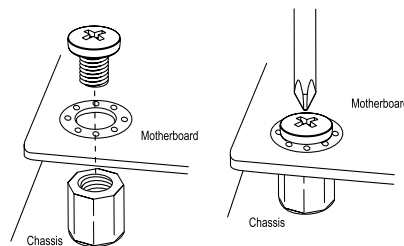

4. Install standoffs in the chassis as needed.
5. Install the motherboard into the chassis carefully to avoid damaging other motherboard components.
6. Using the torque driver, insert a pan head #6 screw into a mounting hole on the motherboard and its matching mounting hole on the chassis.
7. Repeat Step 6 to insert #6 screws into all mounting holes.
8. Make sure that the motherboard is securely placed in the chassis.

 **Note:** Images displayed are for illustration only. Your chassis or components might look different from those shown in this manual.

## 2.4 Memory Support and Installation



**Note:** Check the Supermicro website for recommended memory modules.



**Important:** Exercise extreme care when installing or removing DIMM modules to prevent any possible damage.

### Memory Support

The X13SET-G/-GC motherboard supports up to 4 TB of 3DS RDIMM ECC DDR5 memory in 16 memory slots. The 4<sup>th</sup> Generation Intel Xeon Scalable Processor memory has speeds of up to 4800 MT/s (4400 MT/s when fully populated), while the 5<sup>th</sup> Generation Intel Xeon Scalable Processor memory has speeds of up to 5600 MT/s (4400 MT/s when fully populated). Refer to the table below for the recommended DIMM population order.





1 CPU, 16 DIMM Slots	
Number of DIMMs	Memory Population Sequence
1	DIMMA1 DIMME1 DIMMB1 DIMMF1
2	DIMMA1 / DIMMG1 DIMMC1 / DIMME1
4	DIMMA1 / DIMMG1 / DIMMC1 / DIMME1
6	DIMMA1 / DIMMG1 / DIMMC1 / DIMME1 / DIMMD1 / DIMMF1 DIMMA1 / DIMMG1 / DIMMC1 / DIMME1 / DIMMB1 / DIMMH1 DIMMC1 / DIMME1 / DIMMB1 / DIMMH1 / DIMMD1 / DIMMF1 DIMMA1 / DIMMG1 / DIMMB1 / DIMMH1 / DIMMD1 / DIMMF1
8	DIMMA1 / DIMMG1 / DIMMB1 / DIMMH1 / DIMMD1 / DIMMF1 / DIMMC1 / DIMME1
12	DIMMA1 / DIMMA2 / DIMMB1 / DIMMC1 / DIMMC2 / DIMMD1 / DIMME1 / DIMME2 / DIMMF1 / DIMMG1 / DIMMG2 / DIMMH1 DIMMA1 / DIMMB1 / DIMMB2 / DIMMC1 / DIMMD1 / DIMMD2 / DIMME1 / DIMMF1 / DIMMF2 / DIMMG1 / DIMMH1 / DIMMH2
16	DIMMA1 / DIMMA2 / DIMMB1 / DIMMB2 / DIMMC1 / DIMMC2 / DIMMD1 / DIMMD2 / DIMME1 / DIMME2 / DIMMF1 / DIMMF2 / DIMMG1 / DIMMG2 / DIMMH1 / DIMMH2

1 HBM CPU, 16 DIMM Slots	
Number of DIMMs	Memory Population Sequence
0	
1	DIMMA1 DIMME1
2	DIMMA1 / DIMMG1 DIMMC1 / DIMME1
4	DIMMA1 / DIMMG1 / DIMMC1 / DIMME1
8	DIMMA1 / DIMMG1 / DIMMC1 / DIMME1 / DIMMD1 / DIMMF1 / DIMMB1 / DIMMH1
16	DIMMA1 / DIMMA2 / DIMMB1 / DIMMB2 / DIMMC1 / DIMMC2 / DIMMD1 / DIMMD2 / DIMME1 / DIMME2 / DIMMF1 / DIMMF2 / DIMMG1 / DIMMG2 / DIMMH1 / DIMMH2

Compatible and Incompatible DIMM Types in a Channel and a System			
DIMM Type	RDIMM	RDIMM 3DS	9x4 RDIMM
RDIMM	Compatible	Incompatible	Incompatible
RDIMM 3DS	Incompatible	Compatible	Incompatible
9x4 RDIMM	Incompatible	Incompatible	Compatible

DDR5 Memory Support for the 4 <sup>th</sup> Generation Intel® Xeon® Scalable Processors-SP					
Type	Ranks Per DIMM and Data Width (Stack)	DIMM Capacity (GB)		Speed (MT/s)	
		Memory Density 16 Gb	Memory Density 24 Gb <sup>2</sup>	One DIMM per Channel <sup>1</sup>	Two DIMMs per Channel
				1.1 Volts	
RDIMM	SRx8 (RC D)	16 GB	24 GB	4800*	4400*
	SRx4 (RC C)	32 GB	48 GB		
	SRx4 (RC F) 9x4	32 GB	NA		
	DRx8 (RC E)	32 GB	48 GB		
	DRx4 (RC A)	64 GB	96 GB		
	DRx4 (RC B) 9x4	64 GB	NA		
RDIMM 3DS	(4R/8R) x4 (RC A)	2H-128 GB 4H-256 GB	NA		

\*Memory speed and capacity support depends on the processors used in the system.

-  **Note 1:** 1DPC applies to 1SPC or 2SPC implementations (SPC – sockets per channel).
-  **Note 2:** 24 Gb XCC only with limited configs: 1DPC all DIMM types, 2DPC 96 GB only. Only 8 and 16 DIMM configs, no fallbacks.
-  **Note 3:** Memory speed will be 4800 MT/s 1DPC and 4400 MT/s 2DPC.
-  **Note 4:** Mixing DRAM Density (16 Gb/24 Gb) and/or Frequency is not allowed.

DDR5 Memory Support for the 5 <sup>th</sup> Generation Intel® Xeon® Scalable Processors-SP					
Type	Ranks Per DIMM and Data Width (Stack)	DIMM Capacity (GB)		Speed (MT/s)	
		Memory Density 16 Gb	Memory Density 24 Gb	One DIMM per Channel <sup>1</sup>	Two DIMMs per Channel
				1.1 Volts	
RDIMM	SRx8 (RC D)	16 GB	24 GB <sup>2</sup>	5600*	4400*
	SRx4 (RC C)	32 GB	48 GB <sup>2</sup>		
	SRx4 (RC F) 9x4	NA	NA		
	DRx8 (RC E)	32 GB	48 GB <sup>2</sup>		
	DRx4 (RC A)	64 GB	96 GB		
	DRx4 (RC B) 9x4	NA	NA		
RDIMM 3DS	(4R/8R) x4 (RC A)	2H-128 GB 4H-256 GB	NA		

\*Memory speed and capacity support depends on the processors used in the system.

 **Note 1:** 1DPC applies to 1SPC or 2SPC implementations (SPC – sockets per channel).

 **Note 2:** 24 Gb, 24 GB, and 48 GB DRAM density is not supported in 2DPC.

 **Note 3:** Memory speed will be 5600 MT/s 1DPC and 4400 MT/s 2DPC.

 **Note 4:** For 1DPC 5600 speed, DDR5-5600 DIMMs are required.

 **Note 5:** Mixing DRAM Density (16 Gb/24 Gb) and/or Frequency is not allowed.

## General Guidelines for Optimizing Memory Performance

- It is recommended to use DDR5 memory of the same type, size, and speed.
- Mixed DIMM speeds can be installed. However, all DIMMs will run at the speed of the slowest DIMM.
- To achieve the best memory performance, a balanced memory population is recommended.
- The motherboard will not support an odd number of modules (except for a single DIMM module necessary for board operation). To achieve the best memory performance, a balanced (even number) memory population is recommended.

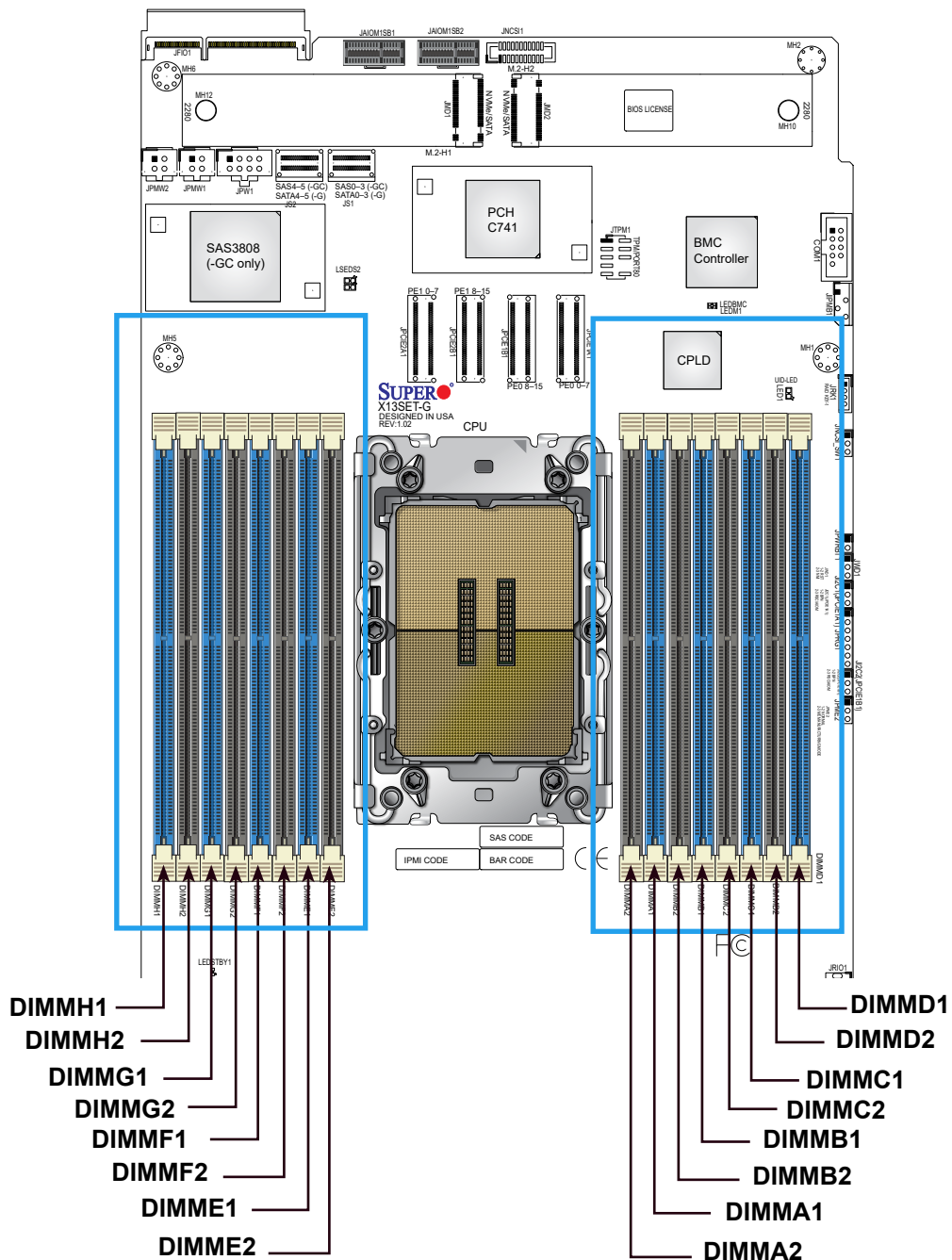

## DIMM Installation

1. Insert the desired number of DIMMs into the memory slots based on the Recommended Memory Population Guide tables on pages 30, 31, and 32.
2. Push the release tabs outwards on both ends of the DIMM slot to unlock it.
3. Align the key of the DIMM module with the receptive point on the memory slot.
4. Align the notches on both ends of the module against the receptive points on the ends of the slot.
5. Push both ends of the module straight down into the slot until the module snaps into place.
6. Press the release tabs to the lock positions to secure the DIMM module into the slot.

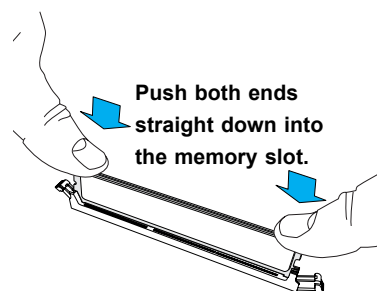
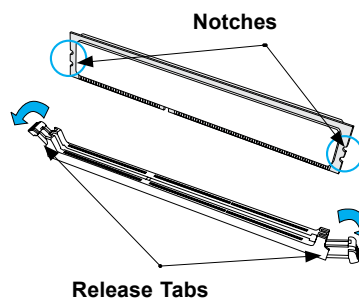
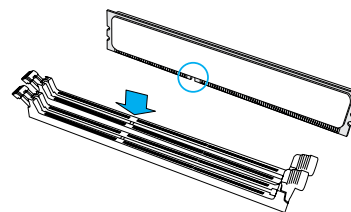
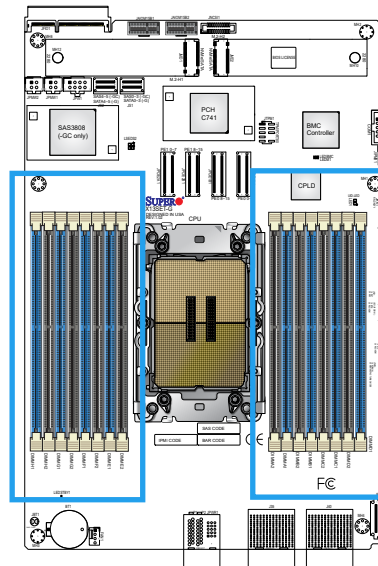

## DIMM Removal

Press both release tabs on the ends of the DIMM module to unlock it. Once the DIMM module is loosened, remove it from the memory slot.

## 2.5 Front I/O Connectors

See Figure 2-1 below for the locations and descriptions of the various I/O connectors on the front of the motherboard.

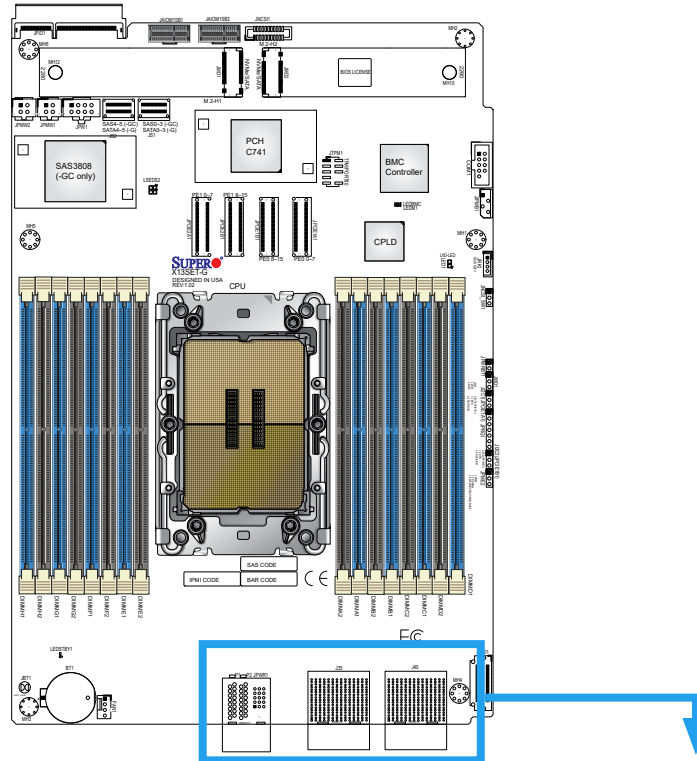
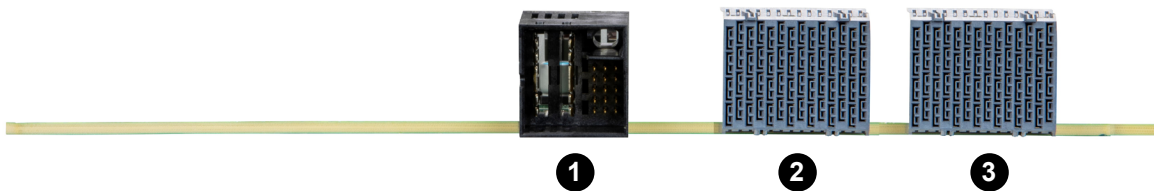

Figure 2-1. I/O Connector Locations and Definitions



Front I/O Connectors	
#	Description
1.	JPWR1
2.	J35
3.	J40

### Molex Impel Plus Connectors

J35 and J40 are PCIe connectors that connect to the PCIe backplane. The connectors can support AIOM backplanes and NVMe backplanes.

### Power Connector

JPWR1 is a 12 V connector that connects to the back and middle plane, BPN-PDB-GT214. The power supply also connects to BPN-PDB-GT214 to provide power to the motherboard.

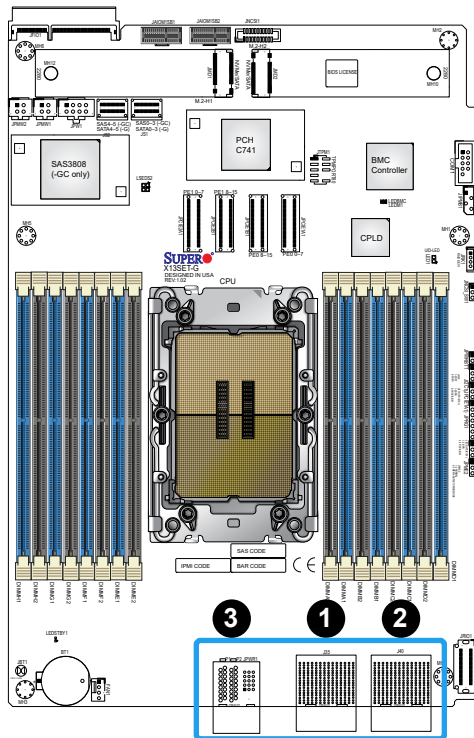

1. J35
2. J40
3. JPWR1

## 2.6 Connectors

### Power Connections

#### Power Connectors

JPMW1 and JPMW2 are the 4-pin power connectors for PCIe or GPU power. JPW1 is the 8-pin power connector for the storage backplane.

4-pin Power Pin Definitions	
Pin#	Definition
1–2	GND
3–4	12 V

8-pin Backplane Power Pin Definitions	
Pin#	Definition
1–4	GND
5–6	12 V
7–8	5 V

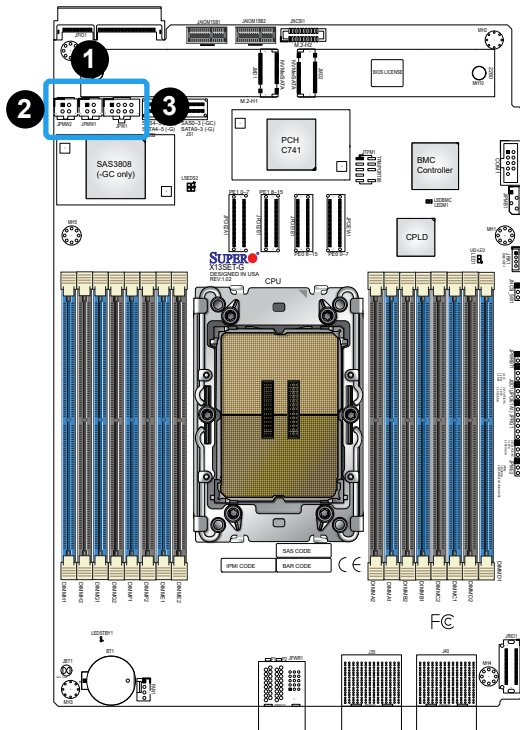

1. JPMW1
2. JPMW2
3. JPW1

## Headers

### COM Header

The motherboard has one COM header (COM1) that provides a serial connection.

COM Header (COM1) Pin Definitions			
Pin#	Definition	Pin#	Definition
1	DCD	2	DSR
3	RXD	4	RTS
5	TXD	6	CTS
7	DTR	8	RI
9	GND	10	N/A

### 4-pin External BMC I<sup>2</sup>C Header

A System Management Bus header for IPMI 2.0 is located at JIPMB1. Connect a cable to this header to use the IPMB I<sup>2</sup>C connection on your system. Refer to the table below for pin definitions.

External I <sup>2</sup> C Header Pin Definitions	
Pin#	Definition
1	Data
2	GND
3	Clock
4	NC
<b>NC = No Connection</b>	

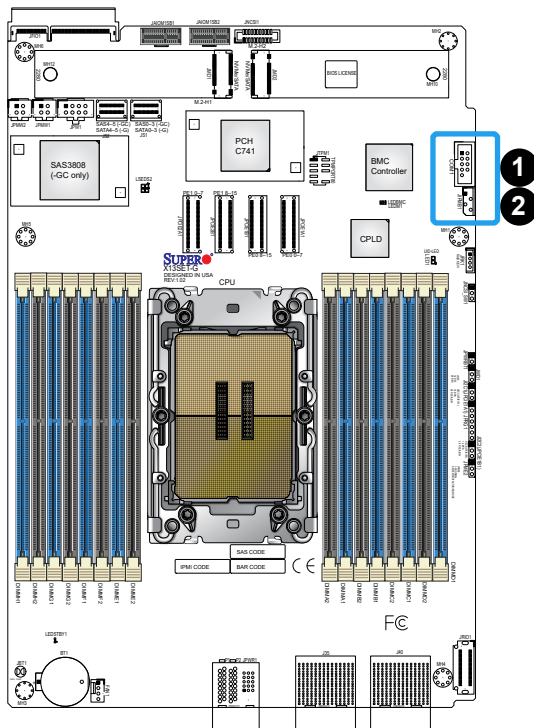

1. COM Header
2. External BMC I<sup>2</sup>C Header

## Fan Headers

There is one 4-pin fan header (FAN1) on the motherboard. The 4-pin fan header is backwards compatible with the traditional 3-pin fans. However, fan speed control is available for 4-pin fans only by Thermal Management via the IPMI 2.0 interface. Refer to the table below for pin definitions.

Fan Header Pin Definitions	
Pin#	Definition
1	GND (Black)
2	2.5 A/+12 V (Red)
3	Tachometer
4	PWM_Control

## Intel RAID Key Header

The JRK1 header allows you to enable RAID functions for NVMe connections. Refer to the table below for pin definitions.

Intel RAID Key Header Pin Definitions	
Pin#	Definition
1	GND
2	PU 3.3 V Stdbby
3	GND
4	PCH RAID KEY

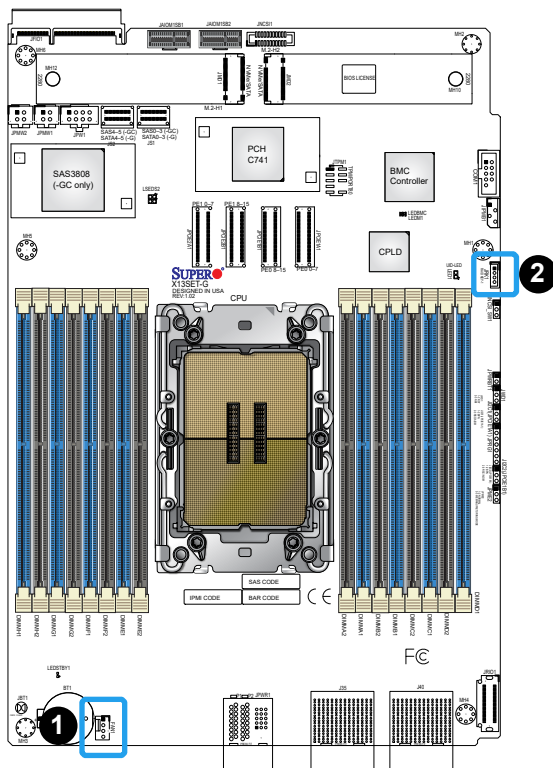

1. FAN1
2. Intel RAID Key Header

## M.2 Slots

This motherboard has two M.2 slots (JMD1, JMD2). M.2 was formerly known as Next Generation Form Factor (NGFF) and serves to replace mini PCIe. M.2 allows for a variety of card sizes, increased functionality, and spatial efficiency. The M.2 slots on the motherboard supports PCIe 3.0 x4 or SATA from the PCH, one in the 2280 form factors.

## MCIO Connectors

JPCIE1A1, JPCIE1B1, JPCIE2A1 and JPCIE2B1 are PCIe connectors that connect to the PCIe backplane. These connectors can support AIOM backplanes, NVMe backplanes and riser cards.

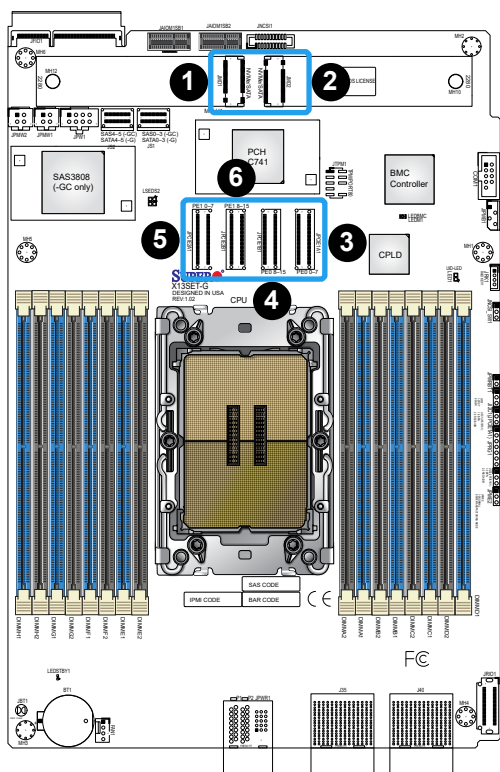

1. JMD1
2. JMD2
3. JPCIE1A1
4. JPCIE1B1
5. JPCIE2A1
6. JPCIE2B1

## NC-SI Connector

A Network-Controller Sideband Interface (NC-SI) header is located at JNCSI1 on the motherboard. The NC-SI header is used to connect a Network Interface Card (NIC) to the motherboard so that the BMC is able to poll the temperature reading from it.

**Note:** For detailed instructions on how to configure Network Interface Card (NIC) settings, refer to the Network Interface Card Configuration User's Guide posted on the web page under the link: <http://www.supermicro.com/support/manuals/>.

## SAS and SATA Ports

This motherboard has two SlimSAS connectors located at JS1 and JS2. They can support either six SAS (SAS0-5) for X13SET-GC or six SATA (SATA0-SATA5) for X13SET-G. X13SET-GC provides a SAS3808 controller to support SAS.

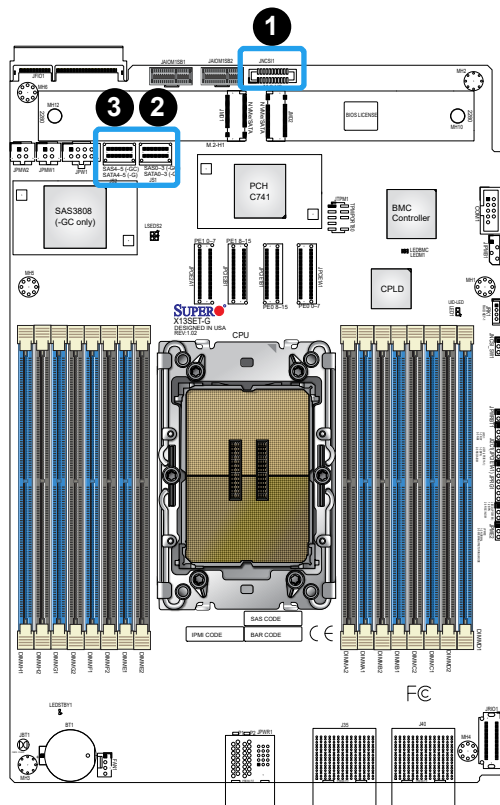

1. NC-SI Connector
2. JS1
3. JS2

### TPM/Port 80 Header

A Trusted Platform Module (TPM)/Port 80 header is located at JTPM1 to provide TPM support and Port 80 connection. Use this header to enhance system performance and data security. Refer to the table below for pin definitions. Go to the following link for more information on the TPM: <http://www.supermicro.com/manuals/other/TPM.pdf>.

Trusted Platform Module Header Pin Definitions			
Pin#	Definition	Pin#	Definition
1	+3.3 V	2	SPI_CS#
3	RESET#	4	SPI_MISO
5	SPI_CLK	6	GND
7	SPI_MOSI	8	NC
9	+3.3 VStdby	10	SPI_IRQ#

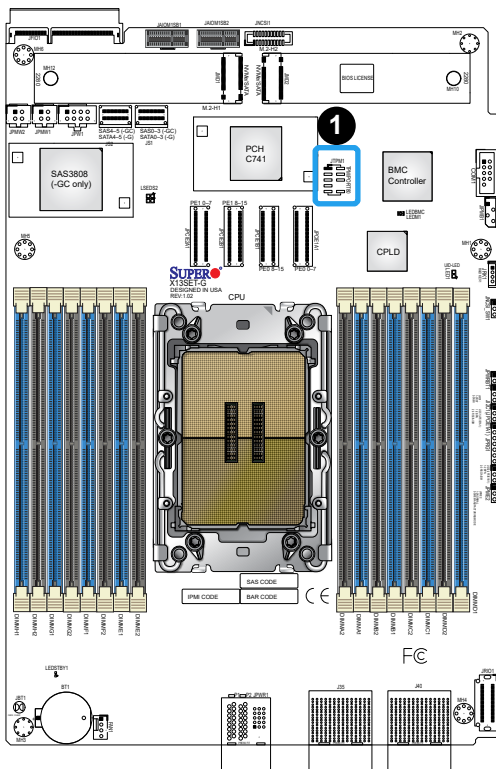

1. TPM/Port 80 Header

## 2.7 Jumper Settings

### How Jumpers Work

To modify the operation of the motherboard, jumpers can be used to choose between optional settings. Jumpers create shorts between two pins to change the function of the connector. Pin 1 is identified with a square solder pad on the printed circuit board. See the diagram below for an example of jumping pins 1 and 2. Refer to the motherboard layout page for jumper locations.

 **Note:** On two-pin jumpers, Closed means the jumper is on and Open means the jumper is off the pins.

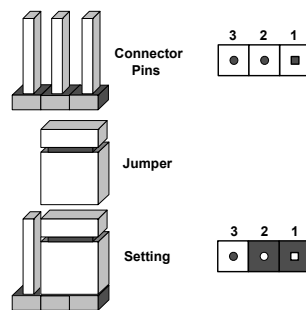

### CMOS Clear

JBT1 is used to clear CMOS, which will also clear any passwords. Instead of pins, this jumper consists of contact pads to prevent accidentally clearing the contents of CMOS.

#### To Clear CMOS

1. First power down the system and unplug the power cord(s).
2. Remove the cover of the chassis to access the motherboard.
3. Remove the onboard battery from the motherboard.
4. Short the CMOS pads with a metal object such as a small screwdriver for at least four seconds.
5. Remove the screwdriver (or shorting device).
6. Replace the cover, reconnect the power cord(s), and power on the system.

 **Note:** Clearing CMOS will also clear all passwords.

Do not use the PW\_ON connector to clear CMOS.



### Backplane or Riser Card/AIOM Enable

Use the JI<sup>2</sup>C1 (JPCIEA1) and JI<sup>2</sup>C2 (JPCIEB1) jumpers to enable backplane or riser card/AIOM features. The backplane supports NVMe while the riser card/AIOM supports standard PCIe devices and AIOM cards. Refer to the table below for jumper settings.

JI <sup>2</sup> C1 (JPCIEA1) and JI <sup>2</sup> C2 (JPCIEB1) Jumper Settings	
Jumper Setting	Definition
Pins 1–2	Backplane (Default)
Pins 2–3	RSC/AIOM

### ME Manufacturing Mode

Close JPME2 to bypass SPI flash security and force the system to use the Manufacturing Mode, which will allow the user to flash the system firmware from a host server to modify system settings. Refer to the table below for jumper settings.

Manufacturing ME Mode Jumper Settings	
Jumper Setting	Definition
Pins 1–2	Normal (Default)
Pins 2–3	Manufacturing Mode

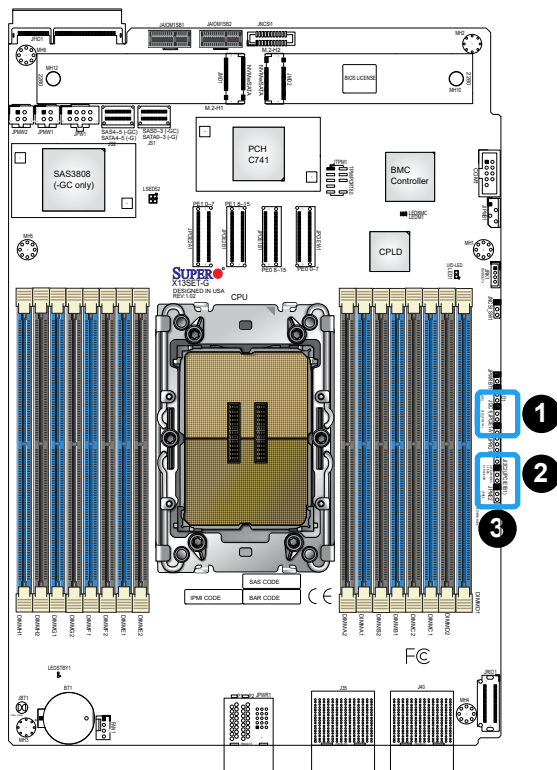

1. JI<sup>2</sup>C1 (JPCIEA1)
2. JI<sup>2</sup>C2 (JPCIEB1)
3. ME Recovery

## Watchdog

JWD1 controls the Watchdog function. Watchdog is a monitor that can reboot the system when a software application hangs. Jumping pins 1–2 will cause Watchdog to reset the system if an application hangs. Jumping pins 2–3 will generate a non-maskable interrupt signal for the application that hangs. Watchdog must also be enabled in BIOS. The default setting is Reset.

 **Note:** When Watchdog is enabled, users need to write their own application software to disable it.

Watchdog Jumper Settings	
Jumper Setting	Definition
Pins 1–2	Reset (Default)
Pins 2–3	NMI
Open	Disabled

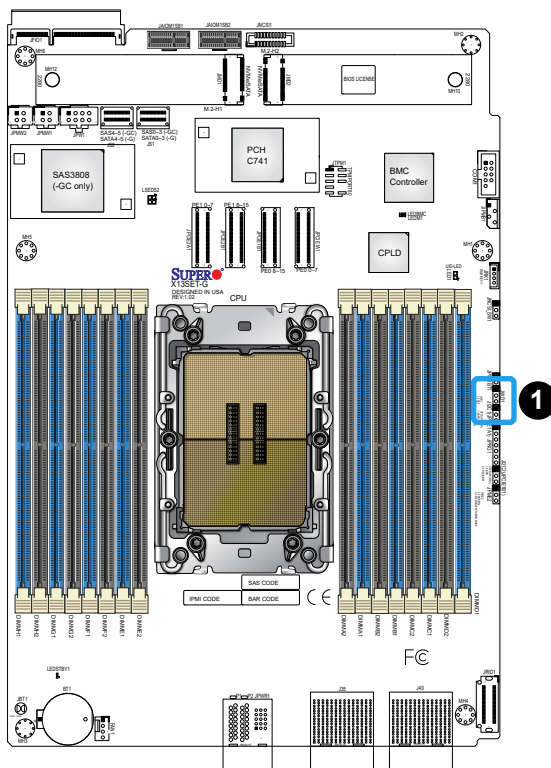

## 2.8 LED Indicators

### BMC Heartbeat LED

LEDM1 is the BMC Heartbeat LED. When the LED is blinking green, BMC is working. Refer to the table below for the LED status.

BMC Heartbeat LED	
LED Color	Definition
Green: Blinking	BMC Normal
Red	BMC Error

### SAS Heartbeat LED

LESDS2 is the SAS Heartbeat LED. When the LED is solid red, there is an error with the SAS. Refer to the table below for the LED status.

SAS Activity LED Indicator	
LED Color	Definition
Green: Blinking	SAS Active
Red	SAS Error

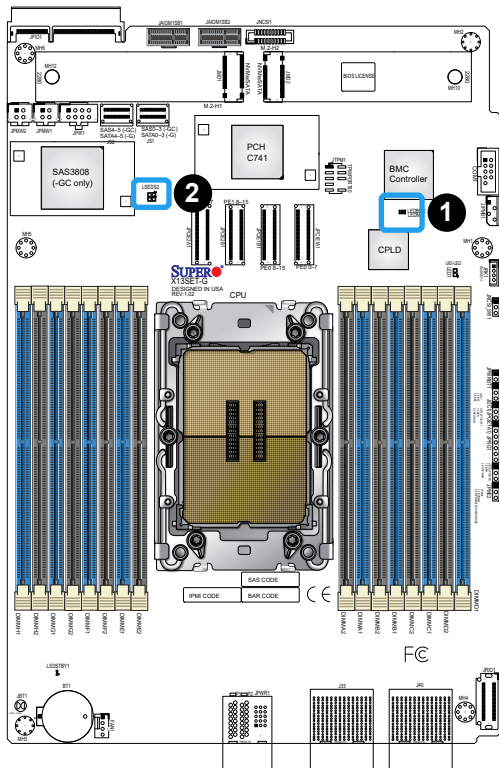

1. BMC Heartbeat LED
2. SAS Heartbeat LED

## UID LED

LED1 is the Unit Identifier LED. When you press the UID switch, the UID LED will be turned on. Press the UID switch again to turn off the LED indicator. The UID Indicator provides easy identification of a system unit that may be in need of service.

 **Note:** UID can also be triggered via IPMI on the motherboard. For more information on IPMI, please refer to the IPMI User's Guide posted on our website at <http://www.supermicro.com/support/manuals/>.

UID LED Pin Definitions	
Color	Status
Blue: On	Unit Identified

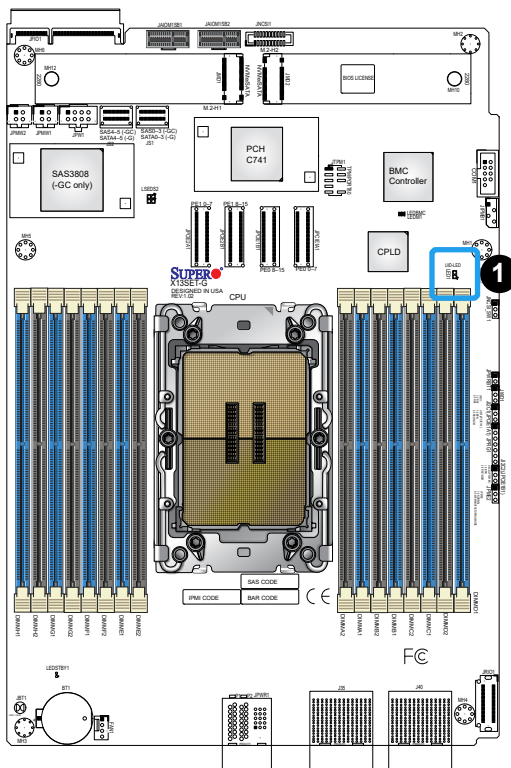

### 1. UID LED

# Chapter 3

## Troubleshooting

### 3.1 Troubleshooting Procedures

Use the following procedures to troubleshoot your system. If you have followed all of the procedures below and still need assistance, refer to the 'Technical Support Procedures' and/or 'Returning Merchandise for Service' section(s) in this chapter. Always disconnect the AC power cord before adding, changing or installing any non hot-swap hardware components.

#### Before Power On

1. Make sure that there are no short circuits between the motherboard and chassis.
2. Disconnect all ribbon/wire cables from the motherboard, including those for the keyboard and mouse.
3. Remove all add-on cards.
4. Install the CPU (making sure it is fully seated) and connect the front panel connectors to the motherboard.

#### No Power

1. Make sure that there are no short circuits between the motherboard and the chassis.
2. Make sure that the power connectors are properly connected.
3. Check that the 115 V/230 V switch, if available, on the power supply is properly set.
4. Turn the power switch on and off to test the system, if applicable.
5. Check the CPU socket for bent pins and make sure the CPU is fully seated.
6. The battery on your motherboard may be old. Check to verify that it still supplies approximately 3 VDC. If it does not, replace it with a new one.

## System Boot Failure

If the system does not display Power-On-Self-Test (POST) or does not respond after the power is turned on, do the following:

1. Check the screen for an error message.
2. Clear the CMOS settings by unplugging the power cord and contacting both pads on the CMOS clear jumper (JBT1). Restart the system. Refer to Section 2-8 in Chapter 2.
3. Remove all components from the motherboard and turn on the system with only one DIMM module installed. If the system boots, turn off the system and repopulate the components back into the system to retest. Add one component at a time to isolate which one may have caused the system boot issue.

## Memory Errors

When suspecting faulty memory is causing the system issue, check the following:

1. Make sure that the memory modules are compatible with the system and are properly installed. See Chapter 2 for installation instructions. (For memory compatibility, refer to the "Tested Memory List" link on the motherboard's product page to see a list of supported memory.)
2. Check if different speeds of DIMMs have been installed. It is strongly recommended that you use the same RAM type and speed for all DIMMs in the system.
3. Make sure that you are using the correct type of ECC DDR5 modules recommended by the manufacturer.
4. Check for bad DIMM modules or slots by swapping a single module among all memory slots and check the results.

## Losing the System's Setup Configuration

1. Make sure that you are using a high-quality power supply. A poor-quality power supply may cause the system to lose the CMOS setup information. Refer to Chapter 2 for details on recommended power supplies.
2. The battery on your motherboard may be old. Check to verify that it still supplies approximately 3 VDC. If it does not, replace it with a new one.
3. If the above steps do not fix the setup configuration problem, contact your vendor for repairs.

## When the System Becomes Unstable

### **A. If the system becomes unstable during or after OS installation, check the following:**

1. CPU/BIOS support: Make sure that your CPU is supported and that you have the latest BIOS installed in your system.
2. Memory support: Make sure that the memory modules are supported by testing the modules using memtest86 or a similar utility.



**Note:** Click on the "Tested Memory List" link on the motherboard's product page to see a list of supported memory.

3. HDD support: Make sure that all hard disk drives (HDDs) work properly. Replace the bad HDDs with good ones.
4. System cooling: Check the system cooling to make sure that all heatsink fans and CPU/system fans, etc., work properly. Check the hardware monitoring settings in the IPMI to make sure that the CPU and system temperatures are within the normal range. Also check the front panel Overheat LED and make sure that it is not on.
5. Adequate power supply: Make sure that the power supply provides adequate power to the system. Make sure that all power connectors are connected. Please refer to our website for more information on the minimum power requirements.
6. Proper software support: Make sure that the correct drivers are used.

### **B. If the system becomes unstable before or during OS installation, check the following:**

1. Source of installation: Make sure that the devices used for installation are working properly, including boot devices such as a USB flash or media drive.
2. Cable connection: Check to make sure that all cables are connected and working properly.
3. Use the minimum configuration for troubleshooting: Remove all unnecessary components (starting with add-on cards first), and use the minimum configuration (but with the CPU and a memory module installed) to identify the trouble areas. Refer to the steps listed in Section A above for proper troubleshooting procedures.
4. Identify bad components by isolating them: If necessary, remove a component in question from the chassis, and test it in isolation to make sure that it works properly. Replace a bad component with a good one.
5. Check and change one component at a time instead of changing several items at the same time. This will help isolate and identify the problem.

6. To find out if a component is good, swap this component with a new one to see if the system will work properly. If so, then the old component is bad. You can also install the component in question in another system. If the new system works, the component is good and the old system has problems.

## 3.2 Technical Support Procedures

Before contacting Technical Support, please take the following steps. Also, please note that as a motherboard manufacturer, Supermicro also sells motherboards through its channels, so it is best to first check with your distributor or reseller for troubleshooting services. They should know of any possible problems with the specific system configuration that was sold to you.

1. Please go through the Troubleshooting Procedures and Frequently Asked Questions (FAQ) sections in this chapter or see the FAQs on our website (<http://www.supermicro.com/FAQ/index.php>) before contacting Technical Support.
2. BIOS upgrades can be downloaded from our website ([http://www.supermicro.com/ResourceApps/BIOS\\_IPMI\\_Intel.html](http://www.supermicro.com/ResourceApps/BIOS_IPMI_Intel.html)).
3. If you still cannot resolve the problem, include the following information when contacting Supermicro for technical support:
  - Motherboard model and PCB revision number
  - BIOS release date/version (This can be seen on the initial display when your system first boots up.)
  - System configuration
4. An example of a Technical Support form is on our website at <http://www.supermicro.com/RmaForm/>.
5. Distributors: For immediate assistance, please have your account number ready when placing a call to our Technical Support department. We can be reached by email at [support@supermicro.com](mailto:support@supermicro.com).

## 3.3 Frequently Asked Questions

**Question: What type of memory does my motherboard support?**

**Answer:** The motherboard supports up to 4 TB of 3DS RDIMM ECC DDR5 memory in 16 memory slots. The 4<sup>th</sup> Generation Intel Xeon Scalable Processor memory has speeds of up to 4800 MT/s (4400 MT/s when fully populated), while the 5<sup>th</sup> Generation Intel Xeon Scalable Processor memory has speeds of up to 5600 MT/s (4400 MT/s when fully populated). To enhance memory performance, do not mix memory modules of different speeds and sizes. Please follow all memory installation instructions given on Section 2-4 in Chapter 2.

**Question: How do I update my BIOS?**

**Answer:** It is recommended that you do not upgrade your BIOS if you are not experiencing any problems with your system. Updated BIOS files are located on our website at [http://www.supernmicro.com/ResourceApps/BIOS\\_IPMI\\_Intel.html](http://www.supernmicro.com/ResourceApps/BIOS_IPMI_Intel.html). Please check our BIOS warning message and the information on how to update your BIOS on our website. Select your motherboard model and download the BIOS file to your computer. Also, check the current BIOS revision to make sure that it is newer than your BIOS before downloading.

Unzip the BIOS file onto a bootable USB device and then boot into the built-in UEFI Shell and type "flash.nsh <BIOS filename><BMC Username><BMC Password>" to start the BIOS update. The flash script will invoke the SUM (EFI) tool automatically to perform the BIOS update, beginning with uploading the BIOS image to BMC. After uploading the firmware, the system will reboot to continue the process. The BMC will take over and continue the BIOS update in the background. The process will take 3-5 minutes.

**Warning:** Do not shut down or reset the system while updating the BIOS to prevent possible system boot failure! Please read the X13\_AMI\_BIOS\_Upgrade\_README file carefully before you perform the BIOS update.

## 3.4 Battery Removal and Installation

### Battery Removal

To remove the onboard battery, follow the steps below:

1. Power off your system and unplug your power cable.
2. Locate the onboard battery as shown below.
3. Using a tool such as a pen or a small screwdriver, push the battery lock outwards to unlock it. Once unlocked, the battery will pop out from the holder.
4. Remove the battery.

### Proper Battery Disposal

**Warning:** Please handle used batteries carefully. Do not damage the battery in any way; a damaged battery may release hazardous materials into the environment. Do not discard a used battery in the garbage or a public landfill. Please comply with the regulations set up by your local hazardous waste management agency to dispose of your used battery properly.

### Battery Installation

1. To install an onboard battery, follow steps 1 and 2 above and continue below:
2. Identify the battery's polarity. The positive (+) side should be facing up.
3. Insert the battery into the battery holder and push it down until you hear a click to ensure that the battery is securely locked.

**Warning:** When replacing a battery, be sure to only replace it with the same type.

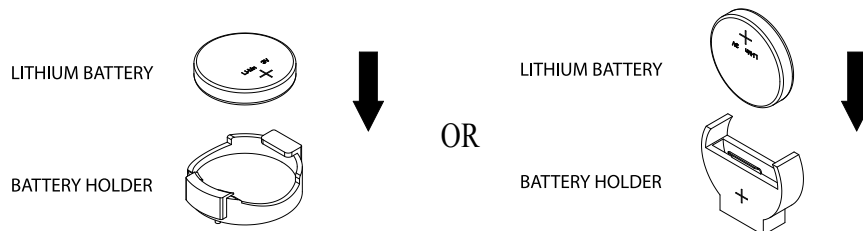

### 3.5 Returning Merchandise for Service

A receipt or copy of your invoice marked with the date of purchase is required before any warranty service will be rendered. You can obtain service by calling your vendor for a Returned Merchandise Authorization (RMA) number. When returning the motherboard to the manufacturer, the RMA number should be prominently displayed on the outside of the shipping carton, and the shipping package is mailed prepaid or hand-carried. Shipping and handling charges will be applied for all orders that must be mailed when service is complete. For faster service, you can also request a RMA authorization online (<http://www.supermicro.com/RmaForm/>).

This warranty only covers normal consumer use and does not cover damages incurred in shipping or from failure due to the alternation, misuse, abuse or improper maintenance of products.

During the warranty period, contact your distributor first for any product problems.

## Chapter 4

# UEFI BIOS

### 4.1 Introduction

This chapter describes the AMIBIOS™ Setup utility for the motherboard. The BIOS is stored on a chip and can be easily upgraded using the BMC WebUI or the SUM utility.



**Note:** Due to periodic changes to the BIOS, some settings may have been added or deleted and might not yet be recorded in this manual. Refer to the Manual Download area of our website for any changes to the BIOS that may not be reflected in this manual.

#### Starting the Setup Utility

To enter the BIOS Setup utility, press the <Delete> key while the system is booting up. In most cases, the <Delete> key is used to invoke the BIOS Setup screen; however, in other cases, other hot keys, such as <F1>, <F2>, may be used for this purpose. Each main BIOS menu option is described in this manual.

The Main BIOS screen has two main frames. The left frame displays all the options that can be configured. “Grayed-out” options cannot be configured. The right frame displays the key legend. Above the key legend is an area reserved for a text message. When an option is selected in the left frame, it is highlighted in white. Often a text message will accompany it. Note that the BIOS has default text messages built in, and we retain the option to include, omit, or change any of these text messages. Settings printed in **Bold** are the default values.

A " ►" indicates a submenu. Highlighting such an item and pressing the <Enter> key will open the list of settings within that submenu.

The BIOS Setup utility uses a key-based navigation system called hot keys. Most of these hot keys (<F1>, <F2>, <F3>, <F4>, <Enter>, <ESC>, <Arrow> keys, etc.) can be used at any time during the setup navigation process.

## 4.2 Main Setup

When you first enter the AMI BIOS Setup utility, you will see the Main setup screen. You can always return to the Main Setup screen by selecting the Main tab on the top of the screen. The Main BIOS Setup screen is shown below.

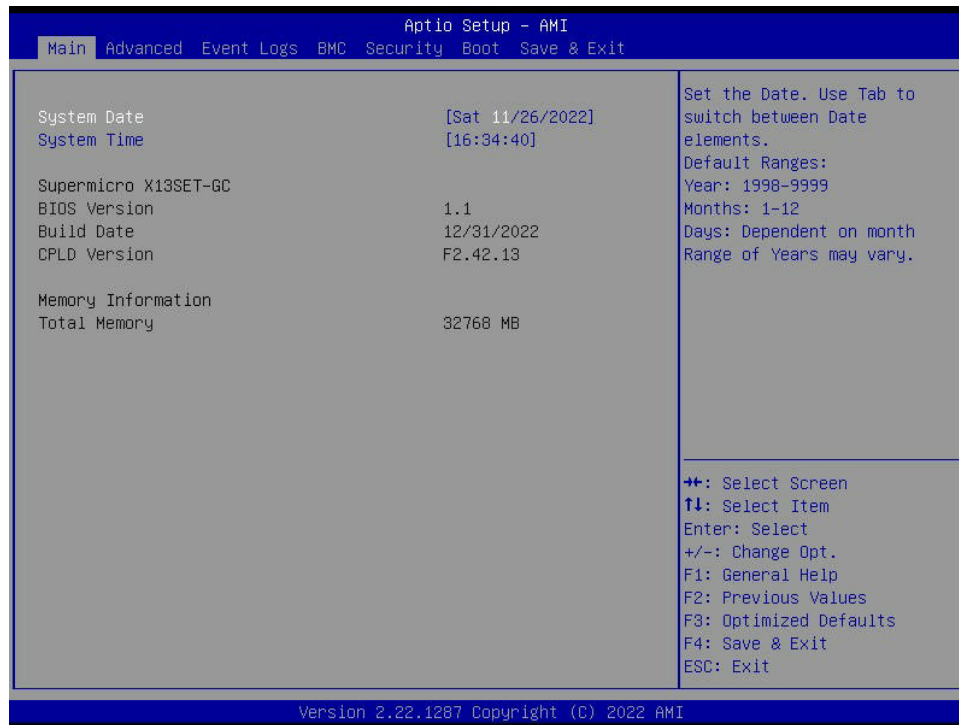

### System Date / System Time

Use this feature to change the system date and time. To change system date and time settings, highlight System Date or System Time using the arrow keys and enter new values using the keyboard. Press the <Tab> key or the arrow keys to move between fields. The date must be entered in MM/DD/YYYY format. The time is entered in HH:MM:SS format.

 **Note:** The time is in the 24-hour format. For example, 5:30 P.M. appears as 17:30:00. The date's default value is the BIOS build date after RTC reset.

### Supermicro X13SET-GC

#### BIOS Version

This feature displays the version of the BIOS ROM used in the system.

#### Build Date

This feature displays the date when the version of the BIOS ROM used in the system was built.

### **CPLD Version**

This feature displays the version of the Complex Programmable Logic Device (CPLD) used in the system.

### **Memory Information**

#### **Total Memory**

This feature displays the total size of memory available in the system.

## 4.3 Advanced Setup Configurations

Use the arrow keys to select the Advanced submenu and press <Enter> to access the submenu items.

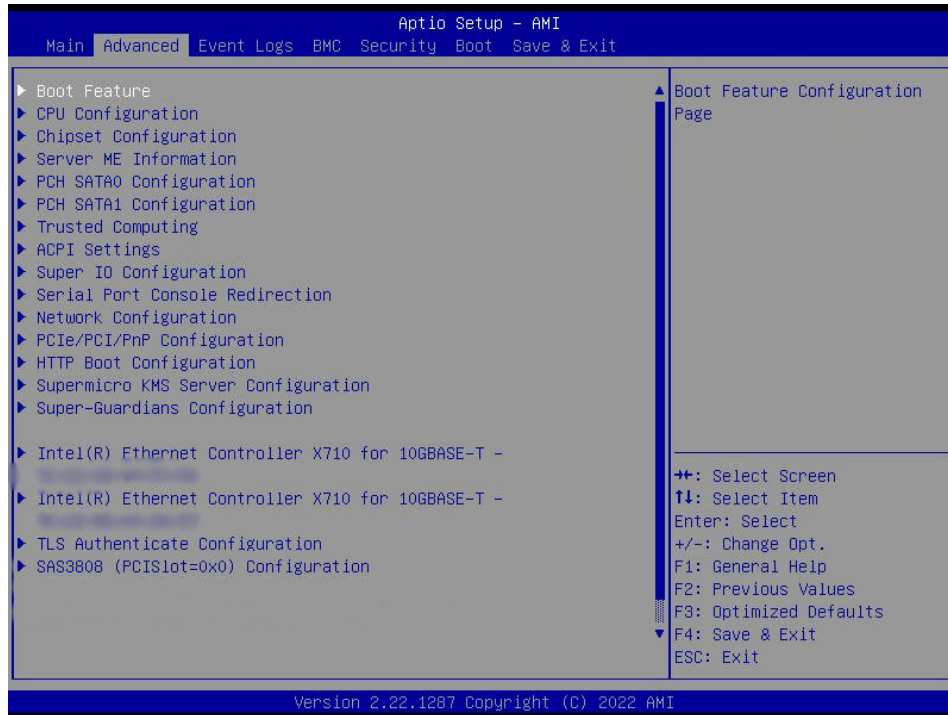

**Warning:** Take caution when changing the Advanced settings. An incorrect value, an improper DRAM frequency, or a wrong BIOS timing setting may cause the system to malfunction. When this occurs, restore the setting to the manufacturer default setting.

### ► Boot Feature

#### Quiet Boot

Use this feature to select the screen between displaying POST messages or the OEM logo at bootup. Select Disabled to display the POST messages. Select Enabled to display the OEM logo instead of the normal POST messages. The options are Disabled and **Enabled**.

 **Note:** BIOS Power-on Self Test (POST) messages are always displayed regardless of the setting for this feature.

#### Option ROM Messages

Use this feature to set the display mode for the Option ROM. Select Keep Current to display the current AddOn ROM display settings. Select Force BIOS to use the Option ROM display mode set by the system BIOS. The options are **Force BIOS** and Keep Current.

### **Bootup NumLock State**

Use this feature to set the Power-on state for the <Numlock> key. The options are **On** and Off.

### **Wait For "F1" If Error**

Select Enabled to force the system to wait until the <F1> key is pressed if an error occurs. The options are **Disabled** and Enabled.

### **INT19 Trap Response**

Interrupt 19 is the software interrupt that handles the boot disk function. When this feature is set to Immediate, the ROM BIOS of the host adaptors will "capture" Interrupt 19 at bootup immediately and allow the drives that are attached to these host adaptors to function as bootable disks. If this feature is set to Postponed, the ROM BIOS of the host adaptors will not capture Interrupt 19 immediately to allow the drives attached to these adaptors to function as bootable devices at bootup. The options are **Immediate** and Postponed.

### **Re-try Boot**

When Extensible Firmware Interface (EFI) Boot is selected, the system BIOS will automatically reboot the system from an EFI boot device after an initial boot failure. Select Legacy Boot to allow the BIOS to automatically reboot the system from a Legacy boot device after an initial boot failure. The options are **Disabled**, Legacy Boot, and EFI Boot.

### **Power Configuration**

#### **Watch Dog Function**

Select Enabled to allow the Watch Dog timer to reboot the system when it is inactive for more than five minutes. The options are **Disabled** and Enabled.

#### **Watch Dog Action (Available when "Watch Dog Function" is set to Enabled.)**

Use this feature to configure the Watch Dog Time\_out setting. The options are **Reset** and NMI.

#### **Front USB Port(s) (Available when DCMS key is activated)**

Select Enabled to allow the specific type of USB devices to be used in the front USB ports. Select Enabled (Dynamic) to allow or disallow this particular type of USB devices to be used in the front USB ports without rebooting the system. The options are **Enabled**, Disabled, and Enabled (Dynamic).

#### **Rear USB Port(s) (Available when DCMS key is activated)**

Select Enabled to allow the specific type of USB devices to be used in the rear USB ports. Select Enabled (Dynamic) to allow or disallow this particular type of USB devices to be used in the rear USB ports without rebooting the system. The options are **Enabled**, Disabled, and Enabled (Dynamic).

### **Restore on AC Power Loss**

Use this feature to set the power state after a power outage. Select Stay Off for the system power to remain off after a power loss. Select Power On for the system power to be turned on after a power loss. Select Last State to allow the system to resume its last power state before a power loss. The options are Stay Off, Power On, and **Last State**.

### **Power Button Function**

This feature controls how the system shuts down when the power button is pressed. Select 4 Seconds Override to power off the system after pressing and holding the power button for four seconds or longer. Select Instant Off to instantly power off the system as soon as you press the power button. The options are **Instant Off** and 4 Seconds Override.

## **► CPU Configuration**

The following processor configuration information is displayed:

- Processor BSP Revision
- Processor Socket
- Processor ID
- Processor Frequency
- Processor Max Ratio
- Processor Min Ratio
- Microcode Revision
- L1 Cache RAM (Per Core)
- L2 Cache RAM (Per Core)
- L3 Cache RAM (Per Package)
- Processor 0 Version

## ► Advanced Power Management Configuration

### Power Technology

Select Energy Efficient to support power-saving mode. Select Custom to customize system power settings. Select Disabled to disable power-saving settings. The options are Disable, Energy Efficient, and **Custom**.

### Power Performance Tuning

Select BIOS to allow the system BIOS to configure the Power-Performance Tuning Bias setting. The options are **OS Controls EPB** and BIOS Controls EPB.

### **ENERGY\_PERF\_BIAS CFG Mode (ENERGY PERFORMANCE BIAS CONFIGURATION Mode) (Available when "Power Performance Tuning" is set to BIOS Controls EPB)**

Use this feature to configure the proper operation setting for your machine by achieving the desired system performance level and energy saving (efficiency) level at the same time. Select Maximum Performance to maximize system performance to its highest potential; however, this may consume maximal amount of power as energy is needed to fuel processor operation. Select Performance to enhance system performance; however, this may consume more power as energy is needed to fuel the processors for operation. The options are Maximum Performance, Performance, **Balanced Performance**, Balanced Power, and Power.

### Optimized Power Mode

Use this feature to enable or disable Optimized Power Mode. The options are **Disable** and Enable.

## ► CPU P State Control

This feature allows you to configure the following CPU power settings:

### **AVX P1 (Available when "SpeedStep (P-States)" is set to Enable)**

Use this feature to set the appropriate TDP level for the system. The Intel Advanced Vector Extensions (Intel AVX) P1 feature allows you to specify the base P1 ratio for Streaming SIMD Extensions (SSE) and AVX workloads and to pre-grant a license level. The options are **Nominal**, Level 1, and Level 2.

### **SpeedStep (P-States)**

Enhanced Intel SpeedStep Technology (EIST) allows the system to automatically adjust processor voltage and core frequency in an effort to reduce power consumption and heat dissipation. Refer to Intel's website for detailed information. The options are Disable and **Enable**.

**EIST PSD Function (Available when "SpeedStep (P-States)" is set to Enable)**

This feature reduces the latency that occurs when one P-state changes to another, thus allowing the transitions to occur more frequently. This feature allows for more demand-based P-state switching based on real-time energy needs of applications and optimize the power-to-performance balance for energy efficiency. The options are **HW\_ALL** and **SW\_ALL**.

**Turbo Mode (Available when "SpeedStep (P-States)" is set to Enable)**

Select Enable to allow the CPU to operate at the manufacturer-defined turbo speed by increasing CPU clock frequency. This feature is available when it is supported by the processors used in the system. The options are Disable and **Enable**.

**► Hardware PM State Control****Hardware P-States**

If this feature is set to Disable, system hardware will choose a P-state setting for the system based on an OS request. If this feature is set to Native Mode, hardware will choose a P-state setting based on the OS guidance. If this feature is set to Native Mode with No Legacy Support, system hardware will choose a P-state setting independently without OS guidance. The options are **Disable**, Native Mode, Out of Band Mode, and Native Mode with No Legacy Support.

**► CPU C State Control****Enable Monitor MWAIT**

Select Enable to support Monitor and Mwait, which are two instructions in Streaming SIMD Extension 3 (SSE3), to improve synchronization between multiple threads for CPU performance enhancement. The options are Disable, Enable, and **Auto**.

**CPU C1 Auto Demotion**

Select Enable to allow the CPU to demote C3, C6, or C7 requests to C1 based on un-core auto-demote information. The options are Disable and **Enable**.

**CPU C6 Report**

Select Enable to allow the BIOS to report the CPU C6 State (ACPI C3) to the operating system. During the CPU C6 State, the power to all cache is turned off. The options are Disable, Enable, and **Auto**.

**Enhanced Halt State (C1E)**

Select Enable to enable "Enhanced Halt State" support. This feature will significantly reduce the CPU's power consumption by minimizing CPU's clock cycles and reduce voltage during a "Halt State." The options are Disable and **Enable**.

## ► Package C State Control

### Package C State

Use this feature to optimize and reduce CPU package power consumption in the idle mode. Note that the changes you've made in this setting will affect all CPU cores or the circuits of the entire system. The options are C0/C1 state, C2 state, C6 (non Retention) state, C6 (Retention) state, No Limit, and **Auto**.

## ► CPU1 Core Disable Bitmap

### Available Bitmap:

This feature displays the available bitmap.

### Disable Bitmap(Hex)

Enter 0 to enable this feature for all CPU cores. Enter FFFFFFFFFFFFFFFF to disable this feature for all CPU cores. Note that at least one core per CPU must be enabled. Disabling all cores is not allowed. The default setting is **0**.

### Hyper-Threading (ALL)

Select Enable to use Intel Hyper-Threading Technology to enhance CPU performance. The options are **Enable** and Disable.

### Hardware Prefetcher

If this feature is set to Enable, the hardware prefetcher will prefetch data from the main system memory to Level 2 cache to help expedite data transaction to enhance memory performance. The options are **Enable** and Disable.

### Adjacent Cache Prefetch

Select Enable for the CPU to prefetch both cache lines for 128 bytes as comprised. Select Disable for the CPU to prefetch both cache lines for 64 bytes. The options are **Enable** and Disable.

### DCU Streamer Prefetcher

If this feature is set to Enable, the Data Cache Unit (DCU) streamer prefetcher will prefetch data streams from the cache memory to the DCU to speed up data accessing and processing to enhance CPU performance. The options are **Enable** and Disable.

### DCU IP Prefetcher

This feature allows the system to use the sequential load history, which is based on the instruction pointer of previous loads, to determine whether the system will prefetch additional lines. The options are **Enable** and Disable.

**LLC Prefetch**

If this feature is set to Enable, LLC (hardware cache) prefetching on all threads will be supported. The options are **Disable** and Enable.

**Extended APIC**

Based on the Intel Hyper-Threading technology, each logical processor (thread) is assigned 256 APIC IDs (APIDs) in 8-bit bandwidth. When this feature is set to Enable, the APIC ID will be expanded from 8 bits to 16 bits to provide 512 APIDs to each thread to enhance CPU performance. The options are Disable and **Enable**.



**Note:** When enabled, VT-d and Interrupt Remapping will be automatically enabled.

**Intel Virtualization Technology**

Select Enable to enable the Intel Vanderpool Technology for Virtualization platform support. This feature allows multiple operating systems to run simultaneously on the same computer to maximize system resources for performance enhancement. The options are Disable and **Enable**.



**Note:** The changes take effect after you press Save Changes and Exit, Save Changes and Reset, or Save Changes in the Save and Exit submenu.

**Enable SMX**

Select Enable to support Safer Mode Extensions (SMX). This feature provides a programming interface for system software to establish a controlled environment to support the trusted platform configured by the end user and to verify a virtual machine monitor before it is allowed to run. The options are **Disable** and Enable.

**PPIN Control**

Select Unlock/Enable to use the Protected-Processor Inventory Number (PPIN) in the system. The options are **Lock/Disable** and Unlock/Enable.

**AES-NI**

Select Enable to use the Intel Advanced Encryption Standard (AES) New Instructions (NI) to ensure data security. The options are Disable and **Enable**.

**Limit CPU PA to 46 Bits**

Select Enable to limit CPU physical address to 46 bits to support the older Hyper-v CPU platform. The options are Disable and **Enable**.

-----  
TME, TME-MT, TDX  
-----

### Memory Encryption (TME)

Select Enabled for total memory encryption support to enhance memory data security. The options are **Disabled** and Enabled.

### Total Memory Encryption (TME) Bypass (Available when "Memory Encryption (TME)" is set to Enabled)

Use this feature to disable/enable the Total Memory Encryption (TME) function for physical memory protection. The options are **Auto**, Disabled, and Enabled.

The following information is displayed:

- Total Memory Encryption
- Multi-Tenant (TME-MT)
- Memory Integrity
- Key Stock Amount
- TME-MT Key ID bits

### Trust Domain Extension (TDX) (Available when your CPU supports Intel TDX)

Use this feature to enable Intel Trust Domain Extension (TDX) technology support to enhance control of data security. The options are **Disabled** and Enabled.

### TDX Secure Arbitration Mode Loader (SEAM Loader) (Available when your CPU supports Intel TDX)

The SEAM Loader (SEAMLDR) is used to load and update Intel TDX modules into the SEAM memory range by verifying the digital signature. The options are **Disabled** and Enabled.

-----

### Software Guard Extension (SGX)

-----

***\*The following SGX features are available when "Memory Encryption (TME)" is set to Enabled and CPU supports Intel SGX***

 **Note:** Each memory channel must have at least one DIMM populated on the motherboard to support the Intel SGX features.

### SGX Factory Reset

Use this feature to perform an SGX factory reset to delete all registration data and force an Initial Platform Establishment flow. Reboot the system for the change to take effect. The options are **Disabled** and Enabled.

### **SW Guard Extensions (SGX)**

Use this feature to enable Intel Software Guard Extensions (SGX) support. Intel SGX is a set of extensions that increases the security of application code and data by using enclaves in memory to protect sensitive information. The options are **Disabled** and Enabled.

### **SGX Package Info In-Band Access**

Setting this feature to Enabled is required before BIOS provides software with the key blobs, which are generated for each CPU package. The options are **Disabled** and Enabled.

### **SGX PRM Size (Available when "SW Guard Extensions (SGX)" is set to Enabled)**

Use this feature to set the Processor Reserved Memory Range Register (PRMRR) size. The options are **256 M**, 512 M, 1 G, 2 G, 4 G, 8 G, 16 G and 32 G.

## **► Chipset Configuration**

**Warning:** Setting wrong values in below sections may cause system to malfunction.

### **► North Bridge**

This feature allows you to configure the following North Bridge settings.

#### **► Uncore Configuration**

The following Uncore General Configuration information is displayed.

- Number of CPU
- Current UPI Link Speed
- Current UPI Link Frequency
- Global MMIO Low Base / Limit
- Global MMIO High Base / Limit
- PCIe Configuration Base / Size

#### **Degrade Precedence**

Use this feature to select the degrading precedence option for Ultra Path Interconnect (UPI) connections. Select Topology Precedent to degrade UPI features if system options are in conflict. Select Feature Precedent to degrade UPI topology if system options are in conflict. The options are **Topology Precedence** and Feature Precedence.

### Link L0p Enable

Select Enable for the system BIOS to enable Link L0p support. This feature allows the CPU to reduce the UPI links from full width to half width in the event when the CPU's workload is low in an attempt to save power. This feature is available for the system that uses Intel processors with UPI technology support. The options are Disable, Enable, and **Auto**.

 **Note:** You can change the performance settings for non-standard applications by using this parameter. It is recommended that the default settings be used for standard applications.

### Link L1 Enable

Select Enable for the BIOS to activate Link L1 support. This feature will power down the UPI links to save power when the system is idle. This feature is available for the system that uses Intel processors with UPI technology support. The options are Disable, Enable, and **Auto**.

 **Note:** Link L1 is an excellent feature for an idle system. L1 is used during Package C-States when its latency is hidden by other components during a wakeup.

### KTI Prefetch

Select Enable for the KTI prefetcher to preload the L1 cache with data deemed relevant. This allows the memory read to start earlier on a DDR bus in an effort to reduce latency. Select Auto for the KTI prefetcher to automatically preload the L1 cache with relevant data whenever is needed. The options are Disable, Enable, and **Auto**.

### IO Directory Cache (IODC)

Select Enable for the IODC to generate snoops instead of generating memory lockups for remote IIO (InvlToM) and/or WCiLF (Cores). Select Auto for the IODC to generate snoops (instead of memory lockups) for WCiLF (Cores). The options are Disable, **Auto**, Enable for Remote InvltoM Hybrid Push, InvltoM AllocFlow, Enable for Remote InvltoM Hybrid AllocNonAlloc, and Enable for Remote InvltoM and Remote WViLF.

### SNC

Sub NUMA Clustering (SNC) is a feature that breaks up the Last Level Cache (LLC) into clusters based on address range. Each cluster is connected to a subset of the memory controller. Enable this feature to improve average latency and reduce memory access congestion for higher performance. The options are **Auto**, Disable, Enable SNC2 (2-clusters), and Enable SNC4 (4-clusters).

### **Stale AtoS (A to S)**

The in-memory directory has three states: I, A, and S states. The I (-invalid) state indicates that the data is clean and does not exist in the cache of any other sockets. The A (-snoop All) state indicates that the data may exist in another socket in an exclusive or modified state. The S state (-Shared) indicates that the data is clean and may be shared in the caches across one or more sockets. When the system is performing "read" on the memory and if the directory line is in A state, we must snoop all other sockets because another socket may have the line in a modified state. If this is the case, a "snoop" will return the modified data. However, it may be the case that a line "reads" in an A state, and all the snoops come back with a "miss." This can happen if another socket reads the line earlier and then has silently dropped it from its cache without modifying it. If "Stale AtoS" is enabled, a line will transition to the S state when the line in the A state returns only snoop misses. That way, subsequent reads to the line will encounter it in the S state and will not have to snoop, saving the latency and snoop bandwidth. Stale "AtoS" may be beneficial in a workload where there are many cross-socket reads. The options are Disable, Enable, and **Auto**.

### **LLC Dead Line Alloc**

Select Enable to opportunistically fill the deadlines in the LLC. The options are Disable, **Enable**, and Auto.

## **► Memory Configuration**

This feature allows you to configure the Integrated Memory Controller (iMC) settings.

### **Enforce DDR Memory Frequency POR**

Select POR to enforce Plan of Record (POR) restrictions for DDR memory frequency and voltage programming. The options are **POR** and Disable.

### **Memory Frequency**

Use this feature to set the maximum memory frequency for onboard memory modules. The options are **Auto**, 3200, 3600, 4000, 4400, 4800, 5200, and 5600.

### **Enable ADR**

Select Enable for Asynchronous DRAM Refresh (ADR) support to enhance memory performance. The options are Disable and **Enable**.

### **Legacy ADR Mode**

Use this feature to support the Legacy ADR mode to enhance memory performance. The options are Disable, Enable, and **Auto**.

### **DDR 2x Refresh Enable**

Select Enable for memory 2X refresh support to enhance memory performance. The options are **Auto**, Disable, and Enable.

### **CXL Type 3 Legacy**

Use this feature to enable or disable legacy support for CXL Type 3 devices. The options are Enable and **Disable**.

### **▶ Memory Topology**

This feature displays the information of onboard memory modules as detected by the BIOS.

### **▶ Memory RAS Configuration Setup**

Use this submenu to configure the following Memory Reliability\_Availability\_Serviceability (RAS) settings.

### **Mirror Mode**

### **UEFI ARM Mirror**

### **Correctable Error Threshold**

Use this feature to specify the threshold value for correctable memory-error logging. This sets a limit on the maximum number of events that can be logged in the memory error log at a given time. The default setting is **512**.

The following information is displayed:

- Leaky Bucket Low Bit
- Leaky Bucket High Bit

### **Patrol Scrub**

Patrol Scrubbing is a process that allows the CPU to correct correctable memory errors detected in a memory module and send the corrections to the requestor (the original source). When this feature is set to Enable, the IO hub will read and write back one cache line every 16K cycles if there is no delay caused by internal processing. By using this method, roughly 64 GB of memory behind the IO hub will be scrubbed every day. The options are Disabled and **Enable at End of POST (POST: Power On Self Test)**.

### DDR PPR Type

Post Package Repair (PPR) is a new feature available for the DDR4/DDR5 technology. PPR provides additional spare capacity within a DDR4/DDR5 DRAM module that is used to replace faulty cell areas detected during system boot. PPR offers two types of memory repairs. Soft Post Package Repair (sPPR) provides a quick, temporary fix on a raw element in a bank group of a DDR4/DDR5 DRAM device, while hard Post Package Repair (hPPR) will take a longer time to provide a permanent repair on a raw element. The options are PPR Disabled, **Hard PPR**, and Soft PPR.

### Enhanced PPR

Use this feature to set advanced memory test. Select Enable to always execute for every boot. Select Once to execute only one time. The options are **Disabled**, Enabled, and Once.

### Memory PFA Support (Available when the DCMS key is activated)

Select Enabled to enable memory Predictive Failure Analysis (PFA) support. PFA can be used to avoid uncorrectable faults in the same memory page. The options are **Disabled** and Enabled.

## ► IIO Configuration

### ► CPU1 Configuration

#### IOU0/1/2/3/4 (IIO PCIe Port 1/2/3/4/5)

Use this feature to configure the PCIe port Bifurcation setting for PCIe port. The options are **Auto**, x4x4x4x4, x4x4x8, x8x4x4, x8x8, and x16.

*\*For detailed slot bifurcation mapping, refer to the system block diagram in Chapter 1.*

### ► Socket0 Port DMI

#### Link Speed

Use this feature to select the link speed for the PCIe port. The options are **Auto**, Gen 1 (2.5 GT/s), Gen 2 (5 GT/s), Gen 3 (8 GT/s), and Gen 4 (16 GT/s).

The following information is displayed:

- PCIe Port Link Status
- PCIe Port Link Max
- PCIe Port Link Speed

### **Data Link Feature Exchange**

Use this feature to enable or disable the data link feature negotiation in the Data Link Feature Capabilities (DLFCAP) register. The options are Disable and **Enable**.

### **DMI Port MPSS**

Use this feature to set the maximum payload size supported in Direct Media Interface (DMI) device capabilities register for the device installed in the PCIe port. The options are 128B, 256B, and **Auto**.

### **Equalization Bypass to Highest Rate**

Enable this feature to bypass the equalization of intermediate data rates. This will reduce the time for link training in PCIe 5.0 devices. The options are Disable and **Enable**.

### **► Socket0 Port 1A / Socket0 Port 2A / Socket0 Port 2C / Socket0 Port 2E / Socket0 Port 2G / Socket0 Port 3A / Socket0 Port 3E / Socket0 Port 4A / Socket0 Port 5A**

#### **Link Speed**

Use this feature to select the link speed for the PCIe port. The options are **Auto**, Gen 1 (2.5 GT/s), Gen 2 (5 GT/s), Gen 3 (8 GT/s), Gen 4 (16 GT/s), and Gen 5 (32 GT/s).

The following information is displayed:

- PCIe Port Link Status
- PCIe Port Link Max
- PCIe Port Link Speed

### **Data Link Feature Exchange**

Use this feature to enable or disable the data link feature negotiation in the Data Link Feature Capabilities (DLFCAP) register. The options are Disable and **Enable**.

### **PCIe Port Max Payload Size**

Selecting Auto for this feature enables the motherboard to automatically detect the maximum Transaction Layer Packet (TLP) size for the connected PCIe device, allowing for maximum I/O efficiency. Selecting 128B or 256B designates maximum packet size of 128 or 256. The options are 128B, 256B, 512B, and **Auto**.

### **Equalization Bypass to Highest Rate**

Enable this feature to bypass the equalization of intermediate data rates. This will reduce the time for link training in PCIe 5.0 devices. The options are Disable and **Enable**.

## ▶ IOAT Configuration

### Relaxed Ordering

Select Yes to enable Relaxed Ordering support. This feature allows certain transactions to violate the strict-ordering rules of PCI bus for a transaction to be completed prior to other transactions that have already been enqueued. The options are **No** and Yes.

## ▶ Intel® VT for Directed I/O (VT-d)

### Intel® VT for Directed I/O (VT-d)

Select Enable to use Intel Virtualization Technology for Direct I/O VT-d support by reporting the I/O device assignments to the Virtual Machine Monitor (VMM) through the DMAR ACPI tables. This feature offers fully-protected I/O resource sharing across Intel platforms, providing greater reliability, security and availability in networking and data-sharing. The options are **Enable** and Disable.

### Pre-boot DMA Protection

Enable this feature to help block DMA attacks. The options are Enable and **Disable**.

### Interrupt Remapping

Select Enable to support I/O DMA transfer remapping and device-generated interrupts. The options are **Auto**, Enable, and Disable.

### PCIe ACSCTL

Select Enable to program ACS control to Chipset PCIe Root Port bridges. Select Disable to program ACS control to all PCIe Root Port bridges. The options are **Disable** and Enable.

## ▶ Intel® VMD Technology

This section describes the configuration settings for the Intel VMD technology.



**Note:** After you've enabled VMD in the BIOS on a PCIe slot, this PCIe slot will be dedicated for VMD use only, and it will no longer support any PCIe device. To re-activate this slot for PCIe use, disable VMD in the BIOS.

### NVMe Mode Switch

If this feature is set to Auto, VMD mode will be automatically enabled for all NVMe slots when a VROC key is plugged in. The options are Manual, VMD, and **Auto**.

► **Intel® VMD for Volume Management Device on Socket 0 (Available when "NVMe Mode Switch" is set to Manual)**

**VMD Config for PCH ports**

**Enable/Disable VMD**

Select Enable to enable Intel Volume Management Device (VMD) technology support for the root port specified. The options are **Disable** and Enable.

**PCH Root Port 0 / PCH Root Port 1 / PCH Root Port 2 / PCH Root Port 3 /  
PCH Root Port 4 / PCH Root Port 5 / PCH Root Port 6 / PCH Root Port 8 /  
PCH Root Port 9 / PCH Root Port 10 / PCH Root Port 11**

**PCH Root Port 7 (Available when the device is detected by the system and "Enable/Disable VMD" above is set to Enable)**

Select Enable to enable Intel VMD technology support for the root port specified. The options are **Disable** and Enable.

**Hot Plug Capable**

Select Enable to enable Hot Plug support for the root ports specified. This feature allows you to change the devices on those root ports without shutting down the system. The options are **Disable** and Enable.

**VMD Config for IOU 0**

**Enable/Disable VMD**

Select Enable to enable Intel Volume Management Device (VMD) technology support for the root port specified. The options are **Disable** and Enable.

**Socket0 IOU0 VMD port A / Socket0 IOU0 VMD port C / Socket0 IOU0 VMD  
port E / Socket0 IOU0 VMD port G (Available when the device is detected by  
the system and "Enable/Disable VMD" above is set to Enable)**

Select Enable to enable Intel VMD technology support for the root port specified. The options are **Disable** and Enable.

**Hot Plug Capable**

Select Enable to enable Hot Plug support for the root ports specified. This feature allows you to change the devices on those root ports without shutting down the system. The options are **Disable** and Enable.

### **VMD Config for IOU 1**

#### **Enable/Disable VMD**

Select Enable to enable Intel Volume Management Device (VMD) technology support for the root port specified. The options are **Disable** and Enable.

#### **Socket0 IOU1 VMD port A / Socket0 IOU1 VMD port C / Socket0 IOU1 VMD port E / Socket0 IOU1 VMD port G (Available when the device is detected by the system and "Enable/Disable VMD" above is set to Enable)**

Select Enable to enable Intel VMD technology support for the root port specified. The options are **Disable** and Enable.

#### **Hot Plug Capable**

Select Enable to enable Hot Plug support for the root ports specified. This feature allows you to change the devices on those root ports without shutting down the system. The options are **Disable** and Enable.

### **VMD Config for IOU 2**

#### **Enable/Disable VMD**

Use this feature to enable or disable the volume management device for this stack. The options are **Disable** and Enable.

#### **Socket0 IOU2 VMD port A / Socket0 IOU2 VMD port C / Socket0 IOU2 VMD port E / Socket0 IOU2 VMD port G (Available when the device is detected by the system and "Enable/Disable VMD" above is set to Enable)**

Select Enable to enable Intel VMD technology support for the root port specified. The options are **Disable** and Enable.

#### **Hot Plug Capable**

Select Enable to enable Hot Plug support for the root ports specified. This feature allows you to change the devices on those root ports without shutting down the system. The options are **Disable** and Enable.

### **VMD Config for IOU 3**

#### **Enable/Disable VMD**

Select Enable to enable Intel VMD technology support for the root port specified. The options are **Disable** and Enable.

#### **Socket0 IOU3 VMD port A / Socket0 IOU3 VMD port C / Socket0 IOU3 VMD port E / Socket0 IOU3 VMD port G (Available when the device is detected by the system and "Enable/Disable VMD" above is set to Enable)**

Select Enable to enable Intel VMD technology support for the root port specified. The options are **Disable** and Enable.

### **Hot Plug Capable**

Select Enable to enable Hot Plug support for the root ports specified. This feature allows you to change the devices on those root ports without shutting down the system. The options are **Disable** and Enable.

### **VMD Config for IOU 4**

#### **Enable/Disable VMD**

Select Enable to enable Intel VMD technology support for the root port specified. The options are **Disable** and Enable.

#### **Socket0 IOU4 VMD port A / Socket0 IOU4 VMD port C / Socket0 IOU4 VMD port E / Socket0 IOU4 VMD port G (Available when the device is detected by the system and "Enable/Disable VMD" above is set to Enable)**

Select Enable to enable Intel VMD technology support for the root port specified. The options are **Disable** and Enable.

### **Hot Plug Capable**

Select Enable to enable Hot Plug support for the root ports specified. This feature allows you to change the devices on those root ports without shutting down the system. The options are **Disable** and Enable.

### **VMD Config for IOU 5 / VMD Config for IOU 6**

## **IIO-PCIe Express Global Options**

### **PCIe ASPM Support (Global)**

Use this feature to enable or disable ASPM support for all downstream devices. The options are **Disable** and Auto.

### **PCIe Max Read Request Size**

Use this feature to select the Maximum Read Request size of the PCIe device, or select Auto to allow the System BIOS to determine the value. The options are **Auto**, 128 Bytes, 256 Bytes, 512 Bytes, 1024 Bytes, 2048 Bytes, and 4096 Bytes.

### **IIO eDPC Support**

Use this feature to enable or disable IIO enhanced DPC (eDPC) support. The options are **Disable**, On Fatal Error, and On Fatal and Non-Fatal Errors.

### **IIO eDPC Interrupt (Available if "IIO eDPC Support" is set to On Fatal Error or On Fatal and Non-Fatal Errors)**

Use this feature to enable or disable IIO enhanced DPC (eDPC) interrupt. The options are Disable and **Enable**.

### **IIO eDPC ERR\_COR Message (Available if "IIO eDPC Support" is set to On Fatal Error or On Fatal and Non-Fatal Errors)**

Use this feature to enable or disable IIO enhanced DPC (eDPC) error correction message. The options are Disable and **Enable**.

## **► South Bridge**

The following USB information is displayed:

- USB Devices

### **Legacy USB Support**

Select Enabled to support onboard legacy USB devices. Select Auto to disable legacy support if there are no legacy USB devices present. Select Disabled to have all USB devices available for EFI applications only. The options are **Enabled**, Disabled, and Auto.

### **XHCI Hand-off**

This is a work-around solution for operating systems that do not support Extensible Host Controller Interface (XHCI) hand-off. The XHCI ownership change should be claimed by the XHCI driver. The options are **Enabled** and Disabled.

### **Port 60/64 Emulation**

Select Enabled for I/O port 60h/64h emulation support, which in turn, provides complete legacy USB keyboard support for the operating systems that do not support legacy USB devices. The options are **Disabled** and Enabled.

### **PCIe PLL SSC**

Select Enabled for PCH PCIe Spread Spectrum Clocking support. This feature allows the BIOS to monitor and attempt to reduce the level of electromagnetic interference caused by the components whenever needed. The options are **Disabled** and Enabled.

## **► Server ME Information**

The following General ME Configuration is displayed:

- General ME Configuration
- Oper. Firmware Version
- Current State
- Error Code

## ► PCH SATA0 Configuration

When the submenu is selected, the AMI BIOS automatically detects the presence of the SATA devices that are supported by the Intel PCH chip and displays the following features.

### **SATA Controller(s)**

This feature enables or disables the onboard SATA controller supported by the Intel PCH chip. The options are Disabled and **Enabled**.

### **SATA Mode Selection (Available when "SATA Controller" is set to Enabled)**

Use this feature to select the mode of installed SATA drives. The options are **AHCI** and RAID.



**Note 1:** The RAID option is unavailable when "Boot Mode Select" is set to Legacy.



**Note 2:** Refer to Boot submenu in BIOS Setup main menu to set "Boot Mode Select."

### **Support Aggressive Link Power Management (Available when "SATA Controller" is set to Enabled)**

When this feature is set to Enable, the SATA AHCI controller manages the power use of the SATA link. The controller will put the link in a low power mode during an extended period of I/O inactivity, and will return the link to an active state when I/O activity resumes. The options are **Disabled** and Enabled.

### **SATA SGPIO Enable**

Use this feature to enable serial GPIO for the SATA controller to ensure which storage driver can monitor and auxiliary service in a drive enclosure. This feature is only valid in AHCI/RAID mode. When you select Enable, it supports multiple-activity LEDs to show the per drive status information from the Front Panel. When you select Disabled, the SGPIO signals are off to deliver the LED messages from the Front Panel. The options are LED and **SGPIO**.



**Note:** The signals are not related to SATALED.

### **SATA Port 0–SATA Port 5**

This feature displays the information detected on the installed SATA drive on the particular SATA port.

#### **Hot Plug**

Select Enable to support Hot-plugging for the device installed on a selected SATA port. This feature allows you to replace the device installed in the slot without shutting down the system. The options are Disabled and **Enabled**.

#### **Spin Up Device**

Select Enable for Staggered Spin Up support. This feature allows the SATA devices you specified to spin up one at a time at boot up in an effort to prevent all hard drive disks from spinning up at the same time, causing a power surge. The options are **Disabled** and Enabled.

### SATA Device Type

Use this feature to specify if the device installed on the SATA port you specified should be connected to a Solid State drive or a Hard Disk Drive. The options are **Hard Disk Drive** and Solid State Drive.

## ► PCH SATA1 Configuration

When the submenu is selected, the AMI BIOS automatically detects the presence of the SATA devices that are supported by the Intel PCH chip and displays the following features.

### SATA Controller

This feature enables or disables the onboard SATA controller supported by the Intel PCH chip. The options are Disabled and **Enabled**.

### SATA Mode Selection (Available when "SATA Controller" is set to Enabled)

Use this feature to select the mode of installed SATA drives. The options are **AHCI** and RAID.



**Note 1:** The RAID option is unavailable when "Boot Mode Select" is set to Legacy.



**Note 2:** Refer to Boot submenu in BIOS Setup main menu to set "Boot Mode Select."

### Support Aggressive Link Power Management (Available when "SATA Controller" is set to Enabled)

When this feature is set to Enable, the SATA AHCI controller manages the power use of the SATA link. The controller will put the link in a low power mode during an extended period of I/O inactivity, and will return the link to an active state when I/O activity resumes. The options are **Disabled** and Enabled.

### SATA SGPIO Enable

Use this feature to enable serial GPIO for the SATA controller to ensure which storage driver can monitor and auxiliary service in a drive enclosure. This feature is only valid in AHCI/RAID mode. When you select Enable, it supports multiple-activity LEDs to show the per drive status information from the Front Panel. When you select Disabled, the SGPIO signals are off to deliver the LED messages from the Front Panel. The options are Disabled and **Enabled**.



**Note:** The signals are not related to SATALED.

### SATA Port 2 / SATA Port 4

This feature displays the information detected on the installed SATA drive on the particular SATA port.

### Hot Plug

Select Enable to support Hot-plugging for the device installed on a selected SATA port. This feature allows you to replace the device installed in the slot without shutting down the system. The options are Disabled and **Enabled**.

### Spin Up Device

Select Enable for Staggered Spin Up support. This feature allows the SATA devices you specified to spin up one at a time at boot up in an effort to prevent all hard drive disks from spinning up at the same time, causing a power surge. The options are **Disabled** and **Enabled**.

### SATA Device Type

Use this feature to specify if the device installed on the SATA port you specified should be connected to a Solid State drive or a Hard Disk Drive. The options are **Hard Disk Drive** and **Solid State Drive**.

## ► Trusted Computing

The motherboard supports TPM 2.0. The following Trusted Platform Module (TPM) information is displayed if a TPM 2.0 module is detected:

- Firmware Version
- Vendor Name

### Security Device Support

Select Enable to enable BIOS support for onboard security devices, which are not displayed in the OS. If this feature is set to Enable, TCG EFI protocol and INT1A interface will not be available. The options are **Disable** and **Enable**.

\*When "Security Device Support" is set to Enable, the following information will display:

- Active PCR banks
- Available PCR banks

### SHA256 PCR Bank (Available when "Security Device Support" is set to Enable)

Select Enabled to enable SHA256 PCR Bank support to enhance system integrity and data security. The options are **Disabled** and **Enabled**.

### Pending Operation (Available when "Security Device Support" is set to Enable)

Use this feature to schedule a TPM-related operation to be performed by a security (TPM) device at the next system boot to enhance system data integrity. Your system will reboot to carry out a pending TPM operation. The options are **None** and **TPM Clear**.



**Note:** Your system will reboot to carry out a pending TPM operation.

---

**Platform Hierarchy (Available when "Security Device Support" is set to Enable) (for TPM Version 2.0 and above)**

Select Enabled for TPM Platform Hierarchy support. This feature allows the manufacturer to utilize the cryptographic algorithm to define a constant key or a fixed set of keys to be used for initial system boot. These early boot codes are shipped with the platform and are included in the list of "public keys." During system boot, the platform firmware uses the trusted public keys to verify a digital signature in an attempt to manage and control the security of the platform firmware used in a host system via a TPM device. The options are Disabled and **Enabled**.

**Storage Hierarchy (Available when "Security Device Support" is set to Enable)**

Select Enabled for TPM Storage Hierarchy support that is intended to be used for non-privacy-sensitive operations by a platform owner such as an IT professional or the end user. Storage Hierarchy has an owner policy and an authorization value, both of which can be set and are held constant (rarely changed) through reboots. This hierarchy can be cleared or changed independently of the other hierarchies. The options are Disabled and **Enabled**.

**Endorsement Hierarchy (Available when "Security Device Support" is set to Enable)**

Select Enabled for Endorsement Hierarchy support. This feature contains separate controls to address your privacy concerns because the primary keys in the hierarchy are certified by the TPM key or by a manufacturer with restrictions on how an authentic TPM device that is attached to an authentic platform can be accessed and used. A primary key can be encrypted and certified with a certificate created by using TPM2\_ActivateCredential, which allows you to independently enable "flag, policy, and authorization values" without involving other hierarchies. You can disable the endorsement hierarchy while still using the storage hierarchy for TPM applications, permitting the platform software to use the TPM. The options are Disabled and **Enabled**.

**PH Randomization (for TPM Version 2.0 and above)**

Select Enabled for Platform Hierarchy (PH) Randomization support. This feature is used only during the platform developmental stage. This feature cannot be enabled in the production platforms. The options are **Disabled** and Enabled.

**Supermicro BIOS-Based TPM Provision Support**

If this feature is set to Enabled, Supermicro BIOS-based TPM provision will be supported. The options are **Disabled** and Enabled.



**Note:** Enabling this feature will lock your TPM on the production platform, and you will not be able to delete the NV indexes.

## TXT Support

Select Enabled to enable Intel Trusted Execution Technology (TXT) support to enhance system integrity and data security. The options are **Disabled** and Enabled.

 **Note 1:** If this feature is set to Enabled, be sure to disable Device Function On-Hide (EV DFX) support when it is present in the BIOS for the system to work properly.

 **Note 2:** For more information on TPM, refer to the TPM manual at <http://www.super-micro.com/manuals/other/TPM.pdf>.

## ▶ACPI Settings

### NUMA

Use this feature to enable Non-Uniform Memory Access (NUMA) to enhance system performance. The options are Disabled and **Enabled**.

### UMA-Based Clustering

When the feature is set to Hemisphere, Uniform Memory Access (UMA)-based clustering will support 2-cluster configuration for system performance enhancement. The options are Disabled (All2All), Hemisphere (2-clusters), and **Quadrant (4-clusters)**.

### WHEA Support

Select Enabled to support the Windows Hardware Error Architecture (WHEA) platform and provide a common infrastructure for the system to handle hardware errors within the Windows OS environment to reduce system crashes and to enhance system recovery and health monitoring. The options are Disabled and **Enabled**.

### High Precision Event Timer

Select Enabled to activate the High Precision Event Timer (HPET) that produces periodic interrupts at a much higher frequency than a Real-time Clock (RTC) does in synchronizing multimedia streams, providing smooth playback and reducing the dependency on other timestamp calculation devices, such as an x86 RDTSC Instruction embedded in the CPU. The High Performance Event Timer is used to replace the 8254 Programmable Interval Timer. The options are Disabled and **Enabled**.

## ▶Super IO Configuration

The following Super IO information is displayed:

- Super IO Chip AST2600

---

## ► Serial Port 1 Configuration

This submenu allows you to configure the settings of Serial Port 1.

### Serial Port 1

Select Enabled to enable the selected onboard serial port. The options are Disabled and **Enabled**.

### Device Settings

This feature displays the base I/O port address and the Interrupt Request address of serial port 1.

### Change Settings

This feature specifies the base I/O port address and the Interrupt Request address of the serial port. Select Auto to allow the BIOS to automatically assign the base I/O and IRQ address. The options are **Auto**, (IO=3F8h; IRQ=4;), (IO=2F8h; IRQ=4;), (IO=3E8h; IRQ=4;), and (IO=2E8h; IRQ=4;).

## ► Serial Port 2 Configuration

This submenu allows you to configure the settings of Serial Port 2.

### Serial Port 2

Select Enabled to enable the selected onboard serial port. The options are Disabled and **Enabled**.

### Device Settings

This feature displays the status of a serial port.

### Change Settings

This feature specifies the base I/O port address and the Interrupt Request address of the serial port. Select Auto to allow the BIOS to automatically assign the base I/O and IRQ address. The options are **Auto**, (IO=2F8h; IRQ=3;), (IO=3F8h; IRQ=3;), (IO=3E8h; IRQ=3;), and (IO=2E8h; IRQ=3;).

### Serial Port 2 Attribute (Available for Serial Port 2 only)

Select SOL to use serial port 2 as a Serial Over LAN (SOL) port for console redirection. The options are **SOL** and COM.

## ► Serial Port Console Redirection

### COM1

#### Console Redirection

Select Enabled to enable COM port 1 for Console Redirection. This feature allows a client machine to be connected to a host machine at a remote site for networking. The options are **Disabled** and **Enabled**.



**Note:** This feature will be set to Enabled if there is no BMC support.

#### ► COM1 Console Redirection Settings (Available when "Console Redirection" above is set to Enabled)

##### Terminal Type

Use this feature to select the target terminal emulation type for Console Redirection. Select VT100 to use the ASCII Character set. Select VT100+ to add color and function key support. Select ANSI to use the Extended ASCII Character Set. Select VT-UTF8 to use UTF8 encoding to map Unicode characters into one or more bytes. The options are VT100, **VT100+**, VT-UTF8, and ANSI.

##### Bits Per Second

Use this feature to set the transmission speed for a serial port used in Console Redirection. Make sure that the same speed is used in the host computer and the client computer. A lower transmission speed may be required for long and busy lines. The options are 9600, 19200, 38400, 57600, and **115200** (bits per second).

##### Data Bits

Use this feature to set the data transmission size for Console Redirection. The options are 7 and **8**.

##### Parity

A parity bit can be sent along with regular data bits to detect data transmission errors. Select Even if the parity bit is set to 0, and the number of 1's in data bits is even. Select Odd if the parity bit is set to 0, and the number of 1's in data bits is odd. Select None if you do not want to send a parity bit with your data bits in transmission. Select Mark to add a mark as a parity bit to be sent along with the data bits. Select Space to add a Space as a parity bit to be sent with your data bits. The options are **None**, Even, Odd, Mark, and Space.

##### Stop Bits

A stop bit indicates the end of a serial data packet. Select 1 Stop Bit for standard serial data communication. Select 2 Stop Bits if slower devices are used. The options are **1** and 2.

**Flow Control**

Use this feature to set the flow control for Console Redirection to prevent data loss caused by buffer overflow. Send a "Stop" signal to stop sending data when the receiving buffer is full. Send a "Start" signal to start sending data when the receiving buffer is empty. The options are **None** and Hardware RTS/CTS.

**VT-UTF8 Combo Key Support**

Select Enabled to enable VT-UTF8 Combination Key support for ANSI/VT100 terminals. The options are Disabled and **Enabled**.

**Recorder Mode**

Select Enabled to capture the data displayed on a terminal and send it as text messages to a remote server. The options are **Disabled** and Enabled.

**Resolution 100x31**

Select Enabled for extended-terminal resolution support. The options are Disabled and **Enabled**.

**Putty KeyPad**

This feature selects Function Keys and KeyPad settings for Putty which is a terminal emulator designed for the Windows OS. The options are **VT100**, LINUX, XTERMR6, SCO, ESCN, and VT400.

**SOL/COM2****Console Redirection**

Select Enabled to use the SOL port for Console Redirection. The options are Disabled and **Enabled**.

**► Console Redirection Settings (Available when "Console Redirection" above is set to Enabled)**

Use this feature to specify how the host computer will exchange data with the client computer.

**Terminal Type**

Use this feature to select the target terminal emulation type for Console Redirection. Select VT100 to use the ASCII Character set. Select VT100+ to add color and function key support. Select ANSI to use the Extended ASCII Character Set. Select VT-UTF8 to use UTF8 encoding to map Unicode characters into one or more bytes. The options are ANSI, VT100, **VT100+**, VT-UTF8 and ANSI.

### **Bits Per Second**

Use this feature to set the transmission speed for a serial port used in Console Redirection. Make sure that the same speed is used in the host computer and the client computer. A lower transmission speed may be required for long and busy lines. The options are 9600, 19200, 38400, 57600, and **115200** (bits per second).

### **Data Bits**

Use this feature to set the data transmission size for Console Redirection. The options are 7 and **8**.

### **Parity**

A parity bit can be sent along with regular data bits to detect data transmission errors. Select Even if the parity bit is set to 0, and the number of 1's in data bits is even. Select Odd if the parity bit is set to 0, and the number of 1's in data bits is odd. Select None if you do not want to send a parity bit with your data bits in transmission. Select Mark to add a mark as a parity bit to be sent along with the data bits. Select Space to add a Space as a parity bit to be sent with your data bits. The options are **None**, Even, Odd, Mark, and Space.

### **Stop Bits**

A stop bit indicates the end of a serial data packet. Select 1 Stop Bit for standard serial data communication. Select 2 Stop Bits if slower devices are used. The options are **1** and 2.

### **Flow Control**

Use this feature to set the flow control for Console Redirection to prevent data loss caused by buffer overflow. Send a "Stop" signal to stop sending data when the receiving buffer is full. Send a "Start" signal to start sending data when the receiving buffer is empty. The options are **None** and Hardware RTS/CTS.

### **VT-UTF8 Combo Key Support**

Select Enabled to enable VT-UTF8 Combination Key support for ANSI/VT100 terminals. The options are Disabled and **Enabled**.

### **Recorder Mode**

Select Enabled to capture the data displayed on a terminal and send it as text messages to a remote server. The options are **Disabled** and Enabled.

### **Resolution 100x31**

Select Enabled for extended-terminal resolution support. The options are Disabled and **Enabled**.

### **Putty KeyPad**

This feature selects Function Keys and KeyPad settings for Putty, which is a terminal emulator designed for the Windows OS. The options are **VT100**, LINUX, XTERMR6, SCO, ESCN, and VT400.

## Legacy Console Redirection

### ► Legacy Console Redirection Settings

#### Legacy Serial Redirection Port

Use this feature to select a COM port to display redirection of Legacy OS and Legacy OPRM messages. The options are **COM1** and SOL.

#### Resolution

Use this feature to select the number of rows and columns used in Console Redirection for Legacy OS support. The options are 80x24 and **80x25**.

#### Redirection After POST

Use this feature to enable or disable legacy console redirection after BIOS POST. When the option - BootLoader is selected, legacy console redirection is disabled before booting the OS. When the option - Always Enable is selected, legacy console redirection remains enabled upon OS bootup. The options are **Always Enable** and BootLoader.

## Serial Port for Out-of-Band Management/Windows Emergency Management Services (EMS)

### Console Redirection EMS

Select Enabled to use the SOL port for Console Redirection. The options are **Disabled** and Enabled.

### ► Console Redirection Settings (Available when "Console Redirection EMS" above is set to Enabled)

This feature allows you to specify how the host computer exchanges data with the client computer. The client computer is the remote computer you use.

#### Out-of-Band Mgmt Port

The feature selects a serial port in a client server to be used by the Microsoft Windows Emergency Management Services (EMS) to communicate with a remote host server. The options are **COM1** and SOL. Note that the SOL option is unavailable if there is no BMC support.

#### Terminal Type EMS

Use this feature to select the target terminal emulation type for Console Redirection. Select VT100 to use the ASCII character set. Select VT100+ to add color and function key support. Select ANSI to use the extended ASCII character set. Select VT-UTF8 to use UTF8 encoding to map Unicode characters into one or more bytes. The options are VT100, VT100+, **VT-UTF8**, and ANSI.

### **Bits Per Second EMS**

This feature sets the transmission speed for a serial port used in Console Redirection. Make sure that the same speed is used in the host computer and the client computer. A lower transmission speed may be required for long and busy lines. The options are 9600, 19200, 57600, and **115200** (bits per second).

### **Flow Control EMS**

Use this feature to set the flow control for Console Redirection to prevent data loss caused by buffer overflow. Send a "Stop" signal to stop sending data when the receiving buffer is full. Send a "Start" signal to start sending data when the receiving buffer is empty. The options are **None**, Hardware RTS/CTS, and Software Xon/Xoff.

The following information is displayed:

Data Bits EMS / Parity EMS / Stop Bits EMS

## **► Network Configuration**

### **Network Stack**

Select Enabled to enable Preboot Execution Environment (PXE) or Unified Extensible Firmware Interface (UEFI) for network stack support. The options are Disabled and **Enabled**.

### **IPv4 PXE Support (Available when "Network Stack" is set to Enabled)**

Select Enabled to enable IPv4 PXE boot support. If this feature is disabled, it will not create the IPv4 PXE boot option. The options are Disabled and **Enabled**.

### **IPv4 HTTP Support (Available when "Network Stack" is set to Enabled)**

Select Enabled to enable IPv4 HTTP boot support. If this feature is disabled, it will not create the IPv4 HTTP boot option. The options are **Disabled** and Enabled.

### **IPv6 PXE Support (Available when "Network Stack" is set to Enabled)**

Select Enabled to enable IPv6 PXE boot support. If this feature is disabled, it will not create the IPv6 PXE boot option. The options are **Disabled** and Enabled.

### **IPv6 HTTP Support (Available when "Network Stack" is set to Enabled)**

Select Enabled to enable IPv6 HTTP boot support. If this feature is disabled, it will not create the IPv6 HTTP boot option. The options are **Disabled** and Enabled.

### **PXE Boot Wait Time (Available when "Network Stack" is set to Enabled)**

Use this feature to set the wait time (in seconds) upon which the system BIOS will wait for you to press the <ESC> key to abort PXE boot instead of proceeding with PXE boot by connecting to a network server immediately. Press <+> or <-> on your keyboard to change the value. The default setting is **0**.

### Media Detect Count

Use this feature to select the wait time (in seconds) for the BIOS ROM to detect the presence of a LAN media either via the Internet connection or via a LAN port. Press <+> or <-> on your keyboard to change the value. The default setting is **1**.

### ▶ **MAC:xxxxxxxxxxx-IPv6 Network Configuration** ▶ **MAC:xxxxxxxxxxx-IPv6 Network Configuration**

#### ▶ **Enter Configuration Menu**

The following information is displayed:

Interface Name / Interface Type / MAC address / Host addresses / Route Table / Gateway addresses / DNS addresses

#### **Interface ID**

Use this feature to set the 64-bit alternative interface ID for the device.

#### **DAD Transmit Count**

If this set feature is set to 0, the Duplication Address Detection is not performed. Set the value to a preferred selection. The default value is **1**.

#### **Policy**

Use this feature to set the policy to automatic or manual. The options are **automatic** and manual.

#### ▶ **Advanced Configuration (Available when "Policy" is set to manual)**

##### **New IPv6 address**

Use this feature to enter the IPv6 address for the local machine.

##### **New Gateway address**

Use this feature to set the gateway address for the local machine.

##### **New DNS address**

Use this feature to set the DNS server address for the local machine.

##### **Commit Changes and Exit**

Press <Enter> to save changes and exit. The options are **Yes** and No.

##### **Discard Changes and Exit**

Press <Enter> to discard changes and exit. The options are **Yes** and No.

### **Save Changes and Exit**

Select this feature to save the changes for the features above and exit.

- ▶ **MAC:xxxxxxxxxxx-IPv4 Network Configuration**
- ▶ **MAC:xxxxxxxxxxx-IPv4 Network Configuration**

### **Configured**

Select Enabled to show whether the network address has been successfully configured. The options are **Disabled** and Enabled.

### **Enable DHCP (Available when "Configured" is set to Enabled)**

Select Enabled to support Dynamic Host Configuration Protocol (DHCP). This feature allows the BIOS to search for a DHCP server attached to the network and request the next available IP address for this computer. The options are **Disabled** and Enabled.

### **Local IP Address (Available when "Configured" is set to Enabled and "Enabled DHCP" is set to Disabled)**

Use this feature to enter an IP address for the local machine.

### **Local NetMask (Available when "Configured" is set to Enabled and "Enabled DHCP" is set to Disabled)**

Use this feature to set the network for the local machine.

### **Local Gateway (Available when "Configured" is set to Enabled and "Enabled DHCP" is set to Disabled)**

Use this feature to set the gateway address for the local machine.

### **Local DNS Servers (Available when "Configured" is set to Enabled and "Enabled DHCP" is set to Disabled)**

Use this feature to set the Domain Name System (DNS) server address for the local machine.

### **Save Changes and Exit**

Select this feature to save the changes for the features above and exit.

## ► PCIe/PCI/PnP Configuration

The following information is displayed:

- PCI Bus Driver Version

### PCI Devices Common Settings:

#### Above 4G Decoding (Available if the system supports 64-bit PCI decoding)

Select Enabled to decode a PCI device that supports 64-bit in the space above 4G Address. The options are Disabled and **Enabled**.

#### MMCFG Base

This feature determines how the lowest Memory Mapped Configuration (MMCFG) base is assigned to onboard PCI devices. The options are 1 G, 1.5 G, 1.75 G, 2 G, 2.25 G, 3 G, and **Auto**.

#### MMCFG Size

Use this feature to set the MMCFG size. The options are 64 M, 128 M, 256 M, 512 M, 1 G, 2 G, and **Auto**.

#### MMIO High Base

Use this feature to select the base memory size according to memory-address mapping for the IO hub. The options are 56T, 40T, **32T**, 24T, 16T, 4T, 2T, 1T, 512 G, and 3584T.

#### MMIO High Granularity Size

Use this feature to select the high memory size according to memory-address mapping for the IO hub. The options are 1 G, 4 G, 16 G, 64 G, **256 G**, and 1024 G.

#### SR-IOV Support

Use this feature to enable or disable Single Root IO Virtualization Support. The options are Disabled and **Enabled**.

#### ARI Support

Use this feature to enable or disable ARI support. The options are Disabled and **Enabled**.

#### Bus Master Enable

If this setting is set to Enabled, the PCI Bus Driver will enable the Bus Master Attribute for DMA transactions. If this setting is set to Disabled, the PCI Bus Driver will disable the Bus Master Attribute for Pre-Boot DMA protection. The options are Disabled and **Enabled**.

#### Consistent Device Name Support

Use this feature to enable or disable ACPI\_DSM device name support for onboard devices and slots. The options are **Disabled** and Enabled.

### **NVMe Firmware Source**

Use this feature to select the NVMe firmware to support system booting. The default option, Vendor Defined Firmware, is pre-installed on the drive and may resolve errata or enable innovative functions for the drive. The other option, AMI Native Support, is offered by the BIOS with a generic method. The options are **Vendor Defined Firmware** and AMI Native Support.

### **VGA Priority**

Use this feature to select the graphics device to be used as the primary video display for system boot. The options are **Onboard** and Offboard.

For the following features, note that:



**Note 1:** The number of slots and slot naming vary based on your motherboard.



**Note 2:** The Legacy option is available when "Boot Mode Select" is set to Dual.



**Note 3:** Refer to Boot submenu in BIOS Setup main menu to set "Boot Mode Select."

### **Onboard Video Option ROM**

Select EFI to allow you to boot the computer using the Extensible Firmware Interface (EFI) device installed on the onboard video port. The options are Disabled, **EFI**, and Legacy.

### **M.2-1 PCIe 3.0 x4 OPROM / M.2-2 PCIe 3.0 x4 OPROM / AOC-GTG-i2T Option ROM**

Select EFI to allow you to boot the computer using the EFI device installed on the PCIe slot specified. The options are Disabled, Legacy, and **EFI**.

### **Onboard SAS Option ROM**

Use this feature to enable or disable the onboard SAS firmware to be loaded. The options are Disabled, Legacy, and **EFI**.

### **Onboard NVME1 Option ROM / Onboard NVME2 Option ROM / Onboard NVME3 Option ROM / Onboard NVME4 Option ROM / Onboard NVME5 Option ROM / Onboard NVME6 Option ROM**

Use this feature to select which firmware function to be loaded for the NVMe device in this slot. The options are Disabled, Legacy, and **EFI**.

## **► HTTP Boot Configuration**

### **HTTP Boot Policy**

Use this feature to set the HTTP boot policy. The options are Apply to all LANs, **Apply to each LAN**, and Boot Priority #1 instantly.

### **HTTPS Boot Checks Hostname**

Use this feature to select whether HTTPS Boot checks the hostname of TLS certificates matches the hostname provided by the remote server. The options are **Enabled** and Disabled (WARNING: Security Risk!!).

**Priority of HTTP Boot****Instance of Priority 1:**

This feature sets the rank target port. The default value is **1**.

**Select IPv4 or IPv6**

This feature specifies which connection the target LAN port should boot from. The options are **IPv4** and IPv6.

**Boot Description**

Use this feature to enter a boot description that cannot be longer than 75 characters. Enter a boot description; otherwise, the boot option for the URI cannot be created.

**Boot URI**

Enter a Boot Uniform Research Identifier (URI) with 128 characters or shorter. This Boot URI determines how IPv4 Boot Option and IPv6 Boot Option will be created. This feature is only supported on Dual or EFI Boot Mode.

**► Supermicro KMS Server Configuration****Supermicro KMS Server IP address**

Use this feature to enter the Supermicro Key Management Service (KMS) server IPv4 address in dotted-decimal notation (e.g., 255.255.255.255).

**Second Supermicro KMS Server IP address**

Use this feature to enter the second Supermicro KMS server IPv4 address in dotted-decimal notation (e.g., 255.255.255.255).

**Supermicro KMS TCP Port number**

Use this feature to enter the Supermicro KMS TCP port number. The valid range is 100–9999. The default setting is **5696**.

**KMS Time Out**

Use this feature to enter the KMS server connecting time-out (in seconds). The default setting is **5** (seconds).

**TimeZone**

Use this feature to enter the correct time zone. The default setting is **0** (not specified).

**Client UserName**

Press <Enter> to set the client identity (UserName). The length is 0–63 characters.

**Client Password**

Press <Enter> to set the client identity (Password). The length is 0–31 characters.

## KMS TLS Certificate / Size

### ▶ CA Certificate

For the CA certificate, use this feature to enroll factory defaults or load the KMS TLS certificates from the file. The options are **Update**, Delete, and Export.

### ▶ Client Certificate

For the client certificate, use this feature to enroll factory defaults or load the KMS TLS certificates from the file. The options are **Update**, Delete, and Export.

### ▶ Client Private Key

For the client private key, use this feature to enroll factory defaults or load the KMS TLS certificates from the file. The options are **Update**, Delete, and Export.

## ▶ Super-Guardians Configuration

Super Guardians is a unified security solution to facilitate KMS, TPM, or USB-based authentication controls for Supermicro X13 motherboards. Use this submenu to configure the authentication policy, method, and KMS server settings.

### Super-Guardians Protection Policy

Use this feature to enable the Super-Guardians Protection Policy. The options are **Storage**, System, and "System and Storage." Set this feature to Storage to protect and have secure access to Trusted Computing Group (TCG) NVMe devices with the Authentication-Key (AK). Set this feature to System to protect and have secure access to your system/motherboard with the AK. Set this feature to "System and Storage" to protect and have secure access to your TCG NVMe devices/system/motherboard with the AK.

### KMS Security Policy

Set this feature to Enabled to enable the Key Management Service (KMS) Security Policy. When this feature has not previously been set to Enabled, the options are **Disabled** and Enabled. Changes take effect after you save settings and reboot the system.



**Note 1:** Be sure that the KMS server is ready before configuring this feature.



**Note 2:** Use the professional KMS server solutions (e.g., Thales Server) or the Supermicro PyKMIP Software Package to establish the KMS server.

When this feature has previously been set to Enabled, the options are **Enabled**, Reset, and Key Rotation. Set this feature to Key Rotation to obtain an existing Authentication-Key from the KMS server and create a new Authentication-Key. To disable the KMS Security Policy, set this feature to Reset. When this feature is set to reset, the system and TCG NVMe devices chosen in "Super-Guardians Protection Policy" will be in the unprotected mode.

### KMS Server Retry Count

Use this feature to specify how many times the system will attempt reconnecting to the KMS server. Press <+> or <-> on your keyboard to change the value. The default setting is **5**. If the value is 0, the system will retry infinitely. The valid range is 0 to 10.

### TPM Security Policy

Use this feature to enable or disable the TPM Security Policy. When this feature has not previously been set to Enabled, the options are **Disabled** and Enabled. Changes take effect after you save settings and reboot the system.

 **Note:** Install a Trusted Platform Module 2.0 device to your system before configuring this feature.

When this feature has previously been set to Enabled, the options are **Enabled** and Reset. To disable the TPM Security Policy, set this feature to Reset. When this feature is set to reset, the system and TCG NVMe devices chosen in "Super-Guardians Protection Policy" will be in the unprotected mode.

### Load Authentication-Key

Use this feature to toggle whether the BIOS should automatically load an Authentication-Key named TPMAuth.bin from a USB flash drive. The options are **Disabled** and Enabled. Set this feature to Enabled to load the Authentication-Key. After an Authentication Key is loaded, this option will be reset to Disabled. Changes take effect after you save settings and reboot the system.

 **Note 1:** Connect a USB flash drive with the Authentication-Key (TPMAuth.bin) to your system before configuring this feature.

 **Note 2:** Load the Authentication-Key after installing a TPM device. The TPM function will not work properly without an Authentication-Key.

### Save Authentication-Key

Use this feature to toggle whether the BIOS should automatically save an Authentication-Key with the name TPMAuth.bin to a USB flash drive. The options are **Disabled** and Enabled. After an Authentication Key is saved, this option will be reset to Disabled. Changes take effect after you save settings and reboot the system.

 **Note 1:** Connect a USB flash drive to your system before configuring this feature. Save the Authentication-Key and keep a backup.

 **Note 2:** Load the Authentication-Key after installing a TPM device. The TPM function will not work properly without an Authentication-Key.

## USB Security Policy

Use this feature to configure USB Security Policy settings. When this feature has not previously been set to Enabled, this feature will toggle whether the BIOS should automatically save a USB Authentication-Key named "USBAuth.bin" to a USB flash drive and begin the USB Security Policy. The options are **Disabled** and Enabled. Changes take effect after you save settings and reboot the system.

 **Note:** Connect a USB flash drive to your system before configuring this feature. Save the USB Authentication-Key and keep a backup.

When this feature has been previously set to Enabled, the options are **Enabled** and Reset. To disable the USB Security Policy, set this feature to Reset. When this feature is set to reset, the system and TCG NVMe devices chosen in "Super-Guardians Protection Policy" will be in the unprotected mode.

▶ **Intel(R) Ethernet Controller X710 - XX:XX:XX:XX:XX:XX**

▶ **Intel(R) Ethernet Controller X710 - XX:XX:XX:XX:XX:XX**

 **Note 1:** This feature is available when "Onboard LAN Option ROM Type" is set to EFI.

 **Note 2:** The Ethernet controller and MAC addresses shown above are based on your system.

## ▶ Firmware Image Properties

The following information is displayed:

- Option ROM Version
- Unique NVM/EEPROM ID
- NVM Version

## ▶ NIC Configuration

### Link Speed

### Wake On LAN

If this feature is set to Enabled, the LAN port you specified will be enabled when the system is powered on. The options are Disabled and **Enabled**.

### LLDP Agent

Select Enabled to enable the Link Layer Discovery Protocol (LLDP) agent which will provide the basic device information of a device to other devices on the same Local Area Network periodically (about 30 seconds). The options are **Enabled** and Disabled.

### **Blink LEDs**

Use this feature to identify the physical network port by blinking the associated LED. The default setting is **0** (up to 15 seconds).

The following information is displayed:

- UEFI Driver
- Adapter PBA
- Device Name
- Chip Type
- PCI Device ID
- PCI Address
- Link Status
- MAC Address
- Virtual MAC Address

### **► TLS Authenticate Configuration**

This submenu allows you to configure Transport Layer Security (TLS) settings.

#### **► Server CA Configuration**

This feature allows you to configure the client certificate that is to be used by the server.

#### **► Enroll Certification**

This feature allows you to enroll the certificate in the system.

#### **► Enroll Certification Using File**

This feature allows you to enroll the security certificate in the system by using a file.

### **Certification GUID**

Press <Enter> and input the certification Global Unique Identifier (GUID).

### **Commit Changes and Exit**

Use this feature to save all changes and exit TLS settings.

### **Discard Changes and Exit**

Use this feature to discard all changes and exit TLS settings.

#### **▶ Delete Certification**

Use this feature to discard all changes and exit TLS settings. The options are **Disabled** and **Enabled**.

### **▶ Client Certification Configuration**

#### **▶ Driver Health**

This feature displays the health information of the drivers installed in your system, including LAN controllers, as detected by the BIOS. Select one and press <Enter> to see the details.

#### **▶ Intel(R) 40 GbE Driver 4.8.08**

**Intel(R) Ethernet Controller X710 for 10GBASE-T**

**Intel(R) Ethernet Controller X710 for 10GBASE-T**

#### **▶ Intel(R) 40 GbE Driver 4.8.08**

**Intel(R) Ethernet Controller X710 for 10GBASE-T**

**Intel(R) Ethernet Controller X710 for 10GBASE-T**

#### **▶ AvagoTech MPT35 SAS-PCIe UEFI BSD HII**

**SAS3808**

## 4.4 Event Logs

Use this menu to configure Event Log settings.

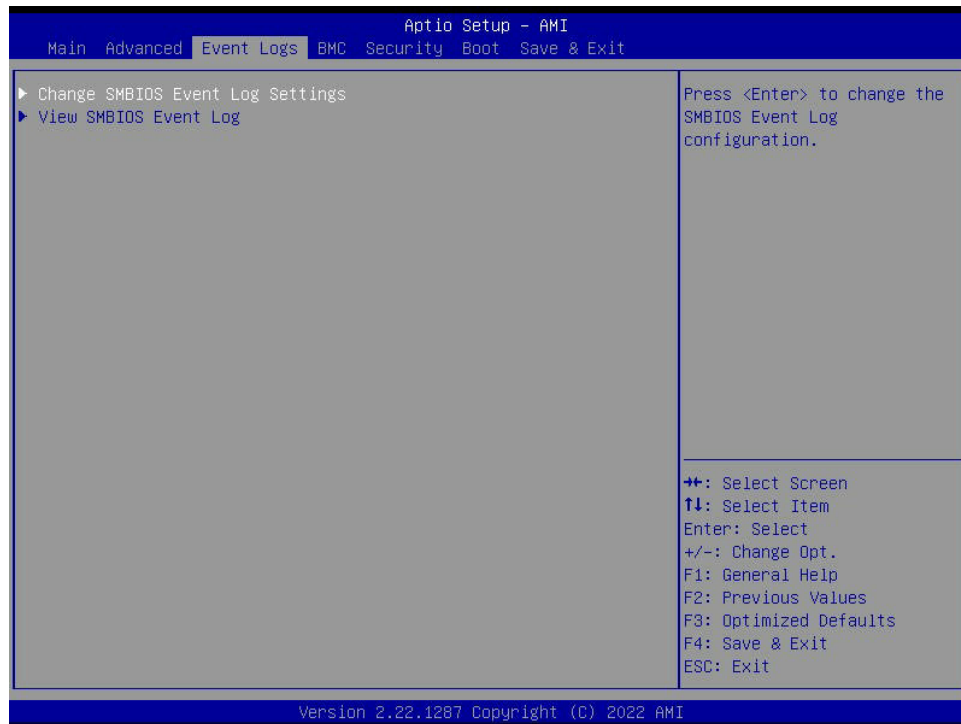

 **Note:** The changes take effect after you press Save Changes and Exit, Save Changes and Reset, or Save Changes in the Save and Exit submenu.

### ► Change SMBIOS Event Log Settings

#### Enabling/Disabling Options

##### SMBIOS Event Log

Select Enabled to enable System Management BIOS (SMBIOS) Event Logging during system boot. The options are Disabled and **Enabled**.

#### Erasing Settings

##### Erase Event Log (Available when "SMBIOS Event Log" is set to Enabled)

Select "No" to keep the event log without erasing it upon next system bootup. Select "Yes, Next Reset" to erase the event log upon next system reboot. The options are **No**, (Yes, Next reset), and (Yes, Every reset).

##### When Log is Full (Available when "SMBIOS Event Log" is set to Enabled)

Select Erase Immediately to immediately erase all errors in the SMBIOS event log when the event log is full. Select Do Nothing for the system to do nothing when the SMBIOS event log is full. The options are **Do Nothing** and Erase Immediately.

## **SMBIOS Event Log Standard Settings**

### **Log System Boot Event (Available when "SMBIOS Event Log" is set to Enabled)**

Select Enabled to log system boot events. The options are Enabled and **Disabled**.

### **MECI (Multiple Event Count Increment) (Available when "SMBIOS Event Log" is set to Enabled)**

Enter the increment value for the multiple event counter. Enter a number between 1 to 255. The default setting is **1**.

### **METW (Multiple Event Count Time Window) (Available when "SMBIOS Event Log" is set to Enabled)**

This feature is used to determine how long (in minutes) should the multiple event counter wait before generating a new event log. Enter a number between 0 to 99. The default setting is **60**.



**Note:** All values changed here do not take effect until computer is restarted.

## **►View SMBIOS Event Log**

This feature allows you to view the event in the system event log. Select this feature and press <Enter> to view the status of an event in the log. The following categories will be displayed:

DATE / TIME / ERROR CODE / SEVERITY.

## 4.5 BMC

Use this menu to configure BMC settings.



### BMC Firmware Revision

This feature indicates the IPMI firmware revision used in your system.

### BMC STATUS (Baseboard Management Controller)

This feature indicates the status of the IPMI firmware installed in your system.

## ▶ System Event Log

### Enabling/Disabling Options

#### SEL Components

Select Enabled to enable all system event logging upon system boot. The options are Disabled and **Enabled**.

#### Erasing Settings

##### Erase SEL

Select (Yes, On next reset) to erase all system event logs upon next system boot. Select (Yes, On every reset) to erase all system event logs upon each system reboot. Select No to keep all system event logs after each system reboot. The options are **No**, (Yes, On next reset), and (Yes, On every reset).

### When SEL is Full

This feature allows you to determine what the BIOS should do when the system event log is full. Select Erase Immediately to erase all events in the log when the system event log is full. The options are **Do Nothing** and Erase Immediately.



**Note:** All values changed here do not take effect until computer is restarted.

## ► BMC Network Configuration

### BMC Network Configuration

#### Update BMC LAN Configuration

Select Yes for the BIOS to implement all IP/MAC address changes upon next system boot. The options are **No** and Yes.

\*\*\*\*\*

#### Configure IPv4 Support

\*\*\*\*\*

#### BMC LAN Selection

Use this feature to select the type of the IPMI LAN. The default setting is **Failover**.

#### BMC Network Link Status

This feature displays the status of the IPMI network link for this system. The default setting is **Dedicated LAN**.

#### Configuration Address Source (Available when "Update BMC LAN Configuration" is set to Yes)

Use this feature to select the source of the IPv4 connection. If Static is selected, you will need to know the IP address of IPv4 connection and enter it to the system manually in the field. If DHCP is selected, the BIOS will search for a Dynamic Host Configuration Protocol (DHCP) server in the network that is attached to and request the next available IP address for this computer. The options are **DHCP** and Static.

#### Station IP Address (Available when "Configuration Address Source" is set to Static)

This feature displays the Station IP address in decimal and in dotted quad form (i.e., 172.29.176.131).

#### Subnet Mask (Available when "Configuration Address Source" is set to Static)

This feature displays the sub-network that this computer belongs to. The value of each three-digit number separated by dots should not exceed 255.

---

**Station MAC Address (Available when "Configuration Address Source" is set to Static)**

This feature displays the Station MAC address for this computer. Mac addresses are six two-digit hexadecimal numbers.

**Gateway IP Address**

This feature displays the Gateway IP address for this computer. This should be in decimal and in dotted quad form (i.e., 172.29.0.1).

**VLAN (Available when "Update BMC LAN Configuration" is set to Yes)**

This feature displays the status of VLAN support. The options are **Disable** and **Enable**.

**VLAN ID (Available when "BMC" is set to Enable)**

Use this feature to create a new LAN ID by using an existing VLAN or creating a new VLAN ID. Enter a valid value between 1–4094.

\*\*\*\*\*

**Configure IPv6 Support**

\*\*\*\*\*

**IPv6 Address Status**

This feature displays the status of the IPv6 address.

**IPv6 Support**

Use this feature to enable IPv6 support. The options are **Enabled** and **Disabled**.

**Configuration Address Source (Available when "IPv6 Support" is set to Enabled)**

Use this feature to select the source of the IPv6 connection. If Static Configuration is selected, you will need to know the IP address of IPv6 connection and enter it to the system manually in the field. If the Dynamic Host Configuration Protocol (DHCP) related option is selected, the BIOS will search for a DHCP server in the network that is attached to and request the next available IP address for this computer. The options are Static Configuration, **DHCPv6 Stateless**, and DHCPv6 Stateful.

**IPv6 Address (DHCPv6 Static) (Available when "Configuration Address Source" is set to Static Configuration)**

This feature displays the station IPv6 address. Press <Enter> to change the setting.

**Prefix Length (Available when "Configuration Address Source" is set to Static Configuration)**

This feature displays the prefix length. Press <Enter> to change the setting.

**Gateway IP (Available when "Configuration Address Source" is set to Static Configuration)**

Use this feature to enter the IPv6 gateway IP address. Press <Enter> to change the setting.

**Advanced Settings**

This feature allows you to automatically obtain the DNS server IP or manually obtain the DNS server IP. The options are **Auto obtain DNS server IP** and Manually obtain DNS server IP.

**Preferred DNS server IP**

Use this feature to enter the preferred DNS server IP address in dotted-decimal notation (e.g., 255.255.255.255).

**Alternative DNS server IP**

Use this feature to enter the alternative DNS server IP address in dotted-decimal notation (e.g., 255.255.255.255).

## 4.6 Security

Use this menu to configure the following security settings for the system.

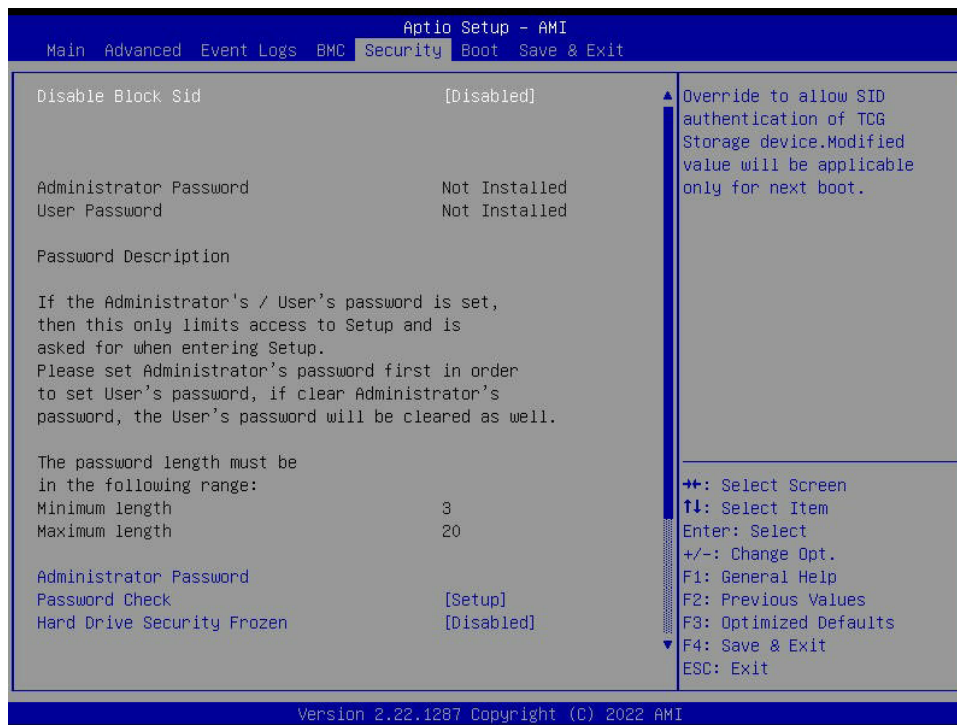

The following information is displayed:

- Administrator Password
- User Password
- Password Description

### Administrator Password

This feature indicates if an administrator password has been set. It also allows you to set the administrator password which is required to enter the BIOS Setup utility. The length of the password should be from three characters to 20 characters long.

### User Password (Available when "Administrator Password" has been set)

This feature indicates if a user password has been set. It also allows you to set the user password which is required to enter the BIOS Setup utility. This feature provides the description of the user password. The length of the password should be from three characters to 20 characters long.

 **Note:** For detailed instructions on how to configure Security Boot settings, refer to the Security Boot Configuration User's Guide posted on the web page under the link: <http://www.supernmicro.com/support/manuals/>.

### **Password Check**

Select Setup for the system to check for a password at Setup. Select Always for the system to check for a password at bootup and upon entering the BIOS Setup utility. The options are **Setup** and Always.

### **Hard Drive Security Frozen**

Select Enabled to freeze the Lock Security feature for HDD to protect key data in hard drives from being altered. The options are Enabled and **Disabled**.

### **Lockdown Mode (Available when the DCMS key is activated)**

Select Enabled to support Lockdown Mode that will prevent existing data or keys stored in the system from being altered or changed in an effort to preserve system integrity and security. The options are **Disabled** and Enabled.

## **► Supermicro Security Erase Configuration (Available when any storage device is detected by the BIOS)**

This section allows you to configure the Supermicro-proprietary Security Erase settings. When this section is selected, the following information is displayed. Note that the order of the following information may differ based on the storage devices being detected.

- **HDD Name:** This feature displays the name of the HDD/SATA drive that is detected by the BIOS.
- **HDD Serial Number:** This feature displays the serial number of the HDD/SATA device that is detected by the BIOS.
- **Security Mode:** This feature displays the security mode of the HDD/SATA device that is detected by the BIOS.
- **Estimated Time:** This feature displays the estimate time needed to perform the selected Security Erase features.
- **HDD User Pwd Status:** This feature indicates if a password has been set as a SATA user password which allows you to configure Supermicro Security Erase settings on the HDD (SATA) device by using this SATA user password.
- **Admin Pwd Status:** This feature indicates if a password has been set as a SATA administrator password which allows you to configure Supermicro Security Erase settings on the HDD (SATA) device by using this SATA administrator password.

## Security Function

Select Set Password to set an HDD/SATA password which allows you to configure the security settings of the HDD/SATA device. Select Security Erase - Password to enter a SATA user password to allow you to erase the password and the contents previously stored in the HDD/SATA device. Select Security Erase - Password to use the manufacturer default password "111111111" as the SATA user password and allow you to erase the contents of the HDD/SATA device by using this default password. The options are **Disabled**, Set Password, Security Erase - Password, Security Erase - PSID, and Security Erase - Without Password.



**Note:** The option, Security Erase - PSID, is based on the storage device support.

## Password

Use this feature to set the SATA user password which allows you to configure the Supermicro Security Erase settings by using the SATA user password.

## Lockdown Mode (Available when the DCMS key is activated)

Select Enabled to support Lockdown Mode that will prevent existing data or keys stored in the system from being altered or changed in an effort to preserve system integrity and security. The options are **Disabled** and Enabled.

## ► Secure Boot



**Note:** For detailed instructions on how to configure Security Boot settings, refer to the Security Boot Configuration User's Guide posted on the web page under the link: <http://www.supermicro.com/support/manuals/>.

This section displays the contents of the following secure boot features:

- System Mode
- Secure Boot

## Secure Boot

Select Enabled to configure Secure Boot settings. The options are **Disabled** and Enabled.

## Secure Boot Mode

Use this feature to select the desired secure boot mode for the system. The options are Standard and **Custom**.

## CSM Support

If this feature is set to Enabled, legacy devices will be supported by the system. The options are Disabled and **Enabled**.

### ▶ Enter Audit Mode (Available when "Secure Boot Mode" is set to Custom)

Select Ok to enter the Audit Mode workflow. It will result in erasing of Platform Key (PK) variables and reset system to the Setup/Audit Mode.

### ▶ Key Management (Available when "Secure Boot Mode" is set to Custom)

The following information is displayed.

- Vendor Keys

### Provision Factory Defaults

Select Enabled to install provision factory default settings after the platform reset while the system is in the Setup Mode. The options are **Disabled** and Enabled.

### ▶ Restore Factory Keys

Select Yes to restore manufacturer default keys used to ensure system security. The options are **Yes** and No. Select Yes will reset system to the Deployed mode.

### ▶ Reset To Setup Mode (Available when any secure keys have been installed)

### ▶ Enroll Efi Image

This feature allows the image to run in the secure boot mode. Enroll SHA256 Hash certificate of a PE image into the Authorized Signature Database (DB).

### ▶ Export Secure Boot Variables (Available when any secure keys have been installed)

**Secure Boot variable / Size / Keys / Key Source**

### ▶ Platform Key (PK)

Use this feature to enter and configure a set of values to be used as platform firmware keys for the system. These values also indicate the sizes, keys numbers, and the sources of the authorized signatures. Select Update to update your "Platform Key." The options are Details, Export, Update, and Delete.

### ▶ **Key Exchange Key (KEK)**

Use this feature to enter and configure a set of values to be used as Key-Exchange-Keys for the system. These values also indicate the sizes, keys numbers, and the sources of the authorized signatures. Select Update to update your "Key Exchange Keys." Select Append to append your "Key Exchange Keys." The options are Details, Export, Update, Append, and Delete.

### ▶ **Authorized Signatures (db)**

Use this feature to enter and configure a set of values to be used as Authorized Signatures for the system. These values also indicate the sizes, keys numbers, and the sources of the authorized signatures. Select Update to update your "Authorized Signatures." Select Delete to delete the authorized signatures. The options are Details, Export, Update, Append, and Delete.

### ▶ **Forbidden Signatures (dbx)**

Use this feature to enter and configure a set of values to be used as Forbidden Signatures for the system. These values also indicate sizes, key numbers, and key sources of the forbidden signatures. Select Update to update your "Forbidden Signatures." Select Append to append your "Forbidden Signatures." The options are Details, Export, Update, Append, and Delete.

### ▶ **Authorized TimeStamps (dbt)**

This feature allows you to set and save the timestamps for the authorized signatures which will indicate the time when these signatures are entered into the system. These values also indicate sizes, keys, and key sources of the authorized timestamps. Select Update to update your "Authorized TimeStamps." Select Append to append your "Authorized TimeStamps." The options are Details, Export, Update, Append, and Delete.

### ▶ **OsRecovery Signature (dbr)**

This feature allows you to set and save the timestamps for the authorized signatures which will indicate the time when these signatures are entered into the system. These values also indicate sizes, keys, and key sources of the authorized timestamps. Select Update to update your "Authorized TimeStamps." Select Append to append your "Authorized TimeStamps." The options are Details, Export, Update, Append, and Delete.

## 4.7 Boot

Use this menu to configure Boot settings.

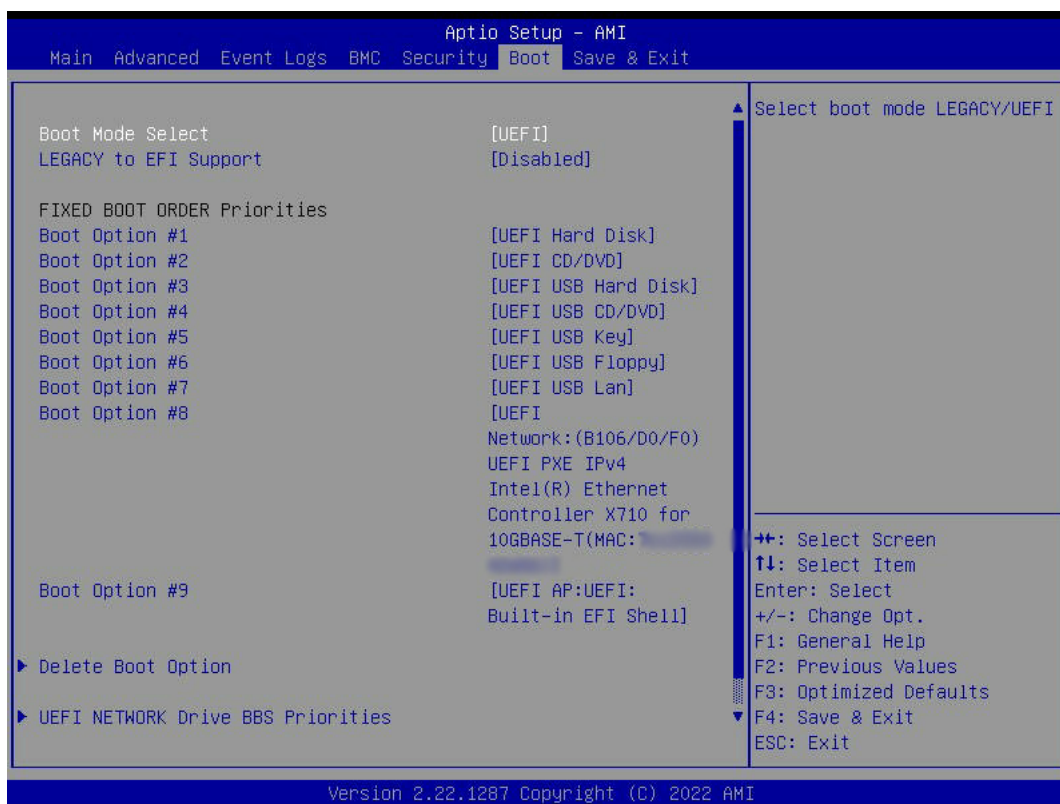

### Boot Mode Select

Use this feature to select the type of devices from which the system will boot. The options are Legacy, **UEFI**, and Dual.



**Note:** When "Boot Mode Select" is set to Dual, all OPRM-related features will be set to Legacy.

### Legacy to EFI Support

Select Enabled to boot EFI OS support after Legacy boot order has failed. The options are **Disabled** and Enabled.

### Fixed Boot Order Priorities

This feature prioritizes the order of a bootable device from which the system will boot. Press <Enter> on each item sequentially to select devices.

When "Boot Mode Select" is set to Legacy, the following features will be displayed for configuration:

- Boot Option #1–Boot Option #8

When "Boot Mode Select" is set to UEFI, the following features will be displayed for configuration:

- Boot Option #1–Boot Option #9

When "Boot Mode Select" is set to **Dual** (default), the following features will be displayed for configuration:

- Boot Option #1–Boot Option #17

### ▶ Delete Boot Option

This feature allows you to select a boot device to delete from the boot priority list.

#### **Delete Boot Option**

Use this feature to remove an EFI boot option from the boot order.

### ▶ UEFI NETWORK Drive BBS Priorities

This feature allows you to set the system boot order of detected devices.

### ▶ UEFI Application Boot Priorities

This feature allows you to set the system boot order of detected devices.

## 4.8 Save & Exit

Use this menu to save settings and exit from the BIOS.

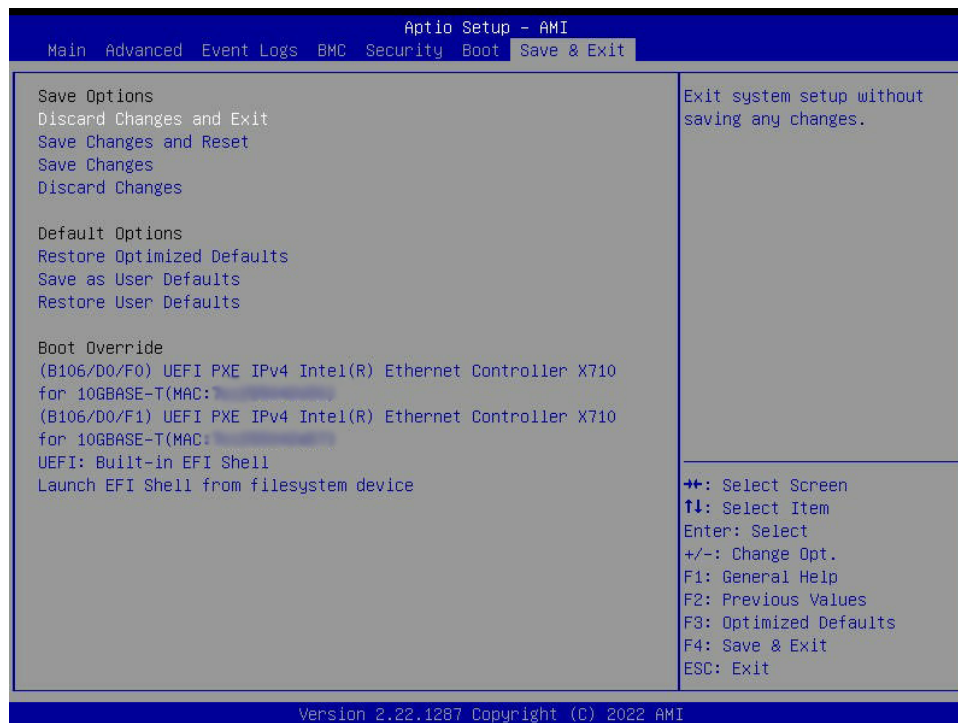

### Save Options

#### Discard Changes and Exit

Use this feature to exit from the BIOS Setup utility without making any permanent changes to the system configuration and reboot the computer.

#### Save Changes and Reset

When you have completed the system configuration changes, use this feature to leave the BIOS Setup utility and reboot the computer for the new system configuration parameters to become effective.

#### Save Changes

When you have completed the system configuration changes, use this feature to save all changes you've made. This will not reset (reboot) the system.

#### Discard Changes

Select this feature and press <Enter> to discard all the changes you've made and return to the BIOS Setup utility.

## **Default Options**

### **Restore Optimized Defaults**

Select this feature and press <Enter> to load manufacturer optimized default settings. The default settings are intended for maximum system performance but not for maximum stability.

### **Save As User Defaults**

Select this feature and press <Enter> to save all changes on the default values specified to the BIOS Setup utility for future use.

### **Restore User Defaults**

Select this feature and press <Enter>. Use this feature to retrieve user-defined default settings that have been saved previously.

### **Boot Override**

This feature allows you to override the Boot priorities sequence in the Boot menu, and immediately boot the system with a device specified instead of the one specified in the boot list. This is an one-time override.

**(B106/D0/F0) UEFI PXE IPv4 Intel(R) Ethernet Controller X710 for 10GBASE-T  
(MAC:xxxxxxxxxxxx)**

**(B106/D0/F1) UEFI PXE IPv4 Intel(R) Ethernet Controller X710 for 10GBASE-T (MAC:  
xxxxxxxxxxxx)**

**UEFI: Built-in EFI Shell**

**Launch EFI Shell from filesystem device**

## Appendix A

### Software

After the hardware has been installed, you can install the Operating System (OS), configure RAID settings and install the drivers.

#### A.1 Microsoft Windows OS Installation

If you will be using RAID, you must configure RAID settings before installing the Windows OS and the RAID driver. Refer to the RAID Configuration User Guides posted on our website at [www.supermicro.com/support/manuals](http://www.supermicro.com/support/manuals).

##### *Installing the OS*

1. Create a method to access the MS Windows installation ISO file. That can be a USB flash or media drive.
2. Retrieve the proper RST/RSTe driver. Go to the Supermicro web page for your motherboard and click on "Download the Latest Drivers and Utilities", select the proper driver, and copy it to a USB flash drive.
3. Boot from a bootable device with Windows OS installation. You can see a bootable device list by pressing <F11> during the system startup.

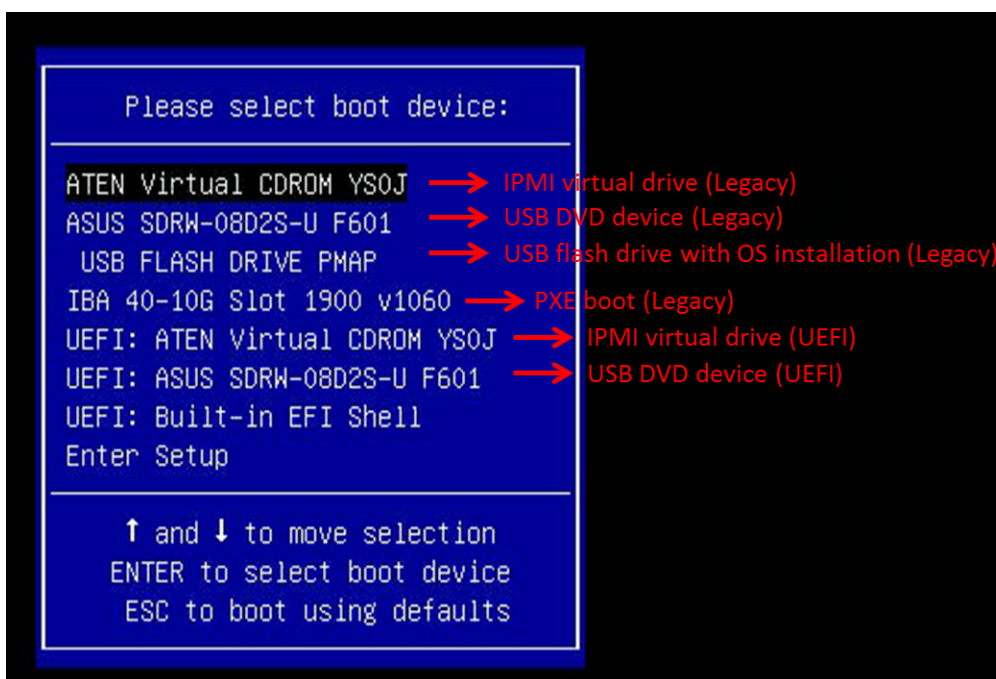
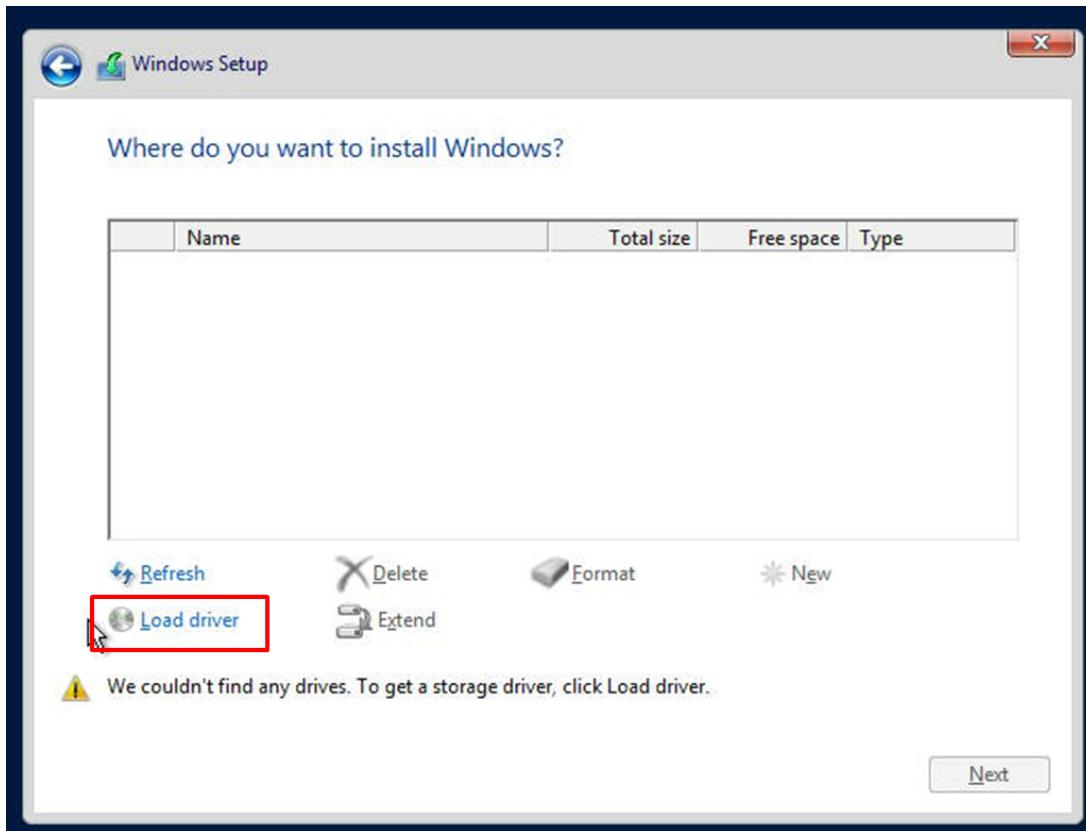

Figure A-1. Select Boot Device

4. During Windows Setup, continue to the dialog where you select the drives on which to install Windows. If the disk you want to use is not listed, click on “Load driver” link at the bottom left corner.



**Figure A-2. Load Driver Link**

To load the driver, browse the USB flash drive for the proper driver files.

- For RAID, choose the SATA/sSATA RAID driver indicated then choose the storage drive on which you want to install it.
  - For non-RAID, choose the SATA/sSATA AHCI driver indicated then choose the storage drive on which you want to install it.
5. Once all devices are specified, continue with the installation.
  6. After the Windows OS installation has completed, the system will automatically reboot multiple times.

## A.2 Driver Installation

The Supermicro website that contains drivers and utilities for your system is at <https://www.supermicro.com/wdl/driver/>. Some of these must be installed, such as the chipset driver.

After accessing the website, go into the CDR\_Images (in the parent directory of the above link) and locate the ISO file for your motherboard. Download this file to a USB flash drive or a DVD. (You may also use a utility to extract the ISO file if preferred.)

Another option is to go to the Supermicro website at <http://www.supermicro.com/products/>. Find the product page for your motherboard and download the latest drivers and utilities.

Insert the flash drive or disk and the screenshot shown below should appear.



**Figure A-3. Driver and Tool Installation Screen**

 **Note:** Click the icons showing a hand writing on paper to view the readme files for each item. Click the computer icons to the right of these items to install each item (from top to bottom) one at a time. **After installing each item, you must reboot the system before moving on to the next item on the list.** The bottom icon with a CD on it allows you to view the entire contents.

## A.3 IPMI

The 4th and 5th Generation Intel Xeon Processors support the Intelligent Platform Management Interface (IPMI). IPMI is used to provide remote access, monitoring and management. There are several BIOS settings that are related to IPMI.

Supermicro ships standard products with a unique password for the BMC ADMIN user. This password can be found on a label on the motherboard. For general documentation and information on IPMI, visit our website at [https://www.supermicro.com/en/support/BMC\\_Unique\\_Password](https://www.supermicro.com/en/support/BMC_Unique_Password).

## Appendix B

### Standardized Warning Statements

The following statements are industry standard warnings, provided to warn the user of situations which have the potential for bodily injury. Should you have questions or experience difficulty, contact Supermicro's Technical Support department for assistance. Only certified technicians should attempt to install or configure components.

Read this section in its entirety before installing or configuring components.

These warnings may also be found on our website at [http://www.supermicro.com/about/policies/safety\\_information.cfm](http://www.supermicro.com/about/policies/safety_information.cfm).

#### Battery Handling



**Warning!** There is the danger of explosion if the battery is replaced incorrectly. Replace the battery only with the same or equivalent type recommended by the manufacturer. Dispose of used batteries according to the manufacturer's instructions

#### 電池の取り扱い

電池交換が正しく行われなかった場合、破裂の危険性があります。交換する電池はメーカーが推奨する型、または同等のものを使用下さい。使用済電池は製造元の指示に従って処分して下さい。

#### 警告

電池更換不當會有爆炸危險。請只使用同類電池或制造商推薦的功能相當的電池更換原有電池。請按製造商的說明處理廢舊電池。

#### 警告

電池更換不當會有爆炸危險。請使用製造商建議之相同或功能相當的電池更換原有電池。請按照製造商的說明指示處理廢棄舊電池。

#### Warnung

Bei Einsetzen einer falschen Batterie besteht Explosionsgefahr. Ersetzen Sie die Batterie nur durch den gleichen oder vom Hersteller empfohlenen Batterietyp. Entsorgen Sie die benutzten Batterien nach den Anweisungen des Herstellers.

## Attention

Danger d'explosion si la pile n'est pas remplacée correctement. Ne la remplacer que par une pile de type semblable ou équivalent, recommandée par le fabricant. Jeter les piles usagées conformément aux instructions du fabricant.

## ¡Advertencia!

Existe peligro de explosión si la batería se reemplaza de manera incorrecta. Reemplazar la batería exclusivamente con el mismo tipo o el equivalente recomendado por el fabricante. Desechar las baterías gastadas según las instrucciones del fabricante.

אזהרה!

קיימת סכנת פיצוץ של הסוללה במידה והוחלפה בדרך לא תקינה. יש להחליף את הסוללה בסוג התואם מחברת יצרן מומלצת. סילוק הסוללות המשומשות יש לבצע לפי הוראות היצרן.

هناك خطر من انفجار في حالة اسبدال البطارية بطريقة غير صحيحة فعلياً  
اسبدال البطارية  
فقط بنفس النوع أو ما يعادلها مما أوصت به الشركة المصنعة  
جخلص من البطاريات المسحمة وفقاً لتعليمات الشركة الصانعة

## 경고!

배터리가 올바르게 교체되지 않으면 폭발의 위험이 있습니다. 기존 배터리와 동일하거나 제조사에서 권장하는 동등한 종류의 배터리로만 교체해야 합니다. 제조사의 안내에 따라 사용된 배터리를 처리하여 주십시오.

## Waarschuwing

Er is ontploffingsgevaar indien de batterij verkeerd vervangen wordt. Vervang de batterij slechts met hetzelfde of een equivalent type die door de fabrikant aanbevolen wordt. Gebruikte batterijen dienen overeenkomstig fabrieksvoorschriften afgevoerd te worden.

## Product Disposal



**Warning!** Ultimate disposal of this product should be handled according to all national laws and regulations.

### 製品の廃棄

この製品を廃棄処分する場合、国の関係する全ての法律・条例に従い処理する必要があります。

### 警告

本产品的废弃处理应根据所有国家的法律和规章进行。

### 警告

本產品的廢棄處理應根據所有國家的法律和規章進行。

### Warnung

Die Entsorgung dieses Produkts sollte gemäß allen Bestimmungen und Gesetzen des Landes erfolgen.

### ¡Advertencia!

Al deshacerse por completo de este producto debe seguir todas las leyes y reglamentos nacionales.

### Attention

La mise au rebut ou le recyclage de ce produit sont généralement soumis à des lois et/ou directives de respect de l'environnement. Renseignez-vous auprès de l'organisme compétent.

סילוק המוצר

אזהרה!

סילוק סופי של מוצר זה חייב להיות בהתאם להנחיות וחוקי המדינה.

عند التخلص النهائي من هذا المنتج ينبغي التعامل معه وفقا لجميع القوانين واللوائح الوطنية

### 경고!

이 제품은 해당 국가의 관련 법규 및 규정에 따라 폐기되어야 합니다.

### Waarschuwing

De uiteindelijke verwijdering van dit product dient te geschieden in overeenstemming met alle nationale wetten en reglementen.