



X13SCD-F

USER'S MANUAL

Revision 1.0b

The information in this user's manual has been carefully reviewed and is believed to be accurate. The manufacturer assumes no responsibility for any inaccuracies that may be contained in this document, and makes no commitment to update or to keep current the information in this manual, or to notify any person or organization of the updates. **Please Note: For the most up-to-date version of this manual, please see our website at www.supermicro.com.**

Super Micro Computer, Inc. ("Supermicro") reserves the right to make changes to the product described in this manual at any time and without notice. This product, including software and documentation, is the property of Supermicro and/or its licensors, and is supplied only under a license. Any use or reproduction of this product is not allowed, except as expressly permitted by the terms of said license.

IN NO EVENT WILL Super Micro Computer, Inc. BE LIABLE FOR DIRECT, INDIRECT, SPECIAL, INCIDENTAL, SPECULATIVE OR CONSEQUENTIAL DAMAGES ARISING FROM THE USE OR INABILITY TO USE THIS PRODUCT OR DOCUMENTATION, EVEN IF ADVISED OF THE POSSIBILITY OF SUCH DAMAGES. IN PARTICULAR, SUPER MICRO COMPUTER, INC. SHALL NOT HAVE LIABILITY FOR ANY HARDWARE, SOFTWARE, OR DATA STORED OR USED WITH THE PRODUCT, INCLUDING THE COSTS OF REPAIRING, REPLACING, INTEGRATING, INSTALLING OR RECOVERING SUCH HARDWARE, SOFTWARE, OR DATA.

Any disputes arising between manufacturer and customer shall be governed by the laws of Santa Clara County in the State of California, USA. The State of California, County of Santa Clara shall be the exclusive venue for the resolution of any such disputes. Supermicro's total liability for all claims will not exceed the price paid for the hardware product.

FCC Statement: This equipment has been tested and found to comply with the limits for a Class A digital device pursuant to Part 15 of the FCC Rules. These limits are designed to provide reasonable protection against harmful interference when the equipment is operated in a commercial environment. This equipment generates, uses, and can radiate radio frequency energy and, if not installed and used in accordance with the manufacturer's instruction manual, may cause harmful interference with radio communications. Operation of this equipment in a residential area is likely to cause harmful interference, in which case you will be required to correct the interference at your own expense.

California Best Management Practices Regulations for Perchlorate Materials: This Perchlorate warning applies only to products containing CR (Manganese Dioxide) Lithium coin cells. "Perchlorate Material-special handling may apply. See www.dtsc.ca.gov/hazardouswaste/perchlorate".



WARNING: This product can expose you to chemicals including lead, known to the State of California to cause cancer and birth defects or other reproductive harm. For more information, go to www.P65Warnings.ca.gov.

The products sold by Supermicro are not intended for and will not be used in life support systems, medical equipment, nuclear facilities or systems, aircraft, aircraft devices, aircraft/emergency communication devices or other critical systems whose failure to perform be reasonably expected to result in significant injury or loss of life or catastrophic property damage. Accordingly, Supermicro disclaims any and all liability, and should buyer use or sell such products for use in such ultra-hazardous applications, it does so entirely at its own risk. Furthermore, buyer agrees to fully indemnify, defend and hold Supermicro harmless for and against any and all claims, demands, actions, litigation, and proceedings of any kind arising out of or related to such ultra-hazardous use or sale.

Manual Revision 1.0b

Release Date: February 24, 2025

Unless you request and receive written permission from Super Micro Computer, Inc., you may not copy any part of this document. Information in this document is subject to change without notice. Other products and companies referred to herein are trademarks or registered trademarks of their respective companies or mark holders.

Copyright © 2025 by Super Micro Computer, Inc.
All rights reserved.

Printed in the United States of America

Preface

About This Manual

This manual is written for system integrators, IT technicians and knowledgeable end users. It provides information for the installation and use of the X13SCD-F motherboard.

About This Motherboard

The Supermicro X13SCD-F supports the Intel® Xeon® 6300-series/E-2400 Series processor and a TDP of up to 95 W in an LGA 1700 socket. The motherboard supports PCIe 4.0/5.0 slots, SAS ports, and M.2 NVMe. Built with the Intel C266 chipset, the X13SCD-F supports up to 128 GB of DDR5 ECC UDIMM memory in four slots. The X13SCD-F is optimized for high-performance, high-end computing platforms that address the needs of high-end computing platforms that address the needs of next generation applications. Please note that this motherboard is intended to be installed and serviced by professional technicians only. For processor/memory updates, please refer to our website at <http://www.supermicro.com/products/>.

Conventions Used in the Manual

Special attention should be given to the following symbols for proper installation and to prevent damage done to the components or injury to yourself:



Warning! Indicates important information given to prevent equipment/property damage or personal injury.



Warning! Indicates high voltage may be encountered while performing a procedure.



Important: Important information given to ensure proper system installation or to relay safety precautions.



Note: Additional Information given to differentiate various models or provides information for proper system setup.

Contacting Supermicro

Headquarters

Address: Super Micro Computer, Inc.
980 Rock Ave.
San Jose, CA 95131 U.S.A.

Tel: +1 (408) 503-8000

Fax: +1 (408) 503-8008

Email: Marketing@supermicro.com (General Information)
Sales-USA@supermicro.com (Sales Inquiries)
Government_Sales-USA@supermicro.com (Gov. Sales Inquiries)
Support@supermicro.com (Technical Support)
RMA@supermicro.com (RMA Support)
Webmaster@supermicro.com (Webmaster)

Website: www.supermicro.com

Europe

Address: Super Micro Computer B.V.
Het Sterrenbeeld 28, 5215 ML
's-Hertogenbosch, The Netherlands

Tel: +31 (0) 73-6400390

Fax: +31 (0) 73-6416525

Email: Sales_Europe@supermicro.com (General Information)
Support_Europe@supermicro.com (Technical Support)
RMA_Europe@supermicro.com (RMA Support)

Website: www.supermicro.nl

Asia-Pacific

Address: Super Micro Computer, Inc.
3F, No. 150, Jian 1st Rd.
Zhonghe Dist., New Taipei City 235
Taiwan (R.O.C)

Tel: +886-(2) 8226-3990w

Fax: +886-(2) 8226-3992

Email: Sales-Asia@supermicro.com.tw (Sales Inquiry)
Support@supermicro.com.tw (Technical Support)
RMA@supermicro.com.tw (RMA Support)

Website: www.supermicro.com.tw

Table of Contents

Chapter 1 Introduction

1.1 Checklist.....	8
Quick Reference	11
Quick Reference Table.....	12
Motherboard Features.....	13
1.2 Processor and Chipset Overview.....	16
1.3 Special Features	16
Recovery from AC Power Loss.....	16
1.4 System Health Monitoring.....	17
Onboard Voltage Monitors	17
Fan Status Monitor with Firmware Control	17
Environmental Temperature Control	17
System Resource Alert.....	17
1.5 ACPI Features.....	18
1.6 Power Supply	18

Chapter 2 Installation

2.1 Static-Sensitive Devices.....	19
Precautions	19
Unpacking	19
2.2 Processor and Heatsink Installation.....	20
Installing the LGA1700 Processor	20
Installing the CPU Heatsink	23
Removing the Heatsink.....	24
2.3 Motherboard Installation.....	25
Tools Needed	25
Location of Mounting Holes	25
Installing the Motherboard.....	26
Installing the Motherboard into the Chassis	27
2.4 Memory Support and Installation	28
Memory Support.....	28
DIMM Module Population Configuration	28

General Guidelines for Optimizing Memory Performance	29
DIMM Installation	30
DIMM Removal	30
2.5 Rear I/O Ports	31
2.6 Connectors	35
2.7 Jumper Settings	38
How Jumpers Work.....	38
2.8 LED Indicators.....	44
Chapter 3 Troubleshooting	
3.1 Troubleshooting Procedures	45
Before Power On	45
No Power	45
No Video	46
System Boot Failure.....	46
Memory Errors	46
Losing the System's Setup Configuration.....	47
When the System Becomes Unstable	47
3.2 Technical Support Procedures	49
3.3 Frequently Asked Questions	50
3.4 Battery Removal and Installation	51
Battery Removal.....	51
Proper Battery Disposal.....	51
Battery Installation.....	51
3.5 Returning Merchandise for Service.....	52
Chapter 4 UEFI BIOS	
4.1 Introduction.....	53
4.2 Main Setup	54
4.3 Advanced Setup Configurations.....	56
4.4 Event Logs	91
4.5 BMC	93
4.6 Security	97
4.7 Boot.....	102
4.8 Save & Exit	104

Appendix A BIOS Codes

A.1 BIOS Error POST (Beep) Codes	106
A.2 Additional BIOS POST Codes.....	107

Appendix B Software

B.1 Microsoft Windows OS Installation.....	108
B.2 Driver Installation.....	110
B.3 SuperDoctor® 5.....	111

Appendix C Standardized Warning Statements***Appendix D UEFI BIOS Recovery***

D.1 Overview.....	115
D.2 Recovering the UEFI BIOS Image.....	115
D.3 Recovering the BIOS Block with a USB Device.....	116

Chapter 1

Introduction

Congratulations on purchasing your computer motherboard from an industry leader. Supermicro motherboards are designed to provide you with the highest standards in quality and performance.

In addition to the motherboard, several important parts that are included in the retail box are listed below. If anything listed is damaged or missing, please contact your retailer.

1.1 Checklist

Main Parts List		
Description	Part Number	Quantity
Supermicro Motherboard	X13SCD-F	1
Quick Reference Guide	MNL-2621-QRG	1

Important Links

For your system to work properly, please follow the links below to download all necessary drivers/utilities and the user's manual for your server.

- Supermicro product manuals: <http://www.supermicro.com/support/manuals/>
- Product drivers and utilities: <https://www.supermicro.com/wdl/driver>
- Product safety info: http://www.supermicro.com/about/policies/safety_information.cfm
- A secure data deletion tool designed to fully erase all data from storage devices can be found at our website: https://www.supermicro.com/about/policies/disclaimer.cfm?url=/wdl/utility/Lot9_Secure_Data_Deletion_Utility/
- If you have any questions, please contact our support team at: support@supermicro.com

This manual may be periodically updated without notice. Please check the Supermicro website for possible updates to the manual revision level.

Figure 1-1. X13SCD-F Motherboard Image

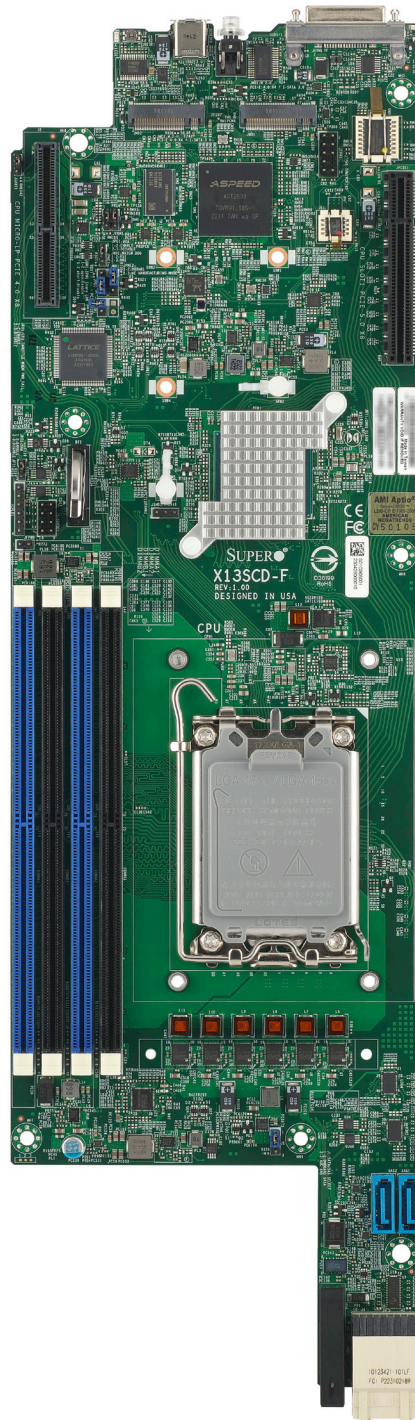

 **Note:** All graphics shown in this manual were based upon the latest PCB revision available at the time of publication of the manual. The motherboard you received may or may not look exactly the same as the graphics shown in this manual.

Figure 1-2. X13SCD-F Motherboard Layout

(not drawn to scale)

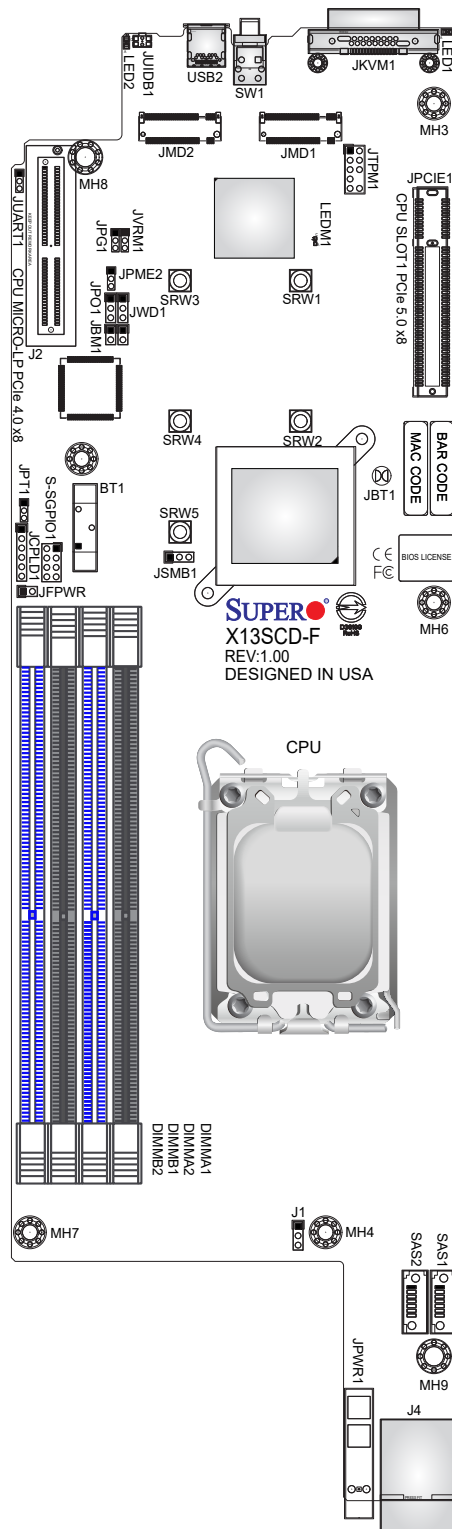

Note: Components not documented are for internal testing only.

Quick Reference

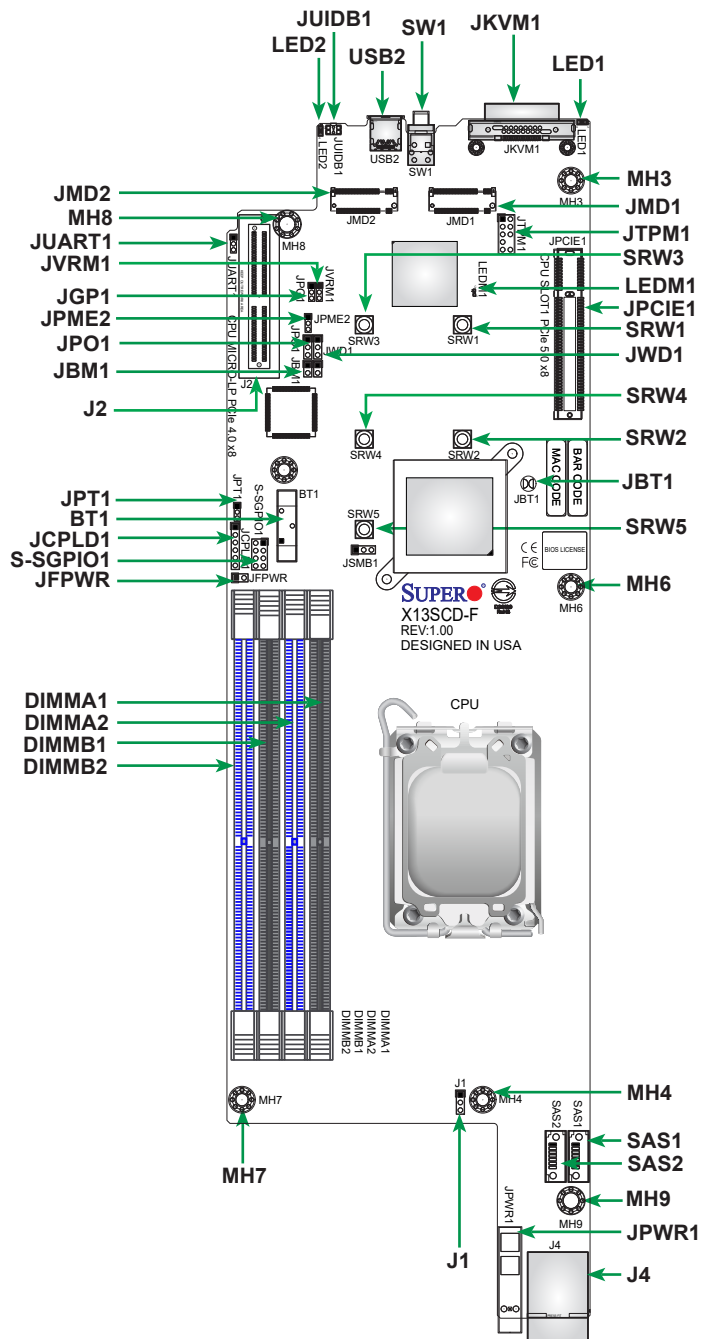
 Notes:

- See [Chapter 2](#) for detailed information on jumpers, I/O ports, and JF1 front panel connections. Jumpers/LED indicators not indicated are used for testing only.
- "■" indicates the location of Pin 1.
- Use only the correct type of onboard CMOS battery as specified by the manufacturer. Do not install the onboard battery upside down to avoid possible explosion.

Quick Reference Table

Jumper	Description	Default Setting
J1	SATA/SAS Select	Pins 1–2 (Onboard SATA) Pins 2–3 (AOC SAS)
JBM1	Disable IPMI Share LAN	Pins 1–1 (Enabled)
JBT1	CMOS Clear	Open (Normal)
JPG1	VGA Enable/Disable	Pins 1–2 (Enabled)
JPME2	ME Manufacturing Mode	Pins 1–2 (Normal)
JPO1	CPU Throttle When PWR_Fail	Pins 2–3 (Disabled)
JPT1	Onboard TPM Enable/Disable	Pins 1–2 (Enabled)
JWD1	Watchdog Timer	Pins 1–2 (Reset)
LED	Description	Status
LED1	Unit Identifier LED	Solid Blue: Unit Identified
LED2	OH/Power Fail/FAN LED	Blinking Red: Power Fail or FAN Fail Solid Red: Overheat
LEDM1	BMC Heartbeat LED	Blinking Green: BMC Normal
Connector	Description	
BT1	CMOS Battery	
J2	CPU MICRO-LP PCIe 4.0 x8 Slot	
J4	Backplane Connector	
JKVM1	KVM Connector (VGA/USB 2.0 x 2/COM port)	
JMD1	M.2-H PCIe 4.0 x4/I-SATA 3.0 (2242/2280 form factors)	
JMD2	M.2-H PCIe 4.0 x4/I-SATA 3.0 (2242/2280/22110 form factors)	
JPCIE1	CPU Slot 1 PCIe 5.0 x8 Slot	
JPWR1	Power Connector	
JTPM1	Trusted Platform Module/Port 80 Connector	
JUIDB1	UID Switch	
MH3–MH9	Mounting Holes	
SAS1, SAS2	SAS Ports	
S-SGPIO1	Serial Link General Purpose I/O Header	
SRW1–SRW5	M.2 Mounting Holes	
SW1	Power Button, Power LED	
USB2	USB 3.2 Type-C Port	



Note: Table is continued on the next page.

Motherboard Features

Motherboard Features	
CPU	<ul style="list-style-type: none"> Supports an Intel Xeon 6300-series/E-2400 Series processor with a TDP of up to 95 W in an LGA 1700 socket
Memory	<ul style="list-style-type: none"> Supports up to 128 GB of DDR5 ECC UDIMM memory with speeds of up to 4400 MT/s in four memory slots
DIMM Size	<ul style="list-style-type: none"> 8 GB, 12 GB, 16 GB, 24 GB, 32 GB <p> Note: For the latest CPU/memory updates, please refer to our website at http://www.supermicro.com/products/motherboard.</p>
Chipset	<ul style="list-style-type: none"> Intel C266
Expansion Slots	<ul style="list-style-type: none"> One MICRO-LP PCIe 4.0 x8 Slot One PCIe 5.0 x8 Slot (SLOT1) Two M.2 PCIe 4.0 x4/I-SATA 3.0 Slots (JMD1 supports 2242/2280 and JMD2 supports 2242/2280/22110)
Graphics	<ul style="list-style-type: none"> ASpeed AST2600. One VGA Port via the KVM Connector
I/O Devices	<ul style="list-style-type: none"> Two M.2 Ports (JMD1, JMD2) Two SATA 3.0 or two PCIe 4.0 x4 to the backplane One COM Port via the KVM Connector
Peripheral Devices	<ul style="list-style-type: none"> Two USB 2.0 ports on the rear I/O panel (USB0/1) via KVM connector
BIOS	<ul style="list-style-type: none"> 256 Mb AMI BIOS® SPI Flash BIOS ACPI 6.0, Plug and Play (PnP), SPI dual/quad speed support, and Real Time Clock (RTC) wake up



Note: The table above is continued on the next page.

Motherboard Features

Power Management

- ACPI power management
- Power button override mechanism
- Power-on mode for AC power recovery
- Power supply monitoring

System Health Monitoring

- Onboard voltage monitoring for +12 V, +5 V, +3.3 V, +5 V stdby, +3.3 V stdby, Vcore, CPU temperature, PCH temperature, system temperature, and memory temperature
- CPU thermal trip support
- Platform Environment Control Interface (PECI)/TSI

Fan Control

- Low-noise fan speed control

System Management

- Trusted Platform Module (TPM) support
- SuperDoctor® 5
- System resource alert via SuperDoctor® 5
- Platform Environment Control Interface (PECI) 3.0 support
- Watchdog, NMI
- Chassis intrusion header and detection
- Intel Active Management Technology (AMT)

LED Indicators

- BMC Heartbeat LED
- CPU/System Overheat LED
- Fan Fail LED
- LAN Activity LED
- Power indicator LED
- UID LED

Dimensions

- 4.75" (W) x 15.69" (L) (120.65 mm x 398.53 mm)



Note 1: The CPU maximum thermal design power (TDP) is subject to chassis and heatsink cooling restrictions. For proper thermal management, check the chassis and heatsink specifications for proper CPU TDP sizing.

Note 2: The BIOS 2.0 or above is required to support the Intel Xeon 6300-series processor.

Figure 1-3.
System Block Diagram

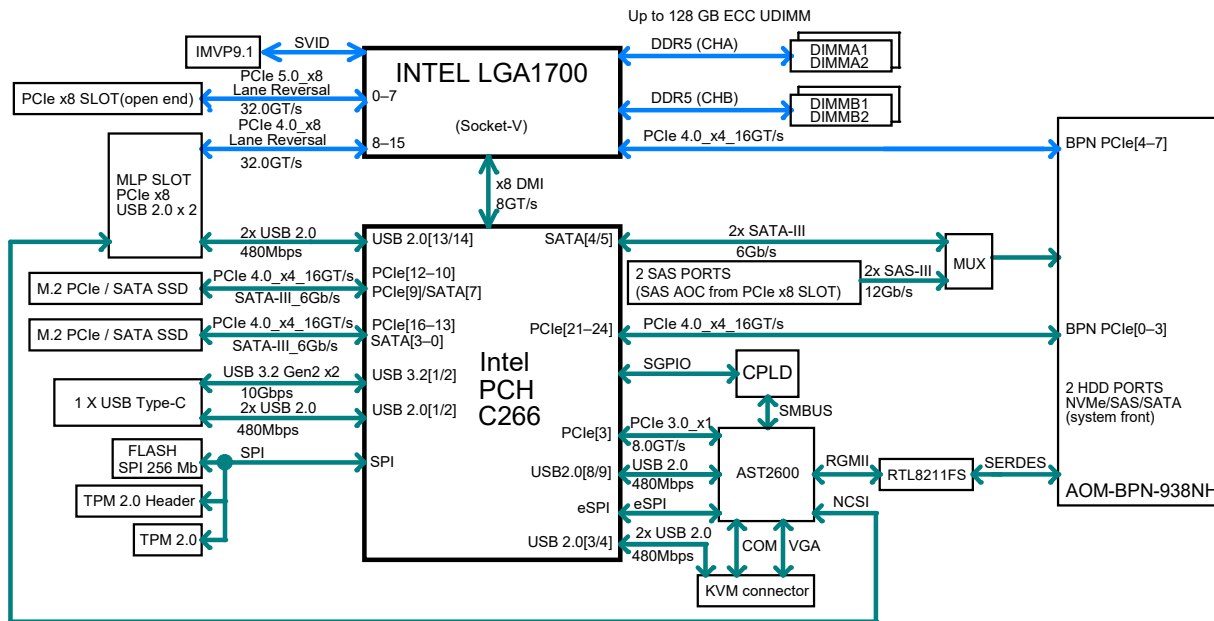

 **Note:** This is a general block diagram and may not exactly represent the features on your motherboard. See the previous pages for the actual specifications of your motherboard.

1.2 Processor and Chipset Overview

Built upon the functionality and capability of the 6300-series/E-2400 Series processor and the C266 chipset, the X13SCD-F motherboard provides system performance, power efficiency, and feature sets to address the needs of next-generation computer users.

With the support of the new Intel Microarchitecture 14 nm Process Technology, the X13SCD-F dramatically increases system performance for a multitude of applications.

The Intel CPU Xeon E-2400/6300-series and PCH C266 chipset support the following features:

- Intel TXT
- Intel Turbo Boost and Rapid Storage Technology
- Intel Boot Guard Technology
- Intel Hyper-Threading, Intel VT-d, and VT-x
- PCI Express 4.0/5.0, SATA 3.0, USB 3.2

1.3 Special Features

Recovery from AC Power Loss

The Basic I/O System (BIOS) provides a setting that determines how the system will respond when AC power is lost and then restored to the system. You can choose for the system to remain powered off (in which case you must press the power switch to turn it back on), or for it to automatically return to the power-on state. See the Advanced BIOS Setup section for this setting. The default setting is **Last State**.

1.4 System Health Monitoring

This section describes the health monitoring features of the motherboard. The motherboard has an onboard System Hardware Monitoring chip that supports system health monitoring.

Onboard Voltage Monitors

An onboard voltage monitor will scan the voltages of the onboard chipset, memory, CPU, and battery continuously. Once a voltage becomes unstable, a warning is given, or an error message is sent to the screen. The user can adjust the voltage thresholds to define the sensitivity of the voltage monitor.

Fan Status Monitor with Firmware Control

PC health monitoring in the BIOS can check the RPM status of the cooling fans. The onboard CPU and chassis fans are controlled by Thermal Management. Refer to the below table for available fan modes to choose the most appropriate one for nominal operation.

Environmental Temperature Control

The thermal control sensor monitors the CPU temperature in real time and will turn on the thermal control fan whenever the CPU temperature exceeds a user-defined threshold. The overheat circuitry runs independently from the CPU. Once the thermal sensor detects that the CPU temperature is too high, it will automatically turn on the thermal fans to prevent the CPU from overheating. The onboard chassis thermal circuitry can monitor the overall system temperature and alert the user when the chassis temperature is too high.



Note: To avoid possible system overheating, provide adequate airflow to your system.

System Resource Alert

This feature is available when used with SuperDoctor 5® in the Windows OS or in the Linux environment. SuperDoctor is used to notify the user of certain system events. For example, you can configure SuperDoctor to provide you with warnings when the system temperature, CPU temperatures, voltages, and fan speeds go beyond a predefined range.

Figure 1-4. Fan Speed Modes

Fan Mode	Description
Quiet	Use this mode to set fan speed for best power efficiency and maximum noise reduction
Stable	Use this mode to set the fan speed for normal system cooling
Full Speed	Use this mode to set fan speed at full speed for maximum system cooling
Customize	Use this mode to manually adjust the desired PWM according to the specified temperature

1.5 ACPI Features

The Advanced Configuration and Power Interface (ACPI) specification defines a flexible and abstract hardware interface that provides a standard way to integrate power management features throughout a computer system, including its hardware, operating system and application software. This enables the system to automatically turn on and off peripherals such as USB flash or media drives, network cards, hard disk drives and printers.

In addition to enabling operating system-directed power management, ACPI also provides a generic system event mechanism for Plug and Play, and an operating system-independent interface for configuration control. ACPI leverages the Plug and Play BIOS data structures, while providing a processor architecture-independent implementation that is compatible with appropriate Windows operating systems. For detailed information regarding OS support, refer to the Supermicro website.

1.6 Power Supply

As with all computer products, a stable power source is necessary for proper and reliable operation. It is even more important for processors that have high CPU clock rates. In areas where noisy power transmission is present, you may choose to install a line filter to shield the computer from noise. It is recommended that you also install a power surge protector to help avoid problems caused by power surges.

Chapter 2

Installation

2.1 Static-Sensitive Devices

Electrostatic Discharge (ESD) can damage electronic components. To avoid damaging your system board, it is important to handle it very carefully. The following measures are generally sufficient to protect your equipment from ESD.

Precautions

- Use a grounded wrist strap designed to prevent static discharge.
- Touch a grounded metal object before removing the board from the antistatic bag.
- Handle the motherboard by its edges only; do not touch its components, peripheral chips, memory modules or gold contacts.
- When handling chips or modules, avoid touching their pins.
- Put the motherboard and peripherals back into their antistatic bags when not in use.
- For grounding purposes, make sure that your computer chassis provides excellent conductivity between the power supply, the case, the mounting fasteners and the motherboard.
- Use only the correct type of onboard CMOS battery. Do not install the onboard battery upside down to avoid possible explosion.

Unpacking

The motherboard is shipped in antistatic packaging to avoid static damage. When unpacking the motherboard, make sure that the person handling it is static protected.

2.2 Processor and Heatsink Installation

Warning: When handling the processor package, avoid placing direct pressure on the label area of the fan.



Important:

- Use ESD protection.
- Unplug the AC power cord from all power supplies after shutting down the system.
- Check that the plastic protective cover is on the CPU socket and none of the socket pins are bent. If they are, contact your retailer.
- When handling the processor, avoid touching or placing direct pressure on the LGA lands (gold contacts). Improper installation or socket misalignment can cause serious damage to the processor or CPU socket, which may require manufacturer repairs.
- Thermal grease is pre-applied on a new heatsink. No additional thermal grease is needed.
- Refer to the Supermicro website for updates on processor support.
- All graphics in this manual are for illustrations only. Your components may look different.

Installing the LGA1700 Processor

1. Remove the plastic protective cover from the load plate.

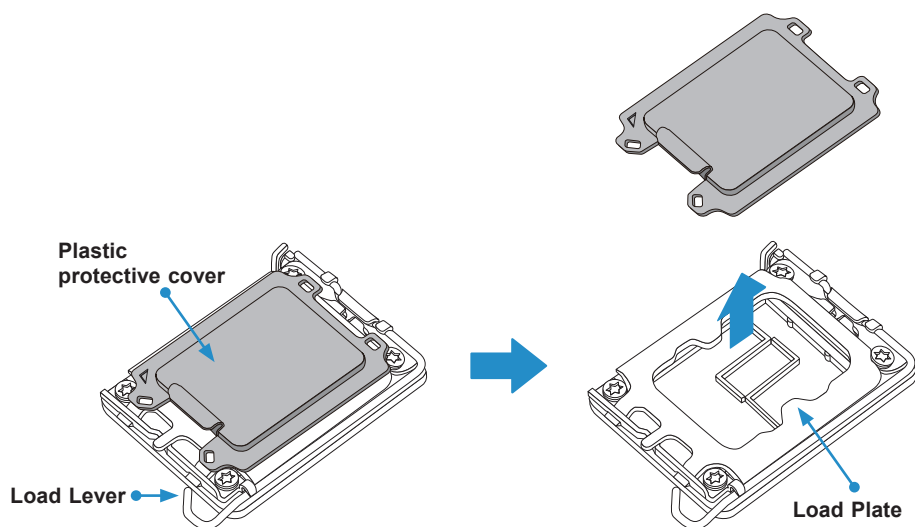

2. Gently push down the load lever to release and lift it, then lift the load plate to open it completely.

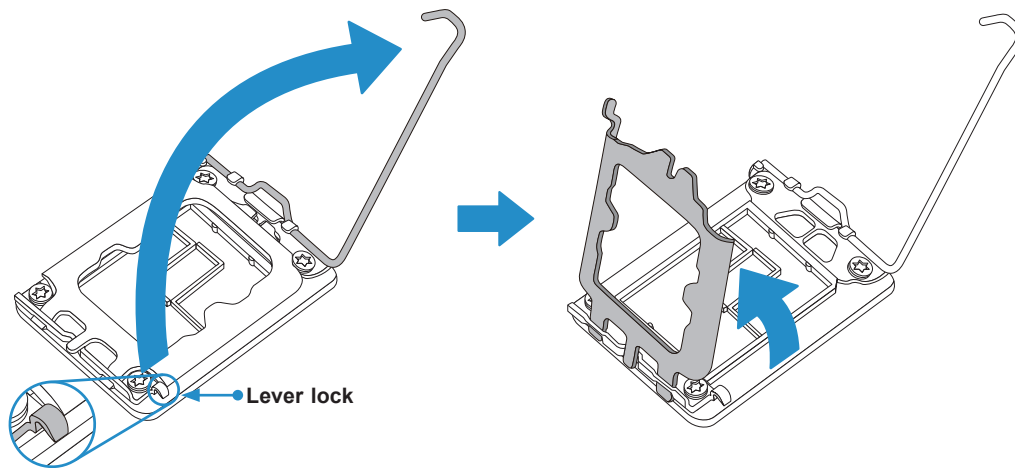

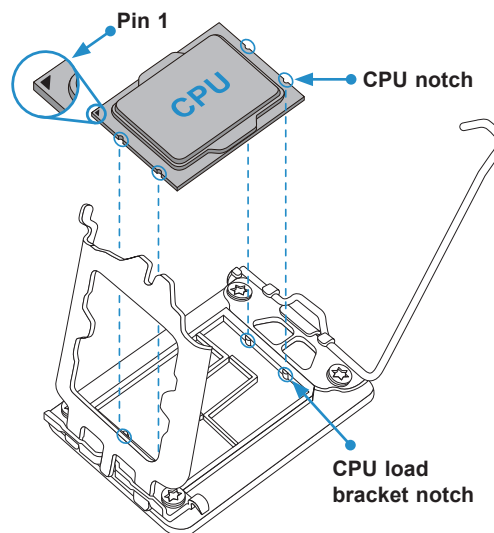

3. Use your thumb and your index finger to hold the CPU. Align the small triangle marker and notches on the CPU to the corresponding triangle marker and notches on the CPU load bracket. Once aligned, carefully lower the CPU straight down into the socket. Do not drop the CPU on the socket, or move it horizontally or vertically.

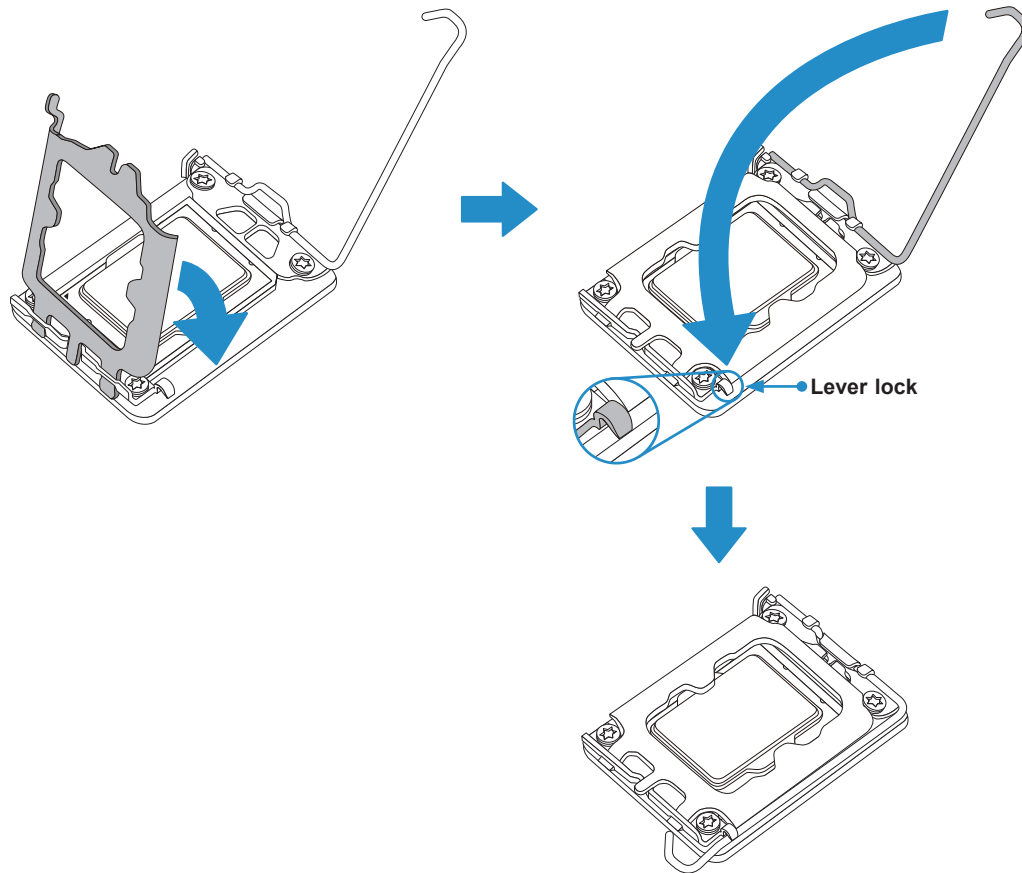

4. Do not rub the CPU against the surface or against any pins of the socket to avoid damaging the CPU or the socket.
5. With the CPU inside the socket, inspect the four corners of the CPU to make sure that the CPU is properly installed.

6. Close the load plate with the CPU inside the socket. Gently push the load lever down to the lever locks.



 **Important:** You can only install the CPU inside the socket in one direction. Make sure that it is properly inserted into the CPU socket before closing the load plate. If it doesn't close properly, do not force it as it may damage your CPU. Instead, open the load plate again and double-check that the CPU is aligned properly.

Installing the CPU Heatsink

1. Do not apply thermal grease to the heatsink or the CPU; the required amount has already been applied.
2. Align the four holes of the heatsink with the four mounting holes on the motherboard.
3. With a torque driver, gradually tighten screws #1, #2, then #3, #4 to ensure even pressure. The order of the screws is shown below. To avoid damaging the processor or socket, do not use a force greater than 12 lbf-in when tightening the screw.
4. Examine all corners to ensure the heatsink is firmly attached to the motherboard.

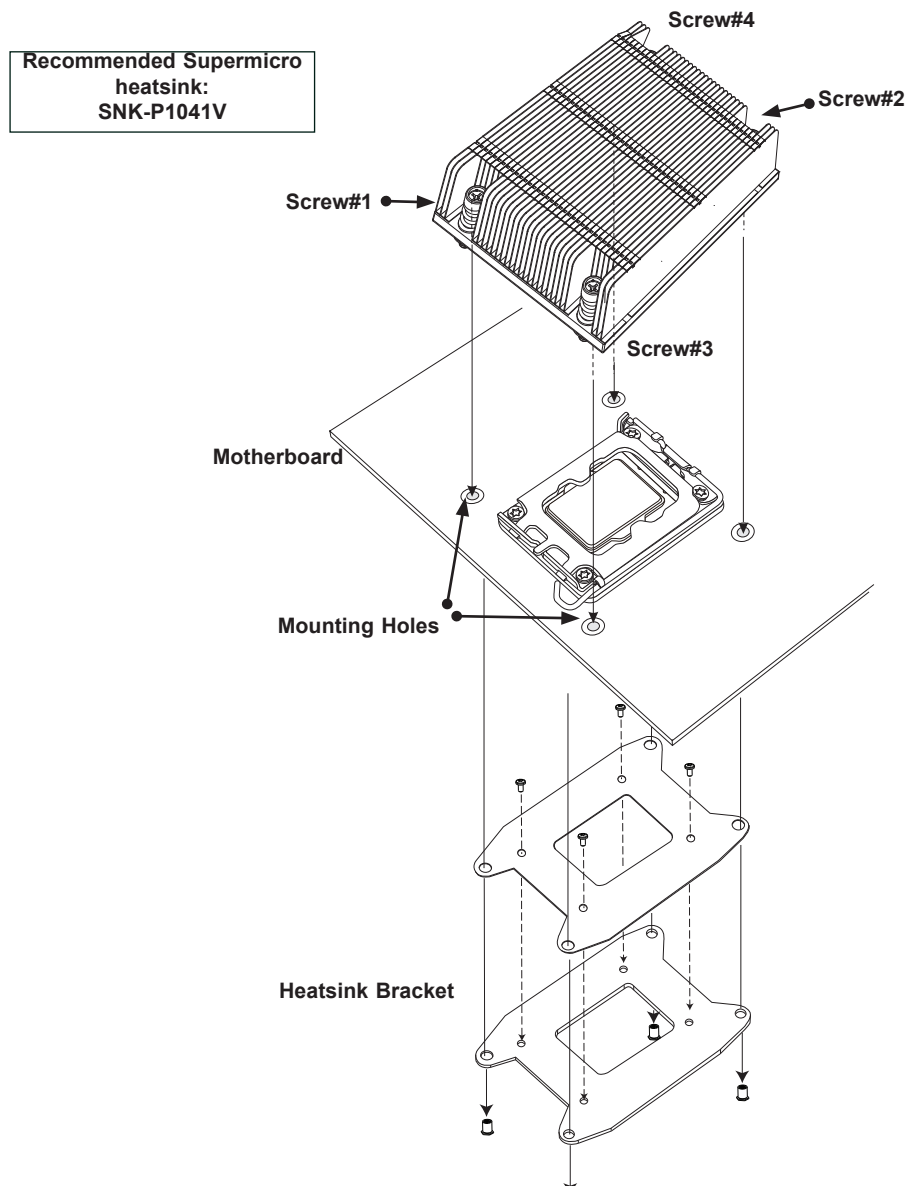

Removing the Heatsink

 **Note:** We do not recommend that the CPU or heatsink be removed. However, if you do need to remove the heatsink, please follow the instructions below to remove the heatsink and prevent damage done to the CPU or other components.

1. Unplug the power connector from the power supply.
2. Unscrew the heatsink screws in the sequence shown below.
3. Gently lift the heatsink up and remove it from the CPU.

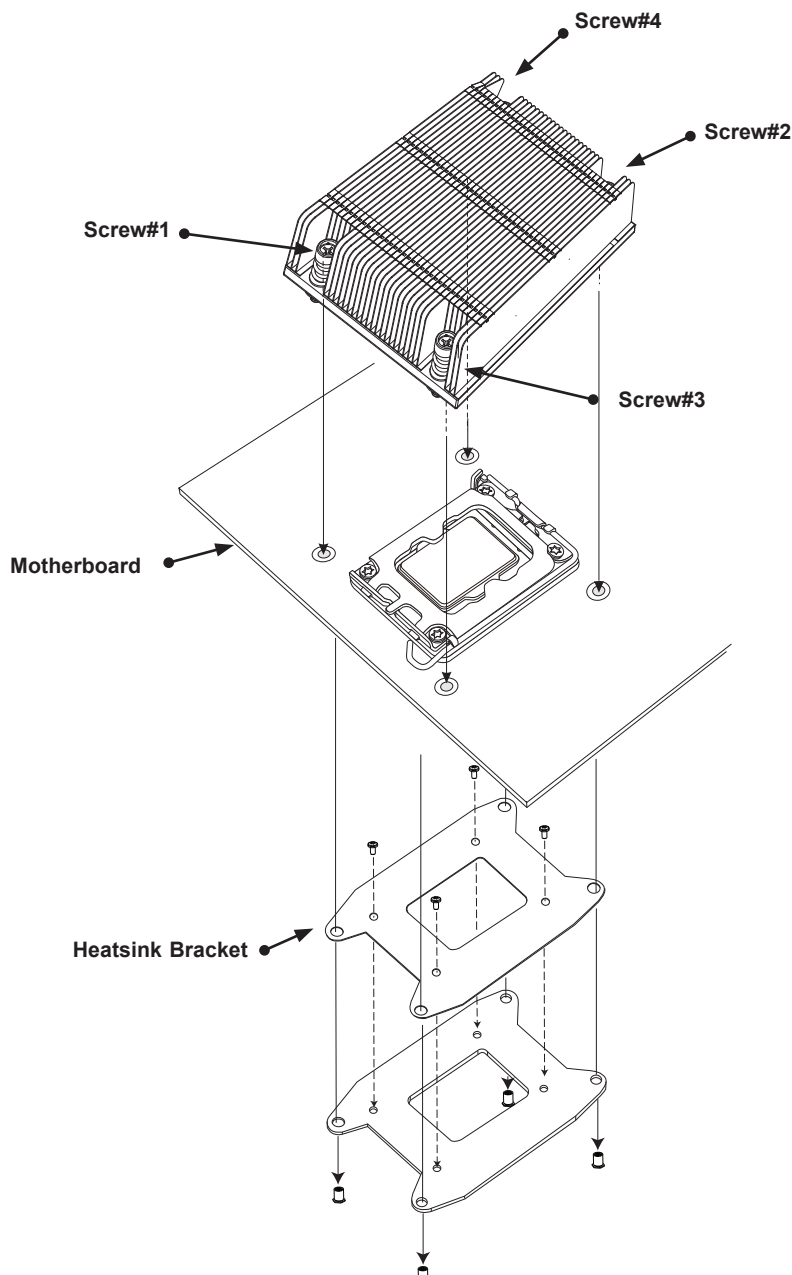



2.3 Motherboard Installation

All motherboards have standard mounting holes to fit different types of chassis. Make sure that the locations of all the mounting holes for both the motherboard and the chassis match. Although a chassis may have both plastic and metal mounting fasteners, metal ones are highly recommended because they ground the motherboard to the chassis. Make sure that the metal standoffs click in or are screwed in tightly.

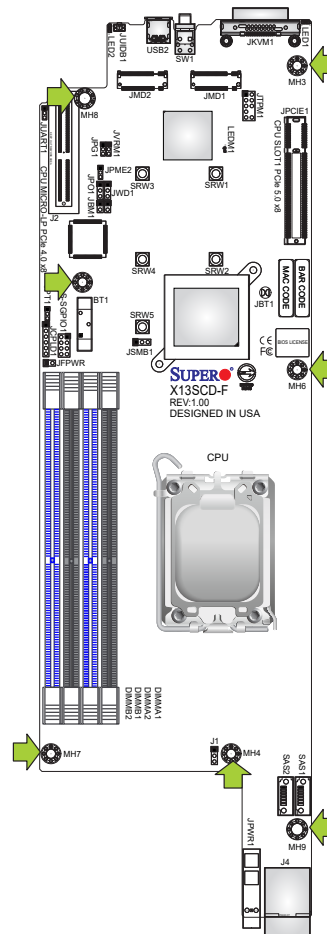
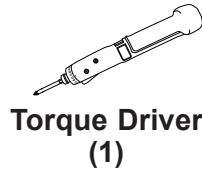
Tools Needed



Location of Mounting Holes

-  **Note 1:** Do not use a force greater than 8 in-lbf (0.904 N-m) on each mounting screw during motherboard installation. Exceeding this force may over-torque the screw, causing damage to the motherboard and screw.
-  **Note 2:** Some components are very close to the mounting holes. Please take precautionary measures to avoid damaging these components when installing the motherboard to the chassis.

Installing the Motherboard

1. Locate the mounting holes on the motherboard and the mounting tray. Refer to the previous page for the mounting holes.
2. Install the standoffs on the mounting tray. Align the mounting holes on the motherboard against the mounting holes on the tray.

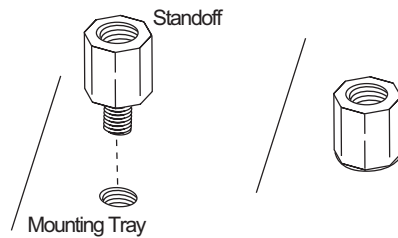

3. Using the Phillips screwdriver, insert a Phillips head #6 screw into a mounting hole on the motherboard and its matching hole on the tray.

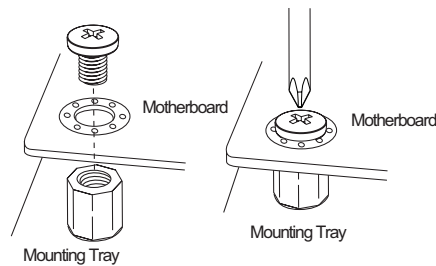

4. Repeat step 2 to insert #6 screws to all mounting holes located on the motherboard and tray and securely install the motherboard onto the tray.

Installing the Motherboard into the Chassis

1. When the motherboard is securely installed on the mounting tray, push the tray into the chassis.

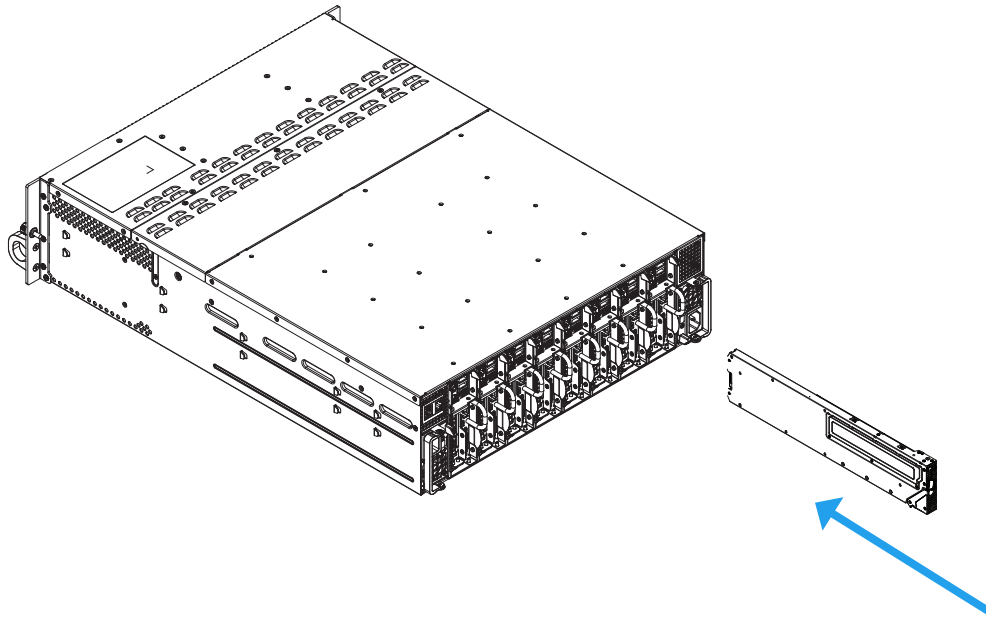

2. Once the mounting tray is pushed in the chassis, the connectors on the motherboard's edge will make contact with the chassis' backplane, which provides the connections to the chassis power, network and other I/O devices.

2.4 Memory Support and Installation



Note: Check the Supermicro website for recommended memory modules.



Important: Exercise extreme care when installing or removing DIMM modules to prevent any possible damage.

Memory Support

The X13SCD-F supports up to 128 GB of DDR5 ECC UDIMM memory with speeds of up to 4400 MT/s in four memory slots. Refer to the table below for the recommended DIMM population order and additional memory information.

DIMM Module Population Configuration

For optimal memory performance, follow the table below when populating memory.

Configuration	DIMMs	Channel A		Channel B		Status	Speed
		Slot 1	Slot 2	Slot 1	Slot 2		
1	1				1	Supported	4400 (2SPC - 1DIMM)
2	1			1		Not Supported	N/A
3	2			1	1	Supported	4000 (2SPC - 2DIMM 1R) 3600 (2SPC - 2DIMM 2R)
4	1		1			Supported - Best Performance	4400 (2SPC - 1DIMM)
5	2		1		1	Supported - Best Performance	4400 (2SPC - 1DIMM)
6	2		1	1		Not Supported	N/A
7	3		1	1	1	Supported	4000 (2SPC - 2DIMM 1R) 3600 (2SPC - 2DIMM 2R)
8	1	1				Not Supported	N/A
9	2	1			1	Not Supported	N/A
10	2	1		1		Not Supported	N/A
11	3	1		1	1	Not Supported	N/A
12	2	1	1			Supported	4000 (2SPC - 2DIMM 1R) 3600 (2SPC - 2DIMM 2R)
13	3	1	1		1	Supported	4000 (2SPC - 2DIMM 1R) 3600 (2SPC - 2DIMM 2R)
14	3	1	1	1		Not Supported	N/A
15	4	1	1	1	1	Supported - Best Performance	4000 (2SPC - 2DIMM 1R) 3600 (2SPC - 2DIMM 2R)

General Guidelines for Optimizing Memory Performance

- DIMM slots must be populated in the following order: DIMMA2, DIMMB2 and then DIMMA1, DIMMB1.
- It is recommended to use DDR5 memory of the same type, size, and speed.
- Mixed DIMM speeds can be installed. However, all DIMMs will run at the speed of the slowest DIMM.
- The motherboard will support odd-numbered amount of modules. However, to achieve the best memory performance, a balanced memory population is recommended.

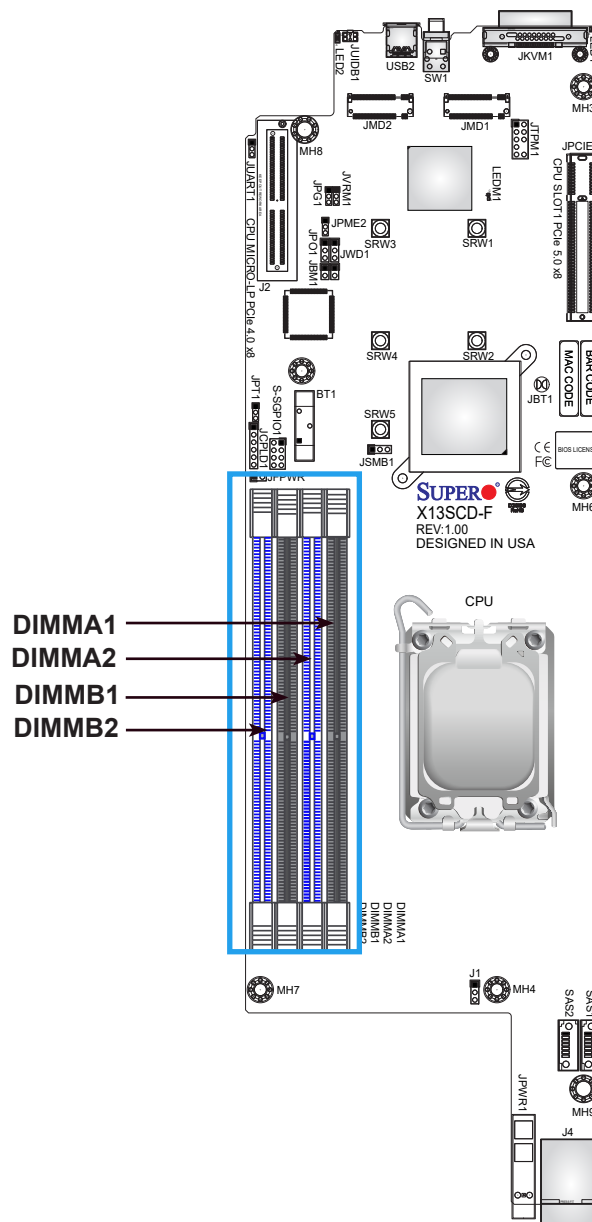

DIMM Installation

1. Insert DIMM modules in the following order: DIMMA2, DIMMB2 and then DIMMA1, DIMMB1.
2. Push the release tabs outwards on both ends of the DIMM slot to unlock it.
3. Align the key of the DIMM module with the receptive point on the memory slot.
4. Align the notches on both ends of the module against the receptive points on the ends of the slot.
5. Push both ends of the module straight down into the slot until the module snaps into place.
6. Press the release tabs to the lock positions to secure the DIMM module into the slot.

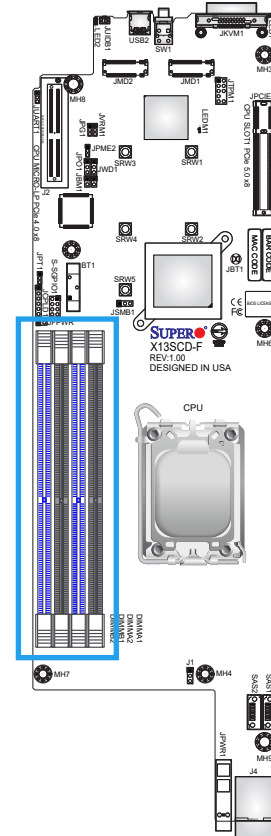

DIMM Removal

Press both release tabs on the ends of the DIMM module to unlock it. Once the DIMM module is loosened, remove it from the memory slot.

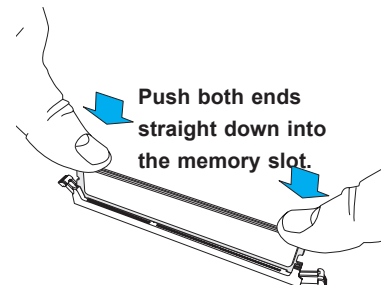
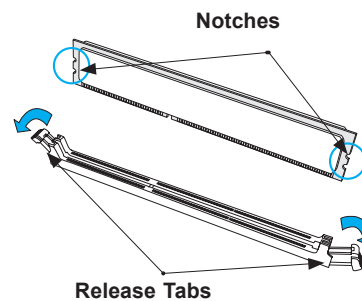
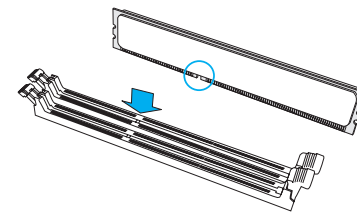

2.5 Rear I/O Ports

See Figure 2-1 below for the locations and descriptions of the various I/O ports on the rear of the motherboard.

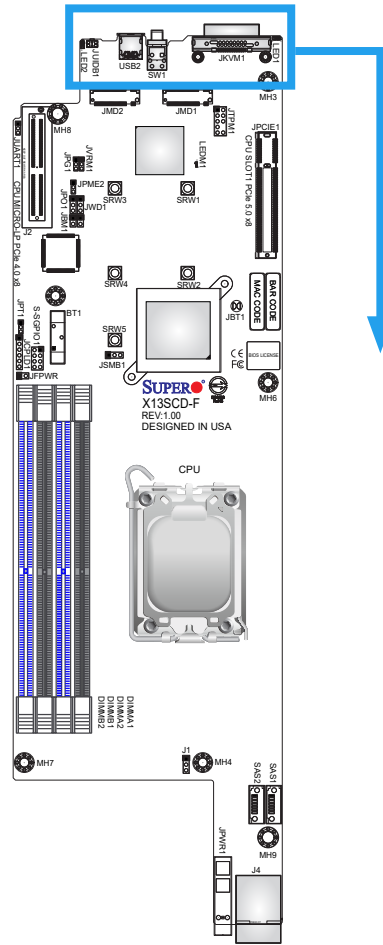

Figure 2-1. I/O Port Locations and Definitions



Rear I/O Ports			
#	Description	#	Description
1	KVM Connector	3	USB Type-C
2	Power Switch	4	UID Switch

KVM Connector

The JKVM1 connector is an acronym for Keyboard, Video, and Mouse. The connector supports a set of keyboard, monitor, and mouse to control multiple computers. It also provides VGA and COM connections.

Universal Serial Bus (USB) Ports

There is one USB 3.2 Type-C port (USB2).

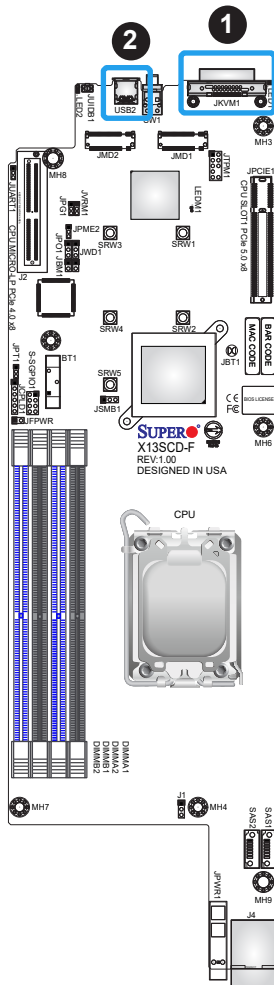

Back Panel USB 3.2 Pin Definitions			
Pin#	Definition	Pin#	Definition
A1	VBUS	B1	Power
A2	D-	B2	USB_N
A3	D+	B3	USB_P
A4	GND	B4	GND
A5	Stda_SSRX-	B5	USB3_RN
A6	Stda_SSRX+	B6	USB3_RP
A7	GND	B7	GND
A8	Stda_SSTX-	B8	USB3_TN
A9	Stda_SSTX+	B9	USB3_TP

1. KVM Connector
2. USB2

Unit Identifier Switch (JUIDB1): One button with two functions

A Unit Identifier (UID) switch and two LED Indicators are located on the motherboard. The UID switch is located next to the VGA port on the back panel.

Function	User Input	Behavior	LED Activity
UID LED Indicator	Push Once	Turns on the UID LED	UID LED turns solid blue
	Push Again	Turns off the UID LED	UID LED turns off
BMC Reset	Push and hold for 6 seconds	BMC will do a cold boot	BMC Hearbeat LED turns solid green
	Push and hold for 12 seconds	BMC will reset to factory default	BMC Hearbeat LED turns solid green

Note: After pushing and holding the UID switch for 12 seconds, all BMC settings including username and password will revert back to the factory default. Only the network settings and FRU are retained.

UID LED Pin Definitions	
Color	Status
Blue: On	Unit Identified

UID Switch Pin Definitions	
Pin#	Definition
1	Button In
2	Ground
G1	Ground
G2	Ground

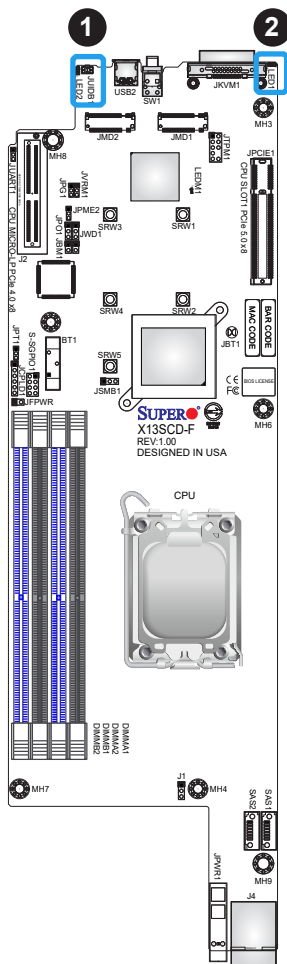

1. UID Switch
2. UID LED

Power Button

Press the button at SW1 to power on the motherboard. This button can also power off the motherboard instantly or in four seconds. The settings for this button can be configured with the Power Button Function feature in the BIOS.

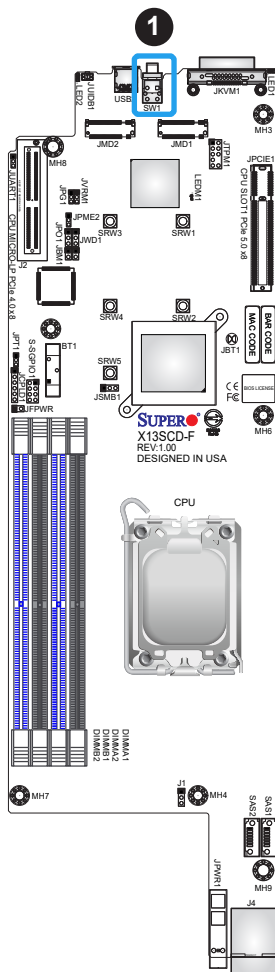

1. Power Button

2.6 Connectors

TPM Header

The JTPM1 header is used to connect a Trusted Platform Module (TPM)/Port 80, which is available from a third-party vendor. A TPM/Port 80 connector is a security device that supports encryption and authentication in hard drives. It allows the motherboard to deny access if the TPM associated with the hard drive is not installed in the system. Go to the following link for more information on the TPM: <http://www.supermicro.com/manuals/other/TPM.pdf>.

Trusted Platform Module Header Pin Definitions			
Pin#	Definition	Pin#	Definition
1	+3.3 V	2	SPI_CS#
3	RESET#	4	SPI_MISO
5	SPI_CLK	6	GND
7	SPI_MOSI	8	
9	+3.3 V Stby	10	SPI_IRQ#

1. TPM Header

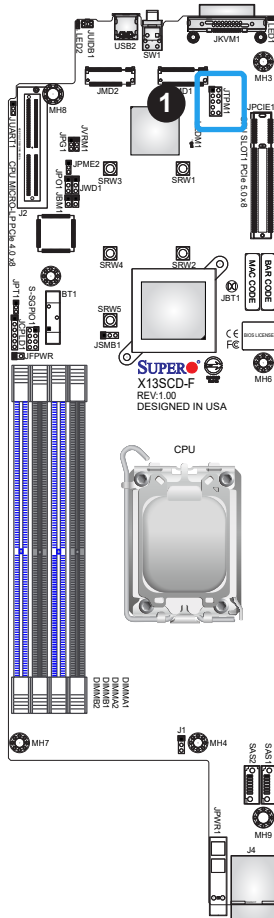

SGPIO Header

There is one Serial Link General Purpose Input/Output (S-SGPIO1) header on the motherboard. S-SGPIO is for sSATA use. Refer to the table below for pin definitions.

SGPIO Header Pin Definitions			
Pin#	Definition	Pin#	Definition
1	NC	2	NC
3	Ground	4	Data
5	Load	6	Ground
7	Clock	8	NC

NC = No Connection

SAS Ports

The X13SCD-F has two Serial Attached SCSI (SAS) ports. Set J1 to pins 1–2 to use these ports as onboard SATA or pins 2–3 as AOC SAS.

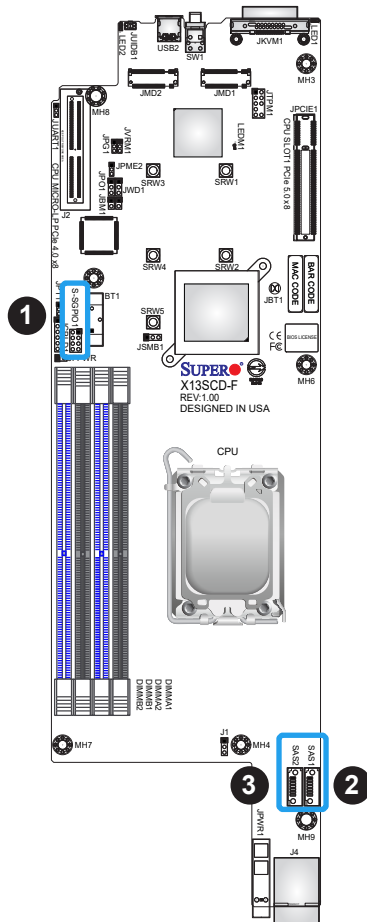

1. Serial Link General Purpose Header
2. SAS1
3. SAS2

M.2 Slots

The motherboard has two M.2 slots (JMD1, JMD2). M.2 allows for a variety of card sizes, increased functionality, and spatial efficiency. JMD1 supports SSD cards in the 2242/2280 form factors and JMD2 supports cards in the 2242/2280/22110 form factors.

Power Connector

JPWR1 is the power connector.

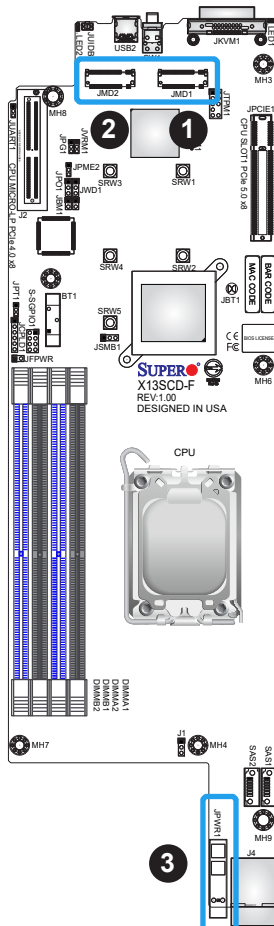

1. JMD1
2. JMD2
3. Power Connector

2.7 Jumper Settings

How Jumpers Work

To modify the operation of the motherboard, jumpers can be used to choose between optional settings. Jumpers create shorts between two pins to change the function of the connector. Pin 1 is identified with a square solder pad on the printed circuit board. See the diagram below for an example of jumping pins 1 and 2. Refer to the motherboard layout page for jumper locations.

 **Note:** On two-pin jumpers, "Closed" means the jumper is on and "Open" means the jumper is off the pins.

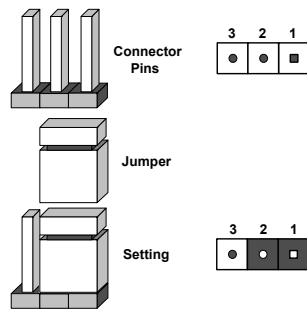

CMOS Clear

JBT1 is used to clear CMOS, which will also clear any passwords. Instead of pins, this jumper consists of contact pads to prevent accidentally clearing the contents of CMOS.

To Clear CMOS

1. First power down the system and unplug the power cord(s).
2. Remove the cover of the chassis to access the motherboard.
3. Remove the onboard battery from the motherboard.
4. Short the CMOS pads with a metal object such as a small screwdriver for at least four seconds.
5. Remove the screwdriver (or shorting device).
6. Replace the cover, reconnect the power cord(s), and power on the system.



Note: Clearing CMOS will also clear all passwords.

Do not use the PW_ON connector to clear CMOS.

1. CMOS Clear

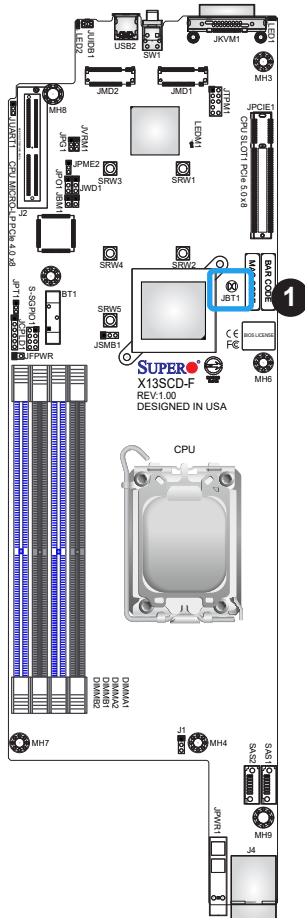

JBT1 contact pads

Watchdog Timer

Watchdog (JWD1) is a system monitor that can reboot the system when a software application hangs. Close pins 1–2 to reset the system if an application hangs. Close pins 2–3 to generate a non-maskable interrupt (NMI) signal for the application that hangs. Refer to the table below for jumper settings. The Watchdog must also be enabled in the BIOS.

Watchdog Timer Jumper Settings	
Jumper Setting	Definition
Pins 1–2	Reset (Default)
Pins 2–3	NMI
Open	Disabled

TPM Enable

Use JPT1 to enable or disable the onboard TPM 2.0. Refer to the table below for jumper settings.

TPM Enable/Disable Jumper Settings	
Jumper Setting	Definition
Pins 1–2	Enabled (Default)
Pins 2–3	Disabled

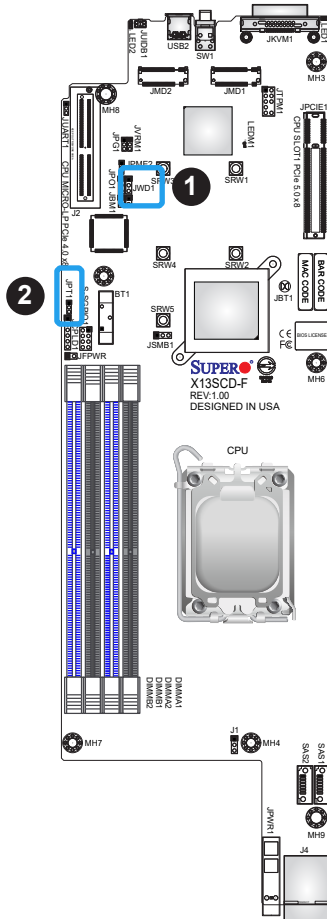

1. Watchdog Timer
2. TPM Enable

SATA/SAS Select

Set J1 to pins 1–2 to use these ports as onboard SATA or pins 2–3 as AOC SAS.

SATA/SAS Mode Select Jumper Settings	
Jumper Setting	Definition
Pins 1–2	Onboard SATA
Pins 2–3	AOC SAS

IPMI Share LAN Enable/Disable

Set the JBM1 jumper to enabled to share the LAN with IPMI.

IPMI Share LAN Enable/Disable Jumper Settings	
Jumper Setting	Definition
Pins 1–2 (Open)	Enabled (Default)
Pins 1–2 (Short)	Disabled

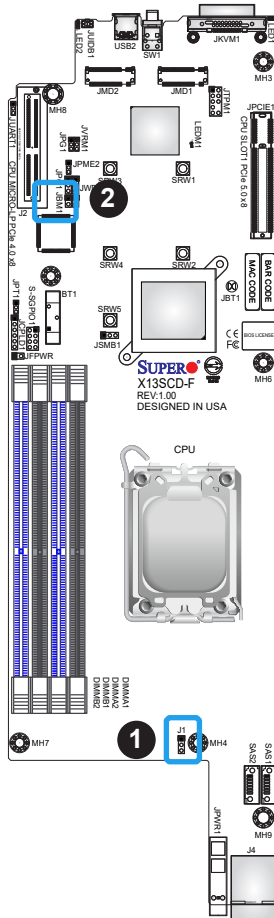

1. SATA/SAS Select
2. IPMI Share Enable/Disable

ME Manufacturing Mode

Close pins 2–3 of jumper JPME2 to bypass SPI flash security and force the system to operate in the manufacturing mode, which allows you to flash the system firmware from a host server for system setting modifications. Refer to the table below for jumper settings.

ME Manufacturing Mode Jumper Settings	
Jumper Setting	Definition
Pins 1–2	Normal (Default)
Pins 2–3	Manufacturing Mode

VGA Enable/Disable

Jumper JPG1 allows you to enable the onboard VGA connector. The default setting is pins 1–2 to enable the connection. Refer to the table below for jumper settings.

VGA Enable/Disable Jumper Settings	
Jumper Setting	Definition
Pins 1–2	Enabled (Default)
Pins 2–3	Disabled

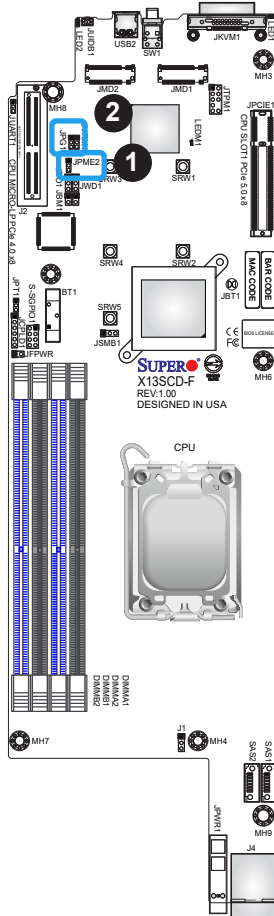

1. ME Manufacturing Mode
2. VGA Enable/Disable

CPU Throttle When PWR_Fail

The JPO1 jumper can enable the CPU Throttle mechanism to protect the CPU from damage due to excessive heat. This is a safeguard to prevent damage to the system. When an overheating condition occurs, thermal throttling kicks in. Three options are available to handle overheating: Power off, CPU Throttle - decrease CPU frequency to the minimum (800 Mhz), and Performance - do nothing.

CPU Throttle When PWR_Fail Jumper Settings	
Jumper Setting	Definition
Pins 1-2	Enabled
Pins 2-3	Disabled

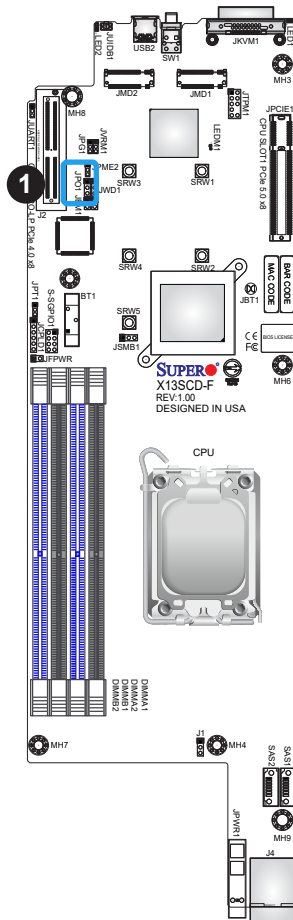

1. CPU Throttle

2.8 LED Indicators

OH/Power Fail/Fan Fail LED

LED2 is the Overheat, Power Fail, and Fan Fail LED. See the table below for the LED status.

OH/Power Fail/Fan Fail LED	
LED Color	Definition
Blinking Red	Power Fail or Fan Fail
Solid Red	Overheat

BMC Heartbeat LED

LEDM1 is the BMC Heartbeat LED. When the LED is blinking green, BMC is working. Refer to the table below for the LED status.

BMC Heartbeat LED	
LED Color	Definition
Blinking Green	BMC Normal

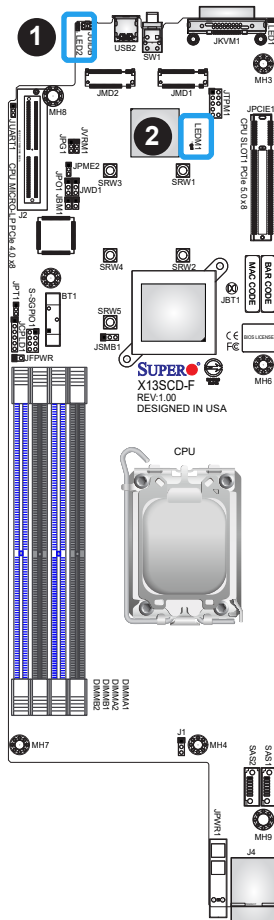

1. OH/Power Fail/Fan Fail LED
2. BMC Heartbeat LED

Chapter 3

Troubleshooting

3.1 Troubleshooting Procedures

Use the following procedures to troubleshoot your system. If you have followed all of the procedures below and still need assistance, refer to the 'Technical Support Procedures' and/or 'Returning Merchandise for Service' section(s) in this chapter. Always disconnect the AC power cord before adding, changing or installing any non hot-swap hardware components.

Before Power On

1. Make sure that there are no short circuits between the motherboard and chassis.
2. Disconnect all ribbon/wire cables from the motherboard, including those for the keyboard and mouse.
3. Remove all add-on cards.
4. Install the CPU (making sure it is fully seated) and connect the front panel connectors to the motherboard.

No Power

1. Make sure that there are no short circuits between the motherboard and the chassis.
2. Make sure that the ATX power connectors are properly connected.
3. Check that the 115 V/230 V switch, if available, on the power supply is properly set.
4. Turn the power switch on and off to test the system, if applicable.
5. The battery on your motherboard may be old. Check to verify that it still supplies approximately 3 VDC. If it does not, replace it with a new one.

No Video

1. If the power is on, but you have no video, remove all add-on cards and cables.
2. Use the speaker to determine if any beep codes are present. Refer to Appendix A for details on beep codes.
3. Remove all memory modules and turn on the system (if the alarm is on, check the specs of memory modules, reset the memory or try a different one).

System Boot Failure

If the system does not display Power-On-Self-Test (POST) or does not respond after the power is turned on, check the following:

1. Check for any error beep from the motherboard speaker.
 - If there is no error beep, try to turn on the system without DIMM modules installed. If there is still no error beep, replace the motherboard.
 - If there are error beeps, clear the CMOS settings by unplugging the power cord and contacting both pads on the CMOS clear jumper (JBT1). Refer to Section 2.8 in Chapter 2.
2. Remove all components from the motherboard, especially the DIMM modules. Make sure that system power is on and that memory error beeps are activated.
3. Turn on the system with only one DIMM module installed. If the system boots, check for bad DIMM modules or slots by following the Memory Errors Troubleshooting procedure in this chapter.

Memory Errors

When a no-memory beep code is issued by the system, check the following:

1. Make sure that the memory modules are compatible with the system and are properly installed. See Chapter 2 for installation instructions. (For memory compatibility, refer to the "Tested Memory List" link on the motherboard's product page to see a list of supported memory.)
2. Check if different speeds of DIMMs have been installed. It is strongly recommended that you use the same RAM type and speed for all DIMMs in the system.
3. Make sure that you are using the correct type of ECC DDR5 modules recommended by the manufacturer.
4. Check for bad DIMM modules or slots by swapping a single module among all memory slots and check the results.

Losing the System's Setup Configuration

1. Make sure that you are using a high-quality power supply. A poor-quality power supply may cause the system to lose the CMOS setup information. Refer to Chapter 2 for details on recommended power supplies.
2. The battery on your motherboard may be old. Check to verify that it still supplies approximately 3 VDC. If it does not, replace it with a new one.
3. If the above steps do not fix the setup configuration problem, contact your vendor for repairs.

When the System Becomes Unstable

A. If the system becomes unstable during or after OS installation, check the following:

1. CPU/BIOS support: Make sure that your CPU is supported and that you have the latest BIOS installed in your system.
2. Memory support: Make sure that the memory modules are supported by testing the modules using memtest86 or a similar utility.



Note: Click on the "Tested Memory List" link on the motherboard's product page to see a list of supported memory.

3. SDD support: Make sure that all solid state drives (SDDs) work properly. Replace the bad SDDs with good ones.
4. System cooling: Check the system cooling to make sure that all heatsink fans and CPU/system fans, etc., work properly. Also check the front panel Overheat LED and make sure that it is not on.
5. Adequate power supply: Make sure that the power supply provides adequate power to the system. Make sure that all power connectors are connected. Please refer to our website for more information on the minimum power requirements.
6. Proper software support: Make sure that the correct drivers are used.

B. If the system becomes unstable before or during OS installation, check the following:

1. Source of installation: Make sure that the devices used for installation are working properly, including boot devices such as USB flash or media drives.
2. Cable connection: Check to make sure that all cables are connected and working properly.

3. Use the minimum configuration for troubleshooting: Remove all unnecessary components (starting with add-on cards first), and use the minimum configuration (but with the CPU and a memory module installed) to identify the trouble areas. Refer to the steps listed in Section A above for proper troubleshooting procedures.
4. Identify bad components by isolating them: If necessary, remove a component in question from the chassis, and test it in isolation to make sure that it works properly. Replace a bad component with a good one.
5. Check and change one component at a time instead of changing several items at the same time. This will help isolate and identify the problem.
6. To find out if a component is good, swap this component with a new one to see if the system will work properly. If so, then the old component is bad. You can also install the component in question in another system. If the new system works, the component is good and the old system has problems.

3.2 Technical Support Procedures

Before contacting Technical Support, please take the following steps. Also, please note that as a motherboard manufacturer, Supermicro also sells motherboards through its channels, so it is best to first check with your distributor or reseller for troubleshooting services. They should know of any possible problems with the specific system configuration that was sold to you.

1. Please go through the Troubleshooting Procedures and Frequently Asked Questions (FAQ) sections in this chapter or see the FAQs on our website (<http://www.supermicro.com/FAQ/index.php>) before contacting Technical Support.
2. BIOS upgrades can be downloaded from our website (http://www.supermicro.com/ResourceApps/BIOS_IPMI_Intel.html).
3. If you still cannot resolve the problem, include the following information when contacting Supermicro for technical support:
 - Motherboard model and PCB revision number
 - BIOS release date/version (this can be seen on the initial display when your system first boots up).
 - System configuration
4. An example of a Technical Support form is on our website at <http://www.supermicro.com/RmaForm/>.
5. Distributors: For immediate assistance, please have your account number ready when placing a call to our Technical Support department. We can be reached by email at support@supermicro.com.

3.3 Frequently Asked Questions

Question: What type of memory does my motherboard support?

Answer: The motherboard supports 128 GB of DDR5 ECC UDIMM memory with speeds of up to 4800 MT/s in four memory slots. To enhance memory performance, do not mix memory modules of different speeds and sizes. Please follow all memory installation instructions given on Section 2.4 in Chapter 2.

Question: How do I update my BIOS?

Answer: It is recommended that you do not upgrade your BIOS if you are not experiencing any problems with your system. Updated BIOS files are located on our website at http://www.supermicro.com/ResourceApps/BIOS_IPMI_Intel.html. Please check our BIOS warning message and the information on how to update your BIOS on our website. Select your motherboard model and download the BIOS file to your computer. Also, check the current BIOS revision to make sure that it is newer than your BIOS before downloading. Please unzip the BIOS file onto a bootable USB device. Run the batch file using the format FLASH.BAT filename.rom from your bootable USB device to flash the BIOS. Then, your system will automatically reboot.

Warning: Do not shut down or reset the system while updating the BIOS to prevent possible system boot failure!



Note: The SPI BIOS chip used on this motherboard cannot be removed. Send your motherboard back to our RMA Department at Supermicro for repair. For BIOS Recovery instructions, please refer to the AMI BIOS Recovery Instructions posted at <http://www.supermicro.com/support/manuals/>.

3.4 Battery Removal and Installation

Battery Removal

To remove the onboard battery, follow the steps below:

1. Power off your system and unplug your power cable.
2. Locate the onboard battery as shown below.
3. Using a tool such as a pen or a small screwdriver, push the battery lock outwards to unlock it. Once unlocked, the battery will pop out from the holder.
4. Remove the battery.

Proper Battery Disposal

Please handle used batteries carefully. Do not damage the battery in any way; a damaged battery may release hazardous materials into the environment. Do not discard a used battery in the garbage or a public landfill. Please comply with the regulations set up by your local hazardous waste management agency to dispose of your used battery properly.

Battery Installation

1. To install an onboard battery, follow steps 1 and 2 above and continue below:
2. Identify the battery's polarity. The positive (+) side should be facing up.
3. Insert the battery into the battery holder and push it down until you hear a click to ensure that the battery is securely locked.

Warning: When replacing a battery, be sure to only replace it with the same type.

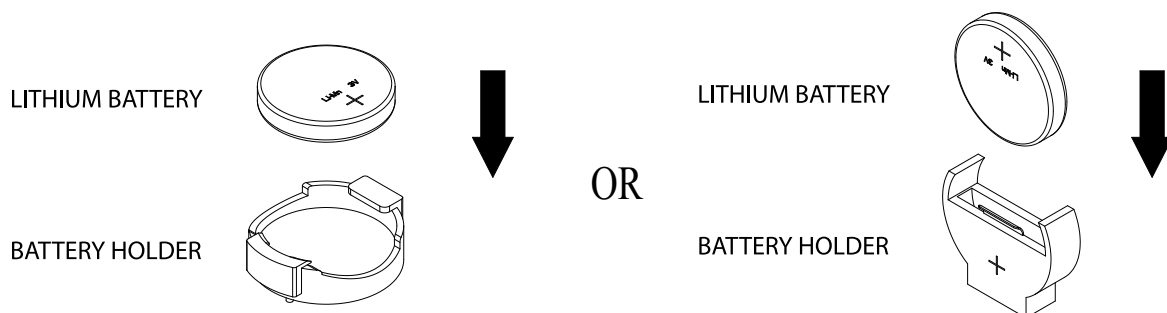

3.5 Returning Merchandise for Service

A receipt or copy of your invoice marked with the date of purchase is required before any warranty service will be rendered. You can obtain service by calling your vendor for a Returned Merchandise Authorization (RMA) number. When returning the motherboard to the manufacturer, the RMA number should be prominently displayed on the outside of the shipping carton, and the shipping package is mailed prepaid or hand-carried. Shipping and handling charges will be applied for all orders that must be mailed when service is complete. For faster service, you can also request a RMA authorization online (<http://www.supermicro.com/RmaForm/>).

This warranty only covers normal consumer use and does not cover damages incurred in shipping or from failure due to the alternation, misuse, abuse or improper maintenance of products.

During the warranty period, contact your distributor first for any product problems.

Chapter 4

UEFI BIOS

4.1 Introduction

This chapter describes the AMIBIOS™ Setup utility for the motherboard. The BIOS is stored on a chip and can be easily upgraded using a flash program.



Note: Due to periodic changes to the BIOS, some settings may have been added or deleted and might not yet be recorded in this manual. Refer to the Manual Download area of our website for any changes to BIOS that may not be reflected in this manual.

Starting the Setup Utility

To enter the BIOS Setup Utility, hit the Delete key while the system is booting-up. In most cases, the <Delete> key is used to invoke the BIOS setup screen. There are a few cases when other keys are used, such as <F1>, <F2>, etc. Each main BIOS menu option is described in this manual.

The Main BIOS screen has two main frames. The left frame displays all the options that can be configured. “Grayed-out” options cannot be configured. The right frame displays the key legend. Above the key legend is an area reserved for a text message. When an option is selected in the left frame, it is highlighted in white. Often a text message accompany it. (Note that BIOS has default text messages built in. We retain the option to include, omit, or change any of these text messages.) Settings printed in **Bold** are the default values.

A " ►" indicates a submenu. Highlighting such an item and pressing the <Enter> key open the list of settings within that submenu.

The BIOS setup utility uses a key-based navigation system called hot keys. Most of these hot keys (<F1>, <F10>, <Enter>, <ESC>, Arrow keys, etc.) can be used at any time during the setup navigation process.

4.2 Main Setup

When you first enter the AMI BIOS setup utility, you enter the Main setup screen. You can always return to the Main setup screen by selecting the Main tab on the top of the screen. The Main BIOS setup screen is shown below. The following Main menu items be displayed:

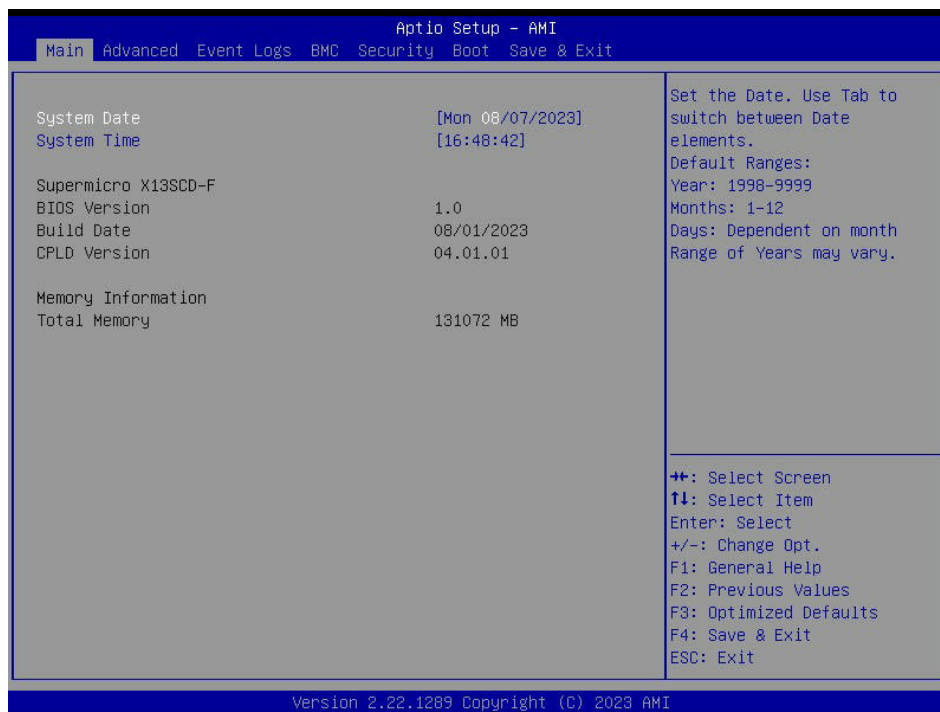

System Date/System Time

Use this option to change the system date and time. Highlight *System Date* or *System Time* using the arrow keys. Enter new values using the keyboard. Press the <Tab> key or the arrow keys to move between fields. The date must be entered in MM/DD/YYYY format. The time is entered in HH:MM:SS format.



Note: The time is in the 24-hour format. For example, 5:30 P.M. appears as 17:30:00.

Supermicro X13SCD-F

BIOS Version

This feature displays the version of the BIOS ROM used in the system.

Build Date

This feature displays the date when the version of the BIOS ROM used in the system was built.

CPLD Version

This feature displays the version of the CPLD.

Memory Information

Total Memory

This feature displays the total size of memory available in the system.

4.3 Advanced Setup Configurations

Use the arrow keys to select the Advanced submenu and press <Enter> to access the submenu items.

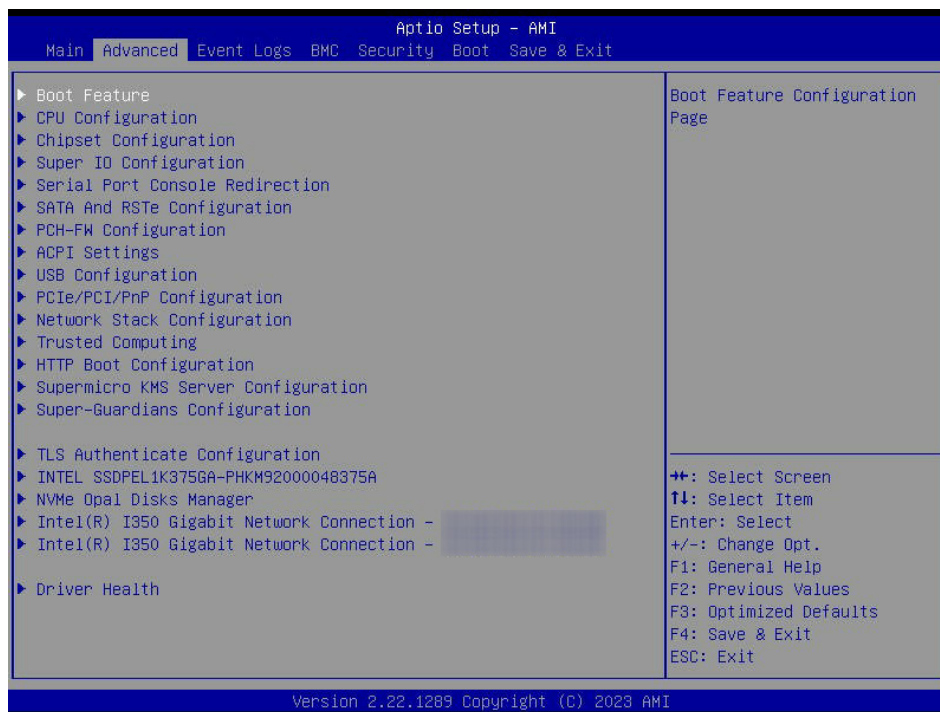

Warning: Take caution when changing the Advanced settings. An incorrect value, an improper DRAM frequency, or a wrong BIOS timing setting may cause the system to malfunction. When this occurs, revert the setting to the manufacture default settings.

► Boot Feature

Quiet Boot

Use this feature to select the screen display between the POST messages or the OEM logo upon bootup. Select Disabled to display the POST messages. Select Enabled to display the OEM logo instead of the normal POST messages. The options are Disabled and **Enabled**.

 **Note:** BIOS Power-on Self Test (POST) messages are always displayed regardless of the setting of this feature.

Option ROM Messages

Use this feature to set the display mode for the Option ROM. Select Keep Current to use the current AddOn ROM display settings. Select Force BIOS to use the Option ROM display mode set by the system BIOS. The options are **Force BIOS** and Keep Current.

Bootup NumLock State

Use this feature to set the Power-on state for the <Numlock> key. The options are **On** and Off.

Wait For "F1" If Error

Select Enabled to force the system to wait until the <F1> key is pressed if an error occurs. The options are Disabled and **Enabled**.

INT19 Trap Response

Interrupt 19 is the software interrupt that handles the boot disk function. When this feature is set to Immediate, the ROM BIOS of the host adaptors will "capture" Interrupt 19 at bootup immediately and allow the drives that are attached to these host adaptors to function as bootable disks. If this feature is set to Postponed, the ROM BIOS of the host adaptors will not capture Interrupt 19 immediately and allow the drive attached to these adaptors to function as bootable devices at boot up. The options are **Immediate** and Postponed.

Re-try Boot

If this feature is enabled, the BIOS will automatically reboot the system from a specified boot device after its initial boot failure. The options are **Disabled**, Legacy Boot, and EFI Boot.

Power Configuration**Watch Dog Function**

If this feature is enabled, the Watch Dog Timer will allow the system to reset or generate NMI based on the JWD1 jumper on the motherboard when it is inactive for more than five minutes. The options are **Disabled** and Enabled.

Rear USB Port(s) (Available when DCMS key is activated)

Select Enabled to allow the specific type of USB devices to be used in the rear USB ports. Select Enabled (Dynamic) to allow or disallow this particular type of USB device to be used in the rear USB ports without rebooting the system. The options are **Enabled**, Disabled, and Enabled (Dynamic).

Restore on AC Power Loss

Use this feature to set the power state after a power outage. Select Power Off for the system power to remain off after a power loss. Select Power On for the system power to be turned on after a power loss. Select Last State to allow the system to resume its last power state before a power loss. The options are Stay Off, Power On, and **Last State**.

Power Button Function

This feature controls how the system shuts down when the power button is pressed. Select 4 Seconds Override for you to power off the system after pressing and holding the power button for four seconds or longer. Select Instant Off to instantly power off the system as soon as you presses the power button. The options are **Instant Off** and 4 Seconds Override.

► CPU Configuration

The following CPU information is displayed:

- CPU Signature
- Brand String
- Microcode Revision
- L1 Data Cache
- L1 Instruction Cache
- L2 Cache
- L3 Cache
- SMX/TXT

C6DRAM

This feature enables moving DRAM contents to PRM memory when the CPU is in a C6 state. The options are Disabled and **Enabled**.

CPU Flex Ratio Override

Use this feature to set whether CPU Flex Ratio Override programming is Disabled or Enabled. The options are **Disabled** and Enabled.

CPU Flex Ratio Settings (Available when "CPU Flex Ratio Override" is set to "Enabled")

Use this feature to set the CPU Flex Ratio when CPU Flex Ratio Override is enabled. The value must be a value between the Max Efficient Ratio (LFM) and Maximum non-Turbo ratio set by the hardware (HFW). The default setting is dependent on the CPU.

Hardware Prefetcher

If this feature is set to Enabled, the hardware prefetcher will prefetch streams of data and instructions from the main memory into the L2 cache to improve CPU performance. The options are Disabled and **Enabled**.

Adjacent Cache Line Prefetch

If this feature is set to Disabled, the CPU will prefetch cache lines for 64 bytes. If set to Enabled, the CPU will prefetch cache lines for 128 bytes as comprised. The options are Disabled and **Enabled**.

Intel (VMX) Virtualization Technology

Select Enabled to use the Intel Virtualization Technology so that I/O device assignments will be reported to Virtual Memory Management (VMM) through the DMAR ACPI Tables. This feature offers fully-protected I/O resource sharing across Intel platforms, allowing for greater reliability, security, and availability in networking and data sharing. The options are Disabled and **Enabled**.

PECI

Use this feature to enable or disable Platform Environment Control Interface (PECI). Peci provides an interface between the processor and external components, such as Super IO and embedded controllers, to view and configure processor thermal management or power services. The options are Disabled and **Enabled**.

AVX

Use this feature to enable or disable Intel Advanced Vector Extensions (AVX) instructions. When AVX instructions are enabled, performance during demanding high performance computing (HPC) workloads may increase. This feature only affects performance cores. The options are **Enabled** and Disabled.

Active Processor Cores

This feature determines how many cores will be activated. When All is selected, all Performance-cores will be activated. The number of cores and E-cores are locked together. The default setting is **All**.

Hyper-Threading

Select Enabled to support Intel Hyper-Threading Technology to enhance CPU performance. The options are **Enabled** and Disabled.

BIST

Use this feature to enable the Built-In Self Test (BIST) at system reset or reboot. The options are **Disabled** and Enabled.

AP Threads Idle Manner

Use this feature to set the AP Threads Idle Manner setting. The options are HALT Loop, **MWAIT Loop**, and RUN Loop.

AES

Select Enabled to use the Intel Advanced Encryption Standard (AES) to ensure data security. The options are Disabled and **Enabled**.

Machine Check

Use this feature to enable or disable Machine Check. The options are Disabled and **Enabled**.

Monitor MWait

Select Enable to support Monitor and Mwait, which are two instructions in Streaming SIMD Extension 3 (SSE3) to improve synchronization between multiple threads for CPU performance enhancement. The options are Disabled and **Enabled**.

► Power & Performance

Boot Performance Mode

This feature allows you to select the performance state that the BIOS will set before handoff to the OS. The options are Power Saving, Max Non-Turbo Performance, and **Turbo Performance**.

Intel(R) SpeedStep(tm)

Intel SpeedStep Technology allows the system to automatically adjust processor voltage and core frequency to reduce power consumption and heat dissipation. The options are Disabled and **Enabled**.

Race to Halt (RTH)

Use this feature to enable or disable Race to Halt (RTH). RTH will dynamically increase CPU frequency to enter C-States more quickly to reduce overall power. The options are Disabled and **Enabled**.

Intel(R) Speed Shift Technology

When this feature is enabled, the Collaborative Processor Performance Control (CPPC) v2 interface will be available to control CPU P-States. The options are **Disabled**, Native Mode, and Out of Band Mode.

Per Core P State OS Control Mode

Use this feature to enable or disable Per Core P State OC Control Mode. Setting this feature to Disabled will set Bit 31 = 1 command 0x06. When this bit is set, the highest core request is used for all other core requests. The options are Disabled and **Enabled**.

HwP Autonomous Epp Grouping

Use this feature to enable or disable Hardware-Controlled Performance States (HwP) Autonomous Energy Performance Preference (EPP) Grouping. When this feature is set to enabled, the same value will be requested for all cores with the same EPP. When this feature is set to disabled, requests will not necessarily be the same value for all cores with the same EPP. The options are Disabled and **Enabled**.

HDC Control

Use this feature to enable or disable Hardware Duty Cycling (HDC). When this feature is enabled, HDC can be enabled during OS if OS support is available. The options are Disabled and **Enabled**.

Turbo Mode

Select Enabled for processor cores to run faster than the frequency specified by the manufacturer. The options are Disabled and **Enabled**.

Power Limit 1

Use this feature to enable or disable Platform Power Limit 1 (PsysPL1) programming. When this feature is set to Enabled, Power Limit 1 Power and Power Limit 1 Time Window can be configured. The options are **Disabled** and Enabled.

Power Limit 1 Power (Available when Power Limit 1 is enabled)

Use this feature to configure Package Power Limit 1 in milliwatts. The CPU will exceed this limit for as long as the value set in "Power Limit 1 Time Window" in seconds before returning to a power usage below this limit. For 12.50 W, enter 12500. The BIOS will round to the nearest 1/8 W. Enter 0 for no custom override. This value must be between Min Power Limit and the Max Power Limit defined by PACKAGE_POWER_SKU_MSR. The default setting is **0**.

Power Limit 1 Time Window (Available when Power Limit 1 is enabled)

Use this feature to set the Power Limit 1 Time Window value in seconds. This value defines how long Power Limit 1 may be exceeded. The CPU throttles to remain under Power Limit 1 when the duration set by Power Limit 1 Time Window is exceeded. Set this value to 0 to use the default value for this processor. The default setting is **0**.

Power Limit 2

Use this feature to enable or disable Platform Power Limit 2 (PsysPL2) programming. When this feature is set to Enabled, Power Limit 2 Power can be configured. The options are **Disabled** and Enabled.

Power Limit 2 Power

Use this feature to configure Package Power Limit 2 in milliwatts or milli-percents. For example, to set Power Limit 2 Power to 12%, enter 12000. The BIOS will round to the nearest 1/8 W or 1/8%. Enter 0 for no custom override. This setting will act as the new Power Limit 2 Power value for the Package running average power limit (RAPL) algorithm. The RAPL algorithm attempts to limit power spikes that go above this limit. When this value is set to 0, the Power Limit 2 Power will default to PACKAGE_POWER_SKU_MSR. The default setting is **0**.

Power Limit 3 Override

Use this feature to enable or disable Platform Power Limit 3 (PsysPL3) override. When this feature is set to Enabled, Power Limit 3, Power Limit 3 Time Window, Power Limit 3 Duty Cycle, and Power Limit 3 Lock can be configured. The options are **Disabled** and Enabled.

Power Limit 3 (Available when Power Limit 3 Override is enabled)

Use this feature to configure Package Power Limit 3 in milliwatts or milli-percents. For example, to set Power Limit 2 Power to 12%, enter 12000. The BIOS will round to the nearest 1/8 W or 1/8%. Enter 0 for no custom override. For XE SKUs, this value may be set up to Psys Pmax. For Overclocking SKUs, this value must be between Max and Min Power Limits defined by PACKAGE_POWER_SKU_MSR. For any other SKUs, this value must be between Min Power Limit and the Processor Base Power (TDP). If this value is 0, the default hardware value will be used. The default setting is **0**.

Power Limit 3 Time Window (Available when Power Limit 3 Override is enabled)

Use this feature to set the Power Limit 3 Time Window value in milliseconds. This value defines how long Power Limit 3 may be exceeded. The CPU throttles to remain under Power Limit 3 when the duration set by Power Limit 3 Time Window is exceeded. This value may be between 3 and 64. Set this feature to 0 to use the default value for this processor. The default setting is **0**. For ATX12V0 PSU systems, the recommended value is 40.

Power Limit 3 Duty Cycle (Available when Power Limit 3 Override is enabled)

Use this feature to set the duty cycle that the processor maintains during the Power Limit 3 Time Window. The value can be between 0 and 100. The default setting is **0**. For ATX12V0 PSU system, the recommended value is 25.

Power Limit 3 Lock (Available when Power Limit 3 Override is enabled)

Use this feature to enable or disable the ability to change Power Limit 3 configurations during OS. When this feature is disabled, Power Limit 3 configurations can be changed during OS. The default setting is **Disabled**.

Power Limit 4 Override

Use this feature to enable or disable Platform Power Limit 4 (PsysPL4) override. When this feature is set to Enabled, Power Limit 4 and Power Limit 4 Lock can be configured. The options are **Disabled** and Enabled.

Power Limit 4 (Available when Power Limit 4 Override is enabled)

Use this feature to configure Package Power Limit 4 in milliwatts or milli-percents. For example, to set Power Limit 4 Power to 12%, enter 12000. The BIOS will round to the nearest 1/8 W or 1/8%. Enter 0 for no custom override. The default value is **0**.

Power Limit 4 Lock (Available when Power Limit 4 Override is enabled)

Use this feature to enable or disable the ability to change Power Limit 4 configurations during OS. When this feature is disabled, Power Limit 4 configurations can be changed during OS. The default setting is **Disabled**.

C-States

Use this feature to enable CPU C-States. The options are Disabled and **Enabled**.

Enhanced C-States

Use this feature to enable enhanced C-States (C1E). When enabled, the CPU will switch to minimum speed if all cores are in C-State. The options are Disabled and **Enabled**.

C-State Auto Demotion

Use this feature to prevent unnecessary excursion into C-States. The options are Disabled and **C1**.

C-State Un-Demotion

Use feature to enable or disable un-demotion of C-States. The options are Disabled and **C1**.

Package C-State Demotion

Use this feature to enable or disable Package C-State Demotion. The options are Disabled and **Enabled**.

Package C-State Un-Demotion

Use this feature to enable or disable Package C-State Un-Demotion. The options are Disabled and **Enabled**.

C-State Pre-Wake

Use this feature to enable or disable C-State Pre-Wake. The options are Disabled and **Enabled**.

IO MWait Redirection

Use this feature to redirect IO_read instructions sent to IO register PMG_IO_BASE_ADDRBASE+offset to MWAIT(offset). The options are **Disabled** and **Enabled**.

Package C-State Limit

Use this feature to set the Package C-State limit. The options are C0/C1, C2, C3, C6, C7, C7S, C8, C9, C10, Cpu Default, and **Auto**.

Total Memory Encryption

Use this feature to enable or disable the Total Memory Encryption (TME) function for enhanced memory data security. TME protects DRAM data from physical attacks. The options are **Disabled** and **Enabled**.

► Chipset Configuration

Warning: Setting the wrong values in the following features may cause the system to malfunction.

► System Agent (SA) Configuration

System Agent (SA) Configuration

The following System Agent information will be displayed:

- VT-d

► Memory Configuration

Memory Configuration

The following memory information will be displayed:

- Memory RC Version
- Memory Frequency
- Memory Timings (tCL-tRCD-tRP-tRAS)
- DIMMA1
- DIMMA2
- DIMMB1
- DIMMB2

Memory Test on Warm Boot

Use this feature to enable or disable memory test on a warm boot. The options are Disabled and **Enabled**.

Maximum Memory Frequency

This feature selects the speed of the memory installed. The default setting is **Auto**. All values are in MT/s.

ECC Support

Use this feature to enable or disable DDR ECC support. The options are Disabled and **Enabled**.

Max TOLUD

This feature sets the Top of Low Usable DRAM (TOLUD) value. The TOLUD value specifies the memory space used by internal graphics devices, GTT Stolen Memory, and TSEG, respectively, if these devices are enabled. The options are **Dynamic**, 1 GB, 1.25 GB, 1.5 GB, 1.75 GB, 2 GB, 2.25 GB, 2.5 GB, 2.75 GB, 3 GB, 3.25 GB, and 3.5 GB.



Note: TSEG is a block of memory that is only accessible by the processor while operating in System Management Mode (SMM).

Retrain on Fast Fail

Use this feature to enable or disable restarting of the Memory Reference Code (MRC) in Cold mode if the memory test fails during fast flow. The options are Disabled and **Enabled**.

Row Hammer Mode

Use this feature to select which mitigation to use against Row Hammer. Row Hammer attacks attempt to trigger bit flips in DRAM chips by repeatedly hitting a row of memory cell until electrical leakage triggers a bit flip in a different row. Pseudo target row refresh (pTRR) automatically refreshes a victim row to mitigate Row Hammer attacks when a row activation threshold is exceeded. Refresh management (RFM) triggers additional row refresh commands when a memory controller detects too many row activations. RFM falls back to pTRR if RFM is unavailable. The options are Disabled, RFM, and **pTRR**.

RH LFSR0 Mask (Available when Row Hammer Mode is set to RFM or pTRR)

Use this feature to set the Row Hammer linear feedback shift register (LFSR) mask for the Row Hammer pTRR feature. The options are a number ranging from $1/2^1$ to $1/2^{15}$. The default setting is **$1/2^{11}$** .

RH LFSR1 Mask (Available when Row Hammer Mode is set to RFM or pTRR)

Use this feature to set the Row Hammer linear feedback shift register (LFSR) mask for the Row Hammer pTRR feature. The options are a number ranging from $1/2^1$ to $1/2^{15}$. The default setting is $1/2^{11}$.

Power Down Mode

Use this feature to set the Clock-Enable (CKE) power down mode. When this feature is set to No Power Down, CKE is disabled. When this feature is set to Active Power-down (APD), open pages are retained when de-asserting CKE. When this feature is set to Pre-charged Power-down (PPD) Delayed-locked Loop off (DLLoff), DDR enters a deep power-down state when all rows are pre-charged. PDD_DLLoff saves more power than No Power Down and APD. The options are **Auto**, No Power Down, APD, PPD-DLLoff.

Page Close Idle Timeout

Use this feature to set if memory controller should force open pages to close after an idle cycle threshold is exceeded. The options are Disabled and **Enabled**.

Memory Scrambler

Use this feature to enable or disable memory scrambler support for memory error correction. The options are Disabled and **Enabled**.

Force ColdReset

Use this feature when ColdBoot is required during MRC execution. The options are Enabled and **Disabled**.

Force Single Rank

Use this feature to force DIMMs to use a single rank. When enabled, only Rank0 will be use in each DIMM. The options are **Disabled** and Enabled.

MRC Fast Boot

This feature enables or disables fast path through the MRC. The options are Disabled and **Enabled**.

► PEG Port Configuration

CPU NVMe on BPN PCIe 4.0 x4

This feature indicates if M.2-C is present.

PCI Express Root Port 1

Use this feature to disable or enable the PCIe root port. The options are **Disabled** and **Enabled**.

ASPM

Use this feature to set the Active State Power Management level. The options are **Disabled**, **L0s**, **L1**, and **L0sL1**.

PCIe Speed

Use this feature to select the PCI Express port speed. The options are **Auto**, **Gen1**, **Gen2**, **Gen3**, and **Gen4**.

CPU MICRO-LP PCIe 4.0 x8

This feature indicates if RSC-W-68G5 PCIe 4.0 x8 is present.

PCI Express Root Port2

Use this feature to disable or enable the PCIe root port. The options are **Disabled** and **Enabled**.

ASPM

Use this feature to set the Active State Power Management level. The options are **Disabled**, **L0s**, **L1**, and **L0sL1**.

PCIe Speed

Use this feature to select the PCI Express port speed. The options are **Auto**, **Gen1**, **Gen2**, **Gen3**, and **Gen4**.

CPU SLOT1 PCIe 5.0 x8

This feature indicates if RSC-W-68G5 SLOT1 PCIe 5.0 x8 is present.

PCI Express Root Port3

Use this feature to disable or enable the PCIe root port. The options are **Disabled** and **Enabled**.

ASPM

Use this feature to set the Active State Power Management level. The options are **Disabled**, **L0s**, **L1**, and **L0sL1**.

PCIe Speed

Use this feature to select the PCI Express port speed. The options are **Auto**, Gen1, Gen2, Gen3, Gen4, and Gen5.

Stop Grant Configuration

Use this feature to configure the stop grant configuration. The options are **Auto** and Manual.

Number of Stop Grant Cycles (Available when Stop Grant Configuration is set to Manual)

Use this feature to set the number of stop-grant cycles. The default value is **1**.

VT-d

Select Enabled to enable Intel Virtualization Technology support for Direct I/O VT-d by reporting the I/O device assignments to VMM through the DMAR ACPI Tables. This feature offers fully-protected I/O resource-sharing across the Intel platforms, providing you with greater reliability, security and availability in networking and data sharing. The options are **Enabled** and Disabled.

Control IOMMU Pre-boot Behavior

Use this feature to enable the input-output memory management unit (IOMMU) in the pre-boot environment if the Direct-Memory Access Remapping (DMAR) table is installed in the driver execution environment (DXE) and if VTD_INFO_PPI is installed during pre-EFI initialization (PEI). The options are **Disable IOMMU** and Enable IOMMU during boot.

X2APIC Opt Out

Use this feature to enable or disable the X2APIC Opt Out Bit. The options are Enabled and **Disabled**.

DMA Control Guarantee

Use this feature to enable or disable Direct Memory Access (DMA) Control Guarantee. The options are **Enabled** and Disabled.

GNA Device (B0:D8:F0)

Use this feature to enable SA GNA device. The options are Enabled and **Disabled**.

▶ PCH-IO Configuration

▶ PCI Express Configuration

PCI Express Configuration

▶ PCI Express Root Port 1 – 24

ASPM 0 – 23

Use this feature to set the Active State Power Management (ASPM) level for the PCIe device. Select Auto for the system BIOS to automatically set the ASPM level based on the system configuration. Select Disabled to disable ASPM support. The options are Disabled, L1, and **Auto**.

L1 Substates

Use this feature to configure the PCI Express L1 Substates. The options are Disabled, L1.1, and **L1.1 & L1.2**.

PCIe Speed

Use this feature to select the PCI Express port speed. The options are **Auto**, Gen1, Gen2, Gen3, and Gen4.

Port 61h Bit-4 Emulation

Use this feature to set the emulation of Port 61h bit-4 toggling in System Management Mode (SMM). The options are Enabled and **Disabled**.

▶ Super IO Configuration

Super IO Configuration

- Super IO Chip - AST2600

▶ Serial Port 1 Configuration

Serial Port 1 Configuration

Serial Port 1

This feature will enable or disable the serial port. The options are Disabled or **Enabled**.

Device Settings - IO=3F8h; IRQ=4;

Change Settings

This feature configures the IRQ setting for the serial port. The options are **Auto**, IO=3F8h; IRQ=4;, IO=3F8h; IRQ=3,4,5,6,7,8,9,10,11,12;, IO=2F8h; IRQ=3,4,5,6,7,8,9,10,11,12, IO=3E8h; IRQ=3,4,5,6,7,8,9,10,11,12;, and IO=2E8h; IRQ=3,4,5,6,7,8,9,10,11,12;.

► Serial Port 2 Configuration

Serial Port 2 Configuration

Serial Port 2

This feature will enable or disable the serial port. The options are Disabled or **Enabled**.

Device Settings - IO=2F8h; IRQ=3;

Change Settings

This feature configures the IRQ setting for the serial port. The options are **Auto**, IO=2F8h; IRQ=3;, IO=3F8h; IRQ=3,4,5,6,7,8,9,10,11,12;, IO=2F8h; IRQ=3,4,5,6,7,8,9,10,11,12, IO=3E8h; IRQ=3,4,5,6,7,8,9,10,11,12;, and IO=2E8h; IRQ=3,4,5,6,7,8,9,10,11,12;.

► Serial Port Console Redirection

COM1

Console Redirection

Use this feature to enable the console redirection support for a serial port specified by you. The options are **Disabled** and Enabled.

Terminal Type

Use this feature to select the target terminal emulation type for Console Redirection. Select VT100 to use the ASCII Character set. Select VT100+ to add color and function key support. Select ANSI to use the Extended ASCII Character Set. Select VT-UTF8 to use UTF8 encoding to map Unicode characters into one or more bytes. The options are VT100, **VT100+**, VT-UTF8, and ANSI.

Bits Per Second

Use this feature to set the transmission speed for a serial port used in Console Redirection. Make sure that the same speed is used in the host computer and the client computer. A lower transmission speed may be required for long and busy lines. The options are 9600, 19200, 38400, 57600, and **115200** (bits per second).

Data Bits

Use this feature to set the data transmission size for Console Redirection. The options are 7 and 8.

Parity

A parity bit can be sent along with regular data bits to detect data transmission errors. Select Even if the parity bit is set to 0, and the number of 1's in data bits is even. Select Odd if the parity bit is set to 0, and the number of 1's in data bits is odd. Select None if you do not want to send a parity bit with your data bits in transmission. Select Mark to add a mark as a parity bit to be sent along with the data bits. Select Space to add a Space as a parity bit to be sent with your data bits. The options are **None**, Even, Odd, Mark, and Space.

Stop Bits

A stop bit indicates the end of a serial data packet. Select 1 Stop Bit for standard serial data communication. Select 2 Stop Bits if slower devices are used. The options are 1 and 2.

Flow Control

Use this feature to set the flow control for Console Redirection to prevent data loss caused by buffer overflow. Send a "Stop" signal to stop sending data when the receiving buffer is full. Send a "Start" signal to start sending data when the receiving buffer is empty. The options are **None** and Hardware RTS/CTS.

VT-UTF8 Combo Key Support

Use this feature to enable VT-UTF8 Combination Key support for ANSI/VT100 terminals. The options are Disabled and **Enabled**.

Recorder Mode

Use this feature to capture the data displayed on a terminal and send it as text messages to a remote server. The options are **Disabled** and Enabled.

Resolution 100x31

Use this feature to enabled for extended terminal resolution support. The options are Disabled and **Enabled**.

Putty KeyPad

This feature selects the settings for Function Keys and KeyPad used for Putty, which is a terminal emulator designed for the Windows OS. The options are **VT100**, LINUX, XTERMR6, SCO, ESCN, and VT400.

SOL

Console Redirection

Use this feature to enable the console redirection support for a serial port specified by you. The options are Disabled and **Enabled**.

Terminal Type

Use this feature to select the target terminal emulation type for Console Redirection. Select VT100 to use the ASCII Character set. Select VT100+ to add color and function key support. Select ANSI to use the Extended ASCII Character Set. Select VT-UTF8 to use UTF8 encoding to map Unicode characters into one or more bytes. The options are VT100, **VT100+**, VT-UTF8, and ANSI.

Bits Per Second

Use this feature to set the transmission speed for a serial port used in Console Redirection. Make sure that the same speed is used in the host computer and the client computer. A lower transmission speed may be required for long and busy lines. The options are 9600, 19200, 38400, 57600, and **115200** (bits per second).

Data Bits

Use this feature to set the data transmission size for Console Redirection. The options are 7 and 8.

Parity

A parity bit can be sent along with regular data bits to detect data transmission errors. Select Even if the parity bit is set to 0, and the number of 1's in data bits is even. Select Odd if the parity bit is set to 0, and the number of 1's in data bits is odd. Select None if you do not want to send a parity bit with your data bits in transmission. Select Mark to add a mark as a parity bit to be sent along with the data bits. Select Space to add a Space as a parity bit to be sent with your data bits. The options are **None**, Even, Odd, Mark, and Space.

Stop Bits

A stop bit indicates the end of a serial data packet. Select 1 Stop Bit for standard serial data communication. Select 2 Stop Bits if slower devices are used. The options are **1** and 2.

Flow Control

Use this feature to set the flow control for Console Redirection to prevent data loss caused by buffer overflow. Send a "Stop" signal to stop sending data when the receiving buffer is full. Send a "Start" signal to start sending data when the receiving buffer is empty. The options are **None** and Hardware RTS/CTS.

VT-UTF8 Combo Key Support

Use this feature to enable VT-UTF8 Combination Key support for ANSI/VT100 terminals. The options are Disabled and **Enabled**.

Recorder Mode

Use this feature to capture the data displayed on a terminal and send it as text messages to a remote server. The options are **Disabled** and Enabled.

Resolution 100x31

Use this feature to enable for extended terminal resolution support. The options are Disabled and **Enabled**.

Putty KeyPad

This feature selects the settings for Function Keys and KeyPad used for Putty, which is a terminal emulator designed for the Windows OS. The options are **VT100**, LINUX, XTERMR6, SCO, ESCN, and VT400.

Legacy Console Redirection

► Legacy Console Redirection Settings

Redirection COM Port

Use this feature to select the COM port used to display redirection of Legacy OS and Legacy OPRM messages. The options are **COM1** and SOL.

Resolution

Use this feature to select the number of rows and columns used in Console Redirection for legacy OS support. The options are **80x24** and 80x25.

Redirection After BIOS POST

Use this feature to enable or disable legacy console redirection after BIOS POST. When set to Bootloader, legacy console redirection is disabled before booting the OS. When set to Always Enable, legacy console redirection remains enabled when booting the OS. The options are **Always Enable** and BootLoader.

Serial Port for Out-Of-Band Management/Windows Emergency Management Services (EMS)

Console Redirection EMS

Select Enabled to use a COM port EMS Console Redirection. The options are **Disabled** and Enabled.

► Console Redirection Settings

Out-of-Band Mgmt Port

This feature selects a serial port in a client server to be used by the Microsoft Windows Emergency Management Services (EMS) to communicate with a remote host server. The options are **COM1** and SOL.

Terminal Type

Use this feature to select the target terminal emulation type for Console Redirection. Select VT100 to use the ASCII character set. Select VT100+ to add color and function key support. Select ANSI to use the extended ASCII character set. Select VT-UTF8 to use UTF8 encoding to map Unicode characters into one or more bytes. The options are VT100, VT100Plus, **VT-UTF8**, and ANSI.

Bits Per Second

This feature sets the transmission speed for a serial port used in Console Redirection. Make sure that the same speed is used in the host computer and the client computer. A lower transmission speed may be required for long and busy lines. The options are 9600, 19200, 57600, and **115200** (bits per second).

Flow Control

Use this feature to set the flow control for Console Redirection to prevent data loss caused by buffer overflow. Send a "Stop" signal to stop sending data when the receiving buffer is full. Send a "Start" signal to start sending data when the receiving buffer is empty. The options are **None**, Hardware RTS/CTS, and Software Xon/Xoff.

The setting for each of these features is displayed:

- **Data Bits**
- **Parity**
- **Stop Bits**

► SATA And RSTe Configuration

SATA And RST Configuration

SATA Controller(s)

This feature enables SATA device(s). The options are Disabled and **Enabled**.

****If this feature is set to Enabled, the following features will become available for configuration:***

SATA Mode Selection

Use this feature select the SATA mode. Select AHCI to configure an sSATA drive specified as an AHCI drive. The options are **AHCI** and Intel RSTe Premium With Intel Optane System Acceleration.

SATA Interrupt Selection (Available when SATA Mode Selection is set to Intel RSTe Premium With Intel Optane System Acceleration)

Use this feature to select the interrupt that will be available to the operating system. The options are **MSI-x**, MSI, and Legacy.

Support Aggressive Link Power Management

This feature enables the PCH to aggressively enter link power state. The options are Disabled and **Enabled**.

Serial ATA Port 3/4/5/7 Hot Plug

This feature designates the specified port for hot plugging. Set the setting to Enabled for hot-plugging support, which will allow you to replace a SATA disk drive without shutting down the system. The options are Disabled and **Enabled**.

Serial ATA Port 3/4/5/7 Spin Up Device

When this feature is disabled, all drives will spin up at boot. When this option is enabled, it will perform Staggered Spin Up on any drive this option is activated. The options are **Disabled** and Enabled.

Serial ATA Port 3/4/5/7 SATA Device Type

Use this feature to identify the type of HDD that is connected to the SATA port. The options are **Hard Disk Drive** and Solid State Drive.

► PCH-FW Configuration

The following PCH-FW information is displayed:

- Operation Firmware Version
- Backup Firmware Version
- Recovery Firmware Version
- ME Firmware Status #1
- ME Firmware Status #2
- Current State
- Error Code

▶ACPI Settings

High Precision Event Timer

Select Enabled to activate the High Precision Event Timer (HPET). The HPET produces periodic interrupts at a much higher frequency than a Real-time Clock (RTC) does in synchronizing multimedia streams, providing smooth playback, and reducing the dependency on other timestamp calculation devices. The HPET replaces the 8254 Programmable Interval Timer. The options are Disabled and **Enabled**.

Native PCIe Enable

Enable this feature to grant control of PCIe Native hot plug, PCIe Power Management Events, and PCIe Capability Structure Control. The options are Disabled and **Enabled**.

Native ASPM

Use this feature to set whether ASPM should be controlled by the OS or by the BIOS. The options are **Auto**, Enabled, and Disabled.

▶USB Configuration

USB Configuration

The following information will be displayed:

- USB Module Version
- USB Controllers
- USB Devices

Legacy USB Support

This feature enables or disables the ability of the system to wake-up from the S5 sleep state through USB ports. The options are **Enabled**, Disabled, and Auto.

XHCI Hand-off

This feature is a workaround solution for operating systems that do not support Extensible Host Controller Interface (XHCI) hand-off. The XHCI ownership change should be claimed by the XHCI driver. The options are **Enabled** and Disabled.

USB Mass Storage Driver Support

This feature enables USB mass storage driver support. The options are Disabled and **Enabled**.

► PCIe/PCI/PnP Configuration

PCI Devices Common Settings:

SR-IOV Support

Use this feature to enable or disable Single Root IO Virtualization Support. The options are **Disabled** and Enabled.

BME DMA Mitigation

Enable this feature to help block DMA attacks. The options are **Disabled** and Enabled.

Onboard Video Option ROM

Use this feature to select the Onboard Video Option ROM type. The options are Disabled and **EFI**.

Above 4GB MMIO BIOS Assignment

Select Enable for remapping of BIOS above 4GB. The options are **Enabled** and Disabled.

PCI PERR/SERR Support

Select Enabled to allow a PCI device to generate a PERR/SERR number for a PCI Bus Signal Error Event. The options are **Disabled** and Enabled.

VGA Priority

Use this feature to select the graphics device to be used as the primary video display for system boot. The options are **Onboard** and Offboard.

NVMe Firmware Source

Use this feature to select the NVMe firmware to support booting. The options are Vendor Defined Firmware and AMI Native Support. The default option, **Vendor Defined Firmware**, is pre-installed on the drive and may resolve errata or enable innovative functions for the drive. The other option, AMI Native Support, is offered by the BIOS with a generic method.

Storage Option ROM/UEFI Driver

Use this feature to enable device name support for onboard devices and slots. The options are Do not Launch, **UEFI**, and Legacy.

PCIe/PCI/PnP Configuration

CPU MICRO-LP PCIe 4.0 x8 OPROM

Select EFI to boot the computer with the EFI device installed on the specified PCIe slot. The options are Disabled and **EFI**.

CPU SLOT1 PCIe 5.0 x8 OPROM

Select EFI to boot the computer with the EFI device installed on the specified PCIe slot. The options are Disabled and **EFI**.

JMD1:M.2-H OPROM

Select EFI to boot the computer with the EFI device installed on the specified M.2 slot. The options are Disabled and **EFI**.

JMD2:M.2-H OPROM

Select EFI to boot the computer with the EFI device installed on the specified M.2 slot. The options are Disabled and **EFI**.

PCIe Clock

Use this feature to set PCIe Clock Native/FREE_RUNNING. The options are Native and **FREE_RUNNING**.

► Network Configuration

Network Stack

Select Enabled to enable Unified Extensible Firmware Interface (UEFI) for network stack support. The options are Disabled and **Enabled**.

IPv4 PXE Support (Available when Network Stack is set to Enabled)

Select Enabled to enable IPv4 Preboot Execution Environment (PXE) for boot support. If this feature is set to Disabled, IPv4 PXE boot option will not be supported. The options are Disabled and **Enabled**.

IPv4 HTTP Support (Available when Network Stack is set to Enabled)

Use this feature to enable IPv4 HTTP boot support. The options are **Disabled** and Enabled.

IPv6 PXE Support (Available when Network Stack is set to Enabled)

Select Enabled to enable IPv6 Preboot Execution Environment (PXE) for boot support. If this feature is set to Disabled, IPv6 PXE boot option will not be supported. The options are Disabled and **Enabled**.

IPv6 HTTP Support (Available when Network Stack is set to Enabled)

Use this feature to enable IPv6 HTTP boot support. The options are **Disabled** and Enabled.

PXE boot wait time (Available when Network Stack is set to Enabled)

Enter a value for the wait time (in seconds) to press the <ESC> key to abort the PXE boot. The default is **0**.

Media detect count (Available when Network Stack is set to Enabled)

Enter a value for the number of times the presence of media will be checked. The default is 1.

- ▶ **MAC: XXXXXXXXXXXXX-IPv4 Network Configuration**
- ▶ **MAC: XXXXXXXXXXXXX-IPv4 Network Configuration**

Configured

This feature indicates whether a network address configured successfully or not. The options are **Disabled** and **Enabled**.

****If this feature is set to Enabled, the following features will become available for configuration:***

Enable DHCP

Use this feature to set the DHCP. The options are **Disabled** and **Enabled**.

****If this feature is set to Disabled, the following features will become available for configuration:***

Local IP Address - Enter an IP address in dotted-decimal notation.

Local NetMask - Enter a NetMask in dotted-decimal notation.

Local Gateway - Enter a Gateway in dotted-decimal notation.

Local DNS Servers - Enter a DNS Servers in dotted-decimal notation.

Save Changes and Exit

Select this feature to save the changes you've made and return to the upper configuration page.

- ▶ **MAC: XXXXXXXXXXXXX-IPv6 Network Configuration**
- ▶ **MAC: XXXXXXXXXXXXX-IPv6 Network Configuration**

▶ Enter Configuration Menu

Information for the following is displayed:

- Interface Name
- Interface Type
- MAC address
- Host addresses
- Route Table
- Gateway addresses

- DNS addresses

Interface ID

Enter an ID for the device.

DAD Transmit Count

Enter a value for Duplicate Address Detection (DAD) Transmit Count. A value of zero indicates the DAD is not performed. The default is **1**.

Policy

Use this feature to set the Policy. The options are **Automatic** and Manual.

****If this feature is set to Manual, the following features will become available for configuration:***

► Advanced Configuration

New IPv6 Address - Enter a new IPv6 address.

New Gateway Addresses - Enter a Gateway address.

New DNS Addresses - Enter a new DNS address.

Commit Changes and Exit

Select this feature to save the changes you've made and return to the upper configuration page.

Discard Changes and Exit

Select this feature to discard all the changes and return to the upper configuration page.

Save Changes and Exit

Select this feature to save the changes you have made and return to the upper configuration page.

► Trusted Computing

When a Trusted-Platform Module (TPM) device is detected in your machine, the following information will display:

- TPM 2.0 Device Found
- Firmware Version
- Vendor

Security Device Support

Select Enable to enable BIOS support for onboard security devices, which are not displayed in the OS. If this feature is set to Enable, TCG EFI protocol and INT1A interface will not be available. The options are Disable and **Enable**.

****When "Security Device Support" is set to Enable, the following information will display:***

- Active PCR banks
- Available PCR banks

SHA256 PCR Bank (Available when Security Device Support is set to Enabled)

Select Enabled to enable SHA256 PCR Bank support to enhance system integrity and data security. The options are **Enabled** and Disabled.

Pending Operation (Available when Security Device Support is set to Enabled)

Use this feature to schedule a TPM-related operation to be performed by a security (TPM) device at the next system boot to enhance system data integrity. Your system will reboot to carry out a pending TPM operation. The options are **None** and TPM Clear.



Note: Your system will reboot to carry out a pending TPM operation.

Platform Hierarchy (Available when Security Device Support is set to Enabled)

Select Enabled for TPM Platform Hierarchy support, which allows the manufacturer to use the cryptographic algorithm to define a constant key or a fixed set of keys to be used for initial system boot. These early boot codes are shipped with the platform and are included in the list of "public keys." During system boot, the platform firmware uses the trusted public keys to verify a digital signature in an attempt to manage and control the security of the platform firmware used in a host system via a TPM device. The options are Disabled and **Enabled**.

Storage Hierarchy (Available when Security Device Support is set to Enabled)

Select Enabled for TPM Storage Hierarchy support that is intended to be used for non-privacy-sensitive operations by a platform owner such as an IT professional or the end user. Storage Hierarchy has an owner policy and an authorization value, both of which can be set and are held constant (-rarely changed) through reboots. This hierarchy can be cleared or changed independently of the other hierarchies. The options are Disabled and **Enabled**.

Endorsement Hierarchy (Available when Security Device Support is set to Enabled)

Select Enabled for Endorsement Hierarchy support, which contains separate controls to address privacy concerns because the primary keys in the hierarchy are certified by the TPM key or by a manufacturer with restrictions on how an authentic TPM device that is attached to an authentic platform can be accessed and used. A primary key can be encrypted and certified with a certificate created by using TPM2_ActivateCredential, which allows you to independently enable "flag, policy, and authorization values" without involving other hierarchies. A user with privacy concerns can disable the endorsement hierarchy while still using the storage hierarchy for TPM applications, permitting the platform software to use the TPM. The options are Disabled and **Enabled**.

Physical Presence Spec Version

Use this feature to change what Physical Presence Interface (PPI) Spec Version the OS should support. The options are 1.2 and **1.3**.

TPM 2.0 InterfaceType

Use this feature to view the interface type of the TPM 2.0 device.

PH Randomization

Select Enabled for Platform Hierarchy (PH) Randomization support, which is used only during the platform developmental stage. This feature cannot be enabled in the production platforms. The options are Disabled and **Enabled**.

TXT Support

Select Enabled to enable Intel Trusted Execution Technology (TXT) support to enhance system integrity and data security. The options are **Disabled** and Enabled.

 **Note 1:** If this feature is set to Enabled, be sure to disable Device Function On-Hide (EV DFX) support when it is present in the BIOS for the system to work properly.

 **Note 2:** For more information on TPM, refer to the TPM manual at <http://www.super-micro.com/manuals/other/TPM.pdf>.

► HTTP Boot Configuration

HTTP Boot Configuration

HTTP Boot Policy

Use this feature to select the policy of HTTP Boot. The options are Apply to all LANs, **Apply to each LAN**, and Boot Priority #1 instantly.



Note: To configure each LAN port, select Apply to each LAN or Boot Priority #1 instantly. Only "Instance of Priority 1" appears when selecting the option of Apply to all LANs.

HTTP Boot Checks Hostname

Selects whether HTTPS Boot Checks Hostname of TLS certificates matches the hostname provided by the remote server. The options are **Enabled** and Disabled (WARNING: Security Risk!!).

Warning: Disabling this option is a violation of RFC 6125 and may expose you to Man-in-the-Middle Attacks. Supermicro is not responsible for any and all security risks incurred by you disabling this option.

Priority of HTTP Boot

Instance of Priority 1

Use this feature to rank the targeted port.



Note: "Instance of Priority 2" is available for configuring when "HTTP Boot Policy" is set to "Apply to each LAN" or "Boot Priority #1 instantly."



Note: The features below will be hidden if the Instance of Priority 1 and Instance of Priority 2 are set to 0.

Select IPv4 or IPv6

Use this feature to select the Targeted LAN port that is boot from IPv4 or IPv6. The options are **IPv4** and IPv6.

Boot Description

Use this feature to input the HTTP boot option description, otherwise the boot option for the URI will not be created. The maximum length should not be more than 75 characters.

Boot URI

Use this feature to input the URI address for HTTP Boot feature. The maximum length should not be more than 128 characters.

► Supermicro KMS Server Configuration

Supermicro KMS Server IP address

Use this feature to enter the Supermicro Key Management Service (KMS) server IPv4 address in dotted-decimal notation.

Second Supermicro KMS Server IP address

Use this feature to enter the second Supermicro KMS server IPv4 address in dotted-decimal notation.

Supermicro KMS TCP Port number

Use this feature to enter the Supermicro KMS TCP port number. The valid range is 100 – 9999. The default setting is **5696**.

KMS Time Out

Use this feature to enter the KMS server connecting time-out (in seconds). The default setting is **5** (seconds).

TimeZone

Use this feature to enter the correct time zone. The default setting is **0** (not specified).

Client UserName

Press <Enter> to set the client identity (UserName). The length is 0 – 63 characters.

Client Password

Press <Enter> to set the client identity (Password). The length is 0 – 31 characters.

KMS TLS Certificate / Size

This feature displays the Transport Layer Security (TLS) certificate and its size for CA Certificate, Client Certificate, and Client Private Key.

► CA Certificate

For the CA certificate, use this feature to enroll factory defaults or load the KMS TLS certificates from the file. The options are **Update**, Delete, and Export.

► Client Certificate

For the client certificate, use this feature to enroll factory defaults or load the KMS TLS certificates from the file. The options are **Update**, Delete, and Export.

► Client Private Key

For the client private key, use this feature to enroll factory defaults or load the KMS TLS certificates from the file. The options are **Update**, Delete, and Export.

Private Key Password (Available when Private Key Password has been set)

Use this feature to change the private key password.

► Super-Guardians Configuration

Super Guardians is a unified security solution to facilitate KMS, TPM, or USB-based authentication controls for Supermicro X13 motherboards. Use this submenu to configure the authentication policy, method, and KMS server settings.

Super-Guardians Protection Policy

Use this feature to enable the Super-Guardians Protection Policy. The options are **Storage**, System, and "System and Storage." Set this feature to Storage to protect and have secure access to Trusted Computing Group (TCG) NVMe devices with the Authentication-Key (AK). Set this feature to System to protect and have secure access to your system/motherboard with the AK. Set this feature to "System and Storage" to protect and have secure access to your TCG NVMe devices/system/motherboard with the AK.

KMS Security Policy

Set this feature to Enabled to enable the Key Management Service (KMS) Security Policy. When this feature has not previously been set to Enabled, the options are **Disabled** and Enabled. Changes take effect after you save settings and reboot the system.



Note 1: Be sure that the KMS server is ready before configuring this feature.



Note 2: Use the professional KMS server solutions (e.g., Thales Server) or the Supermicro PyKMIP Software Package to establish the KMS server.

When this feature has previously been set to Enabled, the options are **Enabled**, Reset, and Key Rotation. Set this feature to Key Rotation to obtain an existing Authentication-Key from the KMS server and create a new Authentication-Key. To disable the KMS Security Policy, set this feature to Reset. When this feature is set to reset, the system and TCG NVMe devices chosen in "Super-Guardians Protection Policy" will be in the unprotected mode.

KMS Server Retry Count

Use this feature to specify how many times the system will attempt reconnecting to the KMS server. Press <+> or <-> on your keyboard to change the value. The default setting is **5**. If the value is 0, the system will retry infinitely. The valid range is 0 to 10.

TPM Security Policy

Use this feature to enable or disable the TPM Security Policy. When this feature has not previously been set to Enabled, the options are **Disabled** and Enabled. Changes take effect after you save settings and reboot the system.

 **Note:** Install a Trusted Platform Module 2.0 device to your system before configuring this feature.

When this feature has previously been set to Enabled, the options are **Enabled** and Reset. To disable the TPM Security Policy, set this feature to Reset. When this feature is set to reset, the system and TCG NVMe devices chosen in "Super-Guardians Protection Policy" will be in the unprotected mode.

Load Authentication-Key

Use this feature to toggle whether the BIOS should automatically load an Authentication-Key named TPMAuth.bin from a USB flash drive. The options are **Disabled** and Enabled. Set this feature to Enabled to load the Authentication-Key. After an Authentication Key is loaded, this option will be reset to Disabled. Changes take effect after you save settings and reboot the system.

 **Note 1:** Connect a USB flash drive with the Authentication-Key (TPMAuth.bin) to your system before configuring this feature.

 **Note 2:** Load the Authentication-Key after installing a TPM device. The TPM function will not work properly without an Authentication-Key.

USB Security Policy

Use this feature to configure USB Security Policy settings. When this feature has not previously been set to Enabled, this feature will toggle whether the BIOS should automatically save a USB Authentication-Key named "USBAuth.bin" to a USB flash drive and begin the USB Security Policy. The options are **Disabled** and Enabled. Changes take effect after you save settings and reboot the system.

 **Note:** Connect a USB flash drive to your system before configuring this feature. Save the USB Authentication-Key and keep a backup.

When this feature has been previously set to Enabled, the options are **Enabled** and Reset. To disable the USB Security Policy, set this feature to Reset. When this feature is set to reset, the system and TCG NVMe devices chosen in "Super-Guardians Protection Policy" will be in the unprotected mode.

▶ TLS Authenticate Configuration

This submenu allows you to configure Transport Layer Security (TLS) settings.

▶ Server CA Configuration

▶ Enroll Cert

▶ Enroll Certification Using File

Use this feature to enroll certification from a file.

Certification GUID

Use this feature to input the certification Global Unique Identifier (GUID).

▶ Commit Changes and Exit

Use this feature to save all changes and exit TLS settings.

▶ Discard Changes and Exit

Use this feature to discard all changes and exit TLS settings.

▶ Delete Certification

Use this feature to delete certification.

▶ Client Certification Configuration

▶ Enroll Certification

▶ Enroll Certification Using File

Use this feature to enroll certification from a file.

Certification GUID

Use this feature to input the certification Global Unique Identifier (GUID).

▶ **Commit Changes and Exit**

Use this feature to save all changes and exit TLS settings.

▶ **Discard Changes and Exit**

Use this feature to discard all changes and exit TLS settings.

▶ **Delete Certification**

Use this feature to delete certification.

▶ **INTEL SSDPEL1K375GA-PHKM92000048375A**

This page displays information about detected NVMe devices.

- Bus Protocol
- PCI Vendor/Device ID
- PCI Vendor subsystem id
- Model Number
- Serial Number
- Firmware Revision
- IEEE Organization Unique Id
- PCIe Maximum Link Width
- PCIe Maximim Speed
- PCIe Negotiated Link Width
- PCIe Negotiated Link Speed
- Number of Namespaces
- Device Capacity
- Device Size
- Device Health

▶ NVMe Opal Disks Manager

NVMe Opal Disks Manager

Physical Disks:

▶ INTEL SSDPEL1K375GA-PHKM92000048375A

▶ PSID Revert to Factory Default

Use this feature to revert the disk to factory default settings. This will erase all data from the disk.

Enter PSID

Enter a 32 character value.

▶ Intel(R) I350 Gigabit Network Connection - XX:XX:XX:XX:XX:XX

▶ Intel(R) I350 Gigabit Network Connection - XX:XX:XX:XX:XX:XX

▶ Firmware Image Properties

This feature displays information about the Ethernet controller. The following information is displayed:

- Option ROM version
- Unique NVM/EEPROM ID
- NVM Version

▶ NIC Configuration

Link Speed

Use this feature to specify the port speed for this port. The options are **Auto Negotiated**, 10 Mbps Half, 10 Mbps Full, 100 Mbps Half, and 100 Mbps Full.

Wake On LAN

Use this feature enable or disable Wake On Lan support. Wake On Lan allows the system to wake up when an onboard LAN device receives an incoming signal. The options are Disabled and **Enabled**.

Blink LEDs (range 0-15 seconds)

Use this feature to identify the physical network port by blinking the associated LED. Highlight this feature and enter a number of seconds in the range of 0 to 15 to set the amount of seconds to blink the LED. The default setting is **0**.

The following information is displayed:

- UEFI Driver
- Adapter PBA
- Device Name
- Chip Type
- PCI Device Id
- PCI Address
- Link Status
- MAC Address
- Virtual MAC Address

► Driver Health

This submenu displays the health of the LAN and its related controller.

4.4 Event Logs

Use this feature to configure Event Log settings.



► Change SMBIOS Event Log Settings

Enabling/Disabling Options

SMBIOS Event Log

Change this feature to enable or disable all features of the SMBIOS Event Logging during system boot. The options are Disabled and **Enabled**.

Erasing Settings

Erase Event Log

If No is selected, data stored in the event log will not be erased. Select Yes, Next Reset, data in the event log will be erased upon next system reboot. Select Yes, Every Reset, data in the event log will be erased upon every system reboot. The options are **No**, Yes, Next reset, and Yes, Every reset.

When Log is Full

Select Erase Immediately for all messages to be automatically erased from the event log when the event log memory is full. The options are **Do Nothing** and Erase Immediately.

SMBIOS Event Log Standard Settings

Log System Boot Event

This option toggles the System Boot Event logging to enabled or disabled. The options are Enabled and **Disabled**.

MECI

The Multiple Event Count Increment (MECI) counter counts the number of occurrences that a duplicate event must happen before the MECI counter is incremented. This is a numeric value. The default value is **1**.

METW

The Multiple Event Time Window (METW) defines the number of minutes that must pass between duplicate log events before the MECI is incremented. Highlight this feature and enter a number between 0 to 99. The default value is **60**.



Note: All values changed here do not take effect until the computer is restarted.

►View SMBIOS Event Log

Select this submenu and press enter to see the contents of the SMBIOS event log. The following categories will be displayed: Date/Time/Error Codes/Severity.

4.5 BMC

Use this feature to configure Baseboard Management Console (BMC) settings.



BMC Firmware Revision

This feature indicates the IPMI firmware revision used in your system.

BMC STATUS

This feature indicates the status of the IPMI firmware installed in your system.

▶ System Event Log

Enabling/Disabling Options

SEL Components

Select Enabled for all system event logging at boot up. The options are Disabled and Enabled.

Erasing Settings

Erase SEL (Available when SEL Components is set to "Enabled")

Select Yes, On next reset to erase all system event logs upon next system reboot. Select Yes, On every reset to erase all system event logs upon each system reboot. Select No to keep all system event logs after each system reboot. The options are **No**, Yes, On next reset, and Yes, On every reset.

When SEL is Full (Available when SEL Components is set to Enabled)

This feature allows you to decide what the BIOS should do when the system event log is full. Select Erase Immediately to erase all events in the log when the system event log is full. The options are **Do Nothing** and Erase Immediately.

► BMC Network Configuration

--BMC Network Configuration--

Update BMC LAN Configuration

Select Yes for the BIOS to implement all IP/MAC address changes at the next system boot. The options are **No** and Yes.

**If this feature above is set to Yes, the following features will become available for configuration:*

Configure IPv4 Support

BMC LAN Selection

This feature displays the BMC LAN setting. The default setting is **Failover**.

BMC Network Link Status

This feature displays the BMC Network Link status. The default setting is **Dedicated LAN**.

Configuration Address Source

This feature allows you to select the source of the IP address for this computer. If Static is selected, you will need to know the IP address of this computer and enter it to the system manually in the field. If DHCP is selected, the BIOS will search for a Dynamic Host Configuration Protocol (DHCP) server in the network that is attached to and request the next available IP address for this computer. The options are **DHCP** and Static.

**If the Configuration Address Source is set to DHCP, the following features will become available for configuration:*

- Station IP Address
- Subnet Mask
- Station MAC Address
- Gateway IP Address

**If the Configuration Address Source is set to Static, the following features will become available for configuration:*

Station IP Address

This feature displays the Station IP address for this computer. This should be in decimal and in dotted quad form (i.e., 192.168.10.253).

Subnet Mask

This feature displays the sub-network that this computer belongs to. The value of each three-digit number separated by dots should not exceed 255.

Station MAC Address

This feature displays the Station MAC address for this computer. Mac addresses are six two-digit hexadecimal numbers.

Gateway IP Address

This feature displays the Gateway IP address for this computer. This should be in decimal and in dotted quad form (i.e., 172.31.0.1).

VLAN

This feature enables the BMC VLAN function. The options are **Disabled** and Enabled.

****If the feature above is set to Enabled, the following feature will become available for configuration:***

VLAN ID

Use this feature to enter the VLAN ID. The default setting is **1**.

Configure IPv6 Support

IPv6 address status

This section displays status of station IPv6 address to BMC.

IPv6 Support

Use this feature to enable IPv6 support. The options are **Enabled** and Disabled.

****If the feature above is set to Enabled, the following feature will become available for configuration:***

Configuration Address Source

This feature allows you to select the source of the IP address for this computer. If Static is selected, you will need to know the IP address of this computer and enter it to the system manually in the field. If DHCP is selected, the BIOS will search for a Dynamic Host Configuration Protocol (DHCP) server in the network that is attached to and request the next available IP address for this computer. The options are Static Configuration, **DHCPv6 Stateless**, and DHCPv6 Stateful.

****If the Configuration Address Source is set to Static Configuration, the following features will become available for configuration:***

- IPv6 Address (Static)
- Prefix Length
- Gateway IP
- Preferred DNS server IP
- Alternative DNS server IP

****If the Configuration Address Source is set to DHCPv6 Stateless, the following features will become available for configuration:***

- Advanced Settings
- Preferred DNS server IP
- Alternative DNS server IP

4.6 Security

This menu allows you to configure the following security settings for the system.

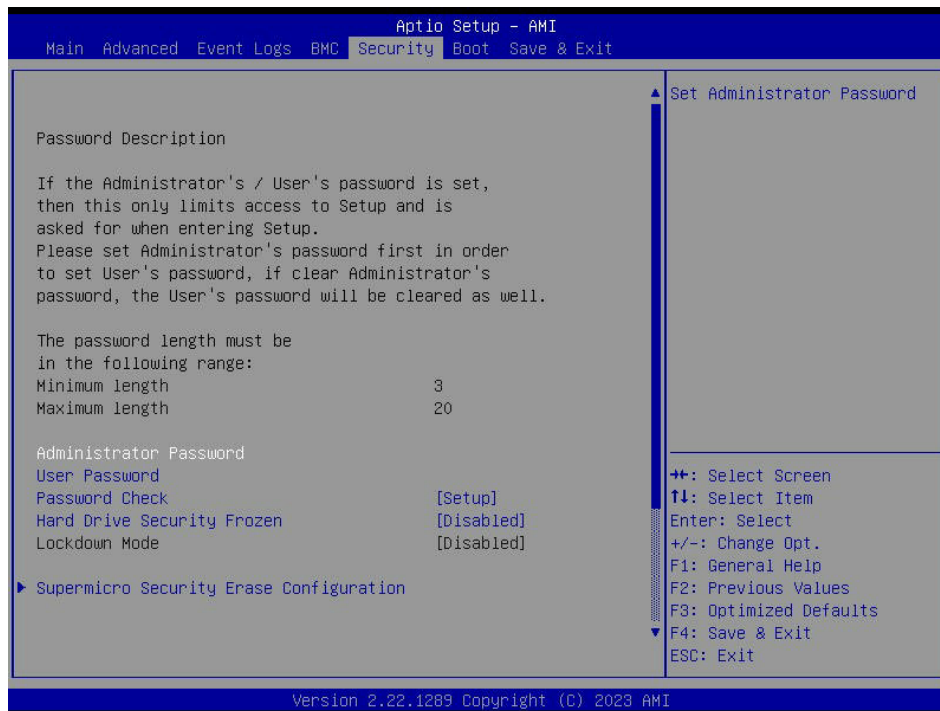

Administrator Password

This feature indicates if an administrator password has been set. Press <Enter> to create a new or change an existing administrator password. The length of the password can be between three to 20 characters long.

User Password (Available when "Administrator Password" has been set)

This feature indicates if a user password has been set. Press <Enter> to create a new or change an existing user password. The length of the password can be between three to 20 characters long.

Password Check

Use this feature to have the system check for a password during BIOS Setup. Select Always for the system to check for a password at bootup and upon entering the BIOS Setup utility. The options are **Setup** and Always.

Hard Drive Security Frozen

Use this feature to enable or disable freezing of the Lock Security feature for storage drives to protect key data in drives from being altered. The options are Enabled and **Disabled**.

Lockdown Mode

Use this feature to disable or enable Lockdown Mode. Lockdown Mode prevents existing data or keys stored in the system from being altered or changed to preserve system integrity and security. The options are **Disabled** and Enabled.

► Supermicro Security Erase Configuration

 **Note:** This submenu becomes configurable when a storage device has been plugged into the motherboard. The features displayed in this section will change depending on what storage devices are detected.

The following information is displayed:

- HDD Name
- HDD Serial Number
- Security Mode
- TCG Device Type
- Estimated Time
- Admin Pwd Status
- **Security Function**

 **Note:** Use this feature to secure erase the storage device or set a password for secure erasing this storage device. The options are **Disable**, Set Password, Security Erase – Password, and Security Erase – PSID.

- **Password**

 **Note:** Use this feature to set the user password.

HDD Security Configuration (Available for configuration if a drive is detected)

You can set a password to protect the drive.

► Secure Boot

 **Note:** For detailed instructions on how to configure Security Boot settings, refer to the Security Boot Configuration User's Guide posted on the web page under the link: <http://www.supermicro.com/support/manuals/>.

This section displays the contents of the following secure boot features:

- System Mode
- Secure Boot

Secure Boot

Select Enabled to configure Secure Boot settings. The options are **Disabled** and Enabled.

Secure Boot Mode

Use this feature to select the desired secure boot mode for the system. The options are Standard and **Custom**.

CSM Support

If this feature is set to Enabled, legacy devices will be supported by the system. The options are **Disabled** and Enabled.

▶ Restore Factory Keys

Select Yes to restore manufacturer default keys used to ensure system security. The options are **Yes** and No. Selecting Yes will reset the system to Deployed mode.

▶ Reset to Setup Mode

This feature resets the system to Setup Mode. The options are **Yes** and No.

▶ Enter Audit Mode (Available when "Secure Boot Mode" is set to Custom)

Select Ok to enter the Audit Mode workflow. It will result in erasing of Platform Key (PK) variables and reset system to the Setup/Audit Mode.

▶ Key Management (Available when "Secure Boot Mode" is set to Custom)

The following information is displayed.

- Vendor Keys

Factory Key Provision

Select Enabled to install provision factory default settings after the platform reset while the system is in the Setup Mode. The options are **Disabled** and Enabled.

▶ Restore Factory Keys

Select Yes to restore manufacturer default keys used to ensure system security. The options are **Yes** and No. Selecting Yes will reset the system to Deployed mode.

▶ Reset To Setup Mode (Available when any secure keys have been installed)

This feature resets the system to the Setup Mode. The options are **Yes** and No.

▶ Enroll Efi Image

This feature allows the image to run in the secure boot mode. Enroll SHA256 Hash certificate of a PE image into the Authorized Signature Database (DB).

▶ Export Secure Boot Variables (Available when any secure keys have been installed)

This feature exports the NVRAM contents of secure boot variables to a storage device. The options are Yes and No.

Secure Boot variable / Size / Keys / Key Source

▶ Platform Key (PK)

Use this feature to enter and configure a set of values to be used as platform firmware keys for the system. These values also indicate the sizes, keys numbers, and the sources of the authorized signatures. Select Update to update your "Platform Key." The default option is **Update**.

▶ Key Exchange Key (KEK)

Use this feature to enter and configure a set of values to be used as Key-Exchange-Keys for the system. These values also indicate the sizes, keys numbers, and the sources of the authorized signatures. Select Update to update your "Key Exchange Keys." Select Append to append your "Key Exchange Keys." The options are **Update** and Append.

▶ Authorized Signatures (db)

Use this feature to enter and configure a set of values to be used as Authorized Signatures for the system. These values also indicate the sizes, keys numbers, and the sources of the authorized signatures. Select Update to update your "Authorized Signatures." Select Delete to delete the authorized signatures. The options are **Update** and Append.

▶ **Forbidden Signatures (dbx)**

Use this feature to enter and configure a set of values to be used as Forbidden Signatures for the system. These values also indicate sizes, key numbers, and key sources of the forbidden signatures. Select Update to update your "Forbidden Signatures." Select Append to append your "Forbidden Signatures." The options are **Update** and Append.

▶ **Authorized TimeStamps (dbt)**

This feature allows you to set and save the timestamps for the authorized signatures which will indicate the time when these signatures are entered into the system. These values also indicate sizes, keys, and key sources of the authorized timestamps. Select Update to update your "Authorized TimeStamps." Select Append to append your "Authorized TimeStamps." The options are **Update** and Append.

▶ **OsRecovery Signatures (dbr)**

This feature allows you to set and save the timestamps for the authorized signatures which will indicate the time when these signatures are entered into the system. These values also indicate sizes, keys, and key sources of the authorized timestamps. Select Update to update your "Authorized TimeStamps." Select Append to append your "Authorized TimeStamps." The options are **Update** and Append.

4.7 Boot

Use this feature to configure Boot Settings:

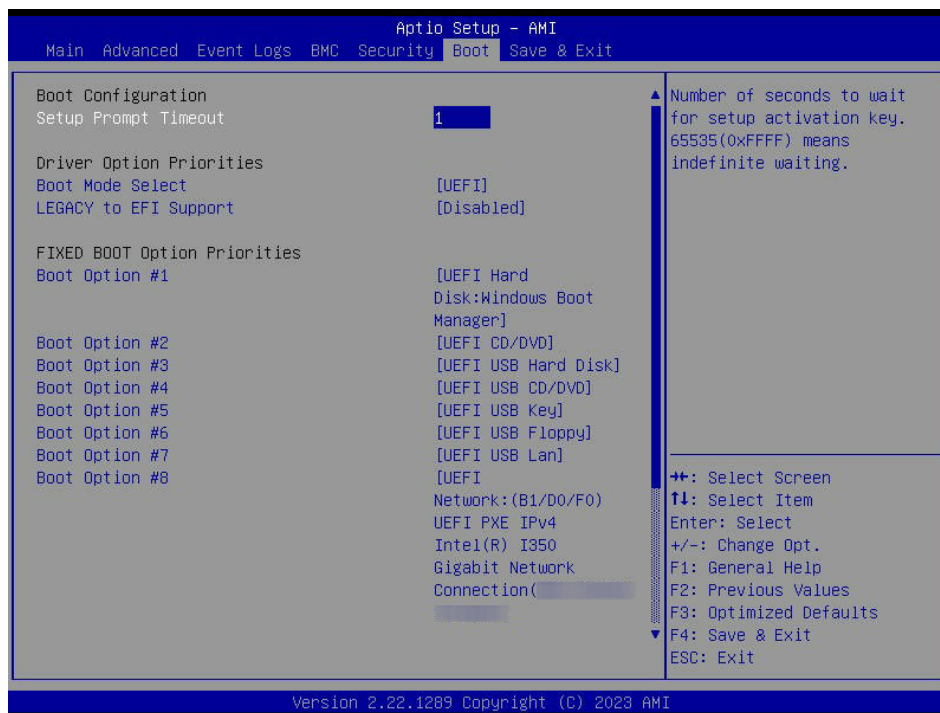

Setup Prompt Timeout

Use this feature to set the number of seconds to wait for the BIOS Setup activation key. The default value is **1**. Set this value to 65535 (0xFFFF) to wait indefinitely.

Boot Mode Select

Use this feature to select the type of devices from which the system will boot. The options are Legacy, **UEFI**, and Dual.

 **Note:** When "Boot Mode Select" is set to Dual, all OPRM-related features will be set to Legacy.

LEGACY to EFI Support

Use this feature to enable booting from EFI OS if Legacy boot order fails. The options are **Disabled** and Enabled.

Fixed Boot Order Priorities

This feature prioritizes the order of a bootable device from which the system will boot. Press <Enter> on each item sequentially to select devices. The displayed options change depending on the setting for "Boot Mode Select."

▶ Add New Boot Option (Available when any storage device is detected by the BIOS)

Use this feature to add a new boot option to the boot priority features for system boot.

Add boot option

Use this feature to specify the name for the new boot option.

Path for boot option

Use this feature to enter the path for the new boot option in the format fsx:\path\filename.efi.

Boot option File Path

Use this feature to specify the file path for the new boot option.

Create

Use this feature to create the new boot option in the boot priority list after the name and file path for the boot option are set.

▶ Delete Boot Option

This feature allows you to select a boot device to delete from the boot priority list.

Delete Boot Option

Use this feature to remove an EFI boot option from the boot order.

▶ UEFI Hard Disk Drive BBS Priorities

This feature allows you to set the system boot order of detected devices.

▶ UEFI USB Key Drive BBS Priorities

This feature allows you to set the system boot order of detected devices.

▶ UEFI NETWORK Drive BBS Priorities

This feature allows you to set the system boot order of detected devices.

▶ UEFI Application Boot Priorities

This feature allows you to set the system boot order of detected devices.

4.8 Save & Exit

Use this feature to save the configurations or leave the BIOS Setup utility.

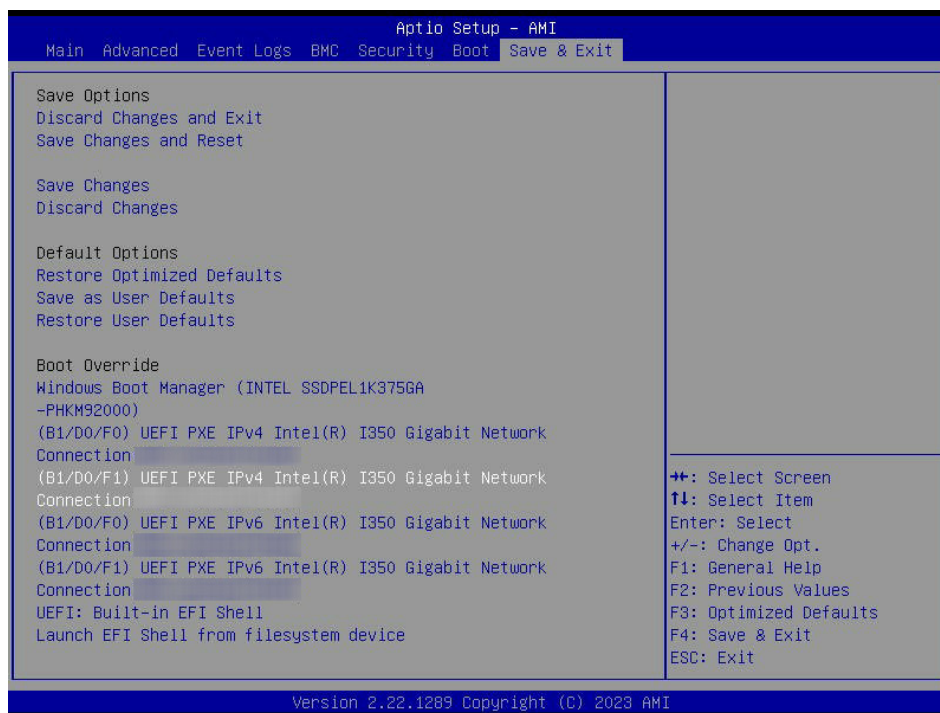

Save Options

Discard Changes and Exit

Select this feature to leave the BIOS Setup utility without making any permanent changes to the system configuration, and reboot the computer.

Save Changes and Reset

When you have completed the system configuration changes, select this feature to leave the BIOS Setup utility and reboot the computer, so the new system configuration parameters can take effect.

Save Changes

After completing the system configuration changes, select this feature to save the changes you have made. This will not reset (reboot) the system.

Discard Changes

Select this feature and press <Enter> to discard all the changes and return to the AMI BIOS utility program.

Default Options**Restore Optimized Defaults**

Select this feature and press <Enter> to load the optimized defaults. These are factory settings designed for maximum system stability but not for maximum performance.

Save As User Defaults

Select this feature and press <Enter> to save as the user defaults. This enables you to save any changes to the BIOS setup for future use.

Restore User Defaults

Select this feature and press <Enter> to restore the user defaults. Use this feature to retrieve user-defined settings that were saved previously.

Boot Override

Listed on this section are other boot options for the system (i.e., Built-in EFI shell). Select a desired feature and press <Enter>. Your system will boot to the selected boot option.

Appendix A

BIOS Codes

A.1 BIOS Error POST (Beep) Codes

During the Power-On Self-Test (POST) routines, which are performed each time the system is powered on, errors may occur.

Non-fatal errors are those which, in most cases, allow the system to continue the boot-up process. The error messages normally appear on the screen.

Fatal errors are those which will not allow the system to continue the boot-up procedure. If a fatal error occurs, you should consult with your system manufacturer for possible repairs.

These fatal errors are usually communicated through a series of audible beeps. The table shown below lists some common errors and their corresponding beep codes encountered by users.

BIOS Beep (POST) Codes		
Beep Code	Error Message	Description
1 beep	Refresh	Circuits have been reset (Ready to power up)
5 short, 1 long	Memory error	No memory detected in system
5 long, 2 short	Display memory read/write error	Video adapter missing or with faulty memory
1 long continuous	System OH	System overheat condition

A.2 Additional BIOS POST Codes

The AMI BIOS supplies additional checkpoint codes, which are documented online at <http://www.supermicro.com/support/manuals/> ("AMI BIOS POST Codes User's Guide").

For information on AMI updates, please refer to <http://www.ami.com/products/>.

Appendix B

Software

After the hardware has been installed, you can install the Operating System (OS), configure RAID settings and install the drivers.

B.1 Microsoft Windows OS Installation

If you will be using RAID, you must configure RAID settings before installing the Windows OS and the RAID driver. Refer to the RAID Configuration User Guides posted on our website at www.supermicro.com/support/manuals.

Installing the OS

1. Create a method to access the MS Windows installation ISO file. That can be a USB flash or media drive.
2. Retrieve the proper RST/RSTe driver. Go to the Supermicro web page for your motherboard and click on "Download the Latest Drivers and Utilities," select the proper driver, and copy it to a USB flash drive.
3. Boot from a bootable device with Windows OS installation. You can see a bootable device list by pressing <F11> during the system startup.

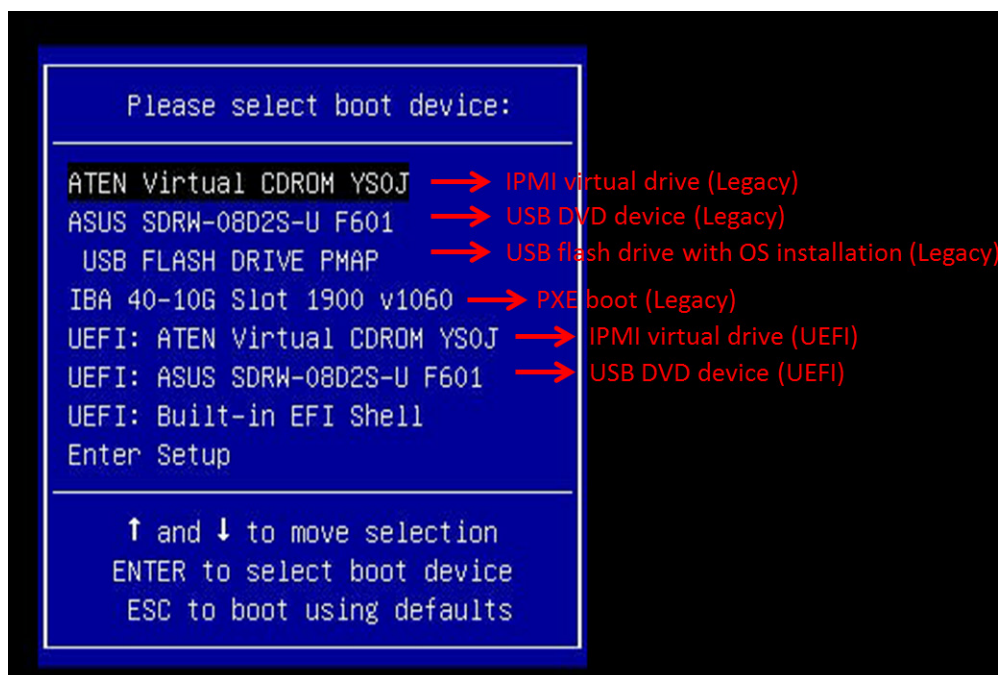

Figure B-1. Select Boot Device

4. During Windows Setup, continue to the dialog where you select the drives on which to install Windows. If the disk you want to use is not listed, click on the “Load driver” link at the bottom left corner.

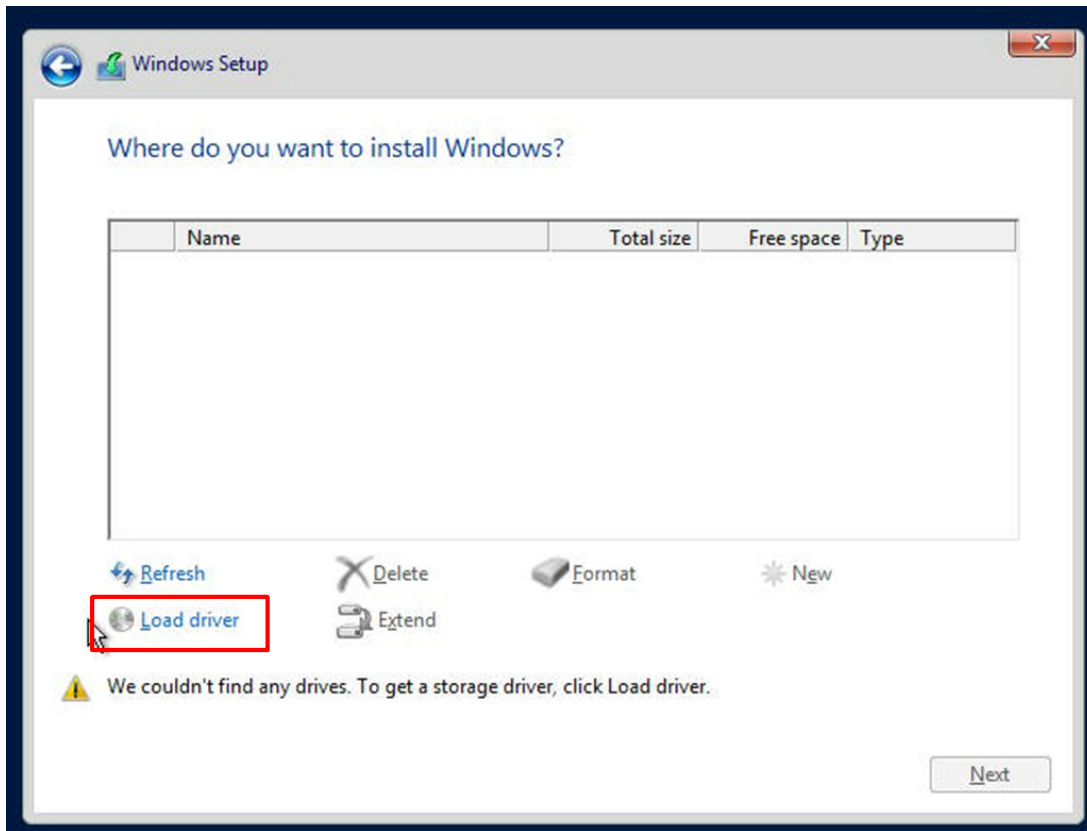

Figure B-2. Load Driver Link

To load the driver, browse the USB flash drive for the proper driver files.

- For RAID, choose the SATA/sSATA RAID driver indicated then choose the storage drive on which you want to install it.
 - For non-RAID, choose the SATA/sSATA AHCI driver indicated then choose the storage drive on which you want to install it.
5. Once all devices are specified, continue with the installation.
 6. After the Windows OS installation has completed, the system will automatically reboot multiple times.

B.2 Driver Installation

The Supermicro website contains drivers and utilities for your system at <https://www.supermicro.com/wdl/driver>. Some of these must be installed, such as the chipset driver.

After accessing the website, go into the CDR_Images (in the parent directory of the above link) and locate the ISO file for your motherboard. Download this file to a USB flash or media drive. You may also use a utility to extract the ISO file if preferred.

Another option is to go to the Supermicro website at <http://www.supermicro.com/products/>. Find the product page for your motherboard, and "Download the Latest Drivers and Utilities."

Insert the flash drive or disk and the screenshot shown below should appear.

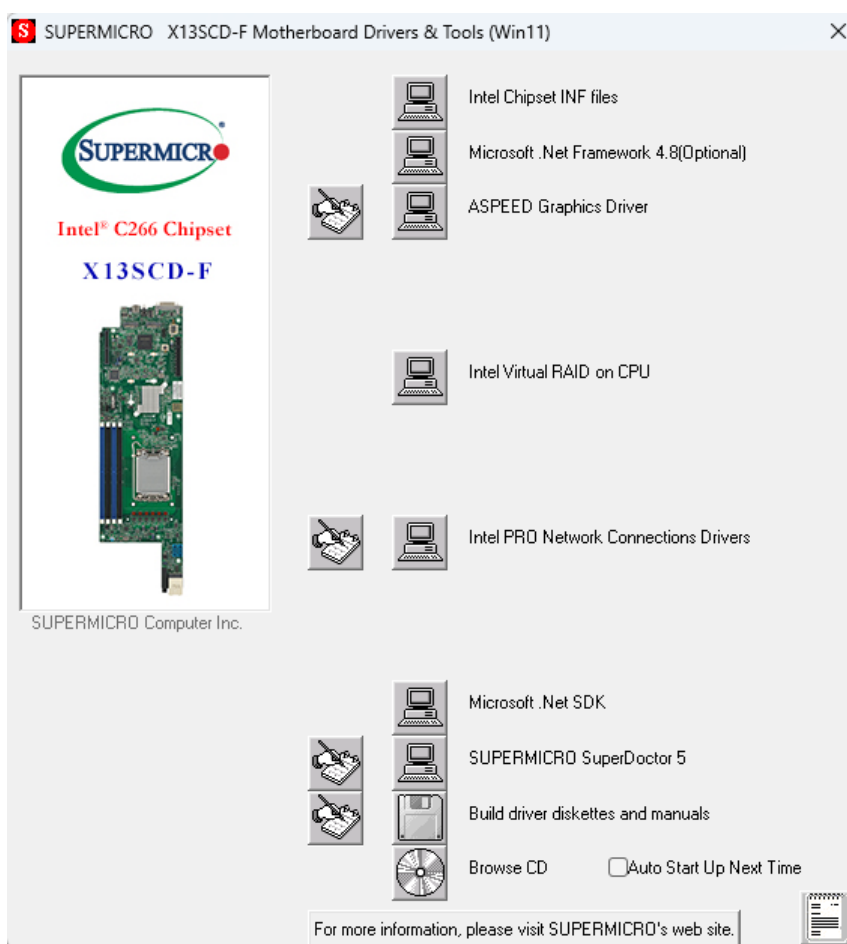



Figure B-3. Driver & Tool Installation Screen

 **Note:** Click the icons showing a hand writing on paper to view the readme files for each item. Click the computer icons to the right of these items to install each item (from top to bottom) one at a time. **After installing each item, you must reboot the system before moving on to the next item on the list.** The bottom icon with a CD on it allows you to view the entire contents.

B.3 SuperDoctor® 5

The Supermicro SuperDoctor 5 is a program that functions in a command-line or web-based interface for Windows and Linux operating systems. The program monitors such system health information as CPU temperature, system voltages, system power consumption, fan speed, and provides alerts via email or Simple Network Management Protocol (SNMP).

SuperDoctor 5 comes in local and remote management versions and can be used with Nagios to maximize your system monitoring needs. With SuperDoctor 5 Management Server (SSM Server), you can remotely control power on/off and reset chassis intrusion for multiple systems with SuperDoctor 5. SuperDoctor 5 Management Server monitors HTTP, FTP, and SMTP services to optimize the efficiency of your operation.

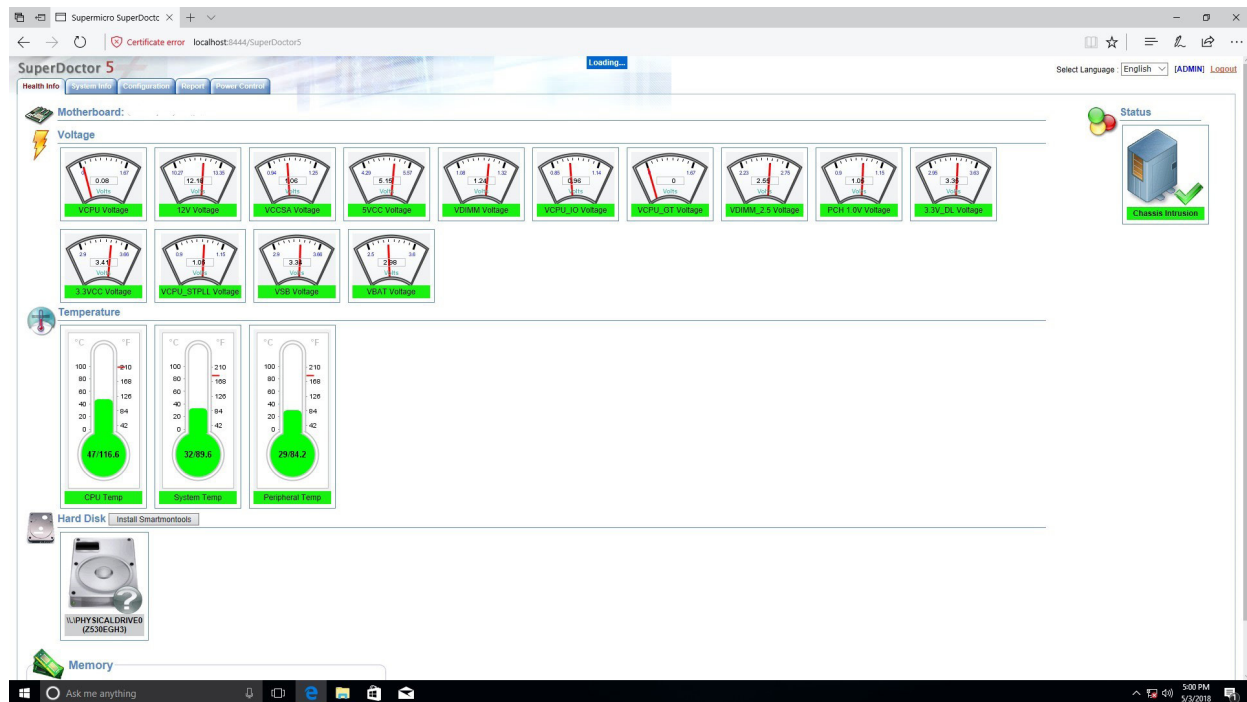

Figure B-4. SuperDoctor 5 Interface Display Screen (Health Information)

Appendix C

Standardized Warning Statements

The following statements are industry standard warnings, provided to warn the user of situations which have the potential for bodily injury. Should you have questions or experience difficulty, contact Supermicro's Technical Support department for assistance. Only certified technicians should attempt to install or configure components.

Read this section in its entirety before installing or configuring components.

These warnings may also be found on our website at http://www.supermicro.com/about/policies/safety_information.cfm.

Battery Handling



Warning! There is the danger of explosion if the battery is replaced incorrectly. Replace the battery only with the same or equivalent type recommended by the manufacturer. Dispose of used batteries according to the manufacturer's instructions

電池の取り扱い

電池交換が正しく行われなかった場合、破裂の危険性があります。交換する電池はメーカーが推奨する型、または同等のものを使用下さい。使用済電池は製造元の指示に従って処分して下さい。

警告

電池更換不當會有爆炸危險。請只使用同類電池或製造商推薦的功能相當的電池更換原有電池。請按製造商的說明處理廢舊電池。

警告

電池更換不當會有爆炸危險。請使用製造商建議之相同或功能相當的電池更換原有電池。請按照製造商的說明指示處理廢棄舊電池。

Warnung

Bei Einsetzen einer falschen Batterie besteht Explosionsgefahr. Ersetzen Sie die Batterie nur durch den gleichen oder vom Hersteller empfohlenen Batterietyp. Entsorgen Sie die benutzten Batterien nach den Anweisungen des Herstellers.

Attention

Danger d'explosion si la pile n'est pas remplacée correctement. Ne la remplacer que par une pile de type semblable ou équivalent, recommandée par le fabricant. Jeter les piles usagées conformément aux instructions du fabricant.

¡Advertencia!

Existe peligro de explosión si la batería se reemplaza de manera incorrecta. Reemplazar la batería exclusivamente con el mismo tipo o el equivalente recomendado por el fabricante. Desechar las baterías gastadas según las instrucciones del fabricante.

אזהרה!

קיימת סכנת פיצוץ של הסוללה במידה והוחלפה בדרך לא תקינה. יש להחליף את הסוללה בסוג התואם מחברת יצרן מומלצת. סילוק הסוללות המשומשות יש לבצע לפי הוראות היצרן.

هناك خطر من انفجار في حالة اسبدال البطارية بطريقة غير صحيحة فعلي
اسبدال البطارية فقط بنفس النع أو ما يعادلها مما أوصت به الشركة المصنعة
جخلص من البطاريات المسعملة وفقا لعمليات الشركة الصانعة

경고!

배터리가 올바르게 교체되지 않으면 폭발의 위험이 있습니다. 기존 배터리와 동일하거나 제조사에서 권장하는 동등한 종류의 배터리로만 교체해야 합니다. 제조사의 안내에 따라 사용된 배터리를 처리하여 주십시오.

Waarschuwing

Er is ontploffingsgevaar indien de batterij verkeerd vervangen wordt. Vervang de batterij slechts met hetzelfde of een equivalent type die door de fabrikant aanbevolen wordt. Gebruikte batterijen dienen overeenkomstig fabrieksvoorschriften afgevoerd te worden.

Product Disposal



Warning! Ultimate disposal of this product should be handled according to all national laws and regulations.

製品の廃棄

この製品を廃棄処分する場合、国の関係する全ての法律・条例に従い処理する必要があります。

警告

本产品的废弃处理应根据所有国家的法律和规章进行。

警告

本產品的廢棄處理應根據所有國家的法律和規章進行。

Warnung

Die Entsorgung dieses Produkts sollte gemäß allen Bestimmungen und Gesetzen des Landes erfolgen.

¡Advertencia!

Al deshacerse por completo de este producto debe seguir todas las leyes y reglamentos nacionales.

Attention

La mise au rebut ou le recyclage de ce produit sont généralement soumis à des lois et/ou directives de respect de l'environnement. Renseignez-vous auprès de l'organisme compétent.

סילוק המוצר

אזהרה!

סילוק סופי של מוצר זה חייב להיות בהתאם להנחיות וחוקי המדינה.

عند التخلص النهائي من هذا المنتج ينبغي التعامل معه وفقا لجميع القوانين واللوائح الوطنية

경고!

이 제품은 해당 국가의 관련 법규 및 규정에 따라 폐기되어야 합니다.

Waarschuwing

De uiteindelijke verwijdering van dit product dient te geschieden in overeenstemming met alle nationale wetten en reglementen.

Appendix D

UEFI BIOS Recovery

Warning: Do not upgrade the BIOS unless your system has a BIOS-related issue. Flashing the wrong BIOS can cause irreparable damage to the system. In no event shall Supermicro be liable for direct, indirect, special, incidental, or consequential damages arising from a BIOS update. If you need to update the BIOS, do not shut down or reset the system while the BIOS is updating to avoid possible boot failure.

D.1 Overview

The Unified Extensible Firmware Interface (UEFI) provides a software-based interface between the operating system and the platform firmware in the pre-boot environment. The UEFI specification supports an architecture-independent mechanism that will allow the UEFI OS loader stored in an add-on card to boot the system. The UEFI offers clean, hands-off management to a computer during system boot.

D.2 Recovering the UEFI BIOS Image

A UEFI BIOS flash chip consists of a recovery BIOS block and a main BIOS block (a main BIOS image). The recovery block contains critical BIOS codes, including memory detection and recovery codes for the user to flash a healthy BIOS image if the original main BIOS image is corrupted. When the system power is first turned on, the boot block codes execute first. Once this process is completed, the main BIOS code will continue with system initialization and the remaining Power-On Self-Test (POST) routines.



Note 1: Follow the BIOS recovery instructions below for BIOS recovery when the main BIOS block crashes.

Note 2: When the BIOS recovery block crashes, you will need to follow the procedures to make a Returned Merchandise Authorization (RMA) request. (For a RMA request, please see section 3.5 for more information).

D.3 Recovering the BIOS Block with a USB Device

This feature allows you to recover the main BIOS image using a USB-attached device without additional utilities used. A USB flash or media drive can be used for this purpose. However, a USB Hard Disk drive cannot be used for BIOS recovery at this time.

The file system supported by the recovery block is FAT (including FAT12, FAT16, and FAT32), which is installed on a bootable or non-bootable USB-attached device. However, the BIOS might need several minutes to locate the SUPER.ROM file if the media size becomes too large due to the huge volumes of folders and files stored in the device.

To perform UEFI BIOS recovery using a USB-attached device, follow the instructions below:

1. Using a different machine, copy the "Super.ROM" binary image file into the disc Root "\\" directory of a USB flash or media drive.

 **Note 1:** If you cannot locate the "Super.ROM" file in your driver disk, visit our website at www.supermicro.com to download the BIOS package. Extract the BIOS binary image into a USB flash device and rename it "Super.ROM" for the BIOS recovery use.



 **Note 2:** Before recovering the main BIOS image, confirm that the "Super.ROM" binary image file you download is the same version or a close version meant for your motherboard.

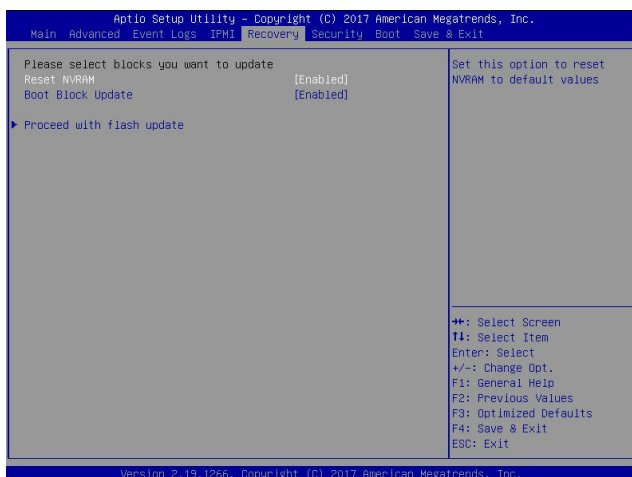

2. Insert the USB device that contains the new BIOS image ("Super.ROM") into your USB port and reset the system until the following screen appears:
3. After locating the new BIOS binary image, the system will enter the BIOS Recovery menu as shown below:

 **Note:** At this point, you may decide if you want to start the BIOS recovery. If you decide to proceed with BIOS recovery, follow the procedures below.

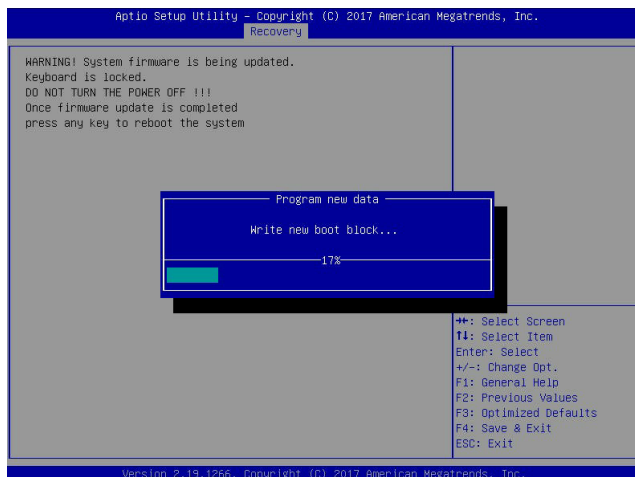

- When the screen as shown above displays, use the arrow keys to select the item "Proceed with flash update" and press the <Enter> key. You will see the BIOS recovery progress as shown in the screen below:

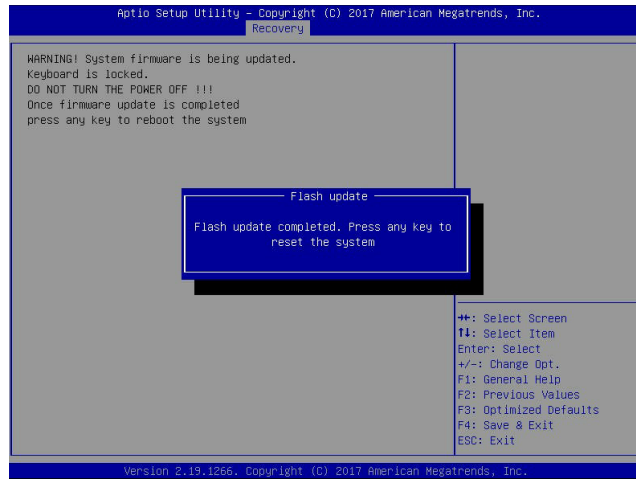

Note: Do not interrupt the BIOS flashing process until it has completed.

- After the BIOS recovery process is completed, press any key to reboot the system.
- Using a different system, extract the BIOS package into a USB flash drive.
- Press during system boot to enter the BIOS Setup utility. From the top of the tool bar, select Boot to enter the submenu. From the submenu list, select Boot Option #1 as shown below. Then, set Boot Option #1 to [UEFI AP:UEFI: Built-in EFI Shell]. Press <F4> to save the settings and exit the BIOS Setup utility.

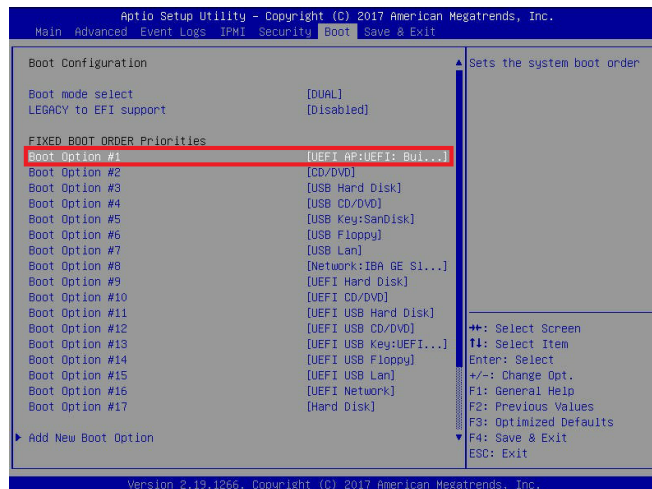

- When the UEFI Shell prompt appears, type `fs#` to change the device directory path. Go to the directory that contains the BIOS package you extracted earlier from Step 6. Enter `flash.nsh BIOSname.###` at the prompt to start the BIOS update process.

```

UEFI Interactive Shell v2.1
EDK II
UEFI v2.50 (American Megatrends, 0x0005000C)
Mapping table
  FS0: Alias(s):HD(0):MBR:BLK1:
      PciRoot(0x0)/Pci(0x14,0x0)/USB(0x11,0x0)/HD(1,MBR,0x37910122,0x800,0x1
CR9592)
  BLK0: Alias(s):
      PciRoot(0x0)/Pci(0x14,0x0)/USB(0x11,0x0)
Press F8 in 1 seconds to skip startup.nsh or any other key to continue.
Shell> fs0:
FS0:\> cd AFUD08
FS0:\AFUD08> cd SNJPME2_03162017
FS0:\AFUD08\SNJPME2_03162017> flash.nsh X110PU7_314

```

```

Done.
[ Access CMOS Port Ex ]
<read>
Index 0x51: 0x18
Done.
*****
* Program BIOS and ME (including FDT) regions...
*****
| AMI Firmware Update Utility v5.09.01.1317 |
| Copyright (C)2017 American Megatrends Inc. All Rights Reserved. |
*****
CPUID = 50652
Reading flash ..... done
- ME Data Size checking ..... ok
- FFS checksums ..... ok
- Check RomLayout ..... Ok.
Erasing Boot Block ..... done
Updating Boot Block ..... done
Verifying Boot Block ..... done
_Erasing Main Block ..... 0x00132000 (0x)

```

```

- Successful Update MFSBII-
- Successful Update FPPRII-
- Successful Update MFS, IVBI and IVB2II
- Successful Update FLOG and UTOXII
- ME Entire Image update success !!
WARNING : System must power-off to have the changes take effect!!
Moving FS0:\AFUD08\SNJPME2_03162017\fdtx64.efi -> FS0:\AFUD08\SNJPME2_03162017\
fd.smc
- [ok]
Moving FS0:\AFUD08\SNJPME2_03162017\afuef1x64.efi -> FS0:\AFUD08\SNJPME2_0316201
7\afuef1.smc
- [ok]
*****
* Please ignore this 'Shell: Cannot read from file - Device Error'
* warning message due to it does not impact flashing process.
*****
Deleting 'FS0:\Startup.nsh'
Delete successful.
FS0:\>

```



Note: Do not interrupt this process until the BIOS flashing is complete.

- The screen below indicates that the BIOS update process is complete. When you see the screen below, unplug the AC power cable from the power supply, clear CMOS, and plug the AC power cable in the power supply again to power on the system.
- Press `` to enter the BIOS Setup utility.
- Press `<F3>` to load the default settings.
- After loading the default settings, press `<F4>` to save the settings and exit the BIOS Setup utility.