



X13DEG-R

USER'S MANUAL

Revision 1.0b

The information in this user's manual has been carefully reviewed and is believed to be accurate. The manufacturer assumes no responsibility for any inaccuracies that may be contained in this document, and makes no commitment to update or to keep current the information in this manual, or to notify any person or organization of the updates. **Please Note: For the most up-to-date version of this manual, please see our website at www.supermicro.com.**

Super Micro Computer, Inc. ("Supermicro") reserves the right to make changes to the product described in this manual at any time and without notice. This product, including software and documentation, is the property of Supermicro and/or its licensors, and is supplied only under a license. Any use or reproduction of this product is not allowed, except as expressly permitted by the terms of said license.

IN NO EVENT WILL SUPER MICRO COMPUTER, INC. BE LIABLE FOR DIRECT, INDIRECT, SPECIAL, INCIDENTAL, SPECULATIVE, OR CONSEQUENTIAL DAMAGES ARISING FROM THE USE OR INABILITY TO USE THIS PRODUCT OR DOCUMENTATION EVEN IF ADVISED OF THE POSSIBILITY OF SUCH DAMAGES. IN PARTICULAR, SUPER MICRO COMPUTER, INC. SHALL NOT HAVE LIABILITY FOR ANY HARDWARE, SOFTWARE, OR DATA STORED OR USED WITH THE PRODUCT, INCLUDING THE COSTS OF REPAIRING, REPLACING, INTEGRATING, INSTALLING, OR RECOVERING SUCH HARDWARE, SOFTWARE, OR DATA.

Any disputes arising between manufacturer and customer shall be governed by the laws of Santa Clara County in the State of California, USA. The State of California, County of Santa Clara shall be the exclusive venue for the resolution of any such disputes. Supermicro's total liability for all claims will not exceed the price paid for the hardware product.

FCC Statement: This equipment has been tested and found to comply with the limits for a Class A digital device pursuant to Part 15 of the FCC Rules. These limits are designed to provide reasonable protection against harmful interference when the equipment is operated in an industrial environment. This equipment generates, uses, and can radiate radio frequency energy and, if not installed and used in accordance with the manufacturer's instruction manual, may cause harmful interference with radio communications. Operation of this equipment in a residential area is likely to cause harmful interference, in which case you will be required to correct the interference at your own expense.

California Best Management Practices Regulations for Perchlorate Materials: This Perchlorate warning applies only to products containing CR (Manganese Dioxide) Lithium coin cells. "Perchlorate Material-special handling may apply. See www.dtsc.ca.gov/hazardouswaste/perchlorate".



The products sold by Supermicro are not intended for and will not be used in life support systems, medical equipment, nuclear facilities or systems, aircraft, aircraft devices, aircraft/emergency communication devices or other critical systems whose failure to perform be reasonably expected to result in significant injury or loss of life or catastrophic property damage. Accordingly, Supermicro disclaims any and all liability, and should buyer use or sell such products for use in such ultra-hazardous applications, it does so entirely at its own risk. Furthermore, buyer agrees to fully indemnify, defend and hold Supermicro harmless for and against any and all claims, demands, actions, litigation, and proceedings of any kind arising out of or related to such ultra-hazardous use or sale.

Manual Revision 1.0b

Release Date: August 29, 2025

Unless you request and receive written permission from Super Micro Computer, Inc., you may not copy any part of this document. Information in this document is subject to change without notice. Other products and companies referred to herein are trademarks or registered trademarks of their respective companies or mark holders.

Copyright © 2025 by Super Micro Computer, Inc.
All rights reserved.

Printed in the United States of America

Preface

About This Manual

This manual is written for system integrators, IT technicians, and knowledgeable end users. It provides information for the installation and use of the X13DEG-R motherboard.

About This Motherboard

The Supermicro X13DEG-R supports dual 5th/4th Generation Intel® Xeon® Scalable/ Intel Xeon Max series processors (in Socket E, LGA 4677) with four Ultra Path Interconnects (UPIs), up to 64 CPU cores, and a Thermal Design Power (TDP) of up to 385 W. Built with the Intel C741 chipset, the X13DEG-R supports up to 8 TB of 3DS RDIMM/RDIMM DDR5 ECC memory with speeds of up to 5600 MT/s in 32 DIMM slots (1DPC configuration). This motherboard features superior I/O expandability and flexibility. It also offers the most advanced data protection capability that provides Trusted Platform Module (TPM) 2.0 and Silicon Root of Trust (RoT) 2.0 support. The X13DEG-R is optimized for future PCIe specifications with flexible I/O, networking, storage, and Graphics Processing Unit (GPU) add-on card support. It is ideal for use in general purpose servers with 3D Rendering, Scientific Computing, High Performance Computing (HPC), Machine Learning (ML), and Virtual Desktop infrastructure (VDI). Please note that this motherboard is intended to be installed and serviced by professional technicians only. For processor/memory updates, please refer to our website at <https://www.supermicro.com/products/>.



Note 1: Memory speed support depends on the processor.

Note 2: Be sure to use processors of the same SKU on a multi-processor motherboard.

Note 3: The 5th Gen. Intel Xeon Scalable processors support four UPIs with 20 GT/s (max.). The 4th Gen. Intel Xeon Scalable processors support four UPIs with 15 GT/s (max.).

Note 4: Only the 5th Gen. Intel Xeon Scalable processor of 8593Q (for liquid cooled general purpose) supports a TDP with 385 W.

Conventions Used in the Manual

Special attention should be given to the following symbols for proper installation and to prevent damage done to the components or injury to yourself:



Important: Important information given to ensure proper system installation or to relay safety precautions.



Warning! Indicates important information given to prevent equipment/property damage or personal injury.



Warning! Indicates high voltage may be encountered while performing a procedure.



Note: Additional Information given to differentiate between various models or to provide information for proper system setup.

Contacting Supermicro

Headquarters

Address: Super Micro Computer, Inc.
980 Rock Ave.
San Jose, CA 95131 U.S.A.

Tel: +1 (408) 503-8000

Fax: +1 (408) 503-8008

Email: marketing@supermicro.com (General Information)
Sales-USA@supermicro.com (Sales Inquiries)
Government_Sales-USA@supermicro.com (Gov. Sales Inquiries)
support@supermicro.com (Technical Support)
RMA@supermicro.com (RMA Support)
Webmaster@supermicro.com (Webmaster)

Website: www.supermicro.com

Europe

Address: Super Micro Computer B.V.
Het Sterrenbeeld 28, 5215 ML
's-Hertogenbosch, The Netherlands

Tel: +31 (0) 73-6400390

Fax: +31 (0) 73-6416525

Email: Sales_Europe@supermicro.com (Sales Inquiries)
Support_Europe@supermicro.com (Technical Support)
RMA_Europe@supermicro.com (RMA Support)

Website: www.supermicro.nl

Asia-Pacific

Address: Super Micro Computer, Inc.
3F, No. 150, Jian 1st Rd.
Zhonghe Dist., New Taipei City 235
Taiwan (R.O.C)

Tel: +886-(2) 8226-3990

Fax: +886-(2) 8226-3992

Email: Sales-Asia@supermicro.com.tw (Sales Inquiries)
Support@supermicro.com.tw (Technical Support)
RMA@supermicro.com.tw (RMA Support)

Website: www.supermicro.com.tw

Table of Contents

Chapter 1 Introduction

1.1 Checklist	8
1.2 Processor and Chipset Support	18
1.3 Special Features	19
1.4 System Health Monitoring	19
1.5 ACPI Features	20
1.6 Power Supply	20
1.7 System Reboot.....	20

Chapter 2 Installation

2.1 Static-Sensitive Devices.....	21
2.2 Processor Installation and Removal.....	22
2.3 Motherboard Installation.....	33
2.4 Memory Support and Installation	35
2.5 Front Control Panel.....	41
2.6 I/O Connections.....	47
2.7 Connectors and Headers	48
2.8 Jumper Settings	55
2.9 LED Indicators.....	58

Chapter 3 Troubleshooting

3.1 Troubleshooting Procedures	61
3.2 Technical Support Procedures	64
3.3 Frequently Asked Questions	65
3.4 Battery Removal and Installation	66
3.5 Returning Merchandise for Service.....	67

Chapter 4 UEFI BIOS

4.1 Introduction.....	68
4.2 Main Setup	69
4.3 Advanced Setup Configurations.....	71
4.4 Event Logs	123
4.5 BMC.....	125
4.6 Security.....	129

4.7 Boot	136
4.8 Save & Exit.....	138

Appendix A BIOS POST Codes

A.1 BIOS POST Codes.....	140
--------------------------	-----

Appendix B Software

B.1 Microsoft Windows OS Installation.....	141
B.2 Driver Installation.....	143
B.3 BMC.....	144
B.4 Logging into the BMC (Baseboard Management Controller).....	144

Appendix C Standardized Warning Statements

Chapter 1

Introduction

Congratulations on purchasing your computer motherboard from an industry leader. Supermicro motherboards are designed to provide you with the highest standards in quality and performance.

1.1 Checklist

This motherboard is intended to be used in a Supermicro proprietary server as a part of an integrated solution. It will not be shipped as a standard, independent product. There will be no shipping package provided for this motherboard.

Important Links

For your motherboard to work properly, please follow the links below to download all necessary drivers/utilities and the user's manual for your computer.

- Supermicro product manuals: <https://www.supermicro.com/support/manuals/>
- Product drivers and utilities: <https://www.supermicro.com/wdl/driver>
- Product safety info: https://www.supermicro.com/about/policies/safety_information.cfm
- A secure data deletion tool designed to fully erase all data from storage devices can be found at our website: https://www.supermicro.com/about/policies/disclaimer.cfm?url=/wdl/utility/Lot9_Secure_Data_Deletion_Utility/
- Firmware-related and AOC user's guides: <https://www.supermicro.com/support/manuals/>
- If you have any questions, please contact our support team at: support@supermicro.com

This manual may be periodically updated without notice. Please check the Supermicro website for possible updates to the manual revision level.

X13DEG-R Motherboard Image

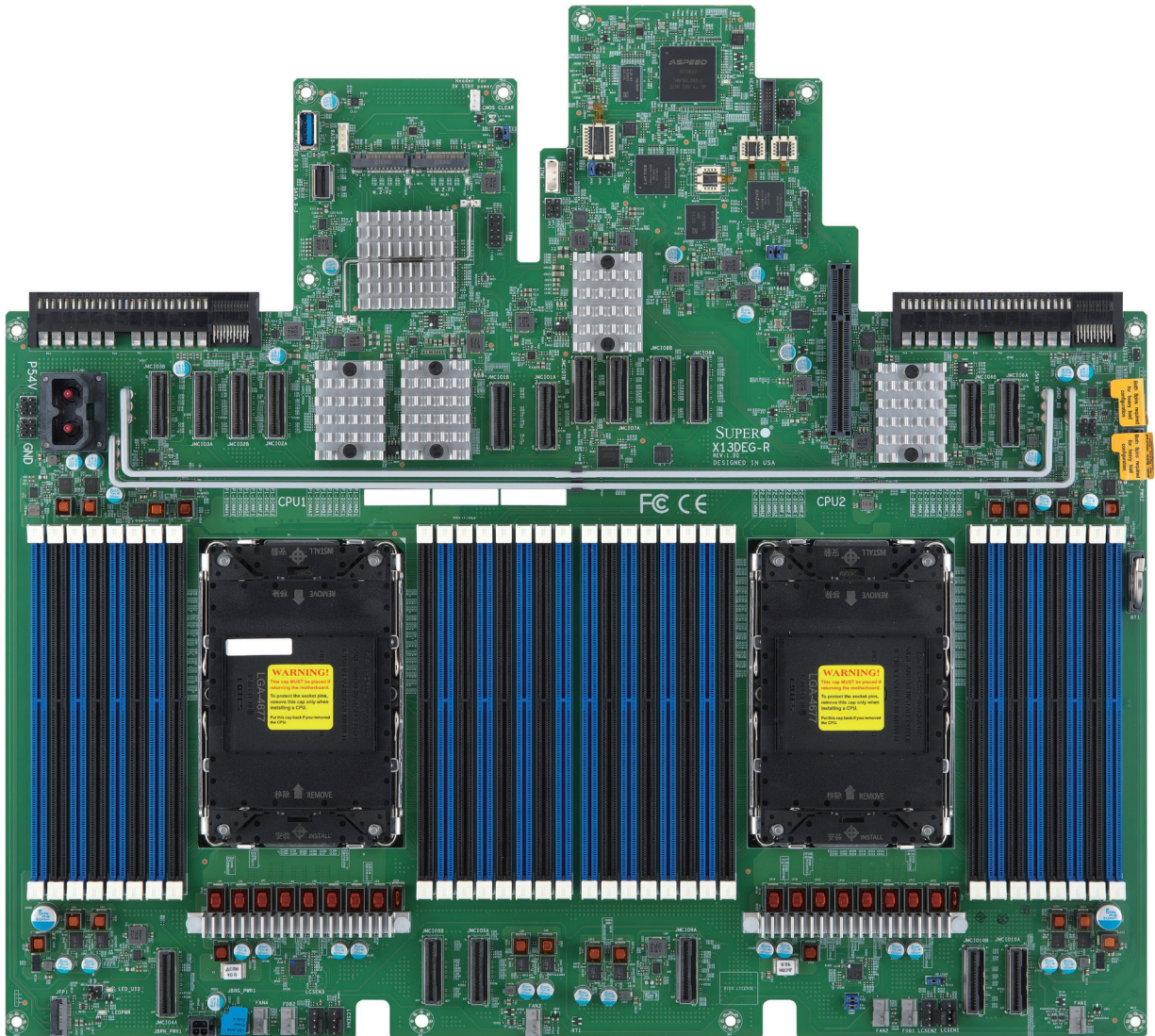

 **Note:** All graphics shown in this manual were based upon the latest PCB revision available at the time of publication of the manual. The motherboard you received may or may not look exactly the same as the graphics shown in this manual.

X13DEG-R Motherboard Layout (not drawn to scale)

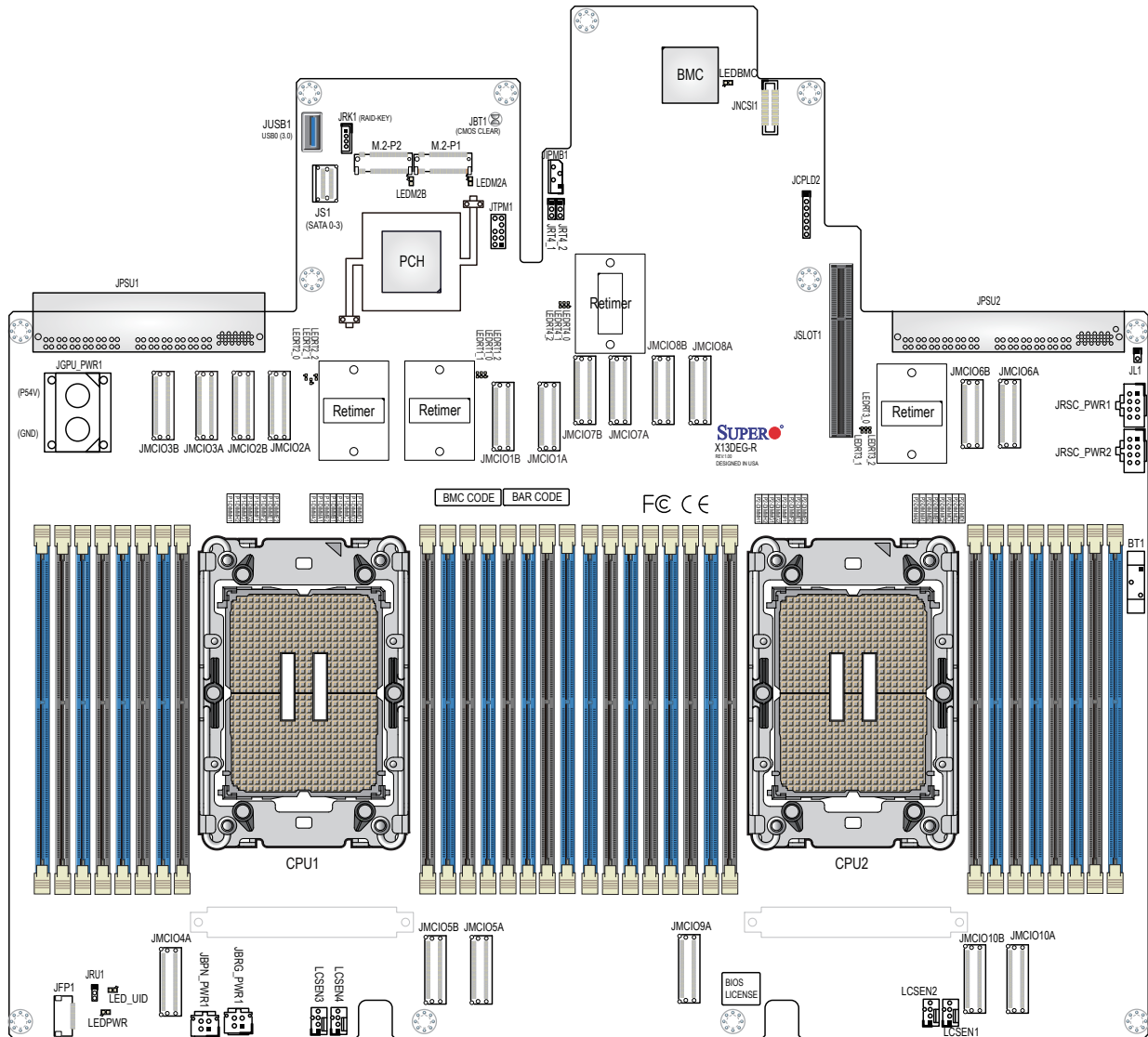

 **Note:** Components not documented are for internal testing only.

Quick Reference

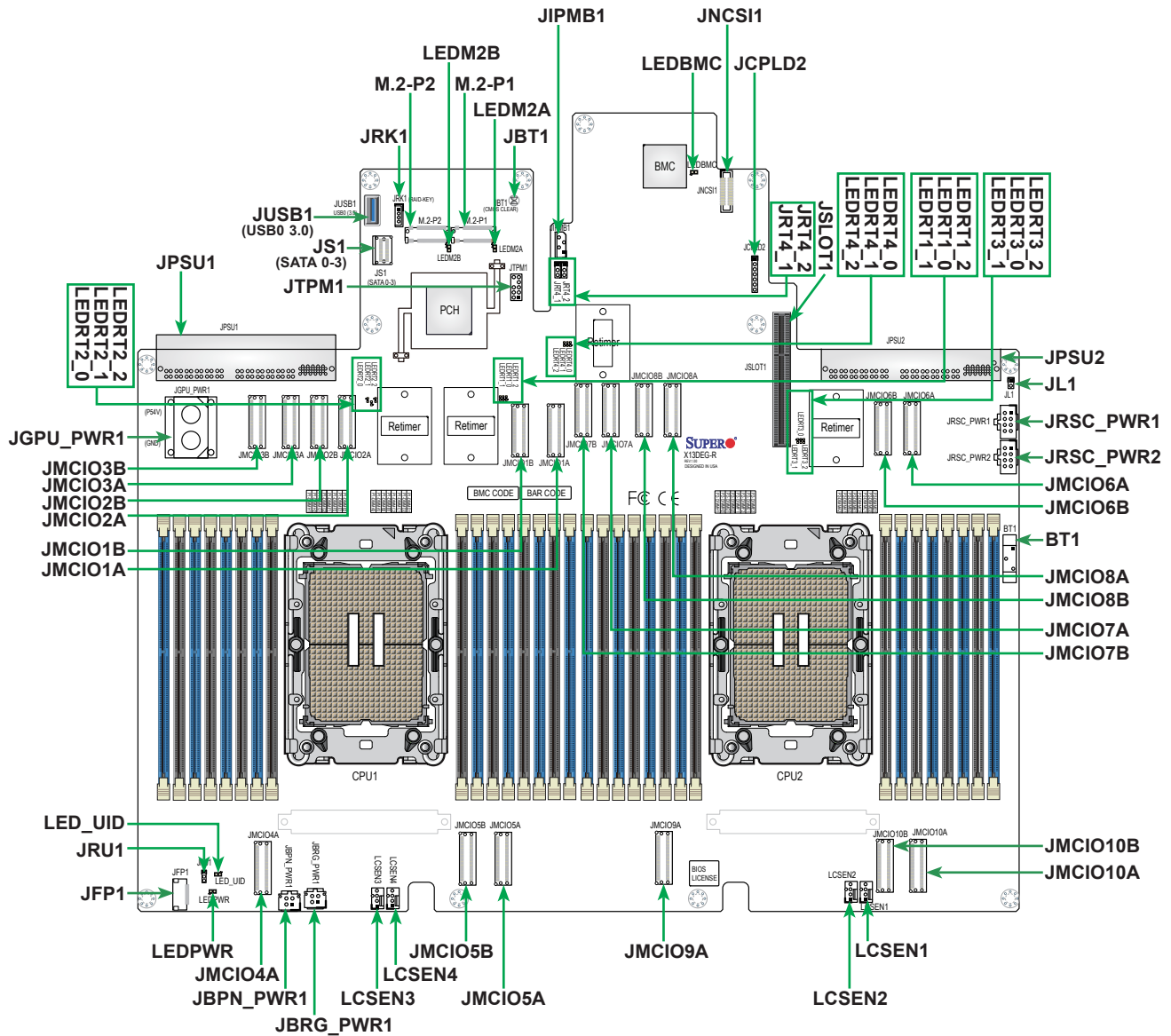

Notes:

- See Chapter 2 for detailed information on jumpers, I/O ports, and JF1 front panel connections.
- "■" indicates the location of Pin 1.
- Jumpers/LED indicators not indicated are used for testing only.
- Use only the correct type of onboard CMOS battery as specified by the manufacturer. Do not install the onboard battery upside down to avoid a possible explosion.

Quick Reference Table

Jumper	Description	Default Setting
JBT1	CMOS Clear	Open (Normal)
JRU1	UID Swtich/BMC Reset/System Reset	Pins 1-2: System Reset Pins 2-3: UID Swtich/BMC Reset (Default)

LED	Description	Status
LED_UID	Unit Identifier (UID) LED	Solid Blue: Unit Identified
LEDBMC	BMC Heartbeat LED	Blinking Green: BMC Normal (Active) Solid Green: During BMC Reset or during a Cold Reboot
LEDM2A, LEDM2B	M.2 LEDs	Blinking Green: Device Working
LEDPWR	Power LED	LED On: Onboard Power On
LEDRT1_0, LEDRT1_1, LEDRT1_2	Retimer Status LED	Working Normally when LEDRT1_0 (Solid On), LEDRT1_1 (Blinking), and LEDRT1_2 (Solid On)
LEDRT2_0, LEDRT2_1, LEDRT2_2	Retimer Status LED	Working Normally when LEDRT2_0 (Solid On), LEDRT2_1 (Blinking), and LEDRT2_2 (Solid On)
LEDRT3_0, LEDRT3_1, LEDRT3_2	Retimer Status LED	Working Normally when LEDRT3_0 (Solid On), LEDRT3_1 (Blinking), and LEDRT3_2 (Solid On)
LEDRT4_0, LEDRT4_1, LEDRT4_2	Retimer Status LED	Working Normally when LEDRT4_0 (Solid On), LEDRT4_1 (Blinking), and LEDRT4_2 (Solid On)

Connector	Description
BT1	Onboard CMOS Battery
JBPN_PWR1	4-pin Power Connector to the Storage Backplane
JBRG_PWR1	4-pin Power Connector to the GPU Transition Board
JCPLD2	Complex Programmable Logic Device (CPLD) Header
JFP1	Front Control Panel Header
JGPU_PWR1	Power Connector for the GPU Module
JIPMB1	4-pin BMC External I ² C Header
JL1	Chassis Intrusion Header
JMCIO1A, JMCIO1B, JMCIO2A, JMCIO2B, JMCIO6A, JMCIO6B, JMCIO7A, JMCIO7B	PCIe 5.0 x8 MCIO Connectors for the GPU Transition Board
JMCIO3A, JMCIO3B, JMCIO5A, JMCIO5B, JMCIO8A, JMCIO8B, JMCIO10A, JMCIO10B	PCIe 5.0 x8 MCIO Connectors for Riser Cards

 **Note:** For details on how to configure Network Interface Card (NIC) settings, please refer to the Network Interface Card Configuration User's Guide posted on our website under the link: <https://www.supermicro.com/support/manuals/>.

Connector	Description
JMCIO4A, JMCIO9A	PCIe 5.0 x8 MCIO Connectors for Storage Devices
JNCSI1	Network Controller Sideband Interface (NC-SI) Connector
JPSU1, JPSU2	5.25 Kilowatt (KW) Power Supply Unit Connectors
JRK1	Intel VROC Key Header for NVMe RAID support * The Intel VROC solution is used for NVMe/SATA drives to create RAID arrays and only supported on the CPU/PCH with the Intel VMD technology. It is NOT able to cross VMDs when creating a boot RAID. The data RAID is allowed to cross VMDs and processors.
JRSC_PWR1, JRSC_PWR2	8-pin Riser Card Power Connectors
JS1 (SATA 0-3)	SlimSAS LP PCIe x4 Connector with support of four Intel PCH SATA 3.0 connections (6 Gb/second, support RAID 0/1/5/10)
JSLOT1	AOM Riser Card Slot (with support of the AOM-PTG-I2T riser card installed to provide connections of one dedicated BMC LAN port, two USB 3.0 ports, one VGA header, one COM header, and dual 10 GbE LAN ports)
JTPM1	Trusted Platform Module/Port 80 Connector
JUSB1 (USB0)	Internal USB 3.0 Vertical Type-A Connector
LCSEN1 – LCSEN4	Leakage Sensor Board Connectors
M.2-P1, M.2-P2	PCIe 3.0 x4 NVMe M.2 Slots (with support of M-Key 2280/22110) * The devices connected to the two M.2 slots can NOT be used to create the Intel VROC RAID arrays.



Note: For detailed instructions on how to configure VROC RAID settings, please refer to the VROC RAID Configuration User's Guide posted on the web page under the link: <https://www.supermicro.com/support/manuals/>.



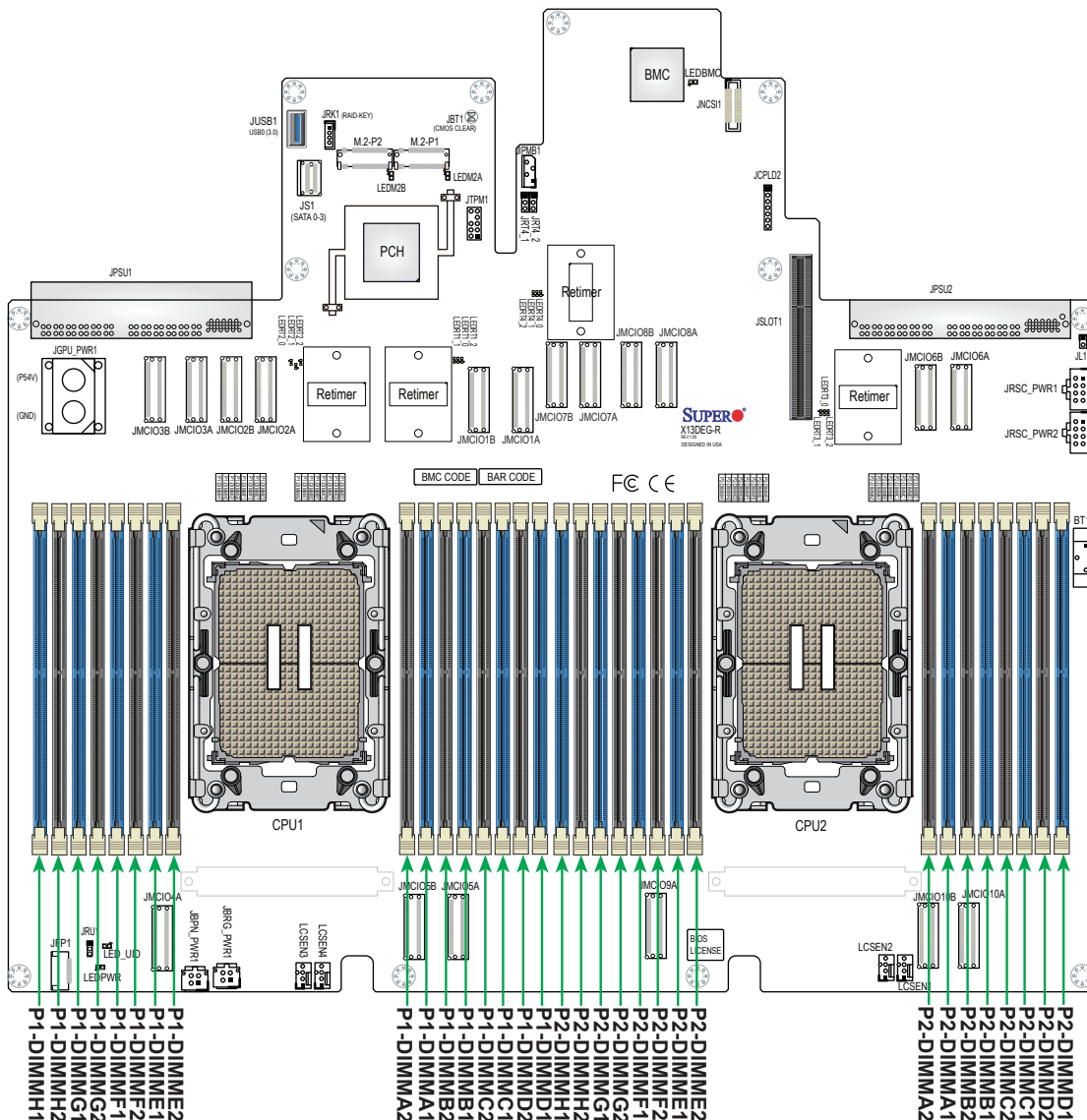

Memory Slots

This motherboard contains 32 DIMM slots to support up to 8 TB of DDR5 memory. Please refer to the layout below for the locations of DIMM slots.

DIMM Slots Supported by CPU1	DIMM Slots Supported by CPU2
P1-DIMMA1 / P1-DIMMA2	P2-DIMMA1 / P2-DIMMA2
P1-DIMMB1 / P1-DIMMB2	P2-DIMMB1 / P2-DIMMB2
P1-DIMMC1 / P1-DIMMC2	P2-DIMMC1 / P2-DIMMC2
P1-DIMMD1 / P1-DIMMD2	P2-DIMMD1 / P2-DIMMD2
P1-DIMME1 / P1-DIMME2	P2-DIMME1 / P2-DIMME2
P1-DIMMF1 / P1-DIMMF2	P2-DIMMF1 / P2-DIMMF2
P1-DIMMG1 / P1-DIMMG2	P2-DIMMG1 / P2-DIMMG2
P1-DIMMH1 / P1-DIMMH2	P2-DIMMH1 / P2-DIMMH2



Motherboard Features

Motherboard Features	
CPU	
<ul style="list-style-type: none"> Supports dual 5th/4th Gen. Intel Xeon Scalable/ Intel Xeon Max series processors (in Socket E LGA 4677) with four UPIs (20 GT/s max.) with up to 64 CPU cores and a Thermal Design Power (TDP) of up to 385 W 	<p> Note 1: Be sure to use processors of the same SKU on a multi-processor motherboard.</p> <p> Note 2: For the 4th Gen. Intel Xeon Scalable processors, CPU Bronze-3xxx and -U (3408U/5412U/6414U) are for the single socket motherboards only. You can also use the following CPU SKUs for a single socket motherboard: 8461V for SaaS/ 5411N/ 6421N/ 8471N for 5G networking.</p> <p>Note 3: For the 4th Gen. Intel Xeon Scalable processors, CPU -H can support the motherboards with a single socket to eight sockets. The 84xxH (8S) and 64xxH (4S) support the X13 dual sockets motherboards/systems.</p> <p>Note 4: Only the 5th Gen. Intel Xeon Scalable processor of 8593Q (for liquid cooled general purpose) supports a TDP with 385 W.</p> <p>Note 5: Please refer to the Intel ARK website for detailed information at https://ark.intel.com/content/www/us/en/ark/products/series/228622/4th-generation-intel-xeon-scalable-processors.html.</p>
Memory	
<ul style="list-style-type: none"> Supports up to 8 TB of 3DS RDIMM/RDIMM DDR5 (288-pin) ECC memory with speeds of up to 5600 MT/s (1DPC) in 32 DIMM slots 	<p> Note: Memory speed and capacity support depends on the processor.</p>
DIMM Size	
<ul style="list-style-type: none"> Up to 256 GB at 1.1 V 	<p> Note: For the latest CPU/memory updates, please refer to our website at https://www.supermicro.com/products/motherboard.</p>
Chipset	
<ul style="list-style-type: none"> Intel C741 	
Expansion Slots	
<ul style="list-style-type: none"> Eight PCIe 5.0 x8 MCIO Connectors for GPU Devices Eight PCIe 5.0 x8 MCIO Connectors for Riser Cards Two PCIe 5.0 x8 MCIO Connectors for NVMe Devices Two PCIe 3.0 x4 NVMe M.2 slots (support M-Key 2280/2211) 	
Baseboard Management Controller (BMC)/Network	
<ul style="list-style-type: none"> ASPEED AST2600 BMC 	
Graphics	
<ul style="list-style-type: none"> Graphics controller and VGA support via ASPEED AST2600 BMC 	
I/O Devices	
<ul style="list-style-type: none"> One SlimSAS LP connector (JS1) with support of four Intel PCH SATA 3.0 connections (SATA0–3, RAID 0/1/5/10 supported) One AOM riser card slot (JSLOT1) with support of the AOM-PTG-I2T riser card installed to provide connections of one dedicated BMC LAN port, two USB 3.0 ports, one VGA header, one COM header, and dual 10 GbE LAN ports 	

<p>Peripheral Devices</p> <ul style="list-style-type: none"> • One internal USB 3.0 Vertical Type-A connector (JUSB1) on the motherboard
<p>BIOS</p> <ul style="list-style-type: none"> • AMI SPI BIOS • EFI GUI, SPI dual/quad speed control, Real Time Clock (RTC) wakeup, IPMIView, SMCIPMITOOL, IPMI CFG, Redundant power supply unit detection, SPM, SUM-OOB/InBand
<p>Power Management</p> <ul style="list-style-type: none"> • ACPI power management • S1, S4, S5 support • Power button override mechanism • Power-on mode for AC power recovery • Power supply monitoring
<p>System Health Monitoring</p> <ul style="list-style-type: none"> • Onboard voltage monitoring for +12 V, +5 V / +5 V standby, +3.3 V, and +3.3 V standby, Vcore, Vmem • Onboard temperature monitoring for CPU, VRM, LAN, PCH, system, and memory • 7+1 CPU switch phase voltage regulator • CPU thermal trip support • Platform Environment Control Interface (PECI)
<p>Fan Control</p> <ul style="list-style-type: none"> • Fan status monitored by BMC connection via the FAN board
<p>System Management</p> <ul style="list-style-type: none"> • Chassis intrusion header and detection • Server platform service
<p>Firmware Integrity/System Security</p> <ul style="list-style-type: none"> • Trusted Platform Module (TPM) support (TPM 9672) • Root of Trust (RoT) support to protect firmware security by detecting critical data corruption, and restoring platform integrity
<p>LED Indicators</p> <ul style="list-style-type: none"> • Power LED • UID/remote LED • BMC/CPLD firmware LED • Re-timer status LEDs
<p>Dimensions</p> <ul style="list-style-type: none"> • 17.3" (W) x 15.7" (L) (440 mm x 399 mm)



Note 1: The CPU maximum TDP is subject to chassis and heatsink cooling restrictions. For proper thermal management, please check the chassis and heatsink specifications.

Note 2: For BMC configuration instructions, please refer to the Embedded BMC Configuration User's Guide available at <https://www.supermicro.com/support/manuals/>.

X13DEG-R

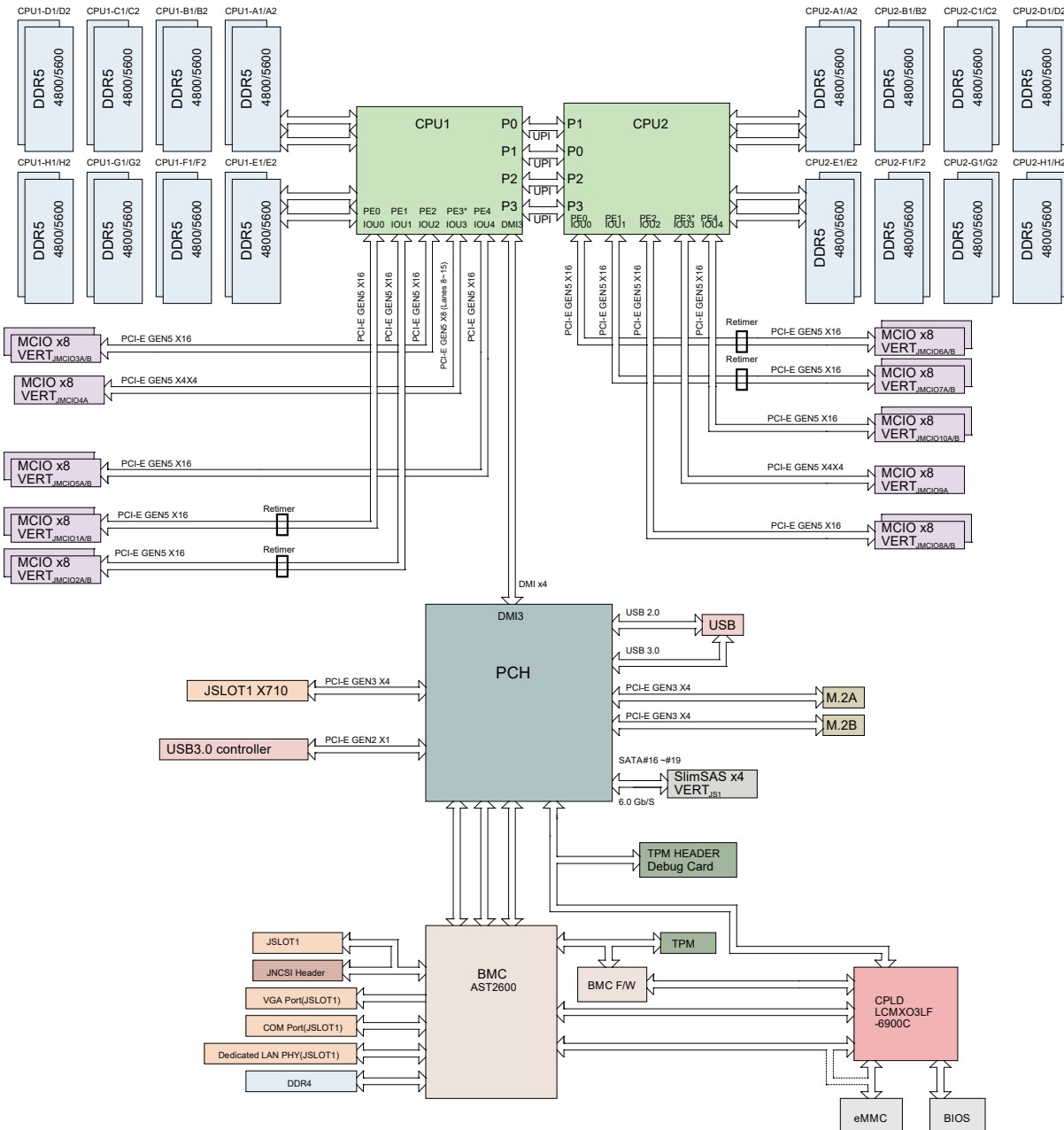

System Block Diagram

 **Note:** This is a general block diagram and may not exactly represent the features on your motherboard. See the previous pages for the actual specifications of your motherboard.

1.2 Processor and Chipset Support

Built upon the functionality and capability of the 5th/4th Gen. Intel Xeon Scalable and Intel Xeon Max series processors (Socket E, LGA4677), and the Intel C741 chipset, the X13DEG-R motherboard offers critical, pivotal technological breakthroughs that unleash unprecedented computing capabilities and provides a scalable platform optimized for applications used in Artificial Intelligence (AI) Acceleration, Deep Learning Boost, Network Interconnectivity, and Platform Manageability technologies. The key features supported by the platform include the following:

Processor Features Supported

- Increased, scalable performance with substantial advancements, including UPI speed improvement, memory speed/capacity/utilization enhancement, hardware-based security innovations for virtualization, and platform interconnectivity optimization
- Integrated accelerators optimized for workload enhancement including Advanced Matrix Extensions (IntelAMX), In-Memory Analytics Accelerator (IAX), Data Streaming Accelerator (IntelDSA), and QuickAssist Technology (Intel QAT)



Note: For the needed drivers to support the Intel QAT function, please visit <https://www.intel.com/content/www/us/en/developer/topic-technology/open/quick-assist-technology/overview.html>.

- Breakthroughs in memory and I/O support, including DDR5 (5600 MT/s max., depending on the processor), HBM (with 1 TB bandwidth max.), PCIe 5.0 (80 lanes max.), and CXL 1.1 (four devices per CPU)
- Increased operational and performance efficiency with substantial enhancements in virtualization, network security, and telemetry and power management
- Integrated AI accelerators with support of 3rd Gen. Intel Deep Learning Boost and new Tile Matrix Multiply (AMX/MUL)
- Enhanced Intel Security Boost Software Guard Extensions with Integrity Platform Firmware Resilience support
- Intel Ultra Path Interconnect (Intel UPI) up to four links per processor at 20 GT/s max. (depending on the processor)
- New Compute Express Link (CXL) and Intel Speed Select Technology
- CPU with 52 physical address/57 virtual address support

PCH Features Supported

- Flexible I/O at 20 lanes for PCIe 3.0, 1 G Ethernet in PCH for manageability, and eight DMIs at PCIe 3.0

1.3 Special Features

Recovery from AC Power Loss

The Basic I/O System (BIOS) provides a setting that determines how the system will respond when AC power is lost and then restored to the system. You can choose for the system to remain powered off (in which case you must press the power switch to turn it back on), or for it to automatically return to the power-on state. See the Advanced BIOS Setup section for this setting. The default setting is **Last State**.

1.4 System Health Monitoring

Onboard Voltage Monitors

An onboard voltage monitor will scan the voltages of the onboard chipset, memory, and CPU continuously. Once a voltage becomes unstable, a warning is given, or an error message is sent to the screen.

Fan Status Monitor with Firmware Control

The system health monitor embedded in the BMC chip can check the RPM status of the cooling fans. The CPU and chassis fans are controlled via BMC.

Environmental Temperature Control

System Health sensors monitor temperatures and voltage settings of onboard processors and the system in real time via the BMC interface. Whenever the temperature of the CPU or the system exceeds Supermicro's pre-defined threshold, the system and CPU cooling fan speed will increase to prevent the CPU or system from overheating.

 **Note:** To avoid possible system overheating, please be sure to provide adequate air-flow to your system.

1.5 ACPI Features

ACPI stands for Advanced Configuration and Power Interface. The ACPI specification defines a flexible and abstract hardware interface that provides a standard way to integrate power management features throughout a computer system, including its hardware, operating system and application software. This enables the system to automatically turn on and off peripherals such as network cards, hard disk drives, and printers.

In addition to enabling operating system-directed power management, ACPI also provides a generic system event mechanism for Plug and Play, and an operating system-independent interface for configuration control. ACPI leverages the Plug and Play BIOS data structures, while providing a processor architecture-independent implementation that is compatible with appropriate Windows operating systems. For detailed information regarding OS support, please refer to the Supermicro website.

1.6 Power Supply

As with all computer products, a stable power source is necessary for proper and reliable operation. It is even more important for processors that have high CPU clock rates where noisy power transmission is present.

Several busbars from power distribution boards provide power to the X13DEG-R motherboard. The power distribution boards in the system are connected to Supermicro proprietary power supplies.

It is strongly recommended that you only use Supermicro approved redundant power supply units for the Supermicro system chassis.

1.7 System Reboot

This motherboard, Intended to be used in a Supermicro GPU server, supports an innovative cooling technology, which will continue cooling down the system even after shutting down. After the system is shutdown, the power button LED on the front panel will start to blink green, indicating that the cooling procedure is in progress. This cooling procedure will take 120 seconds to complete. When the procedure is complete, the power button LED will turn solid amber. We recommend the user to allow this cooling procedure to complete before issuing a power-on command or removing power cable(s) from the system.

Chapter 2

Installation

2.1 Static-Sensitive Devices

Electrostatic Discharge (ESD) can damage electronic components. To avoid damaging your motherboard, it is important to handle it very carefully. The following measures are generally sufficient to protect your equipment from ESD.

Precautions

- Use a grounded wrist strap designed to prevent static discharge.
- Touch a grounded metal object before removing the motherboard from the antistatic bag.
- Handle the motherboard by its edges only; do not touch its components, peripheral chips, memory modules or gold contacts.
- When handling chips or modules, avoid touching their pins.
- Put the motherboard and peripherals back into their antistatic bags when not in use.
- For grounding purposes, make sure that your computer chassis provides excellent conductivity between the power supply, the case, the mounting fasteners and the motherboard.
- Use only the correct type of onboard CMOS battery. Do not install the onboard battery upside down to avoid a possible battery explosion.
- When installing the processor, ensure a torque driver set to the correct force is used for each screw.

Unpacking

The motherboard is shipped in antistatic packaging to avoid static damage. When unpacking the motherboard, make sure that the person handling it is static protected.

2.2 Processor Installation and Removal

The processor (CPU) and processor carrier should be assembled together first to form the processor carrier assembly. This assembly will be then attached to the heatsink to form the processor heatsink module (PHM) before being installed into the CPU socket. Before installation, be sure to perform the following steps:

- Please carefully follow the instructions given on the previous page to avoid ESD-related damages.
- Unplug the AC power cords from all power supplies after shutting down the system.
- Check that the plastic protective cover is on the CPU socket, and none of the socket pins are bent. If they are, contact your retailer.
- When handling the processor, avoid touching or placing direct pressure on the LGA lands (gold contacts). Improper installation or socket misalignment can cause serious damage to the processor or CPU socket, which may require manufacturer repairs.
- Refer to the Supermicro website for updates on processor and memory support.
- All graphics in this manual are for illustrations only. Your components may look different.

The 5th/4th Gen. Intel Xeon Scalable Processors (Top View)

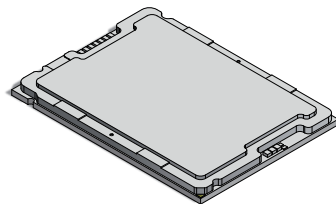

Xeon Scalable Processor (SP) XCC

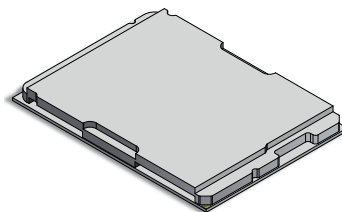

Xeon Scalable Processor (SP) MCC

The Intel Xeon Max Processor (Top View)

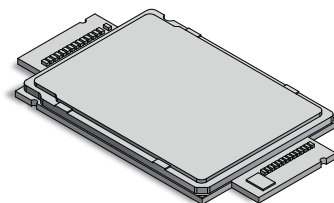

Xeon Max

1. The 5th/4th Gen. Intel Xeon Scalable Processors and the Intel Xeon Max Processor

Processor Top View

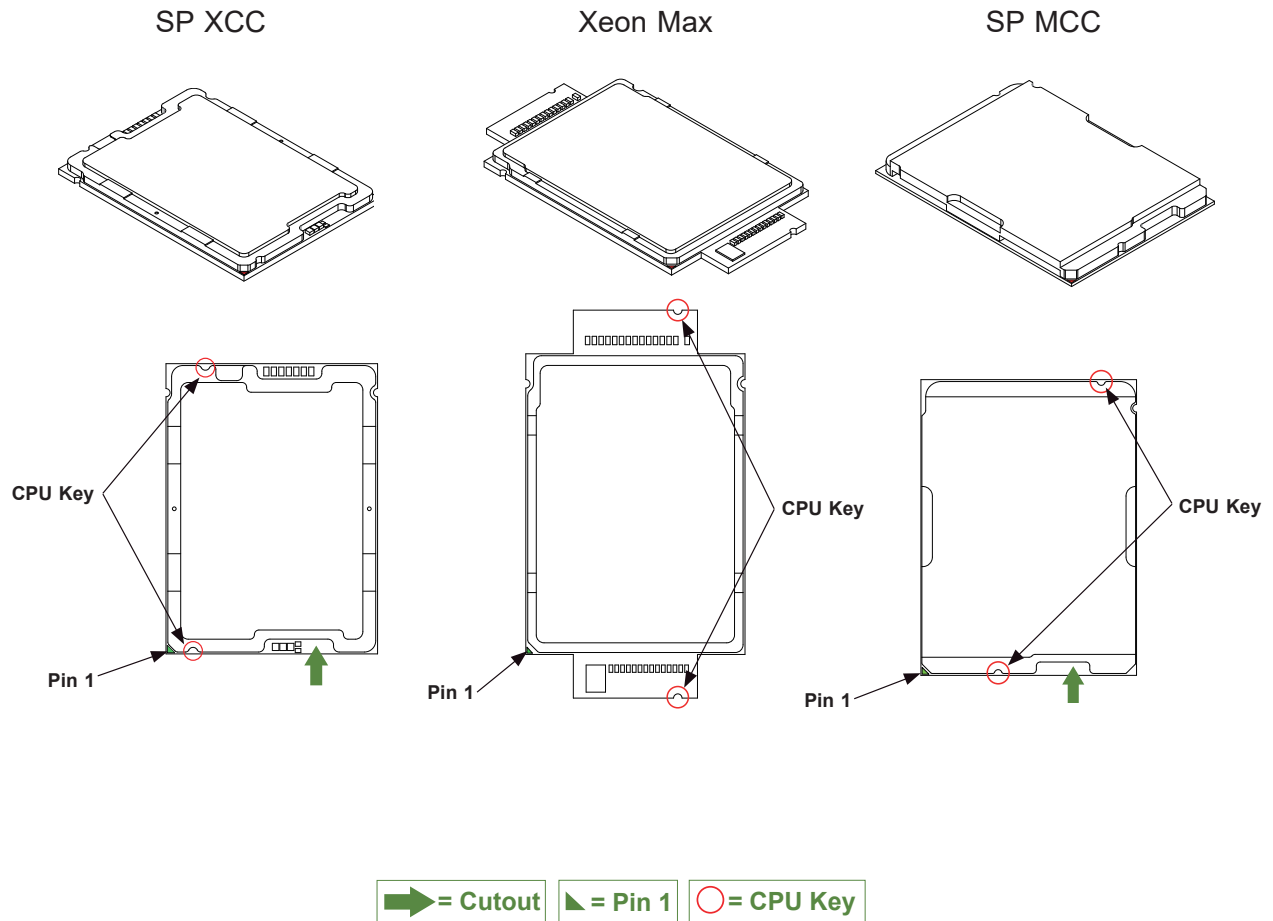

2. The Processor Carrier

Carrier E1A

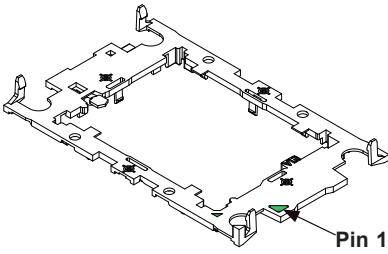

Carrier E1C

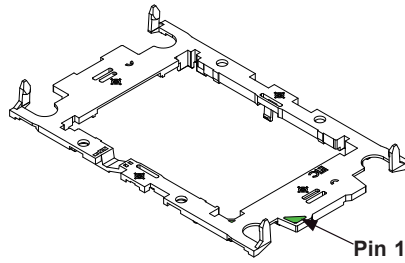

Carrier E1B

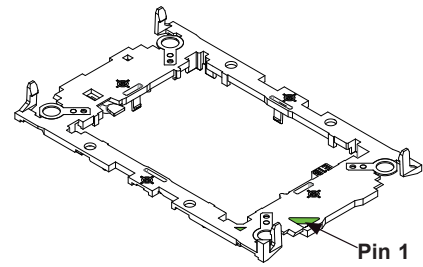

Carrier Top View

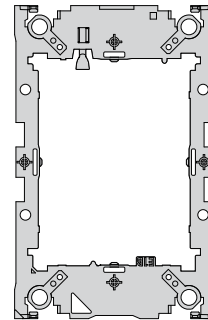
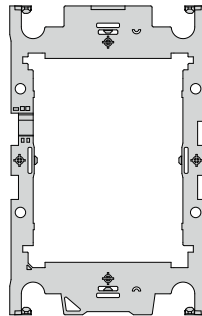
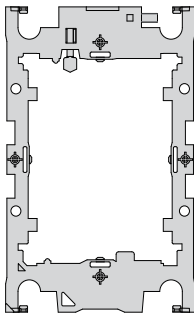

Carrier Bottom View

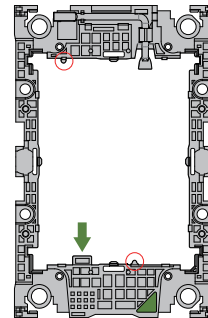
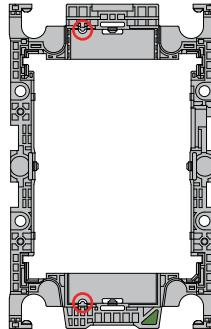
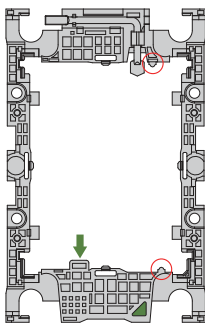

Overview of the CPU Socket

The CPU socket is protected by a plastic protective cover.

Plastic Protective Cover

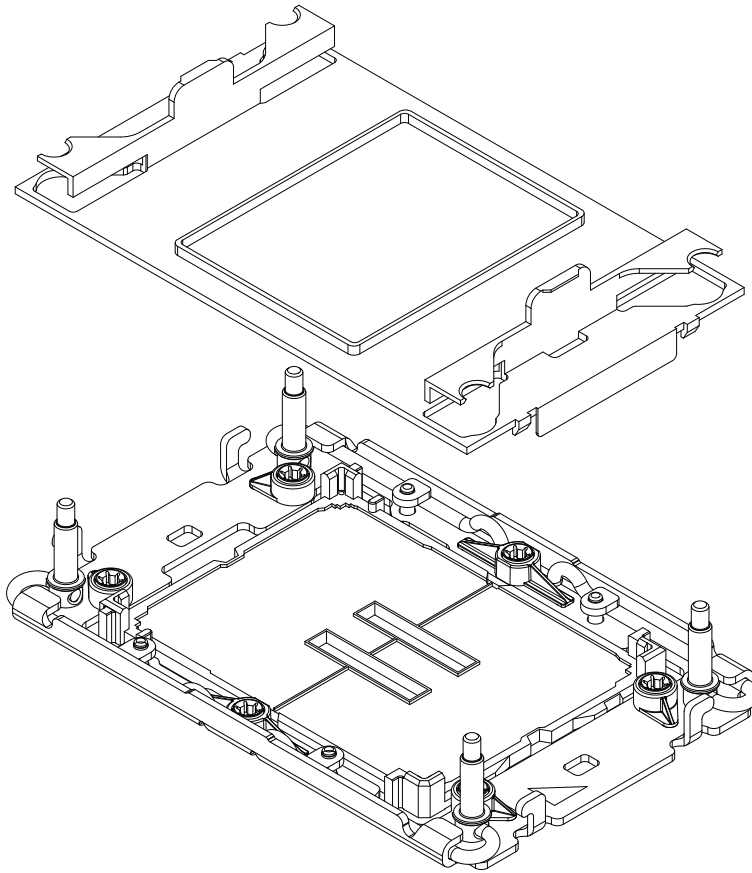

CPU Socket

Preparing the CPU Socket for Installation

This motherboard comes with a plastic protective cover installed on the CPU socket. Remove it from the socket by following the instructions below.

1. Press the tabs inward.

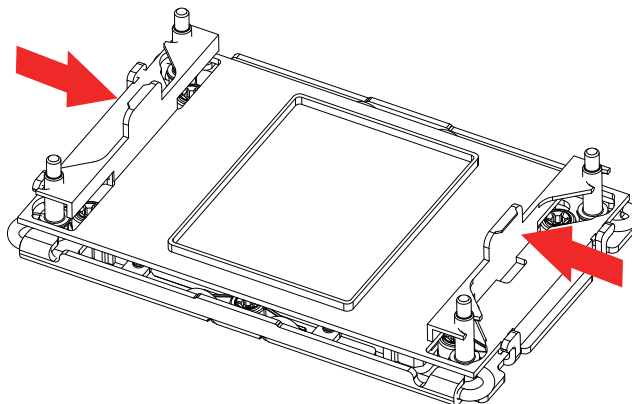

2. Pull up the protective cover from the socket.

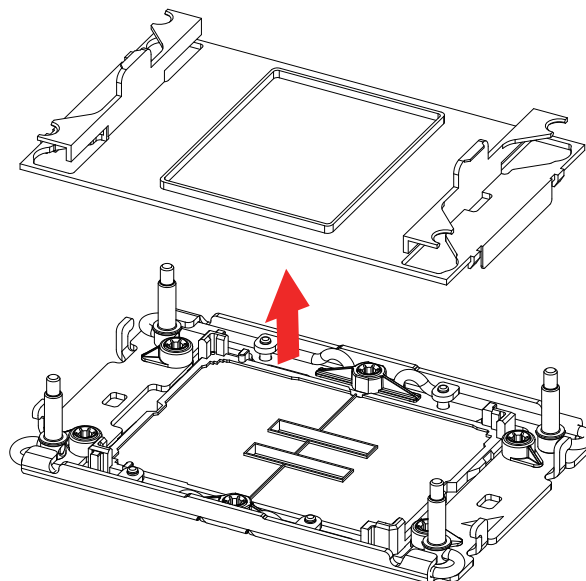

Overview of the Processor Carrier Assembly

The processor carrier assembly contains a processor and a processor carrier. Carefully follow the instructions given in the installation section to place a processor into the carrier to create a processor carrier assembly.

The processor carrier assembly includes a processor and a processor carrier as shown below.

1. The 5th/4th Gen. Intel Xeon Scalable Processors and the Intel Xeon Max Processor (Component Side)

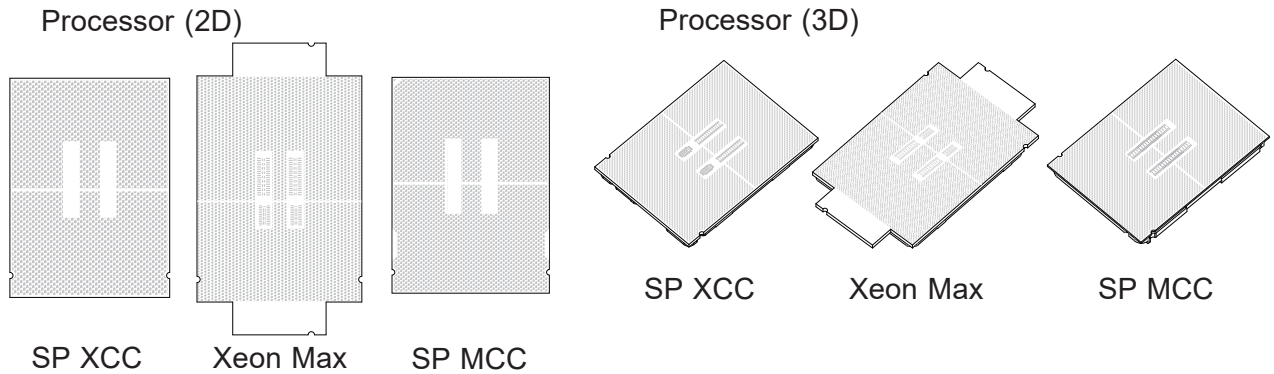

2. Processor Carrier (Top View)

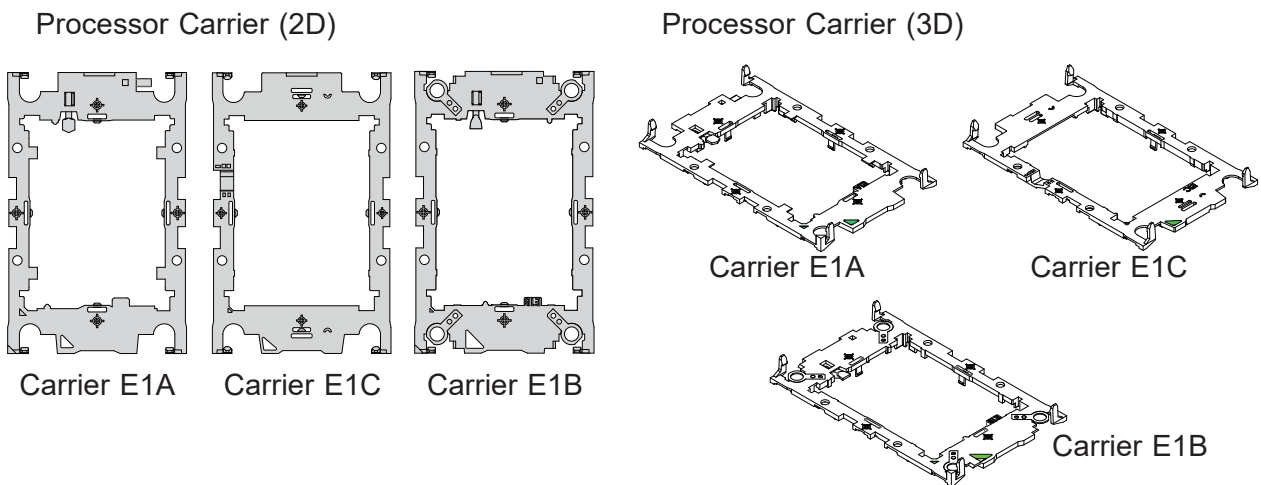

3. Processor Carrier Assembly (with processor seated inside the carrier)

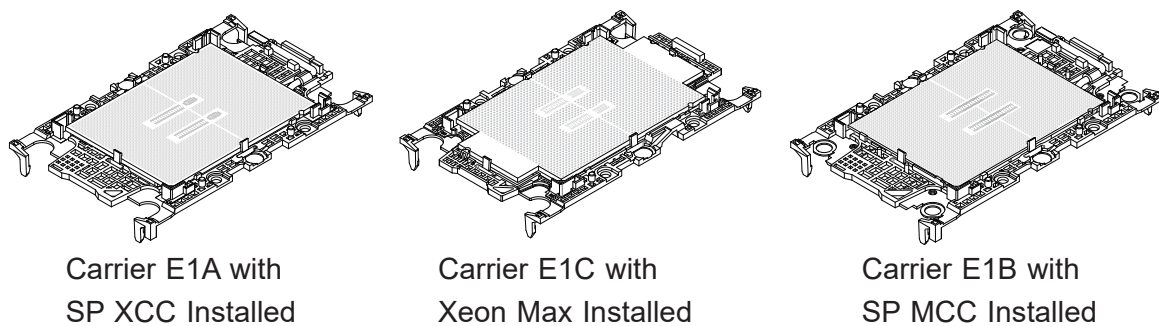

Creating the Processor Carrier Assembly

The processor carrier assembly contains a processor and a processor carrier.

To create the processor carrier assembly, please follow the steps below.

 **Note:** Before installation, be sure to follow the instructions given on pages 1 and 2 of this chapter to properly prepare for installation.

1. Hold the processor with the component side (including the gold contacts) facing down. Locate the small, gold triangle at the corner of the processor and the corresponding hollowed triangle on the processor carrier as shown below. Please note that the triangle indicates the location of Pin 1.

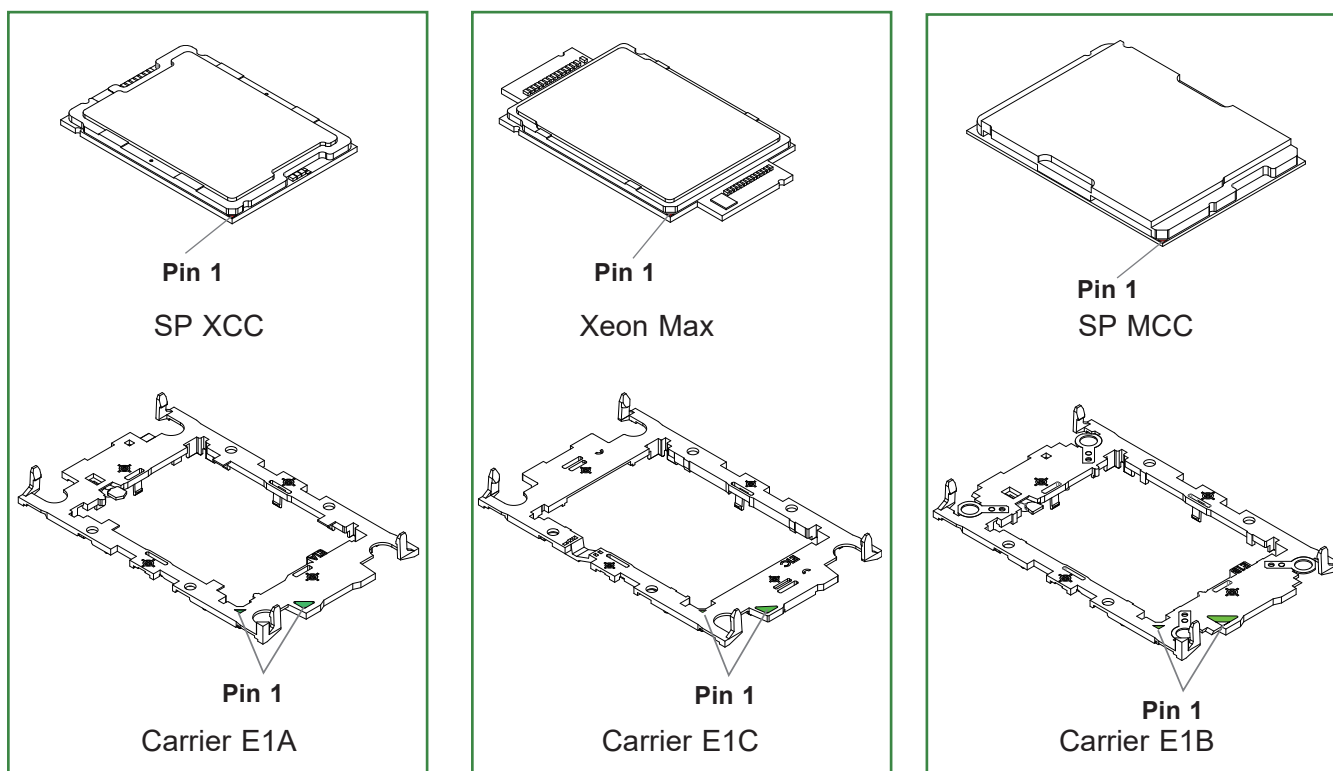

Processor with Matching Carrier

2. First, turn over the processor carrier and locate Pin 1 on the CPU and Pin 1 on the carrier. Then, turn the processor over with component side (including the gold contacts) facing up and locate CPU keys on the processor. Finally, locate the CPU keys and four latches on the carrier as shown below.

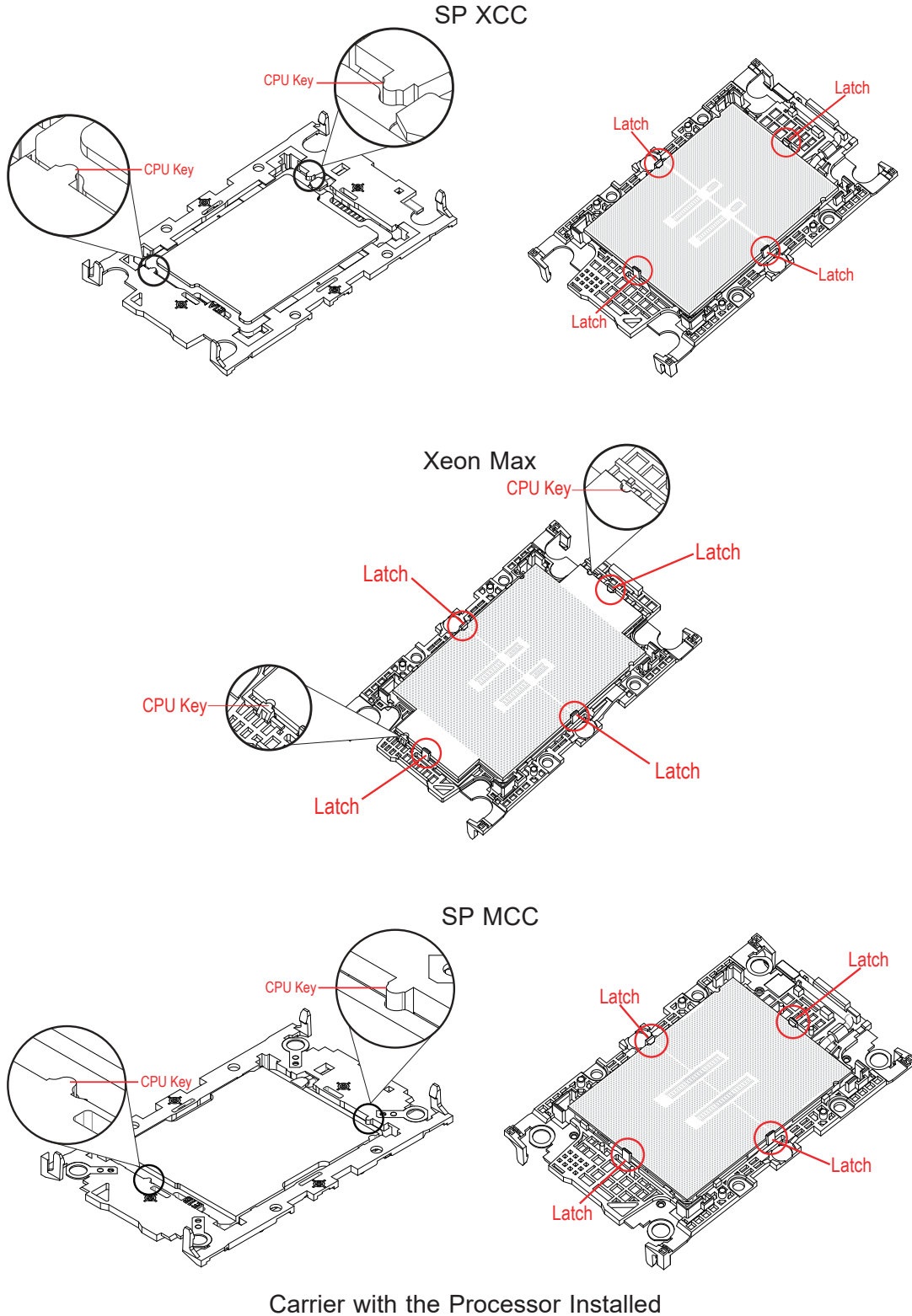

3. Locate the lever on the CPU socket and press it down as shown below.

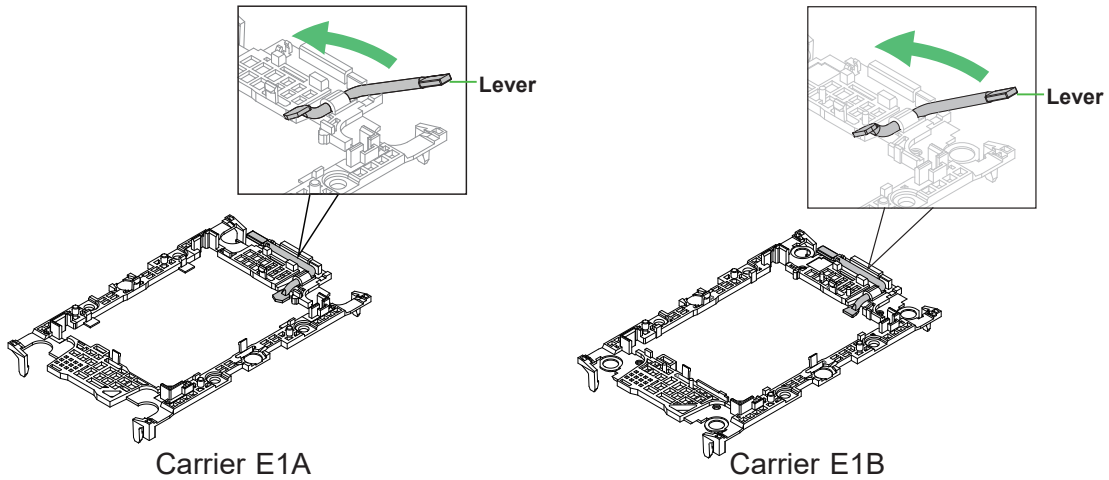

4. Using Pin 1 as a guide, carefully align the CPU keys (marked A and B) on the processor against the CPU keys on the carrier (marked a and b) as shown below.

5. Once they are properly aligned, carefully insert the CPU into the carrier, making sure that the CPU is properly secured by latches (marked 1, 2, 3, 4).

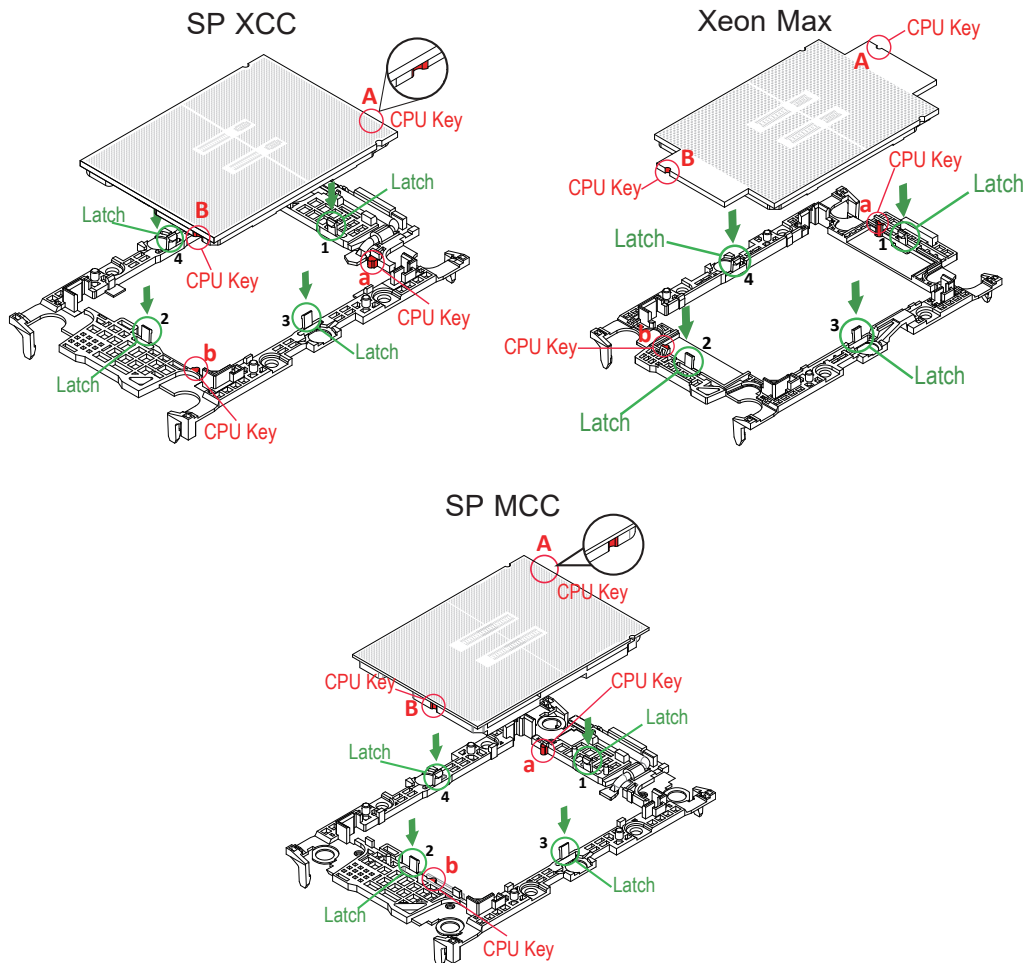

6. After the processor is placed inside the carrier, examine the four sides of the processor, making sure that the processor is properly seated on the carrier.

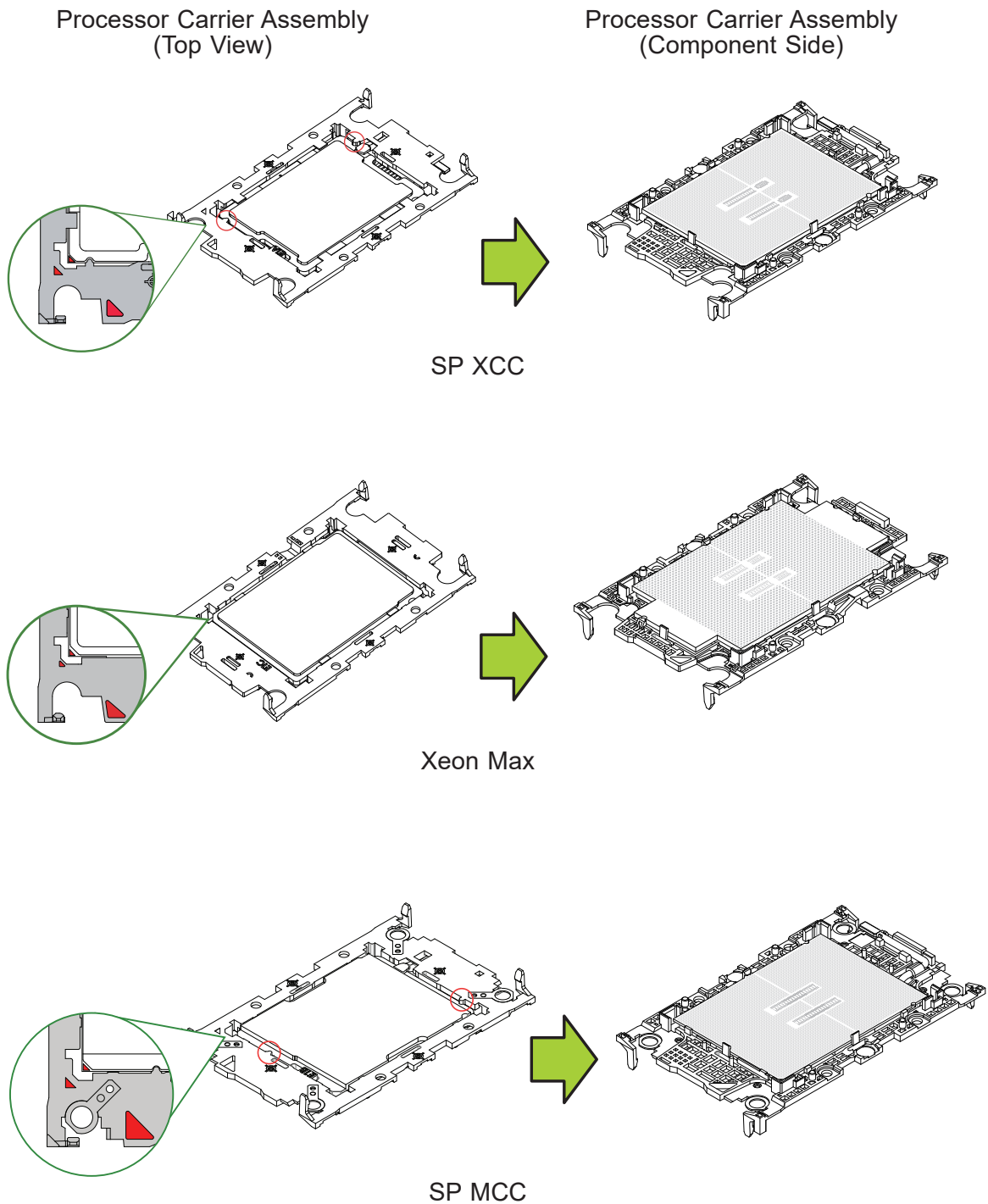

Removing the Processor from the Processor Carrier Assembly

Once you have removed the processor carrier assembly from the PHM, you are ready to remove the processor from the processor carrier by following the steps below.

1. Unlock the lever from its locked position and push the lever upwards to disengage the processor from the processor carrier as shown in the drawings on the right below.

Processor Carrier Assembly (SP XCC, Carrier E1A)

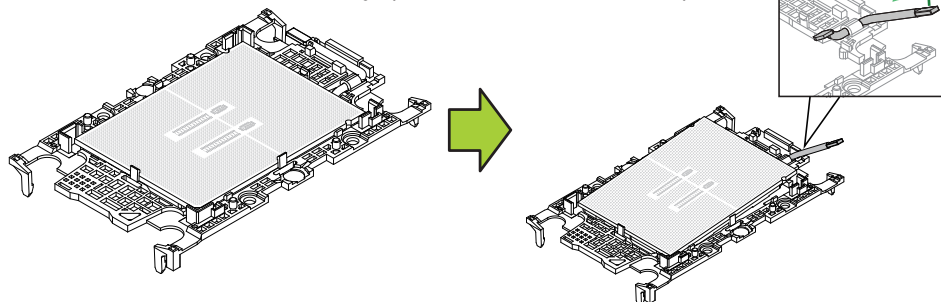

Processor Carrier Assembly (SP MCC, Carrier E1B)

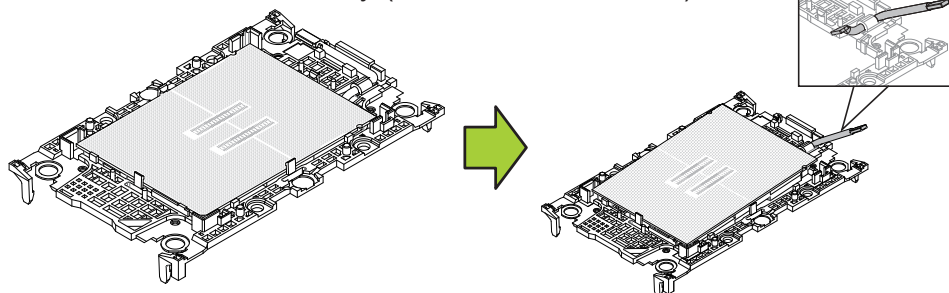

2. Once the processor is loosened from the carrier, carefully remove the processor from the processor carrier.

 **Note:** Please handle the processor with care to avoid damaging the processor and its pins.

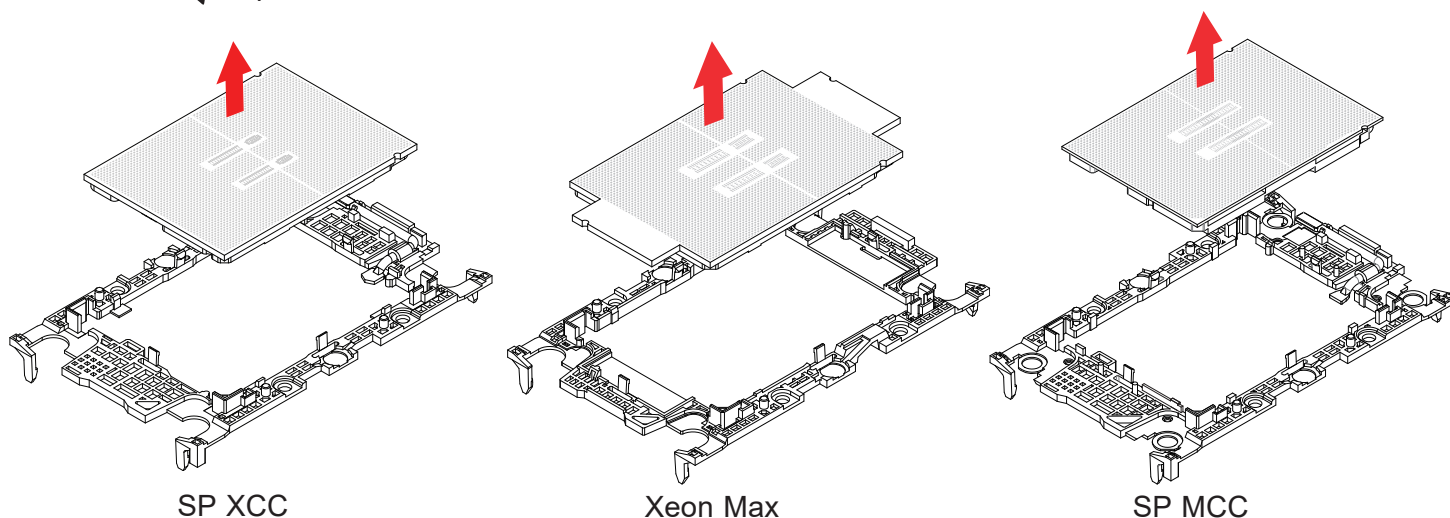

2.3 Motherboard Installation

All motherboards have standard mounting holes to fit different types of chassis. Make sure that the locations of all the mounting holes for both the motherboard and the chassis match. Although a chassis may have both plastic and metal mounting fasteners, metal ones are highly recommended because they ground the motherboard to the chassis. Make sure that the metal standoffs click in or are screwed in tightly.

Tools Needed

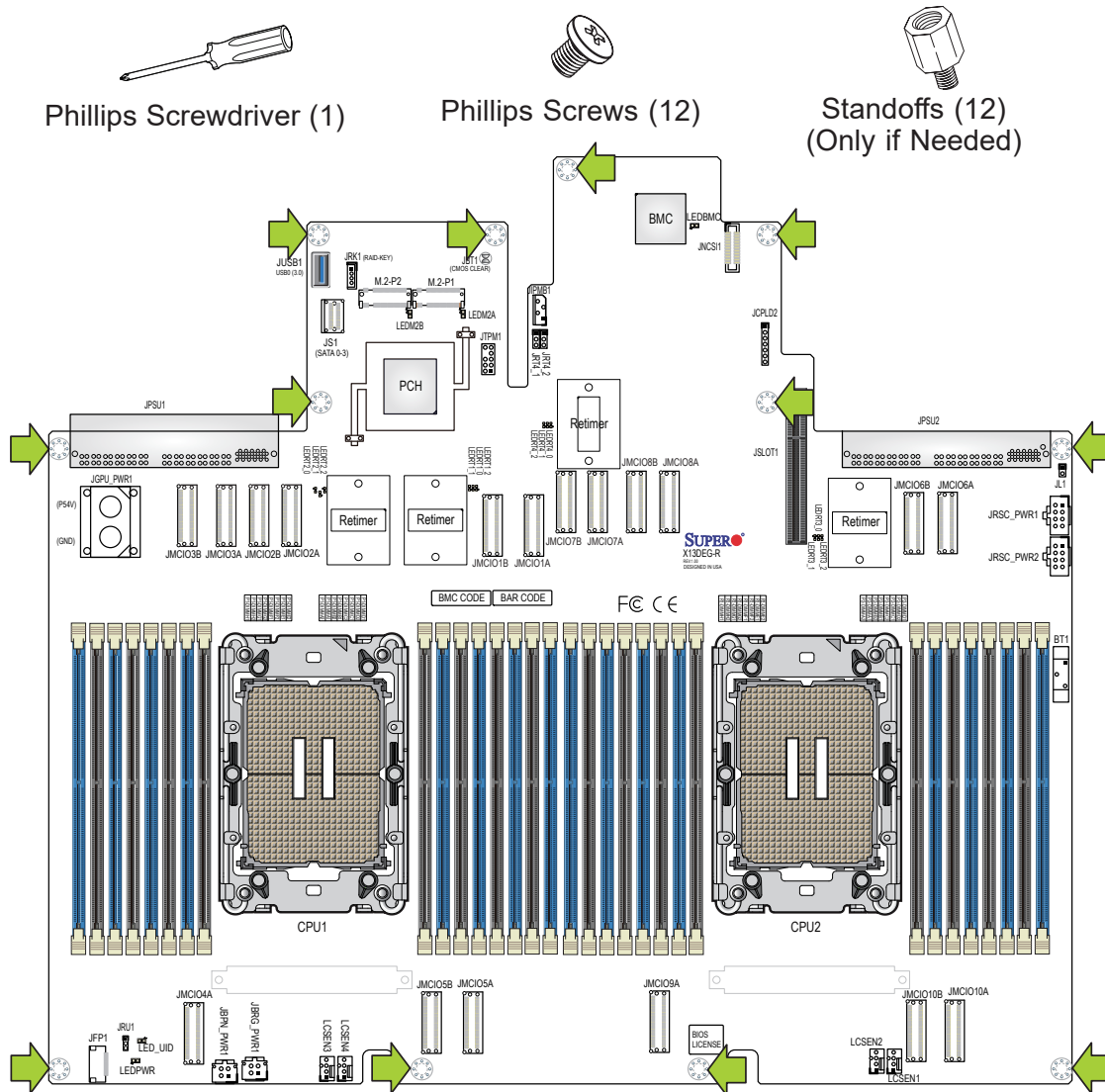

Locations of Mounting Holes

Note 1: To avoid damaging the motherboard and its components, please do not use a force greater than 8 lbf-in on each mounting screw during motherboard installation.

Note 2: Some components are very close to the mounting holes. Please take precautionary measures to avoid damaging these components when installing the motherboard to the chassis.

Installing the Motherboard

1. Install the I/O shield into the back of the chassis, if applicable.
2. Locate the mounting holes on the motherboard. See the previous page for the location.

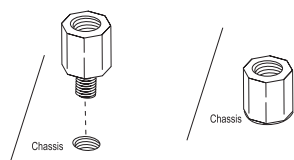

3. Locate the matching mounting holes on the chassis. Align the mounting holes on the motherboard against the mounting holes on the chassis.

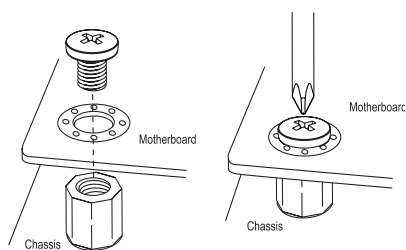

4. Install standoffs in the chassis as needed.
5. Install the motherboard into the chassis carefully to avoid damaging other motherboard components.
6. Using the Phillips screwdriver, insert a pan head #6 screw into a mounting hole on the motherboard and its matching mounting hole on the chassis.
7. Repeat Step 6 to insert #6 screws into all mounting holes.
8. Make sure that the motherboard is securely placed in the chassis.

 **Note:** Images displayed are for illustration only. Your chassis or components might look different from those shown in this manual.

2.4 Memory Support and Installation



Note: Check the Supermicro website for recommended memory modules.



Important: Exercise extreme care when installing or removing memory modules to prevent any possible damage.

Memory Support

This motherboard supports up to 8 TB of 3DS RDIMM/RDIMM DDR5 (288-pin) ECC memory with speeds of up to 5600 MT/s in 32 DIMM slots.



Note: Memory speed and capacity support depend on the processor.

DDR5 Memory Support for the 4th Gen. Intel Xeon Scalable Processors

DDR5 Memory Support for the 4th Gen. Intel Xeon Scalable Processors						
Type	Ranks Per DIMM and Data Width (Stack)	DIMM Capacity (GB)			Speed (MT/s); Voltage (V); DIMM Per Channel (DPC)	
		16 Gb (DRAM Density)	24 Gb ^{Note 2} (DRAM Density)	32 Gb (DRAM Density)	1DPC ^{Note 1}	2DPC
					1.1 V	
RDIMM	SRx8 (RC D)	16 GB	24 GB	N/A	4800	4400
	SRx4 (RC C)	32 GB	48 GB	N/A		
	SRx4 (RC F) 9x4	32 GB	N/A	N/A		
	DRx8 (RC E)	32 GB	48 GB	N/A		
	DRx4 (RC A)	64 GB	96 GB	128 GB		
	DRx4 (RC B) 9x4	64 GB	N/A	N/A		
RDIMM-3DS	(4R/8R) x4 (RC A)	2H-128 GB 4H-256 GB	N/A	N/A		
Supported DIMM generations		DDR5-4800, DDR5-5600	DDR5-4800, DDR5-5600	DDR5-5600		
LRDIMM/LRDIMM-3DS	N/A	N/A	N/A	N/A	Not Supported	Not Supported



Note 1: 1DPC applies to 1 Socket Per Channel (SPC) or 2SPC implementations.

Note 2: The 24 Gb configuration of SP XCC and SP MCC allows only 8 or 16 DIMMs installed. Its 1DPC configuration supports all DIMM types and 2DPC configuration supports capacity of 96 GB only.

DDR5 Memory Support for the 5th Gen. Intel Xeon Scalable Processors

DDR5 Memory Support for the 5th Gen. Intel Xeon Scalable Processors						
Type	Ranks Per DIMM and Data Width (Stack)	DIMM Capacity (GB)			Speed (MT/s); Voltage (V); DIMM Per Channel (DPC)	
		16 Gb (DRAM Density)	24 Gb ^{Note 2} (DRAM Density)	32 Gb (DRAM Density)	1DPC ^{Note 1}	2DPC
RDIMM	SRx8 (RC D)	16 GB	24 GB ^{Note 3}	N/A	5600 ^{Note 4}	4400 ^{Note 4}
	SRx4 (RC C)	32 GB	48 GB ^{Note 3}	N/A		
	SRx4 (RC F) 9x4	N/A	N/A	N/A		
	DRx8 (RC E)	32 GB	48 GB ^{Note 3}	N/A		
	DRx4 (RC A)	64 GB	96 GB	128 GB		
	DRx4 (RC B) 9x4	N/A	N/A	N/A		
RDIMM-3DS	(4R/8R) x4 (RC A)	2H-128 GB 4H-256 GB	N/A	N/A		
Supported DIMM generations		DDR5-4800, DDR5-5600	DDR5-4800, DDR5-5600	DDR5-5600		
LRDIMM/LRDIMM-3DS	N/A	N/A	N/A	N/A	Not Supported	Not Supported



Note 1: 1DPC applies to 1 Socket Per Channel (SPC) or 2SPC implementation.

Note 2: The 24 Gb configuration for 2 DIMMs per processor and 4 DIMMs per processor is NOT supported.

Note 3: The 24 Gb 2DPC configuration with 24 GB and 48 GB DIMMs is NOT recommended.

Note 4: DDR5-4800 DIMMs memory speed supports up to 4800 MT/s (1DPC) and 4400 MT/s (2DPC).

Memory Population for the X13DEG-R Motherboard (with 32 DIMM Slots)

DDR5 Memory Population Table for the X13DEG-R Motherboard (with 32 DIMM Slots)	
1 CPU:	Memory Population Sequence
1 CPU & 1 DIMM	P1-DIMMA1 or P1-DIMME1 or P1-DIMMB1 or P1-DIMMF1
1 CPU & 2 DIMMs	P1-DIMMA1/P1-DIMMG1 or P1-DIMMC1/P1-DIMME1
1 CPU & 4 DIMMs	P1-DIMMA1/P1-DIMMC1/P1-DIMME1/P1-DIMMG1
1 CPU & 6 DIMM	P1-DIMMA1/P1-DIMMC1/P1-DIMMD1/P1-DIMME1/P1-DIMMF1/P1-DIMMG1 or P1-DIMMA1/P1-DIMMB1/P1-DIMMC1/P1-DIMME1/P1-DIMMG1/P1-DIMMH1 or P1-DIMMB1/P1-DIMMC1/P1-DIMMD1/P1-DIMME1/P1-DIMMF1/P1-DIMMH1 or P1-DIMMA1/P1-DIMMB1/P1-DIMMD1/P1-DIMMF1/P1-DIMMG1/P1-DIMMH1
1 CPU & 8 DIMMs	P1-DIMMA1/P1-DIMMB1/P1-DIMMC1/P1-DIMMD1/P1-DIMME1/P1-DIMMF1/P1-DIMMG1/P1-DIMMH1
1 CPU & 12 DIMMs	P1-DIMMA1/P1-DIMMA2/P1-DIMMB1/P1-DIMMC1/P1-DIMMC2/P1-DIMMD1/P1-DIMME1/P1-DIMME2/P1-DIMMF1/P1-DIMMG1/P1-DIMMG2/P1-DIMMH1 or P1-DIMMA1/P1-DIMMB1/P1-DIMMB2/P1-DIMMC1/P1-DIMMD1/P1-DIMMD2/P1-DIMME1/P1-DIMMF1/P1-DIMMF2/P1-DIMMG1/P1-DIMMH1/P1-DIMMH2
1 CPU & 16 DIMMs	P1-DIMMA1/P1-DIMMA2/P1-DIMMB1/P1-DIMMB2/P1-DIMMC1/P1-DIMMC2/P1-DIMMD1/P1-DIMMD2/P1-DIMME1/P1-DIMME2/P1-DIMMF1/P1-DIMMF2/P1-DIMMG1/P1-DIMMG2/P1-DIMMH1/P1-DIMMH2
2 CPUs: (Recommended)	Memory Population Sequence
2 CPUs & 2 DIMMs	CPU1: P1-DIMMA1, CPU2: P2-DIMMA1 or CPU1: P1-DIMME1, CPU2: P2-DIMME1 or CPU1: P1-DIMMB1, CPU2: P2-DIMMB1 or CPU1: P1-DIMMF1, CPU2: P2-DIMMF1
2 CPUs & 4 DIMMs	CPU1: P1-DIMMA1/P1-DIMMG1, CPU2: P2-DIMMA1/P2-DIMMG1 or CPU1: P1-DIMMC1/P1-DIMME1, CPU2: P2-DIMMC1/P2-DIMME1
2 CPUs & 8 DIMMs	CPU1: P1-DIMMA1/P1-DIMMC1/P1-DIMME1/P1-DIMMG1 CPU2: P2-DIMMA1/P2-DIMMC1/P2-DIMME1/P2-DIMMG1
2 CPUs & 10 DIMMs	CPU1: P1-DIMMA1/P1-DIMMC1/P1-DIMMD1/P1-DIMME1/P1-DIMMF1/P1-DIMMG1 CPU2: P2-DIMMA1/P2-DIMMC1/P2-DIMME1/P2-DIMMG1
2 CPUs & 12 DIMMs	CPU1: P1-DIMMA1/P1-DIMMC1/P1-DIMMD1/P1-DIMME1/P1-DIMMF1/P1-DIMMG1 CPU2: P2-DIMMA1/P2-DIMMC1/P2-DIMMD1/P2-DIMME1/P2-DIMMF1/P2-DIMMG1 or CPU1: P1-DIMMA1/P1-DIMMB1/P1-DIMMC1/P1-DIMME1/P1-DIMMG1/P1-DIMMH1 CPU2: P2-DIMMA1/P2-DIMMB1/P2-DIMMC1/P2-DIMME1/P2-DIMMG1/P2-DIMMH1 or CPU1: P1-DIMMB1/P1-DIMMC1/P1-DIMMD1/P1-DIMME1/P1-DIMMF1/P1-DIMMH1 CPU2: P2-DIMMB1/P2-DIMMC1/P2-DIMMD1/P2-DIMME1/P2-DIMMF1/P2-DIMMH1 or CPU1: P1-DIMMA1/P1-DIMMB1/P1-DIMMD1/P1-DIMMF1/P1-DIMMG1/P1-DIMMH1 CPU2: P2-DIMMA1/P2-DIMMB1/P2-DIMMD1/P2-DIMMF1/P2-DIMMG1/P2-DIMMH1
2 CPUs & 16 DIMMs	CPU1: P1-DIMMA1/P1-DIMMB1/P1-DIMMC1/P1-DIMMD1/P1-DIMME1/P1-DIMMF1/P1-DIMMG1/P1-DIMMH1 CPU2: P2-DIMMA1/P2-DIMMB1/P2-DIMMC1/P2-DIMMD1/P2-DIMME1/P2-DIMMF1/P2-DIMMG1/P2-DIMMH1
2 CPUs & 22 DIMMs	CPU1: P1-DIMMA1/P1-DIMMA2/P1-DIMMB1/P1-DIMMB2/P1-DIMMC1/P1-DIMMC2/P1-DIMMD1/P1-DIMMD2/P1-DIMME1/P1-DIMME2/P1-DIMMF1/P1-DIMMF2/P1-DIMMG1/P1-DIMMG2/P1-DIMMH1/P1-DIMMH2 CPU2: P2-DIMMA1/P2-DIMMC1/P2-DIMMD1/P2-DIMME1/P2-DIMMF1/P2-DIMMG1
2 CPUs & 24 DIMMs	CPU1: P1-DIMMA1/P1-DIMMA2/P1-DIMMB1/P1-DIMMB2/P1-DIMMC1/P1-DIMMC2/P1-DIMMD1/P1-DIMMD2/P1-DIMME1/P1-DIMME2/P1-DIMMF1/P1-DIMMF2/P1-DIMMG1/P1-DIMMG2/P1-DIMMH1/P1-DIMMH2 CPU2: P2-DIMMA1/P2-DIMMB1/P2-DIMMC1/P2-DIMMD1/P2-DIMME1/P2-DIMMF1/P2-DIMMG1/P2-DIMMH1
2 CPUs & 32 DIMMs	CPU1: P1-DIMMA1/P1-DIMMA2/P1-DIMMB1/P1-DIMMB2/P1-DIMMC1/P1-DIMMC2/P1-DIMMD1/P1-DIMMD2/P1-DIMME1/P1-DIMME2/P1-DIMMF1/P1-DIMMF2/P1-DIMMG1/P1-DIMMG2/P1-DIMMH1/P1-DIMMH2 CPU2: P2-DIMMA1/P2-DIMMA2/P2-DIMMB1/P2-DIMMB2/P2-DIMMC1/P2-DIMMC2/P2-DIMMD1/P2-DIMMD2/P2-DIMME1/P2-DIMME2/P2-DIMMF1/P2-DIMMF2/P2-DIMMG1/P2-DIMMG2/P2-DIMMH1/P2-DIMMH2



Note 1: The memory configuration is recommended by Supermicro for optimal memory performance. Please use this configuration to maximize your memory performance.

Note 2: To support SGX and TDX features, DIMM population must be symmetric across integrated Memory Controllers (iMCs) and eight DIMMs per socket at least. For each memory controller, populating first slots (Px-DIMMX1) in all channels is required.

DDR5 Memory Population Table for the X13DEG-R Motherboard (with the Intel Xeon Max Series and 16 DIMM Slots)									Intel Xeon Max Series Partitioning Modes					
	P1/P2- DIMMH1	P1/P2- DIMMG1	P1/P2- DIMMF1	P1/P2- DIMME1	P1/P2- DIMMA1	P1/P2- DIMMB1	P1/P2- DIMMC1	P1/P2- DIMMD1	SNC2	SNC4 (DDR+ HBM)	Hemi (DDR only)	Quad (HBM)	Quad (DDR)	All2All (DDR only)
Xeon Max Only										V		V		
Xeon Max & 1 DIMM					DDR5							V		V
Xeon Max & 1 DIMM				DDR5								V		V
Xeon Max & 2 DIMMs		DDR5			DDR5							V		V
Xeon Max & 2 DIMMs				DDR5			DDR5					V		V
Xeon Max & 4 DIMMs		DDR5		DDR5	DDR5		DDR5			V		V	V	
Xeon Max & 8 DIMMs	DDR5	DDR5	DDR5	DDR5	DDR5	DDR5	DDR5	DDR5		V		V	V	

* SNC: Sub NUMA Cluster



Notes: For the memory support on the Intel Xeon Max Series, which is with the high bandwidth memory (HBM), please note the following:

1. CPU Only Mode: This mode is supported when the Intel Xeon Max Series is installed with no DDR memory module. The feature of "Total Memory" on the Main screen of the BIOS Setup utility displays the HBM size.
2. Cache Mode: This mode is supported when the Intel Xeon Max Series is installed with the DDR memory module(s). The processor will be configured in the Two-Level Memory mode (2LM), which is the default setting. The feature of "Total Memory" on the Main screen of the BIOS Setup utility displays the size of DDR memory module(s) installed in your system.
3. Flat Mode: This mode supports the One-Level Memory mode (1LM). Please go to the BIOS Setup utility (Advanced > Chipset Configuration > North Bridge > Memory Configuration) to set "Volatile Memory Mode" to 1LM. The feature of "Total Memory" on the Main screen of the BIOS Setup utility displays the result of adding the HBM size to the DDR size.
4. The total DDR size must be at least two times of the HBM size for each CPU socket.

DIMM Installation

 **Note:** The DDR5 DIMM module is NOT hot-swappable and be sure to disconnect power for a minimum of twenty seconds before inserting or removing it.

1. Insert the desired number of DIMMs into the memory slots based on the recommended DIMM population tables in the previous section. Locate DIMM memory slots on the motherboard as shown on the right.
2. Push the release tabs outwards on both ends of the DIMM slot to unlock it.

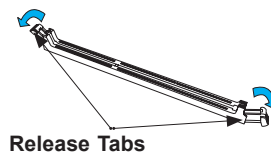
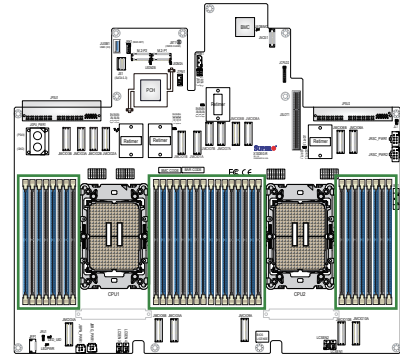

3. Align the key of the memory module with the receptive point on the memory slot.

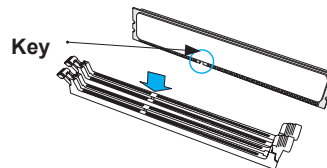

4. Align the notches on both ends of the module against the receptive points on the ends of the slot.

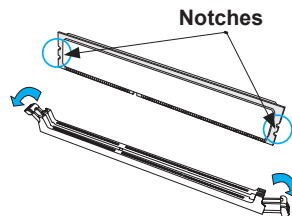

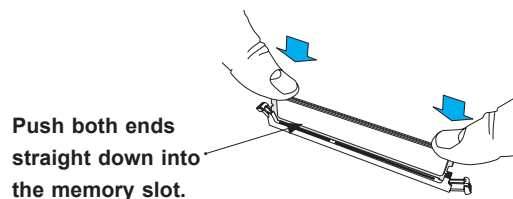

5. Push both ends of the module straight down into the slot until the module snaps into place.
6. Press the release tabs to the lock positions to secure the memory module into the slot.

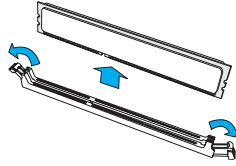

DIMM Removal

Press both release tabs on the ends of the memory module to unlock it. Once the memory module has been loosened, remove it from the memory slot.



 **Note:** Removing a DDR5 DIMM module at a slant angle will cause module damages. It is strongly recommended that you lift the module straight up out of the slot.

Warning! Please do not use excessive force when pressing the release tabs on the ends of the DIMM socket to avoid causing any damage to the memory module or the DIMM socket. Please handle memory modules with care. Carefully follow all the instructions given on the first page of this chapter to avoid ESD-related damages done to your memory modules or components.

2.5 Front Control Panel

Front Control Panel Header with I²C

There is one front control panel header located on this motherboard. The front control panel header (JFP1) contains header pins for various buttons and LED indications with I²C support for front access. This front control panel header is designed specifically for use with Supermicro chassis. Refer to the figure below for the pin-out descriptions for JFP1.

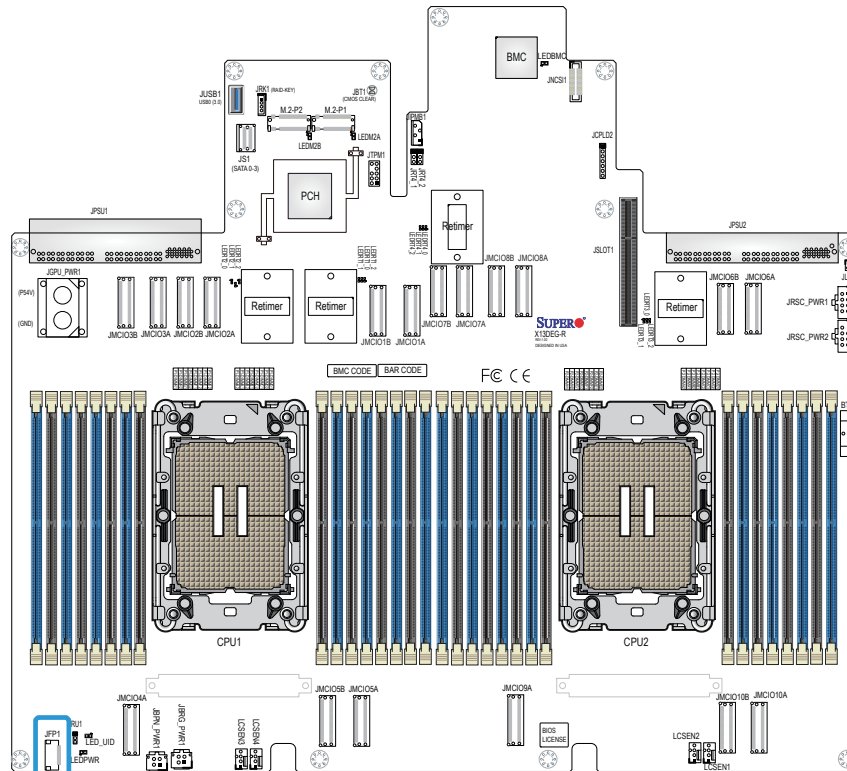

JFP1

1	Power Button
2	Reset/UID Button
3	UID LED_N
4	Fail LED_N (OH/FF/PF)
5	LAN-2 Activity LED
6	LAN-1 Activity LED (Aggregate all LAN)
7	HDD Activity LED
8	Standby LED_N
9	Power/RoT LED_N
10	P3V3_STBY
11	Ground
12	I2C Data
13	I2C Clock
14	Ground
15	Power Fail LED_P
16	
17	
18	
19	Power Fail LED_N
20	Ground

JFP1 Header Pins

Power On and BMC/BIOS Status LED Button

The Power On and BMC/BIOS Status LED button is located on Pin 1 of the front control panel header (JFP1). Momentarily contacting Pin 1 of JFP1 will power on/off the system or display BMC/BIOS status. Refer to the table below for more information.

Power Button BMC/BIOS Status LED Indicator	
Status	Event
Green: solid on	System power on
BMC/BIOS blinking green at 4 Hz	BMC/BIOS checking
BIOS blinking green at 4 Hz	BIOS recovery/update in progress
BMC blinking red x2 (2 blinks red) at 4 Hz, 1 pause at 2 Hz (on-on-off-off)	BMC recovery/update in progress
BMC/BIOS blinking green at 1 Hz	Flash not detected or golden image checking failure

Front UID Switch/Reset Button

The Front UID switch/BMC Reset button/System Reset button connection is located on Pin 2 of JFP1, which is used in conjunction with the Reset button/UID switch select jumper located at JRU1. To configure Pin 2 of JFP1 for front UID switch and BMC reset use in a chassis that supports front UID connection, close Pin 2 and Pin 3 of JRU1. To set Pin 2 of JFP1 for system reset support, close Pin 1 and Pin 2 of JRU1. Please refer to Section 2.7 for more information on JRU1 ([page 57](#)). Also see the motherboard layout below for the location of JRU1.

JFP1	
1	○ Power Button 1
2	○ Reset/UID Button 2
3	○ UID LED_N
4	○ Fail LED_N (OH/FF/PF)
5	○ LAN-2 Activity LED
6	○ LAN-1 Activity LED (Aggregate all LAN)
7	○ HDD Activity LED
8	○ Standby LED_N
9	○ Power/RoT LED_N
10	○ P3V3_STBY
11	○ Ground
12	○ I2C Data
13	○ I2C Clock
14	○ Ground
15	○ Power Fail LED_P
16	○
17	○
18	○
19	○ Power Fail LED_N
20	○ Ground

Front UID Switch/Reset Button Select Jumper (JRU1) Jumper Settings	
State	Description
Close Pin 1 and Pin 2 of JRU1	Pin 2 of JFP1: used for system reset support
Close Pin 2 and Pin 3 of JRU1	Pin 2 of JFP1: used for front UID switch and BMC reset support (Default)

1. Power On and BMC/BIOS Status LED Button
2. Reset Button/UID Switch Connection
3. JRU1 Jumper (Reset Button/UID Switch Select)

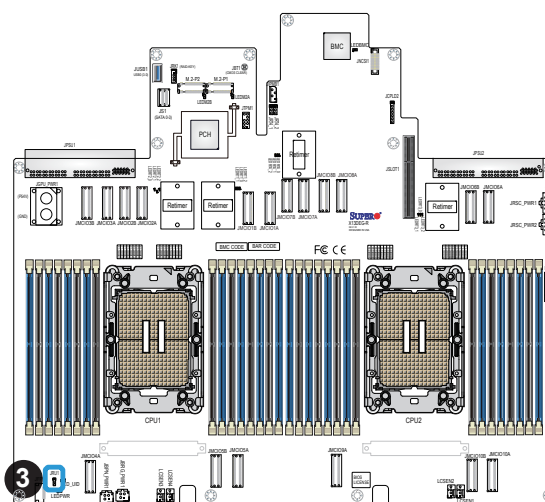

UID LED

The unit identifier LED connection is located on Pin 3 of JFP1. Refer to the figure below for more information on JFP1.

Fail LED (Information LED for OH/FF/PF)

The Fail LED (Information LED for OH/Fan Fail/PWR Fail) connection is located on Pin 4 of JFP1. The LED provides warnings of overheating, power failure, or fan failure. Refer to the table below for more information.

Fail LED (Information LED) (OH/Fan Fail/PWR Fail) LED States	
Status	Description
Solid red (on)	An overheat condition has occurred.
Blinking red (1 Hz)	Fan failure: check for an inoperative fan.
Blinking red (0.25 Hz)	Power failure: check for a non-operational power supply
Blinking red (10 Hz) (FP red LED)	CPLD recovery mode error(s)
Solid blue	UID has been activated locally. Use this function to locate a unit in a rack mount environment that might be in need of service.
Blinking blue (1 Hz)	Local UID has been activated locally on. Use this function to identify a unit that might be in need of service.
BIOS/BMC blinking blue (10 Hz)	BIOS/BMC: recovery and/or update in progress
Red Info LED blinking (10 Hz) and MB UID LED blue blinking (10 Hz)	CPLD: recovery and/or update in progress

JFP1

1	○	Power Button
2	○	Reset/UID Button
3	○	UID LED_N 1
4	○	Fail LED_N (OH/FF/PF) 2
5	○	LAN-2 Activity LED
6	○	LAN-1 Activity LED (Aggregate all LAN)
7	○	HDD Activity LED
8	○	Standby LED_N
9	○	Power/RoT LED_N
10	○	P3V3_STBY
11	○	Ground
12	○	I2C Data
13	○	I2C Clock
14	○	Ground
15	○	Power Fail LED_P
16	○	
17	○	
18	○	
19	○	Power Fail LED_N
20	○	Ground

1. UID LED Indicator
2. Fail LED (Information LED for OH/FF/PF)

LAN1/LAN2 (NIC1/NIC2)

The Network Interface Controller (NIC) LED connection for LAN Port 1 is located on Pin 6 of JFP1, and LAN Port 2 is on Pin 5. Refer to the table below.

LAN1/LAN2 LED LED States	
Color	State
NIC 2: Blinking green	LAN 2: Active
NIC 1: Blinking green	LAN 1: Active

HDD Activity LED

The HDD activity LED connection is located on Pin 7 of JFP1. When this LED is blinking green, it indicates HDD activity. Refer to the table below.

HDD LED LED State	
Color	State
Blinking Green	HDD Active

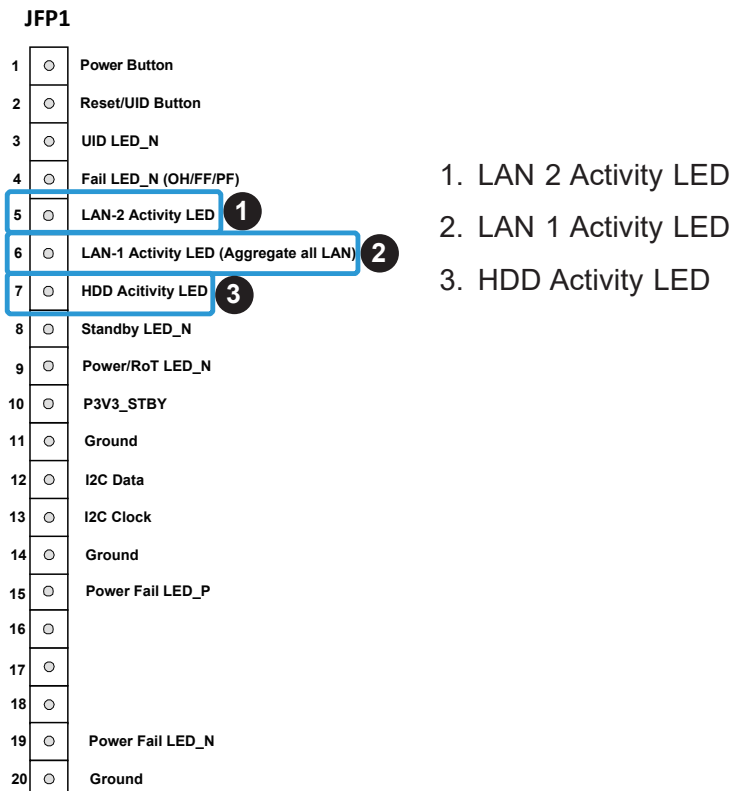

Standby Power LED

The LED indicator for standby power is located on Pin 8 of JFP1. If this LED is on, standby power is on.

RoT (Root of Trust) Power LED

The Power LED for Root of Trust (RoT) connection is located on Pin 9 of JFP1. If this LED is on, power for the RoT chip is on.

JFP1

1	○	Power Button
2	○	Reset/UID Button
3	○	UID LED_N
4	○	Fail LED_N (OH/FF/PF)
5	○	LAN-2 Activity LED
6	○	LAN-1 Activity LED (Aggregate all LAN)
7	○	HDD Activity LED
8	○	Standby LED_N 1
9	○	Power/RoT LED_N 2
10	○	P3V3_STBY
11	○	Ground
12	○	I2C Data
13	○	I2C Clock
14	○	Ground
15	○	Power Fail LED_P
16	○	
17	○	
18	○	
19	○	Power Fail LED_N
20	○	Ground

1. Standby Power LED
2. RoT Power LED

Standby Power

A Standby Power (I²C) connection is located on Pin 10 – Pin 14 of JFP1 to provide power to the system when it is in standby mode. Refer to the table below for pin definitions.

3.3V Standby PWR Pin Definitions	
Pin#	Definition
10	P3V3 Standby
11	Ground
12	I ² C Data
13	I ² C Clock
14	Ground

Power Fail LED Indicators

Power Failure LED Indicators are located on Pin 15 and Pin 19 of JFP1. Refer to the table below for pin definitions.

FP Power LED Pin Definitions (JFP1)	
Pin#	Definition
15	PWR Failure LED-Positive
19	PWR Failure LED-Negative

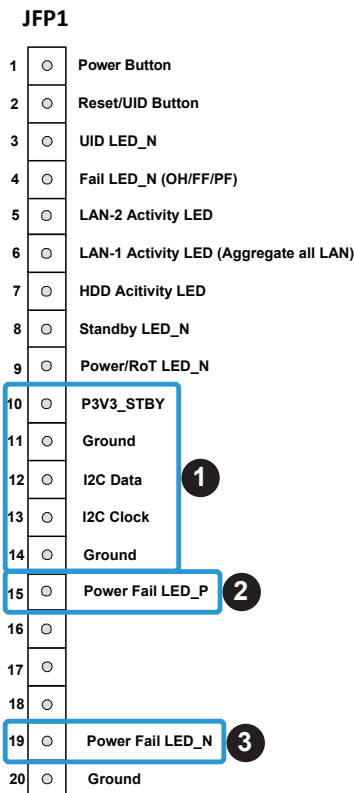

1. (3.3V) Standby Power
2. PWR Fail LED (Positive)
3. PWR Fail LED (Negative)

2.6 I/O Connections

Add-on Module (AOM) Riser Card Slot for I/O Support

An Supermicro proprietary AOM riser card slot is located at JSLOT1 on the motherboard. With support of the AOM-PTG-I2T riser card installed, JSLOT1 provides input/output connections for your system. The AOM-PTG-I2T riser card provides connections of one dedicated BMC LAN port, two USB 3.0 ports, one VGA header, one COM header, and dual 10 GbE LAN ports.

Universal Serial Bus (USB) Connection

There is one USB connection for front access on the motherboard. JUSB1 is the vertical Type-A USB 3.0 connector. It can be used for USB support via USB cables (not provided).

Type-A USB 3.0 Pin Definitions			
Pin#	Definition	Pin#	Definition
1	VBUS	5	SSRX-
2	USB_N	6	SSRX+
3	USB_P	7	GND
4	Ground	8	SSTX-
		9	SSTX+

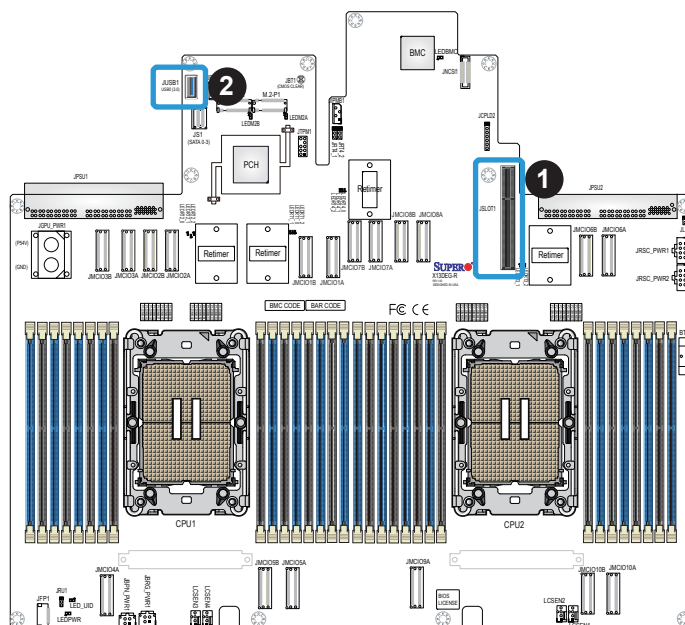

1. AOM Riser Card Slot (JSLOT1)
2. JUSB1 (USB0, Internal USB 3.0 Vertical Type-A Connector)

2.7 Connectors and Headers

Power Connections

Power Connectors

Two power supply connectors, located at JPSU1/JPSU2 (5.25 KW), provide main power to your system. Also, connect the power connector (JGPU_PWR1) to your GPU module. The two 8-pin power connectors (JRSC_PWR1, JRSC_PWR2) are for the riser cards. One 4-pin power connector (JBPN_PWR1) is for the storage backplane. The other 4-pin power connector (JBRG_PWR1) is for the GPU transition board. All these power connectors meet the ATX SSI EPS 12V specification and must be connected to your power supply and the corresponding devices to provide adequate power to your system.

GPU Power (JGPU_PWR1) Pin Definitions	
Pin#	Definition
1	54V
2	Ground

12V 8-pin Riser Card Power (JRSC_PWR1, JRSC_PWR2) Pin Definitions	
Pin#	Definition
1 - 4	Ground
5 - 6	+12V
7	+3.3V
8	+3.3V_STBY

4-pin Storage Backplane Power (JBPN_PWR1) Pin Definitions	
Pin#	Definition
1 - 2	Ground
3	+12V
4	+12V

4-pin GPU Transition Board Power (JBRG_PWR1) Pin Definitions	
Pin#	Definition
1 - 2	Ground
3 - 4	+12V_AUX

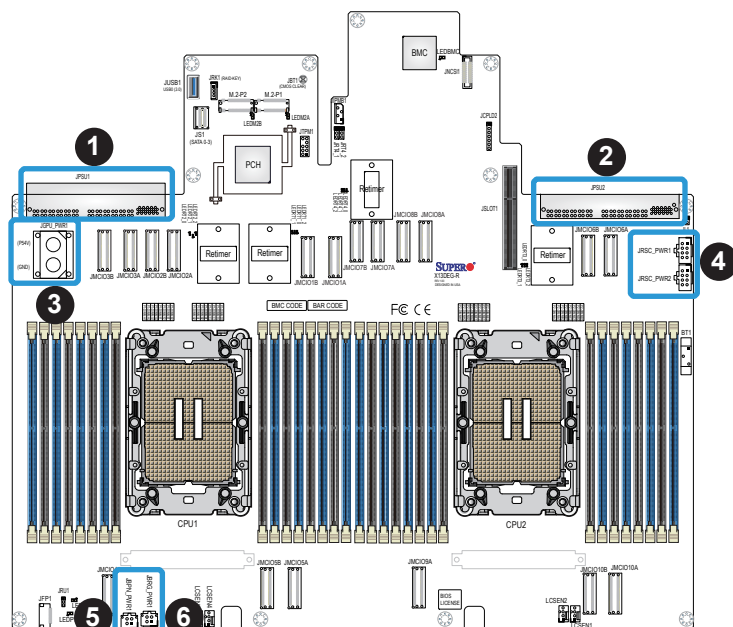

1. Main PWR Supply Unit Connector (JPSU1)
2. Main PWR Supply Unit Connector (JPSU2)
3. Power Connector for the GPU Module (JGPU_PWR1)
4. 8-pin Riser Card Power Connectors (JRSC_PWR1, JRSC_PWR2)
5. 4-pin Power Connector to the Storage Backplane (JBPN_PWR1)
6. 4-pin Power Connector to the GPU Transition Board (JBRG_PWR1)

Headers and Connectors

4-pin BMC External I²C Header

A System Management Bus header for the BMC is located at JIPMB1. Connect the appropriate cable here to use the IPMB I²C connection on your system. Refer to the layout for the location of JIPMB1.

Chassis Intrusion

A Chassis Intrusion header is located at JL1 on the motherboard. Attach the appropriate cable from the chassis to inform you when the chassis is opened. Refer to the table below for pin definitions.

Chassis Intrusion Pin Definitions	
Pin#	Definition
1	Intrusion Input
2	Ground

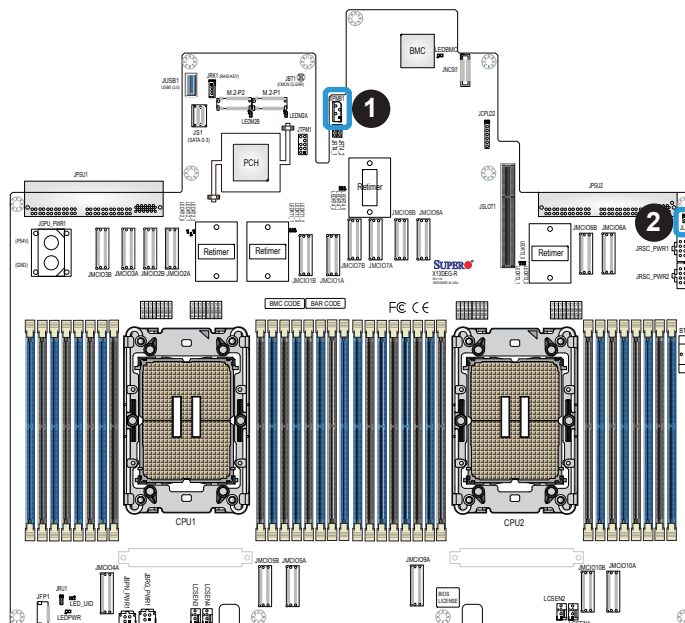

1. BMC External Header (JIPMB1)
2. Chassis Intrusion Header (JL1)

MCIO Connectors for GPU Transition Board

The motherboard supports eight PCIe 5.0 x8 MCIO connectors (JMCIO1A/1B, JMCIO2A/2B, JMCIO6A/6B, JMCIO7A/7B) to be connected to the GPU transition board for your system. Four retimers are also supported for these eight MCIO connectors.

MCIO Connectors for Riser Cards

The motherboard supports eight PCIe 5.0 x8 MCIO connectors (JMCIO3A/3B, JMCIO5A/5B, JMCIO8A/8B, JMCIO10A/10B) to be connected to the riser cards for your system.

MCIO Connectors for Storage Devices

The motherboard supports two PCIe 5.0 x8 MCIO connectors (JMCIO4A, JMCIO9A) to be connected to the storage devices for your system.

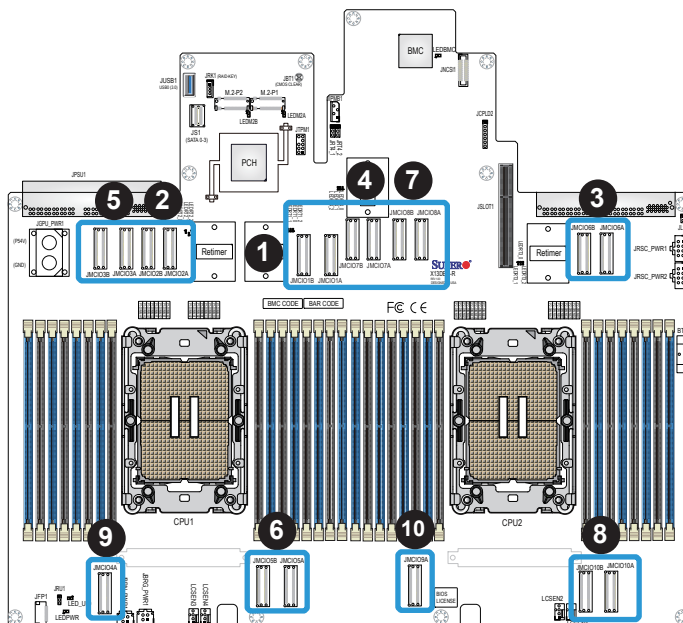

1. JMCIO1A / JMCIO1B
2. JMCIO2A / JMCIO2B
3. JMCIO6A / JMCIO6B
4. JMCIO7A / JMCIO7B
5. JMCIO3A / JMCIO3B
6. JMCIO5A / JMCIO5B
7. JMCIO8A / JMCIO8B
8. JMCIO10A / JMCIO10B
9. JMCIO4A
10. JMCIO9A

NC-SI Connector

The Network Controller Sideband Interface (NC-SI) connector is located at JNCSI1. This connector is used to connect a Network Interface Card (NIC) to the motherboard to allow the onboard BMC to communicate with a network.

TPM/Port 80 Header

The JTPM1 header is used to connect a Trusted Platform Module (TPM)/Port 80, which is available from Supermicro (optional). A TPM/Port 80 connector is a security device that supports encryption and authentication in hard drives. It allows the motherboard to deny access if the TPM, which is associated with the hard drive, is not installed in the system. See the layout below for the location of the TPM header. Please go to the following link for more information on the TPM: https://www.supermicro.com/manuals/other/AOM-TPM-9670V_9670H.pdf.

Trusted Platform Module Header Pin Definitions			
Pin#	Definition	Pin#	Definition
1	+3.3V	2	SPI_CS#
3	RESET#	4	SPI_MISO
5	SPI_CLK	6	GND
7	SPI_MOSI	8	NC
9	+3.3V Stdby	10	SPI_IRQ#

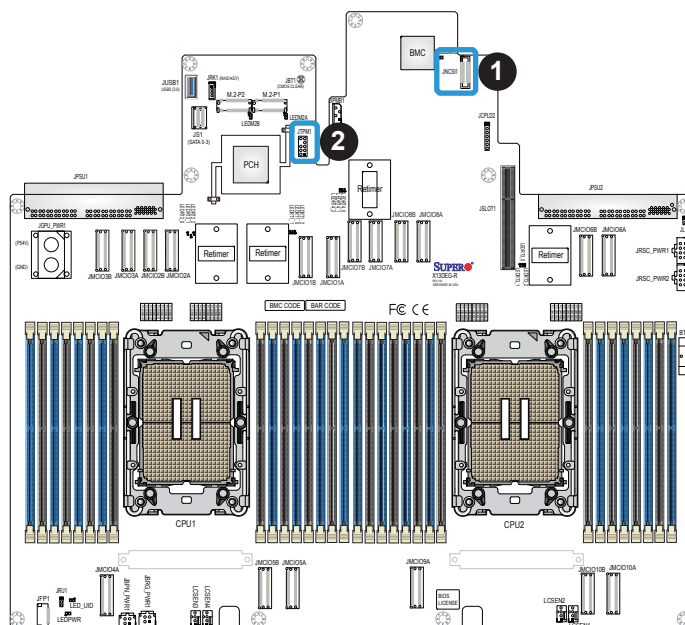

1. NC-SI Connector (JNCSI1)
2. TPM/Port 80 Header(JTPM1)

M.2 Slots (for NVMe Devices Only)

Two M.2 slots are located at M.2-P1 and M.2-P2 on the motherboard. These M.2 slots support PCIe 3.0 x4 M.2 NVMe devices in the 2280 and 22110 form factors. M.2 allows for a variety of card sizes, increased functionality, and spatial efficiency.

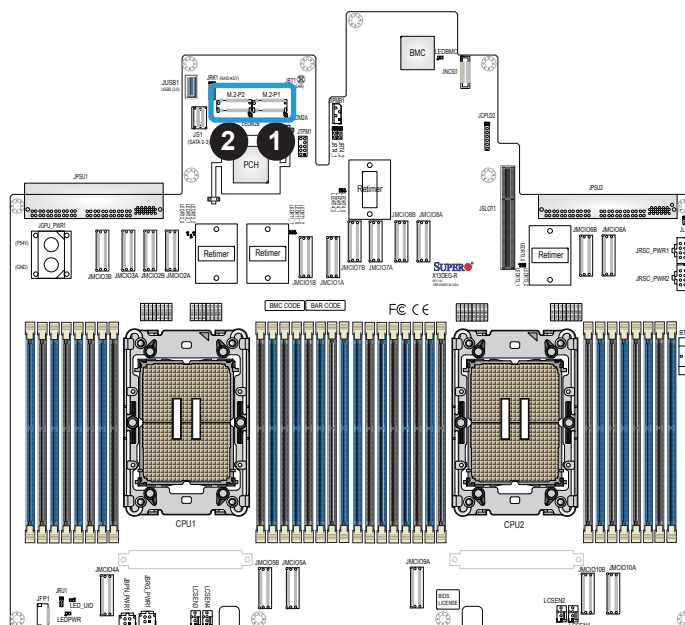

1. M.2 Slot (M.2-P1)
2. M.2 Slot (M.2-P2)

VROC RAID Key Header

An Intel VROC RAID Key header is located at JRK1 on the motherboard. Install a VROC RAID Key on JRK1 for NVMe RAID support as shown in the illustration below. Please refer to the layout below for the location of JRK1.

Note: For detailed instructions on how to configure VROC RAID settings, please refer to the VROC RAID Configuration User's Guide posted on the web page under the link: <https://www.supermicro.com/support/manuals/>.

Intel VROC Key Pin Definitions	
Pin#	Definition
1	Ground
2	3.3V Standby
3	Ground
4	PCH RAID Key

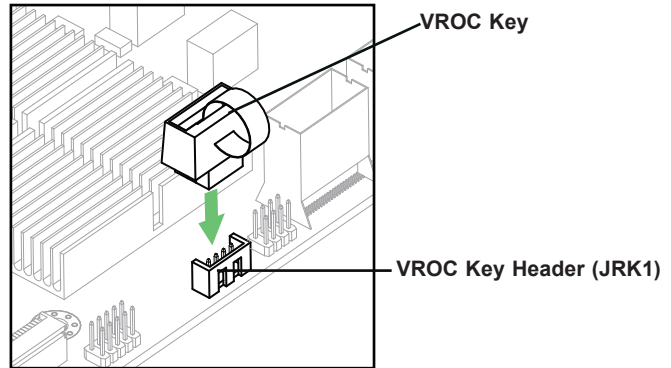

Note: The graphics contained in this user's manual are for illustration only. The components installed in your system may or may not look exactly the same as the graphics shown in the manual.

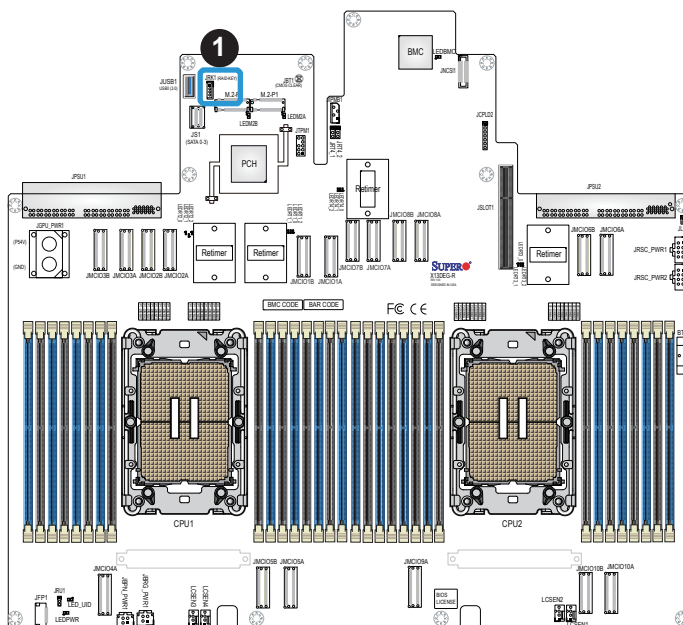

1. VROC RAID Key Header (JRK1)

2.8 Jumper Settings

How Jumpers Work

To modify the operation of the motherboard, jumpers can be used to choose between optional settings. Jumpers create shorts between two pins to change the function of the connector. Pin 1 is identified with a square solder pad on the printed circuit board. See the diagram below for an example of jumping pins 1 and 2. Refer to the motherboard layout page for jumper locations.

 **Note 1:** On two-pin jumpers, "Closed" means the jumper is on and "Open" means the jumper is off the pins.

Note 2: Unplug the power cord from all power supplies before adjusting jumper settings.

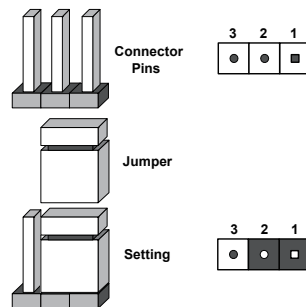

CMOS Clear

JBT1 is used to clear CMOS, which will also clear any passwords. Instead of pins, this jumper consists of contact pads to prevent accidentally clearing the contents of CMOS.

To Clear CMOS



1. First power down the system and unplug the power cord(s).
2. Remove the cover of the chassis to access the motherboard and remove the battery from the motherboard.
3. Short the CMOS pads, JBT1, with a metal object such as a small screwdriver for at least four seconds.
4. Remove the screwdriver (or shorting device).
5. Replace the cover, reconnect the power cord(s), and power on the system.

 **Note:** Clearing CMOS will also clear all passwords.

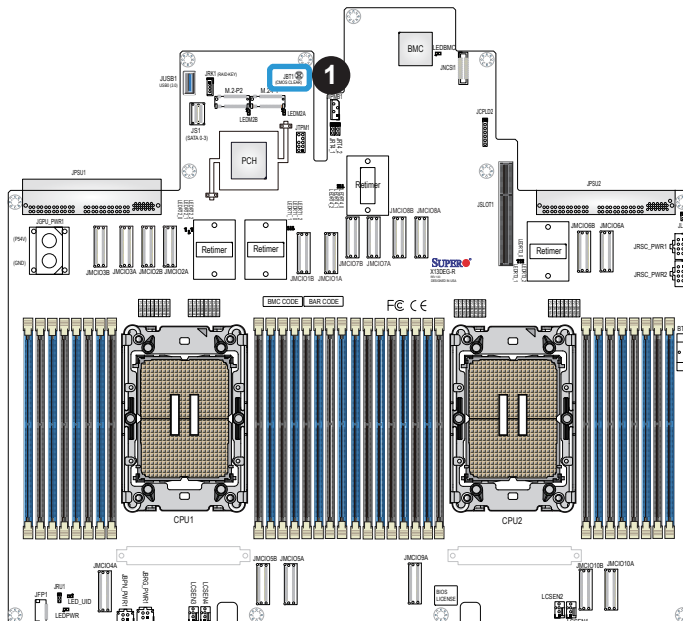

1. JBT1

UID Switch/BMC Reset and System Reset

JRU1 is used in conjunction with Pin 2 of Front Control Panel (JFP1) to function as a System Reset button or a UID Switch/BMC Reset button. To configure Pin 2 of JFP1 for front UID Switch and BMC Reset use in a chassis that supports front UID connection, close Pins 2 and 3 of JRU1. To set Pin 2 of JFP1 for System Reset support, close Pins 1 and 2 of JRU1.

Front UID Switch/BMC Reset and System Reset (JRU1) Jumper Settings	
Jumper Setting	Description
Pins 1-2	Pin 2 of JFP1: used for system reset support
Pins 2-3	Pin 2 of JFP1: used for front UID switch and BMC reset support (Default)

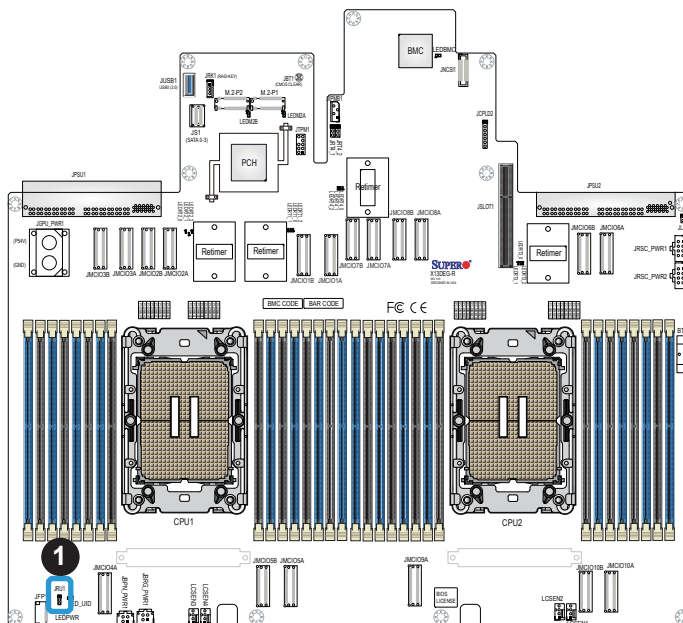

1. UID Switch/BMC Reset/
System Reset (JRU1)

2.9 LED Indicators

Unit ID LED

The rear UID LED indicator is located at UID_LED. This UID indicator provides easy identification of a system that may need service.

UID LED LED Indicator	
LED Color	Definition
Blue: On	System Identified

BMC Heartbeat LED

A BMC Heartbeat LED is located at LEDBMC on the motherboard. When LEDBMC is blinking green, the BMC is functioning normally. Refer to the layout below for the location of LEDBMC.

BMC Heartbeat LED Indicator	
LED Color	Definition
Green: Blinking	BMC Normal

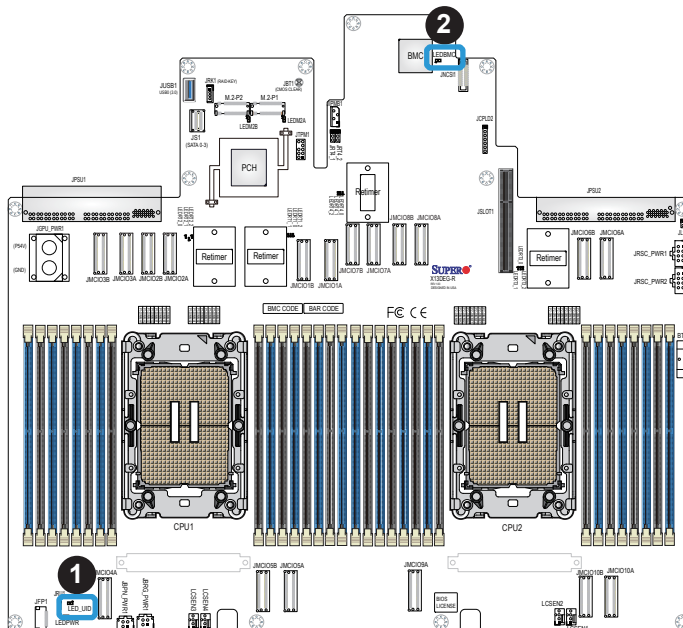

1. UID LED (UID_LED)
2. BMC Heartbeat LED (LEDBMC)

M.2 LED Indicators

Two M.2 LED indicators are located at LEDM2A and LEDM2B on the motherboard. When LEDM2A is blinking, M.2-P1 functions normally; while LEDM2B is blinking, M.2-P2 functions properly. Refer to the layout below for locations of LEDM2A and LEDM2B.

M.2 LED Indicators		
LED#	LED Color	State
LEDM2A	Green: Blinking	M.2-P1: M.2 device working properly
LEDM2B	Green: Blinking	M.2-P2: M.2 device working properly

Onboard Power LED

The Onboard Power LED is located at LEDPWR on the motherboard. When this LED is on, the system power is on. Be sure to turn off the system power and unplug the power cords before removing or installing components. Refer to the table below for more information.

Onboard Power LED Indicator	
LED Color	Definition
Off	System Power Off (power cable not connected)
Green	System Power On

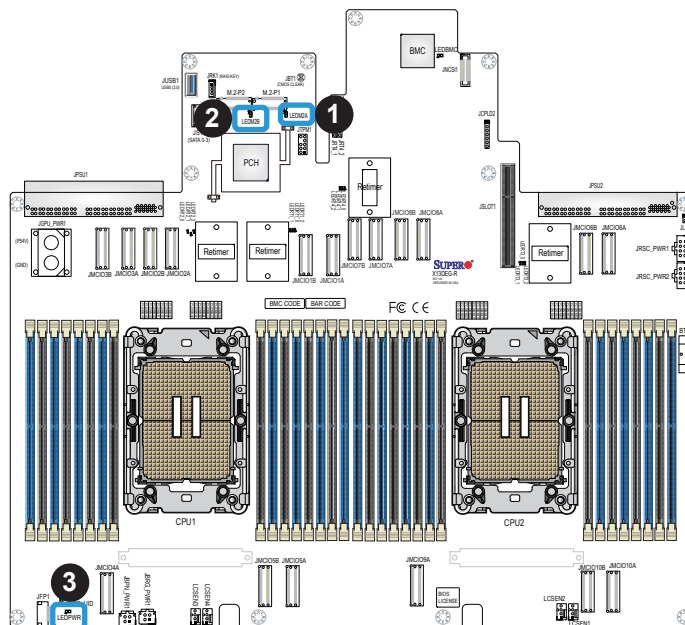

1. M.2-P1 LED (LEDM2A)
2. M.2-P2 LED (LEDM2B)
3. Power LED (LEDPWR)

Retimer Status LED Indicators

This motherboard supports four retimers for JMCIO1A/JMCIO1B, JMCIO2A/JMCIO2B, JMCIO6A/JMCIO6B, and JMCIO7A/JMCIO7B. The retimers can re-drive the PCIe signals from these MCIO connectors to the external GPU devices to help improve the quality of signals.

Retimer LED Indicators		
LED#	LED Status	State
LEDRT1_0	Solid On	Retimer (for JMCIO1A and JMCIO1B) working normally
LEDRT1_1	Blinking	
LEDRT1_2	Solid On	
LEDRT2_0	Solid On	Retimer (for JMCIO2A and JMCIO2B) working normally
LEDRT2_1	Blinking	
LEDRT2_2	Solid On	
LEDRT3_0	Solid On	Retimer (for JMCIO6A and JMCIO6B) working normally
LEDRT3_1	Blinking	
LEDRT3_2	Solid On	
LEDRT4_0	Solid On	Retimer (for JMCIO7A and JMCIO7B) working normally
LEDRT4_1	Blinking	
LEDRT4_2	Solid On	

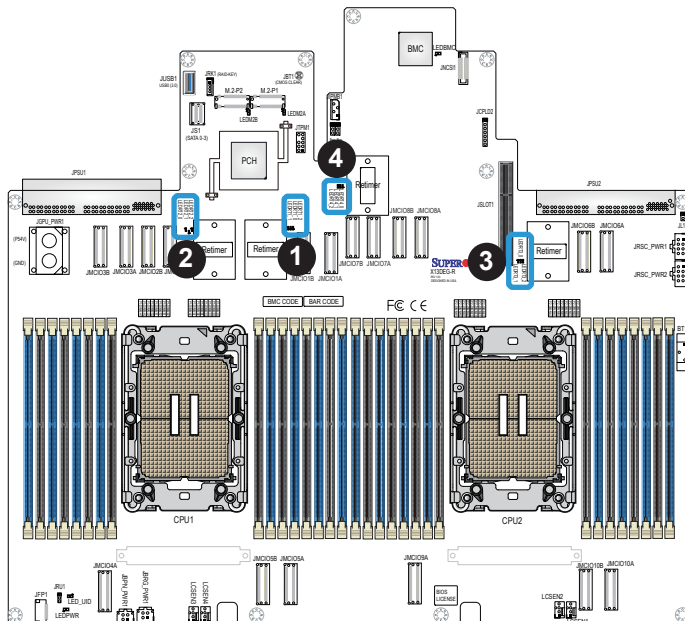

1. LEDRT1_0, LEDRT1_1, LEDRT1_2
2. LEDRT2_0, LEDRT2_1, LEDRT2_2
3. LEDRT3_0, LEDRT3_1, LEDRT3_2
4. LEDRT4_0, LEDRT4_1, LEDRT4_2

Chapter 3

Troubleshooting

3.1 Troubleshooting Procedures

Use the following procedures to troubleshoot your system. If you have followed all of the procedures below and still need assistance, refer to the 'Technical Support Procedures' and/or 'Returning Merchandise for Service' section(s) in this chapter. Always disconnect the AC power cord before adding, changing or installing any non hot-swap hardware components.

Before Power On

1. Make sure that there are no short circuits between the motherboard and chassis.
2. Disconnect all ribbon/wire cables from the motherboard, including those for the keyboard and mouse.
3. Remove all add-on cards.
4. Install the CPU (making sure it is fully seated) and connect the front panel connectors to the motherboard.

No Power

1. Make sure that there are no short circuits between the motherboard and the chassis.
2. Make sure that the ATX power connectors are properly connected.
3. Check that the 115V/230V switch, if available, on the power supply is properly set.
4. Turn the power switch on and off to test the system, if applicable.
5. The battery on your motherboard may be old. Check to verify that it still supplies approximately 3VDC. If it does not, replace it with a new one.

No Video

1. If the power is on, but you do not have video, remove all add-on cards and cables.
2. Remove all memory modules and turn on the system (if the alarm is on, check the specs of memory modules, reset the memory, or try a different one).

System Boot Failure

If the system does not display POST (Power-On-Self-Test) or does not respond after the power is turned on, check the following:

1. Remove all components from the motherboard, especially the DIMM modules. Power on the system and check if the power-on LED (LEDPWR) and the BMC Heartbeat LED (LEDBMC) are on, and system fans are spinning.
2. Turn on the system with only one DIMM module installed. If the system boots, check for bad DIMM modules or slots by following the Memory Errors Troubleshooting procedure in this chapter.

Memory Errors

1. Make sure that the memory modules are compatible with the system and are properly installed. See Chapter 2 for installation instructions. (For memory compatibility, refer to the "Tested Memory List" link on the motherboard's product page to see a list of supported memory.)
2. Check if different speeds of DIMMs have been installed. It is strongly recommended that you use the same RAM type and speed for all DIMM modules in the system.
3. Make sure that you are using the correct type of ECC DDR5 modules recommended by the manufacturer.
4. Check for bad DIMM modules or slots by swapping a single module among all memory slots and check the results.

Losing the System's Setup Configuration

1. Make sure that you are using a high-quality power supply. A poor-quality power supply may cause the system to lose the CMOS setup information. Refer to Chapter 1 for details on recommended power supplies.
2. The battery on your motherboard may be old. Check to verify that it still supplies approximately 3VDC. If it does not, replace it with a new one.

When the System Becomes Unstable

A. If the system becomes unstable during or after OS installation, check the following:

1. CPU/BIOS support: Make sure that your CPU is supported and that you have the latest BIOS installed in your system.
2. Memory support: Make sure that the memory modules are supported by testing the modules using memtest86 or a similar utility.



Note: Click on the "Tested Memory List" link on the motherboard's product page to see a list of supported memory.

3. HDD support: Make sure that all hard disk drives (HDDs) work properly. Replace the bad HDDs with good ones.
4. System cooling: Check the system cooling to make sure that all heatsink fans and CPU/system fans, etc., work properly. Check the hardware monitoring settings in the BMC to make sure that the CPU and system temperatures are within the normal range. Also check the front panel Overheat LED and make sure that it is not on.
5. Adequate power supply: Make sure that the power supply provides adequate power to the system. Make sure that all power connectors are connected. Please refer to our website for more information on the minimum power requirements.
6. Proper software support: Make sure that the correct drivers are used.

B. If the system becomes unstable before or during OS installation, check the following:

1. Source of installation: Make sure that the devices used for installation are working properly, including boot devices such as USB flash or media drives.
2. Cable connection: Check to make sure that all cables are connected and working properly.
3. Using the minimum configuration for troubleshooting: Remove all unnecessary components (starting with add-on cards first), and use the minimum configuration (but with the CPU and a memory module installed) to identify the trouble areas. Refer to the steps listed in Section A above for proper troubleshooting procedures.
4. Identifying bad components by isolating them: If necessary, remove a component in question from the chassis, and test it in isolation to make sure that it works properly. Replace a bad component with a good one.

5. Check and change one component at a time instead of changing several items at the same time. This will help isolate and identify the problem.
6. To find out if a component is good, swap this component with a new one to see if the system will work properly. If so, then the old component is bad. You can also install the component in question in another system. If the new system works, the component is good and the old system has problems.

3.2 Technical Support Procedures

Before contacting Technical Support, please take the following steps. Also, please note that as a motherboard manufacturer, Supermicro also sells motherboards through its channels, so it is best to first check with your distributor or reseller for troubleshooting services. They should know of any possible problems with the specific system configuration that was sold to you.

1. Please go through the Troubleshooting Procedures and Frequently Asked Questions (FAQ) sections in this chapter or see the FAQs on our website (<https://www.supermicro.com/FAQ/index.php>) before contacting Technical Support.
2. BIOS upgrades can be downloaded from our website (https://www.supermicro.com/ResourceApps/BIOS_BMC_Intel.html).
3. If you still cannot resolve the problem, include the following information when contacting Supermicro for technical support:
 - Motherboard model and PCB revision number
 - BIOS release date/version (This can be seen on the initial display when your system first boots up.)
 - System configuration
4. For immediate assistance, please have your account number ready when placing a call to our Technical Support department. We can be reached by email at support@supermicro.com.
5. For worldwide services and support, please visit our website at [Worldwide Services & Support | Supermicro](#).

3.3 Frequently Asked Questions

Question: What type of memory does my motherboard support?

Answer: This motherboard supports up to 8 TB 3DS RDIMM/RDIMM DDR5 (288-pin) DDR5 memory with speeds of up to 5600 MT/s in 32 DIMM slots. To enhance memory performance, do not mix memory modules of different speeds and sizes. Please follow all memory installation instructions given in Section 2.4.

Question: How do I update my BIOS?

Answer: It is recommended that you do not upgrade your BIOS if you are not experiencing any problems with your system. Updated BIOS files are located on our website at https://www.supermicro.com/ResourceApps/BIOS_BMC_Intel.html. Please check our BIOS warning message and the information on how to update your BIOS on our website. Select your motherboard model and download the BIOS file to your computer. Also, check the current BIOS revision to make sure that it is newer than your BIOS before downloading.



Note 1: The SPI BIOS chip used on this motherboard cannot be removed. Send your motherboard back to our RMA Department at Supermicro for repair.

Note 2: For BIOS Update and Recovery instructions, please refer to the Firmware Update and Recovery Instructions for Supermicro's X13 motherboard user's manuals posted at <https://www.supermicro.com/support/manuals/>.

3.4 Battery Removal and Installation

Battery Removal

To remove the onboard battery, follow the steps below:

1. Power off your system and unplug your power cable.
2. Locate the onboard battery as shown below.
3. Using a tool such as a pen or a small screwdriver, push the battery lock outwards to unlock it. Once unlocked, the battery will pop out from the holder.
4. Remove the battery.

Proper Battery Disposal

Warning: Please handle used batteries carefully. Do not damage the battery in any way; a damaged battery may release hazardous materials into the environment. Do not discard a used battery in the garbage or a public landfill. Please comply with the regulations set up by your local hazardous waste management agency to dispose of your used battery properly.

Battery Installation

To install an onboard battery, follow the steps below:

1. Power off your system and unplug your power cable.
2. Locate the onboard battery as shown below
3. Identify the battery's polarity. The positive (+) side should be facing up.
4. Insert the battery into the battery holder and push it down until you hear a click to ensure that the battery is securely locked.

Warning: When replacing a battery, be sure to only replace it with the same type.

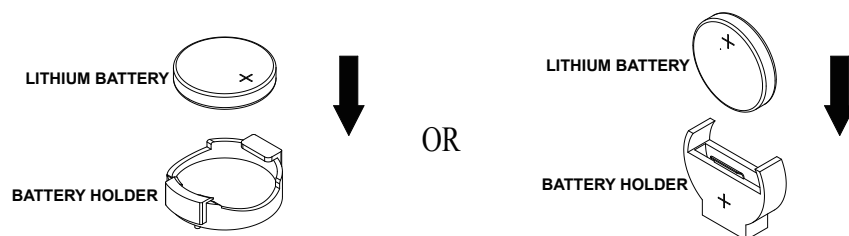

3.5 Returning Merchandise for Service

A receipt or copy of your invoice marked with the date of purchase is required before any warranty service will be rendered. You can obtain service by calling your vendor for a Returned Merchandise Authorization (RMA) number. When returning the motherboard to the manufacturer, the RMA number should be prominently displayed on the outside of the shipping carton, and the shipping package is mailed prepaid or hand-carried. Shipping and handling charges will be applied for all orders that must be mailed when service is complete. For faster service, you can also request a RMA authorization online (<https://www.supermicro.com/RmaForm/>).

This warranty only covers normal consumer use and does not cover damages incurred in shipping or from failure due to the alternation, misuse, abuse or improper maintenance of products.

During the warranty period, contact your distributor first for any product problems.

Chapter 4

UEFI BIOS

4.1 Introduction

This chapter describes the AMIBIOS™ Setup utility for the motherboard. The BIOS is stored on a chip and can be easily upgraded using the UEFI script (flash.nsh), the BMC WebUI, or the SuperServer Automation Assistant (SAA) utility.



Note: Due to periodic changes to the BIOS, some settings may have been added or deleted and might not yet be recorded in this manual. Please refer to the Manual Download area of our website for any changes to the BIOS that may not be reflected in this manual.

Starting the Setup Utility

To enter the BIOS Setup utility, press the <Delete> key while the system is booting up. In most cases, the <Delete> key is used to invoke the BIOS Setup screen; however, in other cases, other hot keys, such as <F1>, <F2>, may be used for this purpose. Each main BIOS menu option is described in this manual.

The Main BIOS screen has two main frames. The left frame displays all the options that can be configured. "Grayed-out" options cannot be configured. The right frame displays the key legend. Above the key legend is an area reserved for a text message. When an option is selected in the left frame, it is highlighted in white, and often a text message will accompany it. Please note that BIOS has default text messages built in, and we retain the option to include, omit, or change any of these text messages. Settings printed in **Bold** are the default values. A "▶" indicates a submenu. Highlighting such an item and pressing the <Enter> key will open the list of settings within that submenu.

The BIOS Setup utility uses a key-based navigation system called hot keys. Most of these hot keys (<F1>, <F2>, <F3>, <F4>, <Enter>, <ESC>, <Arrow> keys, etc.) can be used at any time during the setup navigation process.

4.2 Main Setup

When you first enter the AMI BIOS Setup utility, you will see the Main setup screen. You can always return to the Main setup screen by selecting the Main tab on the top of the screen. The Main BIOS Setup screen is shown below.

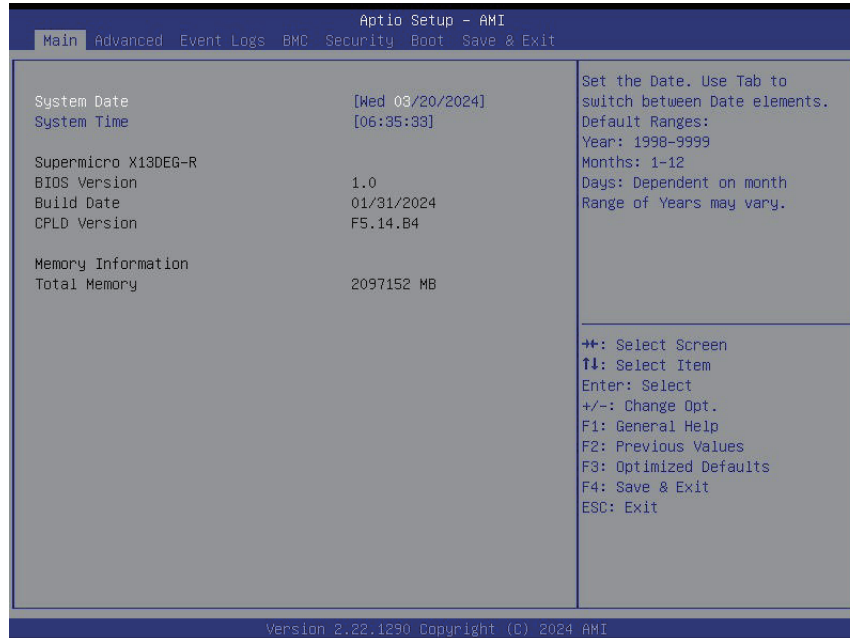

System Date / System Time

Use the two features to change the system date and time. To change system date and time settings, please highlight System Date or System Time using the arrow keys and enter new values using the keyboard. Press the <Tab> key or the arrow keys to move between fields. The date must be entered in Day MM/DD/YYYY format. The time is entered in HH:MM:SS format.

 **Note:** The time is in the 24-hour format. For example, 5:30 P.M. appears as 17:30:00. The date's default value is the BIOS build date after the RTC (Real Time Clock) reset.

Supermicro X13DEG-R

BIOS Version

This feature displays the version of the BIOS ROM used in the system.

Build Date

This feature displays the date when the version of the BIOS ROM used in the system was built.

CPLD Version

This feature displays the version of the Complex-Programmable Logical Device (CPLD) used in the system.

Memory Information

Total Memory

This feature displays the total size of memory available in the system.

4.3 Advanced Setup Configurations

Use the arrow keys to select the Advanced submenu and press <Enter> to access the submenu items:

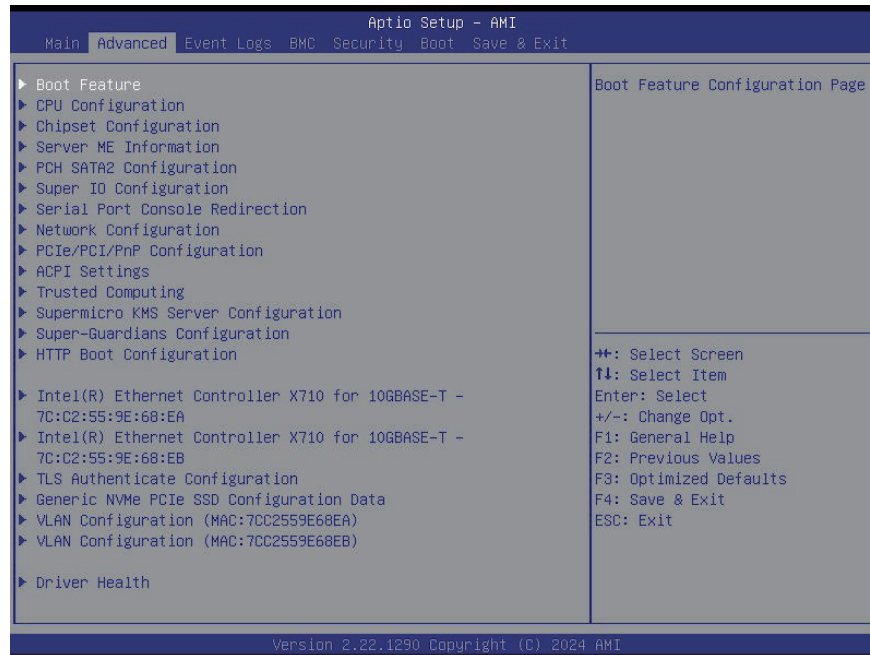

Warning: Take caution when changing the Advanced settings. An incorrect value, an improper DRAM frequency, or a wrong BIOS timing setting may cause the system to malfunction. When this occurs, restore the settings to the default manufacturing settings.

► Boot Feature

Quiet Boot

Use this feature to select the screen between displaying Power-on Self Test (POST) messages or the OEM logo at bootup. Select Disabled to display the POST messages. Select Enabled to display the OEM logo instead of the normal POST messages. The options are Disabled and **Enabled**.



Note: BIOS POST messages are always displayed regardless of the setting for this feature.

Option ROM Messages

Use this feature to set the display mode for the Option ROM. Select Keep Current to use the current AddOn ROM display settings. Select Force BIOS to use the Option ROM display mode set by the system BIOS. The options are **Force BIOS** and Keep Current.

Bootup NumLock State

Use this feature to set the Power-on state for the <NumLock> key. The options are **On** and Off.

Wait For "F1" If Error

Select Enabled to force the system to wait until the <F1> key is pressed if an error occurs. The options are **Disabled** and Enabled.

INT19 Trap Response

Interrupt 19 is the software interrupt that handles the boot disk function. When this feature is set to Immediate, the ROM BIOS of the host adaptors will "capture" Interrupt 19 at bootup immediately and allow the drives that are attached to these host adaptors to function as bootable disks. If this feature is set to Postponed, the ROM BIOS of the host adaptors will not capture Interrupt 19 immediately to allow the drives attached to these adaptors to function as bootable devices at bootup. The options are **Immediate** and Postponed.

Re-try Boot

When EFI (Extensible Firmware Interface) Boot is selected, the system BIOS will automatically reboot the system from an EFI boot device after an initial boot failure. Select Legacy Boot to allow the BIOS to automatically reboot the system from a Legacy boot device after an initial boot failure. The options are **Disabled**, Legacy Boot, and EFI Boot.

Power Configuration

Watch Dog Function

Select Enabled to allow the Watch Dog timer to reboot the system when it is inactive for more than five minutes. The options are **Disabled** and Enabled.

Watch Dog Action (Available when "Watch Dog Function" is set to Enabled)

Use this feature to configure the Watch Dog Time_out setting. The options are **Reset** and NMI.

Restore on AC Power Loss

Use this feature to set the power state after a power outage. Select Stay Off for the system power to remain off after a power loss. Select Power On for the system power to be turned on after a power loss. Select Last State to allow the system to resume its last power state before a power loss. The options are Power On, Stay Off, and **Last State**.

Power Button Function

This feature controls how the system shuts down when the power button is pressed. Select 4 Seconds Override to power off the system after pressing and holding the power button for four seconds or longer. Select Instant Off to instantly power off the system as soon as you press the power button. The options are **Instant Off** and 4 Seconds Override.

► CPU Configuration

Warning: Setting the wrong values for the features included in the following sections may cause the system to malfunction.

Processor Configuration

The following CPU information is displayed:

- Processor BSP Revision
- Processor Socket
- Processor ID
- Processor Frequency
- Processor Max Ratio
- Processor Min Ratio
- Microcode Revision
- L1 Cache RAM (Per Core)
- L2 Cache RAM (Per Core)
- L3 Cache RAM (Per Package)
- Processor 0 Version
- Processor 1 Version

► Advanced Power Management Configuration

Power Technology

Select Energy Efficient to support power-saving mode. Select Custom to customize system power settings. Select Disabled to disable power-saving settings. The options are Disable, Energy Efficient, and **Custom**.

Power Performance Tuning (Available when "Power Technology" is set to Custom)

Set this feature to allow either operating system (OS) or the BIOS to control the EPB. The options are **OS Controls EPB** and BIOS Controls EPB. (EPB is the abbreviation for Intel Performance and Energy Bias Hint.)

ENERGY_PERF_BIAS_CFG Mode (ENERGY PERFORMANCE BIAS CONFIGURATION Mode) (Available when "Power Performance Tuning" is set to BIOS Controls EPB)

Use this feature to configure the proper operation setting for your machine by achieving the desired system performance level and energy saving (efficiency) level at the same time. Select Maximum Performance to maximize system performance to its highest potential; however, this may consume maximal amount of power as energy is needed to fuel processor operation. Select Performance to enhance system performance; however, this may consume more power as energy is needed to fuel the processors for operation. The options are Extreme Performance, Maximum Performance, Performance, **Balanced Performance**, Balanced Power, Power, and Max Power Efficient. (Please note that the options of "Extreme Performance" and "Max Power Efficient" are motherboard-specific.)

Optimized Power Mode (Available when "Power Technology" is set to Custom)

Set this feature to Enable to reduce overall power consumption. The options are **Disable** and **Enable**.

▶ CPU P State Control

Use this submenu to configure the following CPU power settings:

AVX P1 (Available when "SpeedStep (P-States)" is set to Enable)

Use this feature to set the appropriate TDP level for the system. The Intel Advanced Vector Extensions (Intel AVX) P1 feature allows you to set the base P1 ratio for Streaming SIMD Extensions (SSE) and AVX workloads. Each P1 ratio has the corresponding AVX Impressed Current Cathodic Protection (ICCP) pre-grant license level, which refers to the selection between different AVX ICCP transition levels. The options are **Nominal**, Level 1, and Level 2.

SpeedStep (P-States)

Enhanced Intel SpeedStep Technology (EIST) allows the system to automatically adjust processor voltage and core frequency in an effort to reduce power consumption and heat dissipation. Please refer to Intel's website for detailed information. The options are **Disable** and **Enable**.

EIST PSD Function (Available when "SpeedStep (P-States)" is set to Enable)

This feature reduces the latency that occurs when one P-state changes to another, thus allowing the transitions to occur more frequently. This will allow for more demand-based P-state switching to occur based on the real-time energy needs of applications so that the power-to-performance balance can be optimized for energy efficiency. The options are **HW_ALL** and **SW_ALL**.

Turbo Mode (Available when "SpeedStep (P-States)" is set to Enable)

Select Enable to allow the CPU to operate at the manufacturer-defined turbo speed by increasing CPU clock frequency. This feature is available when it is supported by the processors used in the system. The options are Disable and **Enable**.

▶ Hardware PM State Control**Hardware P-States**

If this feature is set to Disable, system hardware will choose a P-state setting for the system based on an OS request. If this feature is set to Native Mode, hardware will choose a P-state setting based on the OS guidance. If this feature is set to Native Mode with No Legacy Support, system hardware will choose a P-state setting independently without OS guidance. The options are **Disable**, Native Mode, Out of Band Mode, and Native Mode with No Legacy Support.

▶ Frequency Prioritization**SST-CP**

With Intel Speed Select Technology (Intel SST-CP), surplus frequency is allocated based on the cores' weights. The weight for each core is assigned by the OS or the Virtual Machine Manager (VMM). The options are Enable and **Disable**.

▶ CPU C State Control**Enable Monitor MWAIT**

Select Enable to support Monitor and Mwait, which are two instructions in Streaming SIMD Extension 3 (SSE3), to improve synchronization between multiple threads for CPU performance enhancement. The options are Disable, Enable, and **Auto**.

CPU C1 Auto Demotion

Enable this feature to allow CPU to automatically demote to the C1 state. Reboot the system for the change to take effect. The options are Disable, Enable, and **Auto**.

CPU C6 Report

Select Enable to allow the BIOS to report the CPU C6 State (ACPI C3) to the operating system. During the CPU C6 State, the power to all cache is turned off. The options are Disable, Enable, and **Auto**. (ACPI is the abbreviation for Advanced Configuration and Power Interface.)

Enhanced Halt State (C1E)

Select Enable to enable "Enhanced Halt State" support, which will significantly reduce the CPU's power consumption by minimizing CPU's clock cycles and reduce voltage during a "Halt State". The options are Disable and **Enable**.

► Package C State Control

Package C State

Use this feature to optimize and reduce CPU package power consumption in the idle mode. Please note that the changes you've made in this setting will affect all CPU cores or the circuits of the entire system. The options are C0/C1 state, C2 state, C6 (non Retention) state, C6 (Retention) state, No Limit, and **Auto**.

► CPU1 Core Disable Bitmap / CPU2 Core Disable Bitmap

Available Bitmap:

This feature displays the available bitmap.

Disable Bitmap

Enter 0 to enable this feature for all CPU cores. Enter FFFFFFFFFF to disable this feature for all CPU cores. Please note that at least one core per CPU must be enabled. Disabling all cores is not allowed. The default setting is **0**.

Hyper-Threading [ALL]

Select Enable to use Intel Hyper-Threading Technology to enhance CPU performance. The options are **Enable** and Disable.

Hardware Prefetcher

If this feature is set to Enable, the hardware prefetcher will prefetch data from the main system memory to Level 2 cache to help expedite data transaction to enhance memory performance. The options are **Enable** and Disable.

Adjacent Cache Prefetch

Select Enable for the CPU to prefetch both cache lines for 128 bytes as comprised. Select Disable for the CPU to prefetch both cache lines for 64 bytes. The options are **Enable** and Disable.

DCU Streamer Prefetcher

If this feature is set to Enable, the Data Cache Unit (DCU) streamer prefetcher will prefetch data streams from the cache memory to the DCU to speed up data accessing and processing to enhance CPU performance. The options are **Enable** and Disable.

DCU IP Prefetcher

This feature allows the system to use the sequential load history, which is based on the instruction pointer of previous loads, to determine whether the system will prefetch additional lines. The options are **Enable** and Disable.

LLC Prefetch

If this feature is set to Enable, LLC (hardware cache) prefetching on all threads will be supported. The options are **Disable** and Enable.

Extended APIC

Based on the Intel Hyper-Threading technology, each logical processor (thread) is assigned 256 APIC IDs (APIDs) in 8-bit bandwidth. When this feature is set to Enable, the APIC ID will be expanded from 8 bits to 16 bits to provide 512 APIDs to each thread to enhance CPU performance. The options are Disable and **Enable**. (APIC is the abbreviation for Extended Advanced Programmable Interrupt Controller.)

Intel Virtualization Technology

Select Enable to enable the Intel Vanderpool Technology for Virtualization platform support, which will allow multiple operating systems to run simultaneously on the same computer to maximize system resources for performance enhancement. The options are Disable and **Enable**.



Note: Please reboot the system for any change of the setting to take effect.

Enable SMX

Select Enable to support Safer Mode Extensions (SMX) which provides a programming interface for system software to establish a controlled environment to support the trusted platform configured by the end user and to verify a virtual machine monitor before it is allowed to run. The options are **Disable** and Enable.

PPIN Control

Select Unlock/Enable to use the Protected Processor Inventory Number (PPIN) in the system. The PPIN is a unique number set for tracking a given Intel Xeon server processor. The options are Lock/Disable and **Unlock/Enable**.

AES-NI

Select Enable to use the Intel Advanced Encryption Standard (AES) New Instructions (NI) to ensure data security. The options are Disable and **Enable**.

Limit CPU PA to 46 Bits

Select Enable to limit CPU physical address to 46 bits to support the older Hyper-V CPU platform. The options are Disable and **Enable**.

TME, TME-MT, TDX

Memory Encryption (TME) (Available when your CPU supports Intel TME)

Select Enabled for Intel Total Memory Encryption (TME) support to enhance memory data security. The options are **Disabled** and Enabled.

Total Memory Encryption (TME) Bypass (Available when "Memory Encryption (TME)" is set to Enabled)

Use this feature to disable/enable the TME function for physical memory protection. The options are **Auto**, Disabled, and Enabled.

Total Memory Encryption Multi-Tenant (TME-MT) (Available when "Memory Encryption (TME)" is set to Enabled and when "Limit CPU PA to 46 Bits" is set to Disable)

Use this feature to support tenant-provided (SW-provided) keys. The options are **Disabled** and Enabled.

Memory Integrity (Available when both "Memory Encryption (TME)" and "Total Memory Encryption Multi-Tenant (TME-MT)" are set to Enabled and when "Limit CPU PA to 46 Bits" is set to Disable)

Use this feature to enable TME-MT memory integrity protection for memory transactions. The options are **Disabled** and Enabled.

Key Stock Amount (Available when "Memory Encryption (TME)" is set to Enabled and when your system supports this feature)

Use this feature to set the number of unique keys per system (the number of tenants per platform). The default setting is **0**.

TME-MT Key ID Bits (Available when "Memory Encryption (TME)" is set to Enabled)

Use this feature to set the number of bits for each key ID. The default setting is **0**.

Trust Domain Extension (TDX) (Available when your CPU supports Intel TDX)

Use this feature to enable Intel Trust Domain Extension (TDX) technology support to enhance control of data security. The options are **Disabled** and Enabled.

 **Note:** To support TDX features, DIMM population must be symmetric across integrated Memory Controllers (iMCs) and eight DIMMs per socket at least. For each memory controller, populating first slots (Px-DIMMX1) in all channels is required.

TDX Secure Arbitration Mode Loader (SEAM Loader) (Available when your CPU supports Intel TDX)

The SEAM Loader (SEAMLDR) is used to load and update Intel TDX modules into the SEAM memory range by verifying the digital signature. The options are **Disabled** and **Enabled**.

Disable Excluding Mem Below 1MB In CMR (Available when "Memory Encryption (TME)" is set to Enabled and when "Trust Domain Extension (TDX)" is set to Enabled)

Use this feature to enable/disable TDX Excluding CMR below 1MB. The options are **Disabled**, **Enabled**, and **Auto**.

TME-MT/TDX Key Split (Available when "Memory Encryption (TME)" is set to Enabled and when "Trust Domain Extension (TDX)" is set to Enabled)

Use this feature to set the number of bits for TDX. The other bits will be used by TME-MT. The default setting is **1**.

TME-MT Keys: (Available when "Memory Encryption (TME)" is set to Enabled and when "Trust Domain Extension (TDX)" is set to Enabled)

This feature displays the number of keys designated for TME-MT.

TDX Keys: (Available when "Memory Encryption (TME)" is set to Enabled and when "Trust Domain Extension (TDX)" is set to Enabled)

This feature displays the number of keys designated for TDX.

Software Guard Extension (SGX)

*The following SGX features are available when "Memory Encryption (TME)" is set to Enabled and when your CPU supports Intel SGX.

 **Note:** To support SGX features, DIMM population must be symmetric across integrated Memory Controllers (iMCs) and eight DIMMs per socket at least. For each memory controller, populating first slots (Px-DIMMX1) in all channels is required.

SGX Factory Reset

Use this feature to perform an SGX factory reset to delete all registration data and force an Initial Platform Establishment flow. Reboot the system for the changes to take effect. The options are **Disabled** and **Enabled**.

SW Guard Extensions (SGX)

Use this feature to enable Intel Software Guard Extensions (SGX) support. Intel SGX is a set of extensions that increases the security of application code and data by using enclaves in memory to protect sensitive information. The options are **Disabled** and **Enabled**.

SGX Package Info In-Band Access

Setting this feature to **Enabled** is required before the BIOS provides software with the key blobs, which are generated for each CPU package. The options are **Disabled** and **Enabled**.

PRM Size for SGX (Available when "SW Guard Extensions (SGX)" is set to Enabled)

Use this feature to set the Processor Reserved Memory Range Register (PRMRR) size. The options are **Auto**, 128M, 256M, 512M, 1G, 2G, 4G, 8G, 16G, 32G, 64G, 128G, 256G, and 512G. Please note that the available options are based on your motherboard features, memory size, and memory map.

SGX QoS (Available when "SW Guard Extensions (SGX)" is set to Enabled)

Use this feature to enable Intel SGX Quality of Service (QoS) support. QoS can enhance network performance by prioritizing network traffic. The options are **Disabled** and **Enabled**.

Select Owner EPOCH Input Type (Available when "SW Guard Extensions (SGX)" is set to Enabled)

Owner EPOCH is used as a parameter to allow you to add personal entropy into the key derivation process. A correct Owner EPOCH is required to have access to personal data previously sealed by other platform users. There are two Owner EPOCH modes. One is New Random Owner EPOCH, and the other is manually entered by the user. Each EPOCH is 64-bit. The options are **Change to New Random Owner EPOCHs** and **Manual User Defined Owner EPOCHs**.



Note: Changing the Owner EPOCH value will lose the data in enclaves.

Software Guard Extensions Epoch 0 (Available when "SW Guard Extensions (SGX)" is set to Enabled and "Select Owner EPOCH input type" is set to Manual User Defined Owner EPOCHs)

Use this feature to enter the EPOCH value. The default is **0**.

Software Guard Extensions Epoch 1 (Available when "SW Guard Extensions (SGX)" is set to Enabled and "Select Owner EPOCH input type" is set to Manual User Defined Owner EPOCHs)

Use this feature to enter the EPOCH value. The default is **0**.

SGXLEPUBKEYHASHx Write Enable (Available when "SW Guard Extensions (SGX)" is set to Enabled)

Use this feature to enable writes to SGXLEPUBKEYHASH[3..0] from OS/SW. The options are Disabled and **Enabled**. Only those CPUs that support Intel SGX Flexible Launch Control (FLC) feature have SGXLEPUBKEYHASH, which contains the hash of the public key for the SGX Launch Enclave (LE) to be signed with.

SGXLEPUBKEYHASH0 (Available when both "SW Guard Extensions (SGX)" and "SGXLEPUBKEYHASHx Write Enable" are set to Enabled)

Use this feature to enter the bytes 0–7 of SGX Launch Enclave Public Key Hash.

SGXLEPUBKEYHASH1 (Available when both "SW Guard Extensions (SGX)" and "SGXLEPUBKEYHASHx Write Enable" are set to Enabled)

Use this feature to enter the bytes 8–15 of SGX Launch Enclave Public Key Hash.

SGXLEPUBKEYHASH2 (Available when both "SW Guard Extensions (SGX)" and "SGXLEPUBKEYHASHx Write Enable" are set to Enabled)

Use this feature to enter the bytes 16–23 of SGX Launch Enclave Public Key Hash.

SGXLEPUBKEYHASH3 (Available when both "SW Guard Extensions (SGX)" and "SGXLEPUBKEYHASHx Write Enable" are set to Enabled)

Use this feature to enter the bytes 24–31 of SGX Launch Enclave Public Key Hash.

SGX Auto MP Registration (Available when "SW Guard Extensions (SGX)" is set to Enabled)

Use this feature to enable/disable SGX Auto Multi-Package Registration Agent (MPA) running automatically at boot time. The options are **Disabled** and Enabled.

► Chipset Configuration

Warning: Setting the wrong values in the following features may cause the system to malfunction.

► North Bridge

Use this submenu to configure the following North Bridge settings.

► Uncore Configuration

The following information is displayed.

- Number of CPU
- Current UPI Link Speed

- Current UPI Link Frequency
- Global MMIO Low Base / Limit
- Global MMIO High Base / Limit
- PCIe Configuration Base / Size

Degrade Precedence

Use this feature to select the degrading precedence option for Ultra Path Interconnect (UPI) connections. Select Topology Precedence to degrade UPI features if system options are in conflict. Select Feature Precedence to degrade UPI topology if system options are in conflict. The options are **Topology Precedence** and Feature Precedence.

Link L0p Enable

Select Enable for the system BIOS to enable Link L0p support which will allow the CPU to reduce the UPI links from full width to half width in the event when the CPU's workload is low in an attempt to save power. This feature is available for the system that uses Intel processors with UPI technology support. The options are Disable, Enable, **Auto**, and Full L0p Enable.

 **Note 1:** You can change the performance settings for non-standard applications by using this parameter. It is recommended that the default settings be used for standard applications.

Note 2: The option of Full L0p Enable is available when the 5th Gen. Intel Xeon Scalable Series processor is used.

Link L1 Enable

Select Enable for the BIOS to activate Link L1 support which will power down the UPI links to save power when the system is idle. This feature is available for the system that uses Intel processors with UPI technology support. The options are Disable, Enable, and **Auto**.

 **Note:** Link L1 is an excellent feature for an idle system. L1 is used during Package C-States when its latency is hidden by other components during a wakeup.

KTI Prefetch

Keizer Technology Interconnect (KTI) is also known as the Intel Ultra Path Interconnect (UPI) technology. Select Enable for the KTI prefetcher to preload the L1 cache with data deemed relevant, which will allow the memory read to start earlier on a DDR bus in an effort to reduce latency. Select Auto for the KTI prefetcher to automatically preload the L1 cache with relevant data whenever is needed. The options are Disable, Enable, and **Auto**.

IO Directory Cache (IODC)

Select Enable for the IODC to generate snoops instead of generating memory lockups for remote IIO (InvlToM) and/or WCiLF (Cores). Select Auto for the IODC to generate snoops (instead of memory lockups) for WCiLF (Cores). The options are Disable, **Auto**, Enable for Remote InvltoM Hybrid Push, InvltoM AllocFlow, Enable for Remote InvltoM Hybrid AllocNonAlloc, and Enable for Remote InvltoM and Remote WViLF.

SNC

Sub NUMA Clustering (SNC) is a feature that breaks up the Last Level Cache (LLC) into clusters based on address range. Each cluster is connected to a subset of the memory controller. Enable this feature to improve average latency and reduce memory access congestion for higher performance. The options are **Auto**, Disable, Enable SNC2 (2-clusters), and Enable SNC4 (4-clusters).

 **Note:** The option of Enable SNC4 (4-clusters) depends on your system configuration and the processor.

Stale AtoS (A to S)

The in-memory directory has three states: I, A, and S states. The I (-invalid) state indicates that the data is clean and does not exist in the cache of any other sockets. The A (-snoop All) state indicates that the data may exist in another socket in an exclusive or modified state. The S state (-Shared) indicates that the data is clean and may be shared in the caches across one or more sockets. When the system is performing "read" on the memory and if the directory line is in A state, we must snoop all other sockets because another socket may have the line in a modified state. If this is the case, a "snoop" will return the modified data. However, it may be the case that a line "reads" in an A state, and all the snoops come back with a "miss". This can happen if another socket reads the line earlier and then has silently dropped it from its cache without modifying it. If "Stale AtoS" is enabled, a line will transition to the S state when the line in the A state returns only snoop misses. That way, subsequent reads to the line will encounter it in the S state and will not have to snoop, saving the latency and snoop bandwidth. Stale "AtoS" may be beneficial in a workload where there are many cross-socket reads. The options are Disable, Enable, and **Auto**.

LLC Dead Line Alloc

Select Enable to opportunistically fill the dead lines in the LLC. The options are Disable, **Enable**, and Auto.

UPI3 (Available when your motherboard supports dual processors)

Use this feature to enable/disable the 4th Intel Ultra Path Interconnect (UPI) link. The default setting is Enable if your motherboard supports UPI3. The options are **Disable** and Enable. This feature depends on your system configuration.

► Memory Configuration

Use this submenu to configure the Integrated Memory Controller (IMC) settings.

Enforce DDR Memory Frequency POR

Select POR to enforce Plan of Record (POR) restrictions for DDR memory frequency and voltage programming. The options are **POR** and Disable.

Memory Frequency

Use this feature to set the maximum memory frequency for onboard memory modules. The options are **Auto**, 3200, 3600, 4000, 4400, 4800, 5200, and 5600. Note that the available options are CPU dependent.

Data Scrambling for DDR5

Select Enable to enable data scrambling for DDR5 modules to enhance memory data security. The options are Disable and **Enable**.

Enable ADR

Select Enable for Asynchronous DRAM Refresh (ADR) support to enhance memory performance. The options are Disable and **Enable**.

Legacy ADR Mode (Available when "Enable ADR" is set to Enable)

Use this feature to support the Legacy ADR mode to enhance memory performance. In the Legacy ADR mode, the ADR safe domain (flush domain) includes the WPQ in memory controllers. The options are Disable, Enable, and **Auto**.

DDR 2X Refresh Enable

Select Enable for memory 2X refresh support to enhance memory performance. The options are **Auto**, Disable, and Enable.

CXL Type 3 Legacy

Select Enable to use the CXL Type 3 memory device, which can be supported by the CXL Type 2 flows, for memory bandwidth and capacity expansion. The options are **Disable** and Enable.



Note: This feature depends on the CXL Type 2 flow and the memory device used.

Volatile Memory Mode

Use this feature to select the volatile memory mode. The options are **1LM** and 2LM. The option of 2LM is CPU-dependent.

 **Note:** This feature is available when your motherboard has the high bandwidth memory (HBM) CPU installed and when "NUMA" (Advanced > ACPI Settings > NUMA) is set to Enabled.

►Memory Topology

This submenu displays the information of onboard memory modules as detected by the BIOS, for example:

P1-DIMMA1: 4400MT/s Samsung DRx4 64GB RDIMM (OK)

►Page Policy

Page Policy

Use this feature to set your memory page policy. The options are **Closed** and Adaptive. The Closed Page Policy is good for random memory access patterns. The Adaptive Page Policy can reduce the average memory latency.

►Memory RAS Configuration

Use this submenu to configure the following Memory Reliability_Availability_Serviceability (RAS) settings.

Mirror Mode (Available when "ADDDC Sparing" is set to Disabled and "UEFI ARM Mirror" is set to Disabled)

Use this feature to configure the mirror mode settings for all 1LM/2LM memory modules in the system which will create a duplicate copy of data stored in the memory to increase memory security, but it will reduce the memory capacity into half. The options are **Disabled**, Full Mirror Mode, and Partial Mirror Mode.

UEFI ARM Mirror (Available when "ADDDC Sparing" is set to Disabled and "Mirror Mode" is set to Disabled)

If this feature is set to Enabled, mirror mode configuration settings for UEFI-based Address Range memory will be enabled upon system boot. This will create a duplicate copy of data stored in the memory to increase memory security, but it will reduce the memory capacity into half. The options are **Disabled** and Enabled.

ARM Mirror Percentage (Available when "UEFI ARM Mirror" is set to Enabled)

Use this feature to set the percentage of memory space to be used for UEFI ARM mirroring for memory security enhancement. The default setting is **0**.

Correctable Error Threshold

Use this feature to specify the threshold value for correctable memory-error logging, which sets a limit on the maximum number of events that can be logged in the memory error log at a given time. The default setting is **512**.

Leaky Bucket Low Bit

Use this feature to set the Low Bit value for the Leaky Bucket algorithm which is used to check the data transmissions between CPU sockets and the memory controller. The default setting is **11**.

Leaky Bucket High Bit

Use this feature to set the High Bit value for the Leaky Bucket algorithm which is used to check the data transmissions between CPU sockets and the memory controller. The default setting is **14**.

ADDDC Sparring (Available when populating 1Rx4, 2Rx4, and 4Rx4 DIMMs)

Select Enabled for Adaptive Double Device Data Correction (ADDDC) support, which will not only provide memory error checking and correction but will also prevent the system from issuing a performance penalty before a device fails. Note that virtual lock-step mode will only start to work for ADDDC after a faulty DRAM module is spared. The options are Disabled and **Enabled**.

Patrol Scrub

Patrol Scrubbing is a process that allows the CPU to correct correctable memory errors detected in a memory module and send the corrections to the requestor (the original source). When this feature is set to Enable, the IO hub will read and write back one cache line every 16K cycles if there is no delay caused by internal processing. By using this method, roughly 64 GB of memory behind the IO hub will be scrubbed every day. The options are Disabled and **Enable at End of POST**. (POST is the abbreviation for Power_On Self Test.)

DDR PPR Type

Post Package Repair (PPR) is a new feature available for the DDR4/DDR5 technology. PPR provides additional spare capacity within a DDR4/DDR5 DRAM module that is used to replace faulty cell areas detected during system boot. PPR offers two types of memory repairs. Soft Post Package Repair (sPPR) provides a quick, temporary fix on a raw element in a bank group of a DDR4/DDR5 DRAM device, while hard Post Package Repair (hPPR) will take a longer time to provide a permanent repair on a raw element. The options are PPR Disabled, **Hard PPR**, and Soft PPR.

Enhanced PPR

Use this feature to set advanced memory test. Select Enabled to always execute for every boot. The options are **Disabled**, Enabled, and Persistent.

Memory PFA Support (Available when the DCMS key is activated)

Select Enabled to enable memory Predictive Failure Analysis (PFA) support. PFA can be used to avoid uncorrectable faults in the same memory page. The options are **Disabled** and Enabled.

► IIO Configuration

► CPU1 Configuration / CPU2 Configuration

IOU2 (IIO PCIe Port 3)

This feature is CPU-dependent. Use this feature to configure the PCIe Bifurcation setting for a PCIe port specified by the user. The options are **Auto**, x4x4x4x4, x4x4x8, x8x4x4, x8x8, and x16.

IOU3 (IIO PCIe Port 4)

This feature is CPU-dependent. Use this feature to configure the PCIe Bifurcation setting for a PCIe port specified by the user. The options are **Auto**, x4x4x4x4, x4x4x8, x8x4x4, x8x8, and x16.

IOU4 (IIO PCIe Port 5)

This feature is CPU-dependent. Use this feature to configure the PCIe Bifurcation setting for a PCIe port specified by the user. The options are **Auto**, x4x4x4x4, x4x4x8, x8x4x4, x8x8, and x16.

► **Socket0 Port DMI / CPU1 SLOT1 PCIe 5.0 X16 / P1 NVMe0 / P1 NVMe1 / CPU1 SLOT2 PCIe 5.0 X16 / CPU2 SLOT3 PCIe 5.0 X16 / P2 NVMe0 / P2 NVMe1 / CPU2 SLOT4 PCIe 5.0 X16**



Note: The number of slots and the slot naming vary based on your motherboard features.

Link Speed

Use this feature to select the link speed for the PCIe port specified. The options are **Auto**, Gen 1 (2.5 GT/s), Gen 2 (5 GT/s), Gen 3 (8 GT/s), Gen 4 (16 GT/s), and Gen 5 (32 GT/s).

The following information is displayed:

- PCIe Port Link Status
- PCIe Port Link Max
- PCIe Port Link Speed

Data Link Feature Exchange

Use this feature to enable/disable the PCIe port to enter PCIe 4.0 DL_Feature negotiation state. The options are Disable and **Enable**.

PCIe Port Max Payload Size

Use this feature to set the maximum payload size supported in Direct Media Interface (DMI) device capabilities register for the device installed in the PCIe port. The options are 128B, 256B, 512B, and **Auto**.

Equalization Bypass To Highest Rate

Set this feature to Enable to reduce the link training time for PCIe 5.0 device by skipping equalization of intermediate data rates. The options are Disable and **Enable**.

► **IOAT Configuration**

Relaxed Ordering

Select Yes to allow certain transactions to be processed and completed before other transactions that have already been enqueued. The options are **No** and Yes.

► Intel VT for Directed I/O (VT-d)

Intel VT for Directed I/O (VT-d)

Select Enable to use Intel Virtualization Technology for Direct I/O VT-d support by reporting the I/O device assignments to the Virtual Machine Monitor (VMM) through the DMAR ACPI tables. This feature offers fully-protected I/O resource sharing across Intel platforms, providing greater reliability, security and availability in networking and data-sharing. The options are **Enable** and Disable. (DMA is the abbreviation for Direct Memory Access. DMAR is the abbreviation for DMA Remapping Reporting.)

Opt-Out Illegal MSI Mitigation (Available when "Intel VT for Directed I/O (VT-d)" is set to Enable)

If this feature is set to Enable, "Illegal OxzFEE Platform Mitigation" will be opted out. The options are **Disable** and Enable.

Pre-boot DMA Protection (Available when "Intel VT for Directed I/O (VT-d)" is set to Enable)

Select Enable to establish DMA protection during pre-boot processing by setting DMA_CTRL_PLATFORM_OPT_IN_FLAG in the DMAR ACPI table. The options are Enable and **Disable**.

Interrupt Remapping (Available when "Intel VT for Directed I/O (VT-d)" is set to Enable)

Select Enable to support I/O DMA transfer remapping and device-generated interrupts. The options are **Auto**, Enable, and Disable.

PCIe ACSCTL (Available when "Intel VT for Directed I/O (VT-d)" is set to Enable)

Select Enable to program ACS control to Chipset PCIe Root Port bridges. Select Disable to program ACS control to all PCIe Root Port bridges. The options are **Disable** and Enable.

► Intel VMD Technology

This section describes the configuration settings for the Intel VMD technology.



Note 1: After you've enabled VMD in the BIOS on a PCIe slot, this PCIe slot will be dedicated for VMD use only, and it will no longer support any PCIe device. To re-activate this slot for PCIe use, please disable VMD in the BIOS.

Note 2: The number of PCIe slots and the slot naming can differ depending on the PCIe devices connected to your motherboard.

NVMe Mode Switch

When this feature is set to Auto, VMD support will be automatically enabled when a VROC key is detected by the BIOS. The options are Manual, VMD, and **Auto**.

► Intel VMD for Volume Management Device on CPU1 (Available when "NVMe Mode Switch" is set to Manual)

VMD Config for PCH ports

Enable/Disable VMD

Select Enable to enable the Intel Volume Management Device (VMD) technology support for the root port specified. The options are **Disable** and Enable.

M.2-P1 VMD / M.2-P2 VMD (Available when the device is detected by the system and "Enable/Disable VMD" above is set to Enable)

Select Enable to enable the Intel VMD technology support for the root port specified. The options are **Disable** and Enable.

VMD Config for IOU 2 / VMD Config for IOU 3 / VMD Config for IOU 4

Enable/Disable VMD

Select Enable to enable the Intel VMD technology support for the root port specified. The options are **Disable** and Enable.

RSC-G-66G5+ SLOT1 PCIe 5.0 X16 VMD / P1 NVMe1 VMD / P1 NVMe2 VMD / RSC-G-66G5+ SLOT2 PCIe 5.0 X16 VMD (Available when the device is detected by the system and "Enable/Disable VMD" above is set to Enable)

Select Enable to enable the Intel VMD technology support for the root port specified. The options are **Disable** and Enable.

Hot Plug Capable (Available when the device is detected by the system and "Enable/Disable VMD" above is set to Enable)

Select Enable to enable Hot Plug support for the root ports specified, which allows you to change the devices on those root ports without shutting down the system. The options are **Disable** and Enable.

► Intel VMD for Volume Management Device on CPU2 (Available when "NVMe Mode Switch" is set to Manual)

VMD Config for IOU 2 / VMD Config for IOU 3 / VMD Config for IOU 4

Enable/Disable VMD

Select Enable to enable the Intel VMD technology support for the root port specified. The options are **Disable** and **Enable**.

RSC-G-66G5+ SLOT3 PCIe 5.0 X16 VMD / P2 NVMe1 VMD / P2 NVMe2 VMD / RSC-G-66G5+ SLOT4 PCIe 5.0 X16 VMD (Available when the device is detected by the system and "Enable/Disable VMD" above is set to Enable)

Select Enable to enable the Intel VMD technology support for the root port specified. The options are **Disable** and **Enable**.

Hot Plug Capable (Available when the device is detected by the system and "Enable/Disable VMD" above is set to Enable)

Select Enable to enable Hot Plug support for the root ports specified, which allows you to change the devices on those root ports without shutting down the system. The options are **Disable** and **Enable**.

► PCIe Leaky Bucket Configuration

Gen2 Link Degradation

Use this feature to enable PCIe Gen. 2 link degradation. The options are **Disable** and **Enable**.

Gen3 Link Degradation

Use this feature to enable PCIe Gen. 3 link degradation. The options are **Disable** and **Enable**.

Gen4 Link Degradation

Use this feature to enable PCIe Gen. 4 link degradation. The options are **Disable** and **Enable**.

Gen5 Link Degradation

Use this feature to enable PCIe Gen. 5 link degradation. The options are **Disable** and **Enable**.

IIO-PCIe Express Global Options

PCIe ASPM Support (Global)

Use this feature to disable the Active State Power Management (ASPM) support for all PCIe root ports. The options are **Disable** and **Auto**.

PCIe Max Read Request Size

Use this feature to set the maximum read request size in PCI hierarchy. The options are **Auto**, 128B, 256B, 512B, 1024B, 2048B, and 4096B.

Equalization Bypass To Highest Rate

Set this feature to **Enable** to reduce the link training time for PCIe 5.0 device by skipping equalization of intermediate data rates. The options are **Disable** and **Enable**.

IIO eDPC Support (Available when your system supports this feature)

Use this feature to configure the setting for IIO Enhanced Downstream Port Containment (eDPC) support for your system in an effort to improve the error containment capacity within the PCIe subsystem when an uncorrected error is detected either at the root port or at the switch downstream port. Select **Disable** to disable IIO eDPC support. Select **On Fatal Error** to enable IIO eDPC support in your system when a fatal error occurs. Select **On Fatal and Non-Fatal Error** to enable IIO eDPC support when an error, fatal or non-fatal, has occurred. The options are **Disable**, **On Fatal Error**, and **On Fatal and Non-Fatal Errors**.

CXL Security Level

By defining security protocols, CXL standards provide protection against the data security threats. Use this feature to set the CXL security level for data transiting the CXL link. The options are **Fully Trusted**, **Partially Trusted**, **Untrusted**, and **Auto**.

- **Fully Trusted**: This option allows the CXL device to access CXL.\$ for both host-attached and device-attached memory ranges in the write-back (WB) address space.
- **Partially Trusted**: This option allows the CXL device to access CXL.\$ for device-attached memory ranges only.
- **Untrusted**: If this option is selected, the host (your system) will abort all requests on CXL.\$.
- **Auto**: This option is based on Si Compatibility.

CXL Header Bypass

Set this feature to enable or disable the CXL header bypass. The options are **Disable** and **Enable**.

► South Bridge

The following information is displayed:

- USB Module Version
- USB Devices:

Legacy USB Support

Select Enabled to support onboard legacy USB devices. Select Auto to disable legacy support if there are no legacy USB devices present. Select Disabled to have all USB devices available for EFI applications only. The options are **Enabled**, Disabled, and Auto.

XHCI Hand-off

This is a work-around solution for operating systems that do not support Extensible Host Controller Interface (XHCI) hand-off. The XHCI ownership change should be claimed by the XHCI driver. The options are **Enabled** and Disabled.

Port 60/64 Emulation

Select Enabled for I/O port 60h/64h emulation support, which in turn, provides complete legacy USB keyboard support for the operating systems that do not support legacy USB devices. The options are **Disabled** and Enabled.

PCIe PLL SSC

Use this feature to set the PCH PCIe Spread Spectrum Clocking (SSC) support, which allows the BIOS to monitor and attempt to reduce the level of electromagnetic interference caused by the components whenever needed. The options are Disabled, 0.3%, 0.5%, and **Auto**.

► Server ME Information

The following information is displayed:

- General ME Configuration
- Oper. Firmware Version
 - Current State
 - Error Code

► PCH SATA2 Configuration

When this submenu is selected, the AMI BIOS automatically detects the presence of the SATA devices that are supported by the Intel PCH chip and displays the following features.

SATA Controller(s)

Use this feature to enable or disable the onboard SATA controller(s) supported by the Intel PCH chip. The options are **Enabled** and Disabled.

SATA Mode Selection (Available when "SATA Controller(s)" is set to Enabled)

Use this feature to select the mode of installed SATA drives. The options are **AHCI** and RAID.

Support Aggressive Link Power Management (Available when "SATA Controller(s)" is set to Enabled)

When this feature is set to Enabled, the SATA AHCI controller manages the power use of the SATA link. The controller will put the link in a low power mode during an extended period of I/O inactivity, and will return the link to an active state when I/O activity resumes. The options are **Disabled** and Enabled.

SATA SGPIO Mode (Available when "SATA Controller(s)" is set to Enabled)

Use this feature to change the serial GPIO mode for SATA controller. The options are LED and **SGPIO**.

SATA Port 0 – SATA Port 3 (Available when "SATA Controller(s)" is set to Enabled)



Note: The SATA port naming may vary based on the related configuration.

Hot Plug

Select Enabled to support hot-plugging for the device installed on a selected SATA port to replace the device installed in the slot without shutting down the system. The options are Disabled and **Enabled**.

Spin Up Device

Select Enabled for staggered spin-up support to allow the specified SATA devices to spin up one at a time at boot up in an effort to prevent all hard drive disks from spinning up at the same time, causing a power surge. The options are **Disabled** and Enabled.

SATA Device Type

Use this feature to specify if the device installed on the SATA port specified by the user should be connected to a solid state drive or a hard disk drive. The options are **Hard Disk Drive** and Solid State Drive.

► Super IO Configuration (Available when your system supports this feature)

The following information is displayed.

- Super IO Chip

► Serial Port 1 Configuration

Serial Port 1

Select Enabled to enable serial port 1. The options are Disabled and **Enabled**.

Device Settings (Available when "Serial Port 1" above is set to Enabled)

This feature displays the base I/O port address and the Interrupt Request address of serial port 1.

Change Settings (Available when "Serial Port 1" above is set to Enabled)

This feature specifies the base I/O port address and the Interrupt Request address of serial port 1. Select Auto for the BIOS to automatically assign the base I/O and IRQ address to serial port 1. The options are **Auto**, (IO=3F8h; IRQ=4;), (IO=3F8h; IRQ=3, 4, 5, 6, 7, 9, 10, 11, 12;), (IO=2F8h; IRQ=3, 4, 5, 6, 7, 9, 10, 11, 12;), (IO=3E8h; IRQ=3, 4, 5, 6, 7, 9, 10, 11, 12;), and (IO=2E8h; IRQ=3, 4, 5, 6, 7, 9, 10, 11, 12;).

► Serial Port 2 Configuration



Note: It can be "Serial Port 2 Configuration" or "SOL Configuration" based on your system support.

Serial Port/SOL ("Serial Port" or "SOL" based on your system support)

Select Enabled to enable serial port 2 (or SOL). The options are Disabled and **Enabled**.

Device Settings (Available when "Serial Port/SOL" is set to Enabled)

This feature displays the base I/O port address and the Interrupt Request address of serial port 2 (or SOL).

Change Settings (Available when "Serial Port/SOL" is set to Enabled)

This feature specifies the base I/O port address and the Interrupt Request address of serial port 2 (or SOL). Select Auto for the BIOS to automatically assign the base I/O and IRQ address to serial port 2. The options are **Auto**, (IO=2F8h; IRQ=3;), (IO=3F8h; IRQ=3, 4, 5, 6, 7, 9, 10, 11, 12;), (IO=2F8h; IRQ=3, 4, 5, 6, 7, 9, 10, 11, 12;), (IO=3E8h; IRQ=3, 4, 5, 6, 7, 9, 10, 11, 12;), and (IO=2E8h; IRQ=3, 4, 5, 6, 7, 9, 10, 11, 12;).

Serial Port 2 Attribute (Available for Serial Port 2 only)

Select SOL to use serial port 2 as a Serial Over LAN (SOL) port for console redirection. The options are **SOL** and **COM**.

► Serial Port Console Redirection

COM1 (Available when your system supports the serial port of COM1)

Console Redirection

Select Enabled to enable COM port 1 for Console Redirection, which allows a client machine to be connected to a host machine at a remote site for networking. The options are **Disabled** and **Enabled**.



Note: This feature will be set to Enabled if there is no BMC support.

► Console Redirection Settings (Available when "Console Redirection" above is set to Enabled)

Terminal Type

Use this feature to select the target terminal emulation type for Console Redirection. Select VT100 to use the ASCII Character set. Select VT100+ to add color and function key support. Select ANSI to use the Extended ASCII Character Set. Select VT-UTF8 to use UTF8 encoding to map Unicode characters into one or more bytes. The options are VT100, **VT100+**, VT-UTF8, and ANSI.

Bits Per Second

Use this feature to set the transmission speed for a serial port used in Console Redirection. Make sure that the same speed is used in the host computer and the client computer. A lower transmission speed may be required for long and busy lines. The options are 9600, 19200, 38400, 57600, and **115200** (bits per second).

Data Bits

Use this feature to set the data transmission size for Console Redirection. The options are 7 and **8** (bits).

Parity

A parity bit can be sent along with regular data bits to detect data transmission errors. Select Even if the parity bit is set to 0 and the number of 1s in data bits is even. Select Odd if the parity bit is set to 0 and the number of 1s in data bits is odd. Select None if you do not want to send a parity bit with your data bits in transmission. Select Mark to add a mark as a parity bit to be sent along with the data bits. Select Space to add a space as a parity bit to be sent with your data bits. The options are **None**, Even, Odd, Mark, and Space.

Stop Bits

A stop bit indicates the end of a serial data packet. Select 1 (stop bit) for standard serial data communication. Select 2 (stop bits) if slower devices are used. The options are **1** and **2**.

Flow Control

Use this feature to set the flow control for Console Redirection to prevent data loss caused by buffer overflow. Send a "Stop" signal to stop sending data when the receiving buffer is full. Send a "Start" signal to start sending data when the receiving buffer is empty. The options are **None** and Hardware RTS/CTS.

VT-UTF8 Combo Key Support

Select Enabled to enable VT-UTF8 Combination Key support for ANSI/VT100 terminals. The options are Disabled and **Enabled**.

Recorder Mode

Select Enabled to capture the data displayed on a terminal and send it as text messages to a remote server. The options are **Disabled** and Enabled.

Resolution 100x31

Select Enabled for extended-terminal resolution support. The options are Disabled and **Enabled**.

Putty KeyPad

This feature selects Function Keys and KeyPad settings for Putty, which is a terminal emulator designed for the Windows OS. The options are **VT100**, LINUX, XTERMR6, SCO, ESCN, and VT400.

SOL/COM2

Note: This feature is available when your system supports serial port of SOL and/or COM2. The "SOL/COM2" here indicates a shared serial port, and SOL is used as the default.

Console Redirection

Select Enabled to use the SOL/COM2 port for Console Redirection. The options are Disabled and **Enabled**.

► Console Redirection Settings (Available when "Console Redirection" above is set to Enabled)

Terminal Type

Use this feature to select the target terminal emulation type for Console Redirection. Select VT100 to use the ASCII Character set. Select VT100+ to add color and function key support. Select ANSI to use the Extended ASCII Character Set. Select VT-UTF8 to use UTF8 encoding to map Unicode characters into one or more bytes. The options are VT100, **VT100+**, VT-UTF8, and ANSI.

Bits Per Second

Use this feature to set the transmission speed for a serial port used in Console Redirection. Make sure that the same speed is used in the host computer and the client computer. A lower transmission speed may be required for long and busy lines. The options are 9600, 19200, 38400, 57600, and **115200** (bits per second).

Data Bits

Use this feature to set the data transmission size for Console Redirection. The options are 7 and **8** (bits).

Parity

A parity bit can be sent along with regular data bits to detect data transmission errors. Select Even if the parity bit is set to 0 and the number of 1s in data bits is even. Select Odd if the parity bit is set to 0 and the number of 1s in data bits is odd. Select None if you do not want to send a parity bit with your data bits in transmission. Select Mark to add a mark as a parity bit to be sent along with the data bits. Select Space to add a space as a parity bit to be sent with your data bits. The options are **None**, Even, Odd, Mark, and Space.

Stop Bits

A stop bit indicates the end of a serial data packet. Select 1 (stop bit) for standard serial data communication. Select 2 (stop bits) if slower devices are used. The options are **1** and 2.

Flow Control

Use this feature to set the flow control for Console Redirection to prevent data loss caused by buffer overflow. Send a "Stop" signal to stop sending data when the receiving buffer is full. Send a "Start" signal to start sending data when the receiving buffer is empty. The options are **None** and Hardware RTS/CTS.

VT-UTF8 Combo Key Support

Select Enabled to enable VT-UTF8 Combination Key support for ANSI/VT100 terminals. The options are Disabled and **Enabled**.

Recorder Mode

Select Enabled to capture the data displayed on a terminal and send it as text messages to a remote server. The options are **Disabled** and Enabled.

Resolution 100x31

Select Enabled for extended-terminal resolution support. The options are Disabled and **Enabled**.

Putty KeyPad

Use this feature to select function key and keypad settings on Putty, which is a terminal emulator designed for the Windows OS. The options are **VT100**, LINUX, XTERMR6, SCO, ESCN, and VT400.

Legacy Console Redirection

► Legacy Console Redirection Settings

Legacy Serial Redirection Port

Use this feature to select a COM port to display redirection of Legacy OS and Legacy OPROM messages. The options are **COM1** and SOL/COM2. Please note that the available options are based on your motherboard features.

Resolution

Use this feature to select the numbers of rows and columns used in Console Redirection for Legacy OS support. The options are 80x24 and **80x25**.

Redirection After BIOS POST

Use this feature to enable or disable legacy console redirection after BIOS POST. When the option - BootLoader is selected, legacy console redirection is disabled before booting the OS. When the option - Always Enable is selected, legacy console redirection remains enabled upon OS bootup. The options are **Always Enable** and BootLoader.

Serial Port for Out-of-Band Management/Windows Emergency Management Services (EMS)

The feature allows you to configure Console Redirection settings to support Out-of-Band Serial Port management.

Console Redirection EMS

Select Enabled to use the SOL port for Console Redirection. The options are **Disabled** and Enabled.

► Console Redirection Settings (Available when "Console Redirection EMS" above is set to Enabled)

Out-of-Band Mgmt Port

The feature selects a serial port in a client server to be used by the Microsoft Windows Emergency Management Services (EMS) to communicate with a remote host server. The options are **COM1** and SOL/COM2. Please note that the option of SOL/COM2 indicates a shared serial port. SOL is available with BMC support.

Terminal Type EMS

Use this feature to select the target terminal emulation type for Console Redirection. Select VT100 to use the ASCII character set. Select VT100+ to add color and function key support. Select ANSI to use the extended ASCII character set. Select VT-UTF8 to use UTF8 encoding to map Unicode characters into one or more bytes. The options are VT100, VT100+, **VT-UTF8**, and ANSI.

Bits Per Second EMS

This feature sets the transmission speed for a serial port used in Console Redirection. Make sure that the same speed is used in the host computer and the client computer. A lower transmission speed may be required for long and busy lines. The options are 9600, 19200, 57600, **115200**, 230400, 460800, and 921600 (bits per second).

Flow Control EMS

Use this feature to set the flow control for Console Redirection to prevent data loss caused by buffer overflow. Send a "Stop" signal to stop sending data when the receiving buffer is full. Send a "Start" signal to start sending data when the receiving buffer is empty. The options are **None**, Hardware RTS/CTS, and Software Xon/Xoff.

The following information is displayed:

Data Bits EMS / Parity EMS / Stop Bits EMS

► Network Configuration

Network Stack

Select Enabled to enable Preboot Execution Environment (PXE) or Unified Extensible Firmware Interface (UEFI) for network stack support. The options are Disabled and **Enabled**.

IPv4 PXE Support (Available when "Network Stack" is set to Enabled)

Select Enabled to enable IPv4 PXE boot support. If this feature is disabled, it will not create the IPv4 PXE boot option. The options are Disabled and **Enabled**.

IPv4 HTTP Support (Available when "Network Stack" is set to Enabled)

Select Enabled to enable IPv4 HTTP boot support. If this feature is disabled, it will not create the IPv4 HTTP boot option. The options are **Disabled** and Enabled.

IPv6 PXE Support (Available when "Network Stack" is set to Enabled)

Select Enabled to enable IPv6 PXE boot support. If this feature is disabled, it will not create the IPv6 PXE boot option. The options are **Disabled** and Enabled.

IPv6 HTTP Support (Available when "Network Stack" is set to Enabled)

Select Enabled to enable IPv6 HTTP boot support. If this feature is disabled, it will not create the IPv6 HTTP boot option. The options are **Disabled** and Enabled.

PXE Boot Wait Time (Available when "Network Stack" is set to Enabled)

Use this feature to set the wait time (in seconds) upon which the system BIOS will wait for you to press the <ESC> key to abort PXE boot instead of proceeding with PXE boot by connecting to a network server immediately. Press the <+> or <-> key on your keyboard to change the value. The default setting is **0**.

Media Detect Count

Use this feature to select the wait time (in seconds) for the BIOS ROM to detect the presence of a LAN media either via the Internet connection or via a LAN port. Press the <+> or <-> key on your keyboard to change the value. The default setting is **1**.

► MAC:(MAC address)-IPv6 Network Configuration**► Enter Configuration Menu**

The following information is displayed:

Interface Name / Interface Type / MAC address / Host address / Route Table / Gateway addresses / DNS addresses

Interface ID

Use this feature to change/enter the 64-bit alternative interface ID for the device. The string format is colon separated. The default setting is the MAC address above.

DAD Transmit Count

This feature displays the number of consecutive neighbor solicitation messages have been sent while performing duplicate address detection on a tentative address. The default setting is **1**.

Policy

Use this feature to select how the policy is to be configured. The options are **automatic** and manual.

► **Advanced Configuration (Available when "Policy" is set to manual)**

New IPv6 address

Use this feature to enter the IPv6 address for the local machine.

New Gateway addresses

Use this feature to set the gateway address for the local machine.

New DNS addresses

Use this feature to set the DNS server address for the local machine.

Commit Changes and Exit

Press <Enter> to save changes and exit.

Discard Changes and Exit

Press <Enter> to discard changes and exit.

Save Changes and Exit

Press <Enter> to save changes and exit. The options are **Yes** and No.

► **MAC:(MAC address)-IPv4 Network Configuration**

Configured

Select Enabled to show whether the network address has been successfully configured. The options are **Disabled** and Enabled.

Enable DHCP (Available when "Configured" is set to Enabled)

Select Enabled to support Dynamic Host Configuration Protocol (DHCP) which allows the BIOS to search for a DHCP server attached to the network and request the next available IP address for this computer. The options are **Disabled** and Enabled.

Local IP Address (Available when "Configured" is set to Enabled and "Enable DHCP" is set to Disabled)

Use this feature to enter an IP address for the local machine.

Local NetMask (Available when "Configured" is set to Enabled and "Enable DHCP" is set to Disabled)

Use this feature to set the netmask for the local machine.

Local Gateway (Available when "Configured" is set to Enabled and "Enable DHCP" is set to Disabled)

Use this feature to set the gateway address for the local machine.

Local DNS Servers (Available when "Configured" is set to Enabled and "Enable DHCP" is set to Disabled)

Use this feature to set the Domain Name System (DNS) server address for the local machine.

Save Changes and Exit

Press <Enter> to save changes and exit. The options are **Yes** and **No**.

► PCIe/PCI/PnP Configuration

The following information is displayed:

- PCI Bus Driver Version

PCI Devices Common Settings:**Above 4G Decoding (Available when the system supports 64-bit PCI decoding)**

Select Enabled to decode a PCI device that supports 64-bit in the space above 4G Address. The options are Disabled and **Enabled**.

Re-Size BAR Support

Use this feature to enable the Resizable BAR support. Resizable BAR is a PCIe interface technology that allows the CPU to access to the entire frame buffer. With this technology, your system will be able to handle multiple CPU to GPU transfers simultaneously rather than queuing, which can improve the frame rate performance. The options are **Disabled** and **Enabled**.

MMCFG Base

This feature determines how the lowest Memory Mapped Configuration (MMCFG) base is assigned to onboard PCI devices. The options are 1G, 1.5G, 1.75G, 2G, 2.25G, 3G, and **Auto**.

MMCFG Size

Use this feature to set the MMCFG size. The options are 128M, 256M, 512M, 1G, 2G, and **Auto**. Please note that the MMCFG size is based on the memory populated.



Note 1: The options shown here depend on your memory size.

Note 2: The option of 64M is not available on the motherboard with dual processors.

MMIO High Base

Use this feature to select the base memory size according to memory-address mapping for the I/O hub. The options are 56T, 40T, 32T, 24T, 16T, **4T**, 2T, 1T, and 512G.

MMIO High Granularity Size

Use this feature to select the high memory size according to memory-address mapping for the I/O hub. The options are 4G, 16G, 64G, 256G, **1024G**, and 2048G.

SR-IOV Support

Select Enabled for Single-Root I/O Virtualization support. The options are Disabled and **Enabled**.

Bus Master Enable

If it is set to Enabled, the PCI Bus Driver will enable the Bus Master Attribute for DMA transactions. If it is set to Disabled, the PCI Bus Driver will disable the Bus Master Attribute for Pre-Boot DMA protection. The options are Disabled and **Enabled**.

ARI Support

Select Enabled for Alternative Routing-ID Interpretation (ARI) support. The options are Disabled and **Enabled**.

Consistent Device Name Support

Select Enabled for ACPI_DSM (DSM: Device Specific Method) device name support for onboard devices and slots. The options are **Disabled** and Enabled.

NVMe Firmware Source

Use this feature to select the NVMe firmware to support system boot. The options are **Vendor Defined Firmware** and AMI Native Support. The default option, Vendor Defined Firmware, is pre-installed on the drive and may resolve errata or enable innovative functions for the drive. The other option, AMI Native Support, is offered by the BIOS with a generic method.

VGA Priority

Use this feature to select the graphics device to be used as the primary video display for system boot. The options are **Onboard** and Offboard.

For the following features, please note that:



Note: The number of slots and slot naming vary based on your motherboard features.

Onboard Video Option ROM

Select EFI to boot the computer using the Extensible Firmware Interface (EFI) device installed on the onboard video port. The options are Disabled, **EFI**, and Legacy.

PCI Devices Option Rom Setting

AOM-PTG-i2T OPROM / M.2-P2 PCIe 3.0 X4 OPROM / GPU-1 OPROM / GPU-2 OPROM / GPU-3 OPROM / GPU-4 OPROM

Select EFI to boot the computer using the EFI device installed on the PCIe slot specified. The options are Disabled, Legacy, and **EFI**.

▶ACPI Settings

NUMA

Use this feature to enable Non-Uniform Memory Access (NUMA) to enhance system performance. The options are Disabled and **Enabled**.

UMA-Based Clustering

When this feature is set to Hemisphere, Uniform Memory Access (UMA)-based clustering will support 2-cluster configuration for system performance enhancement. The options are Disabled (All2All), Hemisphere (2-clusters), and **Quadrant (4-clusters)**.

WHEA Support

Select Enabled to support the Windows Hardware Error Architecture (WHEA) platform and provide a common infrastructure for the system to handle hardware errors within the Windows OS environment to reduce system crashes and to enhance system recovery and health monitoring. The options are Disabled and **Enabled**.

High Precision Event Timer

Select Enabled to activate the High Precision Event Timer (HPET) that produces periodic interrupts at a much higher frequency than a Real-time Clock (RTC) does in synchronizing multimedia streams, providing smooth playback and reducing the dependency on other timestamp calculation devices, such as an x86 RDTSC Instruction embedded in the CPU. The HPET is used to replace the 8254 Programmable Interval Timer. The options are Disabled and **Enabled**.

► Trusted Computing (Available when a TPM device is installed and detected by the BIOS)

When a Trusted-Platform Module (TPM) device is detected by your system, the following information is displayed:

- TPM 2.0 Device Found
- Firmware Version:
- Vendor:

Security Device Support

Select Enable to enable BIOS support for onboard security devices, which are not displayed in the OS. If this feature is set to Enable, TCG EFI protocol and INT1A interface will not be available. The options are Disable and **Enable**.

*When "Security Device Support" is set to Enable, the following information is displayed:

- Active PCR banks
- Available PCR banks

SHA-1 PCR Bank (Available when "Security Device Support" is set to Enable)

Select Enabled to enable SHA-1 PCR Bank support to enhance system integrity and data security. The options are Disabled and **Enabled**.

SHA256 PCR Bank (Available when "Security Device Support" is set to Enable)

Select Enabled to enable SHA256 PCR Bank support to enhance system integrity and data security. The options are Disabled and **Enabled**.

Pending Operation (Available when "Security Device Support" is set to Enable)

Use this feature to schedule a TPM-related operation to be performed by a security (TPM) device at the next system boot to enhance system data integrity. The options are **None** and TPM Clear.



Note: Your system will reboot to carry out a pending TPM operation.

Platform Hierarchy (Available when "Security Device Support" is set to Enable) (for TPM version 2.0 and above)

Select Enabled for TPM Platform Hierarchy support which allows the manufacturer to utilize the cryptographic algorithm to define a constant key or a fixed set of keys to be used for initial system boot. These early boot codes are shipped with the platform and are included in the list of "public keys". During system boot, the platform firmware uses the trusted public keys to verify a digital signature in an attempt to manage and control the security of the platform firmware used in a host system via a TPM device. The options are Disabled and **Enabled**.

Storage Hierarchy (Available when "Security Device Support" is set to Enable)

Select Enabled for TPM Storage Hierarchy support that is intended to be used for non-privacy-sensitive operations by a platform owner such as an IT professional or the end user. Storage Hierarchy has an owner policy and an authorization value, both of which can be set and are held constant (-rarely changed) through reboots. This hierarchy can be cleared or changed independently of the other hierarchies. The options are Disabled and **Enabled**.

Endorsement Hierarchy (Available when "Security Device Support" is set to Enable)

Select Enabled for Endorsement Hierarchy support, which contains separate controls to address the user's privacy concerns because the primary keys in the hierarchy are certified by the TPM key or by a manufacturer with restrictions on how an authentic TPM device that is attached to an authentic platform can be accessed and used. A primary key can be encrypted and certified with a certificate created by using TPM2_ActivateCredential, which allows the user to independently enable "flag, policy, and authorization values" without involving other hierarchies. A user with privacy concerns can disable the endorsement hierarchy while still using the storage hierarchy for TPM applications, permitting the platform software to use the TPM. The options are Disabled and **Enabled**.

PH Randomization (for TPM version 2.0 and above)

Select Enabled for Platform Hierarchy (PH) Randomization support, which is used only during the platform developmental stage. This feature cannot be enabled in the production platforms. The options are **Disabled** and Enabled.

Supermicro BIOS-Based TPM Provision Support

If this feature is set to Enabled, Supermicro BIOS-based TPM provision will be supported. The options are Disabled and **Enabled**.



Note: Enabling this feature will lock your TPM on the production platform, and you will not be able to delete the NV indexes.

TXT Support

Select Enabled to enable Intel Trusted Execution Technology (TXT) support to enhance system integrity and data security. The options are **Disabled** and Enabled.



Note 1: If this feature is set to Enabled, be sure to disable Device Function On-Hide (EV DFX) support when it is present in the BIOS for the system to work properly.

Note 2: For more information on TPM, refer to the TPM manual at https://www.supermicro.com/manuals/other/AOM-TPM-9670V_9670H.pdf.

► Supermicro KMS Server Configuration



Note: Be sure to configure all the features in the section of Supermicro KMS Server Configuration and the feature of "KMS Security Policy" ([page 112](#)) so that your system can communicate with the KMS server.

Supermicro KMS Server IP address

Use this feature to set the Supermicro Key Management Service (KMS) server IPv4 address in dotted-decimal notation.

Second Supermicro KMS Server IP address

Use this feature to set the second Supermicro KMS server IPv4 address in dotted-decimal notation.

Supermicro KMS TCP Port number

Use this feature to set the TCP port number used in the Supermicro KMS server. The valid range is 100–9999. The default setting is **5696**. Do not change the default setting unless a different TCP port number has been specified and used in the Supermicro KMS server.

KMS Time Out

Use this feature to set the KMS server connecting timeout (in seconds). The default setting is **5** (seconds).

TimeZone

Use this feature to set the correct time zone. The default setting is **0** (not specified).

Client UserName

Press <Enter> to set the client identity (UserName). The maximum length is 63 characters.

Client Password

Press <Enter> to set the client identity (Password). The maximum length is 31 characters.

► CA Certificate/ ► Client Certificate/ ► Client Private Key

Use the three features to enroll factory defaults or load the KMS Transport Layer Security (TLS) certificates, which are generated by the KMS server, from the file stored in the USB flash drive as shown below.

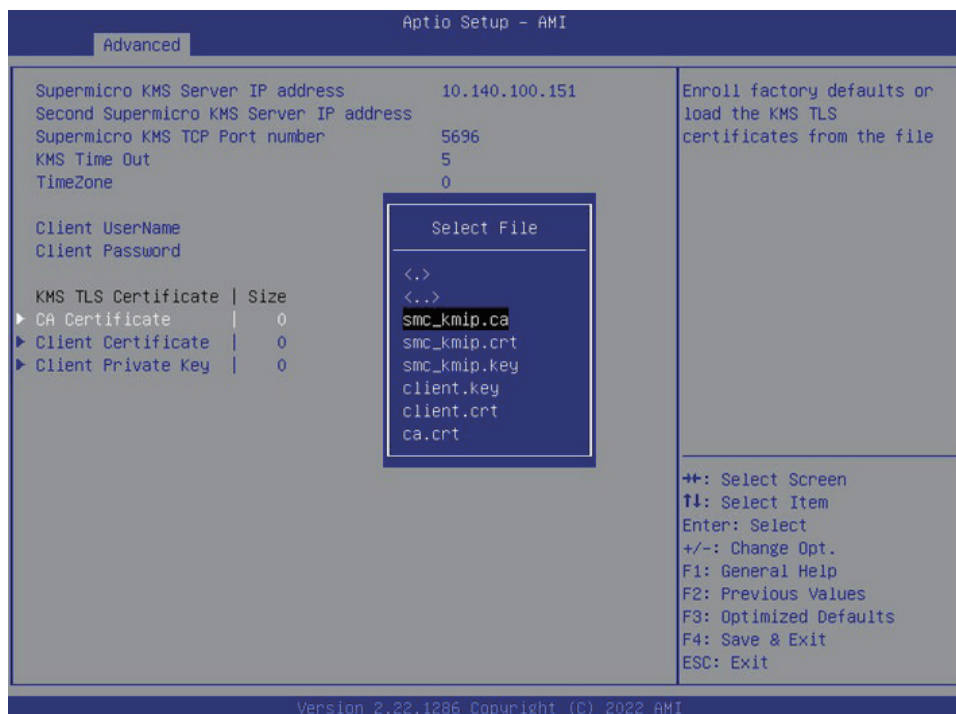

Private Key Password (Available when "Client Private Key" above has been set)

Use this feature to change the private key password.

► Super-Guardians Configuration

Press during system boot to enter the BIOS Setup utility. Navigate to the Advanced tab. Use the arrow keys to select Super-Guardians Configuration and press <Enter>.

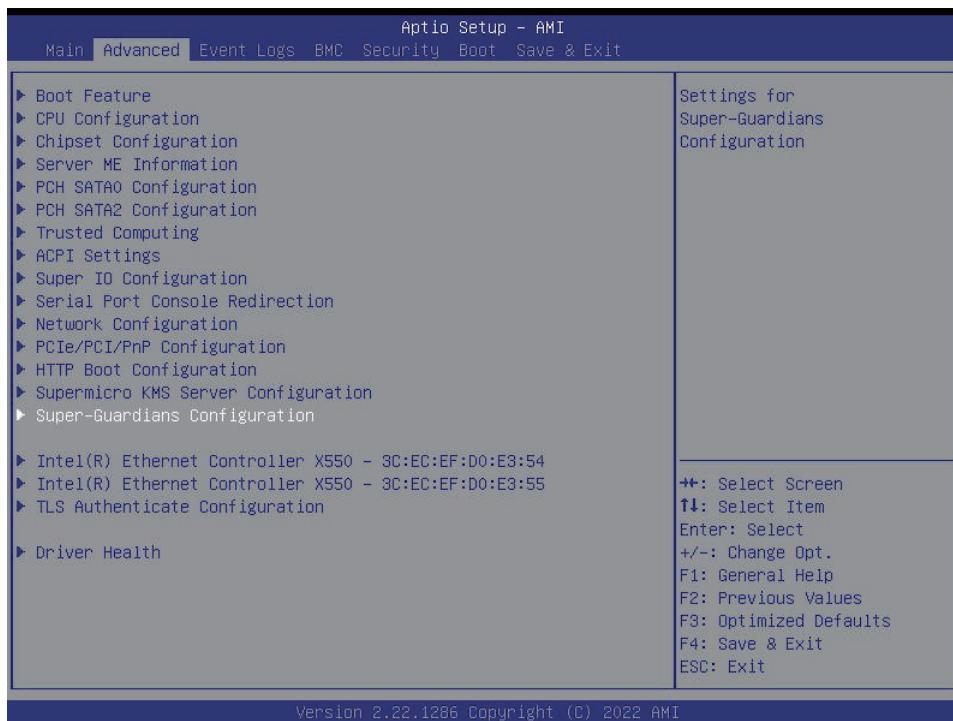

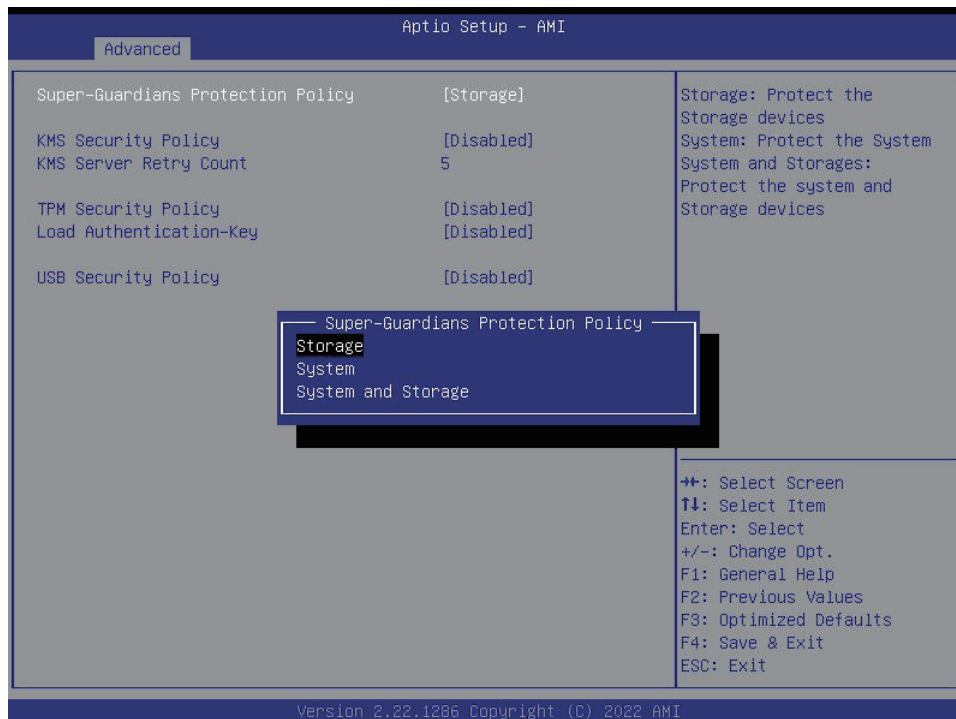

Super-Guardians Protection Policy

Use this feature to enable the Super-Guardians Protection Policy. The options are **Storage**, **System**, and **System and Storage**. The default setting is Storage. Set this feature to Storage to protect and have secure access to your storage devices (TCG NVMe devices) with the Authentication-Key (AK). Set this feature to System to protect and have secure access to your system/motherboard with the AK. Set this feature to System and Storage to protect and have secure access to your system/motherboard/storage devices with the AK. (TCG is the abbreviation for Trusted Computing Group.)



KMS Security Policy (Available when "TPM Security Policy" and "USB Security Policy" are set to Disabled)

Set this feature to Enabled to enable the KMS Security Policy. The options are **Disabled** and **Enabled**. The default setting is Disabled. Save settings (you can press <F4>) and reboot the system for changes to take effect.

-  **Note 1:** Be sure that the KMS server is ready before configuring this feature.
-  **Note 2:** Use the professional KMS server solutions (e.g., Thales Server) or the Supermicro PyKMIP Software Package to establish the KMS server.

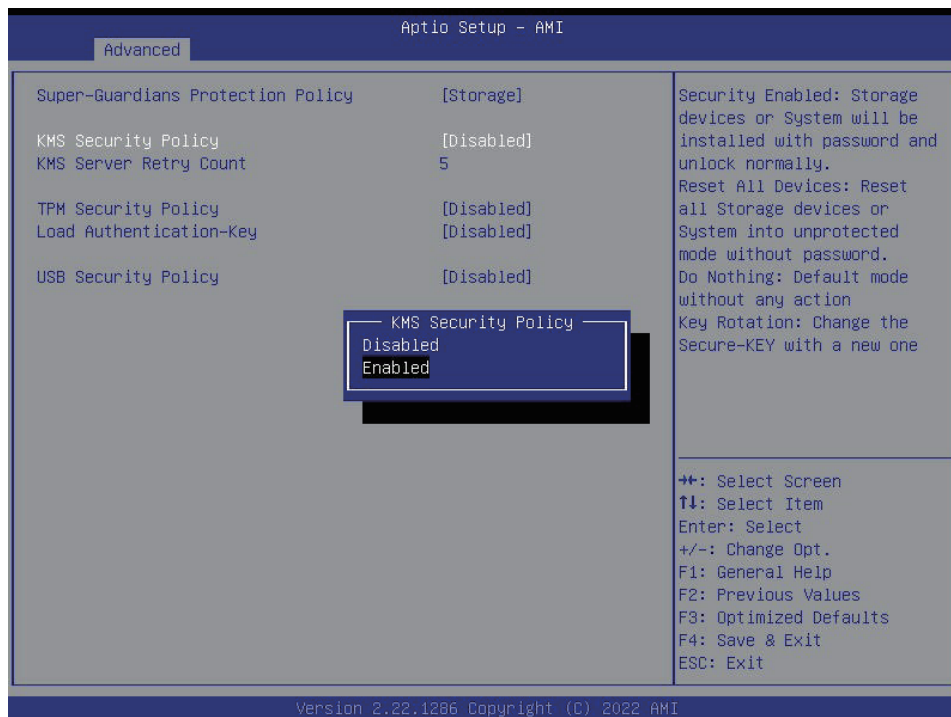

KMS Server Retry Count (Available when "TPM Security Policy" and "USB Security Policy" are set to Disabled)

Use this feature to specify how many times of connection retrying to the KMS server. The valid range is 0–10. Press the <+> or <-> key on your keyboard to change the value. The default setting is **5** (times). The value of 0 indicates a infinite-retrying.

TPM Security Policy (Available when "KMS Security Policy" and "USB Security Policy" are set to Disabled)

The options are **Disabled** and Enabled. The default setting is Disabled. Set this feature to Enabled to enable the TPM Security Policy. Save settings (you can press <F4>) and reboot the system for changes to take effect.

 **Note:** Be sure to install a Trusted Platform Module (TPM) device (TPM 2.0) to your system before configuring this feature.

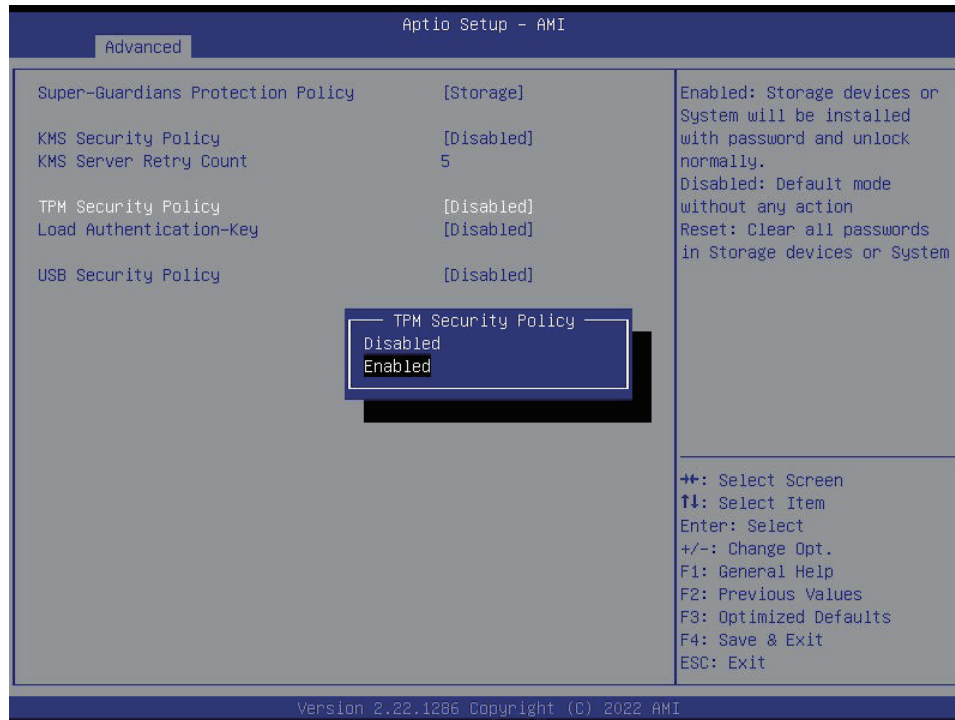

Load Authentication-Key (Available when "KMS Security Policy" and "TPM Security Policy" are set to Disabled)

The options are **Disabled** and Enabled. The default setting is Disabled. Set this feature to Enabled; save settings (you can press <F4>) and reboot the system for changes to take effect. While booting, the BIOS will automatically load the Authentication-Key (filename: TPMAuth.bin) from the USB flash drive. Afterwards, the default setting will be set to Disabled by the BIOS.

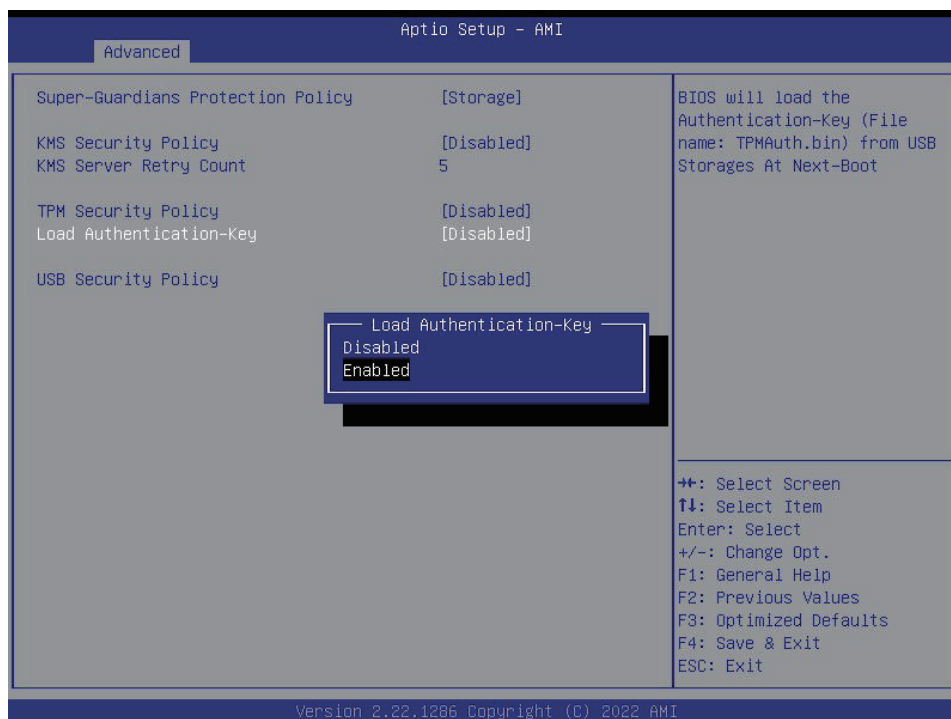

 **Note 1:** Be sure to connect a USB flash drive with the Authentication-Key (filename: TPMAuth.bin) to your system before the system reboot.

Note 2: Be sure to save the Authentication-Key (filename: TPMAuth.bin) to the USB flash drive and keep a backup. Please load the Authentication-Key (filename: TPMAuth.bin) after installing a TPM device. Otherwise, the TPM function can not work properly.

Save Authentication-Key (Available when "TPM Security Policy" is set to Enabled and "USB Security Policy" is set to Disabled)

The options are **Disabled** and Enabled. The default setting is Disabled. Set this feature to Enabled; save settings (you can press <F4>) and reboot the system for changes to take effect. While booting, the BIOS will automatically save the Authentication-Key (filename: TPMAuth.bin) to the USB flash drive. Afterwards, the default setting will be set to Disabled by the BIOS..





Note: Be sure to connect a USB flash drive to your system before the system reboot.

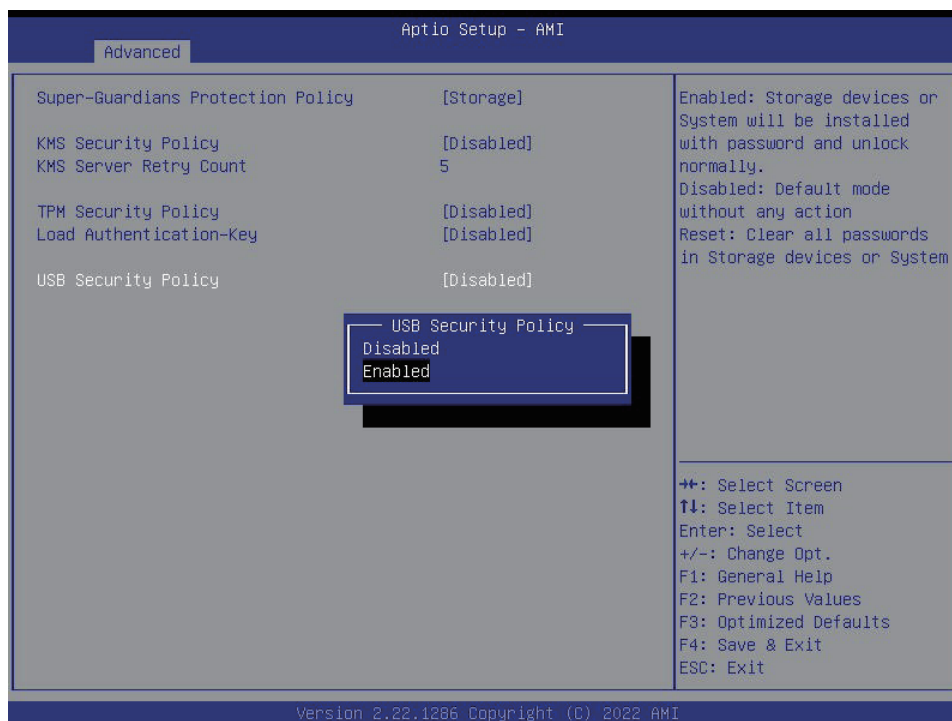

USB Security Policy (Available when "KMS Security Policy" and "TPM Security Policy" are set to Disabled)

Use this feature to enable the USB Security Policy. The options are **Disabled** and Enabled. The default setting is Disabled. Set this feature to Enabled; save settings (you can press <F4>) and reboot the system for changes to take effect. Connect a USB flash drive to your system before the system reboot. While booting, the BIOS will automatically create the USB Authentication-Key (filename: USBAuth.bin) and save it to the USB flash drive.



 **Note 1:** Be sure to connect a USB flash drive to your system before configuring this feature.

Note 2: Be sure to save the USB Authentication-Key (filename: USBAuth.bin) to the USB flash drive and keep a backup.

► HTTP Boot Configuration

HTTP Boot Configuration

HTTP Boot Policy

Use this feature to set the HTTP boot policy. The options are Apply to all LANs, **Apply to each LAN**, and Boot Priority #1 instantly.

HTTPS Boot Checks Hostname

Enable this feature for HTTPS boot to check the hostname of the TLS certificates to see if it matches the host name provided by the remote server. The options are **Enabled** and Disabled (WARNING: Security Risk!!).

Priority of HTTP Boot

Instance of Priority 1: (Available when your motherboard supports this feature)

This feature sets the rank target port. The default setting is **1**.

Select IPv4 or IPv6

This feature specifies which connection the target LAN port should boot from. The options are **IPv4** and IPv6.

Boot Description

Use this feature to enter a boot description, which cannot be longer than 75 characters. Please be sure to enter a boot description; otherwise, the boot option for the URI cannot be created.

Boot URI

Enter a Boot Uniform Research Identifier (URI) with 128 characters or shorter. This Boot URI determines how IPv4 Boot Option and IPv6 Boot Option will be created. This feature is only supported on Dual or EFI Boot Mode.

Instance of Priority 2:

This feature sets the rank target port. The default setting is **0**.

Select IPv4 or IPv6 (Unavailable when "Instance of Priority x:" is set to 0)

This feature specifies which connection the target LAN port should boot from. The options are **IPv4** and IPv6.

Boot Description (Unavailable when "Instance of Priority x:" is set to 0)

Use this feature to enter a boot description, which cannot be longer than 75 characters. Please be sure to enter a boot description; otherwise, the boot option for the URI cannot be created.

Boot URI (Unavailable when "Instance of Priority x:" is set to 0)

Enter a Boot URI with 128 characters or shorter. This Boot URI determines how IPv4 Boot Option and IPv6 Boot Option will be created. This feature is only supported on Dual or EFI Boot Mode.

▶ Intel(R) Ethernet Controller (Ethernet controller) - (MAC address)



Note: The Ethernet controller and MAC addresses shown above are based on your system features.

▶ Firmware Image Properties

The following information is displayed:

- Option ROM version
- Unique NVM/EEPROM ID
- NVM Version

▶ NIC Configuration

Link Speed

Use this feature to set the connection speed of a LAN port specified.

Wake On LAN

Set this feature to support system wake-up via the selected LAN device. If this feature is set to Enabled, the LAN port selected will be enabled when the system is powered on. The options are Disabled and **Enabled**.

LLDP Agent

Use this feature to enable or disable Link Layer Discovery Protocol (LLDP) agent support on a long-term basis. The LLDP, a vendor-neutral link layer protocol, is used by a network device to identify itself and announce its capability to the neighboring devices in a network environment for networking. When disabling the LLDP agent in the firmware, the function of Data Center Bridging (DCB) will also be disabled. The options are Disabled and **Enabled**.

Blink LEDs

Use this feature to identify the physical network port by blinking the associated LED. The default setting is **0** (up to 15 seconds).

The following information is displayed:

- UEFI Driver
- Adapter PBA
- Device Name
- Chip Type
- PCI Device ID
- PCI Address
- Link Status
- MAC Address
- Virtual MAC Address

▶ **TLS Authenticate Configuration**

This submenu allows you to configure Transport Layer Security (TLS) settings.

▶ **Server CA Configuration**

This feature allows you to configure the client certificate that is to be used by the server.

▶ **Enroll Certification**

This feature allows you to enroll the certificate in the system.

▶ **Enroll Certification Using File**

This feature allows you to enroll the security certificate in the system by using a file.

Certification GUID

Press <Enter> and input the certification Global Unique Identifier (GUID).

▶ **Commit Changes and Exit**

Use this feature to save all changes and exit TLS settings.

▶ **Discard Changes and Exit**

Use this feature to discard all changes and exit TLS settings.

▶ Delete Certification

This feature is used to delete the certificate if a certificate has been enrolled in the system. The options are **Disabled** and Enabled.

▶ Client Certification Configuration

This feature allows you to configure the client certificate to be used by the server.

▶ Enroll Certification

This feature allows you to enroll the certificate in the system.

▶ Enroll Certification Using File

This feature allows you to enroll the security certificate in the system by using a file.

Certification GUID

Press <Enter> and input the certification GUID.

▶ Commit Changes and Exit

Use this feature to save all changes and exit TLS settings.

▶ Discard Changes and Exit

Use this feature to discard all changes and exit TLS settings.

▶ Delete Certification

This feature is used to delete the certificate if a certificate has been enrolled in the system.

▶ VLAN Configuration (MAC: Mac address)

▶ Enter Configuration Menu

Create new VLAN

VLAN ID

Use this feature to create the VLAN ID for the new VLAN or existing VLAN. The valid value is 0–4094. The default setting is **0**.

Priority

Use this feature to set the 802.1Q priority. The valid value is 0–7. The default setting is **0**.

Add VLAN

Use this feature to create a new VLAN or update the existing VLAN by using the VLAN ID and Priority above.

Configured VLAN List**VLAN ID: x, Priority: x**

Enable this feature to select the VLAN ID and Priority to be removed. The options are **Disabled** and Enabled.

Remove VLAN

Press <Enter> and the VLAN ID and Priority you selected and enabled above will be removed.

► Intel(R) VROC tSATA Controller

Note 1: This section is based on your system features and related device(s) installed.

Note 2: This section is available when "SATA Mode Selection" is set to RAID.

Note 3: Refer to the submenu of PCH SATA2 Configuration in the BIOS Setup main menu to set "SATA Mode Selection" ([page 94](#)).

The following information is displayed.

- Intel VROC tSATA driver version

► Create RAID Volume**Name:**

This feature allows you to enter the unique name of RAID volume.

RAID Level:

This feature allows you to select the RAID level. The options are **RAID0(Stripe)**, RAID1(Mirror), RAID5(Parity), and RAID10(RAID0+1).

Select Disks:

Select the desired RAID disks one by one by setting them to **X**. The options are (not selected) and **X (selected)**.

Strip Size:

Use this feature to select the RAID strip size. The options are 4KB, 8KB, 16KB, 32KB, 64KB, and **128KB**. The available options are based on the setting of "RAID Level:" above.

Capacity (GB):

This feature allows you to enter the desired RAID capacity (in GB).

▶ Create RAID Volume

Use this feature to create a RAID volume with the settings above. The options are **Yes** and **No**.

Non-RAID Physical Disks:

This feature displays the information of non-RAID physical disk(s).

RAID Volumes:

This feature displays the information of RAID volumes that have been created earlier.

▶ Intel(R) Virtual RAID on CPU

 **Note:** It is available when your system supports this feature and when "Enable/Disable VMD" is set to Enable.

The following information is displayed:

- Intel(R) VROC with VMD Technology x.x.x.xxxx
- Upgrade key:
- Intel VROC Managed Controllers:

▶ Driver Health

This feature displays the health information of the drivers installed in your system, including LAN controllers, as detected by the BIOS. Select one and press <Enter> to see the details.

 **Note:** This section is provided for reference only, for the driver health status will differ depending on the drivers installed in your system. It's also based on your system configuration and the environment that your system is operating in.

4.4 Event Logs

Use this feature to configure Event Logs settings.

 **Note:** After you've made any changes in this section, please be sure to reboot the system for the changes to take effect.

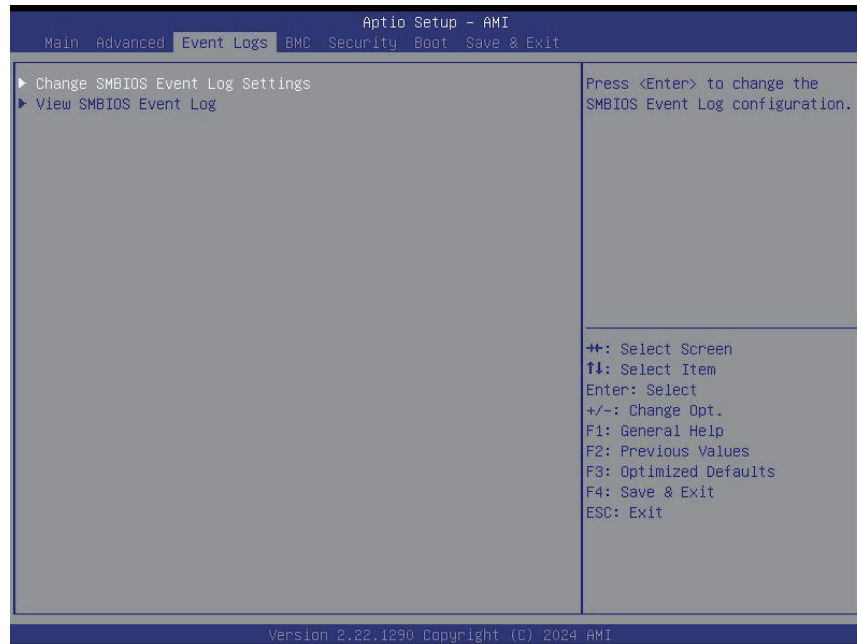

► Change SMBIOS Event Log Settings

Enabling/Disabling Options

SMBIOS Event Log

Select Enabled to enable System Management BIOS (SMBIOS) Event Logging during system boot. The options are Disabled and **Enabled**.

Erasing Settings

Erase Event Log (Available when "SMBIOS Event Log" is set to Enabled)

Select No to keep the event log without erasing it upon next system bootup. Select Yes, Next reset to erase the event log upon next system reboot. The options are **No**, (Yes, Next reset), and (Yes, Every reset).

When Log is Full (Available when "SMBIOS Event Log" is set to Enabled)

Select Erase Immediately to immediately erase all errors in the SMBIOS event log when the event log is full. Select Do Nothing for the system to do nothing when the SMBIOS event log is full. The options are **Do Nothing** and Erase Immediately.

SMBIOS Event Log Standard Settings

Log System Boot Event (Available when "SMBIOS Event Log" is set to Enabled)

Select Enabled to log system boot events. The options are Enabled and **Disabled**.

MECI (Available when "SMBIOS Event Log" is set to Enabled)

Enter the increment value for the multiple event counter. Enter a number between 1 to 255. The default setting is **1**. (MECI is the abbreviation for Multiple Event Count Increment.)

METW (Available when "SMBIOS Event Log" is set to Enabled)

This feature is used to determine how long (in minutes) should the multiple event counter wait before generating a new event log. Enter a number between 0 to 99. The default setting is **60**. (METW is the abbreviation for Multiple Event Count Time Window.)



Note: Please reboot the system for the changes above to take effect.

►View SMBIOS Event Log

This feature allows you to view the event in the system event log. Select this feature and press <Enter> to view the status of an event in the log. The following information is displayed:
DATE / TIME / ERROR CODE / SEVERITY.

4.5 BMC

Use this feature to configure BMC settings.

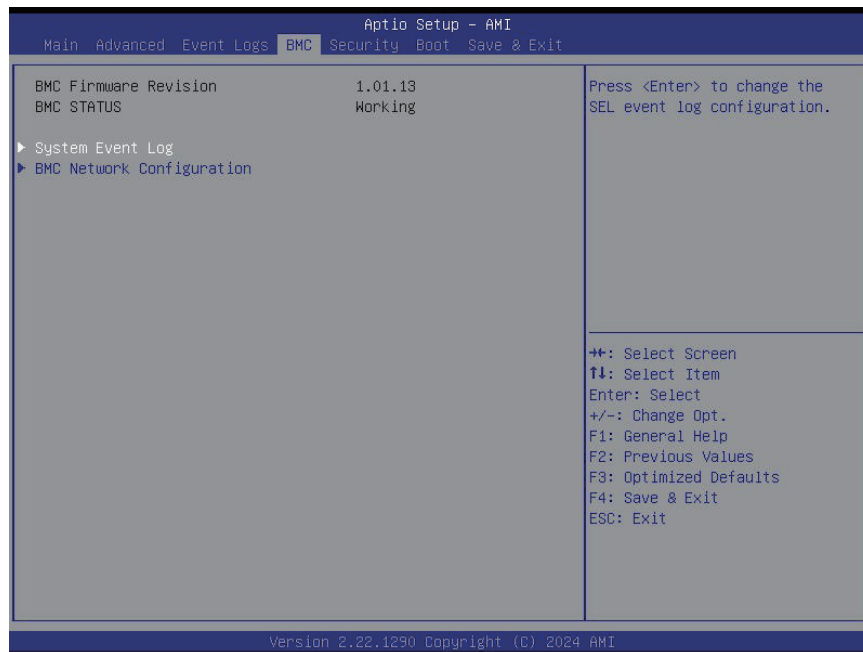

BMC Firmware Revision

This feature indicates the BMC firmware revision used in your system.

BMC STATUS

This feature indicates the status of the BMC firmware installed in your system.

▶ System Event Log

Enabling/Disabling Options

SEL Components

Select Enabled to enable all system event logging upon system boot. The options are Disabled and **Enabled**.

Erasing Settings

Erase SEL (Available when "SEL Components" is set to Enabled)

Select (Yes, On next reset) to erase all system event logs upon next system boot. Select (Yes, On every reset) to erase all system event logs upon each system reboot. Select No to keep all system event logs after each system reboot. The options are **No**, (Yes, On next reset), and (Yes, On every reset).

When SEL is Full (Available when "SEL Components" is set to Enabled)

This feature allows you to determine what the BIOS should do when the system event log is full. Select Erase Immediately to erase all events in the log when the system event log is full. The options are **Do Nothing** and Erase Immediately.

 **Note:** After making changes on a setting, be sure to reboot the system for the changes to take effect.

► BMC Network Configuration

Update BMC LAN Configuration

Select Yes for the BIOS to implement all IP/MAC address changes upon next system boot. The options are **No** and Yes.

Configure IPv4 Support

BMC LAN Selection

This feature displays the type of the BMC LAN.

BMC Network Link Status:

This feature displays the status of the BMC network link for this system.

Configuration Address Source (Available when "Update BMC LAN Configuration" is set to Yes)

Use this feature to select the source of the IPv4 connection. If Static is selected, you will need to know the IP address of IPv4 connection and enter it to the system manually in the field. If DHCP is selected, the BIOS will search for a Dynamic Host Configuration Protocol (DHCP) server in the network that is attached to and request the next available IP address for this computer. The options are Static and **DHCP**.

Station IP Address

This feature displays the Station IP address in decimal and in dotted quad form (i.e., 172.29.176.131). It is available for configuration when "Configuration Address Source" above is set to Static.

Subnet Mask

This feature displays the sub-network that this computer belongs to. The value of each three-digit number separated by dots should not exceed 255. It is available for configuration when "Configuration Address Source" above is set to Static.

Station MAC Address

This feature displays the Station MAC address for this computer. Mac addresses are six two-digit hexadecimal numbers.

Gateway IP Address

This feature displays the Gateway IP address for this computer. This should be in decimal and in dotted quad form (i.e., 172.29.0.1). It is available for configuration when "Configuration Address Source" above is set to Static.

VLAN (Available when "Update BMC LAN Configuration" is set to Yes)

Use this feature to enable virtual LAN (VLAN) support. The options are **Disable** and **Enable**.

VLAN ID (Available when "VLAN" is set to Enable)

Use this feature to create a new VLAN ID by using an existing VLAN or creating a new VLAN ID. The valid value is 1–4094. The default setting is 1.

Configure IPv6 Support

IPv6 Address Status

This feature displays the status of the IPv6 address.

IPv6 Support (Available when "Update BMC LAN Configuration" is set to Yes)

Use this feature to enable IPv6 support. The options are **Enabled** and **Disabled**.

Configuration Address Source (Available when "IPv6 Support" is set to Enabled)

Use this feature to select the source of the IPv6 connection. If Static Configuration is selected, you will need to know the IP address of IPv6 connection and enter it to the system manually in the field. If the other two options are selected, the BIOS will search for a DHCP server in the network that is attached to and request the next available IP address for this computer. The options are Static Configuration, **DHCPv6 Stateless**, and **DHCPv6 Stateful**.

IPv6 Address ("Static", "DHCPv6 Stateless", or "DHCPv6 Stateful", depending on the option you selected for "Configuration Address Source" above)

This feature displays the station IPv6 address. It is available for configuration when "Configuration Address Source" above is set to Static Configuration.

Prefix Length

This feature displays the prefix length. It is available for configuration when "Configuration Address Source" above is set to Static Configuration.

Gateway IP

This feature displays the IPv6 gateway IP address. It is available for configuration when "Configuration Address Source" above is set to Static Configuration.

Advanced Settings (Available when "Configuration Address Source" above is set to DHCPv6 Stateless)

Use this feature to set the DNS server IP. The options are Auto obtain DNS server IP and **Manually obtain DNS server IP**.

Preferred DNS server IP (Available when "Advanced Settings" above is set to Manually obtain DNS server IP)

This feature displays the preferred DNS server IP. It can be configured via Redfish.

Alternative DNS server IP (Available when "Advanced Settings" above is set to Manually obtain DNS server IP)

This feature displays the alternative DNS server IP. It can be configured via Redfish.

4.6 Security

This feature allows you to configure the following security settings for the system.

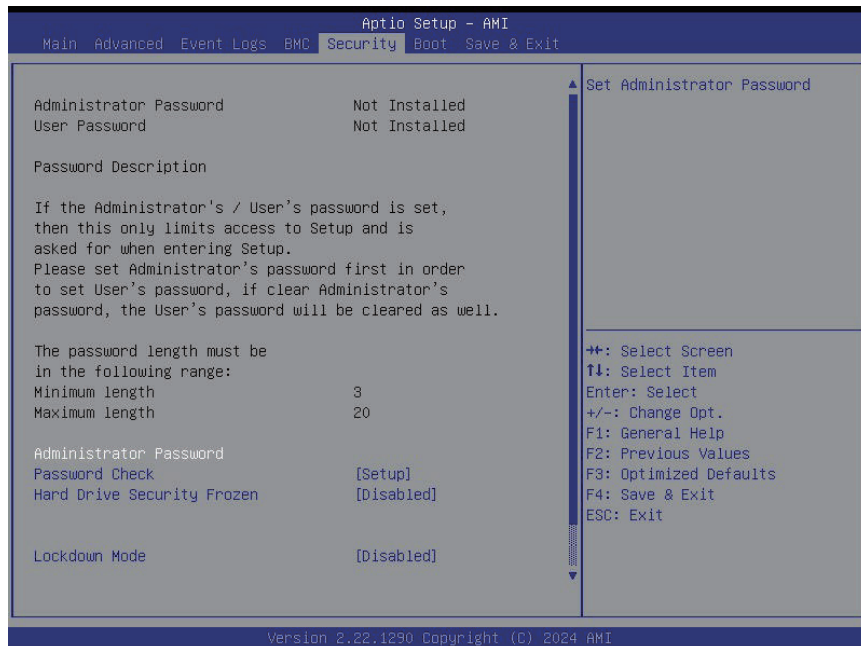

The following information is displayed:

- Administrator Password
- User Password
- Password Description

Administrator Password

This feature indicates if an administrator password has been installed. It also allows you to set the administrator password which is required to enter the BIOS Setup utility. The length of the password should be from three characters to 20 characters long.

User Password (Available when "Administrator Password" has been set)

This feature indicates if a user password has been installed. It also allows you to set the user password which is required to enter the BIOS Setup utility. The length of the password should be from three characters to 20 characters long.

 **Note:** For detailed instructions on how to configure Security Boot settings, please refer to the Security Boot Configuration User's Guide posted on the web page under the link: <https://www.supermicro.com/support/manuals/>.

Password Check

Select Setup for the system to check for a password at Setup. Select Always for the system to check for a password at bootup and upon entering the BIOS Setup utility. The options are **Setup** and Always.

Hard Drive Security Frozen

Select Enabled to freeze the Lock Security feature for HDD to protect key data in hard drives from being altered. The options are **Disabled** and Enabled.

Lockdown Mode (Available when the DCMS key is activated)

Select Enabled to support Lockdown Mode that will prevent the existing data or keys stored in the system from being altered or changed in an effort to preserve system integrity and security. The options are **Disabled** and Enabled.

► Secure Boot



Note: For detailed instructions on how to configure Security Boot settings, please refer to the Security Boot Configuration User's Guide posted on the web page under the link: <https://www.supermicro.com/support/manuals/>.

The following information is displayed:

- System Mode
- Secure Boot

Secure Boot

Select Enabled to configure Secure Boot settings. The options are **Disabled** and Enabled.

Secure Boot Mode

Use this feature to select the desired secure boot mode for the system. The options are Standard and **Custom**.

► Enter Audit Mode (Available when "Secure Boot Mode" is set to Custom)

Select Ok to enter the Audit Mode workflow. It will result in erasing of Platform Key (PK) variables and reset system to the Setup/Audit Mode.

► Enter Deployed Mode / Exit Deployed Mode (Available when "Secure Boot Mode" is set to Custom)

Select Ok to reset system to the User Mode or to the Deployed Mode.

▶ Key Management (Available when "Secure Boot Mode" is set to Custom)

The following information is displayed.

- Vendor Keys

Provision Factory Defaults

Select Enabled to install provision factory default settings after a platform reset while the system is in the Setup Mode. The options are **Disabled** and Enabled.

▶ Restore Factory Keys (Available when any secure keys have been installed)

Select Yes to restore manufacturer default keys to ensure system security. The options are **Yes** and No. Selecting Yes will reset system to the Deployed mode.

▶ Reset To Setup Mode (Available when any secure keys have been installed)

This feature resets the system to the Setup Mode. The options are **Yes** and No.

▶ Export Secure Boot Variables (Available when any secure keys have been installed)

This feature exports the NVRAM contents of secure boot variables to a storage device. The options are **Yes** and No.

▶ Enroll Efi Image

This feature allows the Efi image to run in the secure boot mode, which will enroll the SHA256 Hash certificate of a PE image into the Authorized Signature Database (DB).

Secure Boot variable / Size / Keys / Key Source

▶ Platform Key (PK)

Use this feature to enter and configure a set of values to be used as platform firmware keys for the system. These values also indicate the sizes, keys numbers, and the sources of the authorized signatures. Select Update to update the platform key.

► Key Exchange Keys (KEK)

Use this feature to enter and configure a set of values to be used as Key-Exchange-Keys for the system. These values also indicate the sizes, keys numbers, and the sources of the authorized signatures. Select Update to update your "Key Exchange Keys". Select Append to append your "Key Exchange Keys".

► Authorized Signatures (db)

Use this feature to enter and configure a set of values to be used as Authorized Signatures for the system. These values also indicate the sizes, keys numbers, and the sources of the authorized signatures. Select Update to update your "Authorized Signatures". Select Append to append your "Authorized Signatures".

► Forbidden Signatures (dbx)

Use this feature to enter and configure a set of values to be used as Forbidden Signatures for the system. These values also indicate sizes, key numbers, and key sources of the forbidden signatures. Select Update to update your "Forbidden Signatures". Select Append to append your "Forbidden Signatures".

► Authorized TimeStamps (dbt)

This feature allows you to set and save the timestamps for the authorized signatures which will indicate the time when these signatures are entered into the system. These values also indicate sizes, keys, and key sources of the authorized timestamps. Select Update to update your "Authorized TimeStamps". Select Append to append your "Authorized TimeStamps".

► OsRecovery Signature (dbr)

This feature allows you to set and save the authorized signatures used for OS recovery. Select Update to update your "OS Recovery Signatures". These values also indicate sizes, keys, and key sources of the OsRecovery signatures. Select Append to append your "OS Recovery Signatures".

► Supermicro Security Erase Configuration (Available when any storage device is detected by the BIOS)



Note: For more information, please refer to https://www.supermicro.com/manuals/other/X11_X12_X13_B11_B12_B13_H11_H12_BH12_H13_Secure_Erase_Guide.pdf.

This section allows you to configure the Supermicro-proprietary Security Erase settings. When this section is selected, the following information is displayed. Please note that the order of the following information may differ based on the storage devices being detected.

- **HDD Name:** This feature displays the name of the storage device that is detected by the BIOS.
- **HDD Serial Number:** This feature displays the serial number of the storage device that is detected by the BIOS.
- **Security Mode:** This feature displays the security mode of the storage device that is detected by the BIOS.
- **Estimated Time:** This feature displays the estimate time needed to perform the selected Security Erase features.
- **HDD User Pwd Status:** This feature indicates if a password has been set as a storage device user password that enables configuring Supermicro Security Erase settings on the storage device by using this user password.
- **TCG Device Type:** This feature displays the TCG device type detected by the system.
- **Admin Pwd Status:** This feature indicates if a password has been set as a storage device administrator password that enables configuring Supermicro Security Erase settings on the storage device by using this administrator password.

Security Function

Select Set Password to set a storage device password that enables configuring the security settings of the storage device. Select Security Erase - Password to enter a storage device user password to enable erasing the password and the contents previously stored in the storage device. Select Security Erase - Without Password to use the manufacturer default password "11111111" as the storage device user password and enable erasing the contents of the storage device by using this default password. The options are **Disable**, Set Password, Change Password, Clear Password, Security Erase - Password, Security Erase - PSID, and Security Erase - Without Password.



Note 1: The option of Security Erase - PSID is based on the storage device support. PSID is the abbreviation for Physical Security Identification.

Note 2: The options of Change Password and Clear Password are available when "Password" below has been set.

Note 3: The option of Set Password is not available when "Password" below has been set.

Password

Use this feature to set the storage device user password which allows you to configure the Supermicro Security Erase settings by using this user password.

New Password (Available when "Password" above has been set)

Use this feature to set the new user password for the storage device which allows you to configure the Supermicro Security Erase settings by using this new user password.

HDD Security Configuration:

►P4: (Storage Device Name)

This section is available when the storage device is detected by the BIOS. Select this device. Press <Enter> and the following information is displayed:

- HDD Password Description:
- HDD PASSWORD CONFIGURATION:
 - Security Supported:
 - Security Enabled:
 - Security Locked:
 - Security Frozen:
 - HDD User Pwd Status:
 - HDD Master Pwd Status:

Set User Password (Available when "Security Frozen:" above is No)

Press <Enter> to set the HDD user password.

TCG Storage Security Configuration:**▶(Storage Device Name) (Available when the storage device is compliant with TCG specifications)**

Select this device. Press <Enter> and the following information is displayed:

- TCG Storage Security Password Description:
- PASSWORD CONFIGURATION:
 - Security Subsystem Class:
 - Security Supported:
 - Security Enabled:
 - Security Locked:
 - Security Frozen:
 - Admin Pwd Status:

Set Admin Password

Use this feature to set the administrator password for this storage device.

Set User Password (Available when the administrator password has been set)

Use this feature to set the user password for this storage device.

Device Reset

Use this feature to reset the password configuration for this storage device.

4.7 Boot

Use this feature to configure Boot settings:

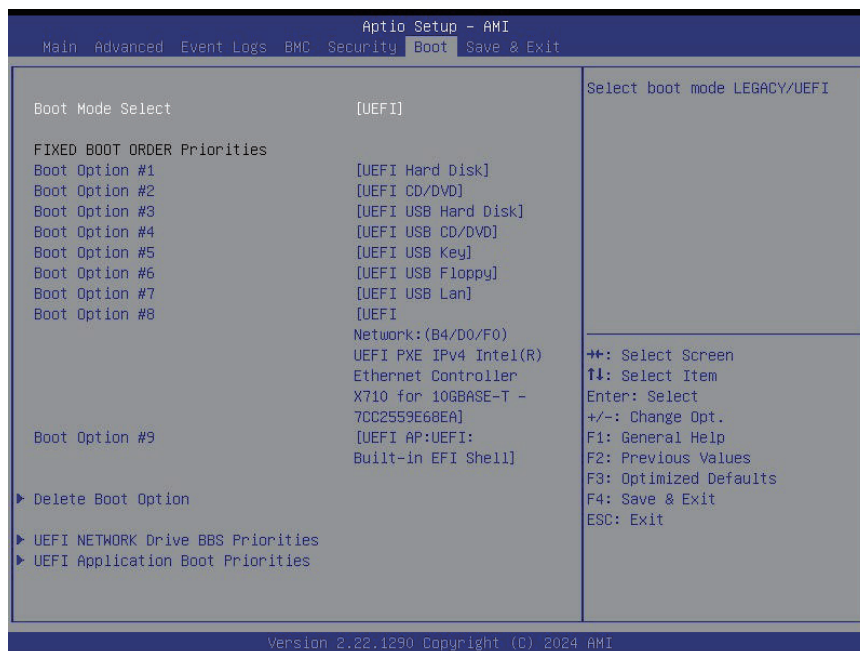

Boot Mode Select

This motherboard supports only the UEFI boot mode.

FIXED BOOT ORDER Priorities

This feature prioritizes the order of a bootable device from which the system will boot. Press <Enter> on each item sequentially to select devices.

For the UEFI boot mode, the following features will be displayed for configuration:

- Boot Option #1 – Boot Option #9

► Add New Boot Option (Available when any storage device is detected by the BIOS)

This feature allows you to add a new boot option to the boot priority features for system boot.

Add boot option

This feature allows you to specify the name for the new boot option.

Path for boot option

Use this feature to enter the path for the new boot option in the format fsx:\path\filename.efi.

Boot option File Path

This feature allows you to specify the file path for the new boot option.

Create

After the name and the file path for the boot option are set, press <Enter> to create the new boot option in the boot priority list.

▶Delete Boot Option

This feature allows you to select a boot device to delete from the boot priority list.

Delete Boot Option

This feature allows you to remove an EFI boot option from the boot priority list.

▶UEFI NETWORK Drive BBS Priorities

This feature allows you to set the system boot order of detected devices.

▶UEFI Application Boot Priorities

This feature allows you to set the system boot order of detected devices.

▶UEFI USB Key Drive BBS Priorities

This feature allows you to set the system boot order of detected devices.

▶UEFI Hard Disk Drive BBS Priorities

This feature allows you to set the system boot order of detected devices.

4.8 Save & Exit

Select Save & Exit from the BIOS Setup screen to configure the settings below.

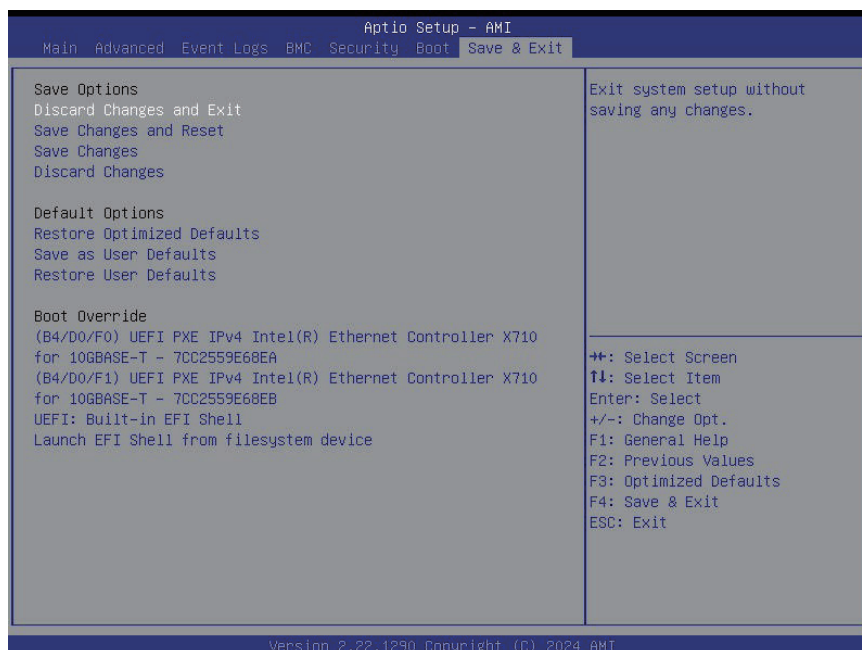

Save Options

Discard Changes and Exit

Use this feature to exit from the BIOS Setup utility without making any permanent changes to the system configuration and reboot the computer.

Save Changes and Reset

When you have completed the system configuration changes, use this feature to exit the BIOS Setup utility and reboot the computer for the new system configuration parameters to become effective.

Save Changes

When you have completed the system configuration changes, use this feature to save all changes you've made. This will not reset (reboot) the system.

Discard Changes

Select this feature and press <Enter> to discard all the changes you've made and return to the BIOS Setup utility.

Default Options

Restore Optimized Defaults

Select this feature and press <Enter> to load manufacturer optimized default settings which are intended for maximum system performance but not for maximum stability.

 **Note:** Please reboot the system for the changes to take effect to ensure that your system has the optimized default settings.

Save as User Defaults

Select this feature and press <Enter> to save all changes on the default values specified to the BIOS Setup utility for future use.

Restore User Defaults

Select this feature and press <Enter> to retrieve user-defined default settings that have been saved previously.

Boot Override

This feature allows you to override the Boot priorities sequence in the Boot menu, and immediately boot the system with a device specified instead of the one specified in the boot list. This is a one-time override.

Appendix A

BIOS POST Codes

A.1 BIOS POST Codes

The AMI BIOS supplies additional checkpoint codes, which are documented online at <https://www.supermicro.com/support/manuals/> ("AMI BIOS POST Codes User's Guide").

When BIOS performs the Power On Self Test, it writes checkpoint codes to I/O port 0080h. If the computer cannot complete the boot process, a diagnostic card can be attached to the computer to read I/O port 0080h (Supermicro P/N AOM-SPI80-V).

For information on AMI updates, please refer to <https://www.ami.com/products/>.

Appendix B

Software

After the hardware has been installed, you can install the Operating System (OS), configure RAID settings, and install the drivers.

B.1 Microsoft Windows OS Installation

If you will be using RAID, you must configure RAID settings before installing the Windows OS and the RAID driver. Refer to the RAID Configuration User Guides posted on our website at www.supermicro.com/support/manuals.

Installing the OS

1. Create a method to access the Microsoft Windows installation ISO file. That can be a USB flash or media drive.
2. Retrieve the proper RST/RSTe driver. Go to the Supermicro web page for your motherboard and click on "Download the Latest Drivers and Utilities", select the proper driver, and copy it to a USB flash drive.
3. Boot from a bootable device with Windows OS installation. You can see a bootable device list by pressing **F11** during the system startup.

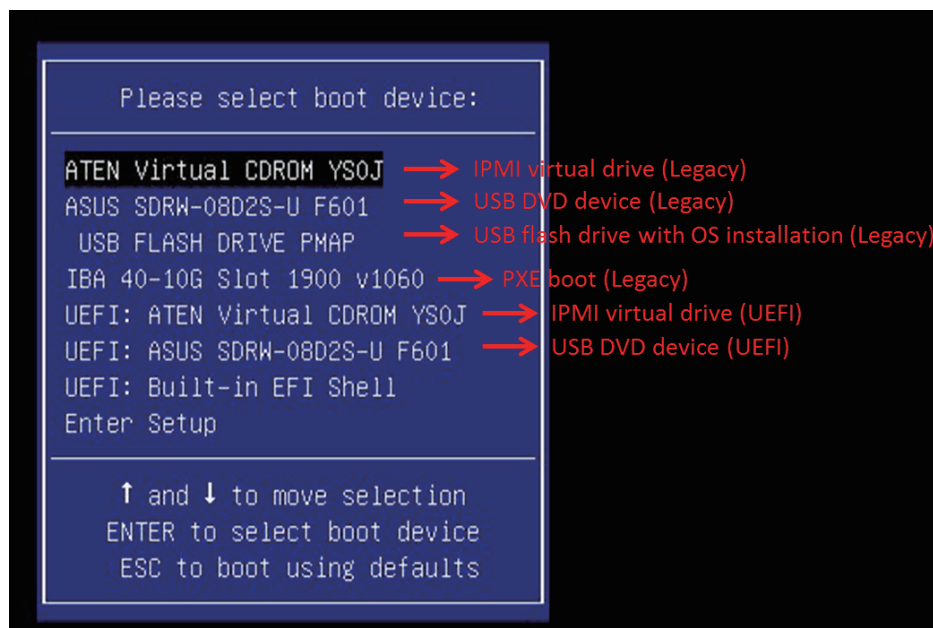

4. During Windows Setup, continue to the dialog where you select the drives on which to install Windows. If the disk you want to use is not listed, click on “Load driver” link at the bottom left corner.

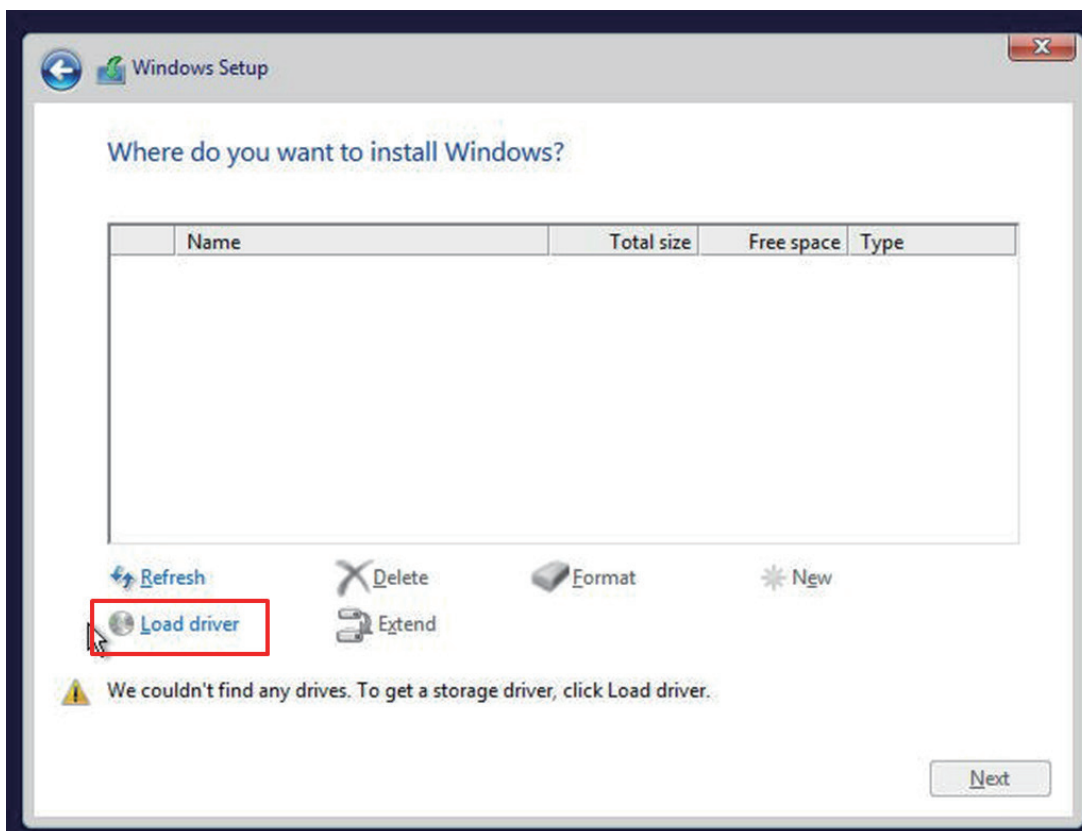

To load the driver, browse the USB flash drive for the proper driver files.

- For RAID, choose the SATA/sSATA RAID driver indicated then choose the storage drive on which you want to install it.
 - For non-RAID, choose the SATA/sSATA AHCI driver indicated then choose the storage drive on which you want to install it.
5. Once all devices are specified, continue with the installation.
 6. After the Windows OS installation has completed, the system will automatically reboot multiple times.

B.2 Driver Installation

The Supermicro website contains drivers and utilities for your system is at <https://www.supermicro.com/wdl/driver>. Some of these must be installed, such as the chipset driver.

After accessing the website, go into the CDR_Images (in the parent directory of the above link) and locate the ISO file for your motherboard. Download this file to a USB flash or media drive. (You may also use a utility to extract the ISO file if preferred.)

Another option is to go to the Supermicro website at <https://www.supermicro.com/products/>. Find the product page for your motherboard and download the latest drivers and utilities.

Insert the flash drive or disk and the screenshot shown below should appear.

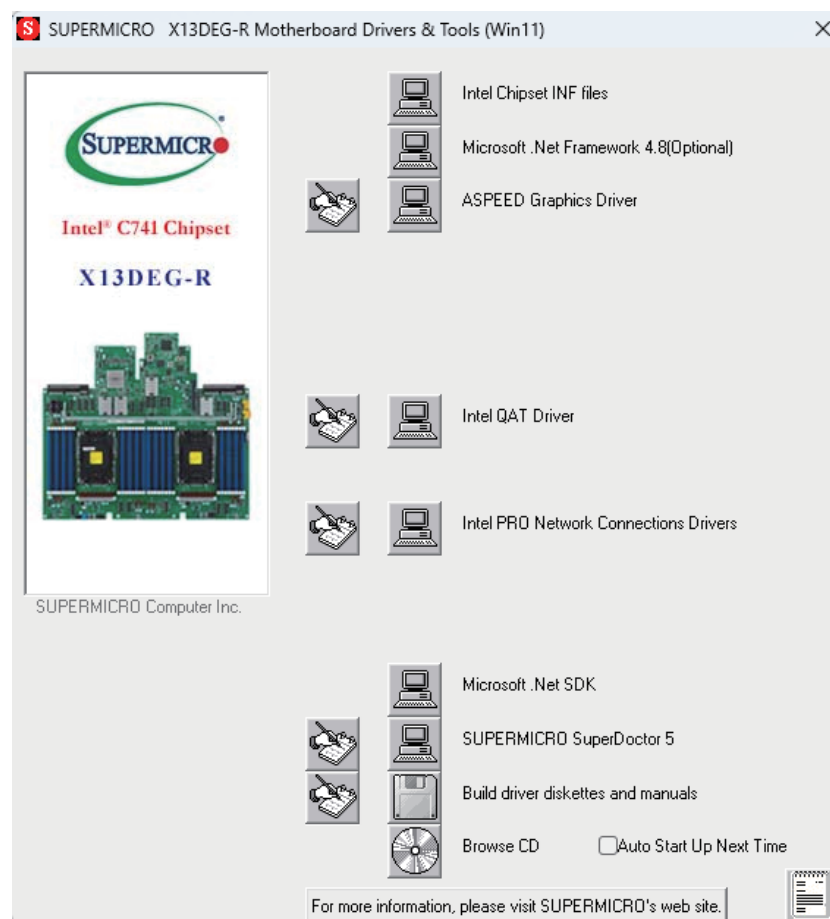

Note: Click the icons showing a hand writing on paper to view the readme files for each item. Click the computer icons to the right of these items to install each item (from top to the bottom) one at a time. **After installing each item, you must re-boot the system before moving on to the next item on the list.** The bottom icon with a CD on it allows you to view the entire contents.

B.3 BMC

This motherboard supports the Baseboard Management Controller (BMC). BMC is used to provide remote access, monitoring, and management. There are several BIOS settings that are related to BMC.

For general documentation and information on BMC, please visit our website at: <https://www.supermicro.com/products/nfo/BMC.cfm>.

B.4 Logging into the BMC (Baseboard Management Controller)

Supermicro ships standard products with a unique password for the BMC ADMIN user. This password can be found on a label on the motherboard.

When logging in to the BMC for the first time, please use the unique password provided by Supermicro to log in. You can change the unique password to a user name and password of your choice for subsequent logins.

For more information regarding BMC passwords, please visit our website at <https://www.supermicro.com/bmcpassword>.

Appendix C

Standardized Warning Statements

The following statements are industry standard warnings, provided to warn the user of situations where a potential bodily injury may occur. Should you have questions or experience difficulty, contact Supermicro's Technical Support department for assistance. Only certified technicians should attempt to install or configure components.

Read this section in its entirety before installing or configuring components.

These warnings may also be found on our website at https://www.supermicro.com/about/policies/safety_information.cfm.

Battery Handling



Warning! There is the danger of explosion if the battery is replaced incorrectly. Replace the battery only with the same or equivalent type recommended by the manufacturer. Dispose of used batteries according to the manufacturer's instructions

電池の取り扱い

電池交換が正しく行われなかった場合、破裂の危険性があります。交換する電池はメーカーが推奨する型、または同等のものを使用下さい。使用済電池は製造元の指示に従って処分して下さい。

警告

電池更換不當會有爆炸危險。請只使用同類電池或製造商推薦的功能相當的電池更換原有電池。請按製造商的說明處理廢舊電池。

警告

電池更換不當會有爆炸危險。請使用製造商建議之相同或功能相當的電池更換原有電池。請按照製造商的說明指示處理廢棄舊電池。

Warnung

Bei Einsetzen einer falschen Batterie besteht Explosionsgefahr. Ersetzen Sie die Batterie nur durch den gleichen oder vom Hersteller empfohlenen Batterietyp. Entsorgen Sie die benutzten Batterien nach den Anweisungen des Herstellers.

Attention

Danger d'explosion si la pile n'est pas remplacée correctement. Ne la remplacer que par une pile de type semblable ou équivalent, recommandée par le fabricant. Jeter les piles usagées conformément aux instructions du fabricant.

¡Advertencia!

Existe peligro de explosión si la batería se reemplaza de manera incorrecta. Reemplazar la batería exclusivamente con el mismo tipo o el equivalente recomendado por el fabricante. Desechar las baterías gastadas según las instrucciones del fabricante.

אזהרה!

קיימת סכנת פיצוץ של הסוללה במידה והוחלפה בדרך לא תקינה. יש להחליף את הסוללה בסוג התואם מחברת יצרן מומלצת. סילוק הסוללות המשומשות יש לבצע לפי הוראות היצרן.

هناك خطر من انفجار في حالة اسبدال البطارية بطريقة غير صحيحة فعلي
اسبدال البطارية فقط بنفس النع أو ما يعادلها مما أوصت به الشركة المصنعة
جخلص من البطاريات المسعملة وفقا لعمليات الشركة الصانعة

경고!

배터리가 올바르게 교체되지 않으면 폭발의 위험이 있습니다. 기존 배터리와 동일하거나 제조사에서 권장하는 동등한 종류의 배터리로만 교체해야 합니다. 제조사의 안내에 따라 사용된 배터리를 처리하여 주십시오.

Waarschuwing

Er is ontploffingsgevaar indien de batterij verkeerd vervangen wordt. Vervang de batterij slechts met hetzelfde of een equivalent type die door de fabrikant aanbevolen wordt. Gebruikte batterijen dienen overeenkomstig fabrieksvoorschriften afgevoerd te worden.

Product Disposal



Warning! Ultimate disposal of this product should be handled according to all national laws and regulations.

製品の廃棄

この製品を廃棄処分する場合、国の関係する全ての法律・条例に従い処理する必要があります。

警告

本产品的废弃处理应根据所有国家的法律和规章进行。

警告

本產品的廢棄處理應根據所有國家的法律和規章進行。

Warnung

Die Entsorgung dieses Produkts sollte gemäß allen Bestimmungen und Gesetzen des Landes erfolgen.

¡Advertencia!

Al deshacerse por completo de este producto debe seguir todas las leyes y reglamentos nacionales.

Attention

La mise au rebut ou le recyclage de ce produit sont généralement soumis à des lois et/ou directives de respect de l'environnement. Renseignez-vous auprès de l'organisme compétent.

סילוק המוצר

אזהרה!

סילוק סופי של מוצר זה חייב להיות בהתאם להנחיות וחוקי המדינה.

عند التخلص النهائي من هذا المنتج ينبغي التعامل معه وفقا لجميع القوانين واللوائح الوطنية

경고!

이 제품은 해당 국가의 관련 법규 및 규정에 따라 폐기되어야 합니다.

Waarschuwing

De uiteindelijke verwijdering van dit product dient te geschieden in overeenstemming met alle nationale wetten en reglementen.