



X14DBG-LC2

USER'S MANUAL

Revision Draft 1.0 MNL-2860

Preface

About This Manual

This manual is written for professional system integrators and PC technicians. It provides information for the installation and use of the X14DBG-LC2 motherboard. Installation and maintenance should be performed by certified service technicians only.

Notes

For your system to work properly, follow the links below to download all necessary drivers/utilities and the user's manual for your motherboard.

- Supermicro product manuals: <https://www.supermicro.com/support/manuals>
- Product drivers and utilities: <https://www.supermicro.com/wdl>
- Product safety info: https://www.supermicro.com/about/policies/safety_information.cfm
- A secure data deletion tool designed to fully erase all data from storage devices can be found on our website:
https://www.supermicro.com/about/policies/disclaimer.cfm?url=/wdl/utility/Lot9_Secure_Data_Deletion_Utility
- Frequently Asked Questions: <https://www.supermicro.com/FAQ/index.php>
- If you still have questions after referring to our FAQs, contact our support team. Region-specific Technical Support email addresses can be found at: "[Contacting Supermicro](#)" on page 9
- If you have any feedback on Supermicro product manuals, contact our writing team at: Techwriterteam@supermicro.com

This manual may be periodically updated without notice. Check the Supermicro website for possible updates to the manual revision level.

Conventions Used in the Manual

Special attention should be given to the following symbols for proper installation and to prevent damage done to the components or injury to yourself.



Warning! Indicates important information given to prevent equipment/property damage or personal injury.



Warning! Indicates high voltage may be encountered while performing a procedure.



Warning! Indicates hazardous moving parts may be encountered while handling a fan or components near a fan.

Important: Important information given to ensure proper motherboard installation or to relay safety precautions.

Note: Additional information given to differentiate various models or to provide information for proper motherboard setup.

The information in this User's Manual has been carefully reviewed and is believed to be accurate. The vendor assumes no responsibility for any inaccuracies that may be contained in this document, and makes no commitment to update or to keep current the information in this manual, or to notify any person or organization of the updates. Note: For the most up-to-date version of this manual, see our website at <https://www.supermicro.com>.

Super Micro Computer, Inc. ("Supermicro") reserves the right to make changes to the product described in this manual at any time and without notice. This product, including software and documentation, is the property of Supermicro and/or its licensors, and is supplied only under a license. Any use or reproduction of this product is not allowed, except as expressly permitted by the terms of said license.

IN NO EVENT WILL Super Micro Computer, Inc. BE LIABLE FOR DIRECT, INDIRECT, SPECIAL, INCIDENTAL, SPECULATIVE OR CONSEQUENTIAL DAMAGES ARISING FROM THE USE OR INABILITY TO USE THIS PRODUCT OR DOCUMENTATION, EVEN IF ADVISED OF THE POSSIBILITY OF SUCH DAMAGES. IN PARTICULAR, SUPER MICRO COMPUTER, INC. SHALL NOT HAVE LIABILITY FOR ANY HARDWARE, SOFTWARE, OR DATA STORED OR USED WITH THE PRODUCT, INCLUDING THE COSTS OF REPAIRING, REPLACING, INTEGRATING, INSTALLING OR RECOVERING SUCH HARDWARE, SOFTWARE, OR DATA.

Any disputes arising between manufacturer and customer shall be governed by the laws of Santa Clara County in the State of California, USA. The State of California, County of Santa Clara shall be the exclusive venue for the resolution of any such disputes. Supermicro's total liability for all claims will not exceed the price paid for the hardware product.

FCC Statement: This equipment has been tested and found to comply with the limits for a Class A or Class B digital device pursuant to Part 15 of the FCC Rules. These limits are designed to provide reasonable protection against harmful interference when the equipment is operated in industrial environment for Class A device or in residential environment for Class B device. This equipment generates, uses, and can radiate radio frequency energy and, if not installed and used in accordance with the manufacturer's instruction manual, may cause harmful interference with radio communications. Operation of this equipment in a residential area is likely to cause harmful interference, in which case you will be required to correct the interference at your own expense.

California Best Management Practices Regulations for Perchlorate Materials: This Perchlorate warning applies only to products containing CR (Manganese Dioxide) Lithium coin cells. "Perchlorate Material-special handling may apply. See <https://www.dtsc.ca.gov/hazardouswaste/perchlorate>".



WARNING: This product can expose you to chemicals including lead, known to the State of California to cause cancer and birth defects or other reproductive harm. For more information, go to <https://www.P65Warnings.ca.gov>.



AVERTISSEMENT : Ce produit peut vous exposer à des agents chimiques, y compris le plomb, identifié par l'État de Californie comme pouvant causer le cancer, des malformations congénitales ou d'autres troubles de la reproduction. Pour de plus amples informations, prière de consulter <https://www.P65Warnings.ca.gov>.

The products sold by Supermicro are not intended for and will not be used in life support systems, medical equipment, nuclear facilities or systems, aircraft, aircraft devices, aircraft/emergency communication devices or other critical systems whose failure to perform be reasonably expected to result in significant injury or loss of life or catastrophic property damage. Accordingly, Supermicro disclaims any and all liability, and should buyer use or sell such products for use in such ultra-hazardous applications, it does so entirely at its own risk. Furthermore, buyer agrees to fully indemnify, defend and hold Supermicro harmless for and against any and all claims, demands, actions, litigation, and proceedings of any kind arising out of or related to such ultra-hazardous use or sale.

Manual Revision Draft 1.0

Release Date: February 26, 2026

Unless you request and receive written permission from Super Micro Computer, Inc., you may not copy any part of this document. Information in this document is subject to change without notice. Other products and companies referred to herein are trademarks or registered trademarks of their respective companies or mark holders.

Copyright © 2026 by Super Micro Computer, Inc.
All rights reserved.

Published in the United States of America

Contents

Contacting Supermicro	9
Chapter 1: Introduction	10
1.1 Quick Reference	11
GPU Server Board Overview	11
Quick Reference Table	12
Motherboard Features	14
Motherboard Block Diagram	16
1.2 Platform Overview	17
Flexible and Scalable Processor Architectural Design	17
New Software Capability and Performance Optimization	17
1.3 Special Features	18
Recovery from AC Power Loss	18
1.4 System Health Monitoring	19
Onboard Voltage Monitors	19
Fan Status Monitor with Firmware Control	19
Environmental Temperature Control	19
1.5 ACPI Features	20
Chapter 2: Component Installation	21
2.1 Static-Sensitive Devices	22
Precautions	22
Unpacking	22
Installing the Motherboard	22
Installing the Motherboard	24
2.2 Memory Support and Installation	26
General Guidelines for Optimizing Memory Performance	26
Memory Support	26
DIMM Installation	32
DIMM Removal	35
2.3 Battery Removal and Installation	36
Battery Removal	36
Proper Battery Disposal	36

Battery Installation	36
2.4 Connections, Jumpers, and LEDs	37
Power Supply and Power Connections	37
Power Supply Connections	37
Headers and Connections	37
AIOM Sideband Signal Header	38
BlueField-3 Card NC-SI Connection	38
BlueField-3 PCIe Signal Connectors	38
DCSCM Signal Header	38
Fan Headers	38
AIOM Card NC-SI Connection	39
TPM/Port 80 Header	39
VROC RAID Key Header	40
Front Control Panel	40
Jumper Settings	41
CMOS Clear	42
LED Indicators	42
BMC Heartbeat LED	43
M.2 LEDs	43
Chapter 3: Troubleshooting	44
3.1 Troubleshooting Procedures	45
Before Power On	45
No Power	45
No Video	45
System Boot Failure	45
Memory Errors	46
Losing the System's Setup Configuration	46
If the System Becomes Unstable	46
3.2 Technical Support Procedures	48
3.3 Motherboard Battery	49
3.4 Where to Get Replacement Components	50
3.5 Returning Merchandise for Service	51
3.6 Feedback	52

Chapter 4: UEFI BIOS	53
4.1 Introduction	54
Updating BIOS	54
Starting the Setup Utility	54
4.2 Main Setup	56
4.3 Advanced Setup Configurations	58
Boot Feature Menu	58
CPU Configuration Menu	60
Chipset Configuration Menu	63
Uncore Configuration Menu	63
Memory Configuration Menu	65
Memory Topology Menu	65
Memory Map Menu	66
Memory RAS Configuration Menu	66
Security Configuration Menu	68
In Field Scan (IFS) Menu	73
IIO Configuration Menu	73
CPU1 Configuration Menu	74
Intel VT for Directed I/O (VT-d) Menu	76
PCIe Leaky Bucket Configuration Menu	76
Trusted Computing Menu	77
ACPI Settings Menu	79
Super IO Configuration Menu	80
Serial Port 1 Configuration Menu	80
Serial Port 2 Configuration Menu	81
Serial Port Console Redirection Menu	81
Network Configuration Menu	84
PCIe/PCI/PnP Configuration Menu	85
HTTP Boot Configuration Menu	87
Supermicro KMS Server Configuration Menu	88
Super-Guardians Configuration Menu	90
Supermicro KMS Server Configuration Menu	93
Driver Health Menu	94
4.4 Event Logs	95

4.5 BMC	97
System Event Log Menu	97
BMC Network Configuration Menu	98
4.6 Security	101
Supermicro Security Erase Configuration Menu	102
Secure Boot Menu	103
4.7 Boot	107
4.8 Save & Exit	109
Appendix A: BIOS Codes	111
BIOS Error POST (Beep) Codes	111
Additional BIOS POST Codes	111
Appendix B: Software	112
Microsoft Windows OS Installation	112
Installing the OS	112
BMC	114
BMC ADMIN User Password	115
Appendix C: Standardized Warning Statements	116
Battery Handling	116
Connection to Earth	118
Product Disposal	119

Contacting Supermicro

Headquarters

Address: Super Micro Computer, Inc.
980 Rock Ave.
San Jose, CA 95131 U.S.A.

Tel: +1 (408) 503-8000

Fax: +1 (408) 503-8008

Email: Marketing@supermicro.com (General Information)
Sales-USA@supermicro.com (Sales Inquiries)
Government_Sales-USA@supermicro.com (Gov. Sales Inquiries)
Support@supermicro.com (Technical Support)
RMA@Supermicro.com (RMA Support)
Webmaster@supermicro.com (Webmaster)

Website: <https://www.supermicro.com>

Europe

Address: Super Micro Computer B.V.
Het Sterrenbeeld 28, 5215 ML
's-Hertogenbosch, The Netherlands

Tel: +31 (0) 73-6400390

Fax: +31 (0) 73-6416525

Email: Sales_Europe@supermicro.com (Sales Inquiries)
Support_Europe@supermicro.com (Technical Support)
RMA_Europe@supermicro.com (RMA Support)

Website: <https://www.supermicro.nl>

Asia-Pacific

Address: Super Micro Computer, Inc.
3F, No. 150, Jian 1st Rd.
Zhonghe Dist., New Taipei City 235 Taiwan (R.O.C)

Tel: +886 (2) 8226-3990

Fax: +886 (2) 8226-3992

Email: Sales-Asia@supermicro.com.tw (Sales Inquiries)
Support@supermicro.com.tw (Technical Support)
RMA@supermicro.com.tw (RMA Support)

Website: <https://www.supermicro.com.tw>

Chapter 1:

Introduction

Congratulations on purchasing your computer motherboard from an industry leader. Supermicro motherboards are designed to provide you with the highest standards in quality and performance.

1.1 Quick Reference	11
GPU Server Board Overview	11
Quick Reference Table	12
Motherboard Features	14
Motherboard Block Diagram	16
1.2 Platform Overview	17
Flexible and Scalable Processor Architectural Design	17
New Software Capability and Performance Optimization	17
1.3 Special Features	18
Recovery from AC Power Loss	18
1.4 System Health Monitoring	19
Onboard Voltage Monitors	19
Fan Status Monitor with Firmware Control	19
Environmental Temperature Control	19
1.5 ACPI Features	20

1.1 Quick Reference

For details on the X14DBG-LC2 motherboard layout, features, and other quick reference information, refer to the content below.

GPU Server Board Overview

This chapter provides detailed information on the components installed on the X14DBG-LC2 motherboard as well as the features supported by the GPU server.

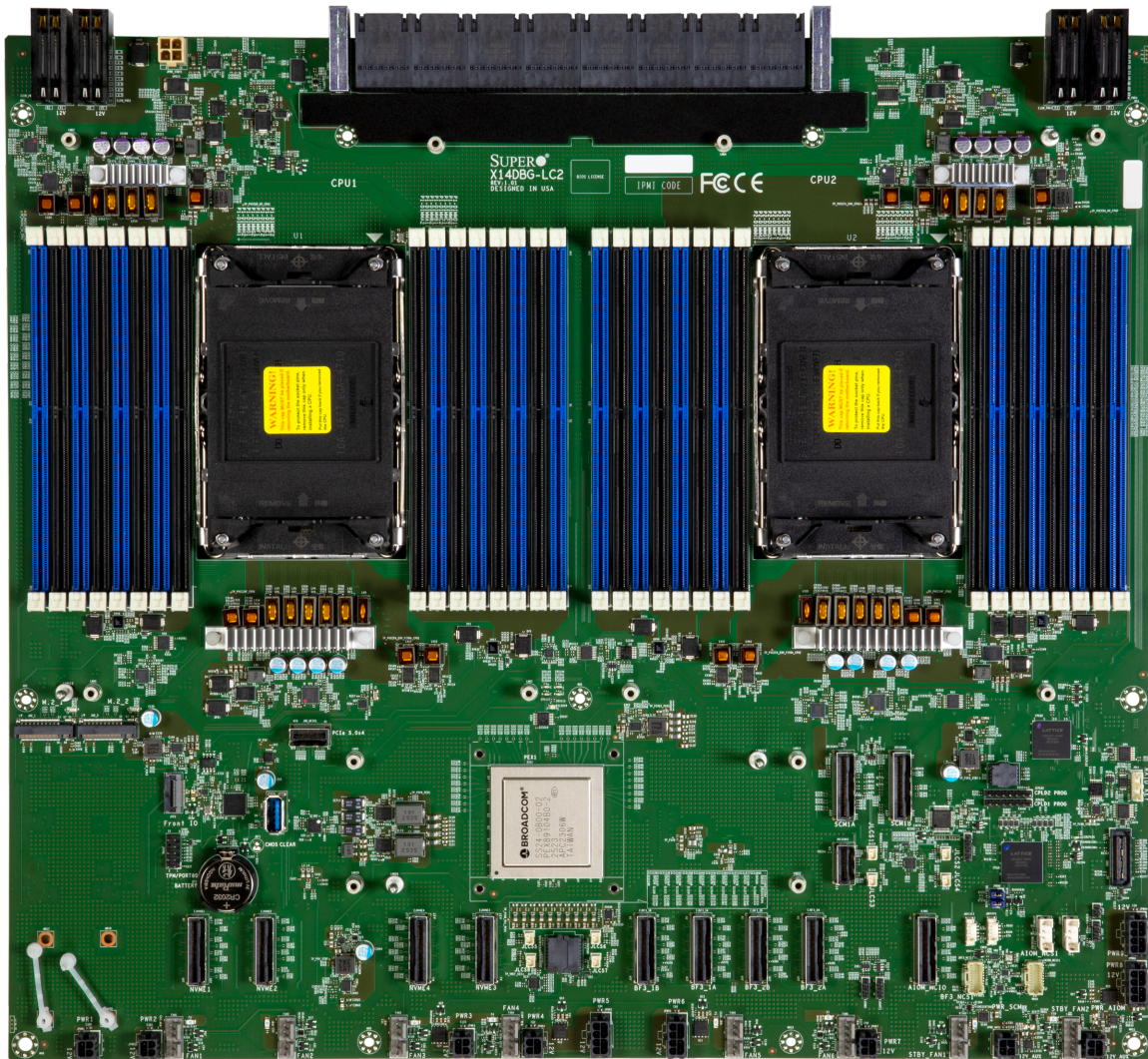

Figure 1-1. X14DBG-LC2 Motherboard Image

Note: Images displayed are for illustration purposes only. The components installed in your system may or may not look exactly the same as the graphics shown in the manual.

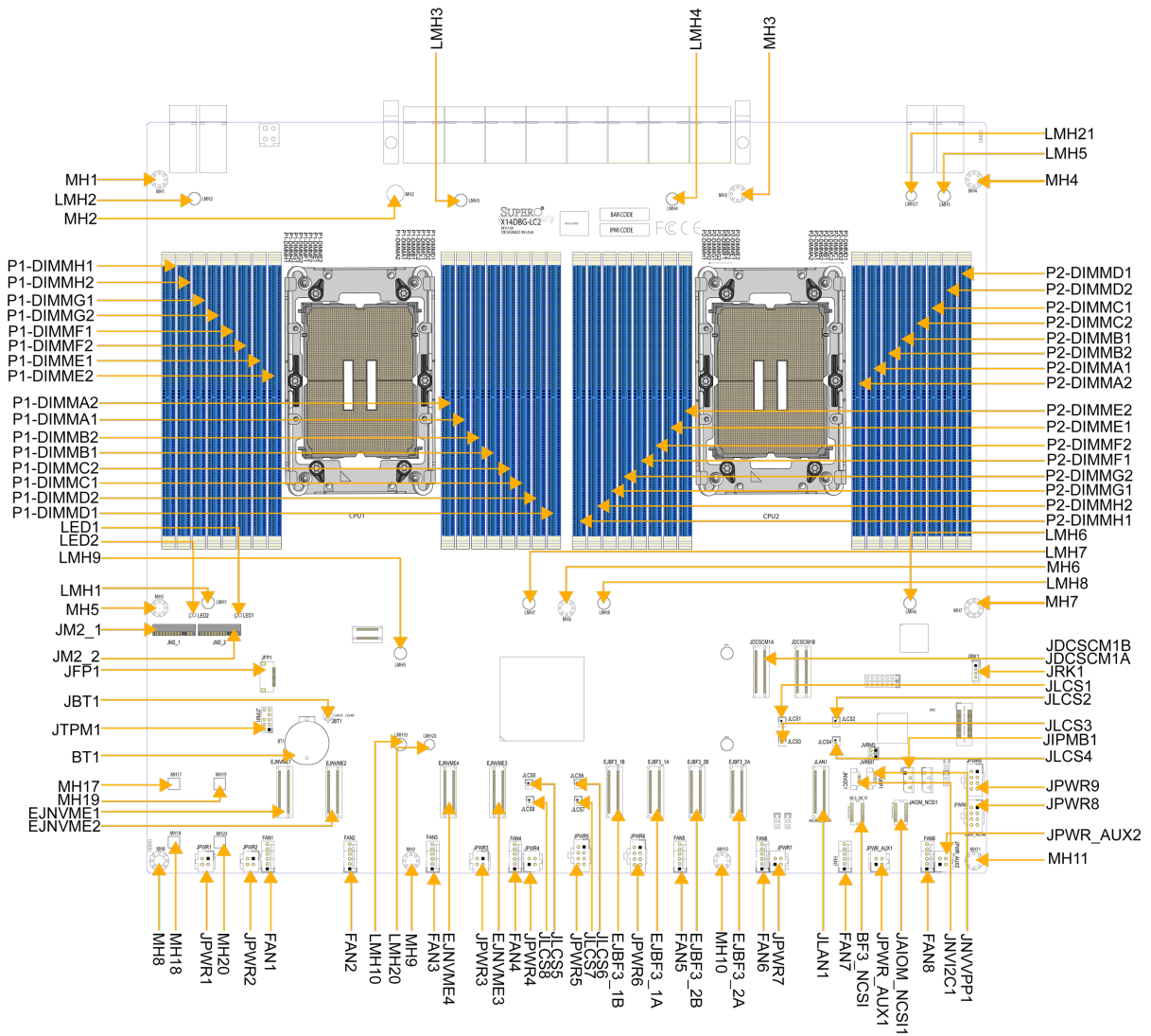

Figure 1-2. X14DBG-LC2 Motherboard Layout

Quick Reference Table

Jumper	Description	Jumper Settings (Default: Bold)
JBT1	CMOS Clear	Open (Normal)

LED	Description	Status
LEDBMC	BMC Heartbeat LED	Blinking Green: BMC Normal (Active) Solid Green: BMC resetting or cold rebooting
LEDPWR	Power LED	LED On: Onboard Power On

LED	Description	Status
LED1	M.2 LED	Blinking Green: Device Working
LED2	M.2 LED	Blinking Green: Device Working

Connector	Description
BT1	Onboard CMOS Battery
BF3_NCSI	NCSI for BF3
EJBF3_1A, EJBF3_2A, EJBF3_1B, EJBF3_2B	BF3 PCIe Signal Connectors
EJNVME1–EJNVME4	Backplane PCIe Signal Connectors
FAN1–FAN8	Fan Headers
JAIOM_NCSI1	NCSI for AIOM
JDCSCM1A, JDCSCM1B	DC-SCM Signals
JFP1	Front Control Panel Header
JM2_1–JM2_2	M.2 Slots
JLAN1	AIOM PCIe Signal Connector
JPWR1–JPWR4, JPWR7	4-pin P12V Power Connectors
JPWR5–JPWR6, JPWR8–JPWR9	8-pin P12V Power Connectors
JPWR_AUX1–JPWR_AUX2	P12V_AUX Power Connectors
JRK1	Intel VROC RAID Key Header
JTPM1	Trusted Platform Module/Port 80 Header

Note: For detailed instructions on how to configure VROC RAID settings, refer to the VROC RAID Configuration User's Guide posted on the web page under the following link: <https://www.supermicro.com/support/manuals>.

Motherboard Features

Processors
<ul style="list-style-type: none"> Supports dual Intel® Xeon® 6 Processors (in Socket E2 LGA 4710) with four UPIs (up to 24 GT/s) and a Thermal Design Power (TDP) up to 350 W Supports 6700 series with the E-cores and P-cores (XCC, LCC, and HCC) SKUs
Memory
<ul style="list-style-type: none"> Supports ECC DDR5 memory with speeds up to 6400 MT/s (1DPC), and MRDIMM DDR5 memory with speeds up to 8000 MT/s (1DPC or 1 slot per channel) in 32 DIMMs. (Memory speed/capacity support depends on the processors used in the system.)
DIMM Size
<ul style="list-style-type: none"> Up to 256 GB
Expansion Slots
<ul style="list-style-type: none"> Two PCIe 5.0 x16 connections to North/South Network Interface Cards for BlueField-3 Two NVMe M.2 ports
Baseboard Management Controller (BMC)/Network
<ul style="list-style-type: none"> ASPEED AST2600 BMC
Graphics
<ul style="list-style-type: none"> Graphics controller through ASPEED AST2600 BMC
I/O Devices
<ul style="list-style-type: none"> One display port through I/O board One VGA connector
Peripheral Devices
<ul style="list-style-type: none"> Two USB 3.0 ports through I/O board
BIOS
<ul style="list-style-type: none"> AMI SPI BIOS NAND Flash 64 MB support SPI dual / quad speed control, Real Time Clock (RTC) wakeup, riser card auto detection support, SuperServer Automation Assistant (SAA), Redundant power supply unit detection, SPM, SUM-OOB / InBand
Power Connections
<ul style="list-style-type: none"> Internal connections to middle plane and PSU

Power Management
<ul style="list-style-type: none">• ACPI power management• S1, S5 support• Power button override mechanism• Power-on mode for AC power recovery• Wake-on-LAN• Power supply monitoring
System Health Monitoring
<ul style="list-style-type: none">• Onboard voltage monitoring for +3.3 V, +3.3 V Standby, +5 V, +5 V Standby, +12 V, Vcore, Vmem• Onboard temperature monitoring for CPU, GPU, VRM, LAN, system, peripheral, memory, NIC, M.2 SSD, AOM, and NVMe devices• Eight CPU switch phase voltage regulator• CPU thermal trip support• Platform Environment Control Interface (PECI)
Fan Control
<ul style="list-style-type: none">• Fan status monitoring via BMC connections• Three cooling zones• Low-noise fan speed control• Four 6-pin proprietary fans supported
System Management
<ul style="list-style-type: none">• Chassis intrusion header and detection• Server platform service• RoHS support
Firmware Integrity / System Security
<ul style="list-style-type: none">• Trusted Platform Module (TPM) support (optional part needed)• Root of Trust (RoT) support to protect firmware security by detecting critical data corruption, and restoring platform integrity

LED Indicators
<ul style="list-style-type: none"> • CPU/system overheat LED • Power/suspend state indicator LED • Fan Fail LED • UID/remote UID • LAN activity LED • BMC/CPLD firmware LED
Dimensions
<ul style="list-style-type: none"> • 17" x 15.21" (431.8 mm x 386.3 mm) (L x W) Proprietary

Note: The CPU maximum Thermal Design Power (TDP) is subject to chassis and heatsink cooling restrictions, and it also depends on server SKUs. For proper thermal management, check the chassis and heatsink specifications.

Motherboard Block Diagram

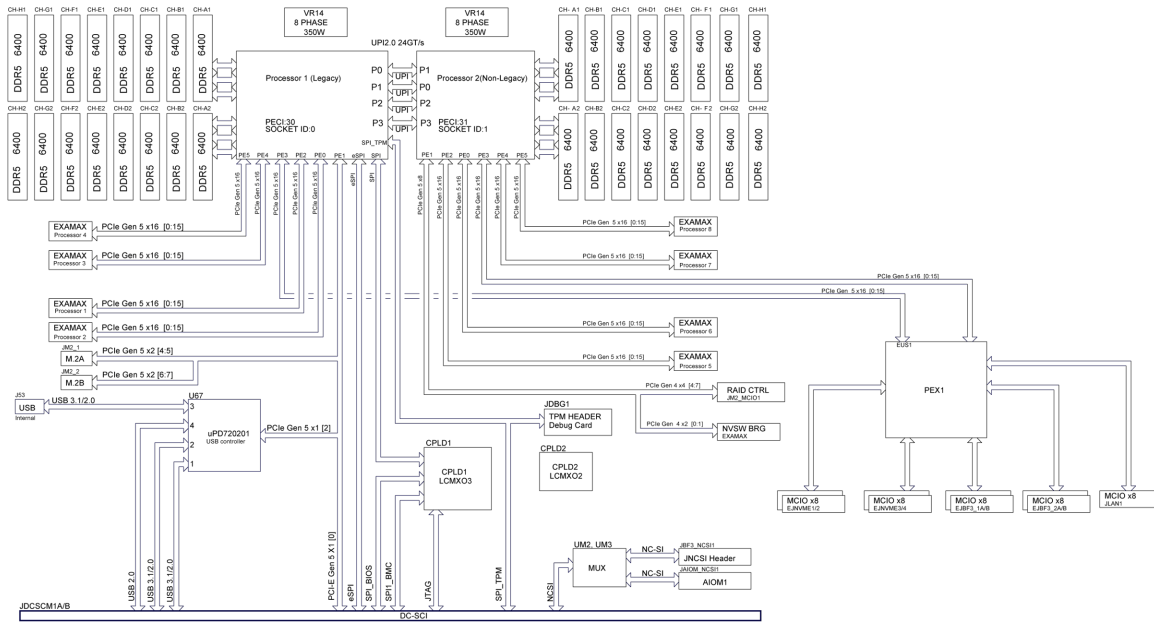

Figure 1-3. X14DBG-LC2 Motherboard Block Diagram

Note: This is a general block diagram and may not exactly represent the features on your motherboard. For the actual specifications of your motherboard, see the previous pages.

1.2 Platform Overview

Built upon the capability of the Intel® Xeon® 6, the X14DBG-LC2 motherboard provides system performance, power efficiency, and feature sets to address the needs of next-generation computer users.

The X14DBG-LC2 motherboard dramatically increases system performance for a multitude of server applications and supports the following features:

Flexible and Scalable Processor Architectural Design

The 6th Gen Xeon Scalable processor platform is built upon System-on-Chip (SoC) modular design, which offers computer systems with flexible, unrestrictive expansion options. The features include the following:

- Separate Compute and IO silicon chiplets
- Modular die fabric that enables flexible construction
- EMIB packaging with high bandwidth/low latency support
- Common IP, Firmware, OS, and platform ingredients
- Processor scalability: P-core (1S, 2S, 4S, 8S) and E-core (1S, 2S) supported (with P-core optimized for performance, and E-core, for efficiency)
- A wide range of core counts and thermals supported
- Memory: up to eight channels of DDR/MCR with one DIMM per channel support
- PCIe 88 lanes including CXL 2.0 64 lanes, up to four UPI 2.0 links support
- Self boot

New Software Capability and Performance Optimization

- AMX supports FP16 (Floating Point 16-bit format) for AI/ML
- 2K memory encryption keys with 256b strength
- 64 KB, 16-way I-cache with improved branch predictor and miss recovery
- More outstanding memory requests and prefetch capabilities
- New Intel Xeon Architecture optimized for power efficiency throughput performance

1.3 Special Features

Recovery from AC Power Loss

The Basic I/O System (BIOS) provides a setting that determines how the system will respond when AC power is lost and then restored to the system. You can choose for the system to remain powered off (in which case you must press the power switch to turn it back on), or for it to automatically return to the power-on state. See Advanced Setup Configurations under "[UEFI BIOS](#)" on [page 53](#) for this setting. The default setting is **Last State**.

1.4 System Health Monitoring

Onboard Voltage Monitors

An onboard voltage monitor will continuously scan the voltages of the onboard chipset, memory, processor, and battery. Once a voltage becomes unstable, a warning is given or an error message is sent to the screen. You can adjust the voltage thresholds to define the sensitivity of the voltage monitor. Real time voltage levels are displayed in IPMI.

Fan Status Monitor with Firmware Control

The system health monitor embedded in the BMC chip can check the RPM status of the cooling fans. The processor and chassis fans are controlled via IPMI.

Environmental Temperature Control

System Health sensors in the BMC monitor the temperatures and voltage settings of onboard processors and the system in real time via the IPMI interface. Whenever the temperature of the processor or the system exceeds a user-defined threshold, system/processor cooling fans will be turned on to prevent the processor or the system from overheating.

Note: To avoid possible system overheating, be sure to provide adequate airflow to your system.

1.5 ACPI Features

ACPI stands for Advanced Configuration and Power Interface. The ACPI specification defines a flexible and abstract hardware interface that provides a standard way to integrate power management features throughout a computer system, including its hardware, operating system, and application software. This enables the system to automatically turn on and off peripherals such as network cards, hard disk drives, and printers.

In addition to enabling operating system-directed power management, ACPI also provides a generic system event mechanism for Plug and Play and an operating system-independent interface for configuration control. ACPI leverages the Plug and Play BIOS data structures while providing a processor architecture-independent implementation that is compatible with operating systems such as Microsoft Windows, Red Hat Linux, and Ubuntu Linux. For detailed information about our certified operating systems, refer to [OS Compatibility](#).

Chapter 2:

Component Installation

This chapter provides instructions on installing and replacing main system components for the X14DBG-LC2 motherboard. To prevent compatibility issues, only use components that match the specifications and/or part numbers given.

Installation or replacement of most components require that power first be removed from the system. Follow the procedures given in each section.

2.1 Static-Sensitive Devices	22
Precautions	22
Unpacking	22
Installing the Motherboard	22
Installing the Motherboard	24
2.2 Memory Support and Installation	26
General Guidelines for Optimizing Memory Performance	26
Memory Support	26
DIMM Installation	32
DIMM Removal	35
2.3 Battery Removal and Installation	36
Battery Removal	36
Proper Battery Disposal	36
Battery Installation	36
2.4 Connections, Jumpers, and LEDs	37
Power Supply and Power Connections	37
Headers and Connections	37
Front Control Panel	40
Jumper Settings	41
LED Indicators	42

2.1 Static-Sensitive Devices

Electrostatic Discharge (ESD) can damage electronic components. To avoid damaging your motherboard, it is important to handle it very carefully. The following measures are generally sufficient to protect your equipment from ESD.

Precautions

- Use a grounded wrist strap designed to prevent static discharge.
- Touch a grounded metal object before removing the board from the antistatic bag.
- Handle the motherboard only by its edges. Do not touch its components, peripheral chips, memory modules, or gold contacts.
- When handling chips or modules, avoid touching their pins.
- Put the motherboard and peripherals back into their antistatic bags when not in use.
- For grounding purposes, make sure that your computer chassis provides excellent conductivity between the power supply, the case, the mounting fasteners, and the motherboard.
- Use only the correct type of onboard CMOS battery. To avoid possible explosion, do not install the onboard battery upside down.

Unpacking

To avoid static damage, the motherboard is shipped in antistatic packaging. When unpacking the motherboard, make sure that the person handling it is static protected.

Installing the Motherboard

1. Install the I/O shield into the back of the chassis, if applicable.

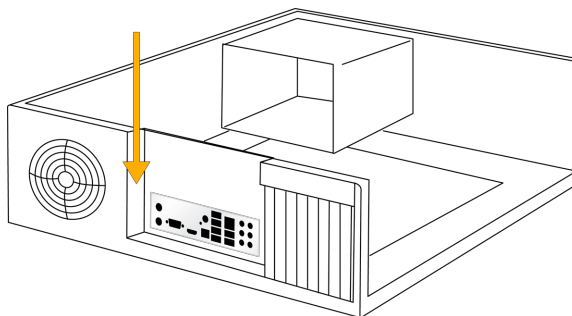

Figure 2-1. Installing the I/O Shield

Note: Images displayed are for illustration purposes only. The components installed in your system may or may not look exactly the same as the graphics shown in the manual.

2. Locate the mounting holes on the motherboard. See Motherboard Installation for the location.

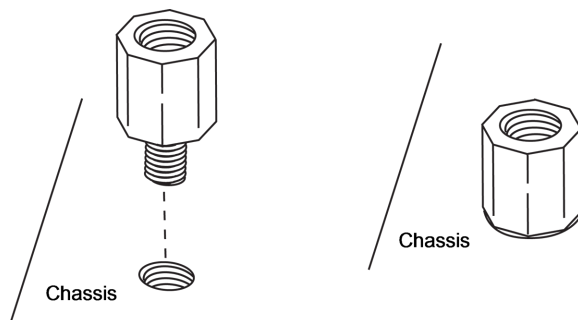

Figure 2-2. Locating the Mounting Holes

3. Locate the matching mounting holes on the chassis. Align the mounting holes on the motherboard against the mounting holes on the chassis.

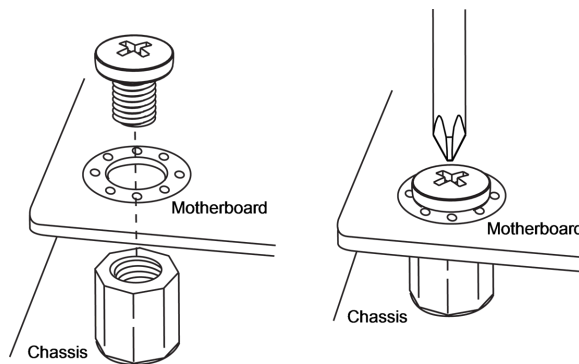

Figure 2-3. Aligning the Mounting Holes

4. Install standoffs in the chassis as needed.
5. Install the motherboard into the chassis carefully to avoid damaging other motherboard components.
6. Insert pan head #6 screws into the mounting holes on the motherboard and the matching mounting holes on the chassis.
7. Make sure that the motherboard is securely placed in the chassis.

Installing the Motherboard

1. Install the I/O shield into the back of the chassis, if applicable.

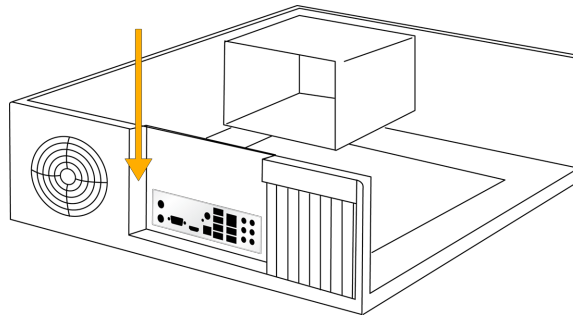

Figure 2-4. Installing the I/O Shield

Note: Images displayed are for illustration purposes only. The components installed in your system may or may not look exactly the same as the graphics shown in the manual.

2. Locate the mounting holes on the motherboard. See Motherboard Installation for the location.

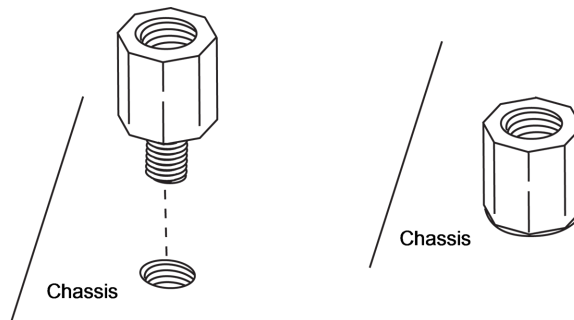

Figure 2-5. Locating the Mounting Holes

3. Locate the matching mounting holes on the chassis. Align the mounting holes on the motherboard against the mounting holes on the chassis.

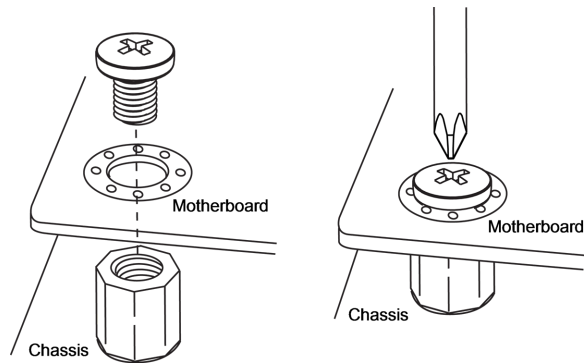

Figure 2-6. Aligning the Mounting Holes

4. Install standoffs in the chassis as needed.
5. Install the motherboard into the chassis carefully to avoid damaging other motherboard components.
6. Insert pan head #6 screws into the mounting holes on the motherboard and the matching mounting holes on the chassis.
7. Make sure that the motherboard is securely placed in the chassis.

2.2 Memory Support and Installation

Important: To prevent any damage, exercise extreme care when installing or removing memory modules.

Note: Check the Supermicro website for recommended memory modules.

General Guidelines for Optimizing Memory Performance

- Using DDR5 memories with the same type, size, speed, ranking, and density is a mandatory requirement.
- First, confirm whether the installed CPU supports P-cores or E-cores, then refer to the corresponding memory population table and install the memory correctly.
- The motherboard will support an odd number of memory modules. However, to achieve the best memory performance, a balanced memory population is recommended.

Memory Support

The X14DBG-LC2 motherboard supports up to 8 TB ECC DDR5 memory with speeds up to 6400 MT/s in 1DPC configurations with a maximum of 16 DIMMs, and up to 5200 MT/s in 2DPC configurations with a maximum of 32 DIMMs.

Note: Memory speed/capacity support depends on the processors used in the system.

DDR5-6400 Memory Support for Intel® Xeon® 6700/6500-Series Processors with P-Cores									
Type	Ranks Per DIMM, Data Width (Stack)	DIMM Capacity (GB)						Speed (MT/s); Voltage (V); Slots per Channel (SPC) and DIMMs per Channel (DPC)	
		DRAM Density							
		16 Gb		24 Gb		32 Gb		1DPC/2SPC	2DPC/2SPC
		1DPC	2DPC	1DPC	2DPC	1DPC	2DPC	+1.1 V	

DDR5-6400 Memory Support for Intel® Xeon® 6700/6500-Series Processors with P-Cores									
RDIMM	1Rx8	16 GB	-	24 GB	-	-	-	6400, 6000, 5600, 5200, 4800 (DDR5-6400 rated RDIMMs only)	5200, 4800 (DDR5-6400 rated RDIMMs only)
	1Rx4	32 GB	-	48 GB	-	-	-		
	2Rx8	32 GB	32 GB	48 GB	-	-	-		
	2Rx4	64 GB	64 GB [^]	96 GB	96 GB [^]	128 GB [*]	128 GB [*]		
3DS RDIMM	4Rx4	-	128 GB	-	-	-	-	8000, 7200 (MRDIMM- 8800 only)	N/A
	8Rx4	-	256 GB	-	-	256 GB [^]	256 GB [^]		
MRDIMM	2Rx8	32 GB	-	-	-	-	-	8000, 7200 (MRDIMM- 8800 only)	N/A
	2Rx4	64 GB	-	-	-	-	-		N/A

Notes:

- The items marked with an asterisk (*) are supported in 1S/2S/4S systems. The items with circumflex (^) are supported in 8S systems. All others support 1S/2S only
MRDIMM is supported with only 1DPC configurations only.
- Intel Xeon 6700/6500 series processors with P-cores support up to 5200 MT/s speed in 2DPC configuration with 6400 MT/s DIMMs only. 5600 MT/s DIMMs are not supported.
- Intel Xeon 6700/6500-series processors with P-cores supports 1 DIMM per processor socket with the following DIMM configurations only: 16 GB/24 GB 1Rx8 and 32 GB/48 GB 1Rx8.

DDR5-6400 Memory Support for Intel® Xeon® 6700-Series Processors with E-Cores									
Type	Ranks Per DIMM, Data Width (Stack)	DIMM Capacity (GB)						Speed (MT/s); Voltage (V); Slots per Channel (SPC) and DIMMs per Channel (DPC)	
		DRAM Density							
		16 Gb		24 Gb		32 Gb		1DPC/2SPC	2DPC/2SPC
		1DPC	2DPC	1DPC	2DPC	1DPC	2DPC	+1.1 V	

DDR5-6400 Memory Support for Intel® Xeon® 6700-Series Processors with E-Cores									
RDIMM	1Rx4	32 GB	-	-	-	-	-	6400, 6000, 5600, 5200, 4800 (DDR5-6400 rated RDIMMs only)	N/A
	2Rx8	32 GB	-	-	-	-	-		N/A
	2Rx4	64 GB	64 GB	96 GB	96 GB	-	-		5200, 4800 (DDR5-6400 rated RDIMMs only)
	2Rx4	-	-	-	-	128 GB	128 GB		
3DS RDIMM	4Rx4					256 GB	256 GB		

Intel® Xeon® 6700/6500-Series Processors with P-Cores DDR5 Memory Population Table (2 Processors and 32 DIMMs Installed, 2DPC)	
1 Processor DIMM Count	Memory Population Sequence (2DPC)
1 Processor and 1 DIMM	P1-DIMMA1
1 Processor and 4 DIMMs	P1-DIMMA1/P1-DIMMC1/P1-DIMME1/P1-DIMMG1 P1-DIMMB1/P1-DIMMD1/P1-DIMMF1/P1-DIMMH1
1 Processor and 8 DIMMs	P1-DIMMA1/P1-DIMMB1/P1-DIMMC1/P1-DIMMD1/P1-DIMME1/P1- DIMMF1/P1-DIMMG1/P1-DIMMH1 P1-DIMMA1/P1-DIMMA2/P1-DIMMC1/P1-DIMMC2/P1-DIMME1/P1- DIMME2/P1-DIMMG1/P1-DIMMG2 P1-DIMMB1/P1-DIMMB2/P1-DIMMD1/P1-DIMMD2/P1-DIMMF1/P1- DIMMF2/P1-DIMMH1/P1-DIMMH2
1 Processor and 12 DIMMs	P1-DIMMA1/P1-DIMMA2/P1-DIMMB1/P1-DIMMC1/P1-DIMMC2/P1- DIMMD1/P1-DIMME1/P1-DIMME2/P1-DIMMF1/P1-DIMMG1/P1- DIMMG2/P1-DIMMH1
1 Processor and 16 DIMMs	P1-DIMMA1/P1-DIMMA2/P1-DIMMB1/P1-DIMMB2/P1-DIMMC1/P1- DIMMC2/P1-DIMMD1/P1-DIMMD2/P1-DIMME1/P1-DIMME2/P1- DIMMF1/P1-DIMMF2/P1-DIMMG1/P1-DIMMG2/P1-DIMMH1/P1-DIMMH2
2 Processor DIMM Count (Recommended)	Memory Population Sequence (2DPC)
2 Processors and 2 DIMMs	P1-DIMMA1 P2-DIMMA1

Intel® Xeon® 6700/6500-Series Processors with P-Cores DDR5 Memory Population Table (2 Processors and 32 DIMMs Installed, 2DPC)	
2 Processors and 8 DIMMs	P1-DIMMA1/P1-DIMMC1/P1-DIMME1/P1-DIMMG1 P2-DIMMA1/P2-DIMMC1/P2-DIMME1/P2-DIMMG1
2 Processors and 8 DIMMs	P1-DIMMB1/P1-DIMMD1/P1-DIMMF1/P1-DIMMH1 P2-DIMMB1/P2-DIMMD1/P2-DIMMF1/P2-DIMMH1
2 Processors and 16 DIMMs	P1-DIMMA1/P1-DIMMB1/P1-DIMMC1/P1-DIMMD1/P1-DIMME1/P1-DIMMF1/P1-DIMMG1/P1-DIMMH1 P2-DIMMA1/P2-DIMMB1/P2-DIMMC1/P2-DIMMD1/P2-DIMME1/P2-DIMMF1/P2-DIMMG1/P2-DIMMH1
2 Processors and 16 DIMMs	P1-DIMMA1/P1-DIMMA2/P1-DIMMC1/P1-DIMMC2/P1-DIMME1/P1-DIMME2/P1-DIMMG1/P1-DIMMG2 P2-DIMMA1/P2-DIMMA2/P2-DIMMC1/P2-DIMMC2/P2-DIMME1/P1-DIMME2/P2-DIMMG1/P2-DIMMG2
2 Processors and 16 DIMMs	P1-DIMMB1/P1-DIMMB2/P1-DIMMD1/P1-DIMMD2/P1-DIMMF1/P1-DIMMF2/P1-DIMMH1/P1-DIMMH2 P2-DIMMB1/P2-DIMMB2/P2-DIMMD1/P2-DIMMD2/P2-DIMMF1/P2-DIMMF2/P2-DIMMH1/P2-DIMMH2
2 Processors and 24 DIMMs	P1-DIMMA1/P1-DIMMA2/P1-DIMMB1/P1-DIMMC1/P1-DIMMC2/P1-DIMMD1/P1-DIMME1/P1-DIMME2/P1-DIMMF1/P1-DIMMG1/P1-DIMMG2/P1-DIMMH1 P2-DIMMA1/P2-DIMMA2/P2-DIMMB1/P2-DIMMC1/P2-DIMMC2/P2-DIMMD1/P2-DIMME1/P2-DIMME2/P2-DIMMF1/P2-DIMMG1/P2-DIMMG2/P2-DIMMH1
2 Processors and 32 DIMMs	P1-DIMMA1/P1-DIMMA2/P1-DIMMB1/P1-DIMMB2/P1-DIMMC1/P1-DIMMC2/P1-DIMMD1/P1-DIMMD2/P1-DIMME1/P1-DIMME2/P1-DIMMF1/P1-DIMMF2/P1-DIMMG1/P1-DIMMG2/P1-DIMMH1/P1-DIMMH2 P2-DIMMA1/P2-DIMMA2/P2-DIMMB1/P2-DIMMB2/P2-DIMMC1/P2-DIMMC2/P2-DIMMD1/P2-DIMMD2/P2-DIMME1/P2-DIMME2/P2-DIMMF1/P2-DIMMF2/P2-DIMMG1/P2-DIMMG2/P2-DIMMH1/P2-DIMMH2

Intel® Xeon® 6700/6500-Series Processors with P-Cores DDR5 Memory Population Table (2 Processors and 32 DIMMs Installed, 1DPC)	
1 Processor DIMM Count	Memory Population Sequence (1DPC)

Intel® Xeon® 6700/6500-Series Processors with P-Cores DDR5 Memory Population Table (2 Processors and 32 DIMMs Installed, 1DPC)	
1 Processor and 1 DIMM	P1-DIMMA1
1 Processor and 4 DIMMs	P1-DIMMA1/P1-DIMMC1/P1-DIMME1/P1-DIMMG1 P1-DIMMB1/P1-DIMMD1/P1-DIMMH1/P1-DIMMF1
1 Processor and 8 DIMMs	P1-DIMMA1/P1-DIMMB1/P1-DIMMC1/P1-DIMMD1/P1-DIMME1/P1-DIMMF1/P1-DIMMG1/P1-DIMMH1
2 Processor (Recommended)	<i>Memory Population Sequence (1DPC)</i>
2 Processors and 8 DIMMs	P1-DIMMA1/P1-DIMMC1/P1-DIMME1/P1-DIMMG1 P2-DIMMA1/P2-DIMMC1/P2-DIMME1/P2-DIMMG1
2 Processors and 8 DIMMs	P1-DIMMB1/P1-DIMMD1/P1-DIMMF1/P1-DIMMH1 P2-DIMMB1/P2-DIMMD1/P2-DIMMF1/P2-DIMMH1
2 Processors and 16 DIMMs	P1-DIMMA1/P1-DIMMB1/P1-DIMMC1/P1-DIMMD1/P1-DIMME1/P1-DIMMF1/P1-DIMMG1/P1-DIMMH1 P2-DIMMA1/P2-DIMMB1/P2-DIMMC1/P2-DIMMD1/P2-DIMME1/P2-DIMMF1/P2-DIMMG1/P2-DIMMH1

Intel® Xeon® 6700-Series Processors with E-Cores DDR5 Memory Population Table (2 Processors and 32 DIMMs Installed, 2DPC)	
1 Processor DIMM Count	<i>Memory Population Sequence (2DPC)</i>
1 Processor and 1 DIMM	P1-DIMMA1
1 Processor and 4 DIMMs	P1-DIMMA1/P1-DIMMC1/P1-DIMME1/P1-DIMMG1 P1-DIMMB1/P1-DIMMD1/P1-DIMMF1/P1-DIMMH1
1 Processor and 8 DIMMs	P1-DIMMA1/P1-DIMMB1/P1-DIMMC1/P1-DIMMD1/P1-DIMME1/P1-DIMMF1/P1-DIMMG1/P1-DIMMH1 P1-DIMMA1/P1-DIMMA2/P1-DIMMC1/P1-DIMMC2/P1-DIMME1/P1-DIMME2/P1-DIMMG1/P1-DIMMG2 P1-DIMMB1/P1-DIMMB2/P1-DIMMD1/P1-DIMMD2/P1-DIMMF1/P1-DIMMF2/P1-DIMMH1/P1-DIMMH2

Intel® Xeon® 6700-Series Processors with E-Cores DDR5 Memory Population Table (2 Processors and 32 DIMMs Installed, 2DPC)	
1 Processor and 12 DIMMs	P1-DIMMA1/P1-DIMMA2/P1-DIMMB1/P1-DIMMC1/P1-DIMMC2/P1-DIMMD1/P1-DIMME1/P1-DIMME2/P1-DIMMF1/P1-DIMMG1/P1-DIMMG2/P1-DIMMH1
1 Processor and 16 DIMMs	P1-DIMMA1/P1-DIMMA2/P1-DIMMB1/P1-DIMMB2/P1-DIMMC1/P1-DIMMC2/P1-DIMMD1/P1-DIMMD2/P1-DIMME1/P1-DIMME2/P1-DIMMF1/P1-DIMMF2/P1-DIMMG1/P1-DIMMG2/P1-DIMMH1/P1-DIMMH2
2 Processor DIMM Count (Recommended)	Memory Population Sequence (2DPC)
2 Processors and 2 DIMMs	P1-DIMMA1 P2-DIMMA1
2 Processors and 8 DIMMs	P1-DIMMA1/P1-DIMMC1/P1-DIMME1/P1-DIMMG1 P2-DIMMA1/P2-DIMMC1/P2-DIMME1/P2-DIMMG1
2 Processors and 8 DIMMs	P1-DIMMB1/P1-DIMMD1/P1-DIMMF1/P1-DIMMH1 P2-DIMMB1/P2-DIMMD1/P2-DIMMF1/P2-DIMMH1
2 Processors and 16 DIMMs	P1-DIMMA1/P1-DIMMA2/P1-DIMMC1/P1-DIMMC2/P1-DIMME1/P1-DIMME2/P1-DIMMG1/P1-DIMMG2 P2-DIMMA1/P2-DIMMA2/P2-DIMMC1/P2-DIMMC2/P2-DIMME1/P2-DIMME2/P2-DIMMG1/P2-DIMMG2
2 Processors and 16 DIMMs	P1-DIMMB1/P1-DIMMB2/P1-DIMMD1/P1-DIMMD2/P1-DIMMF1/P1-DIMMF2/P1-DIMMH1/P1-DIMMH2 P2-DIMMB1/P2-DIMMB2/P2-DIMMD1/P2-DIMMD2/P2-DIMMF1/P2-DIMMF2/P2-DIMMH1/P2-DIMMH2
2 Processors and 16 DIMMs	P1-DIMMA1/P1-DIMMB1/P1-DIMMC1/P1-DIMMD1/P1-DIMME1/P1-DIMMF1/P1-DIMMG1/P1-DIMMH1 P2-DIMMA1/P2-DIMMB1/P2-DIMMC1/P2-DIMMD1/P2-DIMME1/P2-DIMMF1/P2-DIMMG1/P2-DIMMH1
2 Processors and 32 DIMMs	P1-DIMMA1/P1-DIMMA2/P1-DIMMB1/P1-DIMMB2/P1-DIMMC1/P1-DIMMC2/P1-DIMMD1/P1-DIMMD2/P1-DIMME1/P1-DIMME2/P1-DIMMF1/P1-DIMMF2/P1-DIMMG1/P1-DIMMG2/P1-DIMMH1/P1-DIMMH2 P2-DIMMA1/P2-DIMMA2/P2-DIMMB1/P2-DIMMB2/P2-DIMMC1/P2-DIMMC2/P2-DIMMD1/P2-DIMMD2/P2-DIMME1/P2-DIMME2/P2-DIMMF1/P2-DIMMF2/P2-DIMMG1/P2-DIMMG2/P2-DIMMH1/P2-DIMMH2

Intel® Xeon® 6700-Series Processors with E-Cores DDR5 Memory Population Table (2 Processors and 32 DIMMs Installed, 1DPC)	
1 Processor DIMM Count	Memory Population Sequence (1DPC)
1 Processor and 1 DIMM	P1-DIMMA1
1 Processor and 4 DIMMs	P1-DIMMA1/P1-DIMMC1/P1-DIMME1/P1-DIMMG1 P1-DIMMB1/P1-DIMMD1/P1-DIMMH1/P1-DIMMF1
1 Processor and 8 DIMMs	P1-DIMMA1/P1-DIMMB1/P1-DIMMC1/P1-DIMMD1/P1-DIMME1/P1-DIMMF1/P1-DIMMG1/P1-DIMMH1
2 Processor DIMM Count (Recommended)	Memory Population Sequence (1DPC)
2 Processors and 8 DIMMs	P1-DIMMA1/P1-DIMMC1/P1-DIMME1/P1-DIMMG1 P2-DIMMA1/P2-DIMMC1/P2-DIMME1/P2-DIMMG1
2 Processors and 8 DIMMs	P1-DIMMB1/P1-DIMMD1/P1-DIMMF1/P1-DIMMH1 P2-DIMMB1/P2-DIMMD1/P2-DIMMF1/P2-DIMMH1
2 Processors and 16 DIMMs	P1-DIMMA1/P1-DIMMB1/P1-DIMMC1/P1-DIMMD1/P1-DIMME1/P1-DIMMF1/P1-DIMMG1/P1-DIMMH1 P2-DIMMA1/P2-DIMMB1/P2-DIMMC1/P2-DIMMD1/P2-DIMME1/P2-DIMMF1/P2-DIMMG1/P2-DIMMH1

DIMM Installation

Important: To avoid causing any damage to the memory module or the DIMM socket, do not use excessive force when pressing the release tabs on the ends of the DIMM socket. Handle memory modules with care. To avoid ESD-related damage to your memory modules or components, carefully follow all the instructions given in "[Static-Sensitive Devices](#)" on [page 22](#).

1. Insert the desired number of DIMMs into the memory slots based on the recommended DIMM population table earlier in this section.
2. Push the release tabs outwards on both ends of the DIMM slot to unlock it.

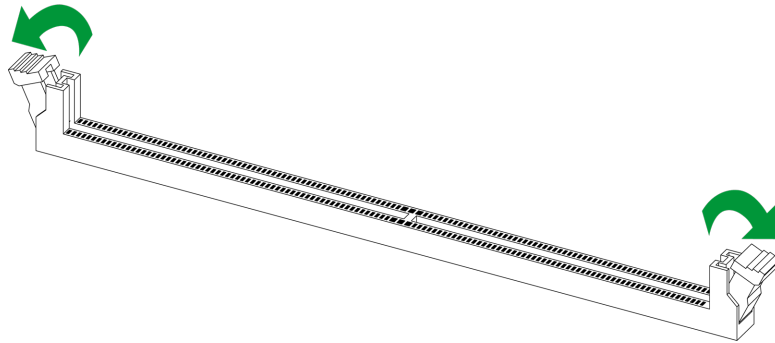

Figure 2-7. Unlocking the DIMM Slot

3. Align the key of the DIMM with the receptive point on the memory slot.

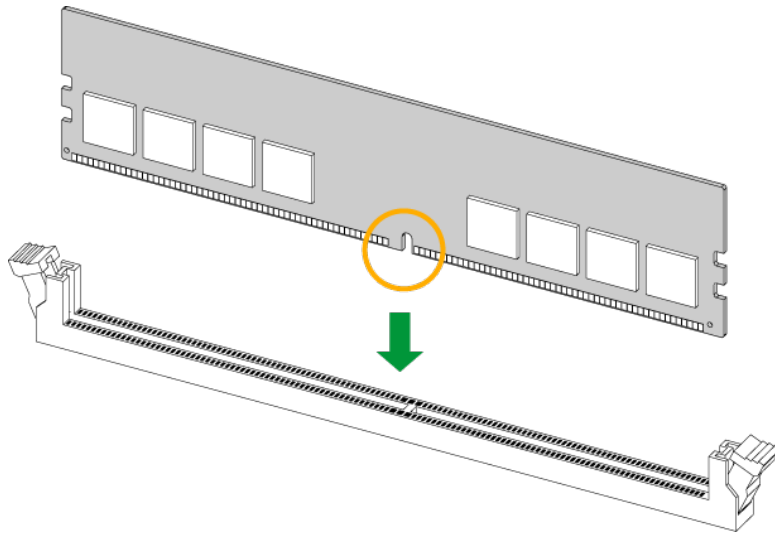

Figure 2-8. Aligning the DIMM Slot with the Receptive Point

4. Align the notches on both ends of the module against the receptive points on the ends of the slot.

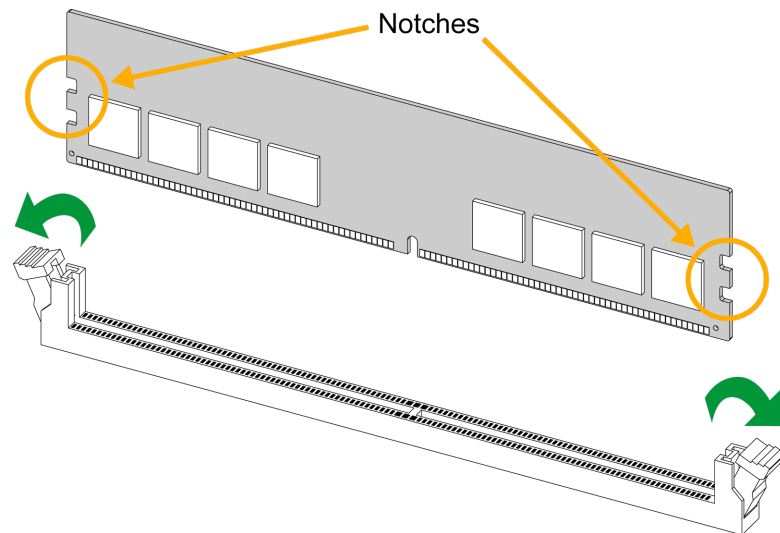

Figure 2-9. Aligning the Notches

5. Press both ends of the module straight down into the slot until the module snaps into place.
6. Press the release tabs to the lock positions to secure the DIMM into the slot.

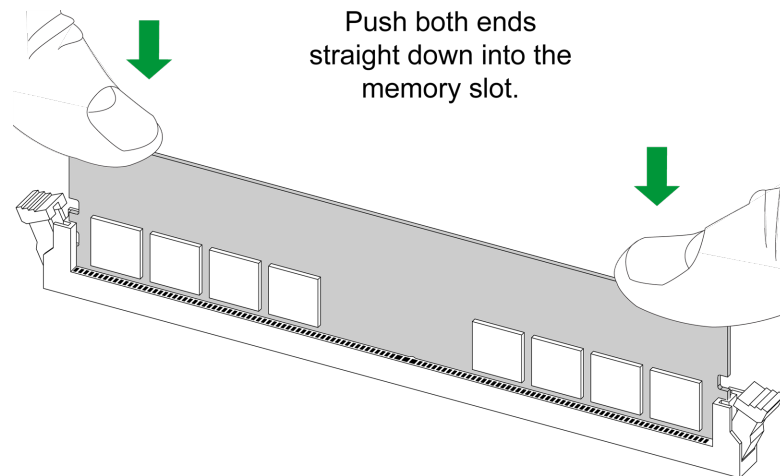

Figure 2-10. Securing the DIMM

For a detailed diagram of the X14DBG-LC2 motherboard, see the layout under ["Quick Reference"](#) on page 11.

DIMM Removal

Important: To avoid causing any damage to the memory module or the DIMM socket, do not use excessive force when pressing the release tabs on the ends of the DIMM socket. Handle memory modules with care. To avoid ESD-related damage to your memory modules or components, carefully follow all the instructions given in "[Static-Sensitive Devices](#)" on [page 22](#).

Press both release tabs on the ends of the DIMM socket to unlock it. Once the DIMM is loosened, remove it from the memory slot.

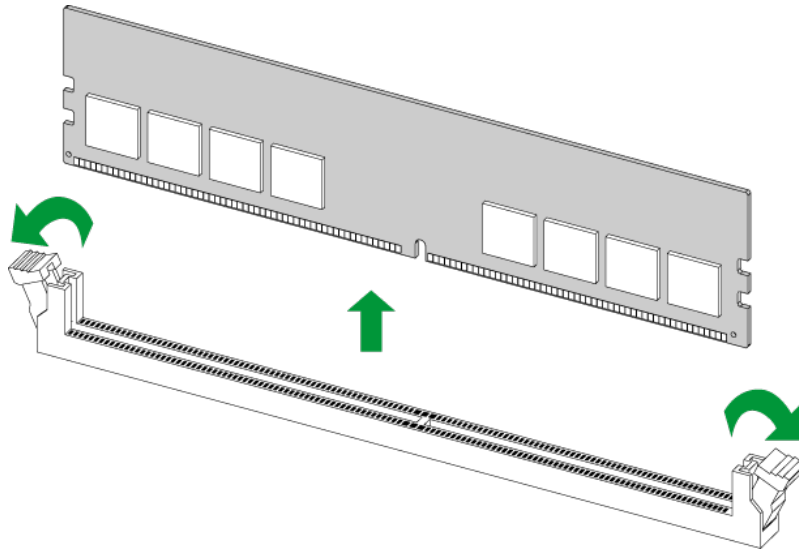

Figure 2-11. Unlocking the DIMM Slot

For a detailed diagram of the X14DBG-LC2 motherboard, see the layout under "[Quick Reference](#)" on [page 11](#).

2.3 Battery Removal and Installation

Battery Removal

To remove the onboard battery, follow the steps below:

1. Power off your system and unplug your power cable.
2. Place the system on a workbench.
3. Remove the top cover from the system.
4. Locate the onboard battery as shown below.
5. Using a tool such as a pen or a small screwdriver, push the battery lock outwards to unlock it. Once unlocked, the battery will pop out from the holder.
6. Remove the battery.

Proper Battery Disposal

Important: Handle used batteries carefully. Do not damage the battery in any way; a damaged battery may release hazardous materials into the environment. Do not discard a used battery in the garbage or a public landfill. Comply with the regulations set up by your local hazardous waste management agency to dispose of your used battery properly.

Battery Installation

To install an onboard battery, follow steps 1 and 2 above and continue below:

Important: When replacing a battery, be sure to only replace it with the same type.

1. Identify the battery's polarity. The positive (+) side should be facing up.
2. Insert the battery into the battery holder and push it down until you hear a click to ensure that the battery is securely locked.

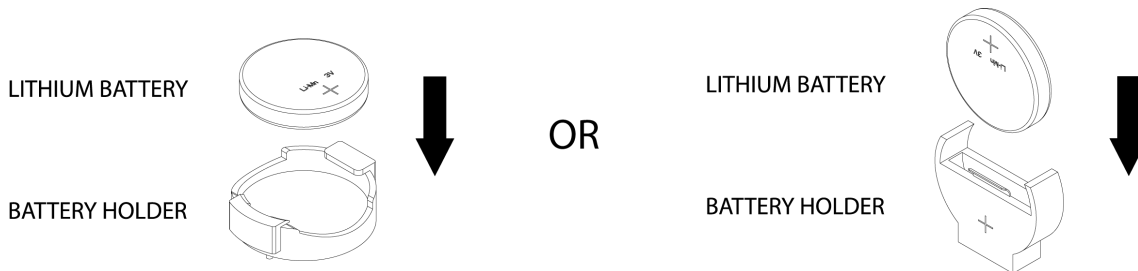

Figure 2-12. Installing a Battery

2.4 Connections, Jumpers, and LEDs

Refer to the following sections for information about connections, jumpers, and LEDs for the X14DBG-LC2 motherboard.

Power Supply and Power Connections

For information about the power supply and power connections of the X14DBG-LC2 motherboard, refer to the following content.

Power Supply Connections

Five 4-pin power connections (JPWR1–JPWR4, JPWR7) are used for +12 V devices. Another four 8-pin power connections (JPWR5–JPWR6, JPWR8–JPWR9) provide additional power for system use. All these power connections meet the ATX SSI EPS 12 V specification and must be connected to your power supply to provide adequate power to your system.

Important: To provide adequate power to your system, be sure to connect the main power supplies (PSU1/PSU2) to the power supply. Failure to do so may void the manufacturer warranty on your power supply and motherboard.

For a detailed diagram of the X14DBG-LC2 motherboard, see the layout under "[Quick Reference](#)" on page 11.

4-pin Power Connector	
Pin Definitions: Four Total	
Pin#	Definition
1–2	GND
3–4	+12 V (12 V Power)

8-pin Power Connector	
Pin Definitions: Eight Total	
Pin#	Definition
1–4	GND
5–8	+12 V (12 V Power)

Headers and Connections

For information about the headers on the X14DBG-LC2 motherboard, refer to the following content.

AIOM Sideband Signal Header

This motherboard supports an AIOM slot, which has support for an AIOM sideband header. Use the header located at JLAN1 on the X14DBG-LC2 motherboard for sideband communication.

For a detailed diagram of the X14DBG-LC2 motherboard, see the layout under "[Quick Reference](#)" on page 11.

BlueField-3 Card NC-SI Connection

The Network Controller Sideband Interface (NC-SI) connection for BlueField-3 (BF3) card is located BF3_NCSI on the X14DBG-LC2 motherboard.

Note: For detailed instructions on how to configure Network Interface Card (NIC) settings, refer to the Network Interface Card Configuration User's Guide posted on the web page under the link: <https://www.supermicro.com/support/manuals>.

For a detailed diagram of the X14DBG-LC2 motherboard, see the layout under "[Quick Reference](#)" on page 11.

BlueField-3 PCIe Signal Connectors

The BlueField-3 (BF3) PCIe signal connectors are located at EJBF3_1A, EJBF3_2A, EJBF3_1B, and EJBF3_2B on the X14DBG-LC2 motherboard.

For a detailed diagram of the X14DBG-LC2 motherboard, see the layout under "[Quick Reference](#)" on page 11.

DCSCM Signal Header

Two DCSCM card connectors is located JDCSCM1A and JDCSCM1B on the X14DBG-LC2 motherboard. This connector connects to a backplane add-on card expansion slot.

For a detailed diagram of the X14DBG-LC2 motherboard, see the layout under "[Quick Reference](#)" on page 11.

Fan Headers

There are eight 6-pin fan headers (FAN1–FAN8) on the X14DBG-LC2 motherboard. All the 4-pin fan headers are backwards compatible with the traditional 3-pin fans. However, fan speed control is available for all fans by Thermal Management via the IPMI 2.0 interface.

6-pin Fan Header			
Pin Definitions: Six Total			
Pin#	Definition	Pin#	Definition
1	GND	4	+12 V
2	+12 V	5	Tachometer
3	GND	6	PWM

AIOM Card NC-SI Connection

The Network Controller Sideband Interface (NC-SI) connection for AIOM card is located at JAIOM_NCSI1 on the X14DBG-LC2 motherboard.

Note: For detailed instructions on how to configure Network Interface Card (NIC) settings, refer to the Network Interface Card Configuration User's Guide posted on the web page under the link: <https://www.supermicro.com/support/manuals>.

For a detailed diagram of the X14DBG-LC2 motherboard, see the layout under "[Quick Reference](#)" on page 11.

TPM/Port 80 Header

The JTPM1 header on the X14DBG-LC2 motherboard is used to connect a Trusted Platform Module (TPM)/Port 80, which is available from Supermicro (optional). A TPM/Port 80 connector is a security device that supports encryption and authentication in hard drives. It allows the motherboard to deny access if the TPM associated with the hard drive is not installed in the system. Information on the TPM is available at the following page:

<https://www.supermicro.com/en/products/accessories/addon/AOM-TPM-9672V.php>

For a detailed diagram of the X14DBG-LC2 motherboard, see the layout under "[Quick Reference](#)" on page 11.

Trusted Platform Module Header			
Pin Definitions: 10 Total			
Pin#	Definition	Pin#	Definition
1	+3.3 V	2	SPI_CS#
3	RESET#	4	SPI_MISO
5	SPI_CLK	6	Ground
7	SPI_MOSI	8	No Connection
9	+1.8 V Standby	10	SPI_IRQ#

VROC RAID Key Header

A VROC RAID Key header is located at JRK1 on the X14DBG-LC2 motherboard. Install a VROC RAID key on JRK1 for NVMe RAID support as shown in the illustration below.

For a detailed diagram of the X14DBG-LC2 motherboard, see the layout under "[Quick Reference](#)" on page 11.

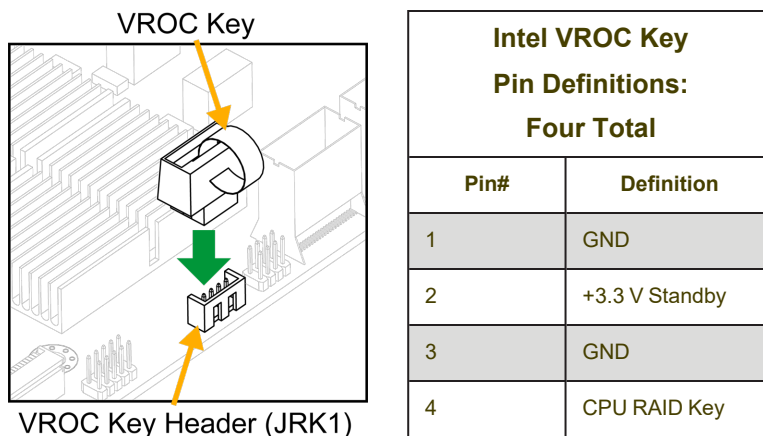

Note: Images displayed are for illustrative purposes only. The components installed in your system may or may not look exactly the same as the graphics shown in the manual.

Note: For detailed instructions on how to configure VROC RAID settings, refer to the VROC RAID Configuration User's Guide posted on the web page under the following link: <https://www.supermicro.com/support/manuals>.

Front Control Panel

There is a front control panel header located on this motherboard. The front control panel header, located at JFP1, contains header pins for various buttons and LED indicators with I²C support for front access. This head is designed specifically for use with the Supermicro chassis.

For a detailed diagram of the X14DBG-LC2 motherboard, see the layout under "[Quick Reference](#)" on page 11.

JFP1

1	○	Power Button
2	○	Reset/UID Button
3	○	UID LED_N
4	○	Fail LED_N (OH/FF/PF)
5	○	LAN-2 Activity LED
6	○	LAN-1 Activity LED (Aggregate all LAN)
7	○	Storage Drive Activity LED
8	○	Standby LED_N
9	○	Power/RoT LED_N
10	○	P3V3_STBY
11	○	GND
12	○	I2C Data
13	○	I2C Clock
14	○	GND
15	○	Power Fail LED_P
16	○	P5V_USB
17	○	P5V_USB
18	○	P5V_USB
19	○	Power Fail LED_N
20	○	GND

Figure 2-13. Front Control Panel Pin Definitions

Jumper Settings

To modify the operation of the motherboard, jumpers can be used to choose between optional settings. Jumpers create shorts between two pins to change the function of the connector. Pin 1 is identified with a square solder pad on the printed circuit board. See the diagram below for an example of jumping pins 1 and 2. Refer to the motherboard layout page for jumper locations.

Note: On two-pin jumpers, "Closed" means the jumper is on and "Open" means the jumper is off the pins.

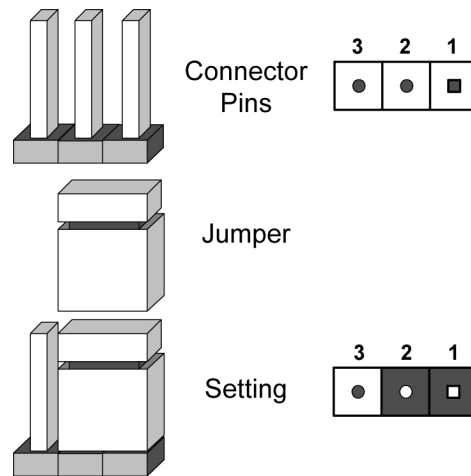

Figure 2-14. Jumping Connector Pins

CMOS Clear

JBT1 on the X14DBG-LC2 motherboard is used to clear CMOS, which will also clear any passwords. Instead of pins, this jumper consists of contact pads to prevent accidentally clearing the contents of CMOS.

For a detailed diagram of the X14DBG-LC2 motherboard, see the layout under "[Quick Reference](#)" on page 11.



1. First power down the system and unplug the power cord(s).
2. Remove the cover of the chassis to access the motherboard.
3. Remove the onboard battery from the motherboard.
4. Short the CMOS pads, JBT1, with a metal object such as a small screwdriver for at least four seconds.

Note: Clearing CMOS will also clear all passwords.

5. Remove the screwdriver (or shorting device).
6. Replace the cover, reconnect the power cord(s), and power on the system.

LED Indicators

For information about the LED indicators on the X14DBG-LC2 motherboard, refer to the following content.

BMC Heartbeat LED

A BMC Heartbeat LED is located on the X14DBG-LC2 motherboard. When this LED is blinking, the BMC is functioning normally.

For a detailed diagram of the X14DBG-LC2 motherboard, see the layout under "[Quick Reference](#)" on page 11.

BMC Heartbeat LED Indicator	
LED Color	Definition
Green: Blinking	BMC Normal

M.2 LEDs

M.2 LEDs are located at LED1 and LED2 on the X14DBG-LC2 motherboard. When these LEDs are blinking, the M.2 devices are functioning normally.

For a detailed diagram of the X14DBG-LC2 motherboard, see the layout under "[Quick Reference](#)" on page 11.

M.2 LED State	
LED Color	Definition
Green: Blinking	Device Working

Chapter 3:

Troubleshooting

The following content contains information on common issues and how to resolve them.

3.1 Troubleshooting Procedures	45
Before Power On	45
No Power	45
No Video	45
System Boot Failure	45
Memory Errors	46
Losing the System's Setup Configuration	46
If the System Becomes Unstable	46
3.2 Technical Support Procedures	48
3.3 Motherboard Battery	49
3.4 Where to Get Replacement Components	50
3.5 Returning Merchandise for Service	51
3.6 Feedback	52

3.1 Troubleshooting Procedures

Use the following procedures to troubleshoot your system. If you have followed all of the procedures below and still need assistance, refer to the ["Technical Support Procedures" on page 48](#) or ["Returning Merchandise for Service" on page 51](#) section(s) in this chapter. Always disconnect the AC power cord before adding, changing or installing any non hot-swappable hardware components. If the below steps do not fix the setup configuration problem, contact your vendor for repairs.

Before Power On

1. Make sure that there are no short circuits between the motherboard and chassis.
2. Disconnect all ribbon/wire cables from the motherboard, including those for the keyboard and mouse.
3. Remove all add-on cards.
4. Install the processor (making sure it is fully seated) and connect the front panel connectors to the motherboard.

No Power

1. Make sure that there are no short circuits between the motherboard and the chassis.
2. Make sure that the power connectors are properly connected.
3. Check that the 115 V/230 V switch, if available, on the power supply is properly set.
4. Turn the power switch on and off to test the system, if applicable.
5. Check the processor socket for bent pins and make sure the processor is fully seated.
6. The battery on your motherboard may be old. Check to verify that it still supplies approximately 3 VDC. If it does not, replace it with a new one.

No Video

1. If the power is on, but you do not have video, remove all add-on cards and cables.
2. Remove all memory modules and turn on the system (if the alarm is on, check the specs of memory modules, reset the memory, or try a different one).

System Boot Failure

If the system does not display Power-On-Self-Test (POST) or does not respond after the power is turned on, do the following:

1. Check the screen for an error message.
2. Clear the CMOS settings by unplugging the power cord and contacting both pads on the CMOS clear jumper. Restart the system. Refer to ["CMOS Clear" on page 42](#).
3. Remove all components from the motherboard and turn on the system with only one DIMM installed. If the system boots, turn off the system and repopulate the components back into the system to retest. Add one component at a time to isolate which one may have caused the system boot issue.

Memory Errors

When suspecting faulty memory is causing the system issue, check the following:

1. Make sure that the memory modules are compatible with the system and are properly installed. See ["Component Installation" on page 21](#) for installation instructions. (For memory compatibility, refer to the "Tested Memory List" link on the motherboard's product page to see a list of supported memory.)
2. Check if different speeds of DIMMs have been installed. It is strongly recommended that you use the same RAM type and speed for all DIMMs in the system.
3. Make sure that you are using the correct type of DIMMs recommended by the manufacturer.
4. Check for bad DIMMs or slots by swapping a single module among all memory slots and check the results.

Losing the System's Setup Configuration

1. Make sure that you are using a high-quality power supply. A poor-quality power supply may cause the system to lose the CMOS setup information. Refer to ["Introduction" on page 10](#) for details on recommended power supplies.
2. The battery on your motherboard may be old. Check to verify that it still supplies approximately 3 VDC. If it does not, replace it with a new one.

If the System Becomes Unstable

If the system becomes unstable during or after OS installation, check the following:

1. Processor/BIOS support: Make sure that your processor is supported and that you have the latest BIOS installed in your system.

2. Memory support: Make sure that the memory modules are supported. Refer to the product page on our website at <https://www.supermicro.com>. Test the modules using memtest86 or a similar utility.

Note: Click on the "Tested Memory List" link on the motherboard's product page to see a list of supported memory.

3. Storage Drive support: Make sure that all storage drives work properly. Replace the failed storage drives with good ones.
4. System cooling: Check the system cooling to make sure that all heatsink fans and processor/system fans, etc., work properly. Check the hardware monitoring settings in the IPMI to make sure that the processor and system temperatures are within the normal range. Also, check the front panel Overheat LED and make sure that it is not on.
5. Adequate power supply: Make sure that the power supply provides adequate power to the system. Make sure that all power connectors are connected. Refer to our website for more information on the minimum power requirements.
6. Proper software support: Make sure that the correct drivers are used.

If the system becomes unstable before or during OS installation, check the following:

1. Source of installation: Make sure that the devices used for installation are working properly, including boot devices such as a USB flash or media device.
2. Cable connection: Check to make sure that all cables are connected and working properly.
3. Use the minimum configuration for troubleshooting: Remove all unnecessary components (starting with add-on cards first), and use the minimum configuration (but with the processor and a memory module installed) to identify the trouble areas. Refer to the steps listed above in this section for proper troubleshooting procedures.
4. Identify bad components by isolating them: If necessary, remove a component in question from the chassis, and test it in isolation to make sure that it works properly. Replace a bad component with a good one.
5. Check and change one component at a time instead of changing several items at the same time. This will help isolate and identify the problem.
6. To find out if a component is good, swap this component with a new one to see if the system will work properly. If so, then the old component is bad. You can also install the component in question in another system. If the new system works, the component is good and the old system has problems.

3.2 Technical Support Procedures

Before contacting Technical Support, take the following steps. Also, note that as a motherboard manufacturer, Supermicro also sells motherboards through its channels, so it is best to first check with your distributor or reseller for troubleshooting services. They should know of any possible problems with the specific system configuration that was sold to you.

1. Refer to "Troubleshooting Procedures" on page 45 or see the FAQs on our website (<https://www.supermicro.com/FAQ/index.php>) before contacting Technical Support.
2. BIOS upgrades can be downloaded from our website (https://www.supermicro.com/support/resources/bios_ipmi.php).
3. If you still cannot resolve the problem, include the following information when contacting Supermicro for technical support:
 - Motherboard model and PCB revision number
 - BIOS release date/version (This can be seen on the initial display when your system first boots up.)
 - System configuration
4. An example of a Technical Support form is on our website at <https://webpr3.supermicro.com/SupportPortal>.
5. Distributors: For immediate assistance, have your account number ready when placing a call to our Technical Support department. For Supermicro contact information, refer to "Contacting Supermicro" on page 9.

3.3 Motherboard Battery

For information on removing, disposing of, and replacing the motherboard battery of your system, refer to ["Battery Removal and Installation" on page 36](#).

3.4 Where to Get Replacement Components

If you need replacement parts for your X14DBG-LC2 motherboard, to ensure the highest level of professional service and technical support, purchase exclusively from our Supermicro Authorized Distributors/System Integrators/Resellers. A list can be found on the Supermicro website:

<https://www.supermicro.com>

Under the "Buy" menu, click the "Where to Buy" link.

3.5 Returning Merchandise for Service

A receipt or copy of your invoice marked with the date of purchase is required before any warranty service will be rendered. You can obtain service by calling your vendor for a Returned Merchandise Authorization (RMA) number. When returning the motherboard to the manufacturer, the RMA number should be prominently displayed on the outside of the shipping carton, and the shipping package is mailed prepaid or hand-carried. Shipping and handling charges will be applied for all orders that must be mailed when service is complete.

For faster service, RMA authorizations can be requested online at the following page:

<https://www.supermicro.com/RmaForm>

Whenever possible, repack the motherboard in the original Supermicro carton, using the original packaging material. If these are no longer available, be sure to pack the motherboard securely, using packaging material to surround the motherboard so that it does not shift within the carton and become damaged during shipping.

This warranty only covers normal consumer use and does not cover damages incurred in shipping or from failure due to the alternation, misuse, abuse or improper maintenance of products.

During the warranty period, contact your distributor first for any product problems.

3.6 Feedback

Supermicro values your feedback as we strive to improve our customer experience in all facets of our business. Email us at Techwriterteam@supermicro.com to provide feedback on our manuals.

Chapter 4:

UEFI BIOS

The following content contains information on BIOS configuration with the X14DBG-LC2 motherboard.

4.1 Introduction	54
4.2 Main Setup	56
4.3 Advanced Setup Configurations	58
4.4 Event Logs	95
4.5 BMC	97
4.6 Security	101
4.7 Boot	107
4.8 Save & Exit	109

4.1 Introduction

This chapter describes the AMIBIOS™ Setup utility for the motherboard. The BIOS is stored on a chip and can be easily upgraded using the UEFI script (flash.nsh), the BMC WebUI, or the SuperServer Automation Assistant (SAA) utility.

Note: Due to periodic changes to the BIOS, some settings may have been added or deleted and might not yet be recorded in this manual. Refer to the Manual Download area of our website for any changes to BIOS that may not be reflected in this manual.

Updating BIOS

It is recommended that you do not upgrade your BIOS if you are not experiencing any problems with your system. Updated BIOS files are located on our website at the following page:

https://www.supermicro.com/support/resources/bios_ipmi.php

Check our BIOS warning message and the information on how to update your BIOS on our website. Select your motherboard model and download the BIOS file to your computer. Also, check the current BIOS revision to make sure that it is newer than your BIOS before downloading.

Important: Do not shut down or reset the system while updating the BIOS to prevent possible system boot failure! Read the motherboard README file carefully before you perform the BIOS update.

To update the BIOS under the UEFI Shell, unzip the BIOS file onto a bootable USB device and then boot into the built-in UEFI Shell. For motherboards with BMC support, type "flash.nsh <BIOS filename><BMC Username><BMC Password>" to start the BIOS update. The flash.nsh script will invoke the SAA (EFI) tool automatically to perform the BIOS update, beginning with uploading the BIOS image to BMC. After uploading the BIOS image, the system will reboot to continue the process. The BMC will take over and continue the BIOS update in the background. The process will take 3–5 minutes. Refer to the README file for more information.

Starting the Setup Utility

To enter the BIOS Setup utility, press the <Delete> key while the system is booting-up. In most cases, the <Delete> key is used to invoke the BIOS Setup screen. There are a few cases when other hot keys are used, such as <F1>, <F2>, etc. Each main BIOS menu option is described in this manual.

The Main BIOS screen has two main frames. The left frame displays all the options that can be configured. "Grayed-out" options cannot be configured. The right frame displays the key legend. Above the key legend is an area reserved for a text message. When a BIOS submenu or item is selected in the left frame, it is highlighted in white. Often a text message will accompany it. (Note that BIOS has default text messages built in. We retain the option to include, omit, or change any of these text messages.) Settings printed in **Bold** are the default values.

A "▶" indicates a submenu. Highlighting such an item and pressing the <Enter> key open the list of settings within that submenu.

The BIOS Setup utility uses a key-based navigation system called hot keys. Most of these hot keys (<F1>, <F2>, <F3>, <F4>, <F5>, <F6>, <Enter>, <ESC>, the arrow keys, etc.) can be used at any time during the setup navigation process.

4.2 Main Setup

The Main setup screen appears when the AMI BIOS Setup utility is first entered. To return to the Main setup screen, select the Main tab at the top of the screen. The Main BIOS setup screen is shown below.

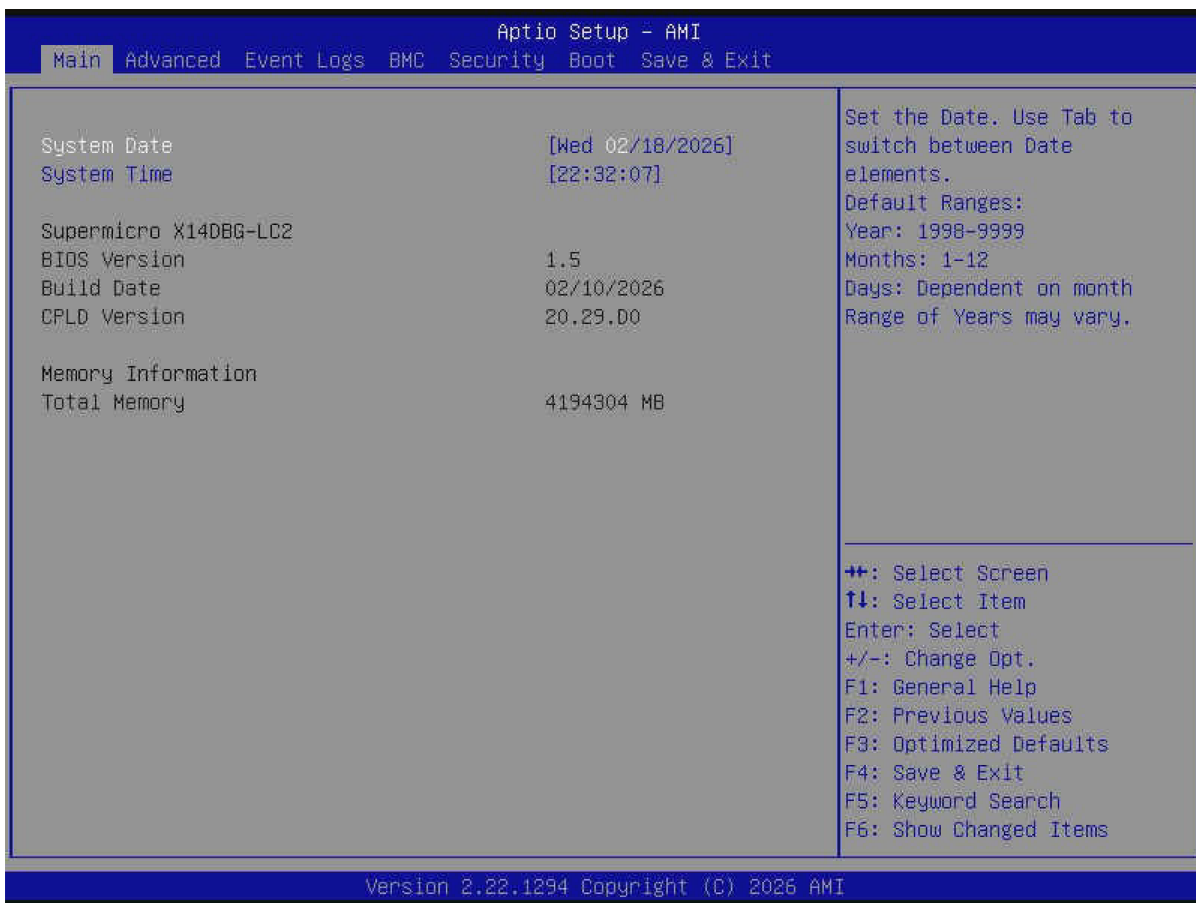

Figure 4-1. Main Setup Page

System Date/System Time

Use the two features to change the system date and time. Highlight **System Date** or **System Time** using the arrow keys. Enter new values using the keyboard. Press the <Tab> key or the arrow keys to move between fields. The date must be entered in MM/DD/YYYY format. The time is entered in HH:MM:SS format.

Note: The time is in the 24-hour format. For example, 5:30 P.M. appears as 17:30:00.

Supermicro X14DBG-LC2

BIOS Version

This feature displays the version of the BIOS ROM used in the system.

Build Date

This feature displays the date when the version of the BIOS ROM used in the system was built.

CPLD Version

This feature displays the version of the Complex-Programmable Logical Device (CPLD) used in the system.

Memory Information**Total Memory**

This feature displays the total size of memory available in the system.

4.3 Advanced Setup Configurations

Use the arrow keys to select the Advanced submenu and press <Enter> to access the submenu items.

Important: Use caution when changing the Advanced settings. An incorrect value, an improper DRAM frequency, or a wrong BIOS timing setting may cause the system to malfunction. When this occurs, revert the settings to the default manufacturing settings.

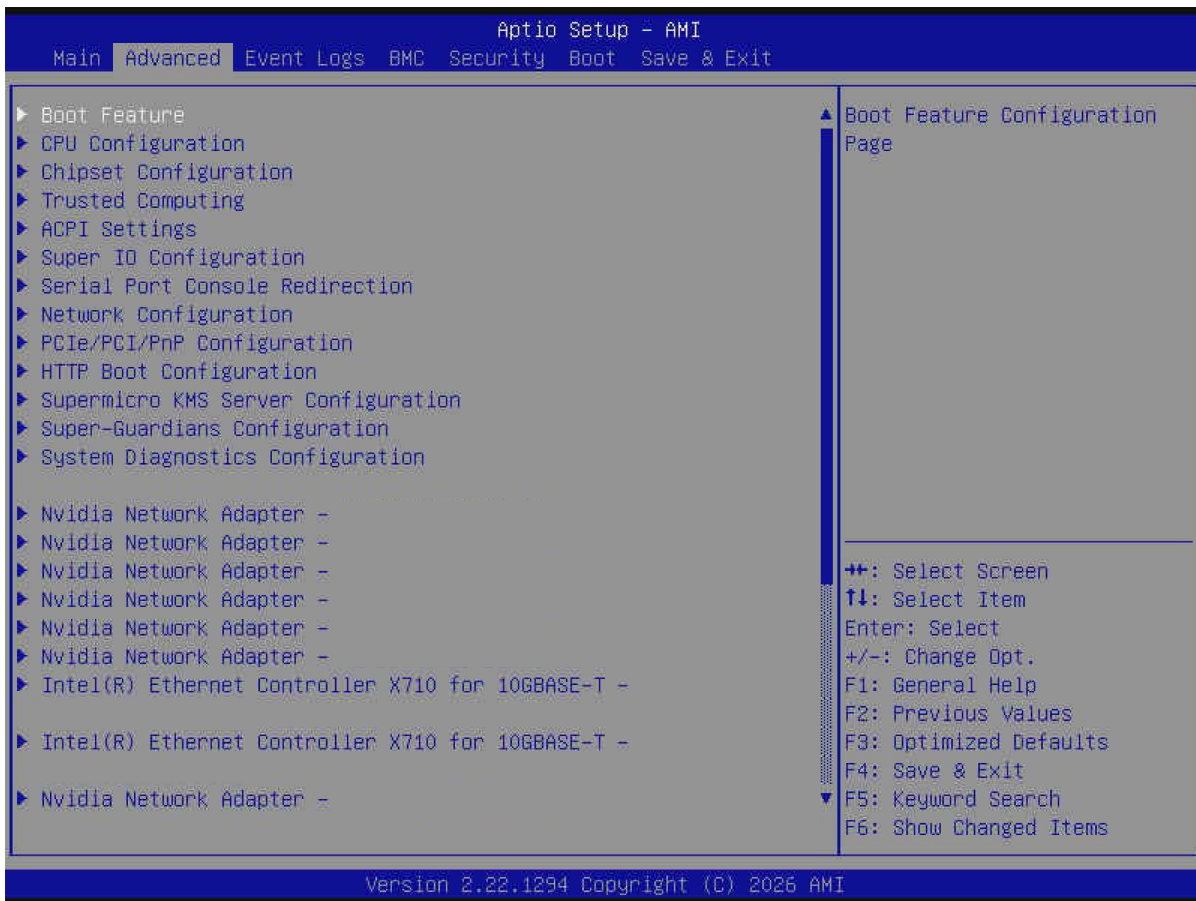

Figure 4-2. Advanced Setup Page

Boot Feature Menu

► Boot Feature

Quiet Boot

Use this feature to select the screen between displaying the Power On Self Test (POST) messages or the OEM logo upon bootup. Select Disabled to display the POST messages. Select Enabled to display the OEM logo instead of the normal POST messages. The options

are Disabled and **Enabled**.

Note: BIOS POST messages are always displayed regardless of the setting of this feature.

Bootup NumLock State

Use this feature to set the power on state for the <Num Lock> key. The options are **On** and Off.

Wait For "F1" If Error

Select Enabled to force the system to wait until the <F1> key is pressed if an error occurs. The options are **Disabled** and Enabled.

Re-try Boot

If this feature is set to Enabled, the system BIOS will automatically reboot the system from an Extensible Firmware Interface (EFI) boot device after an initial boot failure. The options are **Disabled** and Enabled.

Runtime Variable Lock

Enable this feature to manage access to non-volatile memory (NVRAM) variables and use specific runtime services with write protection. The options are **Disabled** and Enabled.

Power Configuration

Watch Dog Function

Select Enabled to allow the Watchdog timer to reboot the system when it is inactive for more than five minutes. The options are **Disabled** and Enabled.

Watch Dog Action (Available when "Watch Dog Function" is set to Enabled)

Use this feature to configure the Watchdog timeout setting. The options are **Reset** and NMI.

Restore on AC Power Loss

Use this feature to set the power state after a power outage. Select Stay Off for the system power to remain off after a power loss. Select Power On for the system power to be turned on after a power loss. Select Last State to allow the system to resume its last power state before a power loss. The options are Stay Off, Power On, and **Last State**.

Power Button Function

This feature controls how the system shuts down when the power button is pressed. Select 4 Seconds Override to power off the system after pressing and holding the power button for four seconds or longer. Select Instant Off to instantly power off the system as soon as you press the power button. The options are **Instant Off** and 4 Seconds Override.

CPU Configuration Menu

► CPU Configuration

Important: Setting the wrong values for the features included in the following sections may cause the system to malfunction.

The following processor information is displayed:

- Processor BSP Revision
- Processor Socket
- Processor ID
- Processor Frequency
- Processor Max Ratio
- Processor Min Ratio
- Microcode Revision
- L1 Cache RAM (Per Core)
- L2 Cache RAM (Per Core)
- L3 Cache RAM (Per Package)
- Processor 0 Version

Hyper-Threading [ALL]

Select Enabled to use Intel Hyper-Threading Technology to enhance CPU performance. The options are Disabled and **Enabled**. This feature is CPU-dependent.

Hardware Prefetcher

If this feature is set to Enabled, the hardware prefetcher will prefetch data from the main system memory to Level 2 cache to help expedite the data transaction to enhance memory performance. The options are **Enabled** and Disabled.

Note: This feature is NOT available when "Workload Profile" is set to HPC, I/O, or Virtualization.

Adjacent Cache Prefetch

Select Enabled for the CPU to prefetch both cache lines for 128 bytes as comprised. Select Disabled for the CPU to prefetch both cache lines for 64 bytes. The options are **Enabled** and Disabled.

Note: This feature is NOT available when "Workload Profile" is set to HPC, I/O, or Virtualization.

DCU Streamer Prefetcher

If this feature is set to Enabled, the Data Cache Unit (DCU) streamer prefetcher will prefetch data streams from the cache memory to the DCU to speed up data accessing and processing to enhance CPU performance. The options are Enabled, Disabled, and **Auto**.

Note: This feature is NOT available when "Workload Profile" is set to HPC, I/O, or Virtualization.

DCU IP Prefetcher

This feature allows the system to use the sequential load history, which is based on the instruction pointer of previous loads, to determine whether the system will prefetch additional lines. The options are **Enabled** and Disabled.

Note: This feature is NOT available when "Workload Profile" is set to HPC, I/O, or Virtualization.

LLC Prefetch

If this feature is set to Enabled, LLC (hardware cache) prefetching on all threads will be supported. The options are **Disabled** and Enabled. This feature is CPU-dependent.

Note: This feature is NOT available when "Workload Profile" is set to HPC, I/O, or Virtualization.

Homeless Prefetch

Select Enabled for Homeless Prefetch support on all threads, which is an Effective Prefetch Strategy (EPS) used to enhance memory performance by reducing communication overhead, network latency, and the wait time needed for barrier synchronization in memory prefetching commonly associated with the home-based software Distributed Shared Memory (DSM) system. The options are Disabled, Enabled, and **Auto**. Please note that the option of Auto is program-specific. This feature is CPU-dependent.

AMP Prefetch

Select Enabled to use a machine learning algorithm to predict the best L2 prefetcher configuration for the currently running workload. This feature can improve the performance of various general-purpose workloads. The options are Disabled and **Enabled**. This feature is CPU-dependent.

APIC Physical Mode

Use this feature to enable the APIC physical destination mode. The options are **Disabled** and Enabled. (APIC is the abbreviation for Extended Advanced Programmable Interrupt Controller.)

IIO LLC Ways Mask (Hex)

This feature sets a specific temporary register bit mask that is used to control or monitor Last Level Cache (LLC) cache configuration and allocation. The default setting is **0**. (IIO is the abbreviation for Intel I/O.)

TXT Support

Select Enabled to enable Intel Trusted Execution Technology (TXT) support to enhance system integrity and data security. The options are **Disabled** and Enabled. This feature is CPU-dependent.

Note: If this feature is set to Enabled, be sure to disable Device Function On-Hide (EV DFX) support when it is present in the BIOS for the system to work properly.

Intel Virtualization Technology

Select Enabled to enable the Intel Vanderpool Technology for Virtualization platform support, which allows multiple operating systems to run simultaneously on the same computer to maximize system resources for performance enhancement. The options are Disabled and **Enabled**. Changes take effect after you save settings and reboot the system.

Notes:

- This feature is NOT available when "TXT Support" is set to Enabled.
- This feature is NOT available when "Workload Profile" is set to Virtualization.

Enable SMX

Select Enabled to support Safer Mode Extensions (SMX), which provides a programming interface for system software to establish a controlled environment to support the trusted platform configured by the end user and to verify a virtual machine monitor before it is allowed to run. The options are **Disabled** and Enabled.

Note: This feature is available when "TXT Support" is set to Disabled.

PPIN Control

Select Unlock/Enabled to use the Protected Processor Inventory Number (PPIN) in the system. The PPIN is a unique number set for tracking a given Intel Xeon server processor. The options are Lock/Disabled and **Unlock/Enabled**.

AES-NI

Select Enabled to use the Intel Advanced Encryption Standard (AES) New Instructions (NI) to ensure data security. The options are Disabled and **Enabled**.

Chipset Configuration Menu

► Chipset Configuration

Important: Setting the wrong values in this section may cause the system to malfunction.

Uncore Configuration Menu

► Uncore Configuration

The following information is displayed.

- Number of CPU
- Current UPI Link Speed
- Current UPI Link Frequency
- Global MMIO Low Base / Limit
- Global MMIO High Base / Limit
- PCIe Configuration Base / Size

Degrade Precedence

Use this feature to select the degrading precedence option for Ultra Path Interconnect (UPI) connections. Select Topology Precedence to degrade UPI features if system options are in conflict. Select Feature Precedence to degrade UPI topology if system options are in conflict. The options are **Topology Precedence** and Feature Precedence.

Link L0p Enable

Select Enabled for the system BIOS to enable Link L0p support, which allows the CPU to reduce the UPI links from full width to half width in the event when the CPU's workload is low in an attempt to save power. This feature is available for the system that uses Intel processors with UPI technology support. The options are **Disabled**, Enabled, and Auto.

Note: You can change the performance settings for non-standard applications by using this parameter. It is recommended that the default settings be used for standard applications.

Link L1 Enable

Select Enabled for the BIOS to activate Link L1 support, which will power down the UPI links to save power when the system is idle. This feature is available for the system that uses Intel processors with UPI technology support. The options are **Disabled**, Enabled, and Auto.

Note: Link L1 is an excellent feature for an idle system. L1 is used during Package C-States when its latency is hidden by other components during a wakeup.

KTI Prefetch

Keizer Technology Interconnect (KTI) is also known as the Intel Ultra Path Interconnect (UPI) technology. Select Enabled for the KTI prefetcher to preload the L1 cache with data deemed relevant, which allows the memory read to start earlier on a DDR bus in an effort to reduce latency. Select Auto for the KTI prefetcher to automatically preload the L1 cache with relevant data whenever it is needed. The options are Disabled, Enabled, and **Auto**.

IO Directory Cache (IODC)

This feature allows the IODC to generate snoops instead of generating memory lockups for remote IIO (InvltoM) and/or WCiLF (Cores). Select Auto for the IODC to generate snoops (instead of memory lockups) for WCiLF (Cores). The options are Disabled, **Auto**, Enable for Remote InvltoM Hybrid Push, Enable for Remote InvltoM AllocFlow, Enable for Remote InvltoM Hybrid AllocNonAlloc, and Enable for Remote InvltoM and Remote WCiLF.

SNC

Sub NUMA Clustering (SNC) is a feature that breaks up the LLC into clusters based on address range. Each cluster is connected to a subset of the memory controller. Enable this feature to improve average latency and reduce memory access congestion for higher performance. The options are Disabled, Enabled, and **Auto**. This feature is CPU-dependent.

Note: This feature is NOT available when "Workload Profile" is set to I/O, Virtualization, or Telco FlexRAN.

XPT Prefetch

XPT Prefetch is a feature that speculatively makes a copy to the memory controller of a read request being sent to the LLC. If the read request maps to the local memory address and the recent memory reads are likely to miss the LLC, a speculative read is sent to the local memory controller. The options are Disabled, Enabled, and **Auto**.

Stale AtoS

The in-memory directory has three states: I, A, and S states. The I (-invalid) state indicates that the data is clean and does not exist in the cache of any other sockets. The A (-snoop All) state indicates that the data may exist in another socket in an exclusive or modified state. The S state

(-Shared) indicates that the data is clean and may be shared in the caches across one or more sockets. When the system is performing "read" on the memory and if the directory line is in A state, we must snoop all other sockets because another socket may have the line in a modified state. If this is the case, a "snoop" will return the modified data. However, it may be the case that a line "reads" in an A state, and all the snoops come back with a "miss." This can happen if another socket reads the line earlier and then has silently dropped it from its cache without modifying it. If "Stale AtoS" is enabled, a line will transition to the S state when the line in the A state returns only snoop misses. That way, subsequent reads to the line will encounter it in the S state and will not have to snoop, saving the latency and snoop bandwidth. Stale "AtoS" may be beneficial in a workload where there are many cross-socket reads. The options are Disabled, Enabled, and **Auto**.

LLC Dead Line Alloc

Select Enabled to optimally fill the dead lines in the LLC. The options are Disabled, **Enabled**, and Auto.

Memory Configuration Menu

► Memory Configuration

This submenu is used to configure the Integrated Memory Controller (IMC) settings.

Enforce DDR Memory Frequency POR

Select Enforce POR to enforce Plan of Record (POR) restrictions for DDR memory frequency and voltage programming. The options are **Enforce POR**, Enforce Stretch Goals, and Disabled.

Host Memory Frequency

Use this feature to set the maximum memory frequency for onboard memory modules. The options are **Auto**, 4800, 5200, 5600, 6000, 6400, and 7200. Note that the available options are CPU-dependent.

Global Scrambling

Select Enabled to enable data scrambling to enhance system performance and data integrity. The options are Disabled and **Enabled**.

Memory Topology Menu

► Memory Topology

This submenu displays the information of onboard memory modules as detected by the BIOS, for example:

P1-DIMMA1: 5600MT/s Hynix SRx8 16GB RDIMM

Memory Map Menu

▶ **Memory Map**

Intel(R) Flat Memory Mode Support

Enable this feature to allow hardware-managed data movement between DDR5 and CXL memory, making total memory capacity visible to your system. The options are **Disabled** and Enabled.

DDR CXL Heterogeneous Interleave Support

Select Enabled to support heterogeneous interleaving for physical DDR5 and CXL memory. The options are **Disabled** and Enabled.

Memory RAS Configuration Menu

▶ **Memory RAS Configuration**

Use this submenu to configure the memory mirroring, Reliability Availability Serviceability (RAS) settings.

Mirror Mode

Use this feature to configure the mirror mode settings for all 1LM/2LM memory modules in the system to create a duplicate copy of data stored in the memory to increase memory security. It will reduce the memory capacity into half. The options are **Disabled** and Full Mirror Mode.

Note: This feature is available when "UEFI ARM Mirror" is set to Disabled.

UEFI ARM Mirror

If this feature is set to Enabled, mirror mode configuration settings for UEFI-based Address Range memory will be enabled upon system boot. This will create a duplicate copy of data stored in the memory to increase memory security, but it will reduce the memory capacity into half. The options are **Disabled** and Enabled. The Address Range Mirroring (ARM) feature supports partial memory mirroring. This feature is CPU-dependent.

Note: This feature is available when "Mirror Mode" is set to Disabled.

Mirror TAD0

Use this feature to enable the mirror mode on the entire memory for Target Address Decoder 0 (TAD0). The options are **Disabled** and Enabled. This feature is CPU-dependent.

Note: This feature is available when "Mirror Mode" is set to Disabled.

ARM Mirror Percentage (Available when "UEFI ARM Mirror" is set to Enabled)

Use this feature to set the percentage of memory space to be used for UEFI ARM mirroring for memory security enhancement. The default setting is **2500**.

Correctable Error Threshold

Use this feature to specify the threshold value for correctable memory-error logging, which sets a limit on the maximum number of events that can be logged in the memory error log at a given time. The default setting is **512**.

Note: This feature is available when "Memory PFA Support" is set to Disabled.

Leaky Bucket Low Bit

Use this feature to set the Low Bit value for the Leaky Bucket algorithm, which is used to check the data transmissions between CPU sockets and the memory controller. The default setting is **12**.

Leaky Bucket High Bit

Use this feature to set the High Bit value for the Leaky Bucket algorithm, which is used to check the data transmissions between CPU sockets and the memory controller. The default setting is **13**.

ADDDC Sparing (Available when populating 1Rx4, 2Rx4, and 4Rx4 DIMMs and when "Memory PFA Support" is set to Disabled)

Select Enabled for Adaptive Double Device Data Correction (ADDDC) support, which will not only provide memory error checking and correction but will also prevent the system from issuing a performance penalty before a device fails. Note that virtual lockstep mode will only start to work for ADDDC after a faulty DRAM module is spared. The options are Disabled and **Enabled**.

DDR PPR Type

Post Package Repair (PPR) is a new feature available for the DDR4/DDR5 technology. PPR provides additional spare capacity within a DDR4/DDR5 DRAM module that is used to replace faulty cell areas detected during system boot. PPR offers two types of memory repairs. Soft Post Package Repair (sPPR) provides a quick, temporary fix on a raw element in a bank group of a DDR4/DDR5 DRAM device, while hard Post Package Repair (hPPR) will take a longer time to provide a permanent repair on a raw element. The options are PPR Disabled, **Hard PPR**, and Soft PPR.

Note: This feature is available when "Memory PFA Support" is set to Disabled.

Enhanced PPR

Use this feature to set advanced memory test. Select Enabled to always execute for every boot. The options are **Disabled**, Enabled, and Persistent.

Memory PFA Support (Available when the DCMS key is activated)

Select Enabled to enable memory Predictive Failure Analysis (PFA) support. PFA can be used to avoid uncorrectable faults on the same memory page. The options are **Disabled** and Enabled.

Security Configuration Menu**► Security Configuration**

Memory Encryption (TME) [Outputs]

The following information is displayed.

- MSE activation state
- MK-TME activation state
- CI activation state
- Cryptographic Algorithm configured

Memory Encryption (TME) [Inputs]

Memory Encryption (TME)

Select Enabled for Intel Total Memory Encryption (TME) support to enhance memory data security. The options are **Disabled** and Enabled.

Total Memory Encryption Multi-Tenant (TME-MT)

Use this feature to support tenant-provided (SW-provided) keys. The options are **Disabled** and Enabled.

Memory Integrity

Use this feature to enable TME-MT memory integrity protection for memory transactions. The options are **Disabled** and Enabled.

The following information is displayed.

- KEY stock amount
- TME-MT key ID bits

TME Encryption Algorithm

Use this feature to set the TME encryption algorithm. The options are AES-XTS-128 and **AES-XTS-256**.

Trust Domain Extensions (TDX) [Outputs]

The following information is displayed.

- TDX activation state

Trust Domain Extensions (TDX) [Inputs]

Trust Domain Extensions (TDX) (Available when your motherboard supports Intel TDX)

Use this feature to enable Intel Trust Domain Extensions (TDX) technology support to enhance control of data security. The options are **Disabled** and Enabled.

Note: To support TDX features, DIMM population must be symmetric across integrated Memory Controllers (IMCs) and at least DIMMs per socket. For each memory controller, populating the first slots (Px-DIMMX1 or DIMMX1 depending on the motherboard design) in all channels is required. Refer to memory population below for your motherboard.

Trust Domain Extensions - Connect (TDX Connect) (Available when "Trust Domain Extensions (TDX)" is set to Enabled)

Use this feature to enable Intel TDX Connect support to improve I/O virtualization by removing the need to establish a secure TD-Device transport-level session. The options are **Disabled** and Enabled. This feature is CPU-dependent.

TDX Secure Arbitration Mode Loader (SEAM Loader) (Available when your motherboard supports Intel TDX and when "Trust Domain Extensions (TDX)" is set to Enabled)

The SEAM Loader (SEAMLDR) is used to load and update Intel TDX modules into the SEAM memory range by verifying the digital signature. The options are **Disabled** and Enabled.

TME-MT/TDX Key Split (Available when "Trust Domain Extensions (TDX)" is set to Enabled)

Use this feature to set the number of bits for TDX. The other bits will be used by TME-MT. The default setting is **1**.

The following information is displayed when "Trust Domain Extensions (TDX)" is set to Enabled.

- TME-MT Keys:
- TDX Keys:

Processor Reserved Memory [Capabilities]

The following information is displayed.

- PRMRR Min Size per domain
- PRMRR Max Size per domain

Processor Reserved Memory [Outputs]

The following information is displayed.

- PRMRR Size per domain
- PRM Size per socket
- PRM Size per system

Software Guard Extensions (SGX) [Outputs]

The following information is displayed when your motherboard supports SGX.

- SGX activation state
- SGX error code [HEX]

Software Guard Extensions (SGX) [Inputs]

The following features are available when your motherboard supports SGX.

Note: To support SGX features, DIMM population must be symmetric across Integrated Memory Controllers (IMCs) and at least DIMMs per socket. For each memory controller, populating the first slots (Px-DIMMX1 or DIMMX1 depending on the motherboard design) in all channels is required. Refer to memory population below for your motherboard.

SGX Factory Reset

Use this feature to perform an SGX factory reset to delete all registration data and force an Initial Platform Establishment flow. Reboot the system for the changes to take effect. The options are **Disabled** and Enabled.

SW Guard Extensions (SGX)

Use this feature to enable Intel Software Guard Extensions (SGX) support. Intel SGX is a set of extensions that increases the security of application code and data by using enclaves in memory to protect sensitive information. The options are **Disabled** and Enabled.

SGX Package Info In-Band Access

Setting this feature to Enabled is required before the BIOS provides software with the key blobs, which are generated for each CPU package. The options are **Disabled** and Enabled.

SGX PRMRR Size Requested (Available when "SW Guard Extensions (SGX)" is set to Enabled)

Use this feature to set the Processor Reserved Memory Range Register (PRMRR) size. The options are **Auto**, 128M, 256M, 512M, 1G, 2G, 4G, 8G, 16G, 32G, 64G, 128G, 256G, and 512G. Note that the available options are based on your motherboard features, memory size, and memory map.

SGX QoS (Available when "SW Guard Extensions (SGX)" is set to Enabled)

Use this feature to enable Intel SGX Quality of Service (QoS) support. QoS can enhance network performance by prioritizing network traffic. The options are Disabled and **Enabled**.

Select Owner EPOCH Input Type (Available when "SW Guard Extensions (SGX)" is set to Enabled)

Owner EPOCH is used as a parameter to add personal entropy into the key derivation process. A correct Owner EPOCH is required to have access to personal data previously sealed by other platform users. There are two Owner EPOCH modes. One is New Random Owner EPOCH, and the other is manually entered by the user. Each EPOCH is 64-bit. The options are **SGX Owner EPOCH deactivated**, Change to New Random Owner EPOCHs, and Manual User Defined Owner EPOCHs.

Note: Changing the Owner EPOCH value will lose the data in enclaves.

Software Guard Extensions Epoch 0

Use this feature to enter the EPOCH value. The default setting is **0**.

Note: This feature is available when "SW Guard Extensions (SGX)" is set to Enabled. This feature is NOT available when "Select Owner EPOCH Input Type" is set to SGX Owner EPOCH deactivated.

Software Guard Extensions Epoch 1

Use this feature to enter the EPOCH value. The default setting is **0**.

Note: This feature is available when "SW Guard Extensions (SGX)" is set to Enabled. This feature is NOT available when "Select Owner EPOCH Input Type" is set to SGX Owner EPOCH deactivated.

SGXLEPUBKEYHASHx Write Enable (Available when "SW Guard Extensions (SGX)" is set to Enabled)

Use this feature to enable writes to SGXLEPUBKEYHASH[3..0] from OS/SW. The options are Disabled and **Enabled**. Only those CPUs that support the Intel SGX Flexible Launch Control (FLC) feature have SGXLEPUBKEYHASH, which contains the hash of the public key for the SGX Launch Enclave (LE) to be signed with.

SGXLEPUBKEYHASH0 (Available when both "SW Guard Extensions (SGX)" and "SGXLEPUBKEYHASHx Write Enable" are set to Enabled)

Use this feature to enter the bytes 0–7 of SGX Launch Enclave Public Key Hash.

SGXLEPUBKEYHASH1 (Available when both "SW Guard Extensions (SGX)" and "SGXLEPUBKEYHASHx Write Enable" are set to Enabled)

Use this feature to enter the bytes 8–15 of SGX Launch Enclave Public Key Hash.

SGXLEPUBKEYHASH2 (Available when both "SW Guard Extensions (SGX)" and "SGXLEPUBKEYHASHx Write Enable" are set to Enabled)

Use this feature to enter the bytes 16–23 of SGX Launch Enclave Public Key Hash.

SGXLEPUBKEYHASH3 (Available when both "SW Guard Extensions (SGX)" and "SGXLEPUBKEYHASHx Write Enable" are set to Enabled)

Use this feature to enter the bytes 24–31 of SGX Launch Enclave Public Key Hash.

SGX Auto MP Registration (Available when "SW Guard Extensions (SGX)" is set to Enabled)

Use this feature to enable/disable SGX Auto Multi-Package Registration Agent (MPA) running automatically at boot time. The options are **Disabled** and Enabled.

In Field Scan (IFS) Menu

► In Field Scan (IFS)

Enable SAF

Select Enabled to enable the Intel SAF feature, which tests the CPU core logic for faults by using scan test images. The options are **Disabled** and Enabled.

I/O Configuration Menu

► I/O Configuration

PCIe Completion Timeout

Use this feature to set the PCIe completion timeout. The options are 50us to 50ms, 50us to 100us, 1ms to 10ms, 16ms to 55ms, 65ms to 210ms, **260ms to 900ms**, 1s to 3.5s, and Disabled.

PCIe ASPM Support (Global)

Use this feature to disable the Active State Power Management (ASPM) support for all PCIe root ports. The options are **Disabled** and Auto.

PRM Feature Control

Use this feature to enable the Platform Runtime Mechanism (PRM). The PRM is a mechanism to reduce the System Management Mode (SMM) usages and to provide an alternate means to invoke native code through the Advanced Configuration and Power Interface (ACPI) context of runtime events. The options are **Disabled** and Enabled.

Equalization Bypass To Highest Rate

Set this feature to Enabled to reduce the link training time for PCIe 5.0 device by skipping equalization of intermediate data rates. The options are Disabled and **Enabled**.

NVMe Mode Switch

When this feature is set to Auto, VMD support will be automatically enabled when a VROC key is detected by the BIOS. The options are Manual, VMD, and **Auto**. This feature is available for configuration when the system supports a VROC key.

PCIe PLL SSC

Select Enabled for PCIe Spread Spectrum Clocking (SSC) support, which allows the BIOS to monitor and attempt to reduce the level of electromagnetic interference caused by the components whenever needed. The options are **Disabled** and Enabled. The available options are CPU-dependent.

Snoop Response Hold Off for PCIe Stack

Use this feature to set the IIO snoop response hold-off value to improve throughput and reduce latency. The default setting is **9**. The valid range is 0 to F. Set this feature to 0 to disable the hold-off time.

CXL Security Level

By defining security protocols, CXL standards provide protection against the data security threats. Use this feature to set the CXL security level for data transiting the CXL link. The options are Fully Trusted, Partially Trusted, Untrusted, and **Auto**.

- Fully Trusted: This option allows the CXL device to access CXL.\$ for both host-attached and device-attached memory ranges in the write-back (WB) address space.
- Partially Trusted: This option allows the CXL device to access CXL.\$ for device-attached memory ranges only.
- Untrusted: If this option is selected, the host (your system) will abort all requests on CXL.\$.
- Auto: This option is based on Si Compatibility.

CXL Header Bypass

Use this feature to enable the CXL header bypass. The options are **Disabled** and Enabled.

CPU1 Configuration Menu

► CPU1 Configuration

► PCI Express 0 / PCI Express 1 / PCI Express 2 / PCI Express 3 / PCI Express 4 / PCI Express 5

Note: The number of PCIe slots and the slot naming can differ depending on the PCIe devices connected to your motherboard.

Intel VMD Technology

When this feature is set to Enabled, VMD support will be automatically enabled when a VROC key is detected by the BIOS. The options are **Disabled** and Enabled. This feature is available for configuration when the system supports a VROC key.

Notes:

- This feature is available when "NVMe Mode Switch" is set to Manual.
- After you've enabled VMD in the BIOS on a PCIe slot, this PCIe slot will be dedicated for VMD use only, and it will no longer support any PCIe device. To re-activate this slot for PCIe use, disable VMD in the BIOS.

Bifurcation

This feature is CPU-dependent. Use this feature to configure the PCIe Bifurcation setting for the PCIe port you specified. The options are **Auto**, x4x4x4x4, x4x4x8, x8x4x4, x8x8, and x16.

► PCI Express 5 Port A/Port C/Port E/Port G

Note: The number of PCIe slots and the slot naming can differ depending on the PCIe devices connected to your motherboard.

Requested Link Speed

Use this feature to configure the link speed of the PCIe port you specified. The options are **Auto**, Gen 1 (2.5 GT/s), Gen 2 (5 GT/s), Gen 3 (8 GT/s), Gen 4 (16 GT/s), and Gen 5 (32 GT/s).

The following information is displayed.

- Max Link Width
- Current Link Width
- Current Link Speed

Data Link Feature Exchange

Use this feature to enable data link feature negotiation in the Data Link Feature Capabilities (DLFCAP) register. The options are Disabled and **Enabled**.

PCIe Port Max Payload Size

Use this feature to configure the maximum payload size supported in PCIe device capabilities register for the device installed in the PCIe port. The options are 128B, 256B, 512B, and **Auto**.

MCTP

Enable this feature, Management Component Transport Protocol (MCTP), to support communications between devices in a platform management subsystem. MCTP's underlying device buses include SMBus/I²C, serial links, PCIe, and USB. The options are

Disabled and **Enabled**.

Equalization Bypass To Highest Rate

Set this feature to Enabled to reduce the link training time for PCIe 5.0 device by skipping equalization of intermediate data rates. The options are Disabled and **Enabled**.

Intel VMD Technology

When this feature is set to Enabled, VMD support will be automatically enabled when a VROC key is detected by the BIOS. The options are **Disabled** and Enabled. This feature is available for configuration when the system supports a VROC key.

Intel VT for Directed I/O (VT-d) Menu

► **Intel VT for Directed I/O (VT-d)**

Note: This submenu is NOT available when "Workload Profile" is set to Virtualization.

Kernel DMA Protection

Select Enabled to notify OS to enable DMA protection after the system has booted by setting DMA_CTRL_PLATFORM_OPT_IN_FLAG in the DMAR ACPI table. The options are Enabled and **Disabled**. (DMA is the abbreviation for Direct Memory Access. DMAR is the abbreviation for DMA Remapping Reporting.)

Pre-boot DMA Protection

Select Enabled to establish DMA protection during pre-boot processing by setting DMA_CTRL_PLATFORM_OPT_IN_FLAG in the DMAR ACPI table. The options are Enabled and **Disabled**.

PCIe ACSCTL

Select Enabled to program ACS control to Chipset PCIe Root Port bridges. Select Disabled to program ACS control to all PCIe Root Port bridges. The options are Enabled and **Disabled**.

PCIe Leaky Bucket Configuration Menu

► **PCIe Leaky Bucket Configuration**

Gen2 Link Degradation

Use this feature to enable PCIe Gen2 link degradation. The options are Disabled and **Enabled**.

Note: The default setting is Enabled when your motherboard supports PCIe Gen2 link. Otherwise, the default setting is Disabled.

Gen3 Link Degradation

Use this feature to enable PCIe Gen3 link degradation. The options are Disabled and **Enabled**.

Note: The default setting is Enabled when your motherboard supports PCIe Gen3 link. Otherwise, the default setting is Disabled.

Gen4 Link Degradation

Use this feature to enable PCIe Gen4 link degradation. The options are Disabled and **Enabled**.

Note: The default setting is Enabled when your motherboard supports PCIe Gen4 link. Otherwise, the default setting is Disabled.

Gen5 Link Degradation

Use this feature to enable PCIe Gen5 link degradation. The options are Disabled and **Enabled**.

Note: The default setting is Enabled when your motherboard supports PCIe Gen5 link. Otherwise, the default setting is Disabled.

Trusted Computing Menu

► Trusted Computing

When the TPM 2.0 (either onboard or external) is detected by your system, the following information is displayed.

- TPM 2.0 Device Found
- Firmware Version:
- Vendor:

Note: This submenu is available when the TPM 2.0 (either onboard or external) is detected by the BIOS.

Security Device Support

Select Enabled to enable BIOS support for onboard security devices, which are not displayed in the OS. If this feature is set to Enabled, TCG EFI protocol and INT1A interface will not be available. The options are Disabled and **Enabled**.

When "Security Device Support" is set to Enabled and the TPM 2.0 (either onboard or external) is detected by the BIOS, the following information is displayed.

- Active PCR banks
- Available PCR banks

Note: The following features are available when the TPM 2.0 (either onboard or external) is detected by the BIOS.

SHA-1 PCR Bank (Available when "Security Device Support" is set to Enabled)

Select Enabled to enable SHA-1 PCR Bank support to enhance system integrity and data security. The options are Disabled and **Enabled**.

SHA256 PCR Bank (Available when "Security Device Support" is set to Enabled)

Select Enabled to enable SHA256 PCR Bank support to enhance system integrity and data security. The options are Disabled and **Enabled**.

SHA384 PCR Bank (Available when "Security Device Support" is set to Enabled)

Select Enabled to enable SHA384 PCR Bank support to enhance system integrity and data security. The options are **Disabled** and Enabled.

Pending Operation (Available when "Security Device Support" is set to Enabled)

Use this feature to schedule a TPM-related operation to be performed by the security TPM (either onboard or external) at the next system boot to enhance system data integrity. The options are **None** and TPM Clear.

Note: If this feature is used, your system will reboot to carry out a pending TPM operation.

Platform Hierarchy (Available when "Security Device Support" is set to Enabled)

Select Enabled for TPM Platform Hierarchy support, which allows the manufacturer to utilize the cryptographic algorithm to define a constant key or a fixed set of keys to be used for initial system boot. These early boot codes are shipped with the platform and are included in the list of "public keys." During system boot, the platform firmware uses the trusted public keys to verify a digital signature in an attempt to manage and control the security of the platform firmware used in a host system via the TPM (either onboard or external). The options are Disabled and **Enabled**.

Storage Hierarchy (Available when "Security Device Support" is set to Enabled)

Select Enabled for TPM Storage Hierarchy support that is intended to be used for non-privacy-sensitive operations by a platform owner such as an IT professional or the end user. Storage Hierarchy has an owner policy and an authorization value, both of which can be set and are held constant (-rarely changed) through reboots. This hierarchy can be cleared or changed independently of the other hierarchies. The options are Disabled and **Enabled**.

Endorsement Hierarchy (Available when "Security Device Support" is set to Enabled)

Select Enabled for Endorsement Hierarchy support, which contains separate controls to address the user's privacy concerns because the primary keys in the hierarchy are certified by the TPM key or by a manufacturer with restrictions on how an authentic TPM (either onboard or external) that is attached to an authentic platform can be accessed and used. A primary key can be encrypted and certified with a certificate created by using TPM2_ActivateCredential, which allows the user to independently enable "flag, policy, and authorization values" without involving other hierarchies. A user with privacy concerns can disable the endorsement hierarchy while still using the storage hierarchy for TPM applications, permitting the platform software to use the TPM. The options are Disabled and **Enabled**.

PH Randomization

Select Enabled for Platform Hierarchy (PH) Randomization support, which is used only during the platform developmental stage. This feature cannot be enabled in the production platforms. The options are **Disabled** and Enabled.

Supermicro BIOS-Based TPM Provision Support

Set this feature to Enabled to unlock the TPM. Save settings and exit the BIOS Setup utility. The Non-volatile (NV) indexes can be deleted after the system reboot. The options are **Disabled** and Enabled.

ACPI Settings Menu

▶ ACPI Settings

NUMA

Use this feature to enable Non-Uniform Memory Access (NUMA) support to minimize memory access latencies. The options are Disabled and **Enabled**. This feature is CPU-dependent.

Virtual NUMA

Enable this feature to optimize the memory-access performance for VMware virtual machines. The options are **Disabled** and Enabled.

Note: This feature is NOT available when "Workload Profile" is set to Telco NFVI, Telco NFVI-FP, or Telco FlexRAN.

Number of Virtual NUMA Nodes (Available when "Virtual NUMA" is set to Enabled)

This feature displays the number of virtual NUMA nodes. A NUMA architecture divides hardware resources (including processors, memory, and I/O buses) into groups, called NUMA

nodes. This feature indicates the available number of virtual NUMA nodes that can be assigned to the virtual machine. By default, this setting is automatically adjusted to match the physical NUMA topology.

WHEA Support

Select Enabled to support the Windows Hardware Error Architecture (WHEA) platform and provide a common infrastructure for the system to handle hardware errors within the Windows OS environment to reduce system crashes and to enhance system recovery and health monitoring. The options are Disabled and **Enabled**.

Super IO Configuration Menu

► Super IO Configuration

The following information is displayed.

- Super IO Chip

Note: This submenu is available when your system supports this feature.

Serial Port 1 Configuration Menu

► Serial Port 1 Configuration

Serial Port 1

Select Enabled to enable serial port 1. The options are Disabled and **Enabled**.

Device Settings (Available when "Serial Port 1" above is set to Enabled)

This feature displays the base I/O port address and the Interrupt Request address of serial port 1.

Change Settings (Available when "Serial Port 1" above is set to Enabled)

Use this feature to specify the base I/O port address and the Interrupt Request address of serial port 1. Select Auto for the BIOS to automatically assign the base I/O and IRQ address to serial port 1. The options are **Auto**, (IO=3F8h; IRQ=4;), (IO=3F8h; IRQ=3,4,5,6,7,9,10,11,12;), (IO=2F8h; IRQ=3,4,5,6,7,9,10,11,12;), (IO=3E8h; IRQ=3,4,5,6,7,9,10,11,12;), and (IO=2E8h; IRQ=3,4,5,6,7,9,10,11,12;).

Serial Port 2 Configuration Menu

► Serial Port 2 Configuration

Note: It can be "Serial Port 2 Configuration" or "SOL Configuration" based on your system support.

Serial Port 2/SOL ("Serial Port 2" or "SOL" based on your system support)

Select Enabled to enable serial port 2 (or SOL). The options are Disabled and **Enabled**.

Device Settings (Available when "Serial Port 2/SOL" above is set to Enabled)

This feature displays the base I/O port address and the Interrupt Request address of serial port 2 (or SOL).

Change Settings (Available when "Serial Port 2/SOL" above is set to Enabled)

Use this feature to specify the base I/O port address and the Interrupt Request address of serial port 2 (or SOL). Select Auto for the BIOS to automatically assign the base I/O and IRQ address to serial port 2 (or SOL).

The options are **Auto**, (IO=2F8h; IRQ=3;), (IO=3F8h; IRQ=3,4,5,6,7,9,10,11,12;), (IO=2F8h; IRQ=3,4,5,6,7,9,10,11,12;), (IO=3E8h; IRQ=3,4,5,6,7,9,10,11,12;), and (IO=2E8h; IRQ=3,4,5,6,7,9,10,11,12;).

Serial Port 2 Attribute (Available for Serial Port 2 only)

Select SOL to use serial port 2 as a Serial Over LAN (SOL) port for console redirection. The options are **SOL** and COM.

Serial Port Console Redirection Menu

► Serial Port Console Redirection

COM1 (Available when your system supports the serial port of COM1)

Console Redirection

Select Enabled to enable COM port 1 for Console Redirection, which allows a client machine to be connected to a host machine at a remote site for networking. The options are **Disabled** and Enabled.

Note: This feature will be set to Enabled if there is no BMC support.

SOL/COM2

Note: This feature is available when your system supports serial port of SOL and/or COM2. The "SOL/COM2" here indicates a shared serial port, and SOL is used as the default.

Console Redirection

Select Enabled to use the SOL/COM2 port for Console Redirection. The options are Disabled and **Enabled**.

► Console Redirection Settings

Note: This submenu is available when "Console Redirection" for COM1 or SOL/COM2 is set to Enabled.

Terminal Type

Use this feature to select the target terminal emulation type for Console Redirection. Select VT100 to use the ASCII character set. Select VT100+ to add color and function key support. Select ANSI to use the extended ASCII character set. Select VT-UTF8 to use UTF8 encoding to map Unicode characters into one or more bytes. The options are VT100, **VT100+**, VT-UTF8, and ANSI.

Bits Per Second

Use this feature to set the transmission speed for a serial port used in Console Redirection. Make sure that the same speed is used in the host computer and the client computer. A lower transmission speed may be required for long and busy lines. The options are 9600, 19200, 38400, 57600, and **115200** (bits per second).

Data Bits

Use this feature to set the data transmission size for Console Redirection. The options are 7 and **8** (bits).

Parity

A parity bit can be sent along with regular data bits to detect data transmission errors. Select Even if the parity bit is set to 0 and the number of 1s in data bits is even. Select Odd if the parity bit is set to 0 and the number of 1s in data bits is odd. Select None if you do not want to send a parity bit with your data bits in transmission. Select Mark to add a mark as a parity bit to be sent along with the data bits. Select Space to add a space as a parity bit to be sent with your data bits. The options are **None**, Even, Odd, Mark, and Space.

Stop Bits

A stop bit indicates the end of a serial data packet. Select 1 (stop bit) for standard serial data communication. Select 2 (stop bits) if slower devices are used. The options are **1** and **2**.

Flow Control

Use this feature to set the flow control for Console Redirection to prevent data loss caused by buffer overflow. Send a "Stop" signal to stop sending data when the receiving buffer is full. Send a "Start" signal to start sending data when the receiving buffer is empty. The options are **None** and Hardware RTS/CTS.

VT-UTF8 Combo Key Support

Select Enabled to enable VT-UTF8 Combination Key support for ANSI/VT100 terminals. The options are Disabled and **Enabled**.

Recorder Mode

Select Enabled to capture the data displayed on a terminal and send it as text messages to a remote server. The options are **Disabled** and Enabled.

Resolution 100x31

Select Enabled for extended-terminal resolution support. The options are Disabled and **Enabled**.

Putty KeyPad

Use this feature to select the function key and keypad settings on Putty, which is a terminal emulator designed for the Windows OS. The options are **VT100**, LINUX, XTERMR6, SCO, ESCN, and VT400.

Serial Port for Out-of-Band Management/Windows Emergency Management Services (EMS)

Use the features below to configure Console Redirection settings to support Out-of-Band Serial Port management.

Console Redirection EMS

Select Enabled to use the SOL port for Console Redirection. The options are **Disabled** and Enabled.

► Console Redirection Settings

Note: This submenu is available when "Console Redirection EMS" is set to Enabled.

Out-of-Band Mgmt Port

Use this feature to select a serial port in a client server to be used by the Microsoft Windows Emergency Management Services (EMS) to communicate with a remote host server. The options are **COM1** and SOL/COM2. Note that the option of SOL/COM2 indicates a shared serial port. SOL is available with BMC support.

Terminal Type EMS

Use this feature to select the target terminal emulation type for Console Redirection. Select VT100 to use the ASCII character set. Select VT100+ to add color and function key support. Select ANSI to use the extended ASCII character set. Select VT-UTF8 to use UTF8 encoding to map Unicode characters into one or more bytes. The options are VT100, VT100+, **VT-UTF8**, and ANSI.

Bits Per Second EMS

This feature sets the transmission speed for a serial port used in Console Redirection. Make sure that the same speed is used in the host computer and the client computer. A lower transmission speed may be required for long and busy lines. The options are 9600, 19200, 57600, and **115200** (bits per second).

Flow Control EMS

Use this feature to set the flow control for Console Redirection to prevent data loss caused by buffer overflow. Send a "Stop" signal to stop sending data when the receiving buffer is full. Send a "Start" signal to start sending data when the receiving buffer is empty. The options are **None**, Hardware RTS/CTS, and Software Xon/Xoff.

The following information is displayed.

- **Data Bits EMS**
- **Parity EMS**
- **Stop Bits EMS**

Network Configuration Menu

► Network Configuration

Network Stack

Select Enabled to enable Preboot Execution Environment (PXE) or Unified Extensible Firmware Interface (UEFI) for network stack support. The options are Disabled and **Enabled**.

IPv4 PXE Support (Available when "Network Stack" is set to Enabled)

Select Enabled to enable IPv4 PXE boot support. If this feature is disabled, it will not create the IPv4 PXE boot option. The options are Disabled and **Enabled**.

IPv4 HTTP Support (Available when "Network Stack" is set to Enabled)

Select Enabled to enable IPv4 HTTP boot support. If this feature is disabled, it will not create the IPv4 HTTP boot option. The options are **Disabled** and Enabled.

IPv6 PXE Support (Available when "Network Stack" is set to Enabled)

Select Enabled to enable IPv6 PXE boot support. If this feature is disabled, it will not create the IPv6 PXE boot option. The options are Disabled and **Enabled**.

IPv6 HTTP Support (Available when "Network Stack" is set to Enabled)

Select Enabled to enable IPv6 HTTP boot support. If this feature is disabled, it will not create the IPv6 HTTP boot option. The options are **Disabled** and Enabled.

PXE Boot Wait Time (Available when "Network Stack" is set to Enabled)

Use this feature to set the wait time (in seconds) upon which the system BIOS will wait for you to press the <ESC> key to abort PXE boot instead of proceeding with PXE boot by connecting to a network server immediately. Press the <+> or <-> key on your keyboard to change the value. The default setting is **0**.

Media Detect Count (Available when "Network Stack" is set to Enabled)

Use this feature to set the wait time (in seconds) for the BIOS ROM to detect the presence of a LAN media either via the Internet connection or via a LAN port. Press the <+> or <-> key on your keyboard to change the value. The default setting is **1**.

PCIe/PCI/PnP Configuration Menu

► PCIe/PCI/PnP Configuration

The following information is displayed.

- PCI Bus Driver Version

PCI Devices Common Settings:**Re-Size BAR Support**

Use this feature to enable the Resizable BAR support. Resizable BAR is a PCIe interface technology that allows the CPU to access the entire frame buffer. With this technology, your system will be able to handle multiple CPU to GPU transfers simultaneously rather than queuing, which can improve the frame rate performance. The options are **Disabled** and Enabled.

SR-IOV Support (Unavailable when "Workload Profile" is set to Virtualization)

Select Enabled for Single-Root IO Virtualization support. The options are Disabled and **Enabled**.

ARI Support

Select Enabled for Alternative Routing-ID Interpretation (ARI) support. The options are Disabled and **Enabled**.

MMCFG Base

This feature determines how the lowest Memory Mapped Configuration (MMCFG) base is assigned to onboard PCI devices. The options are 1G, 1.5G, 1.75G, 2G, 2.25G, 3G, and **Auto**. The options of 2G and 2.25G are not available when the MMCFG size is 2G. The option of 3G is not available when the MMCFG size is 1G or 2G.

MMCFG Size

Use this feature to set the MMCFG size. The options are 64M, 128M, 256M, 512M, 1G, 2G, and **Auto**. Note that the MMCFG size is based on the memory populated.

MMIO High Base

Use this feature to select the base memory size according to memory-address mapping for the I/O hub. The options are 248T, 120T, 88T, 60T, 30T, 56T, 40T, 32T, 24T, 16T, 4T, 2T, 1T, 512G, 3584T, and **Auto**. The options of 248T, 120T, 88T, 60T, 30T, and 3584T are CPU-dependent.

MMIO High Granularity Size

Use this feature to select the high memory size according to memory-address mapping for the I/O hub. The options are 1G, 4G, 16G, 32G, 64G, 256G, and **1024G**. This feature is motherboard-dependent.

Bus Master Enable

If this feature is set to Enabled, the PCI Bus Driver will enable the Bus Master Attribute for DMA transactions. If this feature is set to Disabled, the PCI Bus Driver will disable the Bus Master Attribute for Pre-Boot DMA protection. The options are Disabled and **Enabled**.

NVMe Firmware Source

Use this feature to select the NVMe firmware to support system boot. The options are Vendor Defined Firmware and **AMI Native Support**. The option of Vendor Defined Firmware is pre-installed on the drive and may resolve errata or enable innovative functions for the drive. The option of AMI Native Support is offered by the BIOS with a generic method. The default option is motherboard-dependent.

VGA Priority

Use this feature to select the graphics device to be used as the primary video display for system boot. The options are **Onboard** and Offboard.

Onboard Video Option ROM

Select EFI to boot the computer using the Extensible Firmware Interface (EFI) device installed on the onboard video port. The options are Disabled and **EFI**.

Onboard LAN1 Option ROM

Select EFI to boot the computer using the EFI device installed on LAN port 1. The options are Disabled and **EFI**.

Note: This feature is available when your motherboard supports onboard LAN ports.

Onboard LAN2 Option ROM

Use this feature to boot the computer using the EFI device installed on LAN port 2. Select Disabled to disable this feature. The default setting is **Disabled**.

Note: This feature is available when your motherboard supports onboard LAN ports and when "Onboard LAN1 Option ROM" is set to Disabled.

AOC-ATG-i2S LAN1 OPROM / Onboard SAS Option ROM / Onboard LAN1 Option ROM / Onboard NVMe1 Option ROM – Onboard NVMe24 Option ROM

Select EFI to boot the computer using the EFI device installed on the PCIe slot specified. The options are Disabled and **EFI**.

Note: The number of slots and slot naming vary based on your motherboard features.

HTTP Boot Configuration Menu

► HTTP Boot Configuration

HTTP Boot Policy

Use this feature to set the HTTP boot policy. The options are Apply to all LANs, **Apply to each LAN**, and Boot Priority #1 instantly.

HTTPS Boot Checks Hostname

Important: Disabling "HTTPS Boot Checks Hostname" is a violation of RFC 6125 and may expose you to Man-in-the-Middle Attacks. Supermicro is not responsible for any and all security risks incurred by you disabling this feature.

Enable this feature for HTTPS boot to check the hostname of the TLS certificates to see if it matches the host name provided by the remote server. The options are **Enabled** and Disabled (WARNING: Security Risk!!).

Priority of HTTP Boot

Instance of Priority 1: (Available when your motherboard supports this feature)

This feature sets the rank target port. The default setting is 1.

Select IPv4 or IPv6

This feature specifies which connection the target LAN port should boot from. The options are **IPv4** and IPv6.

Boot Description

Use this feature to enter a boot description, which cannot be longer than 75 characters. Be sure to enter a boot description; otherwise, the boot option for the URI cannot be created.

Boot URI

Enter a Boot Uniform Research Identifier (URI) with 128 characters or shorter. This Boot URI determines how IPv4 Boot Option and IPv6 Boot Option will be created.

Instance of Priority 2: (Available when your motherboard supports this feature)

This feature sets the rank target port. The default setting is 0.

Select IPv4 or IPv6 (Unavailable when "Instance of Priority 2:" above is set to 0)

This feature specifies which connection the target LAN port should boot from. The options are **IPv4** and IPv6.

Boot Description (Unavailable when "Instance of Priority 2:" above is set to 0)

Use this feature to enter a boot description, which cannot be longer than 75 characters. Please be sure to enter a boot description; otherwise, the boot option for the URI cannot be created.

Boot URI (Unavailable when "Instance of Priority 2:" above is set to 0)

Enter a Boot URI with 128 characters or shorter. This Boot URI determines how IPv4 Boot Option and IPv6 Boot Option will be created.

Supermicro KMS Server Configuration Menu

► Supermicro KMS Server Configuration

Note: Be sure to configure all the features in the submenu of Supermicro KMS Server Configuration and the feature of "KMS Security Policy" in the submenu of Super-Guardians Configuration so that your system can communicate with the KMS server.

TPM-KMS Support

This feature combines the capabilities of a hardware-based security module (TPM) with the Key Management Service (KMS) to enhance security by managing cryptographic keys and ensuring secure access to sensitive data. The options are **Disabled** and **Enabled**.

Supermicro KMS Server IP address

Use this feature to set the Supermicro KMS server IPv4 address in dotted-decimal notation.

Second Supermicro KMS Server IP address

Use this feature to set the second Supermicro KMS server IPv4 address in dotted-decimal notation.

Supermicro KMS TCP Port number

Use this feature to set the TCP port number used in the Supermicro KMS server. The valid range is 100–9999. The default setting is **5696**. Do not change the default setting unless a different TCP port number has been specified and used in the Supermicro KMS server.

KMS Time Out

Use this feature to enter the KMS server connecting time-out (in seconds). The default setting is **5** (seconds).

TimeZone

Use this feature to set the correct time zone. The default setting is **0** (not specified).

Client UserName

Press <Enter> to set the client identity (UserName). The length is 0–63 characters.

Client Password

Press <Enter> to set the client identity (Password). The length is 0–31 characters.

▶ CA Certificate

▶ Client Certificate

▶ Client Private Key

Use the three features above to enroll factory defaults or load the KMS Transport Layer Security (TLS) certificates, which are generated by the KMS server, from the file stored in the USB flash drive as shown below.

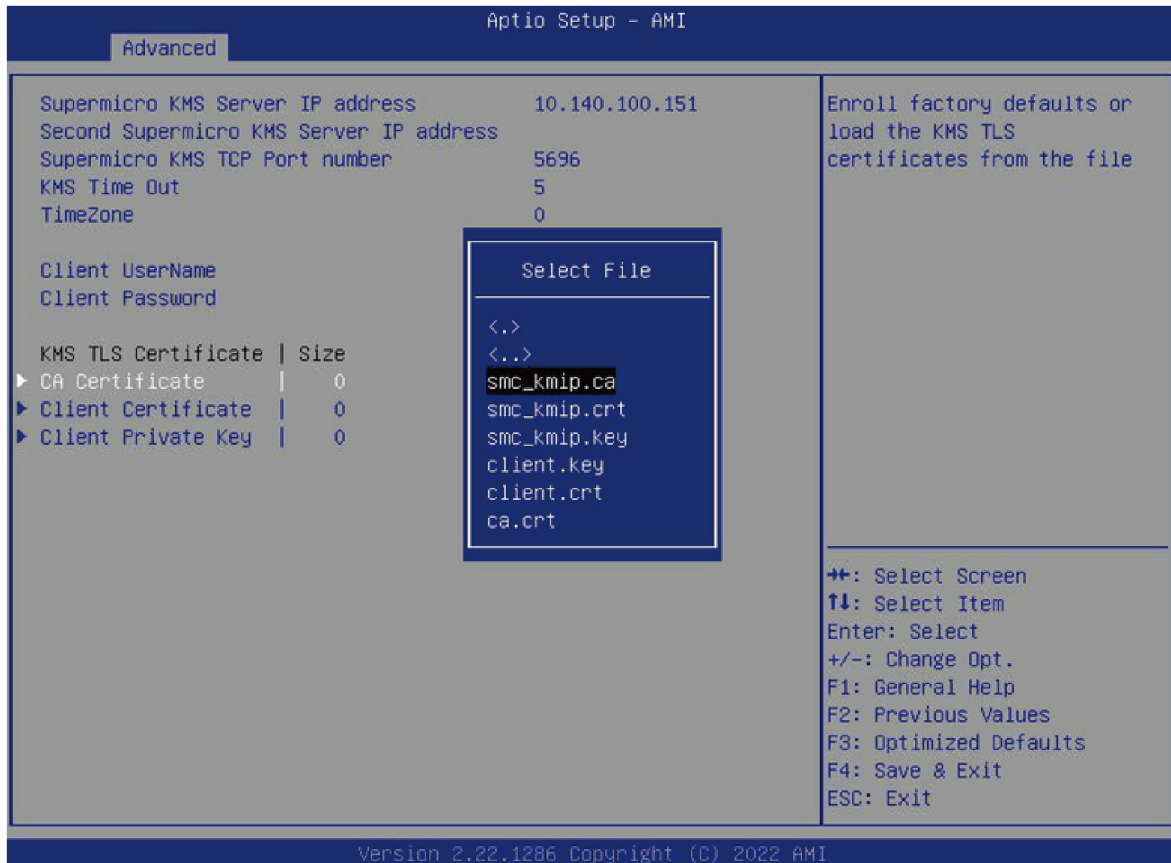

Private Key Password (Available when "Client Private Key" above has been set)

Use this feature to change the private key password.

Super-Guardians Configuration Menu

▶ Super-Guardians Configuration

Super-Guardians Protection Policy

Use this feature to enable the Super-Guardians Protection Policy. The options are **Storage**, **System**, and **System and Storage**. Set this feature to **Storage** to protect and have secure access to the Trusted Computing Group (TCG) NVMe devices with the Authentication-Key (AK). Set this feature to **System** to protect and have secure access to your system/motherboard with the AK. Set this feature to **System and Storage** to protect and have secure access to your system/motherboard/storage devices with the AK.

KMS Security Policy (Available when "TPM Security Policy" and "USB Security Policy" are set to Disabled)

Set this feature to **Enabled** to enable the KMS Security Policy. When this feature has not previously been set to **Enabled**, the options are **Disabled** and **Enabled**. Changes take effect after you save settings and reboot the system.

When this feature has previously been set to Enabled, the options are **Enabled**, Reset, and Key Rotation. Set this feature to Key Rotation to obtain an existing AK from the KMS server and create a new AK. To disable the KMS Security Policy, set this feature to Reset. When this feature is set to Reset, the system and TCG NVMe devices chosen in "Super-Guardians Protection Policy" will be in the unprotected mode.

Notes:

- Be sure that the KMS server is ready before configuring this feature.
- Use the professional KMS server solutions (e.g., Thales Server) or the Supermicro PyKMIP Software Package to establish the KMS server.

KMS Server Retry Count (Available when "TPM Security Policy" and "USB Security Policy" are set to Disabled)

Use this feature to specify how many times the system will attempt reconnecting to the KMS server. The valid range is 0–10. Press the <+> or <-> key on your keyboard to change the value. The default setting is 5. If the value is 0, the system will retry infinitely.

TPM Security Policy (Available when "KMS Security Policy" and "USB Security Policy" are set to Disabled)

Set this feature to Enabled to enable the TPM Security Policy. When this feature has not previously been set to Enabled, the options are **Disabled** and Enabled. Changes take effect after you save settings and reboot the system.

When this feature has previously been set to Enabled, the options are **Enabled**, Reset, and Key Rotation. To disable the TPM Security Policy, set this feature to Reset. When this feature is set to Reset, the system and TCG NVMe devices chosen in "Super-Guardians Protection Policy" will be in the unprotected mode.

Note: The TPM 2.0 (either onboard or external) is required to configure this feature.

Load Authentication-Key (Available when "KMS Security Policy," "TPM Security Policy," and "USB Security Policy" are set to Disabled)

Use this feature to load the Authentication-Key. The options are **Disabled** and Enabled. Set this feature to Enabled. Changes take effect after you save settings and reboot the system. While booting, the BIOS will automatically load the Authentication-Key (filename: TPMAuth.bin) from the USB flash drive. Afterwards, the default setting will be set to Disabled by the BIOS.

Notes:

- Be sure to connect a USB flash drive with the Authentication-Key (filename: TPMAuth.bin) to your system before the system reboot.
- Be sure to save the Authentication-Key (filename: TPMAuth.bin) to the USB flash drive and keep a backup. Load the Authentication-Key (filename: TPMAuth.bin) after the TPM (either onboard or external) is detected by your system. Otherwise, the TPM function can not work properly.

Save Authentication-Key (Available when "TPM Security Policy" is set to Enabled)

Use this feature to save the Authentication-Key. The options are **Disabled** and Enabled. Set this feature to Enabled. Changes take effect after you save settings and reboot the system. While booting, the BIOS will automatically save the Authentication-Key (filename: TPMAuth.bin) to the USB flash drive. Afterwards, the default setting will be set to Disabled by the BIOS.

Note: Be sure to connect a USB flash drive to your system before the system reboot.

USB Security Policy (Available when "KMS Security Policy" and "TPM Security Policy" are set to Disabled)

Use this feature to enable the USB Security Policy. The options are **Disabled** and Enabled. Set this feature to Enabled. Changes take effect after you save settings and reboot the system. Connect a USB flash drive to your system before the system reboot. While booting, the BIOS will automatically create the USB Authentication-Key (filename: USBAuth.bin) and save it to the USB flash drive.

When this feature has been previously set to Enabled, the options are **Enabled** and Reset. To disable the USB Security Policy, set this feature to Reset. When this feature is set to Reset, the system and TCG NVMe devices chosen in "Super-Guardians Protection Policy" will be in the unprotected mode.

Note: Be sure to connect a USB flash drive to your system before configuring this feature. Save the USB Authentication-Key (filename: USBAuth.bin) to the USB flash drive and keep a backup.

Supermicro KMS Server Configuration Menu

► Supermicro KMS Server Configuration

Note: Be sure to configure all the features in the submenu of Supermicro KMS Server Configuration and the feature of "KMS Security Policy" in the submenu of Super-Guardians Configuration so that your system can communicate with the KMS server.

TPM-KMS Support

This feature combines the capabilities of a hardware-based security module (TPM) with the Key Management Service (KMS) to enhance security by managing cryptographic keys and ensuring secure access to sensitive data. The options are **Disabled** and Enabled.

Supermicro KMS Server IP address

Use this feature to set the Supermicro KMS server IPv4 address in dotted-decimal notation.

Second Supermicro KMS Server IP address

Use this feature to set the second Supermicro KMS server IPv4 address in dotted-decimal notation.

Supermicro KMS TCP Port number

Use this feature to set the TCP port number used in the Supermicro KMS server. The valid range is 100–9999. The default setting is **5696**. Do not change the default setting unless a different TCP port number has been specified and used in the Supermicro KMS server.

KMS Time Out

Use this feature to enter the KMS server connecting time-out (in seconds). The default setting is **5** (seconds).

TimeZone

Use this feature to set the correct time zone. The default setting is **0** (not specified).

Client UserName

Press <Enter> to set the client identity (UserName). The length is 0–63 characters.

Client Password

Press <Enter> to set the client identity (Password). The length is 0–31 characters.

► CA Certificate

► Client Certificate

► Client Private Key

Use the three features above to enroll factory defaults or load the KMS Transport Layer Security (TLS) certificates, which are generated by the KMS server, from the file stored in the USB flash drive as shown below.

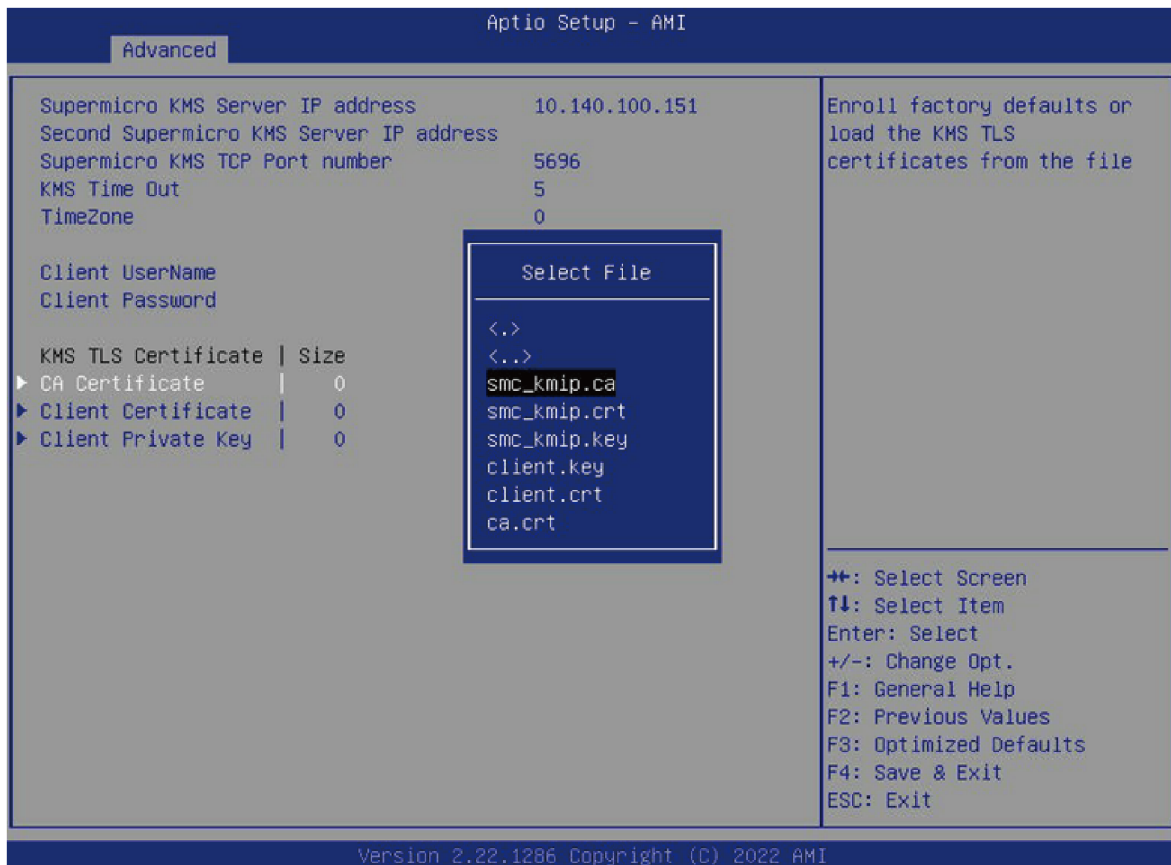

Private Key Password (Available when "Client Private Key" above has been set)

Use this feature to change the private key password.

Driver Health Menu

▶ Driver Health

This feature displays the health information of the drivers installed in your system, including LAN controllers, as detected by the BIOS. Select one and press <Enter> to see the details.

Note: This section is provided for reference only, for the driver health status will differ depending on the drivers installed in your system. It's also based on your system configuration and the environment that your system is operating in.

4.4 Event Logs

Use this menu to configure Event Logs settings.

Note: After making any changes in this section, be sure to reboot the system for the changes to take effect.

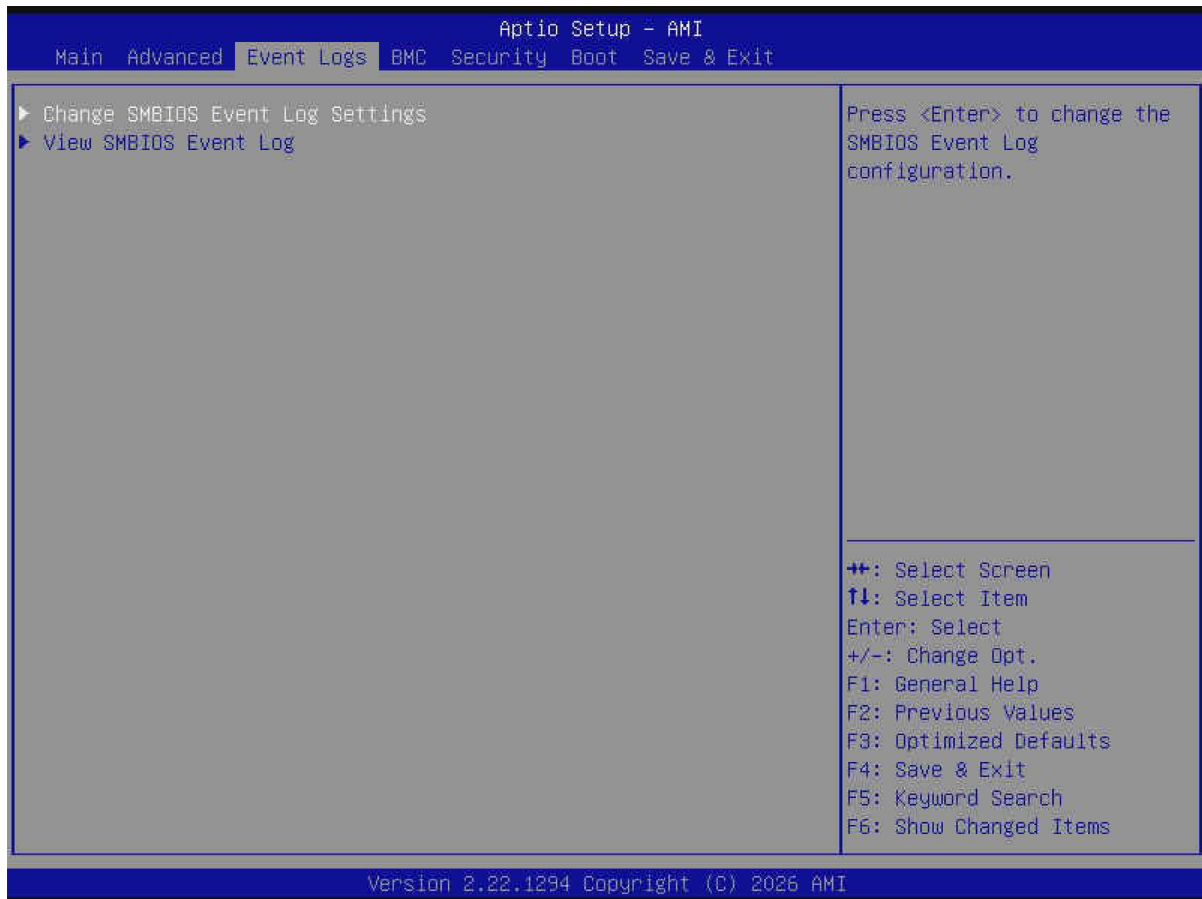

Figure 4-3. Event Logs Setup Page

► Change SMBIOS Event Log Settings

Note: Reboot the system for the changes in this section to take effect.

Enabling/Disabling Options

SMBIOS Event Log

Select Enabled to enable System Management BIOS (SMBIOS) Event Logging during system boot. The options are Disabled and **Enabled**.

Erasing Settings

Erase Event Log (Available when "SMBIOS Event Log" is set to Enabled)

Select No to keep the event log without erasing it upon next system bootup. Select (Yes, Next reset) to erase the event log upon next system reboot. The options are **No**, (Yes, Next reset), and (Yes, Every reset).

When Log is Full (Available when "SMBIOS Event Log" is set to Enabled)

Select Erase Immediately to immediately erase all errors in the SMBIOS event log when the event log is full. Select Do Nothing for the system to do nothing when the SMBIOS event log is full. The options are **Do Nothing** and Erase Immediately.

SMBIOS Event Log Standard Settings

Log System Boot Event (Available when "SMBIOS Event Log" is set to Enabled)

Select Enabled to log system boot events. The options are Enabled and **Disabled**.

MECI (Available when "SMBIOS Event Log" is set to Enabled)

Enter the increment value for the multiple event counter. Enter a number between 1 and 255. The default setting is **1**. (MECI is the abbreviation for Multiple Event Count Increment.)

METW (Available when "SMBIOS Event Log" is set to Enabled)

Use this feature to determine how long (in minutes) should the multiple event counter wait before generating a new event log. Enter a number between 0 and 99. The default value is **60**. (METW is the abbreviation for Multiple Event Count Time Window.)

► View SMBIOS Event Log

Use this feature to view the events in the system event log. Select this feature and press <Enter> to view the status of an event in the log. The following information is displayed: DATE / TIME / ERROR CODE / SEVERITY.

4.5 BMC

Use this menu to configure Baseboard Management Console (BMC) settings.



Figure 4-4. BMC Setup Page

BMC Firmware Revision

This feature indicates the BMC firmware revision used in this system.

BMC STATUS

This feature indicates the status of the BMC firmware installed in this system.

System Event Log Menu

▶ System Event Log

Note: All values changed in this submenu do not take effect until computer is restarted.

Enabling/Disabling Options

SEL Components

Select Enabled to enable all system event logging upon system boot. The options are Disabled and **Enabled**.

Erasing Settings

Erase SEL (Available when "SEL Components" is set to Enabled)

Select (Yes, On next reset) to erase all system event logs upon next system boot. Select (Yes, On every reset) to erase all system event logs upon each system reboot. Select No to keep all system event logs after each system reboot. The options are **No**, (Yes, On next reset), and (Yes, On every reset).

When SEL is Full (Available when "SEL Components" is set to Enabled)

This feature defines what the BIOS should do when the system event log is full. Select Erase Immediately to erase all events in the log when the system event log is full. The options are **Do Nothing** and Erase Immediately.

BMC Network Configuration Menu

► BMC Network Configuration

Update BMC LAN Configuration

Select Yes for the BIOS to implement all IP/MAC address changes upon next system boot. The options are **No** and Yes.

Configure IPv4 Support

BMC LAN Selection

This feature displays the type of the BMC LAN.

BMC Network Link Status:

This feature displays the status of the BMC network link for this system.

Configuration Address Source

Use this feature to select the source of the IPv4 connection. If Static is selected, note the IP address of the IPv4 connection and enter it to the system manually in the field. If DHCP is selected, the BIOS will search for a Dynamic Host Configuration Protocol (DHCP) server in the

network that is attached to and request the next available IP address for this computer. The options are Static and **DHCP**. It is available for configuration when "Update BMC LAN Configuration" is set to Yes.

Station IP Address

This feature displays the Station IP address in decimal and in dotted quad form (i.e., 172.29.176.131). It is available for configuration when "Update BMC LAN Configuration" is set to Yes and "Configuration Address Source" above is set to Static.

Subnet Mask

This feature displays the sub-network that this computer belongs to. It is available for configuration when "Update BMC LAN Configuration" is set to Yes and "Configuration Address Source" above is set to Static.

Station MAC Address

This feature displays the Station MAC address for this computer. MAC addresses are six two-digit hexadecimal numbers.

Gateway IP Address

This feature displays the IPv4 gateway IP address for this computer. This should be in decimal and in dotted quad form (i.e., 172.29.0.1). It is available for configuration when "Update BMC LAN Configuration" is set to Yes and "Configuration Address Source" above is set to Static.

Configure IPv6 Support

IPv6 Address Status

This feature displays the status of the IPv6 address.

IPv6 Support

Use this feature to enable IPv6 support. The options are **Enabled** and Disabled. It is available for configuration when "Update BMC LAN Configuration" is set to Yes.

Configuration Address Source

Use this feature to select the source of the IPv6 connection. If Static Configuration is selected, note the IP address of IPv6 connection and enter it to the system manually in the field. If the other two options are selected, the BIOS will search for a DHCP server in the network that is attached to and request the next available IP address for this computer. The options are Static Configuration, **DHCPv6 Stateless**, and DHCPv6 Stateful. It is available for configuration when "Update BMC LAN Configuration" is set to Yes.

IPv6 Address ("Static," "DHCPv6 Stateless," or "DHCPv6 Stateful," depending on the option you selected for "Configuration Address Source" above)

This feature displays the station IPv6 address. It is available for configuration when "Update BMC LAN Configuration" is set to Yes and "Configuration Address Source" above is set to Static Configuration.

Prefix Length

This feature displays the prefix length. It is available for configuration when "Update BMC LAN Configuration" is set to Yes and "Configuration Address Source" above is set to Static Configuration.

Gateway IP

This feature displays the IPv6 gateway IP address. It is available for configuration when "Update BMC LAN Configuration" is set to Yes and "Configuration Address Source" above is set to Static Configuration.

Advanced Settings

Use this feature to set the DNS server IP. The default setting allows this system to obtain the DNS server IP automatically. The options are **Auto obtain DNS server IP** and **Manually obtain DNS server IP**. It is available for configuration when "Update BMC LAN Configuration" is set to Yes and "Configuration Address Source" above is set to DHCPv6 Stateless.

Preferred DNS server IP (Available when "Advanced Settings" above is set to Manually obtain DNS server IP)

This feature displays the preferred DNS server IP. It can be configured via Redfish.

Alternative DNS server IP (Available when "Advanced Settings" above is set to Manually obtain DNS server IP)

This feature displays the alternative DNS server IP. It can be configured via Redfish.

Configure VLAN Support

VLAN Support

Use this feature to enable the virtual LAN (VLAN) support. The options are **Enabled** and **Disabled**.

VLAN ID (Available when "VLAN Support" is set to Enabled)

Use this feature to create a new VLAN ID. The valid range is 1–4094. The default setting is **1**.

4.6 Security

Use this menu to configure the following security settings for the system.

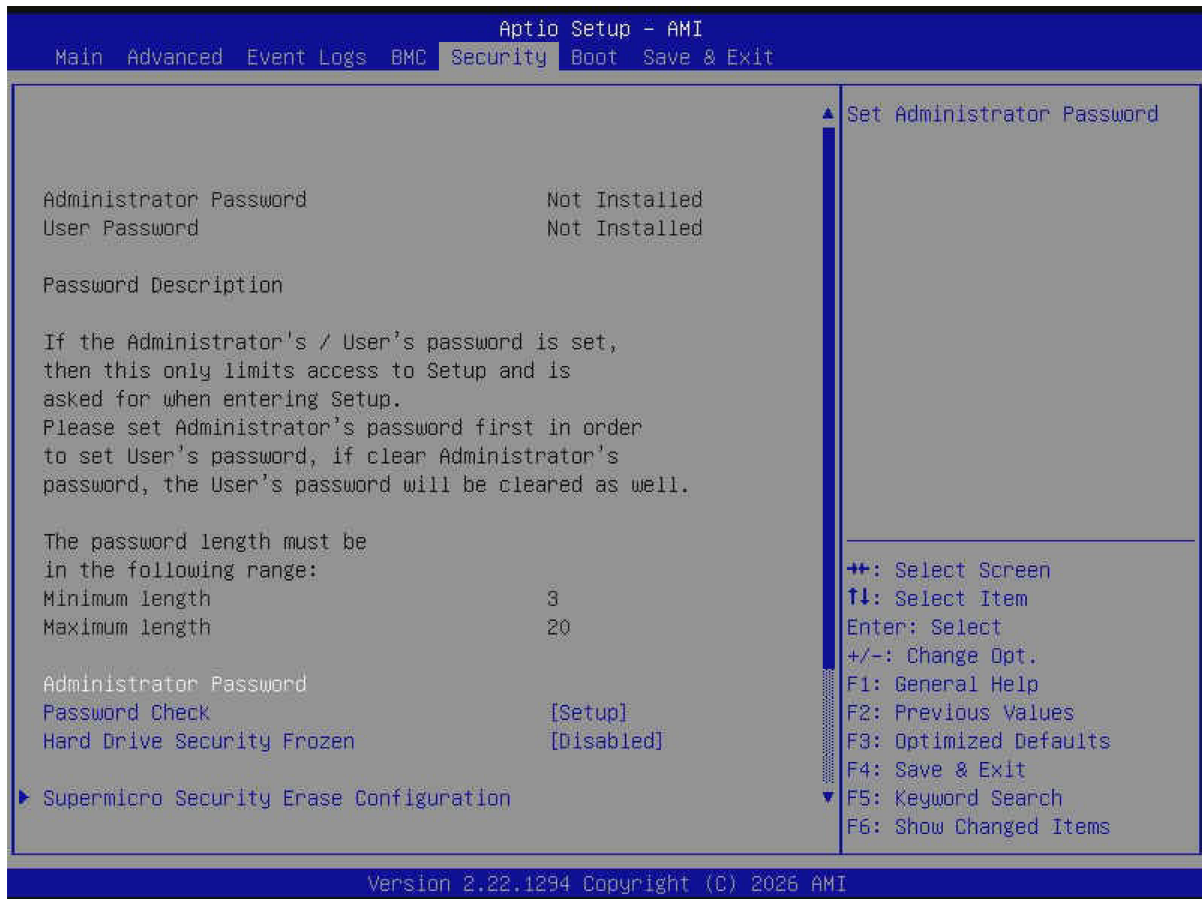

Figure 4-5. Security Setup Page

Disable Block Sid and Freeze Lock (Available when your storage devices support TCG)

Select Enabled to allow SID authentication to be performed in TCG storage devices. The options are **Disabled** and Enabled.

The following information is displayed:

- Administrator Password
- User Password
- Password Description

Administrator Password

This feature indicates if an administrator password has been installed. Use this feature to set the administrator password, which is required to enter the BIOS Setup utility. The length of the password can be between three and 20 characters long.

User Password (Available when "Administrator Password" has been set)

This feature indicates if a user password has been installed. Use this feature to set the user password which is required to enter the BIOS Setup utility. The length of the password can be between three and 20 characters long.

Password Check

Select Setup for the system to check for a password upon entering the BIOS Setup utility. Select Always for the system to check for the passwords needed at bootup and upon entering the BIOS Setup utility. The options are **Setup** and Always.

Hard Drive Security Frozen

Select Enabled to freeze the Lock Security feature for HDD to protect key data in hard drives from being altered. The options are **Disabled** and Enabled.

Lockdown Mode (Available when the DCMS key is activated)

Select Enabled to support the Lockdown Mode, which prevents the existing data or keys stored in the system from being altered or changed in an effort to preserve system integrity and security. The options are **Disabled** and Enabled.

Supermicro Security Erase Configuration Menu

► Supermicro Security Erase Configuration

Use this submenu to configure the Supermicro-proprietary Security Erase settings. When this submenu is selected, the following information is displayed. Note that the order of the following information may differ based on the storage devices being detected.

- **HDD Name:** This feature displays the model name of the storage device that is detected by the BIOS.
- **HDD Serial Number:** This feature displays the serial number of the storage device that is detected by the BIOS.
- **Security Mode:** This feature displays the security mode of the storage device that is detected by the BIOS.
- **Estimated Time:** This feature displays the estimate time needed to perform the selected Security Erase features.
- **HDD User Pwd Status:** This feature indicates if a password has been set as a storage device user password, which enables configuring Supermicro Security Erase settings on this storage device.
- **TCG Device Type:** This feature displays the TCG device type detected by the system.

- **Admin Pwd Status:** This feature indicates if a password has been set as a storage device administrator password, which enables configuring Supermicro Security Erase settings on this storage device.

Note: This submenu is available when any storage device is detected by the BIOS. For more information about this feature, refer to our website.

Security Function

Select **Set Password** to set a storage device user password to enable configuring the security settings on the storage device. Select **Security Erase - Password** to enter a storage device user password to enable erasing the password and the contents previously stored in the storage device. Select **Security Erase - Without Password** to use the manufacturer default password "1111111111" as the storage device user password and enable erasing the contents of the storage device by using this default password. The options are **Disabled**, **Set Password**, **Change Password**, **Clear Password**, **Security Erase - Password**, **Security Erase - PSID**, and **Security Erase - Without Password**.

Notes:

- The option of **Security Erase - PSID** is based on the storage device support. PSID is the abbreviation for Physical Security Identification.
- The options of **Change Password** and **Clear Password** are available when "Password" below has been set.
- The option of **Set Password** is NOT available when "Password" below has been set.

Password

Use this feature to set the storage device user password, which enables configuring the Supermicro Security Erase settings by using this user password.

New Password (Available when "Password" above has been set)

Use this feature to set the new user password for the storage device, which enables configuring the Supermicro Security Erase settings by using this new user password.

Secure Boot Menu

► Secure Boot

The following information is displayed:

- System Mode
- Secure Boot

Note: For detailed instructions on configuring Security Boot settings, refer to the Security Boot Configuration User's Guide at <https://www.supermicro.com/support/manuals>.

Secure Boot

Select Enabled to configure Secure Boot settings. The options are **Disabled** and Enabled.

Secure Boot Mode

Use this feature to select the desired secure boot mode for the system. The options are Standard and **Custom**.

▶ Enter Audit Mode

Select Ok to enter the Audit Mode workflow. It will result in erasing the Platform Key (PK) variables and resetting the system to the Setup/Audit Mode.

Note: This submenu is available when "Secure Boot Mode" is set to Custom.

▶ Enter Deployed Mode / Exit Deployed Mode

Select Ok to reset system to the User Mode or to the Deployed Mode.

Note: This submenu is available when "Secure Boot Mode" is set to Custom.

▶ Key Management

The following information is displayed:

- Vendor Keys

Note: This submenu is available when "Secure Boot Mode" is set to Custom.

Provision Factory Defaults

Select Enabled to install the default secure boot keys when the system is in the Setup Mode. Changes take effect after you save settings and reboot the system. The options are **Disabled** and Enabled.

▶ Restore Factory Keys

Select Yes to restore manufacturer default keys to ensure system security. The options are **Yes** and No. Selecting Yes will reset the system to the User Mode.

Note: This submenu is available when any secure keys have been installed.

▶ **Reset To Setup Mode**

This feature resets the system to the Setup Mode. The options are **Yes** and **No**.

Note: This submenu is available when any secure keys have been installed.

▶ **Enroll Efi Image**

This feature allows the Efi image to run in the secure boot mode and enroll the SHA256 Hash certificate of a PE image into the Authorized Signature Database (DB).

▶ **Export Secure Boot Variables**

This feature exports the NVRAM contents of secure boot variables to a storage device. The options are **Yes** and **No**.

Note: This submenu is available when any secure keys have been installed.

Secure Boot variable / Size / Keys / Key Source

▶ **Platform Key (PK)**

Use this feature to enter and configure a set of values to be used as platform firmware keys for the system. These values also indicate the sizes, key numbers, and the sources of the authorized signatures. Select **Update** to update the platform key.

▶ **Key Exchange Keys (KEK)**

Use this feature to enter and configure a set of values to be used as Key Exchange Keys for the system. These values also indicate the sizes, key numbers, and the sources of the authorized signatures. Select **Update** to update the Key Exchange Keys. Select **Append** to append the Key Exchange Keys.

▶ **Authorized Signatures (db)**

Use this feature to enter and configure a set of values to be used as Authorized Signatures for the system. These values also indicate the sizes, key numbers, and sources of the authorized signatures. Select **Update** to update the Authorized Signatures. Select **Append** to append the new Authorized Signatures.

► **Forbidden Signatures (dbx)**

Use this feature to enter and configure a set of values to be used as Forbidden Signatures for the system. These values also indicate sizes, key numbers, and key sources of the forbidden signatures. Select Update to update the Forbidden Signatures. Select Append to append the Forbidden Signature.

► **Authorized TimeStamps (dbt)**

Use this feature to set and save the timestamps for the Authorized Signatures, which will indicate the time when these signatures are entered into the system. These values also indicate sizes, keys, and key sources of the authorized timestamps. Select Update to update the Authorized TimeStamps. Select Append to append the Authorized TimeStamps.

► **OsRecovery Signatures (dbr)**

Use this feature to set and save the Authorized Signatures used for OS recovery. Select Update to update the OsRecovery Signatures. These values also indicate sizes, keys, and key sources of the OsRecovery Signatures. Select Append to append the OsRecovery Signatures.

4.7 Boot

Use this menu to configure Boot settings.

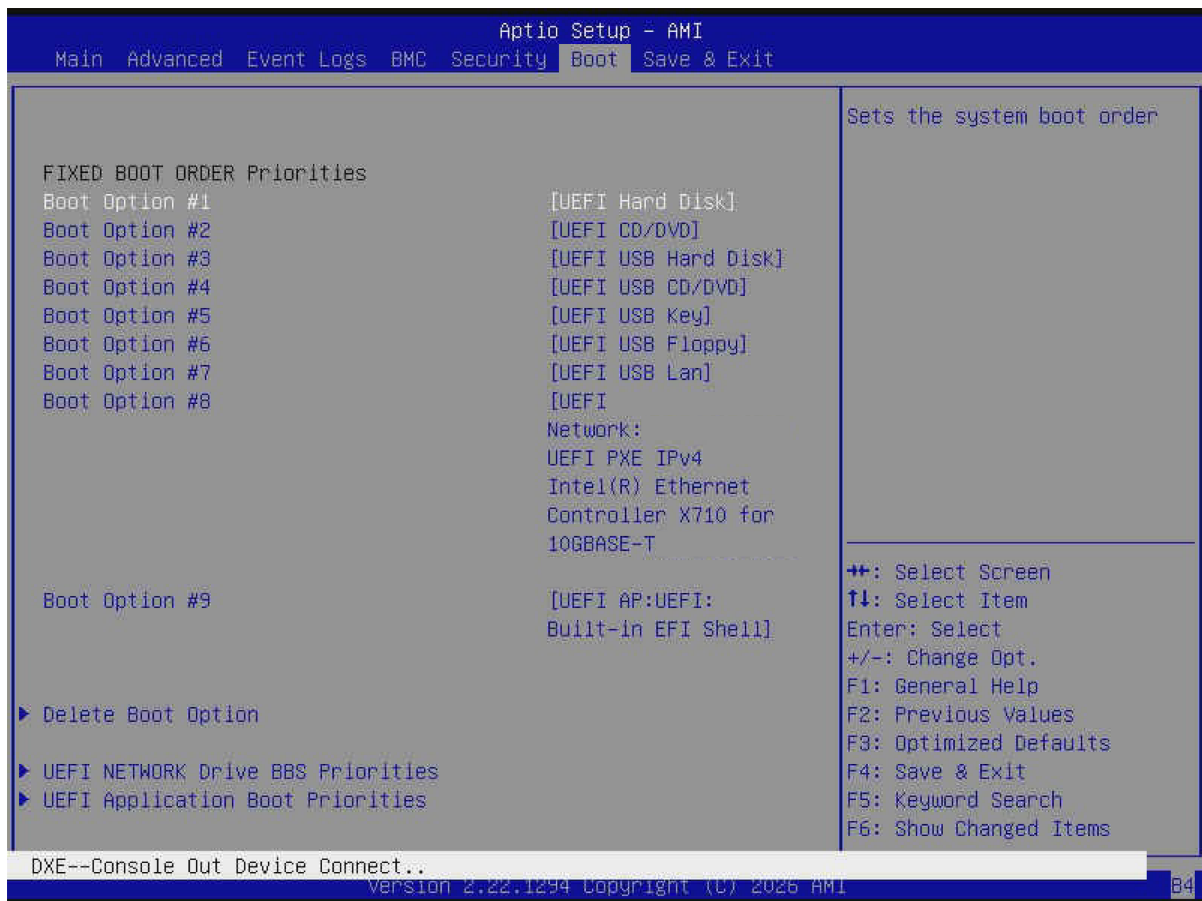

Figure 4-6. Boot Setup Page

FIXED BOOT ORDER Priorities

Use this feature to prioritize the order of a bootable device from which the system will boot. Press <Enter> on each item sequentially to select the device.

- Boot Option #1 – Boot Option #9

► Add New Boot Option

Use this feature to add a new boot option to the boot priority features for system boot.

Note: This submenu is available when any storage device is detected by the BIOS.

Add boot option

Use this feature to specify the name for the new boot option.

Path for boot option

Use this feature to enter the path for the new boot option in the format fsx:\path\filename.efi.

Boot option File Path

Use this feature to specify the file path for the new boot option.

Create

After setting the name and the file path for the boot option, press <Enter> to create the new boot option in the boot priority list.

▶ Delete Boot Option

Use this feature to select a boot device to delete from the boot priority list.

Delete Boot Option

Use this feature to remove an EFI boot option from the boot priority list.

▶ UEFI NETWORK Drive BBS Priorities

Use this feature to set the system boot order of detected devices.

▶ UEFI Application Boot Priorities

Use this feature to set the system boot order of detected devices.

▶ UEFI USB Key Drive BBS Priorities

Use this feature to set the system boot order of detected devices.

▶ UEFI Hard Disk Drive BBS Priorities

Use this feature to set the system boot order of detected devices.

▶ UEFI NETWORK Drive BBS Priorities

Use this feature to set the system boot order of detected devices.

▶ UEFI Application Boot Priorities

Use this feature to set the system boot order of detected devices.

4.8 Save & Exit

Select Save & Exit from the BIOS Setup screen to configure the settings below.

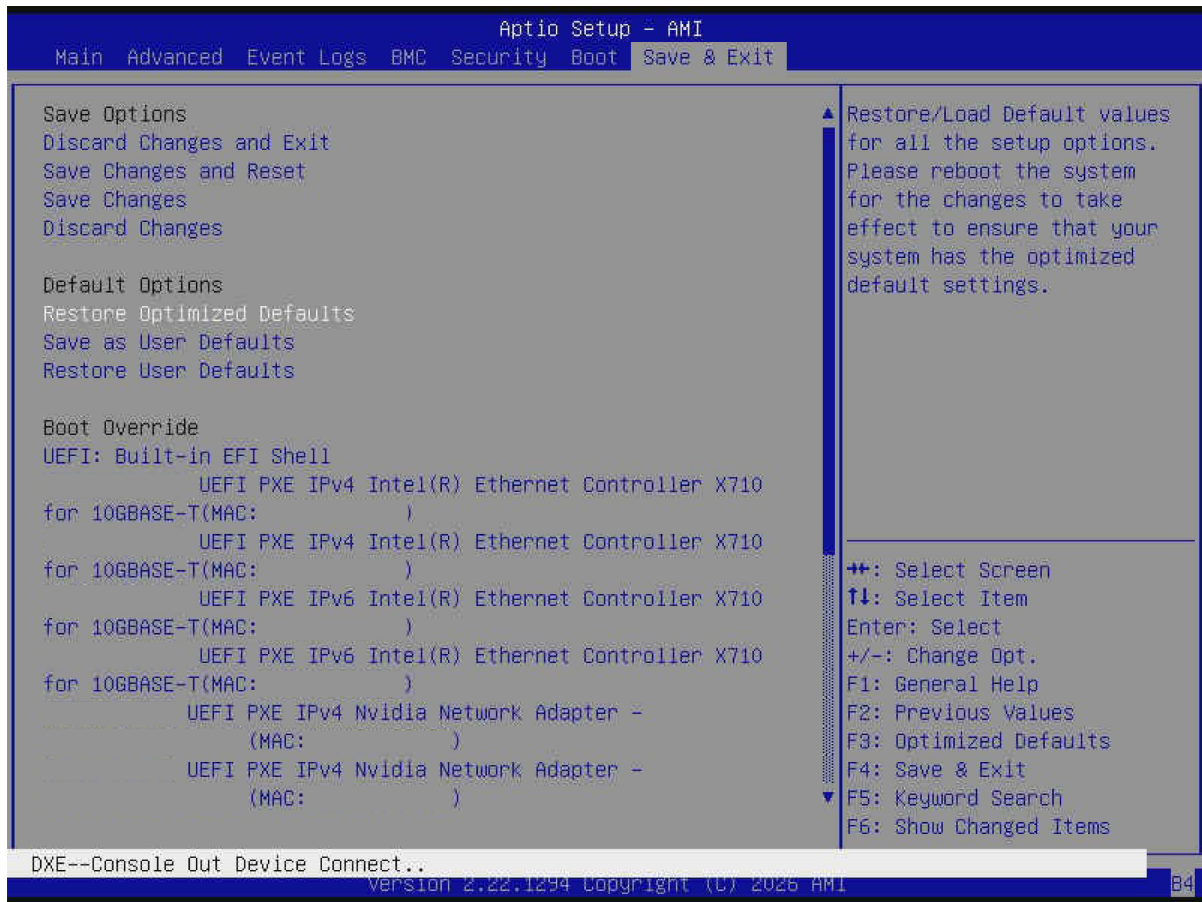

Figure 4-7. Save and Exit Setup Page

Save Options

Discard Changes and Exit

Use this feature to exit from the BIOS Setup utility without making any permanent changes to the system configuration and reboot the computer.

Save Changes and Reset

On completing the system configuration changes, use this feature to exit the BIOS Setup utility and reboot the computer for the new system configuration parameters to take effect.

Save Changes

On completing the system configuration changes, use this feature to save all changes made. This will not reset (reboot) the system.

Discard Changes

Select this feature and press <Enter> to discard all changes made and return to the BIOS Setup utility.

Default Options**Restore Optimized Defaults**

Select this feature and press <Enter> to load manufacturer optimized default settings, which are intended for maximum system performance but not for maximum stability.

Note: Reboot the system for the changes to take effect to ensure that the system has the optimized default settings.

Save as User Defaults

Select this feature and press <Enter> to save all changes as the default values specified to the BIOS Setup utility for future use.

Restore User Defaults

Select this feature and press <Enter> to retrieve user-defined default settings that have been saved previously.

Boot Override

Note: Use this section to override the Boot priorities sequence in the Boot menu, and immediately boot the system with a device specified here instead of the one specified in the boot list. This is a one-time boot override.

Launch EFI Shell from filesystem device

Use this feature to launch the EFI shell application (Shell.efi) from one of the available filesystem devices. A filesystem is a virtual, logical, or physical system for organizing, managing, and accessing the files and directories on devices such as SSDs, HDDs, or other storage devices.

Appendix A:

BIOS Codes

For information about BIOS codes for the X14DBG-LC2 motherboard, refer to the following content.

BIOS Error POST (Beep) Codes

During the Power-On Self-Test (POST) routines, which are performed each time the system is powered on, errors may occur.

Non-fatal errors are those which, in most cases, allow the system to continue the boot up process. The error messages normally appear on the screen.

Fatal errors are those which will not allow the system to continue the boot up process. If a fatal error occurs, you should consult with your system manufacturer for possible repairs.

These fatal errors are usually communicated through a series of audible beeps that can be heard on an external buzzer connected to JD1. The table shown below lists some common errors and their corresponding beep codes encountered by users.

BIOS Beep (POST) Codes		
Beep Code	Error Message	Description
1 beep	Refresh	Circuits have been reset (Ready to power up)
5 short, 1 long	Memory error	No memory detected in system
5 short, 2 long	Display memory read/write error	Video adapter missing or with faulty memory
1 long continuous	System OH	System overheat condition

Additional BIOS POST Codes

The AMI BIOS supplies additional checkpoint codes, which are documented online at <https://www.supermicro.com/support/manuals> ("AMI BIOS POST Codes User's Guide").

For information on AMI updates, refer to <https://www.ami.com/products>.

Appendix B:

Software

After the X14DBG-LC2 motherboard has been installed, you can install the Operating System (OS), configure RAID settings, and install the drivers.

Microsoft Windows OS Installation

If you will be using RAID, you must configure RAID settings before installing the Windows OS and the RAID driver. Refer to the RAID Configuration User Guides posted on our website at <https://www.supermicro.com/support/manuals>.

Installing the OS

1. Create a method to access the Microsoft Windows installation ISO file. That can be a USB flash or media drive, or the BMC KVM console.
2. Retrieve the proper drivers. Go to the Supermicro web page for your motherboard and click on "Download the Latest Drivers and Utilities," select the proper driver, and copy it to a USB flash drive.
3. Boot from a bootable device with Windows OS installation. You can see a bootable device list by pressing <F11> during the system bootup.

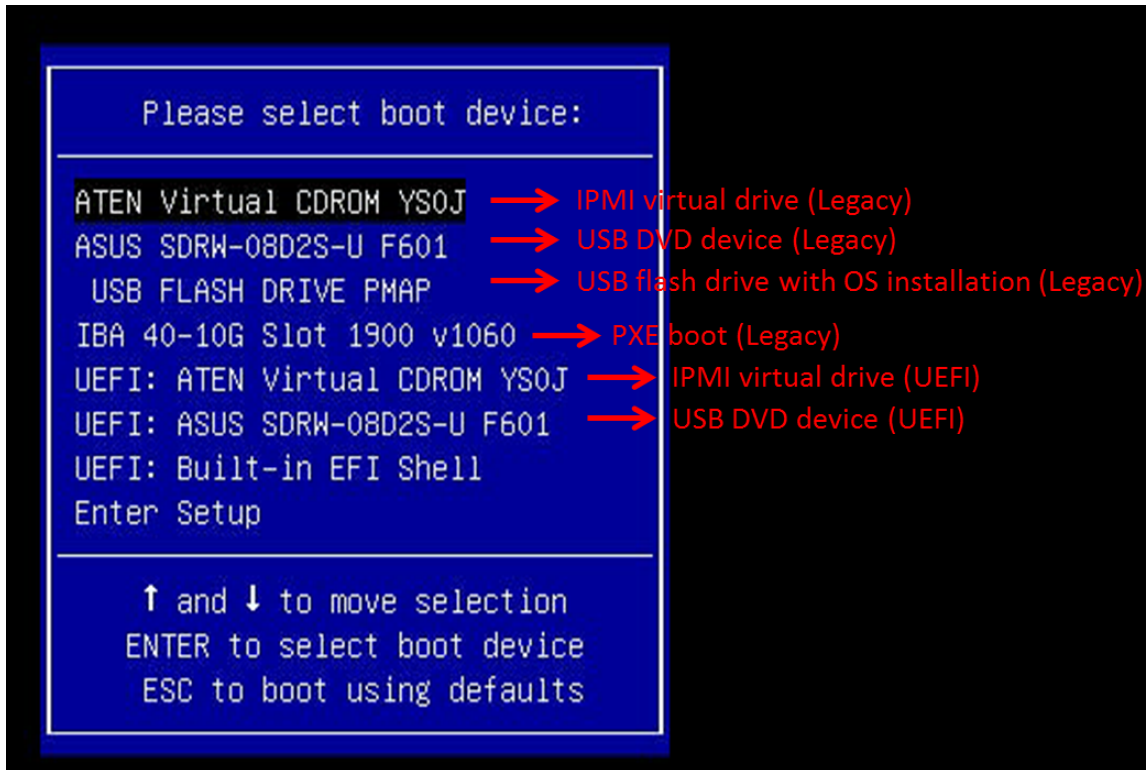

Figure B-1. Selecting the Boot Device

4. During Windows Setup, continue to the dialog box where you select the drives on which to install Windows. If the disk you want to use is not listed, click on the “Load driver” link at the bottom left corner.

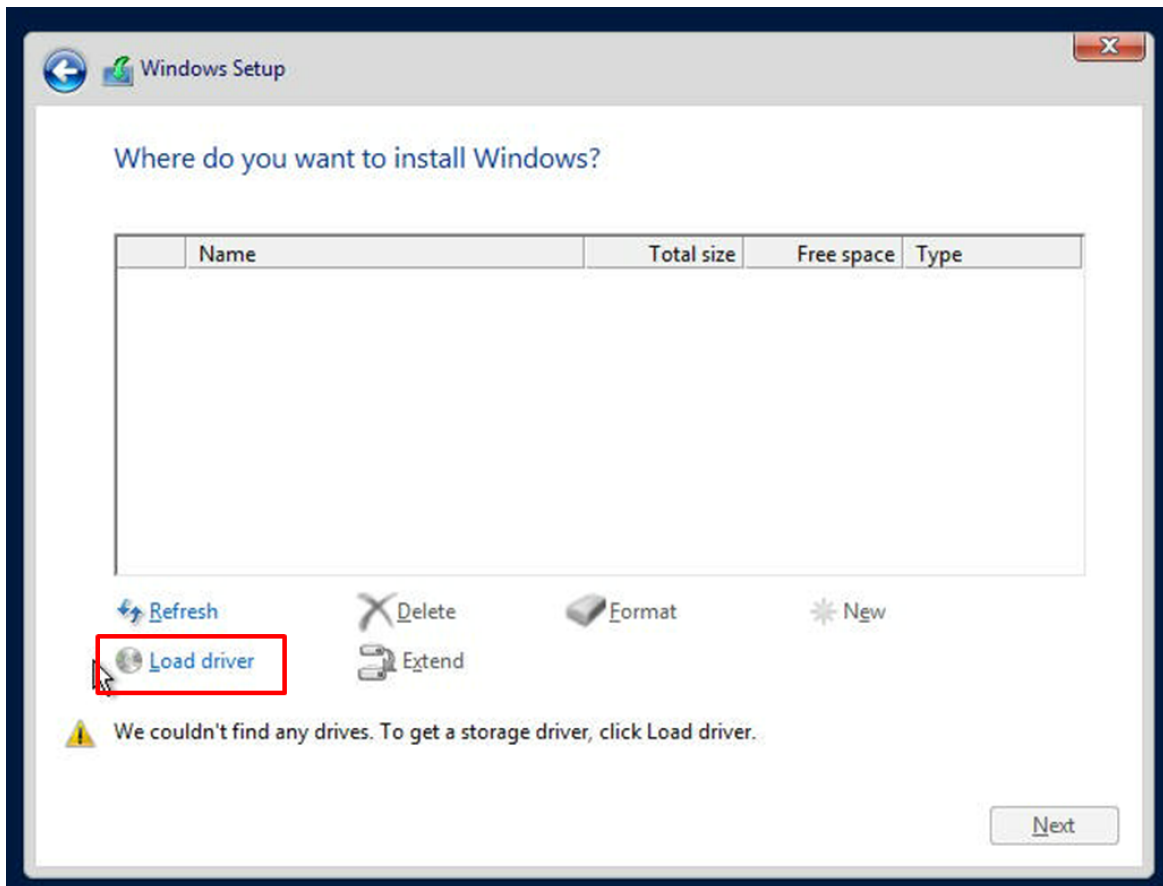

Figure B-2. Loading the Driver Link

To load the driver, browse the USB flash drive for the proper driver files.

5. Once all devices are specified, continue with the installation.
6. After the Windows OS installation has completed, the system will automatically reboot multiple times for system updates.

BMC

The X14DBG-LC2 motherboard provides remote access, monitoring, and management through the baseboard management controller (BMC) and other management controllers distributed among different system modules. There are several BIOS settings that are related to BMC. For general documentation and information on BMC, visit our website at the following page:

<https://www.supermicro.com/en/solutions/management-software/bmc-resources>

BMC ADMIN User Password

For security, each system is assigned a unique default BMC password for the ADMIN user. The password can be found on a sticker on the motherboard and a sticker on the chassis, for Supermicro chassis. The sticker also displays the BMC MAC address. If necessary, the password can be reset using the Supermicro IPMICFG tool.



Figure B-3. BMC Password Label

Appendix C:

Standardized Warning Statements

The following statements are industry standard warnings, provided to warn the user of situations which have the potential for bodily injury. Should you have questions or experience difficulty, contact Supermicro's Technical Support department for assistance. Only certified technicians should attempt to install or configure components.

Read this section in its entirety before installing or configuring components in the Supermicro X14DBG-LC2 motherboard.

These warnings may also be found on our website at the following page:

https://www.supermicro.com/about/policies/safety_information.cfm

Battery Handling



Warning! There is risk of explosion if the battery is replaced by an incorrect type. Replace the battery only with the same or equivalent type recommended by the manufacturer. Dispose of used batteries according to the manufacturer's instructions.

تحذير! يوجد خطر حدوث انفجار إذا تم استبدال البطارية بنوع غير صحيح. استبدل البطارية بنفس النوع أو نوع مكافئ موصى به من قبل الشركة المصنعة فقط. يجب التخلص من البطاريات المستخدمة وفقاً لإرشادات الجهة المصنعة.

警告! 如果更换的电池类型不正确, 有爆炸危险。更换电池时, 请使用制造商推荐的相同或同等型号的电池。请按制造商的说明处理废旧电池。

警告! 如果更換的電池類型不正確。請使用製造商建議之相同或功能相當的電池更換原有電池。請按照製造商的說明指示處理廢棄舊電池。

Advarsel! Der er risiko for eksplosion, hvis batteriet skiftes med et batteri af den forkerte type. Batteriet må kun skiftes med et batteri af samme eller tilsvarende type, der anbefales af producenten. Opbrugte batterier skal bortskaffes i henhold til vejledningerne fra producenten.

Waarschuwing! Er bestaat een explosiegevaar als de batterij wordt vervangen door een onjuist type. Vervang de batterij alleen door hetzelfde type of een soortgelijk type aanbevolen door de fabrikant. Verwijder gebruikte batterijen overeenkomstig de instructies van de fabrikant.

Varoitus! Väärän tyyppisen akun käyttö voi aiheuttaa räjähdysvaaran. Vaihda akku vain valmistajan suosittelemaan samaan tai vastaavaan tyyppiseen akkuun. Hävitä käytetyt paristot valmistajan ohjeiden mukaisesti.

Attention! Il y a un risque d'explosion si la batterie est remplacée par une d'un type incorrect. Remplacez la batterie uniquement par une d'un type identique ou équivalent recommandé par le fabricant. Éliminez les batteries usagées conformément aux instructions du fabricant.

Warnung! Es besteht Explosionsgefahr, wenn die Batterie durch einen falschen Typ ersetzt wird. Ersetzen Sie die Batterie ausschließlich durch denselben oder einen vom Hersteller empfohlenen gleichwertigen Typ. Entsorgen Sie gebrauchte Batterien gemäß den Anweisungen des Herstellers.

אזהרה! קיימת סכנת פיצוץ אם הסוללה תוחלף בסוללה מסוג שגוי. החלף את הסוללה רק בסוללה מאותו סוג או בסוללה מקבילה המומלצת על ידי היצרן. השלך סוללות משומשות בהתאם להוראות היצרן.

चेतावनी! यदि बैटरी को गलत प्रकार से बदला जाता है तो विस्फोट का जोखिम है। बैटरी को केवल निर्माता द्वारा अनुशंसित समान या समकक्ष प्रकार से ही बदलें। इस्तेमाल की गई बैटरियों का निपटान निर्माता के निर्देशों के अनुसार करें।

警告! 電池を間違ったタイプに交換すると爆発する危険があります。交換する電池はメーカーが推奨するタイプ、または同等のものを使用してください。使用済み電池は、メーカーの指示に従って廃棄してください。

경고! 배터리를 잘못된 종류로 교체하면 폭발의 위험이 있습니다. 기존 배터리와 동일하거나 제조사에서 권장하는 동등한 종류의 배터리로만 교체해야 합니다. 제조사의 안내에 따라 사용된 배터리를 처리하여 주십시오.

Advarsel! Det er fare for eksplosjon hvis batteriet byttes ut med et av feil type. Batterier skal kun byttes ut med et av lik eller tilsvarende type, som anbefalt av produsenten. Kast brukte batterier i henhold til produsentens instruksjoner.

¡Advertencia! Existe riesgo de explosión si se sustituye la batería por una de tipo incorrecto. Reemplace la batería únicamente con el mismo tipo o uno equivalente recomendado por el fabricante. Deseche las baterías usadas de acuerdo con las instrucciones del fabricante.

Varning! Det finns risk för explosion om batteriet byts ut mot en felaktig typ. Byt endast ut batteriet mot ett batteri av samma eller likvärdig typ som rekommenderas av tillverkaren. Kassera förbrukade batterier i enlighet med tillverkarens anvisningar.

Connection to Earth



Warning! Equipment shall be connected to an Earth mains socket-outlet.

تحذير! يجب توصيل الأجهزة بمقبس كهربائي أرضي.

警告！设备应连接到接地电源插座。

警告！應將設備連接至接地電源插座。

Advarsel! Dette udstyr skal sluttes til en jordforbundet stikkontakt.

Waarschuwing! De apparatuur moet worden aangesloten op een geaard netstopcontact.

Varoitus! Laitteet on kytkettävä maadoitettuun pistorasiaan.

Attention! L'équipement doit être connecté à une prise de courant avec mise à la terre.

Warnung! Das Gerät muss an eine geerdete Netzsteckdose angeschlossen werden.

אזהרה! יש לחבר את הציוד לשקע חשמל עם הארקה.

चेतावनी! उपकरण को एक अर्थ मेन्स सॉकेट-आउटलेट से जोड़ा जाना चाहिए।

警告！機器は、接地主電源コンセントに接続するものとします。

경고! 장비는 접지된 전원 콘센트에 연결해야 합니다.

Advarsel! Utstyret skal kobles til en jordet stikkontakt.

¡Advertencia! El equipo deberá conectarse a una toma de corriente con conexión a tierra.

Varning! Utrustningen ska vara ansluten till ett jordat eluttag.

Product Disposal



Warning! Ultimate disposal of this product should be handled according to all national laws and regulations.

تحذير! يجب التخلص النهائي من هذا المنتج وفقاً لجميع القوانين واللوائح الوطنية.

警告! 本产品的废弃处理应根据所有国家的法律和规章进行。

警告! 本產品的廢棄處理應根據所有國家的法律和規章進行。

Advarsel! Dette produkt skal bortskaffes i henhold til alle nationale love og regler.

Waarschuwing! De uiteindelijke verwijdering van dit product dient te geschieden in overeenstemming met alle nationale wetten en voorschriften.

Varoitus! Tämän tuotteen lopullinen hävittäminen on suoritettava kaikkien kansallisten lakien ja määräysten mukaisesti.

Attention! La mise au rebut ou le recyclage de ce produit sont généralement soumis à des lois et/ou directives de respect de l'environnement. Renseignez-vous auprès de l'organisme compétent.

Warnung! Die endgültige Entsorgung dieses Produkts muss gemäß allen nationalen Gesetzen und Vorschriften erfolgen.

אזהרה! סילוק סופי של מוצר זה חייב להתבצע בהתאם לכל החוקים והתקנות הלאומיים.

चेतावनी! इस उत्पाद का अंतिम निपटान सभी राष्ट्रीय कानूनों और नियमों के अनुसार किया जाना चाहिए।

警告! この製品を廃棄処分する場合、国の関係する全ての法律・条例に従い処理する必要があります。

경고! 이 제품은 해당 국가의 관련 법규 및 규정에 따라 폐기되어야 합니다.

Advarsel! Når produktet til slutt skal kasseres, må det håndteres i henhold til alle nasjonale lover og forskrifter.

¡Advertencia! Al deshacerse por completo de este producto debe seguir todas las leyes y reglamentos nacionales.

Varning! Slutgiltigt bortskaffande av denna produkt ska ske i enlighet med alla nationella lagar och förordningar.