

SUPER ●[®]

C7Z270-PG

USER'S MANUAL

Revision 1.0a

The information in this User's Manual has been carefully reviewed and is believed to be accurate. The vendor assumes no responsibility for any inaccuracies that may be contained in this document, makes no commitment to update or to keep current the information in this manual, or to notify any person or organization of the updates. **Please Note: For the most up-to-date version of this manual, please see our web site at www.supermicro.com.**

Super Micro Computer, Inc. ("Supermicro") reserves the right to make changes to the product described in this manual at any time and without notice. This product, including software and documentation, is the property of Supermicro and/or its licensors, and is supplied only under a license. Any use or reproduction of this product is not allowed, except as expressly permitted by the terms of said license.

IN NO EVENT WILL SUPERMICRO BE LIABLE FOR DIRECT, INDIRECT, SPECIAL, INCIDENTAL, SPECULATIVE OR CONSEQUENTIAL DAMAGES ARISING FROM THE USE OR INABILITY TO USE THIS PRODUCT OR DOCUMENTATION, EVEN IF ADVISED OF THE POSSIBILITY OF SUCH DAMAGES. IN PARTICULAR, SUPERMICRO SHALL NOT HAVE LIABILITY FOR ANY HARDWARE, SOFTWARE, OR DATA STORED OR USED WITH THE PRODUCT, INCLUDING THE COSTS OF REPAIRING, REPLACING, INTEGRATING, INSTALLING OR RECOVERING SUCH HARDWARE, SOFTWARE, OR DATA.

Any disputes arising between manufacturer and customer shall be governed by the laws of Santa Clara County in the State of California, USA. The State of California, County of Santa Clara shall be the exclusive venue for the resolution of any such disputes. Super Micro's total liability for all claims will not exceed the price paid for the hardware product.

FCC Statement: This equipment has been tested and found to comply with the limits for a class B digital device, pursuant to Part 15 of the FCC Rules. These limits are designed to provide reasonable protection against harmful interference in a residential installation. This equipment generates, uses, and can radiate radio frequency energy and, if not installed and used in accordance with the instructions, may cause harmful interference to radio communications. However, there is no guarantee that interference will not occur in a particular installation. If this equipment does cause harmful interference to radio or television reception, which can be determined by turning the equipment off and on, the user is encouraged to try to correct the interference by one or more of the following measures:

- Reorient or relocate the receiving antenna.
- Increase the separation between the equipment and receiver.
- Connect the equipment to an outlet on a circuit different from that to which the receiver is connected.
- Consult the authorized dealer or an experienced radio/TV technician for help.

California Best Management Practices Regulations for Perchlorate Materials: This Perchlorate warning applies only to products containing CR (Manganese Dioxide) Lithium coin cells. "Perchlorate Material-special handling may apply. See www.dtsc.ca.gov/hazardouswaste/perchlorate"

WARNING: Handling of lead solder materials used in this product may expose you to lead, a chemical known to the State of California to cause birth defects and other reproductive harm.

Manual Revision 1.0a

Release Date: October 26, 2017

Unless you request and receive written permission from Super Micro Computer, Inc., you may not copy any part of this document.

Information in this document is subject to change without notice. Other products and companies referred to herein are trademarks or registered trademarks of their respective companies or mark holders.

Copyright © 2017 by Super Micro Computer, Inc. All rights reserved.

Printed in the United States of America

Preface

This manual is written for system integrators, PC technicians and knowledgeable PC users. It provides information for the installation and use of the **SUPER** C7270-PG motherboard.

Manual Organization

Chapter 1 describes the features, specifications and performance of the motherboard, and provides detailed information on the Intel Z270 Express chipset.

Chapter 2 provides hardware installation instructions. Read this chapter when installing the processor, memory modules and other hardware components into the system.

If you encounter any problems, see **Chapter 3**, which describes troubleshooting procedures for video, memory and system setup stored in the CMOS.

Chapter 4 includes an introduction to the BIOS, and provides detailed information on running the CMOS Setup utility.

Appendix A provides BIOS Error Beep Codes.

Appendix B lists software program installation instructions.

Appendix C contains UEFI BIOS Recovery instructions.

Appendix D contains an introduction and instructions regarding the Dual Boot Block feature of this motherboard.

Appendix E provides instructions of the use of multiple Graphics Processing Units (GPUs).

Appendix F states instructions regarding the M.2/U.2 RAID configuration.

Checklist

Congratulations on purchasing your computer motherboard from an acknowledged leader in the industry. Supermicro boards are designed with the utmost attention to detail to provide you with the highest standards in quality and performance.

Please check that the following items have all been included with your motherboard. If anything listed here is damaged or missing, contact your retailer.

The following items are included in the retail box:

- One (1) Supermicro Motherboard
- Six (6) SATA cables
- One (1) I/O shield
- One (1) Quick Reference Guide
- One (1) Driver CD

Conventions Used in the Manual

Special attention should be given to the following symbols for proper installation and to prevent damage done to the components or injury to yourself:



Attention! Critical information to prevent damage to the components or injury to yourself.



Important: Important information given to ensure proper system installation or to relay safety precautions.



Note: Additional Information given to differentiate various models or provides information for correct system setup.

Standardized Warning Statements

The following statements are industry-standard warnings, provided to warn the user of situations which have the potential for bodily injury. Should you have questions or experience difficulty, contact Supermicro's Technical Support department for assistance. Only certified technicians should attempt to install or configure components.

Read this section in its entirety before installing or configuring components in the Supermicro chassis.

Battery Handling



Warning!

There is a danger of explosion if the battery is replaced incorrectly. Replace the battery only with the same or equivalent type recommended by the manufacturer. Dispose of used batteries according to the manufacturer's instructions

電池の取り扱い

電池交換が正しく行われなかった場合、破裂の危険性があります。交換する電池はメーカーが推奨する型、または同等のものを使用下さい。使用済電池は製造元の指示に従って処分して下さい。

警告

電池更換不當會有爆炸危險。請只使用同類電池或制造商推薦的功能相當的電池更換原有電池。請按製造商的說明處理廢舊電池。

警告

電池更換不當會有爆炸危險。請使用製造商建議之相同或功能相當的電池更換原有電池。請按照製造商的說明指示處理廢棄舊電池。

Warnung

Bei Einsetzen einer falschen Batterie besteht Explosionsgefahr. Ersetzen Sie die Batterie nur durch den gleichen oder vom Hersteller empfohlenen Batterietyp. Entsorgen Sie die benutzten Batterien nach den Anweisungen des Herstellers.

Attention

Danger d'explosion si la pile n'est pas remplacée correctement. Ne la remplacer que par une pile de type semblable ou équivalent, recommandée par le fabricant. Jeter les piles usagées conformément aux instructions du fabricant.

iAdvertencia!

Existe peligro de explosión si la batería se reemplaza de manera incorrecta. Reemplazar la batería exclusivamente con el mismo tipo o el equivalente recomendado por el fabricante. Desechar las baterías gastadas según las instrucciones del fabricante.

אזהרה!

קיימת סכנת פיצוץ של הסוללה במידה והוחלפה בדרך לא תקינה. יש להחליף את הסוללה בסוג התואם מחברת יצרן מומלצת.

סילוק הסוללות המשומשות יש לבצע לפי הוראות היצרן.

هناك خطر من انفجار في حالة استبدال البطارية بطريقة غير صحيحة فعليك استبدال البطارية فقط بنفس النوع أو ما يعادلها كما أوصت به الشركة المصنعة تخلص من البطاريات المستعملة وفقا لتعليمات الشركة الصانعة

경고!

배터리가 올바르게 교체되지 않으면 폭발의 위험이 있습니다. 기존 배터리와 동일하거나 제조사에서 권장하는 동등한 종류의 배터리로만 교체해야 합니다. 제조사의 안내에 따라 사용된 배터리를 처리하여 주십시오.

Waarschuwing

Er is ontploffingsgevaar indien de batterij verkeerd vervangen wordt. Vervang de batterij slechts met hetzelfde of een equivalent type die door de fabrikant aanbevolen wordt. Gebruikte batterijen dienen overeenkomstig fabrieksvoorschriften afgevoerd te worden.

Product Disposal



Warning!

Ultimate disposal of this product should be handled according to all national laws and regulations.

製品の廃棄

この製品を廃棄処分する場合、国の関係する全ての法律・条例に従い処理する必要があります。

警告

本产品的废弃处理应根据所有国家的法律和规章进行。

警告

本產品的廢棄處理應根據所有國家的法律和規章進行。

Warnung

Die Entsorgung dieses Produkts sollte gemäß allen Bestimmungen und Gesetzen des Landes erfolgen.

iAdvertencia!

Al deshacerse por completo de este producto debe seguir todas las leyes y reglamentos nacionales.

Attention

La mise au rebut ou le recyclage de ce produit sont généralement soumis à des lois et/ou directives de respect de l'environnement. Renseignez-vous auprès de l'organisme compétent.

סילוק המוצר

אזהרה!

סילוק סופי של מוצר זה חייב להיות בהתאם להנחיות וחוקי המדינה.

عند التخلص النهائي من هذا المنتج ينبغي التعامل معه وفقا لجميع القوانين واللوائح الوطنية

경고!

이 제품은 해당 국가의 관련 법규 및 규정에 따라 폐기되어야 합니다.

Waarschuwing

De uiteindelijke verwijdering van dit product dient te geschieden in overeenstemming met alle nationale wetten en reglementen.

Contacting Supermicro

Headquarters

Address: Super Micro Computer, Inc.
980 Rock Ave.
San Jose, CA 95131 U.S.A.

Tel: +1 (408) 503-8000

Fax: +1 (408) 503-8008

Email: marketing@supermicro.com (General Information)
support@supermicro.com (Technical Support)

Web Site: www.supermicro.com

Europe

Address: Super Micro Computer B.V.
Het Sterrenbeeld 28, 5215 ML
's-Hertogenbosch, The Netherlands

Tel: +31 (0) 73-6400390

Fax: +31 (0) 73-6416525

Email: sales@supermicro.nl (General Information)
support@supermicro.nl (Technical Support)
rma@supermicro.nl (Customer Support)

Web Site: www.supermicro.nl

Asia-Pacific

Address: Super Micro Computer, Inc.
3F, No. 150, Jian 1st Rd.
Zhonghe Dist., New Taipei City 235
Taiwan (R.O.C)

Tel: +886-(2) 8226-3990

Fax: +886-(2) 8226-3992

Email: support@supermicro.com.tw

Web Site: www.supermicro.com.tw

Where to Find More Information

For your system to work properly, please follow the links below to download all necessary drivers/utilities and the user's manual for your motherboard.

Supermicro product manuals: <http://www.supermicro.com/support/manuals/>

Product Drivers and utilities: <ftp://ftp.supermicro.com/>

If you have any questions, please contact our support team at support@supermicro.com.

Table of Contents

Preface

Manual Organization	iii
Checklist	iv
Conventions Used in the Manual	iv
Standardized Warning Statements	v
Battery Handling.....	v
Product Disposal.....	vi
Contacting Supermicro.....	viii
Where to Find More Information.....	ix

Chapter 1 Introduction

1-1 Overview	1-1
About this Motherboard	1-1
1-2 Chipset Overview	1-1
Intel Z270 Express Chipset Features	1-1
1-3 Motherboard Features	1-2
1-4 Special Features	1-4
Recovery from AC Power Loss	1-4
1-5 PC Health Monitoring.....	1-4
Fan Status Monitor with Firmware Control	1-4
Environmental Temperature Control	1-4
System Resource Alert	1-5
1-6 ACPI Features	1-5
Slow Blinking LED for Suspend-State Indicator.....	1-5
1-7 Power Supply	1-6
1-8 Super I/O	1-6

Chapter 2 Installation

2-1 Installation Components and Tools Needed	2-1
2-2 Static-Sensitive Devices.....	2-2
Precautions	2-2
Unpacking.....	2-2
2-3 Processor and Heatsink Installation.....	2-3
Installing the LGA1151 Processor	2-3
Installing an Active CPU Heatsink with Fan	2-6
Removing the Heatsink.....	2-8
2-4 Installing DDR4 Memory	2-9
DIMM Installation	2-9

Removing Memory Modules.....	2-9
Memory Support.....	2-10
Memory Population Guidelines.....	2-11
2-5 Motherboard Installation.....	2-12
Tools Needed.....	2-12
Location of Mounting Holes.....	2-12
Installing the Motherboard.....	2-13
2-6 Connectors/IO Ports.....	2-14
Back I/O Panel.....	2-14
Universal Serial Bus (USB).....	2-15
Ethernet Port.....	2-16
Back Panel High Definition Audio (HD Audio).....	2-16
ATX PS/2 Keyboard/Mouse Ports.....	2-17
VESA® DisplayPort™.....	2-17
HDMI Port.....	2-17
Front Control Panel.....	2-18
Front Control Panel Pin Definitions.....	2-19
Power LED.....	2-19
HDD LED.....	2-19
NIC1 (LAN).....	2-19
NIC2 (LAN).....	2-19
Reset Button.....	2-20
Power Button.....	2-20
Overheat (OH)/Fan Fail.....	2-20
2-7 Connecting Cables.....	2-21
ATX Main PWR & CPU PWR Connectors (JPW1 & JPW2).....	2-21
Fan Headers (Fan 1 - Fan 5).....	2-22
Chassis Intrusion (JL1).....	2-22
Internal Buzzer (SP1).....	2-23
Speaker (JD1).....	2-23
Onboard Power LED (JLED1).....	2-24
Serial Port (COM1).....	2-24
DOM PWR Connector (JSD1).....	2-25
SPDIF OUT (JSPDIF_OUT).....	2-25
Standby Power Header (JSTBY1).....	2-26
PCI-E M.2 Connector (PCI-E M.2).....	2-26
Front Panel Audio Header (AUDIO FP).....	2-27
TPM Header/Port 80.....	2-27
Thunderbolt Connector.....	2-28

2-8	Jumper Settings	2-29
	Explanation of Jumpers	2-29
	LAN Enable/Disable	2-29
	Clear CMOS & JBT1	2-30
	PCI Slot SMB Enable (I ² C1/I ² C2)	2-30
	Manufacturing Mode (JPME2)	2-31
	Audio Enable (JPAC1)	2-31
	Watch Dog Timer Enable/Disable	2-31
	BIOS Recovery (JBR1)	2-32
	Power Button (POWER BUTTON)	2-32
	Reset Button	2-32
2-9	Onboard Indicators	2-33
	LAN LEDs	2-33
	Onboard Power LED (LED1)	2-33
	Status Display (LED4)	2-34
2-10	Hard Drive Connections	2-35
	SATA Connections (I-SATA0~I-SATA5)	2-35
	U.2 SSD Connectors	2-35

Chapter 3 Troubleshooting

3-1	Troubleshooting Procedures	3-1
	Before Power On	3-1
	No Power	3-1
	No Video	3-2
	Memory Errors	3-2
	When the System is Losing the Setup Configuration	3-2
3-2	Technical Support Procedures	3-3
3-3	Frequently Asked Questions	3-4
3-4	Battery Removal and Installation	3-5
	Battery Removal	3-5
	Proper Battery Disposal	3-5
3-5	Returning Motherboard for Service	3-6
	Battery Installation	3-6

Chapter 4 BIOS

4-1	Introduction	4-1
	Starting BIOS GUI Setup Utility	4-1
	How To Change the Configuration Data	4-2
	How to Start the Setup Utility	4-2
4-2	System Information	4-3

	System Date	4-3
	System Time	4-3
4-3	CPU	4-4
	CPU OverClocking	4-5
	BCLK Clock Frequency (1/100 MHz)	4-5
	FCLK Frequency for Early Power On	4-5
	Active Processor Cores.....	4-5
	Load SMC CPU OC Setting.....	4-6
	1-Core Ratio Limit Override.....	4-6
	2-Core Ratio Limit Override.....	4-6
	3-Core Ratio Limit Override.....	4-6
	4-Core Ratio Limit Override.....	4-6
	BCLK Aware Adaptive Voltage.....	4-6
	Boot performance mode.....	4-6
	Intel(R) SpeedStep(tm)	4-7
	Turbo Mode	4-7
	Configurable TDP Boot Mode	4-7
	Configurable TDP Lock.....	4-7
	Power Limit 1 Override	4-7
	Power Limit 1	4-7
	Power Limit 1 Time Window	4-7
	Power Limit 2 Override	4-8
	Power Limit 2	4-8
	Power Limit 3 Override	4-8
	Power Limit 4 Override	4-8
	CPU Flex Ratio Override.....	4-8
	CPU Flex Ratio Settings	4-8
	Core Max OC Ratio.....	4-8
	System Agent Voltage (mV)	4-8
	Core Voltage Mode.....	4-8
	SVID	4-9
	Core Voltage Override.....	4-9
	Core Extra Turbo Voltage	4-9
	Core Voltage Offset	4-9
	Offset Prefix	4-9
	Core PLL Voltage Offset	4-9
	Ring Max OC Ratio	4-9
	Ring Min OC Ratio.....	4-9
	Uncore Voltage Offset.....	4-10

PCH Voltage	4-10
CPU PLL Voltage	4-10
CPU_IO Voltage	4-10
Load Line Calibration	4-10
CPU Configuration.....	4-10
Active Processor Cores.....	4-11
Hyper-Threading	4-11
TXT support	4-11
Alias Check Request	4-11
Reset AUX Content.....	4-11
FCLK Frequency for Early Power On	4-11
*If Advanced Option (on page 4-4) is set to Enabled (Checked), the following information will appear.....	4-11
C6DRAM	4-12
SW Guard Extension (SGX)	4-12
Select Owner EPOCH input type.....	4-12
PRMRR Size	4-12
Hardware Prefetcher	4-12
Adjacent Cache Line Prefetch	4-12
Intel (VMX) Virtualization Technology	4-13
BIST.....	4-13
AES.....	4-13
Machine Check.....	4-13
MonitorMWait.....	4-13
CPU SMM Enhancement.....	4-13
SMM Code Access Check.....	4-13
SMM Use Delay Indication.....	4-13
SMM Use Block Indication	4-13
Power and Performance.....	4-14
CPU - Power Management Control	4-14
Boot performance mode.....	4-14
Intel(R) SpeedStep(tm)	4-14
C States	4-14
Enhanced C-states	4-14
C-State Auto Demotion.....	4-15
C-State Un-demotion	4-15
Package C-State Demotion	4-15
Package C-State Un-Demotion	4-15
Package C State Limit.....	4-15

	Package C State Workaround.....	4-15
	GT - Power Management Control	4-16
4-4	Memory	4-17
	Memory profile	4-17
	Memory Reference Clock	4-17
	QCLK Odd Ratio	4-18
	Memory Frequency	4-18
	Memory Voltage	4-18
	Memory Scrambler	4-18
	Force ColdReset	4-18
	Force Single Rank	4-18
	MRC Fast Boot	4-19
	Memory OverClocking.....	4-19
	Memory Profile	4-19
	Memory Reference Clock	4-20
	QCLK Odd Ratio	4-20
	Memory Frequency	4-20
	Memory Voltage	4-20
	3rd timing:	4-21
4-5	Advanced.....	4-26
	Boot Feature	4-26
	Fast Boot	4-26
	Quiet Boot	4-26
	Bootup Num-Lock	4-26
	Wait for "F1" If Error	4-26
	Re-try Boot	4-27
	Watch Dog Function	4-27
	Power Button Function.....	4-27
	AC Loss Policy Depend On.....	4-27
	EuP Support	4-27
	SuperIO Chip NCT6792D.....	4-28
	Serial Port 1 Configuration	4-28
	Serial Port.....	4-28
	Device Settings.....	4-28
	Change Settings	4-28
	COM 1	4-29
	Console Redirection	4-29
	System Agent (SA) Configuration.....	4-32
	VT-d	4-34

GMM Device (B0:D8:F0)	4-34
X2APIC Opt Out	4-34
Graphics Configuration	4-34
Graphics Turbo IMON Current	4-34
Skip Scanning of External Gfx Card	4-34
Primary Display	4-35
Select PCIE Card	4-35
External Gfx Card Primary Display Configuration	4-35
Internal Graphics	4-35
GTT Size	4-35
Aperture Size	4-35
DVMT Pre-Allocated	4-35
DVMT Total Gfx Mem	4-36
Gfx Low Power Mode	4-36
VDD Enable	4-36
HDCP Support	4-36
Algorithm	4-36
PM Support	4-36
PAVP Enable	4-36
Cdynmax Clamping Enable	4-36
Graphics Clock Frequency	4-36
GT-UnSliced VR Settings	4-38
GT-Sliced VR Settings	4-40
PCH-IO Configuration	4-43
SATA and RST Configuration	4-44
SATA Controller(s)	4-44
SATA Mode Selection	4-44
SATA Controller Speed	4-44
SATA Frozen	4-44
Serial ATA Port	4-45
Hot Plug	4-45
Configured as eSATA	4-45
Spin Up Device	4-45
SATA Device Type	4-45
PCH-FW Configuration	4-46
ME FW Image Re-Flash	4-46
USB Configuration	4-47
Legacy USB Support	4-47
XHCI Hand-Off	4-47

	PCIe/PCI/PnP Configuration.....	4-48
	Security.....	4-50
	Administrator Password.....	4-50
	User Password	4-50
	Secure Boot	4-51
	Attempt Secure Boot	4-51
	Secure Boot Mode.....	4-51
	CSM Support.....	4-51
	Key Management (Available when Secure Boot Mode is set to 'Customized')	4-52
	Provision Factory Default Keys.....	4-52
	Install Factory Default Keys.....	4-52
	Enroll Efi Image.....	4-52
	Save All Secure Boot Variables	4-52
	Platform Key (PK)	4-52
	Key Exchange Keys	4-53
	Authorized Signatures.....	4-53
	Forbidden Signatures.....	4-53
	Authorized TimeStamps	4-54
	OsRecovery Signatures	4-54
4-6	Thermal & Fan.....	4-55
	Fan Control	4-55
	Fan Control	4-55
	System Temperature	4-55
	System Health.....	4-56
4-7	Save & Exit.....	4-57
	Boot mode select	4-57
	FIXED BOOT ORDER Priorities.....	4-57
	Legacy Boot Option #1~#8.....	4-57
	NETWORK Drive BBS Priorities.....	4-57
	Boot Option #1.....	4-57
	Boot Override	4-57
	Launch EFI Shell from filesystem device	4-58
4-8	BIOS Update	4-60
	Start Update	4-60

Appendix A BIOS Error Beep Codes

A-1 BIOS Error Beep Codes A-1

Appendix B Software Installation Instructions

B-1 Installing Drivers B-1
B-2 Configuring SuperDoctor® V B-2
B-3 Using SuperDoctor® V to Update the BIOS..... B-3

Appendix C UEFI BIOS Recovery Instructions

C-1 An Overview to the UEFI BIOS C-1
C-2 How to Recover the UEFI BIOS Image (-the Main BIOS Block) C-1
C-3 To Recover the Main BIOS Block Using a USB-Attached Device.... C-2

Appendix D Dual Boot Block

D-1 Introduction D-1
 BIOS Boot Block D-1
 BIOS Boot Block Corruption Occurrence D-1
D-2 Steps to Reboot the System by switch JBR1 D-2

Appendix E Use of Multiple GPUs

E-1 DirectX® 12..... E-1

Appendix F M.2/U.2 RAID Configuration

F-1 Configuring the RAID Setting F-1
F-2 Installing the Windows® 10 OS..... F-5

Chapter 1

Introduction

1-1 Overview

About this Motherboard

The C7Z270-PG motherboard supports a single 7th Generation Intel® Core™ i7/i5/i3 processors in an LGA 1151 (H4) socket. With the Intel® Z270 Express chipset built in, the C7Z270-PG motherboard offers substantial system performance and storage capability for overclocking platforms in a sleek package. Please refer to our website (<http://www.supermicro.com/products/>) for processor and memory support updates.

1-2 Chipset Overview

Intel Z270 Express Chipset Features

- Direct Media Interface (up to 10 Gb/s transfer, Full Duplex)
- Intel® Matrix Storage Technology and Intel Rapid Storage Technology
- Dual NAND Interface
- Intel I/O Virtualization (VT-d) Support
- Intel Trusted Execution Technology Support
- PCI Express 3.0 Interface (up to 8 GT/s)
- SATA Controller (up to 6Gb/sec)
- Advanced Host Controller Interface (AHCI)

1-3 Motherboard Features

CPU	Single Intel Core i3/i5/i7 7th generation processor in an LGA1151 type socket.	
Memory	Four (4) slots support up to 64GB of unbuffered, non-ECC, 3600MHz (OC) DDR4 memory	
	Dual-channel memory	
	DIMM sizes	
	Up to 64GB at 1.2V	
Chipset	Intel® Z270	
Expansion Slots	Four (4) PCI-E 3.0 X16 slots	
	One (1) PCI-E 3.0 X4 (for Thunderbolt AIC support)	
	Two (2) M.2 slots	
Network Connections	Two (2) Gigabit Ethernet LAN ports Intel i219v+ i210	
I/O Devices	Hard Drive Connections	
	SATA 3.0 (6Gb/s)	Six (6) I-SATA 0~5, via Intel Z270
		RAID 0, 1, 5, 10
	U.2 Connectors	Two (2) U.2 Connectors for 2.5" SSD Drives
	USB Devices	
	One (1) USB 3.1 Type C (Rear), Three (3) USB 3.1 Type A (Rear), Four (4) USB 3.0 x4 (2x Rear, 2x Header), Eight (8) USB 2.0 (2x Rear, 6x Header)	
	Keyboard/Mouse	
	One shared PS/2 Keyboard/Mouse port on the I/O backpanel	
	Other I/O Ports	
	One (1) DisplayPort, One (1) HDMI Port One (1) Serial Port header (COM1)	
	Audio	
One (1) High Definition Audio 7.1 channel connector supported by Realtek ALC1150 on the back panel		
One (1) Front Panel Audio Header		
One (1) S/PDIF Out on the rear side of the chassis		
Super I/O		
Nuvoton NCT6792D-B		

BIOS	256 Mb AMI BIOS® SPI Flash BIOS
	Plug and Play (PnP), ACPI 3.0, SYMBIOS 2.7, BIOS rescue hot-key, SPI dual/quad speed support, Over-clock support, and Dual-Boot Block
Power Configuration	ACPI Power Management (S3, S4, S5)
	Power Button Override Mechanism
	Internal/External Modem Ring-On
	Power-on mode for AC power recovery
Health Monitoring	CPU Monitoring
	Onboard monitors: +1.8V, +3.3V, +5V, +/- 12V, +3.3V Stby, +5V Stby, VBAT, HT, Memory PCH Temperature, System Temperature, and Memory Temperature
	CPU 6-phase switching voltage regulator
	CPU/System overheat LED and control
	CPU Thermal Trip support
	Fan Control
	Fan status monitoring with firmware 4-pin fan speed control
	Low noise fan speed control
System Management	PECI (Platform Environment Configuration Interface) 2.0 support
	System resource alert via SuperDoctor® 5
	SuperDoctor 5, NMI
	SUM-InBand (Supermicro Update Manager)
	Chassis Intrusion header and detection
CD Utilities	BIOS flash upgrade utility
	Drivers and software for Intel® Z270 Express chipset utilities
Other	ROHS 6/6 (Full Compliance, Lead Free)
Dimensions	ATX form factor (9.6" x 12.0") (243.84 mm x 304.8 mm)

1-4 Special Features

Recovery from AC Power Loss

Basic I/O System (BIOS) provides a setting for you to determine how the system will respond when AC power is lost and then restored to the system. You can choose for the system to remain powered off, (in which case you must press the power switch to turn it back on), or for it to automatically return to a power-on state. See the Advanced BIOS Setup section to change this setting. The default setting is **Last State**.

1-5 PC Health Monitoring

This section describes the PC health monitoring features of the board. All have an onboard System Hardware Monitoring chip that supports PC health monitoring. An onboard voltage monitor will scan these onboard voltages continuously: +1.8V, +3.3V, +5V, +/- 12V, +3.3V Stby, +5V Stby, VBAT, HT, Memory PCH Temperature, System Temperature, and Memory Temperature. Once a voltage becomes unstable, a warning is given, or an error message is sent to the screen. The user can adjust the voltage thresholds to define the sensitivity of the voltage monitor.

Fan Status Monitor with Firmware Control

PC health monitoring in the BIOS can check the RPM status of the cooling fans. The onboard CPU and chassis fans are controlled by Thermal Management via SIO.

Environmental Temperature Control

The thermal control sensor monitors the CPU temperature in real time and will turn on the thermal control fan whenever the CPU temperature exceeds a user-defined threshold. The overheat circuitry runs independently from the CPU. Once the thermal sensor detects that the CPU temperature is too high, it will automatically turn on the thermal fans to prevent the CPU from overheating. The onboard chassis thermal circuitry can monitor the overall system temperature and alert the user when the chassis temperature is too high.



Note: To avoid possible system overheating, please be sure to provide adequate airflow to your system.

System Resource Alert

This feature is available when the system is used with SuperDoctor V in the Windows and Linux operating systems. SuperDoctor is used to notify the user of certain system events. For example, you can also configure SuperDoctor to provide you with warnings when the system temperature, CPU temperatures, voltages and fan speeds go beyond predefined thresholds.

1-6 ACPI Features

ACPI stands for Advanced Configuration and Power Interface. The ACPI specification defines a flexible and abstract hardware interface that provides a standard way to integrate power management features throughout a PC system, including its hardware, operating system and application software. This enables the system to automatically turn on and off peripherals such as CD-ROMs, network cards, hard disk drives and printers.

In addition to enabling operating system-directed power management, ACPI also provides a generic system event mechanism for Plug and Play, and an operating system-independent interface for configuration control. ACPI leverages the Plug and Play BIOS data structures, while providing a processor architecture-independent implementation that is compatible with Windows 7, Windows 8, and Windows 2008 Operating Systems.

Slow Blinking LED for Suspend-State Indicator

When the CPU goes into a suspend state, the chassis power LED will start to blink to indicate that the CPU is in suspend mode. When the user presses any key, the CPU will "wake up," and the LED will automatically stop blinking and remain on.

1-7 Power Supply

As with all computer products, a stable power source is necessary for proper and reliable operation. It is even more important for processors that have high CPU clock rates.

This motherboard accommodates 24-pin ATX power supplies. Although most power supplies generally meet the specifications required by the CPU, some are inadequate. In addition, the 12V 8-pin power connector located at JPW2 is also required to ensure adequate power supply to the system. Also your power supply must supply 1.5A for the Ethernet ports.

! Attention! To prevent damage to the power supply or motherboard, please use a power supply that contains a 24-pin and a 8-pin power connectors. Be sure to connect these connectors to the 24-pin (JPW1) and the 8-pin (JPW2) power connectors on the motherboard.

It is strongly recommended that you use a high quality power supply that meets ATX power supply Specification 2.02 or above. It must also be SSI compliant. (For more information, please refer to the web site at <http://www.ssiforum.org/>). Additionally, in areas where noisy power transmission is present, you may choose to install a line filter to shield the computer from noise. It is recommended that you also install a power surge protector to help avoid problems caused by power surges.

1-8 Super I/O

The Super I/O supports two high-speed, 16550 compatible serial communication ports (UARTs). Each UART includes a 16-byte send/receive FIFO, a programmable baud rate generator, complete modem control capability and a processor interrupt system. Both UARTs provide legacy speed with baud rate of up to 115.2 Kbps as well as an advanced speed with baud rates of 250 K, 500 K, or 1 Mb/s, which support higher speed modems.

The Super I/O provides functions that comply with ACPI (Advanced Configuration and Power Interface), which includes support of legacy and ACPI power management through an SMI or SCI function pin. It also features auto power management to reduce power consumption.

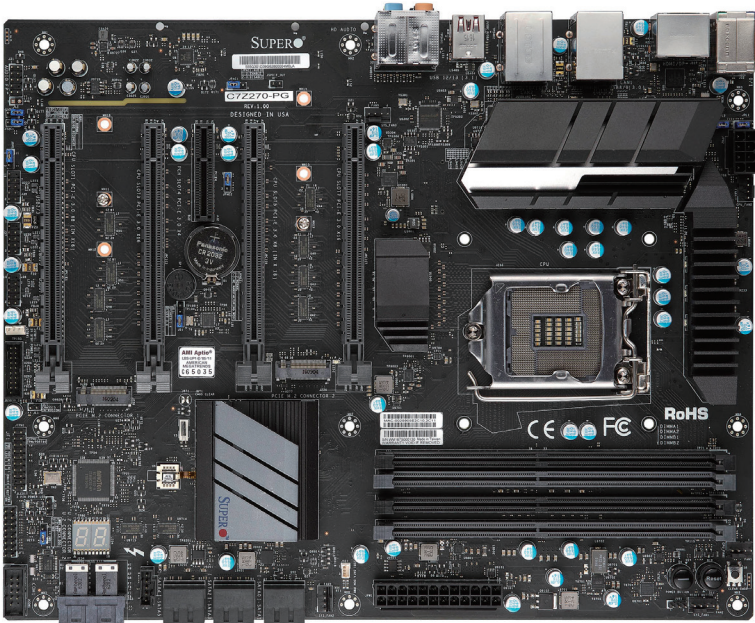
C7Z170-PG Motherboard Image

Note: All graphics shown in this manual were based upon the latest PCB Revision available at the time of publishing of the manual. The motherboard you've received may or may not look exactly the same as the graphics shown in this manual.

C7Z270-PG Motherboard Layout

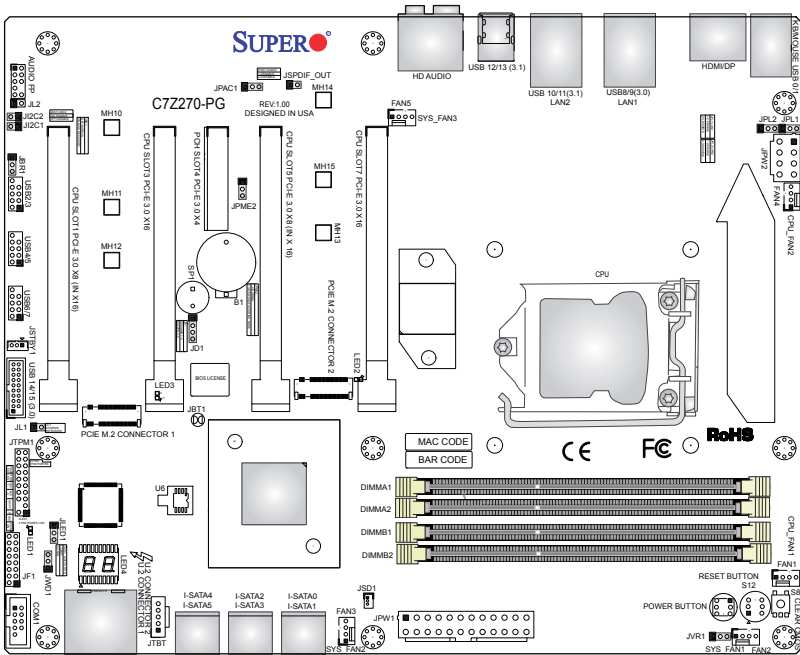

Important Notes to the User

- See Chapter 2 for detailed information on jumpers, I/O ports and JF1 front panel connections.
- "■" indicates the location of "Pin 1".
- Jumpers not indicated are for testing only.
- When LED1 (Onboard Power LED Indicator) is on, system power is on. Unplug the power cable before installing or removing any components.

C7Z270-PG Block Diagram

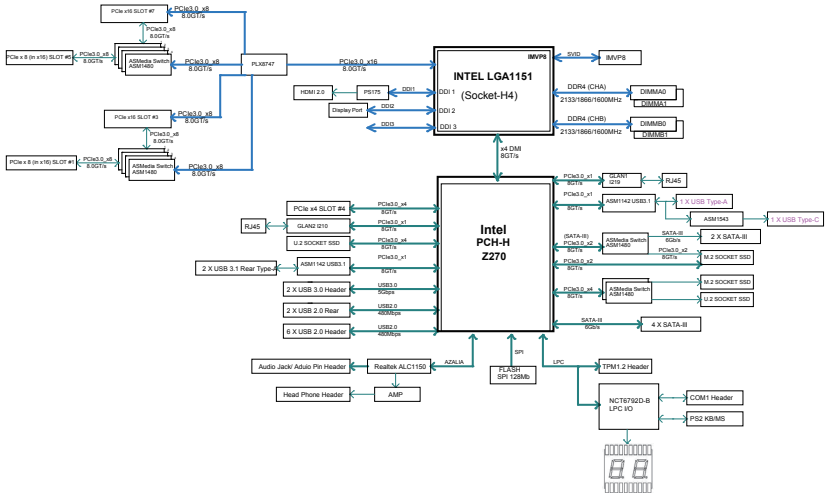

C7Z270-PG Quick Reference

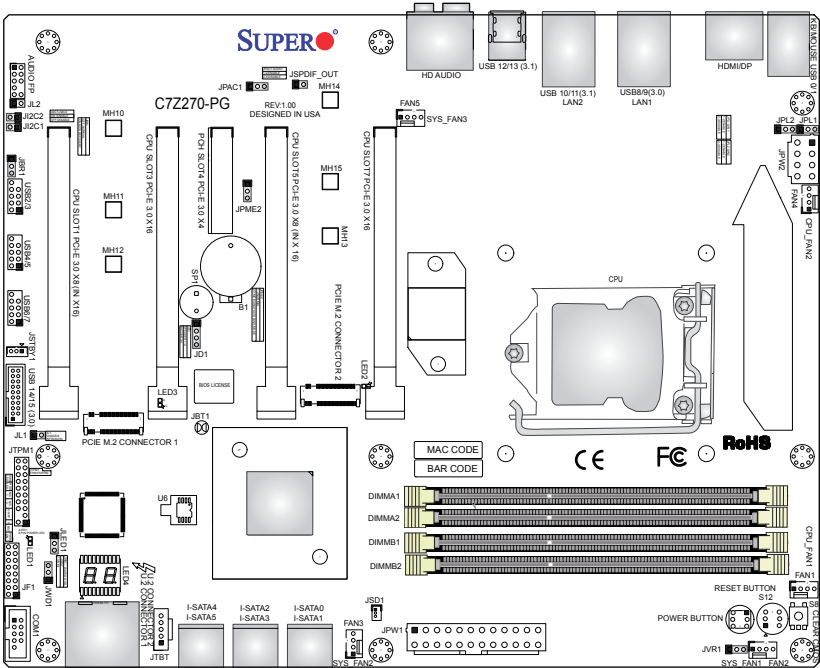

Jumper	Description	Default
CLEAR CMOS	Clear CMOS Switch	Push Button Switch
JBR1	BIOS Recovery Switch	Pins 1-2 (Disable)
JBT1	Clear CMOS (on board)	Short pads to clear CMOS
JI2C1/JI2C2	SMB to PCI Slots	Open (Disable)
JPAC1	Audio Enable	Pins 1-2 (Enabled)
JPL2	LAN3/LAN4 Enable/Disable	Pins 1-2 (Enabled)
JPME2	Intel® Manufacturing Mode	Pins 1-2 (Normal)
JWD1	Watch Dog Function Enable	Pins 1-2 (RST)
POWER BUTTON	Internal Power Button	Push Button Switch
RESET BUTTON	Onboard System Reset Button	Push Button Switch

Connector	Description
AUDIO FP	Front Panel Audio Header
B1	Onboard Battery
COM1	COM1 Port Header
FANS 1-5	System/CPU Fan Headers (Fan 1, Fan 4: CPU Fans; Fan 2, Fan 3, Fan 5: System Fans)
HD Audio	High Definition Audio Ports
HDMI/DP	High Definition Multimedia Interface/Display Port
I-SATA0~5	(Intel® Z270) Serial ATA (SATA 3.0) Ports 0~5 (6Gb/sec)
JD1	Speaker/buzzer (Pins 1~4: External Speaker, Pins 3~4: Buzzer)
JF1	Front Control Panel Header
JL1	Chassis Intrusion Header
JLED1	Power LED Indicator Header
JPW1	24-pin ATX Main Power Connector (Required)
JPW2	+12V 8-pin CPU power Connector (Required)
JSD1	SATA DOM (Disk On Module) Power Connector
JSPDIF_OUT	Sony/Philips Digital Interface Format (S/PDIF) Out Header
JSTBY1	Standby Power Header
JTBT	Thunderbolt Connector
JTPM1	Trusted Platform Module (TPM) Header
KB/MOUSE	PS2 Keyboard/Mouse Connectors
LAN1/LAN2	RJ45 Gigabit LAN Ports
MH 10-12	Mounting holes for PCI-E M.2 Connector 1
MH 13-15	Mounting holes for PCI-E M.2 Connector 2
PCI-E M.2 CONNECTOR 1, 2	PCI-E M.2 Connectors 1 and 2, small form factor devices and other portable devices for High speed NVMe SSDs
Slot 3/7	CPU PCI-E 3.0 x16 Slots
Slot 1/5	CPU PCI-E 3.0 x8 (IN x16) Slots
Slot 4	PCH PCI-E 3.0 x4
SP1	Internal Speakers
U.2 CONNECTOR 1, 2	U.2 Connector 1 and 2, for 2.5" SSD Drives

USB 0/1	Back Panel USB 2.0 Ports
USB 2/3, USB 4/5, USB 6/7	Front Panel Accessible USB 2.0 Headers
USB 8/9	Back Panel USB 3.0 Ports
USB 10/11, USB 12/13	Back Panel USB 3.1 Ports
USB 14/15	Front Panel Accessible USB 3.0 Header

LED	Description	Color/State	Status
LED1	Onboard Standby PWR LED	Green: Solid on	Power On
LED2	M.2 connector 2 SSD ACT LED	Green: Solid on	M.2 device connected
LED3	M.2 connector 1 SSD ACT LED	Green: Solid on	M.2 device connected
LED4	Status Code LED*	Digital Readout	See manual

*Download the AMI status codes at https://www.supermicro.com.tw/manuals/other/AMI_BIOS_POST_Codes_for_Grantley_Motherboards.pdf.

Chapter 2

Installation

2-1 Installation Components and Tools Needed

Screws

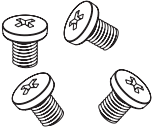

Phillips-Head Screwdriver

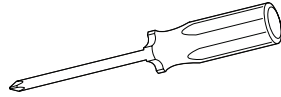

Intel LGA 1151 Processor

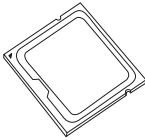

DDR4 DIMMs

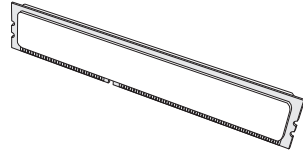

PC Chassis



Heatsink with Fan

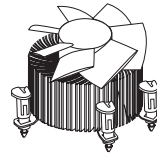

Power Supply

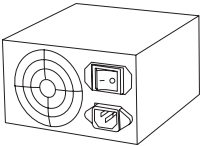

Video Card (Optional)

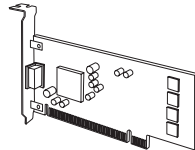

SATA/USB Optical Drive (Optional)

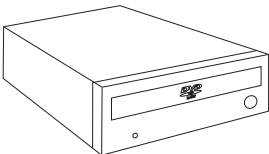

SATA Hard Disk Drive

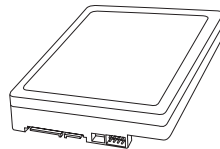

2-2 Static-Sensitive Devices

Electrostatic-Discharge (ESD) can damage electronic components. To avoid damaging your system board, it is important to handle it very carefully. The following measures are generally sufficient to protect your equipment from ESD.

Precautions

- Use a grounded wrist strap designed to prevent static discharge.
- Touch a grounded metal object before removing the board from the antistatic bag.
- Handle the board by its edges only; do not touch its components, peripheral chips, memory modules or gold contacts.
- When handling chips or modules, avoid touching their pins.
- Put the motherboard and peripherals back into their antistatic bags when not in use.
- For grounding purposes, make sure your computer chassis provides excellent conductivity between the power supply, the case, the mounting fasteners and the motherboard.
- Use only the correct type of onboard CMOS battery. Do not install the onboard battery upside down to avoid possible explosion.

Unpacking

The motherboard is shipped in antistatic packaging to avoid static damage. When unpacking the board, make sure that the person handling it is static protected.

2-3 Processor and Heatsink Installation

! **Attention!** When handling the processor package, avoid placing direct pressure on the label area of the fan.



Important:

Always connect the power cord last, and always remove it before adding, removing or changing any hardware components. Make sure that you install the processor into the CPU socket before you install the CPU heatsink.

If you buy a CPU separately, make sure that you use an Intel-certified multi-directional heatsink only.

Make sure to install the system board into the chassis before you install the CPU heatsink.

When receiving a server board without a processor pre-installed, make sure that the plastic CPU socket cap is in place and none of the socket pins are bent; otherwise, contact your retailer immediately.

Refer to the Supermicro website for updates on CPU support.

Installing the LGA1151 Processor

1. Press the load lever to release the load plate, which covers the CPU socket, from its locking position.

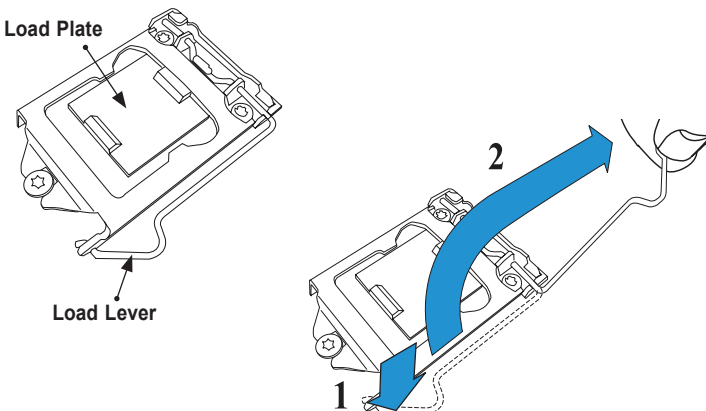

2. Gently lift the load lever to open the load plate. Remove the plastic cap.

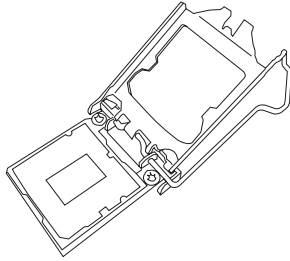

3. Use your thumb and your index finger to hold the CPU at the North center edge and the South center edge of the CPU.

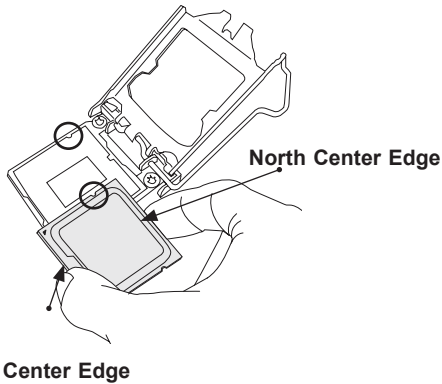

4. Align the CPU key that is the semi-circle cutouts against the socket keys. Once it is aligned, carefully lower the CPU straight down into the socket. Do not drop the CPU on the socket. Do not move the CPU horizontally or vertically.

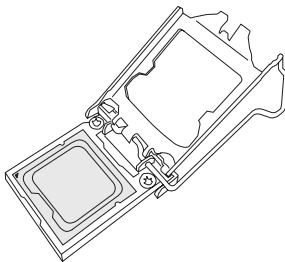

5. Do not rub the CPU against the surface or against any pins of the socket to avoid damaging the CPU or the socket.

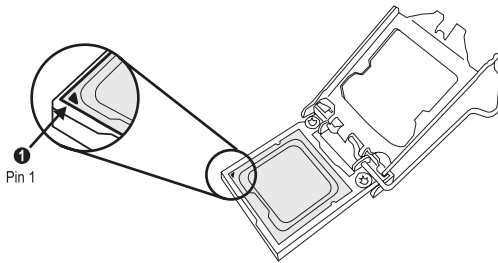

6. With the CPU inside the socket, inspect the four corners of the CPU to make sure that the CPU is properly installed.
7. Use your thumb to gently push the load lever down to the lever lock.

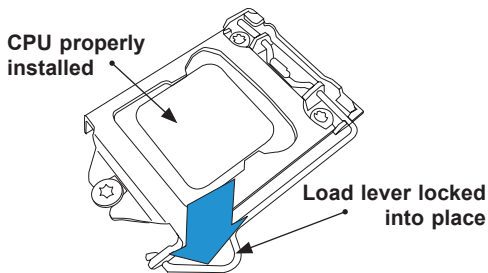

! Attention! You can only install the CPU inside the socket only in one direction. Make sure that it is properly inserted into the CPU socket before closing the load plate. If it doesn't close properly, do not force it as it may damage your CPU. Instead, open the load plate again and double-check that the CPU is aligned properly.

Installing an Active CPU Heatsink with Fan

1. Locate the CPU Fan power connector on the motherboard. (Refer to the layout on the right for the CPU Fan location.)
2. Position the heatsink so that the heatsink fan wires are closest to the CPU fan power connector and are not interfered with other components.
3. Inspect the CPU Fan wires to make sure that the wires are routed through the bottom of the heatsink.
4. Remove the thin layer of the protective film from the heatsink.

! Attention! CPU overheating may occur if the protective film is not removed from the heatsink.

5. Apply the proper amount of thermal grease on the CPU.

Note: If your heatsink came with a thermal pad, please ignore this step.

6. If necessary, rearrange the wires to make sure that the wires are not pinched between the heatsink and the CPU. Also make sure to keep clearance between the fan wires and the fins of the heatsink.

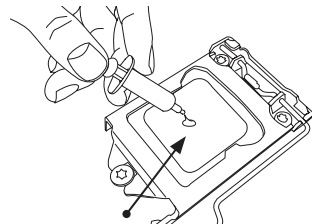

Thermal Grease

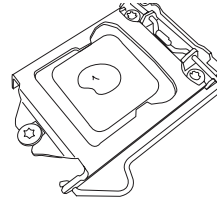

Heatsink Fins

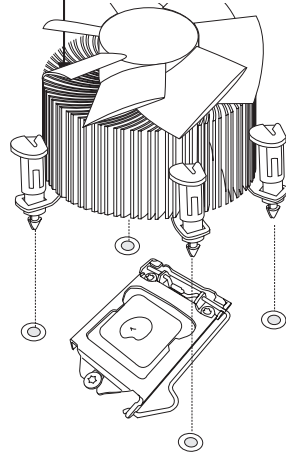

**Recommended Supermicro heatsink:
SNK-P0046A4 active heatsink**

7. Align the four heatsink fasteners with the mounting holes on the motherboard. Gently push the pairs of diagonal fasteners (#1 & #2, and #3 & #4) into the mounting holes until you hear a click. Also, make sure to orient each fastener so that the narrow end of the groove is pointing outward.
8. Repeat Step 7 to insert all four heatsink fasteners into the mounting holes.
9. Once all four fasteners are securely inserted into the mounting holes, and the heatsink is properly installed on the motherboard, connect the heatsink fan wires to the CPU Fan connector.

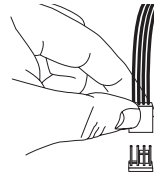
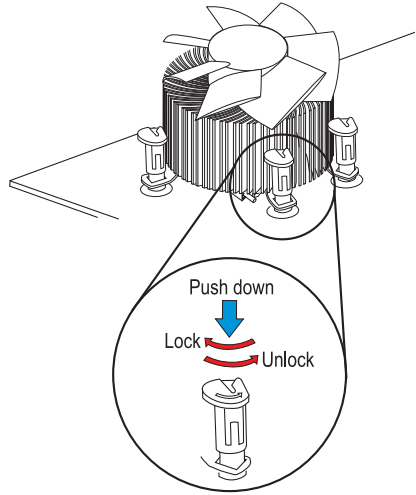

Removing the Heatsink

! Attention! We do not recommend that the CPU or the heatsink be removed. However, if you do need to remove the heatsink, please follow the instructions below to remove the heatsink and to prevent damage done to the CPU or other components.

Active Heatsink Removal

1. Unplug the power cord from the power supply.
2. Disconnect the heatsink fan wires from the CPU fan header.
3. Use your finger tips to gently press on the fastener cap and turn it counterclockwise to make a 1/4 (90°) turn, and pull the fastener upward to loosen it.
4. Repeat Step 3 to loosen all fasteners from the mounting holes.
5. With all fasteners loosened, remove the heatsink from the CPU.

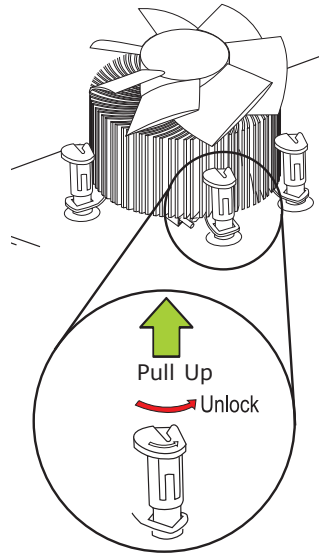
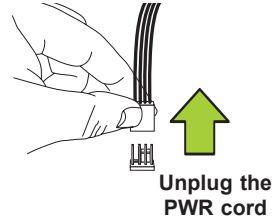

2-4 Installing DDR4 Memory



Note: Check the Supermicro website for recommended memory modules.



Attention! Exercise extreme care when installing or removing DIMM modules to prevent any possible damage.

DIMM Installation

1. Insert the desired number of DIMMs into the memory slots, starting with DIMMA2 (see the next page for the location). For the system to work properly, please use the memory modules of the same type and speed in the same motherboard.

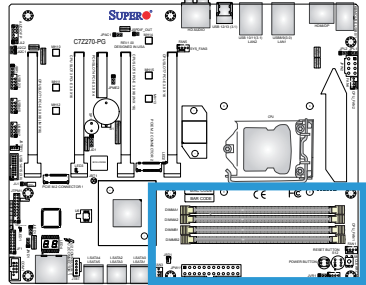

2. Push the release tabs outwards on both ends of the DIMM slot to unlock it.
3. Align the key of the DIMM module with the receptive point on the memory slot.
4. Align the notches on both ends of the module against the receptive points on the ends of the slot.
5. Use two thumbs together to press the notches on both ends of the module straight down into the slot until the module snaps into place.
6. Press the release tabs to the lock positions to secure the DIMM module into the slot.

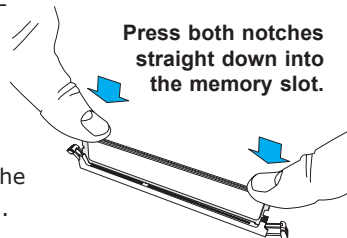
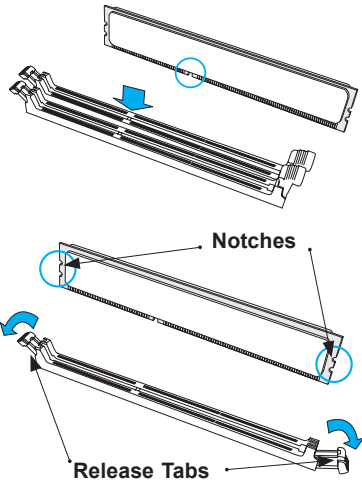

Removing Memory Modules

Reverse the steps above to remove the DIMM modules from the motherboard.

Memory Support

 Towards the CPU



 Towards the edge of the motherboard

The C7Z270-PG supports up to 64GB of unbuffered (UDIMM) non-ECC DDR4 memory, up to 3600MHz (OC) in four 288-pin memory slots. Populating these DIMM modules with a pair of memory modules of the same type and same size will result in interleaved memory, which will improve memory performance.



Notes

Be sure to use memory modules of the same type, same speed, same frequency on the same motherboard. Mixing of memory modules of different types and speeds is not allowed.

Due to memory allocation to system devices, the amount of memory that remains available for operational use will be reduced when 4 GB of RAM is used. The reduction in memory availability is disproportional. See the following table for details.

For Microsoft Windows users: Microsoft implemented a design change in the Windows XP with Service Pack 2 (SP2) and Windows Vista. This change is specific to the behavior of Physical Address Extension (PAE) mode which improves driver compatibility. For more information, please read the following article at

Microsoft's Knowledge Base website at: <http://support.microsoft.com/kb/888137>.

Possible System Memory Allocation & Availability		
System Device	Size	Physical Memory Remaining (-Available) (4 GB Total System Memory)
Firmware Hub flash memory (System BIOS)	1 MB	3.99
Local APIC	4 KB	3.99
Area Reserved for the chipset	2 MB	3.99
I/O APIC (4 Kbytes)	4 KB	3.99
PCI Enumeration Area 1	256 MB	3.76
PCI Express (256 MB)	256 MB	3.51
PCI Enumeration Area 2 (if needed) -Aligned on 256-MB boundary	512 MB	3.01
VGA Memory	16 MB	2.85
TSEG	1 MB	2.84
Memory available to OS and other applications		2.84

Memory Population Guidelines

When installing memory modules, the DIMM slots should be populated in the following order: DIMMA2, DIMMB2, then DIMMA1, DIMMB1.

- Always use DDR4 DIMM modules of the same size, type and speed.
- Mixed DIMM speeds can be installed. However, all DIMMs will run at the speed of the slowest DIMM.

Recommended Population (Balanced)				
DIMMA2	DIMMB2	DIMMA1	DIMMB1	Total System Memory
4GB	4GB			8GB
4GB	4GB	4GB	4GB	16GB
8GB	8GB			16GB
8GB	8GB	8GB	8GB	32GB
16GB	16GB			32GB
16GB	16GB	16GB	16GB	64GB

2-5 Motherboard Installation

All motherboards have standard mounting holes to fit different types of chassis. Make sure that the locations of all the mounting holes for both motherboard and chassis match. Although a chassis may have both plastic and metal mounting fasteners, metal ones are highly recommended because they ground the motherboard to the chassis. Make sure that the metal standoffs click in or are screwed in tightly. Then use a screwdriver to secure the motherboard onto the motherboard tray.



Philips Screwdriver
(1)



Philips Screws (9)



Standoffs (9)
Only if Needed

Tools Needed

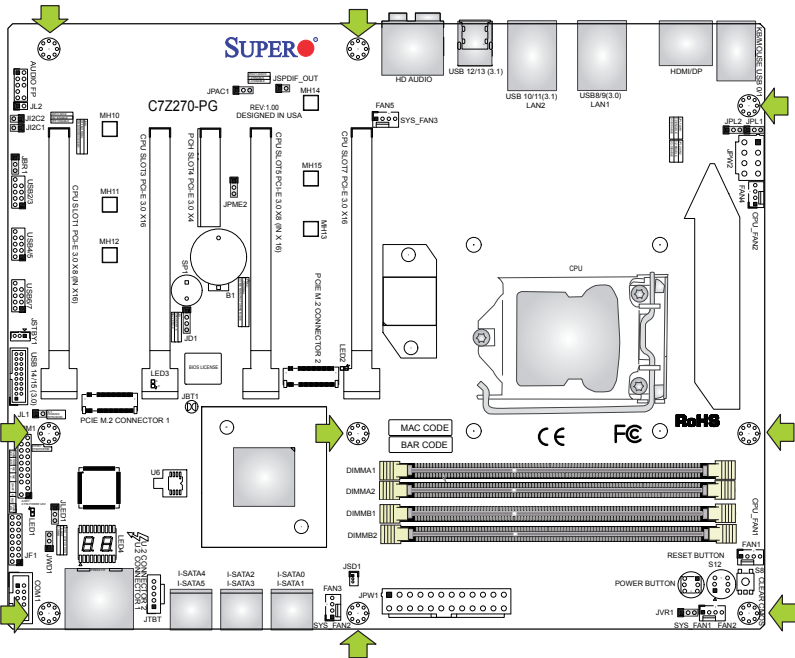

Location of Mounting Holes

- Attention!** 1) To avoid damaging the motherboard and its components, please do not use a force greater than 8 lb/inch on each mounting screw during motherboard installation. 2) Some components are very close to the mounting holes. Please take precautionary measures to avoid damaging these components when installing the motherboard to the chassis.

Installing the Motherboard

1. Install the I/O shield into the back of the chassis.

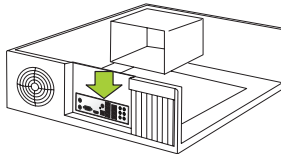

2. Locate the mounting holes on the motherboard. (See the previous page.)
3. Locate the matching mounting holes on the chassis. Align the mounting holes on the motherboard against the mounting holes on the chassis.

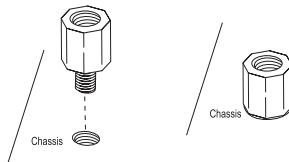

4. Install standoffs in the chassis as needed.
5. Install the motherboard into the chassis carefully to avoid damaging other motherboard components.

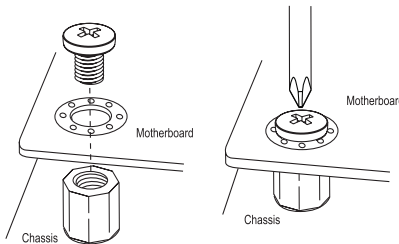

6. Using the Phillips screwdriver, insert a Phillips head #6 screw into a mounting hole on the motherboard and its matching mounting hole on the chassis.
7. Repeat Step 5 to insert #6 screws into all mounting holes.
8. Make sure that the motherboard is securely placed in the chassis.



Note: Images displayed are for illustration only. Your chassis or components might look different from those shown in this manual.

2-6 Connectors/I/O Ports

The I/O ports are color coded in conformance with the industry standards. See the figure below for the colors and locations of the various I/O ports.

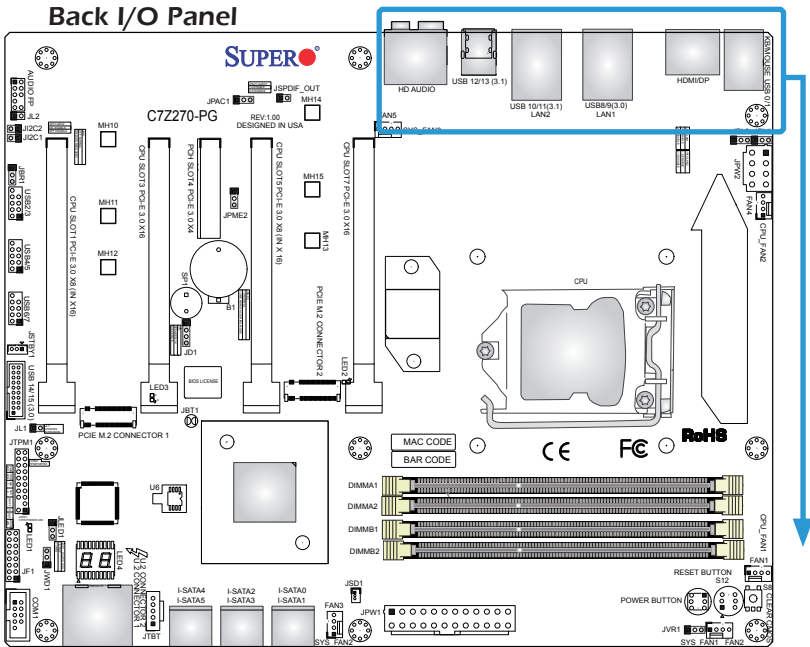

A. PS/2 Keyboard/Mouse Port	G. USB 3.0 Port 8	M. USB 3.1 Port 13	S. Mic In
B. USB 2.0 Port 0	H. USB 3.0 Port 9	N. Center/LFE Out	
C. USB 2.0 Port 1	I. LAN2	O. Surround Out	
D. Display Port	J. USB 3.1 Port 10	P. S/PDIF Out	
E. HDMI Port	K. USB 3.1 Port 11	Q. Line In	
F. LAN1	L. USB 3.1 Port 12	R. Line Out	

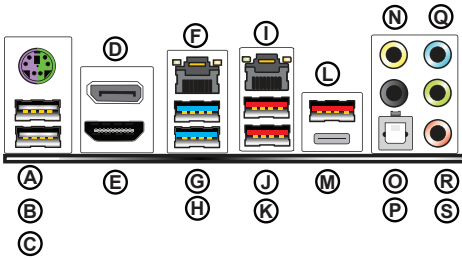

Universal Serial Bus (USB)

Two Universal Serial Bus 2.0 ports (#0/1), two USB 3.0 ports (#8/9), four USB 3.1 ports (#10/11/12/13) are located on the I/O back panel. In addition, one USB 3.0 header (two ports: #14/15), three USB 2.0 headers (six ports: #2/3, 4/5, 6/7) are also located on the motherboard to provide front chassis access using USB cables (not included). See the tables below for pin definitions.

Front Panel USB (2.0) Header #2/3/4/5/6/7 Pin Definitions			
Pin #	Definition	Pin #	Definition
1	+5V	2	+5V
3	USB_PN2	4	USB_PN3
5	USB_PP2	6	USB_PP3
7	Ground	8	Ground
9	Key	10	Ground

Back Panel USB (2.0) #0/1, USB (3.1) #8/9/10/11 Pin Definitions			
Pin#	Definition	Pin#	Definition
1	+5V	5	+5V
2	USB_PN1	6	USB_PN0
3	USB_PP1	7	USB_PP0
4	Ground	8	Ground

Front Panel USB (3.0) Header #12/13 Pin Definitions			
Pin#	Pin#	Signal Name	Description
1	10	VBUS	Power
2	11	D-	USB 2.0 Differential Pair
3	12	D+	
4	13	Ground	Ground of PWR Return
5	14	StdA_SSRX-	SuperSpeed Receiver
6	15	StdA_SSRX+	Differential Pair
7	16	GND_DRAIN	Ground for Signal Return
8	17	StdA_SSTX-	SuperSpeed Transmitter
9	18	StdA_SSTX+	Differential Pair

- A. Back panel USB 2.0 #0
- B. Back panel USB 2.0 #1
- C. Back panel USB 3.0 #8
- D. Back panel USB 3.0 #9
- E. Back panel USB 3.1 #10
- F. Back panel USB 3.1 #11
- G. Back panel USB 3.1 #12
- H. Back panel USB 3.1 #13
- I. USB 2.0 Header #2/3
- J. USB 2.0 Header #4/5
- K. USB 2.0 Header #6/7
- L. USB 3.0 Header #14/15

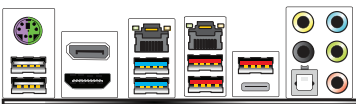

- (A)
- (B)
- (C)
- (D)
- (E)
- (F)
- (G)
- (H)

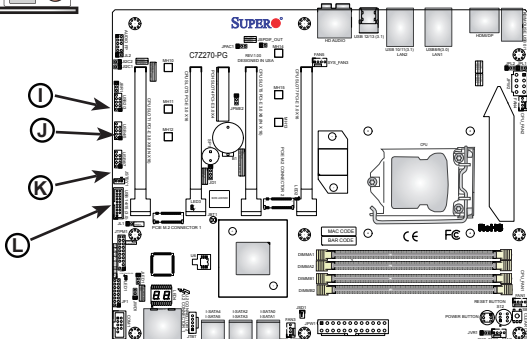

Ethernet Port

Two Gigabit Ethernet port (LAN) are located on the I/O Back panel to provide network connections. This port will accept RJ45 type cables.



Note: Please refer to the LED Indicator Section for LAN LED information.

LAN Ports Pin Definition			
Pin#	Definition	Pin#	Definition
1	P2V5SB	10	SGND
2	TD0+	11	Act LED
3	TD0-	12	P3V3SB
4	TD1+	13	Link 100 LED (Green, +3V3SB)
5	TD1-	14	Link 1000 LED (Yellow, +3V3SB)
6	TD2+	15	Ground
7	TD2-	16	Ground
8	TD3+	17	Ground
9	TD3-	88	Ground

Back Panel High Definition Audio (HD Audio)

This motherboard features a 7.1+2 Channel High Definition Audio (HDA) codec that provides 10 DAC channels. The HD Audio connections simultaneously supports multiple-streaming 7.1 sound playback with 2 channels of independent stereo output through the front panel stereo out for front, rear, center and subwoofer speakers. Use the Advanced software included in the CD-ROM with your motherboard to enable this function.

(NC: No Connection)

- A. LAN1
- B. LAN2
- C. Center/LFE Out
- D. Surround Out
- E. S/PDIF Out
- F. Line In
- G. Line Out
- H. Mic In

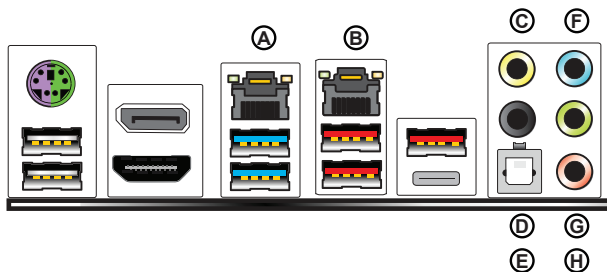

ATX PS/2 Keyboard/Mouse Ports

The ATX PS/2 keyboard and PS/2 mouse are located above Back Panel USB Ports 0/1 on the motherboard.

VESA® DisplayPort™

DisplayPort, developed by the VESA consortium, delivers digital display at a fast refresh rate. It can connect to virtually any display device using a DisplayPort adapter for devices such as VGA, DVI, or HDMI.

HDMI Port

One HDMI (High-Definition Multimedia Interface) is located on the I/O backpanel. This connector is used to display both high definition video and digital sound through an HDMI capable display, using a single HDMI cable (not included).

- A. PS/2 Keyboard/Mouse Port
- B. Display Port
- C. HDMI Port

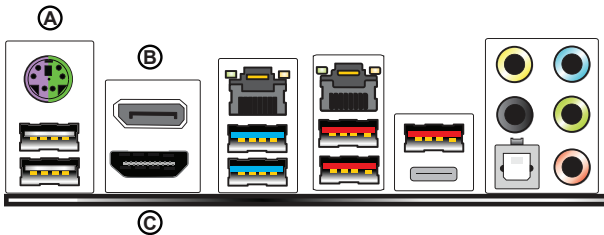

Front Control Panel

JF1 contains header pins for various buttons and indicators that are normally located on a control panel at the front of the chassis. These connectors are designed specifically for use with Supermicro chassis. See the figure below for the descriptions of the front control panel buttons and LED indicators. Refer to the following section for descriptions and pin definitions.

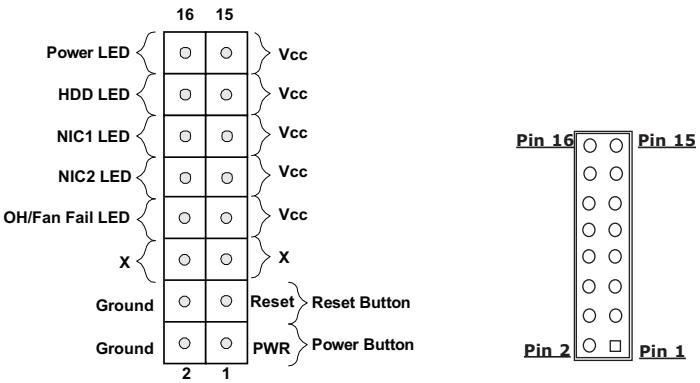
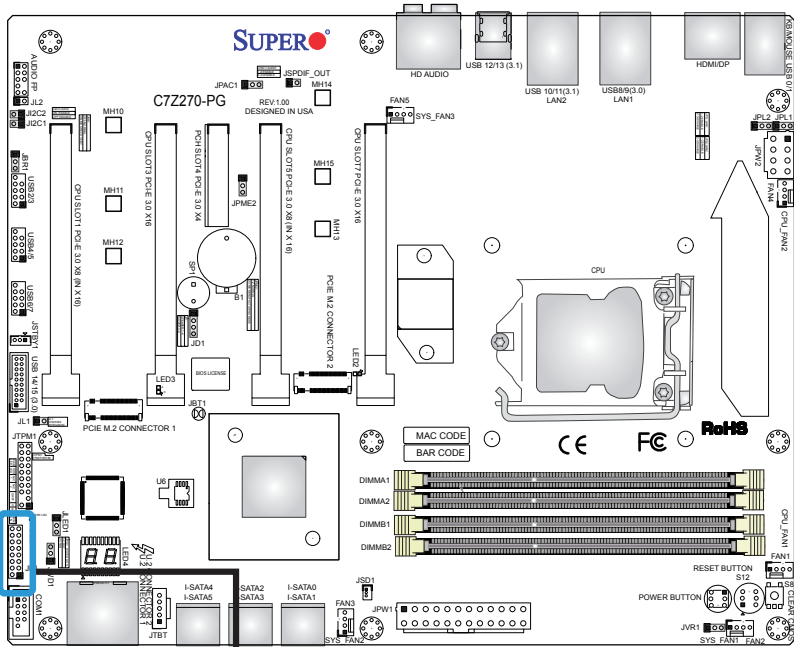

JF1 Header Pins

Front Control Panel Pin Definitions

Power LED

The Power LED connection is located on pins 15 and 16 of JF1. Refer to the table on the right for pin definitions.

Power LED Pin Definitions (JF1)	
Pin#	Definition
15	+5V
16	Vcc

HDD LED

The HDD LED connection is located on pins 13 and 14 of JF1. Attach a cable here to indicate the status of HDD-related activities, including IDE, SATA activities. See the table on the right for pin definitions.

HDD LED Pin Definitions (JF1)	
Pin#	Definition
13	Vcc
14	HDD LED

NIC1 (LAN)

The NIC (Network Interface Controller) LED connection for LAN port 1 is located on pins 11 and 12 of JF1. Attach an LED indicator to this header to display network activity. Refer to the table on the right for pin definitions.

LAN LED Pin Definitions (JF1)	
Pin#	Definition
11	Vcc
12	NIC2 LED

NIC2 (LAN)

The NIC (Network Interface Controller) LED connection for LAN port 2 is located on pins 9 and 10 of JF1. Attach an LED indicator to this header to display network activity. Refer to the table on the right for pin definitions.

LAN LED Pin Definitions (JF1)	
Pin#	Definition
9	Vcc
10	NIC2 LED

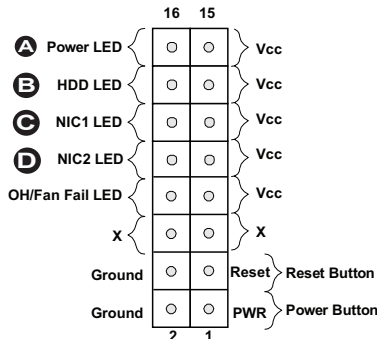

- A. PWR LED
- B. HDD LED
- C. NIC1 LED
- D. NIC2 LED

Reset Button

The Reset Button connection is located on pins 3 and 4 of JF1. Attach it to a hardware reset switch on the computer case to reset the system. Refer to the table on the right for pin definitions.

Reset Button Pin Definitions (JF1)	
Pin#	Definition
3	Reset Button
4	Ground

Power Button

The Power Button connection is located on pins 1 and 2 of JF1. Momentarily contacting both pins will power on/off the system. This button can also be configured to function as a suspend button (with a setting in the BIOS - see Chapter 4). To turn off the power in the suspend mode, press the button for at least 4 seconds. Refer to the table on the right for pin definitions.

Power Button Pin Definitions (JF1)	
Pin#	Definition
1	Power Button
2	Ground

Overheat (OH)/Fan Fail

Connect an LED cable to OH/Fan Fail connections on pins 7 and 8 of JF1 to provide warnings for chassis overheat/fan failure. Refer to the table on the right for pin definitions.

OH/Fan Fail LED Pin Definitions (JF1)	
Pin#	Definition
7	Vcc
8	OH/Fan Fail LED

OH/Fan Fail Indicator Status	
State	Definition
Off	Normal
On	Overheat
Flashing	Fan Fail

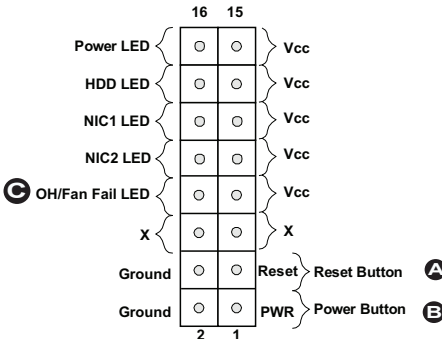

- A. Reset Button
- B. PWR Button
- C. OH/Fan Fail LED

2-7 Connecting Cables

This section provides brief descriptions and pinout definitions for onboard headers and connectors. Be sure to use the correct cable for each header or connector.

ATX Main PWR & CPU PWR Connectors (JPW1 & JPW2)

The 24-pin main power connector (JPW1) is used to provide power to the motherboard. The 8-pin CPU PWR connector (JPW2) is also required for the processor. These power connectors meet the SSI EPS 12V specification. See the table on the right for pin definitions.

12V 8-pin Power Connector Pin Definitions	
Pins	Definition
1 through 4	Ground
5 through 8	+12V

(Required)

ATX Power 24-pin Connector Pin Definitions (JPW1)			
Pin#	Definition	Pin #	Definition
13	+3.3V	1	+3.3V
14	-12V	2	+3.3V
15	COM	3	COM
16	PS_ON	4	+5V
17	COM	5	COM
18	COM	6	+5V
19	COM	7	COM
20	Res (NC)	8	PWR_OK
21	+5V	9	5VSB
22	+5V	10	+12V
23	+5V	11	+12V
24	COM	12	+3.3V

A. 24-Pin ATX Main PWR

B. 8-Pin PWR

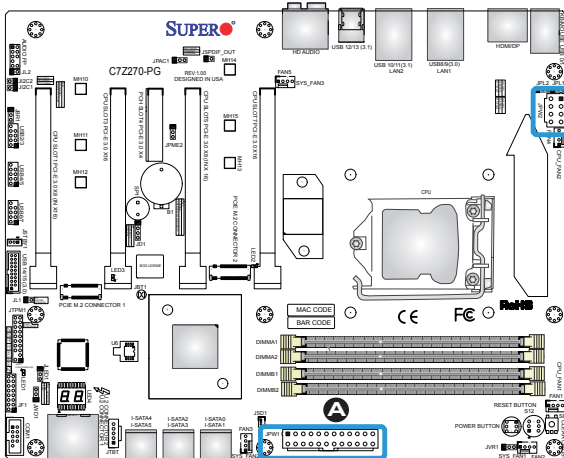

Fan Headers (Fan 1 - Fan 5)

Your motherboard has five fan headers (Fan 1-Fan 5). These fans are 4-pin fan headers. Although pins 1-3 of the fan headers are backward compatible with the traditional 3-pin fans, we recommend the use 4-pin fans to take advantage of the fan speed control. This allows the fan speeds to be automatically adjusted based on the motherboard temperature. Refer to the table on the right for pin definitions.

Fan Header Pin Definitions	
Pin#	Definition
1	Ground (Black)
2	2.5A/+12V (Red)
3	Tachometer
4	PWM_Control

Chassis Intrusion (JL1)

A Chassis Intrusion header is located at JL1 on the motherboard. Attach the appropriate cable from the chassis to inform you of a chassis intrusion when the chassis is opened.

Chassis Intrusion Pin Definitions (JL1)	
Pin#	Definition
1	Intrusion Input
2	Ground

- A. Fan 1 (CPU Fan)
- B. Fan 2
- C. Fan 3
- D. Fan 4 (CPU Fan)
- E. Fan 5
- F. Chassis Intrusion

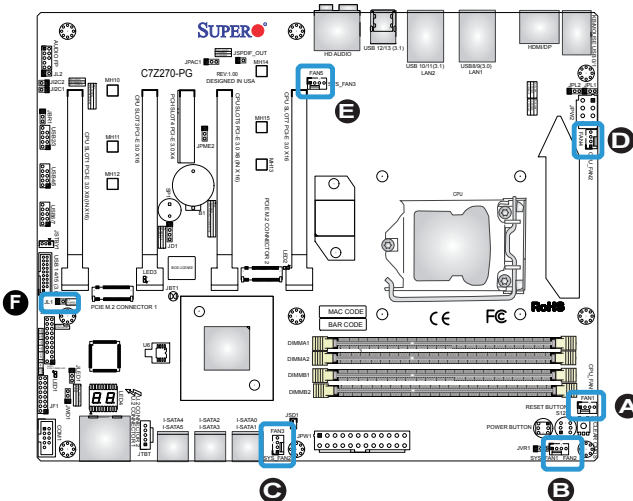

Internal Buzzer (SP1)

The Internal Buzzer (SP1) can be used to provide audible indications for various beep codes. See the table on the right for pin definitions.

Internal Buzzer Pin Definition		
Pin#	Definitions	
Pin 1	Pos. (+)	Beep In
Pin 2	Neg. (-)	Alarm Speaker

Speaker (JD1)

On the JD1 header, pins 3-4 are used for internal speaker. Close pins 3-4 with a cap to use the onboard speaker. If you wish to use an external speaker, close pins 1-4 with a cable. See the table on the right for pin definitions.

Speaker Connector Pin Definitions	
Pin Setting	Definition
Pins 3~4	Internal Speaker
Pins1~4	External Speaker

- A. Internal Buzzer
- B. Speaker Header

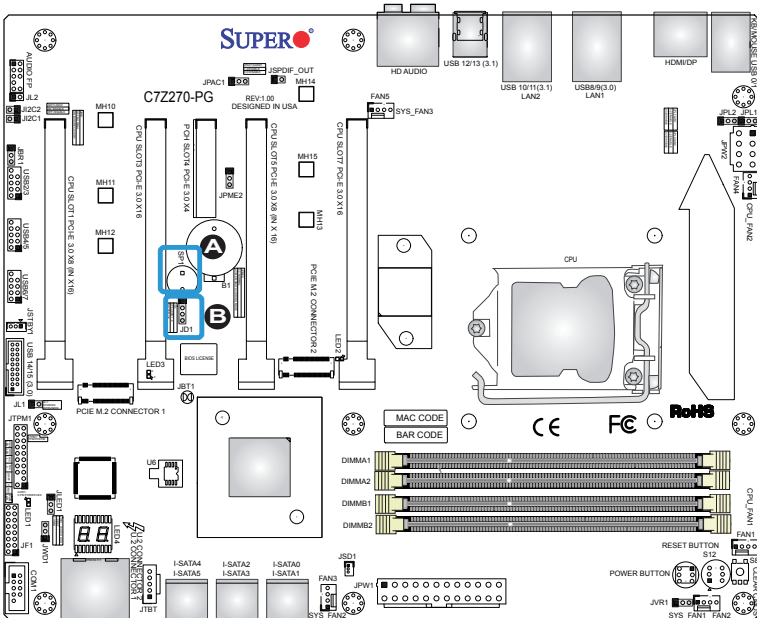

Onboard Power LED (JLED1)

An onboard Power LED header is located at JLED1. This Power LED header is connected to Front Control Panel located at JF1 to indicate the status of system power. See the table on the right for pin definitions.

Onboard PWR LED Pin Definitions	
Pin#	Definition
1	VCC
2	No Connection
3	Connection to PWR LED in JF1

Serial Port (COM1)

There is one serial (COM) port header on the motherboard. COM1 is located next to the 1394 connection header. See the table on the right for pin definitions.

Serial/COM Ports Pin Definitions			
Pin #	Definition	Pin #	Definition
1	DCD	6	DSR
2	RXD	7	RTS
3	TXD	8	CTS
4	DTR	9	RI
5	Ground	10	N/A

A. PWR LED

B. COM1

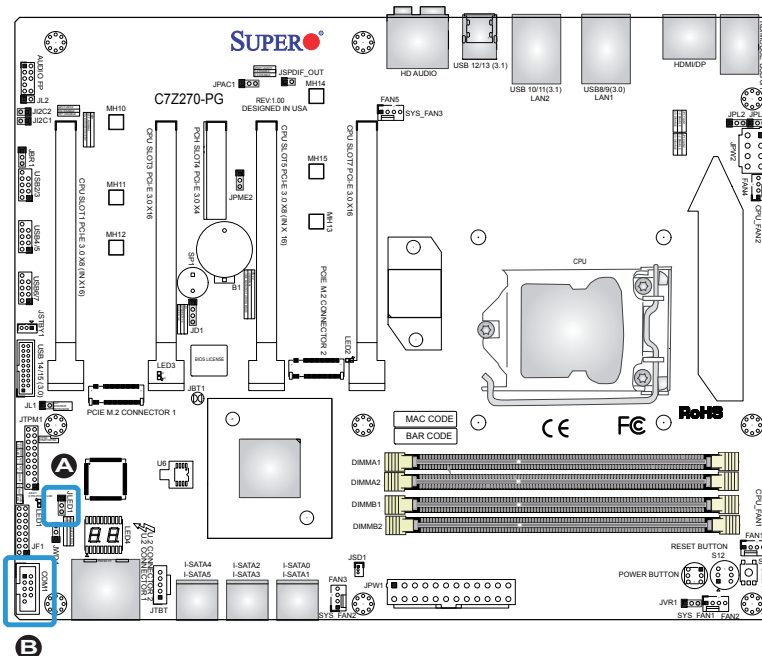

DOM PWR Connector (JSD1)

The Disk-On-Module (DOM) power connector, located at JSD1, provides 5V power to a solid state DOM storage device connected to one of the SATA ports. See the table on the right for pin definitions.

DOM PWR Pin Definitions	
Pin#	Definition
1	5V
2	Ground
3	Ground

SPDIF OUT (JSPDIF_OUT)

The SPDIF Out (JSPDIF_OUT) is used for digital audio output. You will also need the appropriate cable to use this feature.

SPDIF_OUT Pin Definitions	
Pin#	Definition
1	S/PDIF_Out
2	Ground

- A. DOM PWR
- B. S/PDIF OUT

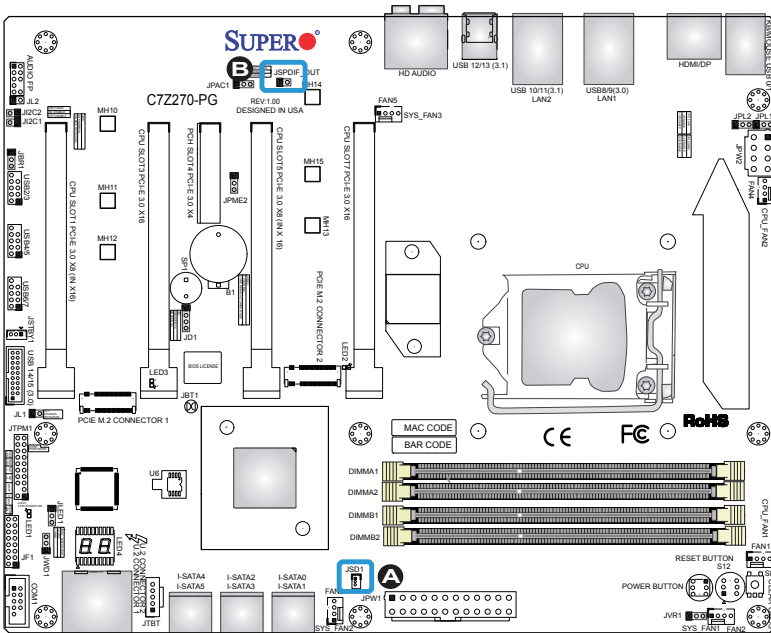

Standby Power Header (JSTBY1)

The Standby Power header is located at JSTBY1 on the motherboard. See the table on the right for pin definitions.

Standby Power Pin Definitions	
Pin#	Definition
1	+5V Standby
2	Ground
3	Wake-up

PCI-E M.2 Connector (PCI-E M.2)

The PCI-E M.2 connector is for devices such as memory cards, wireless adapters, etc. These devices must conform to the PCIe M.2 specifications (formerly known as NGFF).

- A. JSTBY PWR
- B. PCI-E M.2 Connector 1
- C. PCI-E M.2 Connector 2

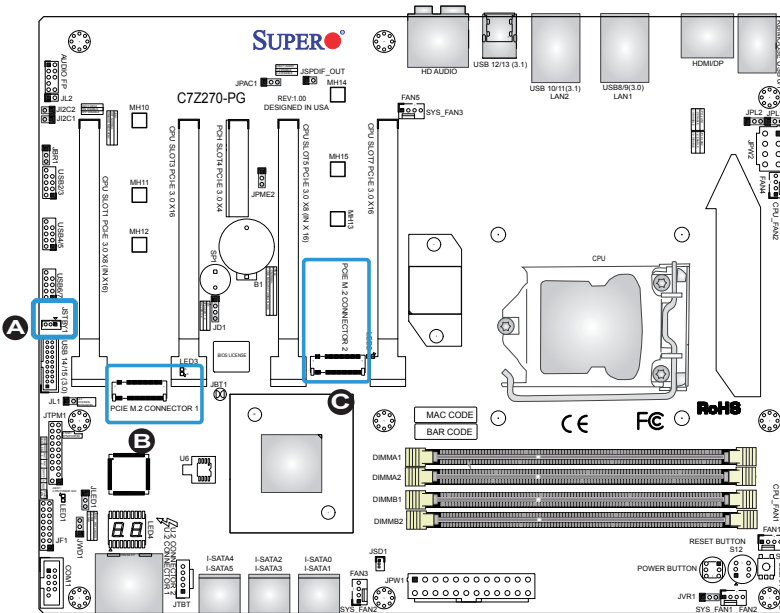

Front Panel Audio Header (AUDIO FP)

A 10-pin Audio header is supported on the motherboard. This header allows you to connect the motherboard to a front panel audio control panel, if needed. Connect an audio cable to the audio header to use this feature (not supplied). See the table on the right for pin definitions for the header.

10-in Audio Pin Definitions	
Pin#	Signal
1	Microphone_Left
2	Audio_Ground
3	Microphone_Right
4	Audio_Detect
5	Line_2_Right
6	Ground
7	Jack_Detect
8	Key
9	Line_2_Left
10	Ground

TPM Header/Port 80

A Trusted Platform Module/Port 80 header is located at JTPM1 to provide TPM support and Port 80 connection. Use this header to enhance system performance and data security. See the table on the right for pin definitions.

TPM/Port 80 Header Pin Definitions			
Pin #	Definition	Pin #	Definition
1	LCLK	2	GND
3	LFRAME#	4	<(KEY)>
5	LRESET#	6	+5V (X)
7	LAD 3	8	LAD 2
9	+3.3V	10	LAD1
11	LAD0	12	GND
13	SMB_CLK4	14	SMB_DAT4
15	+3V_DUAL	16	SERIRQ
17	GND	18	CLKRUN# (X)
19	LPCPD#	20	LDRQ# (X)

- A. AUDIO FP
- B. TPM Header

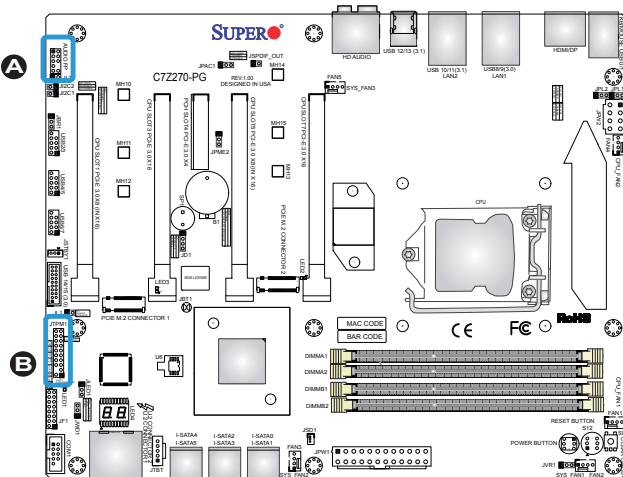

2-8 Jumper Settings

Explanation of Jumpers

To modify the operation of the motherboard, jumpers can be used to choose between optional settings. Jumpers create shorts between two pins to change the function of the connector. Pin 1 is identified with a square solder pad on the printed circuit board.



Note: On two-pin jumpers, "Closed" means the jumper is on, and "Open" means the jumper is off the pins.

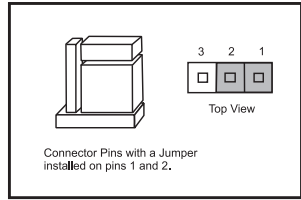
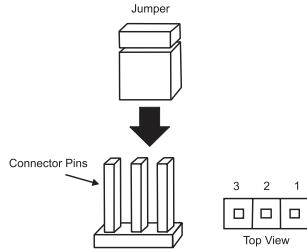

LAN Enable/Disable

Jumper JPL2 will enable or disable LAN ports 3 and 4. See the table on the right for jumper settings. The default setting is enabled.

GLAN Enable Jumper Settings	
Pin#	Definition
1-2	Enabled (default)
2-3	Disabled

A. JPL2: LAN2 Enable

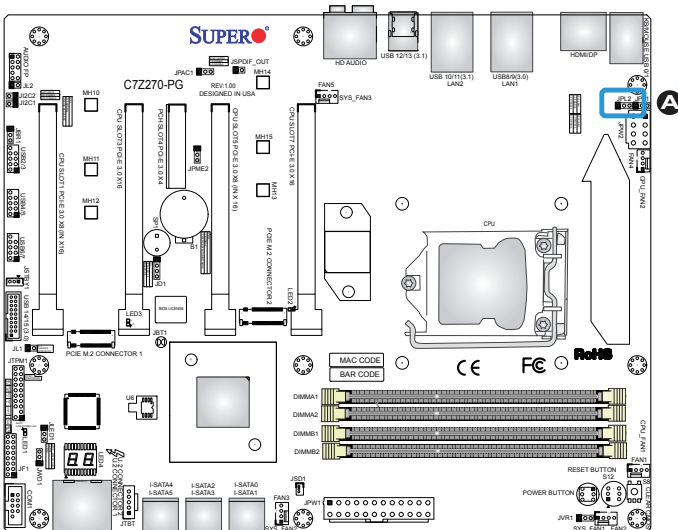

Clear CMOS & JBT1

Clear CMOS and JBT1 are used to clear the saved system setup configuration stored in the CMOS chip. To clear the contents of the CMOS using JBT1, short the two pads of JBT1 with metallic conductor such as a flathead screwdriver. Clear CMOS works the same way but is a push button switch. This will erase all user settings and revert everything to their factory-set defaults.

PCI Slot SMB Enable (I²C1/I²C2)

Use Jumpers I²C1/I²C2 to enable PCI SMB (System Management Bus) support to improve system management for the PCI slots. See the table on the right for jumper settings.

PCI Slot_SMB Enable Jumper Settings	
Jumper Setting	Definition
Short	Enabled
Open (Default)	Disabled

- A. JBT1
- B. Clear CMOS
- C. I²C1
- D. I²C2

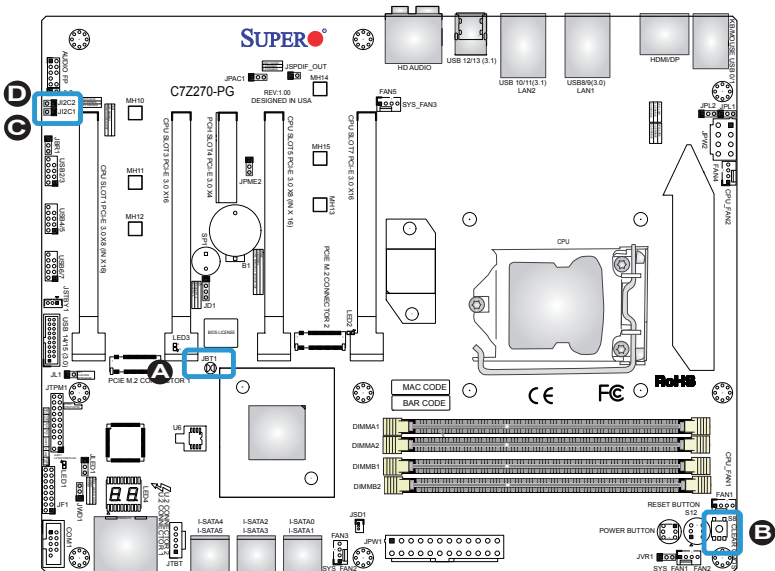

Manufacturing Mode (JPME2)

Close pins 2 and 3 of jumper JPME2 to bypass SPI flash security and force the system to operate in Manufacturing Mode, allowing the user to flash the system firmware from a host server for system setting modifications. See the table on the right for jumper settings.

Manufacture Mode (JPME2) Jumper Settings	
Pin#	Definition
1-2	Normal (Default)
2-3	Manufacture Mode

Audio Enable (JPAC1)

JPAC1 allows you to enable or disable the onboard audio support. The default position is on pins 1 and 2 to enable onboard audio connections. See the table on the right for jumper settings.

Audio Enable/Disable Jumper Settings	
Both Jumpers	Definition
Pins 1-2	Enabled
Pins 2-3	Disabled

Watch Dog Timer Enable/Disable

Watch Dog (JWD1) is a system monitor that can reboot the system when a software application hangs. Close pins 1-2 to reset the system if an application hangs. Close pins 2-3 to generate a non-maskable interrupt signal for the application that hangs. See the table on the right for jumper settings.

Watch Dog Jumper Settings	
Jumper Setting	Definition
Pins 1-2	Reset (default)
Pins 2-3	NMI
Open	Disabled

- A. Manufacturing Mode
- B. Audio Enable
- C. Watch Dog Timer

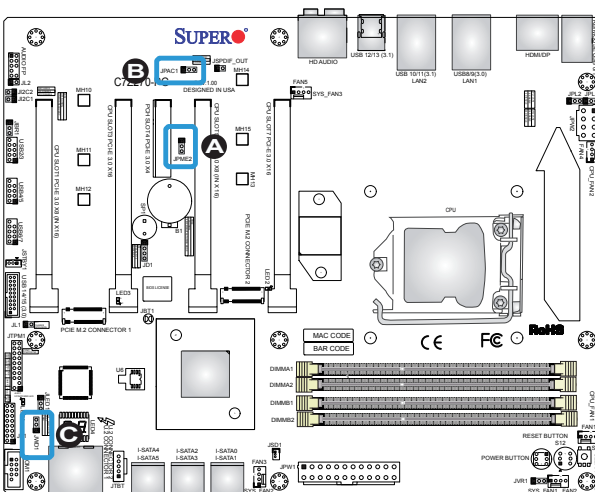

2-9 Onboard Indicators

LAN LEDs

Two LAN ports are located on the I/O back panel of the motherboard. This Ethernet LAN port has two LEDs (Light Emitting Diode). The yellow LED indicates activity, while the Link LED may be green, amber, or off to indicate the speed of the connections. See the tables at right for more information.

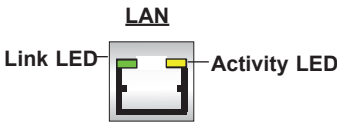

GLAN Activity Indicator LED Settings		
Color	Status	Definition
Yellow	Flashing	Active

GLAN Link Indicator LED Settings	
LED Color	Definition
Off	No Connection/10 Mbps/100 Mbps
Amber	1 Gbps
Green	10 Gbps.

Onboard Power LED (LED1)

An Onboard Power LED is located at LED1 on the motherboard. When LED1 is on, the AC power cable is connected. Make sure to disconnect the power cable before removing or installing any component. See the layout below for the LED location.

Onboard PWR LED Indicator LED Status	
Status	Definition
Off	System Off
On	System on, or System off and PWR Cable Connected

- A. LAN1 LEDs
- B. LAN2 LEDs
- C. PWR LED

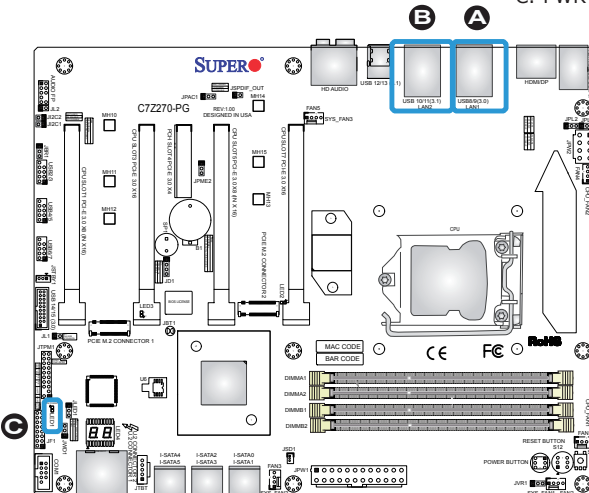

Status Display (LED4)

LED4 is made up of two alpha-numeric displays that will display a status or POST code, when the motherboard is powered on. Please download the AMI POST codes at:

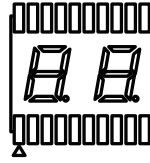

https://www.supermicro.com.tw/manuals/other/AMI_BIOS_POST_Codes_for_Grantley_Motherboards.pdf

LED	Description	Color/State	Status
LED1	Onboard Standby PWR LED	Green: Solid on	Power On
LED2	M.2 connector 2 SSD ACT LED	Green: Solid on	M.2 device connected
LED3	M.2 connector 1 SSD ACT LED	Green: Solid on	M.2 device connected
LED4	Status Code LED*	Digital Readout	See manual

- A. Power LED
- B. M.2 Connector 2 Activity LED
- C. M.2 Connector 1 Activity LED
- D. Status LED .

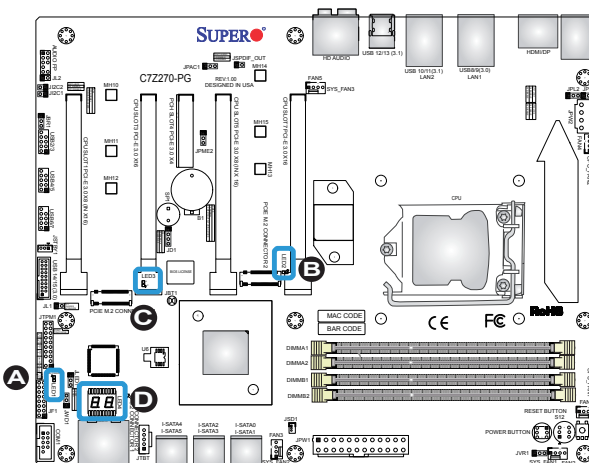

2-10 Hard Drive Connections

SATA Connections (I-SATA0~I-SATA5)

Six Serial ATA (SATA) 3.0 connectors (I-SATA 0~5) are supported on the board. These I-SATA 3.0 ports are supported by the Intel Z270 PCH chip (supports RAID 0,1,5,10). See the table on the right for pin definitions.

SATA 2.0/3.0 Connectors Pin Definitions	
Pin#	Signal
1	Ground
2	SATA_TXP
3	SATA_TXN
4	Ground
5	SATA_RXN
6	SATA_RXP
7	Ground

U.2 SSD Connectors

Two U.2 SSD connectors (U.2 Connector 1, U.2 Connector 2) are supported on the board. These connectors support Solid State Drives (SSD) and is an extension of the existing SATA connectors. They offer up to 4x PCI 3.0 lanes to a connected SSD device.

Top

- A. I-SATA 3.0 #4
- B. I-SATA 3.0 #2
- C. I-SATA 3.0 #0
- G. U.2 Connector 1

Bottom

- D. I-SATA 3.0 #5
- E. I-SATA 3.0 #3
- F. I-SATA 3.0 #1
- H. U.2 Connector 2

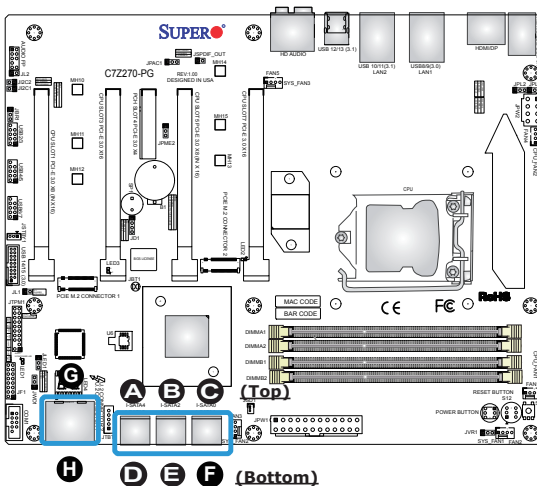

Notes

Chapter 3

Troubleshooting

3-1 Troubleshooting Procedures

Use the following procedures to troubleshoot your system. If you have followed all of the procedures below and still need assistance, refer to the 'Technical Support Procedures' and/or 'Returning Merchandise for Service' section(s) in this chapter. Always disconnect the AC power cord before adding, changing or installing any hardware components.

Before Power On

1. Make sure that the Standby PWR LED is not on. (**Note:** If it is on, the onboard power is on. Be sure to unplug the power cable before installing or removing the components.)
2. Make sure that there are no short circuits between the motherboard and chassis.
3. Disconnect all ribbon/wire cables from the motherboard, including those for the keyboard and mouse. Also, be sure to remove all add-on cards.
4. Install a CPU and heatsink (be sure that it is fully seated) and then connect the chassis speaker and the power LED to the motherboard. Check all jumper settings as well.

No Power

1. Make sure that there are no short circuits between the motherboard and chassis.
2. Make sure that all jumpers are set to their default positions.
3. Check if the 115V/230V switch on the power supply is properly set.
4. Turn the power switch on and off to test the system.
5. The battery on your motherboard may be old. Check to make sure that it still supplies ~3VDC. If it does not, replace it.

No Video

1. If the power is on, but you have no video--in this case, you will need to remove all the add-on cards and cables first.
2. Use the speaker to determine if any beep codes exist. (Refer to Appendix A for details on beep codes.)
3. Remove all memory modules and turn on the system. (If the alarm is on, check the specifications of memory modules, reset the memory or try a different one.)

Memory Errors

1. Make sure that the DIMM modules are properly installed and fully seated in the slots.
2. You should be using unbuffered non-ECC DDR4 (up to 3600 MHz) memory recommended by the manufacturer. Also, it is recommended that you use the memory modules of the same type and speed for all DIMMs in the system. Do not use memory modules of different sizes, different speeds and different types on the same motherboard.
3. Check for bad DIMM modules or slots by swapping modules between slots to see if you can locate the faulty ones.
4. Check the switch of 115V/230V power supply.

When the System is Losing the Setup Configuration

1. Please be sure to use a high quality power supply. A poor quality power supply may cause the system to lose CMOS setup information. Refer to Section 1-5 for details on recommended power supplies.
2. The battery on your motherboard may be old. Check to verify that it still supplies ~3VDC. If it does not, replace it with a new one.
3. If the above steps do not fix the Setup Configuration problem, contact your vendor for repairs.

3-2 Technical Support Procedures

Before contacting Technical Support, please make sure that you have followed all the steps listed below. Also, Note that as a motherboard manufacturer, Supermicro does not sell directly to end users, so it is best to first check with your distributor or reseller for troubleshooting services. They should know of any possible problem(s) with the specific system configuration that was sold to you.

1. Please go through the 'Troubleshooting Procedures' and 'Frequently Asked Question' (FAQ) sections in this chapter or see the FAQs on our website (<http://www.supermicro.com/support/faqs/>) before contacting Technical Support.
2. BIOS upgrades can be downloaded from our website at (<http://www.supermicro.com/support/bios/>).



Note: Not all BIOS can be flashed. Some cannot be flashed; it depends on the boot block code of the BIOS.

3. If you've followed the instructions above to troubleshoot your system, and still cannot resolve the problem, then contact Supermicro's technical support and provide them with the following information:
 - Motherboard model and PCB revision number
 - BIOS release date/version (this can be seen on the initial display when your system first boots up)
 - System configuration
 - An example of a Technical Support form is on our website at (<http://www.supermicro.com/support/contact.cfm>).
4. Distributors: For immediate assistance, please have your account number ready when placing a call to our technical support department. We can be reached by e-mail at support@supermicro.com, by phone at: (408) 503-8000, option 2, or by fax at (408)503-8019.

3-3 Frequently Asked Questions

Question: What type of memory does my motherboard support?

Answer: Supports up to 64GB of unbuffered, non-ECC, 3600MHz (OC) DDR4 memory. See Section 2-4 for details on installing memory.

Question: How do I update my BIOS?

Answer: We do NOT recommend that you upgrade your BIOS if you are not experiencing any problems with your system. Updated BIOS files are located on our website at <http://www.supermicro.com/support/bios/>. Please check our BIOS warning message and the information on how to update your BIOS on our web site. Select your motherboard model and download the BIOS ROM file to your computer. Also, check the current BIOS revision to make sure that it is newer than your BIOS before downloading. You may choose the zip file or the .exe file. If you choose the zipped BIOS file, please unzip the BIOS file onto a bootable device or a USB pen/thumb drive. To flash the BIOS, run the batch file named "ami.bat" with the new BIOS ROM file from your bootable device or USB pen/thumb drive. Use the following format:

```
F:\> ami.bat BIOS-ROM-filename.xxx <Enter>
```



Note: Always use the file named "ami.bat" to update the BIOS, and insert a space between "ami.bat" and the filename. The BIOS-ROM-filename will bear the motherboard name (i.e., C7Z270) and build version as the extension. For example, "C7Z270.115". When completed, your system will automatically reboot.

If you choose the .exe file, please run the .exe file under Windows to create the BIOS flash floppy disk. Insert the floppy disk into the system you wish to flash the BIOS. Then, boot the system to the floppy disk. The BIOS utility will automatically flash the BIOS without any prompts. Please note that this process may take a few minutes to complete. Do not be concerned if the screen is paused for a few minutes.

When the BIOS flashing screen is completed, the system will reboot and will show "Press F1 or F2". At this point, you will need to load the BIOS defaults. Press <F1> to go to the BIOS setup screen, and press <F9> to load the default settings. Next, press <F10> to save and exit. The system will then reboot.



Attention! Do not shut down or reset the system while updating the BIOS to prevent possible system boot failure!

Question: I think my BIOS is corrupted. How can I recover my BIOS?

Answer: Please see Appendix C-BIOS Recovery for detailed instructions.

3-4 Battery Removal and Installation

Battery Removal

To remove the onboard battery, follow the steps below:

1. Power off your system and unplug your power cable.
2. Locate the onboard battery as shown below.
3. Using a tool such as a pen or a small screwdriver, push the battery lock outwards to unlock it. Once unlocked, the battery will pop out from the holder.
4. Remove the battery.

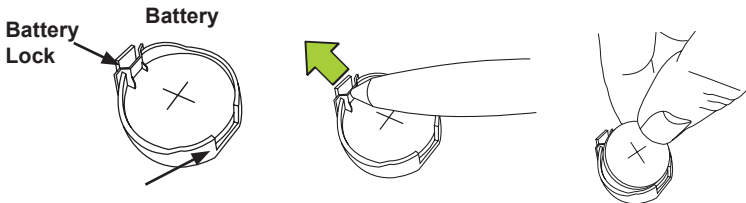

Proper Battery Disposal

- ! Attention!** Please handle used batteries carefully. Do not damage
- the battery in any way; a damaged battery may release hazardous materials into the environment. Do not discard a used battery in the garbage or a public landfill. Please comply with the regulations set up by your local hazardous waste management agency to dispose of your used battery properly.

Battery Installation

1. To install an onboard battery, follow the steps 1 & 2 above and continue below:
2. Identify the battery's polarity. The positive (+) side should be facing up.
3. Insert the battery into the battery holder and push it down until you hear a click to ensure that the battery is securely locked.

! Attention! When replacing a battery, be sure to only replace it with the same type.

Battery Holder

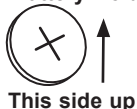

3-5 Returning Motherboard for Service

A receipt or copy of your invoice marked with the date of purchase is required before any warranty service will be rendered. You can obtain service by calling your vendor for a Returned Merchandise Authorization (RMA) number. For faster service, you may also obtain RMA authorizations online (<http://www.supermicro.com/RmaForm/>). When you return the motherboard to the manufacturer, the RMA number should be prominently displayed on the outside of the shipping carton, and mailed prepaid or hand-carried. Shipping and handling charges will be applied for all orders that must be mailed when service is complete.

This warranty only covers normal consumer use and does not cover damages incurred in shipping or from failure due to the alteration, misuse, abuse or improper maintenance of products.

During the warranty period, contact your distributor first for any product problems.

Chapter 4

BIOS

4-1 Introduction

This chapter describes the AMI BIOS setup utility for the C7Z270-PG. The ROM BIOS is stored in a Flash EEPROM and can be easily updated. This chapter describes the basic navigation of the AMI BIOS setup utility setup screens.



Note: For AMI BIOS Recovery, please refer to the UEFI BIOS Recovery Instructions in Appendix C.

Starting BIOS GUI Setup Utility

To enter the AMI BIOS GUI setup utility screens, press the <Delete> key while the system is booting up.



Note: In most cases, the <Delete> key is used to invoke the AMI BIOS setup screen.

SUPER™

15:01:33
THU 05/04/2017

C7Z270-PG
VERSION 1.0b
BIOS Build Date: 06/01/2017

CPU: Genuine Intel(R)
CPU Speed: 2998 MHz
CLK: 100.49 MHz
VCP: 1.016V

Memory: 8192 MB
Memory Frequency: 2133 MHz
VDIMM: 1.216V
Temperature CPU: 37°C PCH: 36°C

Processor Information

Name	Kabylake DT
Type	Genuine Intel(R) CPU 0000 @ 3.00GHz
Speed	3000 MHz
ID	0x500E8
Stepping	A0
Number of Processors	4Core(s) / 8Thread(s)
Advanced Option	<input type="checkbox"/>

CPU OverClocking
CPU Configuration
Power & Performance

Arrow Key: Move
Enter Key: Select
F2 Key: Help
ESC Key: Exit
F1 Key: General Help

CPU_FAN1 Sensor: CPU Temperature Speed: NA
CPU_FAN2 Sensor: CPU Temperature Speed: NA
SYS_FAN1 Sensor: PCH Temperature Speed: NA
SYS_FAN2 Sensor: PCH Temperature Speed: 1368RPM
SYS_FAN3 Sensor: PCH Temperature Speed: NA

Version 1.01.0040. Copyright (C) 2017 American Megatrends, Inc.

Each BIOS menu option is described in this manual. The Main BIOS Setup screen has two main areas. The left area is the Main Navigation, and the main area is for the Information Section. Icons that do not respond when the mouse pointer is hovering on top are not configurable.

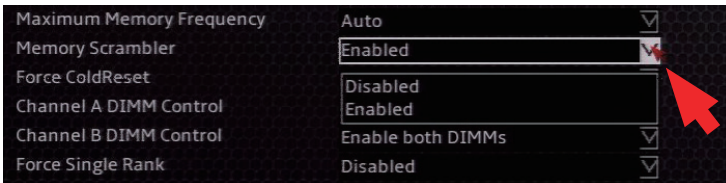

The AMI BIOS GUI setup utility uses a mouse pointer navigation system similar to standard graphical user interfaces. Hover and click an icon to select a section, click a down arrow to select from an options list.

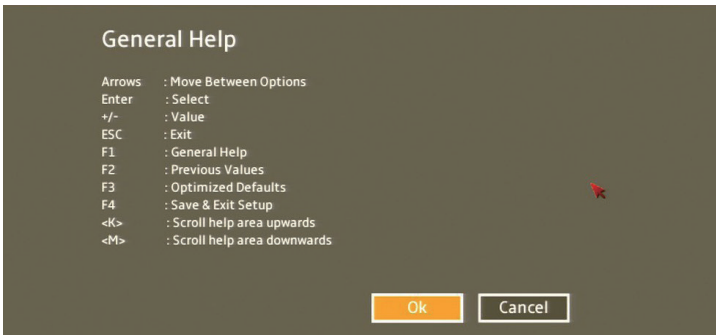

You may press the <F1> on any screen under the Setup Section to see a list of Hot Keys that are available. Press <F12> to print the screen.

The keyboard's Escape key <ESC> cancels the current screen and will allow you to return to the previous screen.

How To Change the Configuration Data

The configuration data that determines the system parameters may be changed by entering the AMI BIOS GUI setup utility. This setup utility can be accessed by pressing at the appropriate time during system boot.



Note: For the purposes of this manual, options that are printed in **Bold** are default settings.

How to Start the Setup Utility

Normally, the only visible Power-On Self-Test (POST) routine is the memory test. As the memory is being tested, press the <Delete> key to enter the main menu of the AMI BIOS GUI setup utility. From the Setup Home screen, you can access the other Setup Sections.

4-2 System Information

The System Information Panel displays the motherboard's configuration.

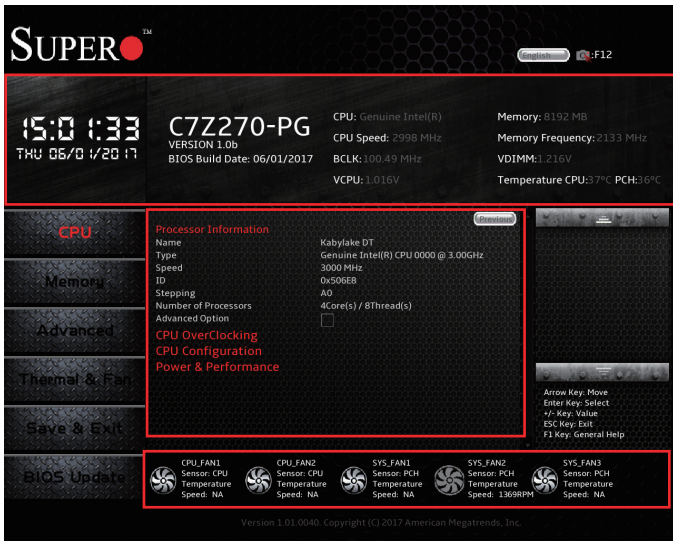

The following information among others is displayed in this section:

- **Motherboard Model Name** - C7Z270-PG.
- **BIOS Version** - This item displays the BIOS version number.
- **Build Date and Time** - displays the BIOS build date and Time.
- **CPU** - displays the CPU type speed, stepping, etc
- **CPU Fan Data** - displays sensor type, temperature, speed

System Date

Click on the date to open the setup fields. This item sets and displays the system date. Click the up and down arrows to adjust the date.

System Time

Click on the time to open the setup fields. This item sets and displays the system time. Click the up and down arrows to adjust the system time.

4-3 CPU

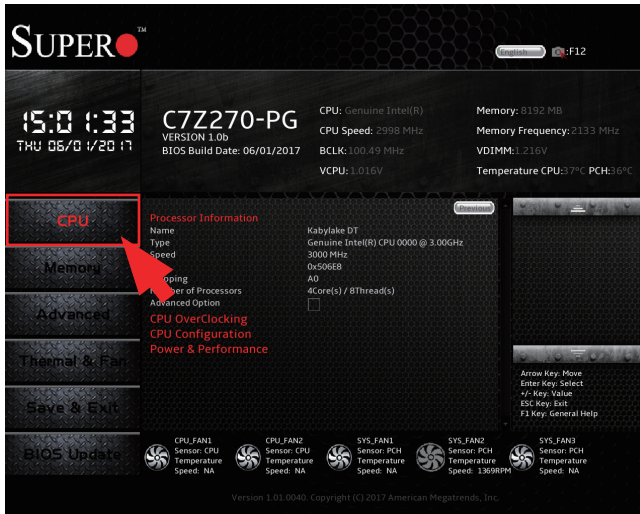

The following information is displayed in this section:

- **Name** - indicates the model name of the CPU.
- **Type** - indicates the brand, model name, model number of the CPU and it's rated clock speed.
- **Speed** - this item shows the detected CPU speed.
- **ID** - displays the unique CPU ID.
- **Stepping** - displays the processor stepping.
- **Number of Processors** - displays the number of cores detected.
- **Advanced Option** - the default is Unchecked (Disabled).

**If Advanced Option is set to Enabled (Checked), the following information will appear:*

- **Microcode Revision** - displays the CPU's microcode patch version.
- **GT Info** - this item shows the processor's GT Information.
- **IGFX VBIOS Version** - this item shows the Integrated Graphics VBIOS version.

- **IGFX GOP Version** - this item shows the Integrated Graphics VOP version.
- **Memory RC Version** - this item shows the memory RC version.

CPU OverClocking

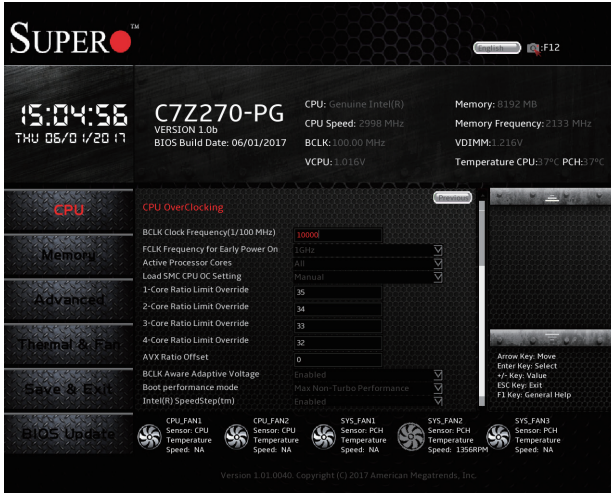

Note: For the C7Z270-PG, Intel® Core™ i7/i5/i3 K series processors are capable of overclocking.

BCLK Clock Frequency (1/100 MHz)

Use this item to set the CPU clock override value for the host system. The default setting is **10000**.

FCLK Frequency for Early Power On

Select the FCLK frequency for early power on. The options are Normal (800MHz), **1GHz**, and 400MHz.

Active Processor Cores

Use this feature to select the number of active processor cores. The options are **All**, 1, 2, 3, and 4. (These options depend on how many cores are supported by the CPU.)

Load SMC CPU OC Setting

This item has optimized pre-configured overclocking settings. Select one to activate. The options are **Manual** and 4.0GHz~5.5GHz (in 100MHz increments).

1-Core Ratio Limit Override

Enter a value between 0 to 83. The minimum range may vary between processors. This 1-Core Ratio Limit must be greater than or equal to 2-Core Ratio Limit, 3-Core Ratio Limit, and 4-Core Ratio Limit. The default setting is based on CPU.

2-Core Ratio Limit Override

Enter a value between 0 to 83. The minimum range may vary between processors. This 2-Core Ratio Limit must be less than or equal to 1-Core Ratio Limit. The default setting is based on CPU.

3-Core Ratio Limit Override

Enter a value between 0 to 83. The minimum range may vary between processors. This 3-Core Ratio Limit must be less than or equal to 1-Core Ratio Limit. The default setting is based on CPU.

4-Core Ratio Limit Override

Enter a value between 0 to 83. The minimum range may vary between processors. This 4-Core Ratio Limit must be less than or equal to 1-Core Ratio Limit. The default setting is based on CPU.

AVX Ratio Offset

This item specifies a negative offset from the Turbo Ratio Limit MSR for AVX workloads. AVX is a more stressful workload, it is helpful to lower the AVX ratio to ensure maximum possible ratio for SSE workloads. Valid range is 0-31.

BCLK Aware Adaptive Voltage

When enabled, pcode will be aware of the BCLK frequency when calculating the CPV/F curves. This is ideal for BCLK to avoid high voltage overrides. The options are Disabled and **Enabled**.

Boot performance mode

This option enables the selection of the default CPU performance during system boot. The options are Max Battery, **Max Non-Turbo Performance**, and Turbo Performance.

Intel(R) SpeedStep(tm)

Enhanced Intel SpeedStep Technology (EIST) allows the system to automatically adjust processor voltage and core frequency in an effort to reduce power consumption and heat dissipation. **Please refer to Intel's web site for detailed information.** The options are Disabled and **Enabled**.

Turbo Mode

This feature allows processor cores to run faster than the rated operating frequency in specific conditions. The options are Disabled and **Enabled**.

Configurable TDP Boot Mode

This feature sets the TDP Boot Mode to either **Nominal**, Down, Up, or Deactivated. When deactivated, it will set MSR to Nominal and MMIO to zero.

Configurable TDP Lock

This option sets the lock bits on TURBO_ACTIVATION_RATIO and CONFIG_TDP_CONTROL. When lock is enabled, Custom Config TDP Count will be forced to 1 and Custom Config TDP Boot Index will be forced to 0. The options are Enabled and **Disabled**.

Power Limit 1 Override

This feature disables or enables the Power Limit 1 Override. If this option is disabled, the BIOS will program the default values for Power Limit and Power Limit 1 Time Window. The options are Disabled and **Enabled**.

Power Limit 1

This feature configures Package Power Limit 1, in milliwatts. When the limit is exceeded, the CPU ratio is lowered after a period of time (see item below). A lower limit can save power and protect the CPU, while a higher limit improves performance. This value must be between Min Power Limit TDP limit. If value is '0' the BIOS will program the TDP value. Use the number keys on your keyboard to enter the value. The default setting is dependent on the CPU.

Power Limit 1 Time Window

This item determines how long the time window over which the TDP value is maintained. Use the number keys on your keyboard to enter the value. The default setting is **8**. This value may vary between 0~128.

Power Limit 2 Override

This feature disables or enables the Power Limit 2 Override. If this option is disabled, the BIOS will program the default values for Power Limit and Power Limit 2 Time Window. The options are Disabled and **Enabled**.

Power Limit 2

This feature configures Package Power Limit 2, in milliwatts. When the limit is exceeded, the CPU ratio is lowered after a period of time (see item below). A lower limit can save power and protect the CPU, while a higher limit improves performance. This value must be between Min Power Limit TDP limit. If value is '0' the BIOS will program the TDP value. Use the number keys on your keyboard to enter the value. The default setting is dependent on the CPU.

Power Limit 3 Override

This feature disables or enables the Power Limit 3 Override. If this option is disabled, the BIOS will program the default values for Power Limit and Power Limit 3 Time Window. The options are **Disabled** and Enabled.

Power Limit 4 Override

This feature disables or enables the Power Limit 4 Override. If this option is disabled, the BIOS will program the default values for Power Limit and Power Limit 4 Time Window. The options are **Disabled** and Enabled.

CPU Flex Ratio Override

Select Enabled to activate CPU Flex Ratio programming. The options are **Disabled** and Enabled.

CPU Flex Ratio Settings

When CPU Flex Ratio Override is enabled, this sets the value for the CPU Flex Ratio. The default is **30**.

Core Max OC Ratio

This option sets the maximum overclocking ratio for the CPU core. The allowable range is 8~83.

System Agent Voltage (mV)

This option sets the System Agent Voltage in mV.

Core Voltage Mode

Use this feature to select the Core voltage mode. The options are Adaptive and **Override**.

If the feature above is set to Override, SVID and Core Voltage Override are available for configuration.

SVID

(If the feature above, Core Voltage Mode, is set to Override.) Use this feature to enable/disable SVID. The options are **Disabled** and Enabled.

Core Voltage Override

(If the feature above, Core Voltage Mode, is set to Override.) Use this feature to set the core voltage override value.

Core Extra Turbo Voltage

(If the feature above, Core Voltage Mode, is set to Adaptive.) Use this feature to set the extra voltage applied while GT is operating in turbo mode. Specify a value from 0mV to 2000mV. Enter **0** to use the manufacturer default value.

Core Voltage Offset

Use this feature to set the CPU Voltage Offset value from -500mV to +500mV. Enter **0** to use the manufacturer default value.

Offset Prefix

Use this feature to set the Core Voltage Offset value as a positive (+) number or a negative (-) number. The default setting is "+".

Core PLL Voltage Offset

Use this feature to set the CPU PLL Voltage Offset value from 0-63 with each unit at 15mV. This is used to increase the range of the core frequency in extreme overclocking conditions. Enter **0** to use the manufacturer default value.

Ring Max OC Ratio

Use this feature to set the maximum overclocking ratio for the RING Domain. Enter a value or press "+" or "-" on your keyboard to change the value.

Ring Min OC Ratio

Use this feature to set the minimum overclocking ratio for the RING Domain. Enter a value or press "+" or "-" on your keyboard to change the value.

Uncore Voltage Offset

Use this feature to specify the Offset Voltage applied to the Uncore domain. Enter a value or press "+" or "-" on your keyboard to change the value.

PCH Voltage

Use this feature to trim the PCH Voltage. Select from these values: **1.00V**, 1.05V, 1.10V, 1.15V, 1.20V, 1.25V, and 1.30V.

CPU PLL Voltage

Use this feature to trim the CPU PLL Voltage. Select from these values: **1.20V**, 1.25V, 1.30V, 1.35V, 1.40V, 1.45V, and 1.50V.

CPU_IO Voltage

Use this feature to calibrate the CPU I/O Voltage. Select from these values: **0.975V**, 1.15V, 1.30V, and 1.50V.

Load Line Calibration

Load line calibration is vDroop, which is the tendency for a CPU's vCore to drop when going from an idle state to a load state. Set this feature to auto, or select a specific level to reduce vDroop. The options are **Disabled**, Level 1~7, and Auto.

CPU Configuration

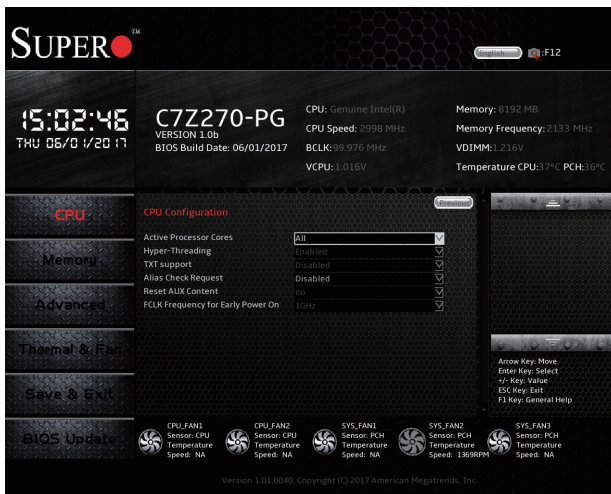

Active Processor Cores

Use this feature to select the number of active processor cores. The options are **All**, 1, 2, and 3. (These options depend on how many cores are supported by the CPU.)

Hyper-Threading

Select Enabled to support Intel Hyper-threading Technology to enhance CPU performance. The options are Disabled and **Enabled**.

TXT support

Intel TXT (Trusted Execution Technology) helps protect against software-based attacks and ensures protection, confidentiality and integrity of data stored or created on the system. The options are **Disabled** and Enabled.

Alias Check Request

**If TXT support is Enabled, the features Alias Check Request is available for configuration.*

Use this feature to set up Alias Check Request. The options are **Disabled** and Enabled.

Reset AUX Content

**If TXT support is Disabled, the features Reset AUX Content is available for configuration.*

Use this feature to reset the TPM Auxiliary content. The options are yes or **no**.

FCLK Frequency for Early Power On

Select the FCLK frequency for early power on. The options are Normal (800MHz), **1GHz**, and 400MHz.

**If Advanced Option (on page 4-4) is set to Enabled (Checked), the following information will appear.*

The following CPU information will be displayed:

- **Type** - indicates the brand, model name, model number of the CPU and it's rated clock speed.
- **ID** - displays the unique CPU ID.
- **Speed** - this item shows the detected CPU speed.
- **L1 Data Cache** - indicates if Level 1 cache is supported.

- **L1 Instruction Cache** - displays if Level 1 instruction cache is supported.
- **L2 Cache** - indicates if Level 2 cache is supported.
- **L3 Cache** - displays whether Level 3 cache is supported or not.
- **L4 Cache** - indicates if Level 4 cache is supported.
- **VMX** - indicates if VMX is supported.
- **SMX/TXT** - indicates if SMX/TXT is supported.

C6DRAM

Select Enabled to activate moving the DRAM contents to PRM memory when CPU is in C6 State. The options are **Disabled** and Enabled.

SW Guard Extension (SGX)

Select Enabled to activate the Software Guard Extensions (SGX). The options are **Software Controlled**, Enabled, and Disabled.

Select Owner EPOCH input type

There are three Owner EPOCH modes (Each EPOCH is 64 bit). The options are **No Change in Owner EPOCHs**, Change to New Random Owner EPOCHs, and Manual User Defined Owner EPOCHs.

PRMRR Size

The BIOS must reserve a contiguous region of Processor Reserved Memory (PRM) in the Processor Reserved Memory Range Register (PRMRR). This item appears if SW Guard Extensions is enabled. The options are **Auto**, 32MB, 64MB, and 128MB.

Hardware Prefetcher

(Available when supported by the CPU)

If this item is set to Enabled, the hardware prefetcher will prefetch streams of data and instructions from the main memory to the L2 cache to improve CPU performance. The options are Disabled and **Enabled**.

Adjacent Cache Line Prefetch

(Available when supported by the CPU)

Select Enabled for the CPU to prefetch both cache lines for 128 bytes as comprised. Select Disabled for the CPU to prefetch both cache lines for 64 bytes. The options are Disabled and **Enabled**.

Intel (VMX) Virtualization Technology

(Available when supported by the CPU)

Select Enabled to use the Intel Virtualization Technology to allow one platform to run multiple operating systems and applications in independent partitions, creating multiple "virtual" systems in one physical computer. The options are Disabled and **Enabled**.



Note: If there is any change to this setting, you will need to power off and reboot the system for the change to take effect. Please refer to Intel's web site for detailed information.

BIST

Select Enabled to activate the Built-In Self Test (BIST) on reset. The options are **Disabled** and Enabled.

AES

Select Enable for Intel CPU Advanced Encryption Standard (AES) Instructions support to enhance data integrity. The options are Disabled and **Enabled**.

Machine Check

Select Enable to activate Machine Check. The options are Disabled and **Enabled**.

MonitorMWait

Select Enable to activate MonitorMWait. The options are Disabled and **Enabled**.

CPU SMM Enhancement

SMM Code Access Check

Select Enabled to activate support for SMM Code Access feature. The options are **Disabled** and Enabled.

SMM Use Delay Indication

Select Enabled to activate usage of SMM_DELAYED MSR for MP sync in SMI feature. The options are **Disabled** and Enabled.

SMM Use Block Indication

Select Enabled to activate usage of SMM_BLOCKED MSR for MP sync ins SMI feature. The options are **Disabled** and Enabled.

Power and Performance

CPU - Power Management Control

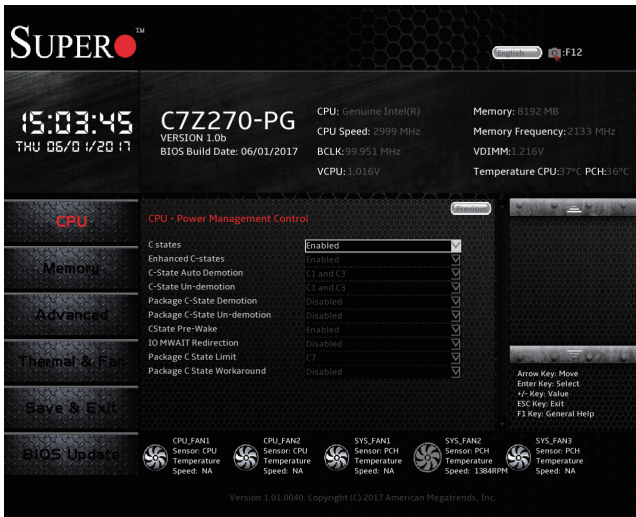

Boot performance mode

This option enables the selection of the default CPU performance during system boot. The options are Max Battery, **Max Non-Turbo Performance**, and Turbo Performance.

Intel(R) SpeedStep(tm)

Intel SpeedStep Technology allows the system to automatically adjust processor voltage and core frequency in an effort to reduce power consumption and heat dissipation. **Please refer to Intel's web site for detailed information.** The options are Disabled and **Enabled**.

C States

C-States architecture, a processor power management platform developed by Intel, can further reduce power consumption from the basic C1 (Halt State) state that blocks clock cycles to the CPU. Select Enabled for CPU C States support. The options are **Enabled** and Disabled.

**If C States is set to Enabled, the following items are available for configuration.*

Enhanced C-states

Select Enabled to enable Enhanced C1 Power State to boost system performance. The options are Disabled and **Enabled**.

C-State Auto Demotion

When this item is enabled, the CPU will conditionally demote C State based on un-cored auto-demote information. The options are Disabled, C1, C3, and **C1 and C3**.

C-State Un-demotion

When this item is enabled, the CPU will conditionally undemote from demoted C3 or C1. The options are Disabled, C1, C3, and **C1 and C3**.

Package C-State Demotion

This item enables the Package C-State demotion. The options are **Disabled** and Enabled.

Package C-State Un-Demotion

When this item is enabled, the CPU will conditionally undemote from demoted Packaged Package C-State Un-Demotion. The options are **Disabled** and Enabled.

CState Pre-Wake

Use this option to enable or disable the C-State pre wake. The options are Disabled and **Enabled**.

IO MWAIT Redirection

When set, this option will map I/O read instructions sent to the I/O registers PMG_IO_BASE_ADDRBASE+offset to MWAIT (offset). The options are **Disabled** and Enabled.

Package C State Limit

Select Auto for the AMI BIOS to automatically set the limit on the C-State package register. The options are Auto, Cpu Default, C10, C9, C8, C7s, **C7**, C6, C3, C2, and C0/C1.

Package C State Workaround

Enable this feature to fix old HDDs that have problems entering the Package C State. The options are **Disabled** and Enabled.

GT - Power Management Control

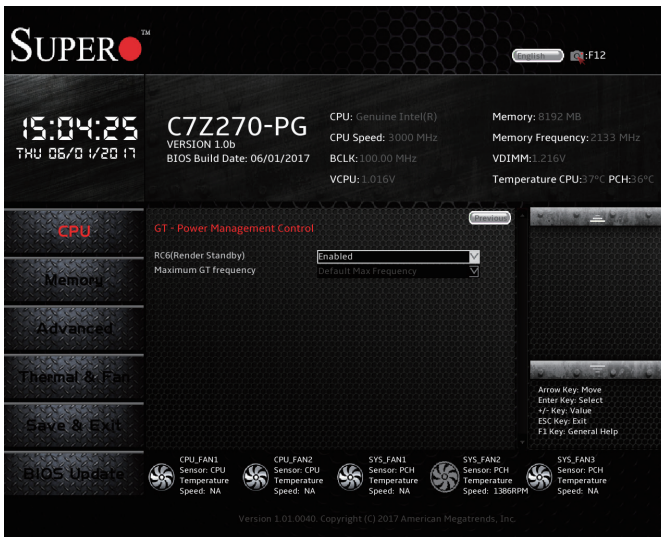

RC6 (Render Standby)

Use this feature enable Render Standby support. The options are **Enabled** and Disabled.

Maximum GT Frequency

This option is the Maximum GT Frequency as defined by the user. Choose between 300MHz (RPN) and 1200MHz (RP0). Any value beyond this range will be clipped to its min/max supported by the CPU. The options are **Default Max Frequency** and 100MHz through 1200MHz (in increments of 50MHz).

4-4 Memory

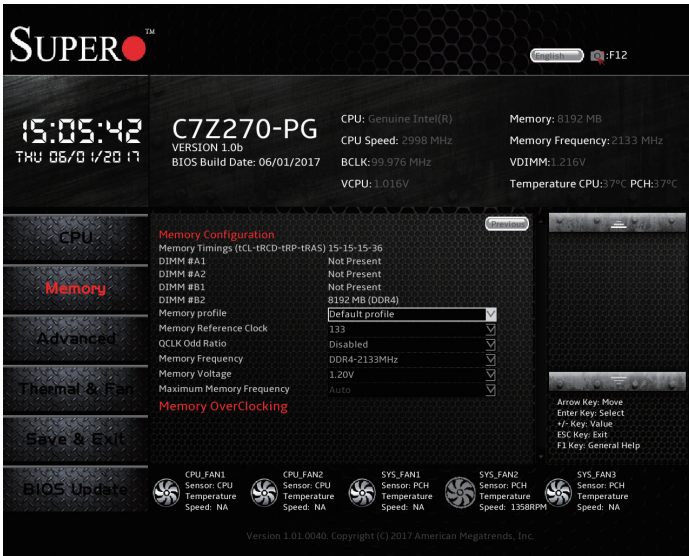

The following information is displayed in this section:

- **Memory RC Version**
- **Memory Frequency**
- **Memory Timings (tCL-tRCD-tRP-tRAS)**
- **DIMM#A1 ~ DIMM#B2**

Memory profile

Use this feature to set the DIMM timing profile which may cause impact on memory behavior. The options are **Default Profile**, Custom profile, and XMP profile 1.

**If Memory profile is set to Custom profile, the following four items are available for configuration.*

Memory Reference Clock

This option selects the Memory Clock ratio. The options are Auto, **133**, and 100. All values are in MHz.

QCLK Odd Ratio

This option enables or disables the quadrature clock odd ratio. The options are **Disabled** and Enabled.

Memory Frequency

This option selects the type/speed of the memory installed. The options are Auto, DDR4-1067MHz, DDR4-1333MHz, DDR4-1600MHz, DDR4-1867MHz, DDR4-2133MHz, DDR4-2400MHz, DDR4-2667MHz, DDR4-2933, DDR4-3200MHz, DDR4-3467MHz, DDR4-3733MHz, DDR4-4000MHz, DDR4-4267MHz, DDR4-4533MHz, and DDR4-4800MHz.

Default speed is auto detected.

Memory Voltage

This option selects the Memory Voltage Override. The options are **Default**, 1.20V, 1.25V, 1.30V, 1.35V, 1.40V, 1.45V, 1.50V, 1.55V, 1.60V, 1.65V, 1.70V, and 1.75V.

Maximum Memory Frequency

This option selects the type/speed of the memory installed. The options are Auto, 1067, 1333, 1600, 1867, 2133, 2400, 2667, 2933, 3200, 3467, 3733, 4000, and 4133. All values are in MHz. **Default speed is auto detected.**

Memory Scrambler

This feature enables or disables memory scrambler support for memory error correction. The settings are Disabled and **Enabled**.

Force ColdReset

Use this feature when ColdBoot is required during MRC execution. The settings are Enabled and **Disabled**.

Force Single Rank

When enabled, only Rank0 will be use in each DIMM. The settings are **Disabled** and Enabled.

Memory Remap

PCI memory resources will overlap with the total physical memory if 4GB of memory or above is installed on the motherboard. When this occurs, **Enable** this function to reallocate the overlapped physical memory to a location above the total physical memory to resolve the memory overlapping situation. The options are **Enabled** and Disabled.

MRC Fast Boot

This feature enables or disables fast path through MRC. The settings are Disabled and **Enabled**.

Memory OverClocking

The stored values for Default, Custom, XMP1, and XMP2 memory profiles in that particular order will be displayed in these fields.

- **tCK (MHz)**
- **tCL**
- **tRCD/tRP**
- **tRAS**
- **tCWL**
- **tFAW**
- **tREFI**
- **tRFC**
- **tRRD**
- **tRTP**
- **tWR**
- **tWTR**
- **NMode**
- **VDD [mV]**

Memory Profile

Use this feature to set Performance Memory Profiles which may cause impact on memory behavior. The options are **Default profile**, Custom profile, and XMP Profile 1.

If Default is selected, the installed memory will run at 2200MHz if the detected memory is rated at 2400MHz or above, and run at 1867MHz if the memory detected is rated at 1867MHz.

Memory Reference Clock

This option selects the Memory Clock ratio. The options are Auto, **133**, and 100. All values are in MHz.

QCLK Odd Ratio

This option enables or disables the quadrature clock odd ratio. The options are **Disabled** and Enabled.

Memory Frequency

This option selects the type/speed of the memory installed. The options are Auto, DDR4-1067MHz, DDR4-1333MHz, DDR4-1600MHz, DDR4-1867MHz, DDR4-2133MHz, DDR4-2400MHz, DDR4-2667MHz, DDR4-2933, DDR4-3200MHz, DDR4-3467MHz, DDR4-3733MHz, DDR4-4000MHz, DDR4-4267MHz, DDR4-4533MHz, and DDR4-4800MHz.

Default speed is auto detected.

Memory Voltage

This option selects the Memory Voltage The options are **Default**, 1.20V, 1.25V, 1.30V, 1.35V, 1.40V, 1.45V, 1.50V, 1.55V, 1.60V, 1.65V, 1.70V, and 1.75V.

**If Memory profile is set to Custom profile, the following options appear.*

tCL

This option configures the Cas Latency Range. Enter a number between 4-18. The default is **15**.

tRCD/tRP

This option selects the Ras Precharge Range and Row to Col Delay Range. Enter a number between 1-38. The default is **15**.

tRAS

This option selects the Ras Active Time. Enter a number between 1-586. The default is **36**.

Minimum CAS Write Latency Time (tCWL)

This option selects the Minimum CAS Write Latency Time. Enter a numeric value. The default is **14**.

tFAW

This option selects the Minimum Four Activate Window Delay Time. Enter a numeric value between 1-586. The default is **23**.

Maximum tREFI Time (tREFI)

This option configures the Maximum tREFI Time (Average Periodic Refresh Interval). Enter a numeric value. The default is **8316**.

tRFC

This option selects the Minimum Refresh Recovery Delay Time. Enter a number between 1-9363. The default is **374**.

tRRD

This option selects the Minimum Row Active To Row Active Delay Time. Enter a number between 1-38. The default is **11**.

tRTP

This option configures the Internal Read to Precharge Command Delay Time. Enter a number between 1-38. The default is **8**.

tWR

This option configures the Minimum Write Recovery Time. Enter a number between 1-38. The default is **16**.

tWTR

This option configures the Minimum Internal Write to Read Command Delay Time. Enter a number between 1-38. The default is **0**.

NMode

This option configures NMode. The default is **2**.

3rd timing:**tRPab_ext**

This option configures the tRPab_ext. Enter a numeric value. The default is **0**.

tRDPRE

This option configures the tRDPRE. Enter a numeric value. The default is **8**.

tWRPRE

This option configures the tWRPRE. Enter a numeric value. The default is **34**.

tRRD_sg

This option configures the tRRD_sg. Enter a numeric value. The default is **6**.

tRRD_dg

This option configures the tRRD_dg. Enter a numeric value. The default is **4**.

derating_ext

This option configures the derating_ext. Enter a numeric value. The default is **2**.

ODT_read_duration

This option configures the ODT Read Duration. Enter a numeric value. The default is **0**.

ODT_Read_Delay

This option configures the ODT Read Delay. Enter a numeric value. The default is **1**.

ODT_write_duration

This option configures the ODT Write Duration. Enter a numeric value. The default is **0**.

ODT_Write_Delay

This option configures the ODT Write Delay. Enter a numeric value. The default is **0**.

Write_Early_ODT

This option configures the Write Early ODT. Enter a numeric value. The default is **0**.

tAONPD

This option configures the tAONPD. The default is **10**.

ODT_Always_Rank0

This option configures the ODT Always Rank0. Enter a numeric value. The default is **0**.

tRDRD_sg

This option configures the between module read to read delay (tRDRD_sg). Enter a numeric value. The default is **6**.

tRDRD_dg

This option configures the between module read to read delay (tRDRD_dg). Enter a numeric value. The default is **4**.

tRDRD_dr

This option configures the between module read to read delay (tRDRD_dr). Enter a numeric value. The default is **6**.

tRDRD_dd

This option configures the between module read to read delay (tRDRD_dd). Enter a numeric value. The default is **7**.

tRDWR_sg

This option configures the between module read to write delay (tRDWR_sg). Enter a numeric value. The default is **10**.

tRDWR_dg

This option configures the between module read to write delay (tRDWR_dg). Enter a numeric value. The default is **10**.

tRDWR_dr

This option configures the between module read to write delay (tRDWR_dr). Enter a numeric value. The default is **10**.

tRDWR_dd

This option configures the between module read to write delay (tRDWR_dd). Enter a numeric value. The default is **11**.

tWRRD_sg

This option configures the between module read to write delay (tWRRD_sg). Enter a numeric value. The default is **28**.

tWRRD_dg

This option configures the between module read to write delay (tWRRD_dg). Enter a numeric value. The default is **23**.

tWRRD_dr

This option configures the between module read to write delay (tWRRD_dr). Enter a numeric value. The default is **6**.

tWRRD_dd

This option configures the between module read to write delay (tWRRD_dd). Enter a numeric value. The default is **6**.

tRWRW_sg

This option configures the between module read to write delay (tRWRW_sg). Enter a numeric value. The default is **6**.

tRWRW_dg

This option configures the between module read to write delay (tRWRW_dg). Enter a numeric value. The default is **4**.

tRWRW_dr

This option configures the between module read to write delay (tRWRW_dr). Enter a numeric value. The default is **7**.

tRWRW_dd

This option configures the between module read to write delay (tRWRW_dd). Enter a numeric value. The default is **7**.

tXP

This option configures tXP. Enter a numeric value. The default is **7**.

tXPDLL

This option configures tXPDLL. Enter a numeric value. The default is **26**.

tPRPDEN

This option configures tPRPDEN. Enter a numeric value. The default is **2**.

tRDPDEN

This option configures tRDPDEN. Enter a numeric value. The default is **20**.

tWRPDEN

This option configures tWRPDEN. Enter a numeric value. The default is **34**.

DIIBwEn[0]

This option configures DIIBwEn[0]. Enter a numeric value. The default is **0**.

DIIBwEn[1]

This option configures DIIBwEn[1]. Enter a numeric value. The default is **1**.

DIIBwEn[2]

This option configures DIIBwEn[2]. Enter a numeric value. The default is **2**.

DIIBwEn[3]

This option configures DIIBwEn[3]. Enter a numeric value. The default is **2**.

4-5 Advanced

Boot Feature

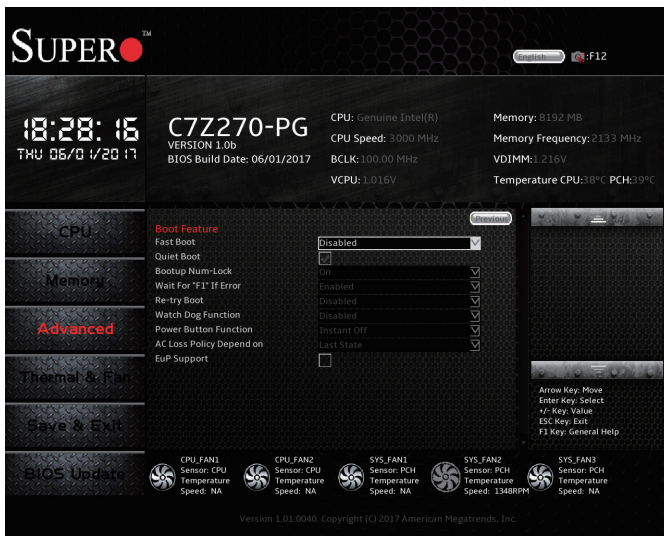

Fast Boot

Select Enabled to skip the routine memory procedure and attempt to boot the system using the last valid memory configuration settings at bootup. The options are **Disabled** and Enabled.

Quiet Boot

Use this feature to select the screen display between the POST messages and the OEM logo upon bootup. Uncheck the box to display the POST messages. Check the box to display the OEM logo instead of the normal POST messages.

Bootup Num-Lock

Use this feature to set the Power-on state for the <Numlock> key. The options are Off and **On**.

Wait for "F1" If Error

Use this feature to force the system to wait until the 'F1' key is pressed if an error occurs. The options are Disabled and **Enabled**.

Re-try Boot

If this item is enabled, the BIOS will automatically reboot the system from a specified boot device after its initial boot failure. The options are **Disabled**, Legacy Boot, and EFI Boot.

Watch Dog Function

If enabled, the Watch Dog Timer will allow the system to reset or generate NMI based on jumper settings when it is expired for more than 5 minutes. The options are **Disabled** and Enabled.

Power Button Function

This feature controls how the system shuts down when the power button is pressed. Select 4 Seconds Override for the user to power off the system after pressing and holding the power button for 4 seconds or longer. Select Instant Off to instantly power off the system as soon as the user presses the power button. The options are **Instant Off** and 4 Seconds Override.

AC Loss Policy Depend On

Use this feature to set the power state after a power outage. Select Stay Off for the system power to remain off after a power loss. Select Power On for the system power to be turned on after a power loss. Select Last State to allow the system to resume its last power state before a power loss. The options are Stay Off, Power On, and **Last State**.

EuP Support

EuP, or Energy Using Product, is a European energy-saving specification that sets a standard on the maximum total power consumption on electrical products. Check the box to activate EUP support. The default is **Disabled (Unchecked)**.

NCT6792D Super IO Configuration



SuperIO Chip NCT6792D

Serial Port 1 Configuration

Serial Port

This item will Enable or Disable Serial Port 1 (COM1). Place a tick mark on the box to enable Serial Port 1. The default is **Checked (Enabled)**.

Device Settings

This item displays the current IRQ setting for Serial Port 1 (COM1).

Change Settings

This item configures the IRQ setting for Serial Port 1 (COM1).

The options for Serial Port 1 are **Auto**, (IO=3F8h; IRQ=4), (IO=3F8h; IRQ=3, 4, 5, 6, 7, 9, 10, 11, 12), (IO=2F8h; IRQ=3, 4, 5, 6, 7, 9, 10, 11, 12), (IO=3E8h; IRQ=3, 4, 5, 6, 7, 9, 10, 11, 12), and (IO=2E8h; IRQ=3, 4, 5, 6, 7, 9, 10, 11, 12).

Serial Port Console Redirection

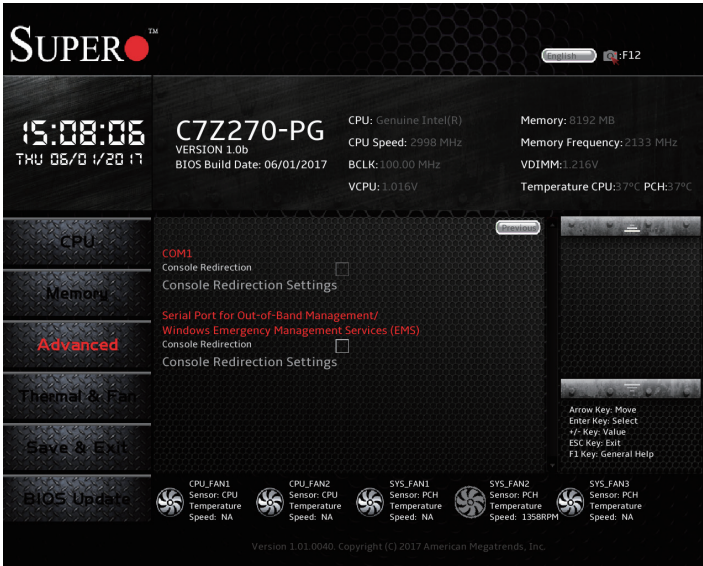

COM 1

Console Redirection

Select Enabled to enable COM Port 1 Console Redirection, which will allow a client machine to be connected to a host machine at a remote site for networking. The default is **Unchecked (Disabled)**.

**If the item above is set to Enabled, the following items will become available for configuration:*

Console Redirection Settings

Terminal Type

This feature allows the user to select the target terminal emulation type for Console Redirection. Select VT100 to use the ASCII character set. Select VT100+ to add color and function key support. Select ANSI to use the Extended ASCII character set. Select VT-UTF8 to use UTF8 encoding to map Unicode characters into one or more bytes. The options are VT100, VT100+, VT-UTF8, and **ANSI**.

Bits per second

Use this item to set the transmission speed for a serial port used in Console Redirection. Make sure that the same speed is used in the

host computer and the client computer. A lower transmission speed may be required for long and busy lines. The options are 9600, 19200, 38400, 57600, and **115200** (bits per second).

Data Bits

Use this feature to set the data transmission size for Console Redirection. The options are 7 (Bits) and **8 (Bits)**.

Parity

A parity bit can be sent along with regular data bits to detect data transmission errors. Select Even if the parity bit is set to 0, and the number of 1's in data bits is even. Select Odd if the parity bit is set to 0, and the number of 1's in data bits is odd. Select None if you do not want to send a parity bit with your data bits in transmission. Select Mark to add a mark as a parity bit to be sent along with the data bits. Select Space to add a Space as a parity bit to be sent with your data bits. The options are **None**, Even, Odd, Mark, and Space.

Stop Bits

A stop bit indicates the end of a serial data packet. Select 1 Stop Bit for standard serial data communication. Select 2 Stop Bits if slower devices are used. The options are **1** and 2.

Flow Control

Use this item to set the flow control for Console Redirection to prevent data loss caused by buffer overflow. Send a "Stop" signal to stop sending data when the receiving buffer is full. Send a "Start" signal to start sending data when the receiving buffer is empty. The options are **None** and Hardware RTS/CTS.

VT-UTF8 Combo Key Support

Select Enabled to enable VT-UTF8 Combination Key support for ANSI/VT100 terminals. The default is **Checked (Enabled)**.

Recorder Mode

Select Enabled to capture the data displayed on a terminal and send it as text messages to a remote server. The default is **Unchecked (Disabled)**.

Resolution 100x31

Select Enabled for extended-terminal resolution support. The default is **Unchecked (Disabled)**.

Legacy OS Redirection Resolution

Use this item to select the number of rows and columns used in Console Redirection for legacy OS support. The options are **80x24** and 80x25.

Putty KeyPad

This feature selects settings for the function keys and the key pad for Putty, which is a terminal emulator designed for the Windows OS. The options are **VT100**, LINUX, XTERMR6, SCO, ESCN, and VT400.

Redirection After BIOS POST

Use this feature to enable or disable legacy Console Redirection after BIOS POST. When the option-BootLoader is selected, legacy Console Redirection is disabled before booting the OS. When the option- Always Enable is selected, legacy Console Redirection remains enabled upon OS bootup. The options are **Always Enable** and BootLoader.

Serial Port for Out-of-Band Management/Windows Emergency Management Services (EMS)

The submenu allows the user to configure Console Redirection settings to support Out-of-Band Serial Port management.

Console Redirection

Select Enabled to use a COM port selected by the user for EMS Console Redirection. The default is **Unchecked (Disabled)**.

**If the item above is set to Enabled (Checked), the following items will become available for user configuration:*

Console Redirection Settings

Out-of-Band Mgmt Port

The feature selects a serial port in a client server to be used by the Windows Emergency Management Services (EMS) to communicate with a remote host server. The options are **dependent on the available COM ports**.

Terminal Type

Use this feature to select the target terminal emulation type for Console Redirection. Select VT100 to use the ASCII character set. Select VT100+ to add color and function key support. Select ANSI to use the extended ASCII character set. Select VT-UTF8 to use UTF8 encoding

to map Unicode characters into one or more bytes. The options are VT100, VT100+, **VT-UTF8**, and ANSI.

Bits per second

This item sets the transmission speed for a serial port used in Console Redirection. Make sure that the same speed is used in both host computer and the client computer. A lower transmission speed may be required for long and busy lines. The options are 9600, 19200, 57600, and **115200** (bits per second).

Flow Control

Use this item to set the flow control for Console Redirection to prevent data loss caused by buffer overflow. Send a "Stop" signal to stop data sending when the receiving buffer is full. Send a "Start" signal to start data sending when the receiving buffer is empty. The options are **None**, Hardware RTS/CTS, and Software Xon/Xoff.

The setting for each these features is displayed:

Data Bits, Parity, Stop Bits

System Agent (SA) Configuration

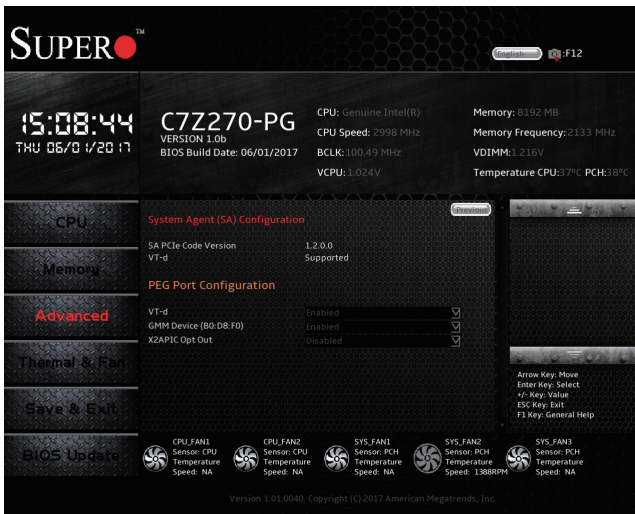

The following information will be displayed:

- **SA PCIe Code Version**
- **VT-d Capability**

PEG Port Configuration

PEG 0:1:0

Enable Root Port

Select **Enable** to activate the Root Port. The options are **Disabled**, **Enabled**, and **Auto**.

Max Link Speed

Select **Auto**, **Gen1**, **Gen2**, or **Gen3** to set the PEG Max Link Speed.

Max Link Width

Select **Auto**, **Force X1**, **Force X2**, **Force X4**, and **Force X8**.

Power Down Unused Lanes

Use this feature to power down the unused lanes based on the max possible link width. The options are **Disabled** and **Auto**.

ASPM

This feature configures the ASPM (Active State Power Management) settings for the graphics devices installed on PCI-E Slot 0, Slot 1, or Slot2. The options are **Disabled**, **Auto**, **ASPM L0s**, **ASPM L1**, and **ASPM L0sL1**.

De-emphasis Control

Use this feature to configure the De-emphasis control on PEG. The options are **-6 dB** and **-3.5 dB**.

PEG 0:1:1

Enable Root Port

Select **Enable** to activate the Root Port. The options are **Disabled**, **Enabled**, and **Auto**.

Max Link Speed

Select **Auto**, **Gen1**, **Gen2**, or **Gen3** to set the PEG Max Link Speed.

PEG 0:1:2

Enable Root Port

Select **Enable** to activate the Root Port. The options are **Disabled**, **Enabled**, and **Auto**.

Max Link Speed

Select **Auto**, Gen1, Gen2, or Gen3 to set the PEG Max Link Speed.

VT-d

This feature will enable/disable the VT-d capability. The options are Disabled and **Enabled**.

GMM Device (B0:D8:F0)

This feature will enable/disable the SA GMM device. The options are **Enabled** and Disabled.

X2APIC Opt Out

This feature will enable/disable the X2APIC_OPT_OUT bit. The options are Enabled and **Disabled**.

Graphics Configuration

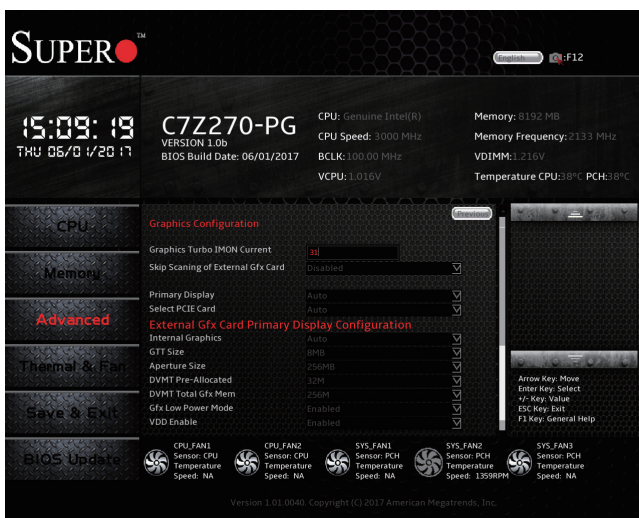

Graphics Turbo IMON Current

Use this feature to set the limit on the current voltage regulator. Valid range is 14-31. Default is **31**.

Skip Scanning of External Gfx Card

Use this feature to scan for External Gfx Card on PEG and PCH PCIe Ports. If this feature is enabled, the system will not scan for a new card. The options are **Disabled** or Enabled.

Primary Display

Use this feature to select the graphics device to be used as the primary display. Select from IGFX/PEG/PCI or select SG for switchable GFX. The options are **Auto**, IGFX, PEG, PCI, and SG.

Select PCIE Card

Use this feature to select Elk Creek 4, PEG Eval, or **Auto** to use on the platform.

External Gfx Card Primary Display Configuration

Primary PEG

This feature allows the user to select the primary PCI Express Graphics (PEG) slot. The options are **Auto**, PEG11, and PEG12.

Primary PCIE

This feature allows the user to specify which graphics card to be used as the primary graphics card. The options are **Auto**, PCIE1, PCIE2, PCIE3, PCIE4, PCIE5, PCIE6, PCIE7, PCIE8, PCIE9, PCIE10, PCIE11, PCIE12, PCIE13, PCIE14, PCIE15, PCIE16, PCIE17, PCIE18, and PCIE19.

Internal Graphics

This item keeps the Internal Graphics Device (IGD) enabled, based on setup options. The options are **Auto**, Disabled, and Enabled.

GTT Size

Use this feature to set the memory size to be used by the graphics translation table (GTT). The options are 2MB, 4MB, and **8MB**.

Aperture Size

Use this feature to set the Aperture size, which is the size of system memory reserved by the BIOS for graphics device use. The options are 128MB, **256MB**, 512MB, 1024MB, and 2048MB.

DVMT Pre-Allocated

Dynamic Video Memory Technology (DVMT) allows dynamic allocation of system memory to be used for video devices to ensure best use of available system memory based on the DVMT 5.0 platform. The options are 0M, **32M**, 64M, 4M, 8M, 12M, 16M, 20M, 24M, 28M, 32M/F7, 36M, 40M, 44M, 48M, 52M, 56M, and 60M.

DVMT Total Gfx Mem

Use this feature to set the total memory size to be used by internal graphics devices based on the DVMT 5.0 platform. The options are **256MB**, 128MB, and MAX.

Gfx Low Power Mode

Select Enabled to use the low power mode for internal graphics devices installed in a small form factor (SFF) computer. The options are **Enabled** and Disabled.

VDD Enable

Activating this feature will force VDD in the BIOS. The options are Disabled and **Enabled**.

HDCP Support

Activating this feature will enable HDCP (High-bandwidth Digital Content Protection) BIOS support. The options are **Enabled** and Disabled.

Algorithm

Select either **One-Time** or Periodic for HDCP re-encryption flow.

PM Support

Activating this feature will enable Power Management BIOS support. The options are **Enabled** and Disabled.

PAVP Enable

Use the feature to enable Protect Audio Video Path Mode. The options are **Enabled** and Disabled.

Cdynmax Clamping Enable

Enable this option to activate Cdynmas Clamping. The options are **Enabled** and Disabled.

Graphics Clock Frequency

Use this feature to set the internal graphics clock frequency. The options are 337.5MHz, 450MHz, 540MHz, and **675MHz**.

Graphics OverClocking

GT Slice Domain

GT OverClocking Frequency

This option selects the Overclocked RPO frequency in multiples of 50MHz. The default is **0**.

GT Voltage Mode

Use this feature to select the Overclocking GT mode. The options are **Adaptive** and **Override**.

GT Extra Turbo Voltage

(Available when GT Voltage Mode is set to Adaptive)

Use this feature to set the extra voltage applied while GT is operating in turbo mode. Specify a value from 0mV to 2000mV. Enter **0** to use the manufacture default value.

GT Voltage Override

(Available when GT Voltage Mode is set to Override)

Use this feature to set the Override Voltage applied to the GT domain. This voltage is specified in millivolts (mV) and uses the BIOS mailbox MSR 0x150, command 0x11. Specify a value from 0mV to 2000mV. Enter **0** to use the manufacture default value.

GT Voltage Offset

Use this feature to set the GT Adaptive voltage Target(mV) value from 0mV to 2000mV. Enter **0** to use the manufacture default value.

Offset Prefix

Use this feature to set the Offset value as a positive (+) number or a negative (-) number. The default setting is **"+"**.

GT Unslice Domain

GT OverClocking Frequency

This option selects the Overclocked RPO frequency in multiples of 50MHz. The default is **0**.

GT Voltage Mode

Use this feature to select the Overclocking GT mode. The options are **Adaptive** and **Override**.

GT Extra Turbo Voltage

(Available when GT Voltage Mode is set to Adaptive) Use this feature to set the extra voltage applied while GT is operating in turbo mode. Specify a value from 0mV to 2000mV. Enter **0** to use the manufacture default value.

GT Voltage Override

(Available when GT Voltage Mode is set to Override)

Use this feature to set the Override Voltage applied to the GT domain. This voltage is specified in millivolts (mV) and uses the BIOS mailbox MSR 0x150, command 0x11. Specify a value from 0mV to 2000mV. Enter **0** to use the manufacture default value.

GT Voltage Offset

Use this feature to set the GT Adaptive voltage Target(mV) value from 0mV to 2000mV. Enter **0** to use the manufacture default value.

Offset Prefix

Use this feature to set the Offset value as a positive (+) number or a negative (-) number. The default setting is "+".

GT-UnSliced VR Settings

GT-UnSliced Domain

VR Config Enable

Select **Enable** to activate VR configuration options. The options are **Disabled** and **Enabled**.

AC Loadline

AC Loadline is defined in 1/100 mOhms and uses the BIOS mailbox command 0x2. A value of 100 equals 1.0 mOhm, and 1255 is 12.55 mOhms. Valid range is 0-6249 (0-62.49 mOhms). Enter **0 for AUTO**.

DC Loadline

DC Loadline is defined in 1/100 mOhms and uses the BIOS mailbox command 0x2. A value of 100 equals 1.0 mOhm, and 1255 is 12.55 mOhms. Valid range is 0-6249 (0-62.49 mOhms). Enter **0 for AUTO**.

PS Current Threshold1

The PS Current Threshold1 is defined in 1/4A (Amperes) increments and uses the BIOS mailbox command 0x3. A value of 400 equals 100A. Range is 0-512 which translates to 0-128A. Enter 0 for AUTO. Default is **80 for 20A**.

PS Current Threshold2

The PS Current Threshold2 is defined in 1/4A (Amperes) increments and uses the BIOS mailbox command 0x3. A value of 400 equals 100A. Range is 0-512 which translates to 0-128A. Enter 0 for AUTO. Default is **20** for 5A.

PS Current Threshold3

The PS Current Threshold2 is defined in 1/4A (Amperes) increments and uses the BIOS mailbox command 0x3. A value of 400 equals 100A. Range is 0-512 which translates to 0-128A. Enter 0 for AUTO. Default is **4** for 1A.

PS3 Enable

Enable or Disables PS3. Uses BIOS VR mailbox command line 0x3. The options are Disabled and **Enabled**.

PS4 Enable

Enable or Disables PS4. Uses BIOS VR mailbox command line 0x3. The options are Disabled and **Enabled**.

IMON Slope

IMON (Load Current Monitor) Slope is defined in 1/100 increments and uses the BIOS VR mailbox command 0x4. Valid range is 0-200. For example, enter 125 for a 1.25 slope. Enter **0 for AUTO**.

IMON Offset

IMON Offset is defined in 1/1000 increments and uses the BIOS VR mailbox command 0x4. For example, enter 25,348 for a 25.348 offset. Valid range is 0-63999.

IMON Prefix

This feature sets the IMON offset value to a positive or negative number. The options are + and -.

VR Current Limit

This feature sets the Voltage Regulator current limit. The value represents the maximum instantaneous current allowed at any given time. The value is represented in 1/4A (Ampere) increments. A value of 400 equals 100A. Set this number to **0 for Auto**. This uses the BIOS VR mailbox command 0x6.

VR Voltage Limit

This feature sets the Voltage Regulator voltage limit. The value is represented in mV. A value of 1250 equals 1.25V. Set this number to **0 for Auto**. This uses the BIOS VR mailbox command 0x6.

TDC Enable

Enable or Disables TDC (Thermal Design Current). The options are **Disabled** and Enabled.

TDC Current Limit

The TDC Current Limit is defined in 1/8A (Amperes) increments and uses the BIOS mailbox command 0x1A. A value of 1000 equals 125A. Valid range is 0-32767. Enter **0 for 0 Amps**.

TDC Time Window

The TDC Time Window is defined in milliseconds. Valid range is 1-8ms and 10ms. Note that 9ms has no valid encoding in the MSR definition. The options are **1ms**, 2ms, 3ms, 4ms, 5ms, 6ms, 7ms, 8ms, and 10ms.

TDC Lock

Enable or Disables TDC Lock. The options are **Disabled** and Enabled.

GT-Sliced VR Settings

GT-Sliced Domain

VR Config Enable

Select Enable to activate VR configuration options. The options are Disabled and **Enabled**.

AC Loadline

AC Loadline is defined in 1/100 mOhms and uses the BIOS mailbox command 0x2. A value of 100 equals 1.0 mOhm, and 1255 is 12.55 mOhms. Valid range is 0-6249 (0-62.49 mOhms). Enter **0 for AUTO**.

DC Loadline

DC Loadline is defined in 1/100 mOhms and uses the BIOS mailbox command 0x2. A value of 100 equals 1.0 mOhm, and 1255 is 12.55 mOhms. Valid range is 0-6249 (0-62.49 mOhms). Enter **0 for AUTO**.

PS Current Threshold1

The PS Current Threshold1 is defined in 1/4A (Amperes) increments and uses the BIOS mailbox command 0x3. A value of 400 equals 100A. Range is 0-512 which translates to 0-128A. Enter 0 for AUTO. Default is **80 for 20A**.

PS Current Threshold2

The PS Current Threshold2 is defined in 1/4A (Amperes) increments and uses the BIOS mailbox command 0x3. A value of 400 equals 100A. Range is 0-512 which translates to 0-128A. Enter 0 for AUTO. Default is **20 for 5A**.

PS Current Threshold3

The PS Current Threshold2 is defined in 1/4A (Amperes) increments and uses the BIOS mailbox command 0x3. A value of 400 equals 100A. Range is 0-512 which translates to 0-128A. Enter 0 for AUTO. Default is **4 for 1A**.

PS3 Enable

Enable or Disables PS3. Uses BIOS VR mailbox command line 0x3. The options are Disabled and **Enabled**.

PS4 Enable

Use this feature to enable or disable PS4. This feature uses BIOS VR mailbox command line 0x3. The options are Disabled and **Enabled**.

IMON Slope

IMON (Load Current Monitor) Slope is defined in 1/100 increments and uses the BIOS VR mailbox command 0x4. Valid range is 0-200. For example, enter 125 for a 1.25 slope. Enter **0 for AUTO**.

IMON Offset

IMON Offset is defined in 1/1000 increments and uses the BIOS VR mailbox command 0x4. For example, enter 25,348 for a 25.348 offset. Valid range is 0-63999.

IMON Prefix

This feature sets the IMON offset value to a positive or negative number. The options are + and -.

VR Current Limit

This feature sets the Voltage Regulator current limit. The value represents the maximum instantaneous current allowed at any given time. The value is represented in 1/4A (Ampere) increments. A value of 400 equals 100A. Set this number to **0 for Auto**. This uses the BIOS VR mailbox command 0x6.

VR Voltage Limit

This feature sets the Voltage Regulator voltage limit. The value is represented in mV. A value of 1250 equals 1.25V. Set this number to **0 for Auto**. This uses the BIOS VR mailbox command 0x6.

TDC Enable

Enable or Disables TDC (Thermal Design Current). The options are **Disabled** and Enabled.

TDC Current Limit

The TDC Current Limit is defined in 1/8A (Amperes) increments and uses the BIOS mailbox command 0x1A. A value of 1000 equals 125A. Valid range is 0-32767. Enter 0 for **0 Amps**.

TDC Time Window

The TDC Time Window is defined in milliseconds. Valid range is 1-8ms and 10ms. Note that 9ms has no valid encoding in the MSR definition. The options are **1ms**, 2ms, 3ms, 4ms, 5ms, 6ms, 7ms, 8ms, and 10ms.

TDC Lock

Enable or Disables TDC Lock. The options are **Disabled** and Enabled.

PCH-IO Configuration

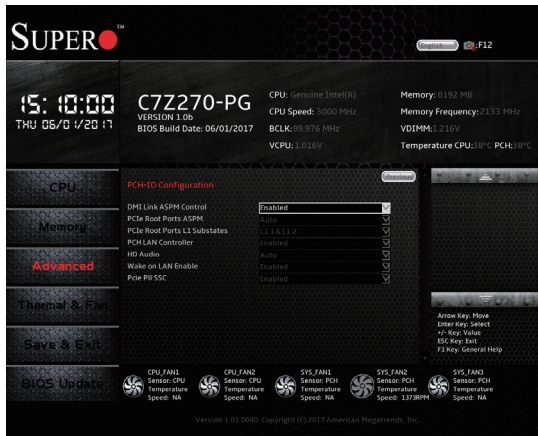

DMI Link ASPM Control

Use this feature to set the ASPM (Active State Power Management) state on the SA (System Agent) side of the DMI Link. The options are Disabled and **Enabled**.

PCIe Root Ports ASPM

Use this feature to set the Active State Power Management (ASPM) to power manage the PCIe link during the various L states. The options are **Auto**, L0sL1, L1, L0s, and Disabled.

PCIe Root Ports L1 Substates

Use this feature to define which L1 substate to use. The options are Disabled, L1.1, L1.2, and **L1.1&L1.2**.

PCH LAN Controller

Use this feature to enable or disable the PCH LAN Controller. The options are **Enabled** and Disabled.

HD Audio

Use this feature to detect an HD Audio device. The options are Disabled, Enabled, and **Auto**.

Wake on LAN Enable

Select Enabled to enable the capability to 'wake up' the system through the Ethernet port. The settings are **Enabled** and Disabled.

Pcie PII SSC

Use this feature to set the PCIE PII SSC percentage. Select Auto to keep the hardware default with no BIOS override. The range is from 0.0% to 2.0%. The options are Disabled and **Enabled**.

SATA and RST Configuration

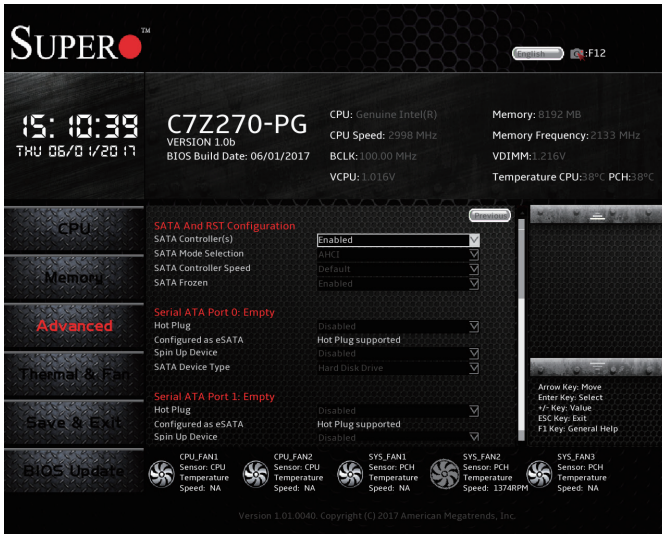

SATA Controller(s)

Select Disabled to disable the onboard SATA Controllers. The settings are **Enabled** and Disabled.

SATA Mode Selection

This item selects the mode for the installed SATA drives. The options are **AHCI** and Intel RST Premium With Intel Optane System Acceleration.

SATA Controller Speed

Use this option to specify the maximum speed the SATA controller can support. The options are **Default**, Gen 1, Gen 2, and Gen 3.

SATA Frozen

Select Disabled to disable the Freeze Lock Security feature. The settings are Disabled and **Enabled**.

The remaining options in the section are similar across Serial ATA Ports 0 through 5.

Serial ATA Port

This item displays the detected SATA drive, if any.

Hot Plug

This feature designates the port specified for hot plugging. Set this item to Enabled for hot-plugging support, which will allow the user to replace a SATA disk drive without shutting down the system. The options are **Disabled** and Enabled.

Configured as eSATA

This item displays the eSATA status for the detected hard drive.

Spin Up Device

When this option is disabled, all drives will spin up at boot. When this option is enabled, it will perform Staggered Spin Up on any drive this option is activated. The settings are **Disabled** and Enabled.

SATA Device Type

Use this feature to identify the type of HDD that is connected to the STATA port. The options are **Hard Disk Drive** and Solid State Drive.

PCH-FW Configuration

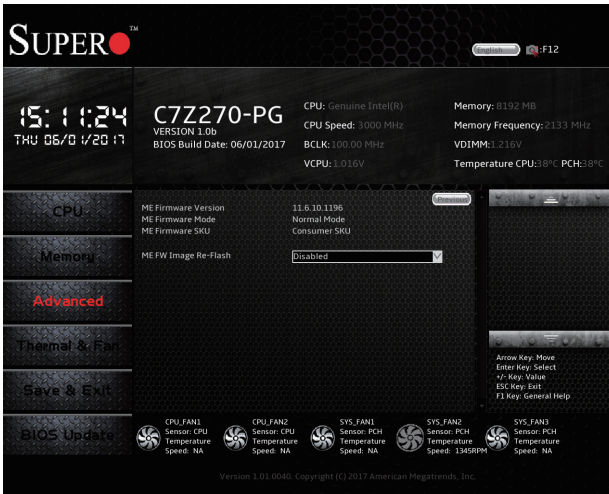

The following information is displayed.

- **ME Firmware Version**
- **ME Firmware Mode**
- **ME Firmware SKU**

ME FW Image Re-Flash

This item will update the PCH Firmware from an image in a USB Flash-drive attached to a USB port. The options are **Disabled** and Enabled.

USB Configuration



The following information is displayed.

- **USB Module Version**
- **USB Controllers**
- **USB Devices**

Legacy USB Support

Select Enabled to support legacy USB devices. Select Auto to disable legacy support when legacy USB devices are not present. If Disable is selected, legacy USB devices will not be supported. The options are **Enabled**, Disabled, and Auto.

XHCI Hand-Off

This item is a work-around solution for operating systems that do not support XHCI (Extensible Host Controller Interface) hand-off. The XHCI ownership change should be claimed by the XHCI driver. The settings are **Enabled** and Disabled.

USB Mass Storage Driver Support

Set Enabled to enable USB mass storage driver support. The options are Disabled and **Enabled**.

Install Windows 7 USB Support

Enable this feature to use the USB keyboard and mouse during the Windows 7 installation, since the native XHCI driver support is unavailable. Use a SATA optical drive as a USB drive, and USB CD/DVD drives are not supported. Disable this feature after the XHCI driver has been installed in Windows. The options are **Disabled** and **Enabled**.

External USB 3.1 Host Controller Support

Use this feature to enable or disable the ASmedia USB 3.1 Host controller. The options are **Disabled** and **Enabled**.

PCIe/PCI/PnP Configuration



Option ROM execution

Video

This feature controls which option ROM to execute for the Video device. The options are Do not launch, UEFI, and **Legacy**.

Storage Option ROM/UEFI Driver

This feature controls which option ROM to execute for the storage device. The options are **Disabled**, **EFI**, and **Legacy**.

Above 4GB MMIO BIOS assignment

Select Enable for remapping of BIOS above 4GB. The options are Enabled and **Disabled**.

PCIe/PCI/PnP Configuration

**CPU SLOT1 PCI-E 3.0 X8 (IN X16) OPROM,
CPU SLOT3 PCI-E 3.0 X16 OPROM,
PCH SLOT4 PCI-E 3.0 X4 OPROM,
CPU SLOT5 PCI-E 3.0 X8 (IN X16) OPROM,
CPU SLOT7 PCI-E 3.0 X16 OPROM**

Select Disabled to deactivate the selected slot, Legacy to activate the slot in legacy mode and EFI to activate the slot in EFI mode. The options are Disabled, **Legacy**, and UEFI.

Onboard LAN Option ROM type

Use this feature to select the type of option ROM installed. The options are **Legacy** and EFI.

Onboard LAN1 Option ROM

Select PXE (Preboot Execution Environment) to boot the computer using a PXE device installed in a LAN port specified. Select Disabled to prevent system boot using a device installed in a LAN port. The options are Disabled and **PXE**.

Onboard LAN2 Option ROM

Select PXE (Preboot Execution Environment) to boot the computer using a PXE device installed in a LAN port specified. Select Disabled to prevent system boot using a device installed in a LAN port. The options are **Disabled** and PXE.

Network Stack

Select Enabled to enable PXE (Preboot Execution Environment) or UEFI (Unified Extensible Firmware Interface) for network stack support. The options are **Disabled** and Enabled. If this feature is enabled, the two features below are available.

Ipv4 PXE Support

Select Enabled to enable Ipv4 PXE (Preboot Execution Environment) for boot support. If this feature is set to Disabled, Ipv4 PXE boot option will not be supported. The options are Disabled and **Enabled**.

Ipv6 PXE Support

Select Enabled to enable Ipv6 PXE (Preboot Execution Environment) for boot support. If this feature is set to Disabled, Ipv6 PXE boot option will not be supported. The options are Disabled and **Enabled**.

Security



This menu allows the user to configure the following security settings for the system.

- If the Administrator password is defined ONLY - this controls access to the BIOS setup ONLY.
- If the User's password is defined ONLY - this password will need to be entered upon each system boot, and will also have Administrator rights in the setup.
- Passwords must be at least 3 and up to 20 characters long.

Administrator Password

Use this feature to set the Administrator Password which is required to enter the BIOS setup utility. The length of the password should be from 3 characters to 20 characters long.

User Password

Use this feature to set the User Password, which is required every time the system boots. The length of the password should be from 3 characters to 20 characters long.

Secure Boot

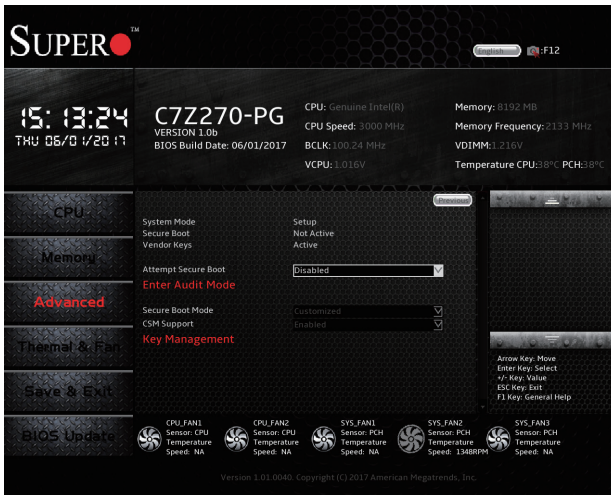

The following items will be displayed:

- **System Mode**
- **Secure Boot**
- **Vendor Keys**

Attempt Secure Boot

Select Enabled for Secure Boot flow control. This feature is available when the platform key (PK) is pre-registered, the platform operates in the user mode, and CSM is disabled in the setup utility. The options are **Disabled** and **Enabled**.

Secure Boot Mode

This feature allows selection of the Secure Boot Mode between Standard and Custom. Selecting Custom enables users to change the Image Execution Policy and manage Secure Boot Keys. The options are Standard and **Customized**.

CSM Support

Select enabled to support the Compatibility Support Module (CSM), which provides compatibility support for traditional legacy BIOS for system boot. The options are Disabled and **Enabled**.

Key Management (Available when Secure Boot Mode is set to 'Customized')

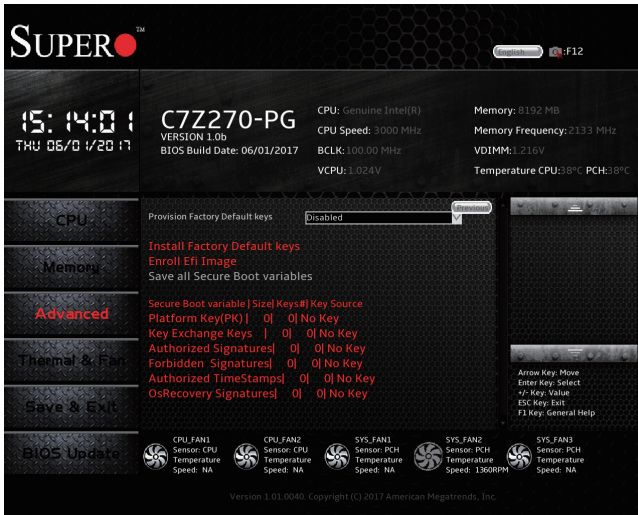

The feature, Key Management, allows experienced users to modify Secure Boot Variables.

Provision Factory Default Keys

Allow provisioning the factory default secure boot keys when system is in setup mode. The options are **Disabled** and Enabled.

Install Factory Default Keys

This option forces the system to install the factory default keys. Click Yes or No.

Enroll Efi Image

This option allows the image to run in Secure Boot Mode. Enroll SHA256 Hash Certificate of the image into the Authorized Signature Database.

Save All Secure Boot Variables

This option saves all revised Secure Boot settings.

Platform Key (PK)

This item uploads and installs a secure Platform Key. You may insert a factory default key or load from a file. The file formats accepted are:

- 1) Public Key Certificate
- a. EFI Signature List

- b. EFI CERT X509 (DER Encoded)
 - c. EFI CERT RSA2048 (bin)
 - d. EFI SERT SHA256 (bin)
- 2) EFI Time Based Authenticated Variable

When prompted, select "Yes" to load Factory Defaults or "No" to load from a file.

Key Exchange Keys

This item uploads and installs a Key Exchange Key. You may insert a factory default key or load from a file. When prompted, select "Yes" to load Factory Defaults or "No" to load from a file.

Authorized Signatures

This item uploads and installs an Authorized Signature . You may insert a factory default key or load from a file. The file formats accepted are:

- 1) Public Key Certificate
- a. EFI Signature List
 - b. EFI CERT X509 (DER Encoded)
 - c. EFI CERT RSA2048 (bin)
 - d. EFI SERT SHA256 (bin)
- 2) EFI Time Based Authenticated Variable

When prompted, select "Yes" to load Factory Defaults or "No" to load from a file.

Forbidden Signatures

This item uploads and installs a Forbidden Signature . You may insert a factory default key or load from a file. The file formats accepted are:

- 1) Public Key Certificate
- a. EFI Signature List
 - b. EFI CERT X509 (DER Encoded)
 - c. EFI CERT RSA2048 (bin)
 - d. EFI SERT SHA256 (bin)
- 2) EFI Time Based Authenticated Variable

When prompted, select "Yes" to load Factory Defaults or "No" to load from a file.

Authorized TimeStamps

This item uploads and installs an Authorized Time Stamp . You may insert a factory default key or load from a file. The file formats accepted are:

- 1) Public Key Certificate
 - a. EFI Signature List
 - b. EFI CERT X509 (DER Encoded)
 - c. EFI CERT RSA2048 (bin)
 - d. EFI SERT SHA256 (bin)
- 2) EFI Time Based Authenticated Variable

When prompted, select "Yes" to load Factory Defaults or "No" to load from a file.

OsRecovery Signatures

This item uploads and installs an OSRecovery Signature . You may insert a factory default key or load from a file. The file formats accepted are:

- 1) Public Key Certificate
 - a. EFI Signature List
 - b. EFI CERT X509 (DER Encoded)
 - c. EFI CERT RSA2048 (bin)
 - d. EFI SERT SHA256 (bin)
- 2) EFI Time Based Authenticated Variable

When prompted, select "Yes" to load Factory Defaults or "No" to load from a file.

4-6 Thermal & Fan

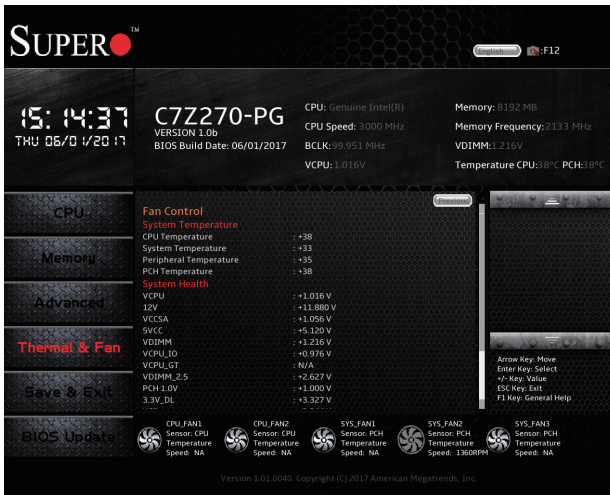

Fan Control

Fan Control

This feature allows the user to decide how the system controls the speeds of the onboard fans. The CPU temperature and the fan speed are correlative. When the CPU on-die temperature increases, the fan speed will also increase for effective system cooling. Select "Full Speed" to allow the onboard fans to run at full speed (of 100% Pulse Width Modulation Duty Cycle) for maximum cooling. This setting is recommended for special system configuration or debugging. Select "Stable" for the onboard fans to run at 50% of the Initial PWM Cycle in order to balance the needs between system cooling and power saving. This setting is recommended for regular systems with normal hardware configurations. Select "Quiet" to optimize for minimal fan noise and Custom to enter user-specific settings. The options are **Quiet**, Stable, Full Speed, and Customize.

When "Customize" is selected above, the settings for **CPU_FAN1/FAN2 FAN Control**, **SYS_FAN1/FAN2/FAN3 FAN Control** will appear and can be configured.

System Temperature

The following items will be displayed:

- **CPU Temperature** - displays the CPU temperature detected by PECI.

- **System Temperature** - indicates the system internal temperature.
- **Peripheral Temperature** - displays the detected peripheral device temperature.
- **PCH Temperature** - indicates the detected PCH chip temperature.

System Health

The following items will be displayed (Voltage):

- **VCPU**
- **12V**
- **VCCSA**
- **5VCC**
- **VDIMM**
- **VCPU_IO**
- **VCPU_GT**
- **VDIMM_2.5**
- **PCH 1.0V**
- **3.3V_DL**
- **VSB**
- **3.3VCC**
- **VBAT**
- **VCPU_STPLL**

4-7 Save & Exit

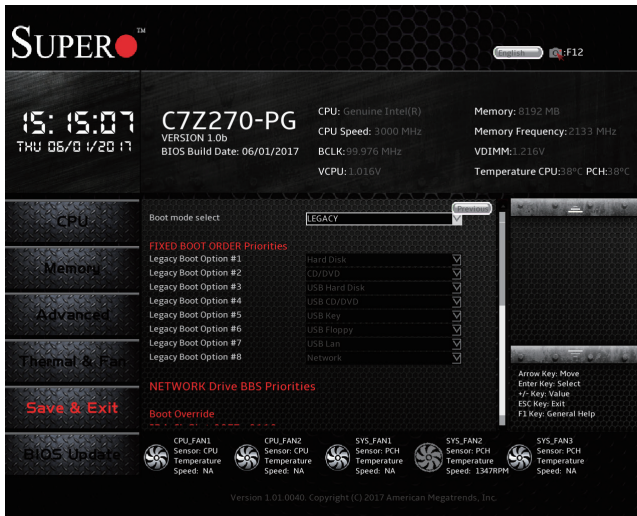

Boot mode select

Use this item to select the type of device to be used for system boot. The options are **Legacy**, UEFI, and Dual.

FIXED BOOT ORDER Priorities

This option prioritizes the order of bootable devices from which the system will boot. Choose an entry from top to bottom to select devices.

Legacy Boot Option #1~#8

The options are Hard Disk, CD/DVD, USB Hard Disk, USB CD/DVD, USB Key, USB Floppy, USB Lan, Network, and Disabled.

NETWORK Drive BBS Priorities

Boot Option #1

Use this feature to specify the Boot Device Priority sequence from available Network Drives. The options are **IBA CL Slot 00FE v0110** and Disable.

Boot Override

Saves the specified boot override and resets the system, i.e., **IBA CL Slot 00FE v0110**. Select OK to activate, otherwise, click Cancel.

Launch EFI Shell from filesystem device

This option will attempt to launch the EFI Shell application (shell.efi) from one of the available file system devices. Select OK to activate, otherwise, click Cancel.

For the following options, select OK to initiate, otherwise, click Cancel.

Save Options

Save Changes and Reset

This option will save the changes that have been made and will reboot the system.

Discard Changes and Reset

This option will save the changes that have been made and will reboot the system.

Save Changes

This option will save the changes but will remain in setup mode.

Discard Changes

This option will discard the changes but will remain in setup mode.

Save Profile 1, Save Profile 2

This option will save the current overclocking profile into either Profile 1 or Profile 2 location. Click OK to save the profile, otherwise, click Cancel.

Load Profile 1, Load Profile 2

This option will load a previously saved overclocking profile from either Profile 1 or Profile 2 location. Click OK to load the profile, otherwise, click Cancel.

Default Options

Restore Defaults

This option will load the factory-stored optimized defaults and remain in setup mode.

Save as User Defaults

This option will save the changes as user-specified defaults and remain in setup mode.

Restore User Defaults

This option will load previously-saved user-specified defaults and remain in setup mode.

4-8 BIOS Update

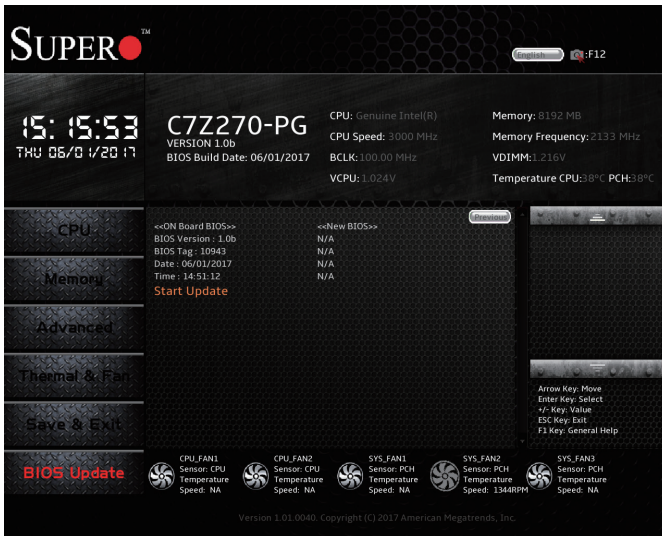

The following items will be displayed:

- **BIOS Version**
- **BIOS Tag.**
- **Date**
- **Time**

Start Update

Use this utility to prepare BIOS Update with ME.

1. Click "Start Update" enter the SuperFlash utility.
2. At the prompt, select "Yes" to reboot and configure the system to Flash mode. Select "No" to cancel and view the BIOS information.
3. After the system reboots to the flash mode, the system is ready to flash the BIOS. At the prompt, select "OK" to continue.
4. Select "Select File" and then in the pop-up menu select "General USB Flash Disk 1.00."

5. Select the filename (i.e., "C7Z270-PG") in the pop-up menu.
6. Select "Start Flash" to flash the BIOS. A pop-up message will appear to show the progress of the BIOS flash.
7. If the flash is successful, a pop-up message will indicate the result. Select "OK" to complete the BIOS flash and to reboot the system. Go to the "SYSTEM INFORMATION - Motherboard" page in the BIOS Setup to check for the correct BIOS version.

Notes

Appendix A

BIOS Error Beep Codes

During the POST (Power-On Self-Test) routines, which are performed each time the system is powered on, errors may occur.

Non-fatal errors are those which, in most cases, allow the system to continue with bootup. The error messages normally appear on the screen.

Fatal errors will not allow the system to continue to bootup. If a fatal error occurs, you should consult with your system manufacturer for possible repairs.

These fatal errors are usually communicated through a series of audible beeps. The numbers on the fatal error list correspond to the number of beeps for the corresponding error.

A-1 BIOS Error Beep Codes

BIOS Error Beep Codes		
Beep Code/LED	Error Message	Description
1 beep	Refresh	Circuits have been reset. (Ready to power up)
5 short beeps + 1 long beep	Memory error	No memory detected in the system
5 short beeps	Display error	System display error
OH LED On	System OH	System Overheat

Notes

Appendix B

Software Installation Instructions

B-1 Installing Drivers

After you've installed the Windows Operating System, a screen as shown below will appear. You are ready to install software programs and drivers that have not yet been installed. To install these software programs and drivers, click the icons to the right of these items. (**Note:** To install the Windows Operating System, please refer to the instructions posted on our website at <http://www.supermicro.com/support/manuals/>.)

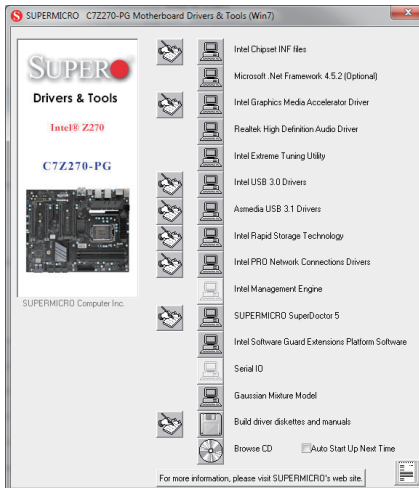

Driver/Tool Installation Display Screen



Note 1. Click the icons showing a hand writing on the paper to view the readme files for each item. Click on a computer icon to the right of an item to install this item (from top to the bottom), one at a time. After installing each item, you must reboot the system before proceeding with the next item on the list. The bottom icon with a CD on it allows you to view the entire contents of the CD.

Note 2. When making a storage driver diskette by booting into a Driver CD, please set the SATA Configuration to "Compatible Mode" and configure SATA as IDE in the BIOS Setup. After making the driver diskette, be sure to change the SATA settings back to your original settings.

B-2 Configuring SuperDoctor® V

The Supermicro SuperDoctor 5 is a hardware monitoring program that functions in a command-line or web-based interface in Windows and Linux operating systems. The program monitors system health information such as CPU temperature, system voltages, system power consumption, fan speed, and provides alerts via email or Simple Network Management Protocol (SNMP).

SuperDoctor 5 comes in local and remote management versions and can be used with Nagios to maximize your system monitoring needs. With SuperDoctor 5 Management Server (SSM Server), you can remotely control power on/off and reset chassis intrusion for multiple systems with SuperDoctor 5 or IPMI. SD5 Management Server monitors HTTP, FTP, and SMTP services to optimize the efficiency of your operation.



Note: The default Username and Password for SuperDoctor 5 is admin/admin. The SuperDoctor 5 program and user's manual can be downloaded from the Supermicro website at http://www.supermicro.com/products/nfo/sms_sd5.cfm.

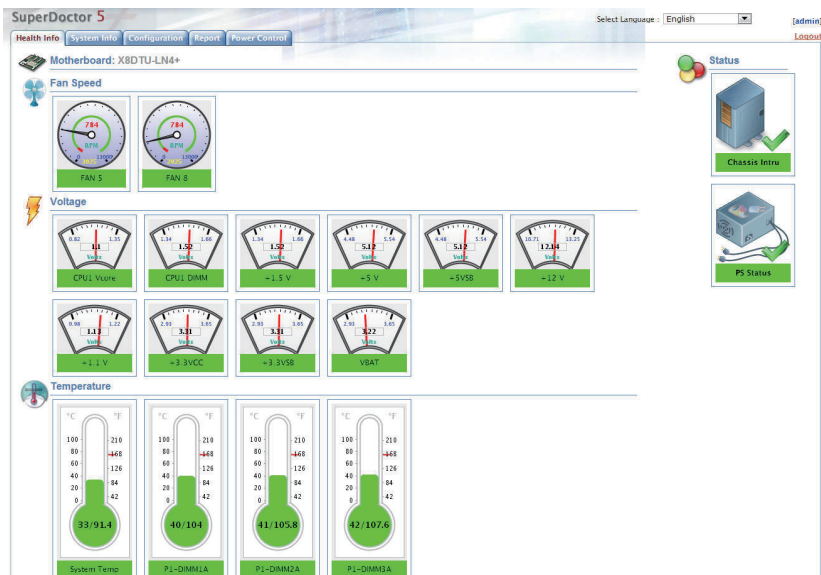

SuperDoctor V Interface Display Screen-I (Health Information)

B-3 Using SuperDoctor® V to Update the BIOS

The Supermicro SuperDoctor 5 provides an alternative to update the BIOS on Supermicro C7 motherboards.



Note: To update the BIOS from the BIOS menu, refer to Chapter 4 for details.

Follow the steps below to update the BIOS.

1. On the main screen, select Configuration > Flash BIOS.

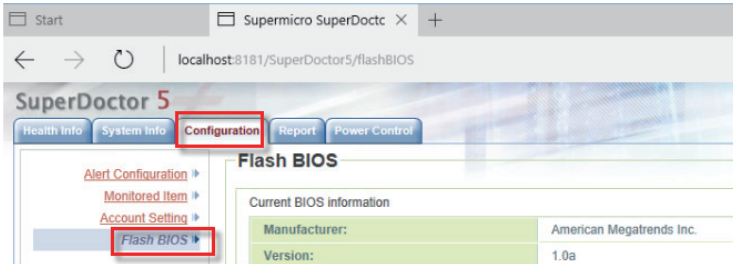

2. Press the **Browse** button to locate the desired BIOS binary file.
3. Click **Upload** to upload the file. The file will appear in the list of Available BIOS as shown below.



4. If the flash is successful, a pop-up message will appear as shown below.
5. Click **OK** to complete the BIOS flash and to reboot the system.

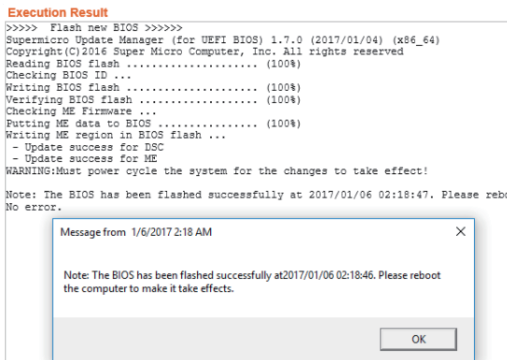

Notes

Appendix C

UEFI BIOS Recovery Instructions

! **Attention!** Do not upgrade the BIOS unless your system has a BIOS-related issue. Flashing the wrong BIOS can cause irreparable damage to the system. In no event shall Supermicro be liable for direct, indirect, special, incidental, or consequential damages arising from a BIOS update. If you need to update the BIOS, do not shut down or reset the system while the BIOS is updating to avoid possible boot failure.

C-1 An Overview to the UEFI BIOS

The Unified Extensible Firmware Interface (UEFI) specification provides a software-based interface between the operating system and the platform firmware in the pre-boot environment. The UEFI specification supports an architecture-independent mechanism for add-on card initialization to allow the UEFI OS loader, which is stored in the add-on card, to boot up the system. UEFI offers a clean, hands-off control to a computer system at bootup.

C-2 How to Recover the UEFI BIOS Image (-the Main BIOS Block)

A UEFI BIOS flash chip consists of a recovery BIOS block, comprised of two boot blocks and a main BIOS block (a main BIOS image). The boot block contains critical BIOS codes, including memory detection and recovery codes for the user to flash a new BIOS image if the original main BIOS image is corrupted. When the system power is on, the boot block codes execute first. Once that is completed, the main BIOS code will continue with system initialization and bootup.



Note: Follow the BIOS Recovery instructions below for BIOS recovery when the main BIOS boot crashes. However, when the BIOS boot block crashes, you will need to follow the procedures in Appendix D.

C-3 To Recover the Main BIOS Block Using a USB-Attached Device

This feature allows the user to recover a BIOS image using a USB-attached device without additional utilities used. A USB flash device such as a USB Flash Drive, or a USB CD/DVD ROM/RW device can be used for this purpose. However, a USB Hard Disk drive cannot be used for BIOS recovery at this time.

To perform UEFI BIOS recovery using a USB-attached device, follow the instructions below.

1. Using a different machine, copy the "Super.ROM" binary image file into the disc Root "\ " Directory of a USB device or a writeable CD/DVD.





Note: If you cannot locate the "SUPER.ROM" file in your driver disk, visit our website at www.supermicro.com to download the BIOS image into a USB flash device (save in the root folder) and rename it "SUPER.ROM" for BIOS recovery use.

2. Insert the USB device that contains the new BIOS image ("SUPER.ROM") into any available USB port. Be sure the file is saved in the very top (root) folder.
3. Set the JBR1 switch on the motherboard to recovery mode and power on the system. If the screen appears as below, press to continue.

```
Version 2.18.1263. Copyright (C) 2017 American Megatrends, Inc.
Supermicro C7Z270-PG BIOS Date:05/31/2017 Rev:1.0b
CPU : Genuine Intel(R) CPU 0000 @ 3.00GHz
Speed : 3.00 GHz
The BMC is operating with DDR4 2133 MHz
Setup default has been loaded.
Press <DEL> to run Setup
Press <F1> to Continue Booting
```

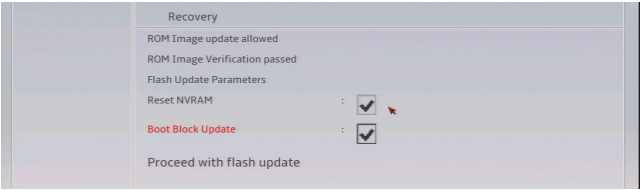
- 4. After locating the new BIOS binary image, the system will enter the BIOS Recovery menu as shown below.



 **Note:** At this point, you may decide if you want to start with BIOS Recovery. If you decide to proceed with BIOS Recovery, follow the procedures below.

- 5. To continue with BIOS Recovery, select the item- "Proceed with flash update". You will see the progress of BIOS Recovery as shown on the screens below.

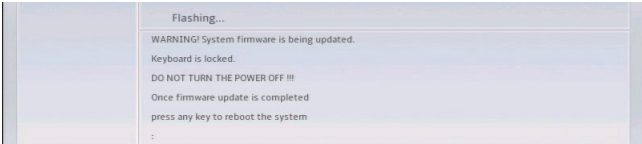

 **Note:** Do not interrupt the BIOS programming until it is completed.

- 6. After the BIOS Recovery process is complete, click OK to reboot the system.

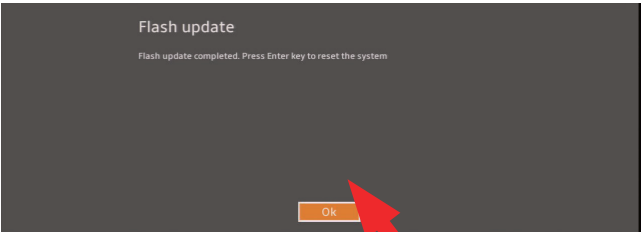

Notes

Appendix D

Dual Boot Block

D-1 Introduction

This motherboard supports the Dual Boot Block feature, which is the last-ditch mechanism to recover the BIOS boot block. This section provides an introduction to the feature.

BIOS Boot Block

A BIOS boot block is the minimum BIOS loader required to enable necessary hardware components for the BIOS crisis recovery flash that will update the main BIOS block. An on-call BIOS boot-block corruption may occur due to a software tool issue (see image below) or an unexpected power outage during BIOS updates.

```
-----
                AMI Firmware Update Utility vX.XX.XX
                Copyright (C)XXXX American Megatrends Inc. All Rights Reserved.
-----
```

```
Reading flash . . . . . done
-- ME Data Size checking . ok
-- FFS checksums . . . . . ok
Erasing Boot Block . . . . . done
_ Updating Boot Block . . . . . 0x00A91000 (13%)
```

BIOS Boot Block Corruption Occurrence

When a BIOS boot block is corrupted due to an unexpected power outage or a software tool malfunctioning during BIOS updates, you can still reboot the system by activating switch JBR1 on the motherboard. When JBR1 is activated, the system will boot from a backup boot block pre-loaded in the BIOS by the manufacturer.

D-2 Steps to Reboot the System by switch JBR1

1. Power down the system.
2. On switch JBR1 slide switch to ON, and power on the system.
3. Follow the BIOS recovery SOP listed in the previous chapter (Appendix C).
4. After completing the steps above, power down the system.
5. Turn OFF switch JBR1, and power on the system.

Appendix E

Use of Multiple GPUs

The motherboard, C7Z270-PG, supports the use of multiple GPUs (Graphics Processing Units) for more lifelike gaming.

E-1 DirectX® 12

DirectX® 12 is an integral part of Windows® 10 operating system. Follow the procedures below to run your games with multiple GPUs.

1. Install two VGA cards and drivers properly.
2. If your game supports DirectX® 12, enable the Multiple GPUs feature.
3. Select the Hardware Configuration menu, and confirm that GPU devices are detected by the system .

Notes

Appendix F

M.2/U.2 RAID Configuration

Dual U.2 connectors (PCIe interface) are located on the motherboard. The connectors are the extension of existing SATA connectors and allow for connection to Solid State Drives (SSDs). Supported RAID levels are RAID 0 and RAID 1.

The appendix aims to provide instructions on how to configure RAID settings and install the Windows® 10 operating system (OS) with two U.2 NVMe devices.

! Attention! Be sure to have the followings ready before the installation of Windows® 10 OS: the UEFI USB boot thumb drive with the Windows® 10 OS image and another USB thumb drive with the Intel® RST driver (**Note:** The Intel® RST driver can be downloaded from either the Supermicro website at <https://www.supermicro.com/support/resources/> or FTP site at ftp://ftp.supermicro.com/driver/SATA/Intel_PCH_RAID_RST/Windows/15.2.0.1020/).

F-1 Configuring the RAID Setting

Follow the steps below to configure RAID settings.

1. Power on the system and press key to enter the BIOS configuration settings.
2. On the main screen, select Advanced > SATA and RST Configuration.
3. Set the item, SATA Mode Selection, to [Intel RST Premium with Intel Optane System Acceleration].

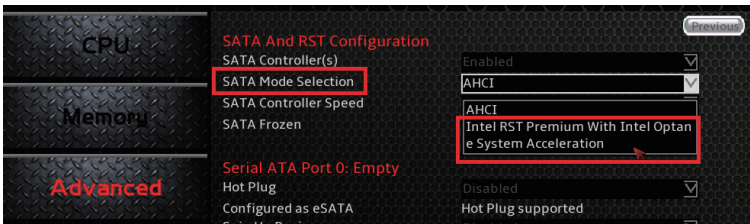

- Set two items, PCIe Storage Dev On Port XX, to [RST Controlled].



Note: The two items in the red box, as shown below, will be displayed when M.2/U.2 devices are detected by the system.

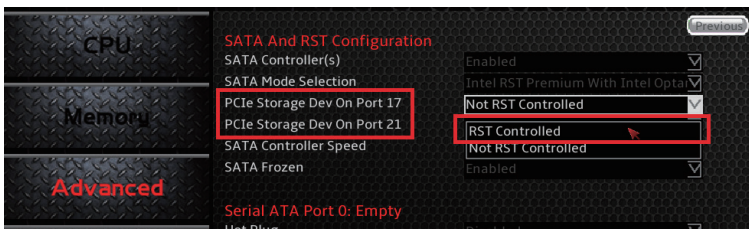

- On the main screen, select Advanced > PCIe/PCI/PnP Configuration.
- Set the item, Storage Option ROM/UEFI Driver, to [EFI].

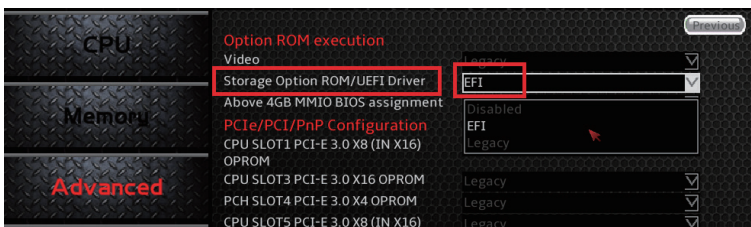

- On the main screen, select Save & Exit. Set the item, Boot mode select, to [DUAL]

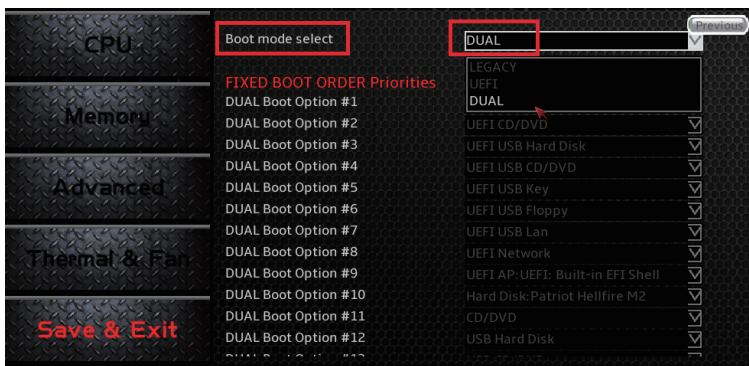

8. Press <F4> key to save the configuration and restart the system.
9. Press key to enter the BIOS configuration settings.
10. On the main screen, select Advanced > Intel(R) Rapid Storage Technology > Create RAID Volume.

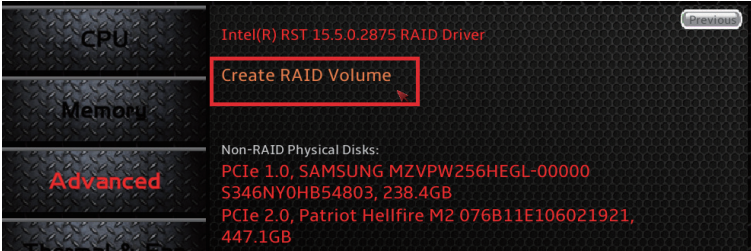

11. The item, Name, allows users to enter the name of RAID.
12. Set the item, RAID Level, to [RAID1(Mirror)].

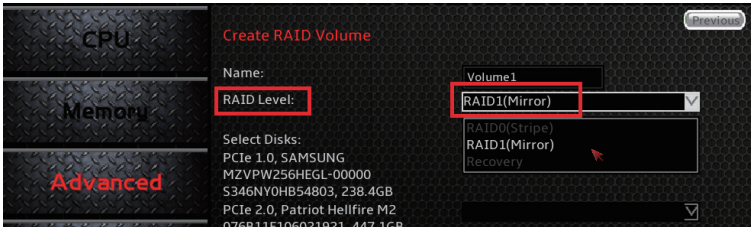

13. Set both items, which display the information for M.2/U.2 devices, to [X].



14. RAID capacity size can be changed here.

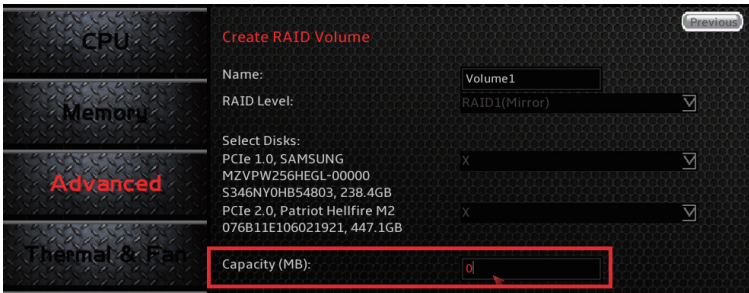

15. The information indicated below confirms that the RAID was successfully created.

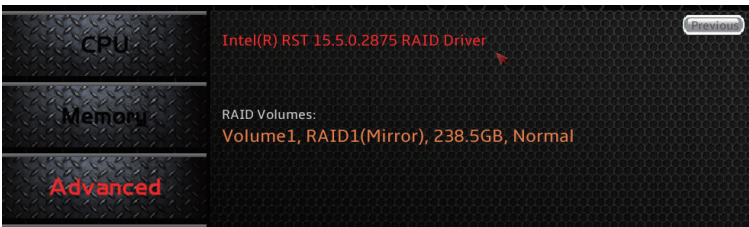

16. On the main screen, select Save & Exit. Set the item, DUAL Boot Option #1, to [UEFI Hard Disk].

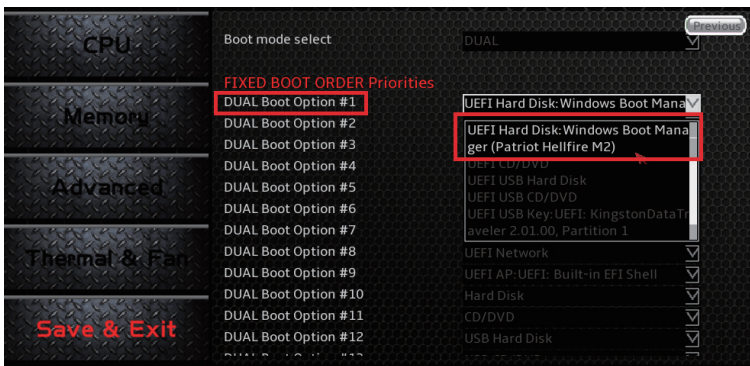

17. Press <F4> key to save the configuration and restart the system.

F-2 Installing the Windows® 10 OS

Follow the steps below to install the Windows® 10 OS with M.2/U.2 NVMe RAID devices.



Note: Be sure to have both UEFI USB boot thumb drives (one with the Windows® 10 OS image and the other with the Intel® RST driver) connected to the system before the rebooting.

1. Power on (reboot) the system.
2. Press <F11> key to enter the boot menu and select the one that contains the Windows® 10 OS image as the boot device.

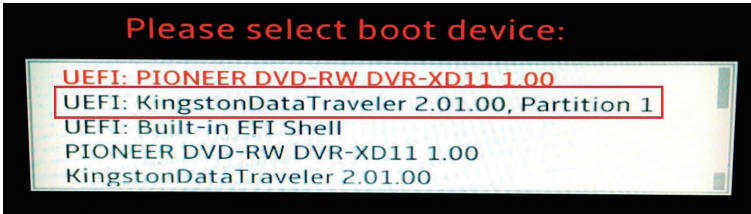

3. Follow the prompts to load and install the RST driver.

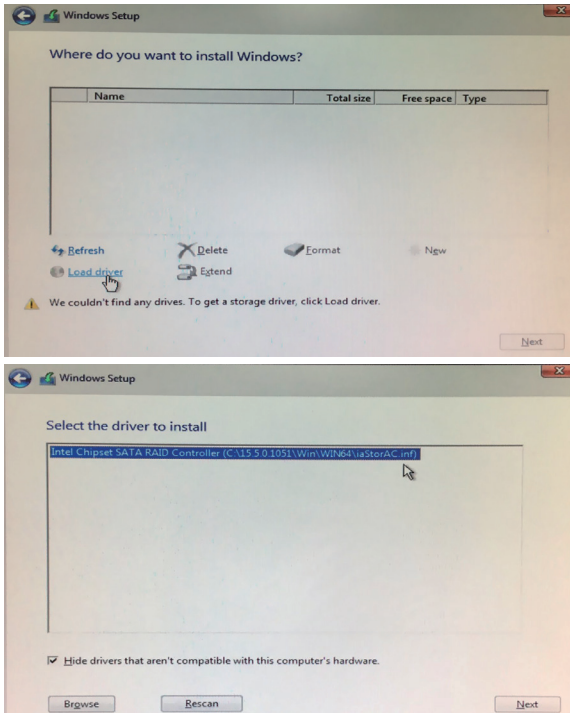

- The information for M.2/U.2 RAID drive will be displayed. Click Next or press <Enter> to start the installing process for Windows® 10 OS.

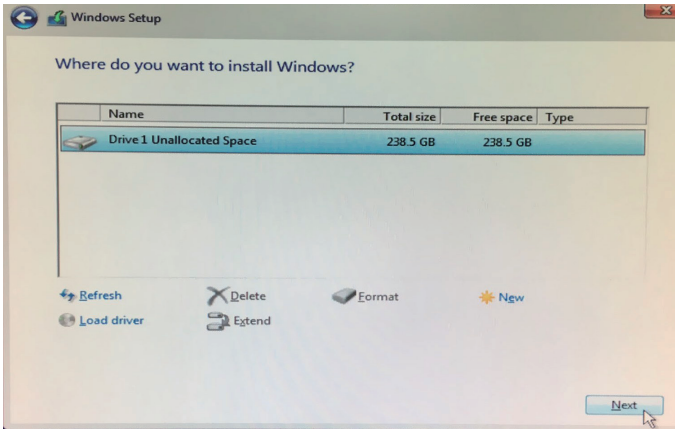

- The system will automatically restart when the installing process is completed.

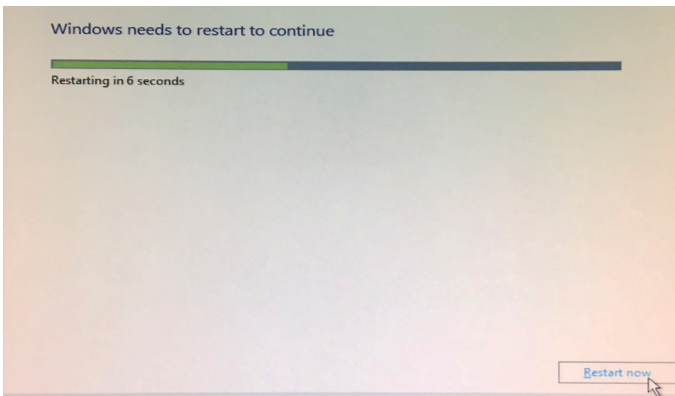
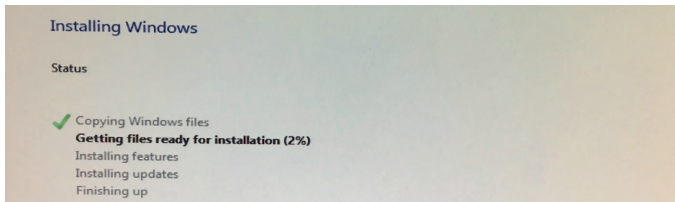

(Disclaimer Continued)

The products sold by Supermicro are not intended for and will not be used in life support systems, medical equipment, nuclear facilities or systems, aircraft, aircraft devices, aircraft/emergency communication devices or other critical systems whose failure to perform be reasonably expected to result in significant injury or loss of life or catastrophic property damage. Accordingly, Supermicro disclaims any and all liability, and should buyer use or sell such products for use in such ultra-hazardous applications, it does so entirely at its own risk. Furthermore, buyer agrees to fully indemnify, defend and hold Supermicro harmless for and against any and all claims, demands, actions, litigation, and proceedings of any kind arising out of or related to such ultra-hazardous use or sale.