



C9Z590-CG
C9Z590-CGW

USER'S MANUAL

Revision 1.1

The information in this user's manual has been carefully reviewed and is believed to be accurate. The manufacturer assumes no responsibility for any inaccuracies that may be contained in this document, and makes no commitment to update or to keep current the information in this manual, or to notify any person or organization of the updates. **Please Note: For the most up-to-date version of this manual, please see our website at www.supermicro.com.**

Super Micro Computer, Inc. ("Supermicro") reserves the right to make changes to the product described in this manual at any time and without notice. This product, including software and documentation, is the property of Supermicro and/or its licensors, and is supplied only under a license. Any use or reproduction of this product is not allowed, except as expressly permitted by the terms of said license.

IN NO EVENT WILL Super Micro Computer, Inc. BE LIABLE FOR DIRECT, INDIRECT, SPECIAL, INCIDENTAL, SPECULATIVE OR CONSEQUENTIAL DAMAGES ARISING FROM THE USE OR INABILITY TO USE THIS PRODUCT OR DOCUMENTATION, EVEN IF ADVISED OF THE POSSIBILITY OF SUCH DAMAGES. IN PARTICULAR, SUPER MICRO COMPUTER, INC. SHALL NOT HAVE LIABILITY FOR ANY HARDWARE, SOFTWARE, OR DATA STORED OR USED WITH THE PRODUCT, INCLUDING THE COSTS OF REPAIRING, REPLACING, INTEGRATING, INSTALLING OR RECOVERING SUCH HARDWARE, SOFTWARE, OR DATA.

Any disputes arising between manufacturer and customer shall be governed by the laws of Santa Clara County in the State of California, USA. The State of California, County of Santa Clara shall be the exclusive venue for the resolution of any such disputes. Supermicro's total liability for all claims will not exceed the price paid for the hardware product.

FCC Statement: This equipment has been tested and found to comply with the limits for a Class B digital device pursuant to Part 15 of the FCC Rules. These limits are designed to provide reasonable protection against harmful interference when the equipment is operated in a consumer environment or residential installation. This equipment generates, uses, and can radiate radio frequency energy and, if not installed and used in accordance with the manufacturer's instruction manual, may cause harmful interference with radio communications. Operation of this equipment in a residential area is likely to cause harmful interference, in which case you will be required to correct the interference at your own expense.

California Best Management Practices Regulations for Perchlorate Materials: This Perchlorate warning applies only to products containing CR (Manganese Dioxide) Lithium coin cells. "Perchlorate Material-special handling may apply. Refer to www.dtsc.ca.gov/hazardouswaste/perchlorate".



WARNING: This product can expose you to chemicals including lead, known to the State of California to cause cancer and birth defects or other reproductive harm. For more information, go to www.P65Warnings.ca.gov.

The products sold by Supermicro are not intended for and will not be used in life support systems, medical equipment, nuclear facilities or systems, aircraft, aircraft devices, aircraft/emergency communication devices or other critical systems whose failure to perform be reasonably expected to result in significant injury or loss of life or catastrophic property damage. Accordingly, Supermicro disclaims any and all liability, and should buyer use or sell such products for use in such ultra-hazardous applications, it does so entirely at its own risk. Furthermore, buyer agrees to fully indemnify, defend and hold Supermicro harmless for and against any and all claims, demands, actions, litigation, and proceedings of any kind arising out of or related to such ultra-hazardous use or sale.

Manual Revision 1.1

Release Date: March 16, 2022

Unless you request and receive written permission from Super Micro Computer, Inc., you may not copy any part of this document. Information in this document is subject to change without notice. Other products and companies referred to herein are trademarks or registered trademarks of their respective companies or mark holders.

Copyright © 2022 by Super Micro Computer, Inc.
All rights reserved.

Printed in the United States of America

Preface

About This Manual

This manual is written for system integrators, IT technicians and knowledgeable end users. It provides information for the installation and use of the C9Z590-CG/-CGW motherboard.

About This Motherboard

The Supermicro C9Z590-CG/-CGW supports a single 11th Generation Intel® Core™ i9/i7/i5 series processor (LGA1200 socket) with up to 8 cores and a thermal design power (TDP) of up to 125W. Built with the Intel PCH Z590 chipset, this motherboard supports up to 128GB of Unbuffered (UDIMM) non-ECC memory with speeds of up to 3200MHz (2DPC, by CPU) in four 288-pin memory slots, three M.2 sockets, 1G/10G Base-T ports, and a Trusted Platform Module (TPM) header. The C9Z590-CG/-CGW is optimized for high-performance, high-end computing platforms that address the needs of next generation server applications. Please note that this motherboard is intended to be installed and serviced by professional technicians only. For processor/memory updates, please refer to our website at <http://www.supermicro.com/products/>.



Note: The system will not boot up if using the 10th Gen Intel Core series processor.

Conventions Used in the Manual

Special attention should be given to the following symbols for proper installation and to prevent damage done to the components or injury to yourself:



Warning! Indicates important information given to prevent equipment/property damage or personal injury.



Warning! Indicates high voltage may be encountered while performing a procedure.



Important: Important information given to ensure proper system installation or to relay safety precautions.



Note: Additional Information given to differentiate various models or to provide information for proper system setup.

Contacting Supermicro

Headquarters

Address: Super Micro Computer, Inc.
980 Rock Ave.
San Jose, CA 95131 U.S.A.

Tel: +1 (408) 503-8000

Fax: +1 (408) 503-8008

Email: marketing@supermicro.com (General Information)
support@supermicro.com (Technical Support)

Website: www.supermicro.com

Europe

Address: Super Micro Computer B.V.
Het Sterrenbeeld 28, 5215 ML
's-Hertogenbosch, The Netherlands

Tel: +31 (0) 73-6400390

Fax: +31 (0) 73-6416525

Email: sales@supermicro.nl (General Information)
support@supermicro.nl (Technical Support)
rma@supermicro.nl (Customer Support)

Website: www.supermicro.nl

Asia-Pacific

Address: Super Micro Computer, Inc.
3F, No. 150, Jian 1st Rd.
Zhonghe Dist., New Taipei City 235
Taiwan (R.O.C)

Tel: +886-(2) 8226-3990

Fax: +886-(2) 8226-3992

Email: support@supermicro.com.tw

Website: www.supermicro.com.tw

Table of Contents

Chapter 1 Introduction

1.1 Checklist.....	8
Quick Reference	12
Quick Reference Table.....	13
Motherboard Features.....	15
1.2 Processor and Chipset Overview.....	18
1.3 Special Features	18
Recovery from AC Power Loss.....	18
1.4 System Health Monitoring.....	19
Onboard Voltage Monitors	19
Fan Status Monitor with Firmware Control	19
Environmental Temperature Control	19
System Resource Alert.....	19
1.5 ACPI Features.....	20
Slow Blinking LED for Suspend-state Indicator	20
1.6 Power Supply	20
1.7 Serial Header	21
1.8 Super I/O	21

Chapter 2 Installation

2.1 Static-Sensitive Devices.....	22
Precautions	22
Unpacking	22
2.2 Processor and Heatsink Installation.....	23
Installing the LGA1200 Processor	23
Installing an Active CPU Heatsink with Fan	26
Removing an Active CPU Heatsink with Fan	27
2.3 Motherboard Installation.....	28
Tools Needed	28
Location of Mounting Holes	28
Installing the Motherboard.....	29

2.4	Memory Support and Installation	30
	General Guidelines for Optimizing Memory Performance	30
	DIMM Installation	31
	DIMM Removal	31
2.5	M.2 Installation (optional).....	32
2.6	Rear I/O Ports	34
2.7	Front Control Panel.....	38
2.8	Connectors	42
	Power Connections	42
	Headers.....	44
2.9	Jumper Settings	51
	How Jumpers Work.....	51
2.10	LED Indicators.....	54
<i>Chapter 3 Troubleshooting</i>		
3.1	Troubleshooting Procedures	57
	Before Power On	57
	No Power	57
	No Video	58
	System Boot Failure	58
	Memory Errors	58
	Losing the System's Setup Configuration.....	59
	When the System Becomes Unstable	59
3.2	Technical Support Procedures	60
3.3	Frequently Asked Questions	61
3.4	Battery Removal and Installation	62
	Battery Removal.....	62
	Proper Battery Disposal.....	62
	Battery Installation.....	62
3.5	Returning Merchandise for Service.....	63

Chapter 4 UEFI BIOS

4.1 Introduction.....	64
4.2 EZ Mode.....	66
4.3 Main.....	69
4.4 Overclocking.....	71
4.5 Advanced.....	93
4.6 H/W Monitor	125
4.7 Boot	127
4.8 Save & Exit.....	129
4.9 BIOS Update	131

Appendix A BIOS Codes

A.1 BIOS Error POST (Beep) Codes	132
A.2 Additional BIOS POST Codes.....	133

Appendix B Software

B.1 Driver Installation	134
B.2 SuperDoctor 5	135

Appendix C Standardized Warning Statements

Appendix D UEFI BIOS Recovery

D.1 Overview.....	139
D.2 Recovering the UEFI BIOS Image.....	139
D.3 Recovering the Main BIOS Block with a USB Device	139

Chapter 1

Introduction

Congratulations on purchasing your computer motherboard from an industry leader. Supermicro motherboards are designed to provide you with the highest standards in quality and performance.

In addition to the motherboard, several important parts that are included in the retail box are listed below. If anything listed is damaged or missing, please contact your retailer.

1.1 Checklist

Main Parts List		
Description	Part Number	Quantity
Supermicro Motherboard	C9Z590-CG/-CGW	1
I/O Shield	MCP-260-00161-0N	1
SATA Cables	CBL-SAST-1000-2	2
	CBL-SAST-1001-2 (Right-Angle SATA Cable)	2
Quick Reference Guide	MNL-2335-QRG	1
Antenna	(For C9Z590-CGW only)	2
S-Connector*	JMP-0010L-0000-PRX	1

 **Note:** The S-Connector is a plug designed to connect the front control panel header on the motherboard and front control panel cables of the chassis.

Important Links

For your system to work properly, please follow the links below to download all necessary drivers/utilities and the user's manual for your server.

- Supermicro product manuals: <http://www.supermicro.com/support/manuals/>
- Product drivers and utilities: <https://www.supermicro.com/wdl/driver/>
- Product safety info: <https://www.supermicro.com/en/about/policies/safety-information>
- A secure data deletion tool designed to fully erase all data from storage devices can be found at our website: https://www.supermicro.com/about/policies/disclaimer.cfm?url=/wdl/utility/Lot9_Secure_Data_Deletion_Utility/
- If you have any questions, please contact our support team at: support@supermicro.com

This manual may be periodically updated without notice. Please check the Supermicro website for possible updates to the manual revision level.

Figure 1-1. C9Z590-CGW Motherboard Image

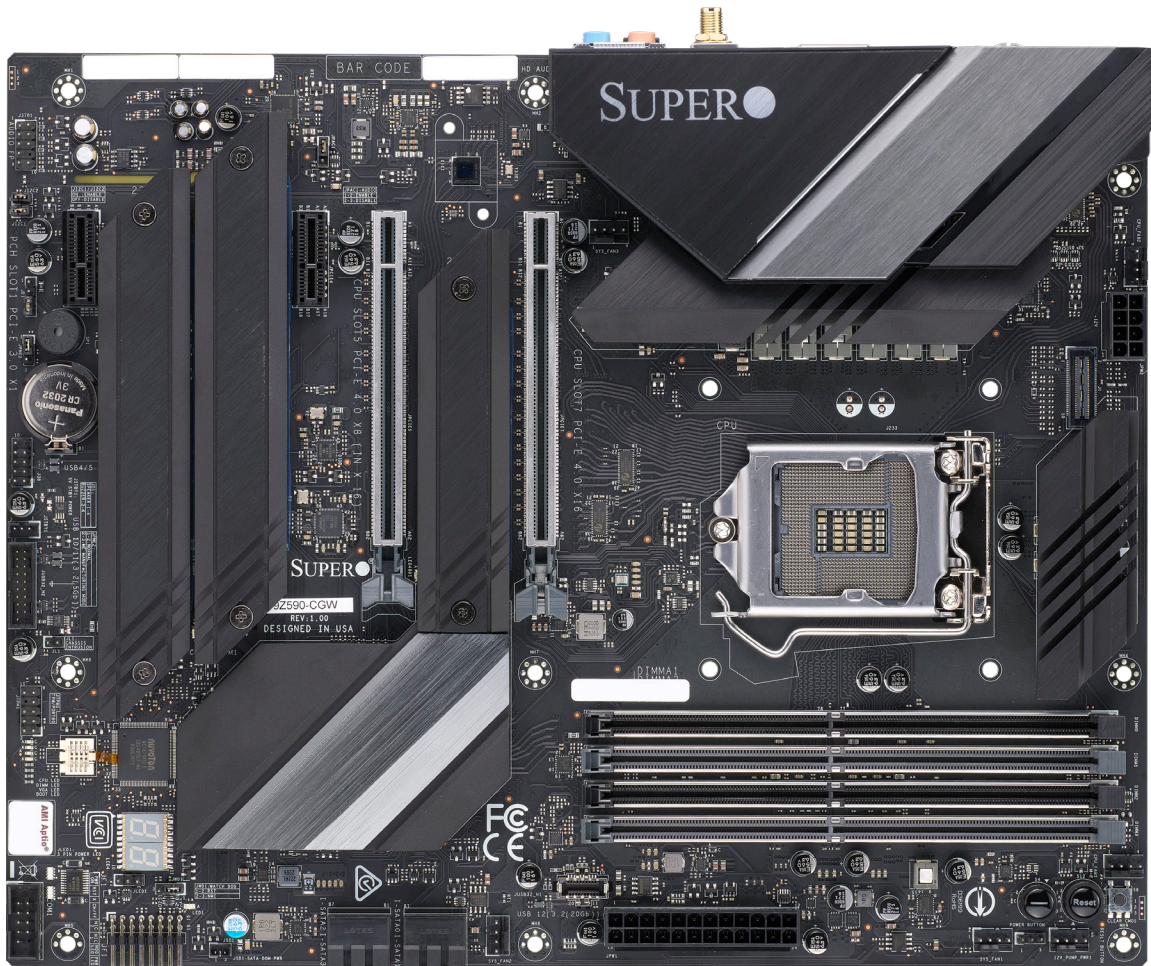

Differences between C9Z590-CG and C9Z590-CGW

	C9Z590-CG	C9Z590-CGW
PCIe M.2 E Key for WiFi and Bluetooth	No	Yes

Note: All graphics shown in this manual were based upon the latest PCB revision available at the time of publication of the manual. The motherboard you received may or may not look exactly the same as the graphics shown in this manual.

Figure 1-2. C9Z590-CG Motherboard Layout
(not drawn to scale)

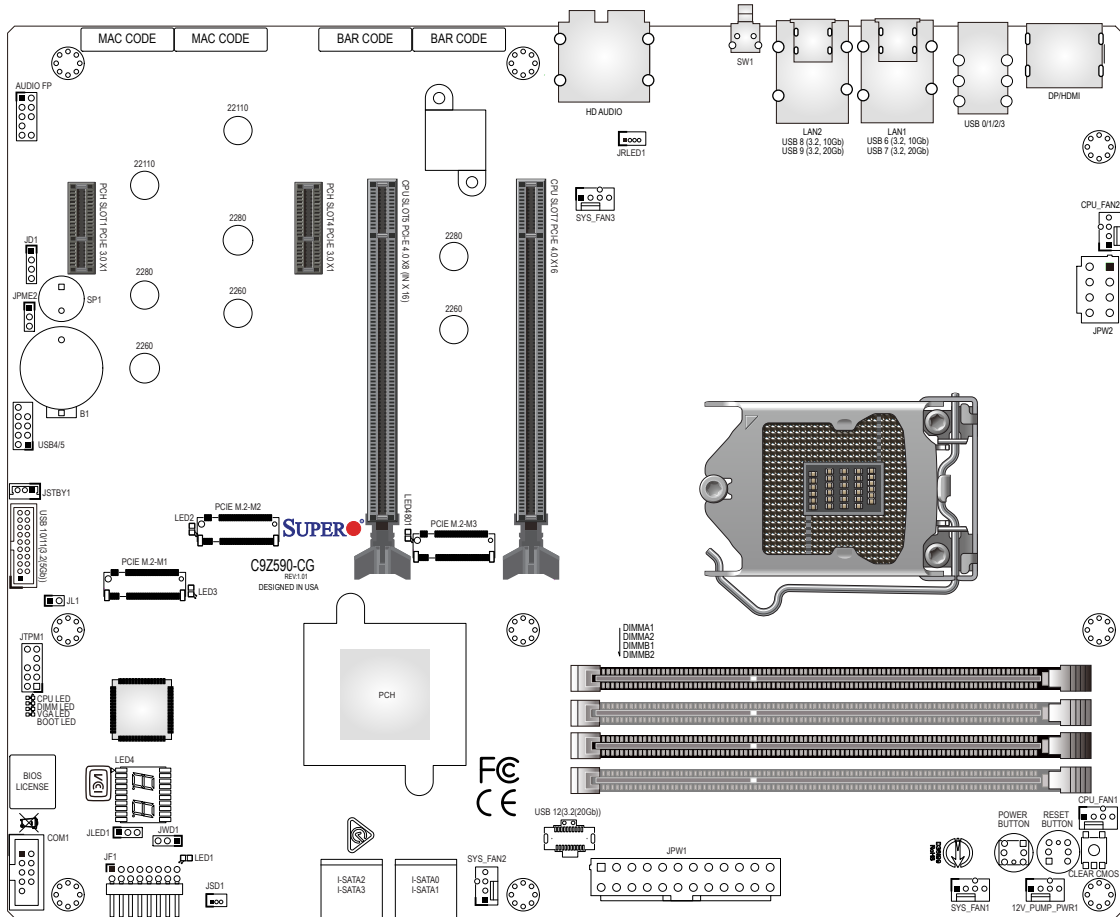

Note: Components not documented are for internal testing only.

Figure 1-3. C9Z590-CGW Motherboard Layout
(not drawn to scale)

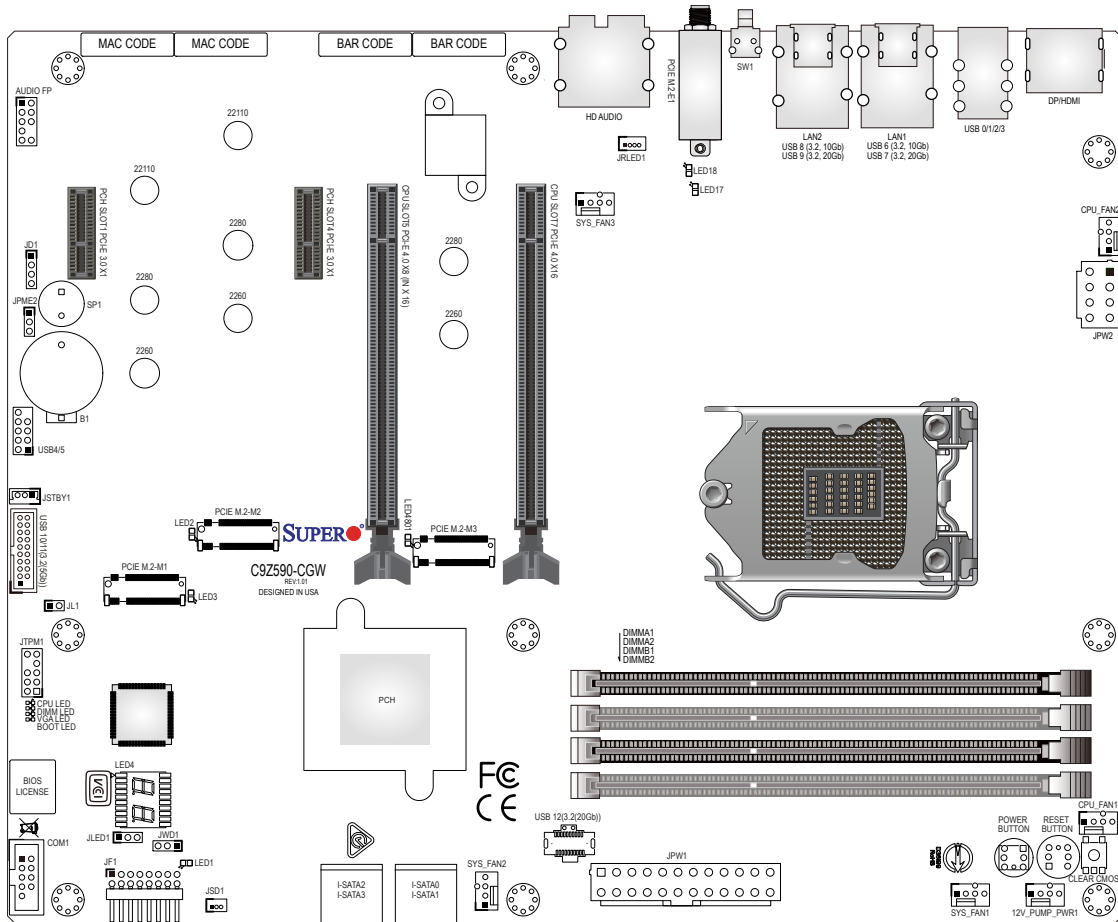

Differences between C9Z590-CG and C9Z590-CGW		
	C9Z590-CG	C9Z590-CGW
PCIe M.2 E Key for WiFi and Bluetooth	No	Yes



Note: Components not documented are for internal testing only.

Quick Reference

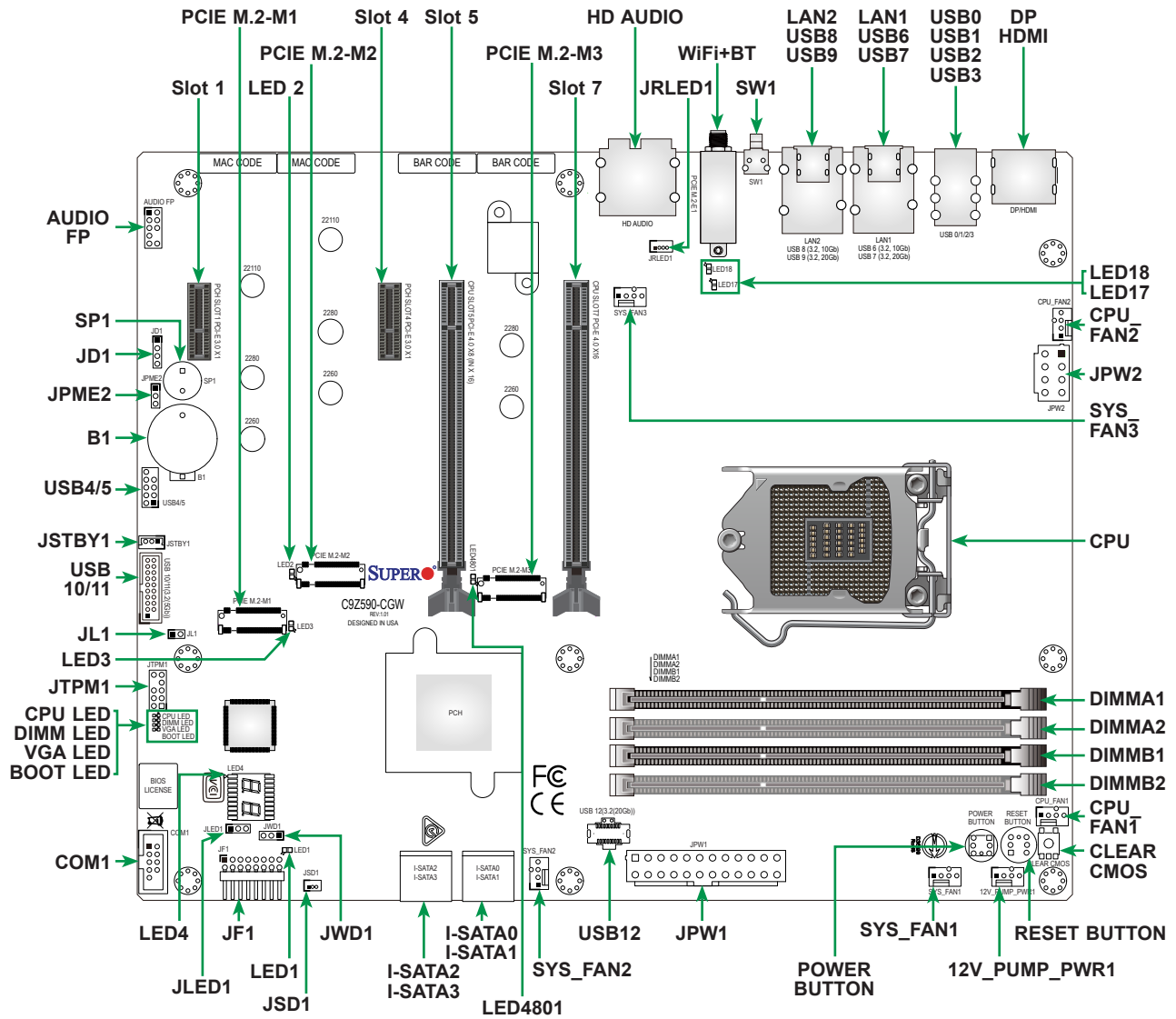

 **Notes:**

- Refer to [Chapter 2](#) for detailed information on jumpers, I/O ports, and JF1 front panel connections.
- " ■ " indicates the location of Pin 1.
- Jumpers/LED indicators not indicated are used for testing only.
- Use only the correct type of onboard CMOS battery as specified by the manufacturer. Do not install the onboard battery upside down to avoid possible explosion.

Quick Reference Table

Jumper	Description	Default Setting
CLEAR CMOS	Clear CMOS Switch	Push Button Switch
JD1	Speaker Buzzer	Pins 1-4: External Speaker Pins 3-4: Buzzer
JPME2	Intel Manufacturing Mode	Pins 1-2: Normal Pins 2-3: Manufacturing Mode
JWD1	Watch Dog Function Enable	Pins 1-2: RST Pins 2-3: NMI
POWER BUTTON	Internal Power Button	Push Button Switch
RESET BUTTON	Onboard System Reset Button	Push Button Switch
SW1	Back Panel Clear CMOS Switch	Push Button Switch



LED	Description	Color/State
BOOT LED	Bootable Device Power-On Self-Test (POST) Status	Bootable Device POST: Orange ON Bootable Device POST Completion: OFF
CPU LED	CPU Power-On Self-Test (POST) Status	CPU POST: Yellow ON CPU POST Completion: OFF
DIMM LED	DIMM Power-On Self-Test (POST) Status	DIMM POST: Blue ON DIMM POST Completion: OFF
LED1	Onboard Power LED S3 (Suspend to RAM) LED	Power On: Green On S3: Green Blinking
LED17	WLAN Power-On Self-Test (POST) Status	WLAN POST: Green ON WLAN POST Completion: OFF
LED18	Bluetooth Device Power-On Self-Test (POST) Status	Bluetooth Device POST: Green ON Bluetooth Device POST Completion: OFF
LED2	PCIe M.2-M2 Socket LED	PCIe Device Detected: Green ON Activity: Green Blinking
LED3	PCIe M.2-M1 Socket LED	PCIe Device Detected: Green ON Activity: Green Blinking
LED4	BIOS POST Code LED	Digital Readout
LED4801	PCIe M.2-M3 Socket LED	PCIe Device Detected: Green ON Activity: Green Blinking
VGA LED	Onboard VGA Power-On Self-Test (POST) Status	Onboard VGA POST: Green ON Onboard VGA POST Completion: OFF



Note: The table above is continued on the next page.

Connector	Description
12V_PUMP_PWR1	12V 4-pin Power Connector for CPU Liquid Cooling Pump
AUDIO FP	Front Panel Audio Header
B1	Onboard Battery
COM1	COM1 Header
CPU_FAN1/CPU_FAN2	CPU Fan Headers
CPU SLOT5 PCI-E 4.0 x8 (IN x16)	PCIe 4.0 x16 Slot (PCIe 4.0 x8 Link) *Supports GPU cards, PCI-e storage cards, and Intel® Optane™ Memory (1x4) only.
CPU SLOT7 PCI-E 4.0 x16	PCIe 4.0 x16 Slot (PCIe 4.0 x16 Link) *Supports GPU cards, PCI-e storage cards, and Intel® Optane™ Memory (1x4) only.
DP/HDMI	Back Panel DisplayPort/High Definition Multimedia Interface
HD AUDIO	High Definition Audio Ports
I-SATA0~3	(Intel Z590) Serial ATA (SATA 3.0) Ports 0~3 (6Gb/sec)
JF1	Front Control Panel Header
JL1	Chassis Intrusion Header
JLED1	Power LED Indicator Header
JPW1	24-pin ATX Main Power Connector (Required)
JPW2	+12V 8-pin CPU Power Connector (Required)
JRLED1	4-pin Connector for a White Light LED Board (Pre-installed) Inside the I/O cover
JSD1	SATA DOM (Disk-On-Module) Power Connector
JSTBY1	5V Standby Power Header
JTPM1	Trusted Platform Module (TPM)/Port 80 Header (TPM 2.0 only)
LAN1/LAN2	RJ45 1GbE/10GbE LAN Ports
PCIE M.2-E1	WiFi 6 + BT 5.1 (Pre-installed, for C9Z590-CGW only)
PCIE M.2-M1/M2	PCIe 3.0 x4 M.2 M-Key Sockets (Attached to PCH)
PCIE M.2-M3	PCIe 4.0 x4 M.2 M-Key Socket (Attached to CPU)
PCH SLOT1/4 PCI-E 3.0 x1	PCIe 3.0 x1 Slots (PCIe 3.0 x1 Link)
SP1	Internal Speaker/Buzzer
SYS_FAN1~SYS_FAN3	System Fan Headers
USB0/1/2/3	Back Panel USB 2.0 Ports (Type A)
USB4/5	Front Panel Accessible USB 2.0 Header
USB6	Back Panel USB 3.2 Gen 2 Port (10Gb, Type A)
USB7	Back Panel USB 3.2 Gen 2x2 Port (20Gb, Type C)
USB8	Back Panel USB 3.2 Gen 2 Port (10Gb, Type A)
USB9	Back Panel USB 3.2 Gen 2x2 Port (20Gb, Type C)
USB10/11	Front Panel Accessible USB 3.2 Gen 1 Header (5Gb)
USB12	Front Panel Accessible USB 3.2 Gen 2x2 20-pin Connector (20Gb)

Motherboard Features

Motherboard Features	
CPU	
<ul style="list-style-type: none"> Supports a single 11th Gen Intel Core i9/i7/i5 series processor (LGA1200 socket) with up to 8 cores and a thermal design power (TDP) of up to 125W  Note: The system will not boot up if using the 10th Gen Intel Core series processor.	
Memory	
<ul style="list-style-type: none"> Supports up to 128 of Unbuffered non-ECC UDIMM (288-pin) memory with speeds of up to 3200MHz (2DPC, by CPU) in four memory slots. 	
DIMM Size	
<ul style="list-style-type: none"> Up to 128GB at 1.2V  Note 1: Memory capacity and frequency is CPU dependent.  Note 2: For the latest CPU/memory updates, please refer to our website at http://www.supermicro.com/products/motherboard .	
Chipset	
<ul style="list-style-type: none"> Intel PCH Z590 	
Expansion Slots	
<ul style="list-style-type: none"> Two PCIe 3.0 x1 Slots (PCH SLOT1 and SLOT4) Two PCIe 4.0 x8/x16 Slots (CPU SLOT7, CPU SLOT5: Supports Auto Switch) Two M.2 PCIe 3.0 x4 Sockets, attached to PCH (M-Key 2260, 2280, and 22110) One M.2 PCIe 4.0 x4 Socket, attached to CPU (M-Key 2260 and 2280) 	
Network	
<ul style="list-style-type: none"> Intel Ethernet i219V Aquantia Ethernet AQC113C 	
I/O Devices	
<ul style="list-style-type: none"> Serial (COM) Port 	<ul style="list-style-type: none"> One front accessible serial port header (COM1)
<ul style="list-style-type: none"> SATA 3.0 	<ul style="list-style-type: none"> Four SATA 3.0 ports at 6 Gb/s (I-SATA0~3 with RAID 0, 1, 5, and 10)
<ul style="list-style-type: none"> Video Port 	<ul style="list-style-type: none"> One DisplayPort 1.4a connection on the rear I/O panel One HDMI 2.0b connection on the rear I/O panel
Peripheral Devices	
<ul style="list-style-type: none"> Four USB 2.0 ports on the rear I/O panel (USB0/1/2/3) One front accessible USB 2.0 header with two USB connections (USB4/5) Two USB 3.2 Gen 2 ports on the rear I/O panel (10Gb, USB6/8) Two USB 3.2 Gen 2x2 ports on the rear I/O panel (20Gb, USB7/9) One front accessible USB 3.2 Gen 1 header with two USB connections (5Gb, USB10/11) One front accessible USB 3.2 Gen 2x2 20-pin connector with one USB connection (20Gb, USB12) 	



Note: The table above is continued on the next page.

Motherboard Features	
BIOS	
<ul style="list-style-type: none"> • 256Mb AMI BIOS® SPI Flash BIOS • ACPI 6.0, Plug and Play (PnP), BIOS rescue hot-key, riser card auto detection support, and SMBIOS 3.0 or later 	
Power Management	
<ul style="list-style-type: none"> • ACPI power management • Power button override mechanism • Power-on mode for AC power recovery • Wake-on-LAN • Power supply monitoring 	
System Health Monitoring	
<ul style="list-style-type: none"> • Onboard voltage monitoring for +12V, +5V, +3.3V, CPU, Memory, VBAT, +5V stdby, +3.3V stdby, +1.8V PCH, +1.05V PCH, +1.0V PCH, CPU temperature, VRM temperature, LAN temperature, PCH temperature, system temperature, and memory temperature • 5 CPU switch phase voltage regulator • CPU thermal trip support • Platform Environment Control Interface (PECI)/TSI 	
Fan Control	
<ul style="list-style-type: none"> • Single cooling zone • Multi-speed fan control via onboard Super I/O • Five 4-pin fan headers 	
System Management	
<ul style="list-style-type: none"> • Trusted Platform Module (TPM) support • SuperDoctor® 5 • Chassis intrusion header and detection <p> Note: Please connect a cable from the Chassis Intrusion header at JL1 to the chassis to receive an alert</p>	
LED Indicators	
<ul style="list-style-type: none"> • CPU/system overheat LED • Power/suspend-state indicator LED • Fan failed LED • HDD activity LED • LAN activity LED 	
Dimensions	
<ul style="list-style-type: none"> • 12" (W) x 9.6" (L) ATX (304.8mm x 243.84mm) 	

 **Note:** The CPU maximum thermal design power (TDP) is subject to chassis and heatsink cooling restrictions. For proper thermal management, please check the chassis and heatsink specifications for proper CPU TDP sizing.

Figure 1-4.
System Block Diagram



Differences between C9Z590-CG and C9Z590-CGW

	C9Z590-CG	C9Z590-CGW
PCIe M.2 E Key for WiFi and Bluetooth	No	Yes

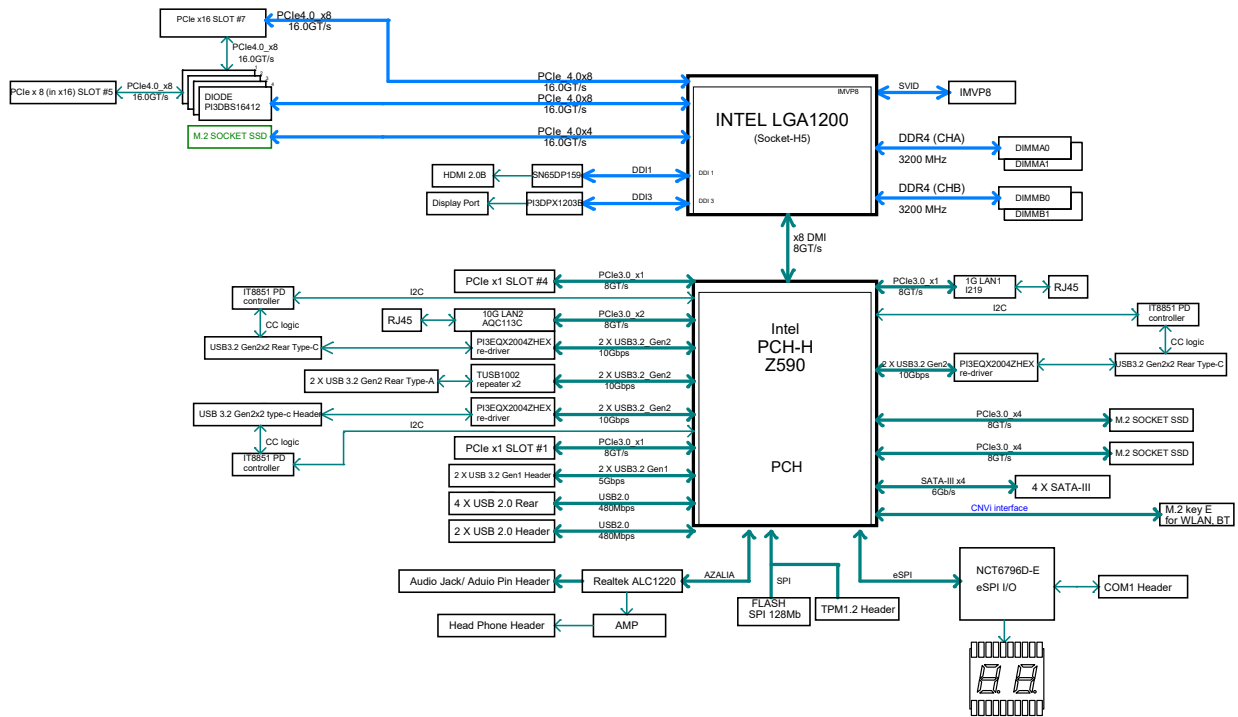
Note: This is a general block diagram and may not exactly represent the features on your motherboard. Refer to the previous pages for the actual specifications of your motherboard.

1.2 Processor and Chipset Overview

Built upon the functionality and capability of the 11th Gen Intel Core i9/i7/i5 series LAG1200 processor and the Intel PCH Z590 chipset, the C9Z590-CG/-CGW motherboard provides system performance, power efficiency, and feature sets to address the needs of next-generation computer users.

With the support of the new Intel Microarchitecture 14nm Process Technology, the C9Z590-CG/-CGW dramatically increases system performance for a multitude of server applications.

The Intel PCH Z590 chipset provides support, including the following features:

- DDR4 288-pin memory support
- Direct Media Interface
- Intel Matrix Storage Technology and Intel Rapid Storage Technology
- Triple NAND Interface
- Intel I/O Virtualization (VT-d) Support
- Intel Trusted Execution Technology Support
- PCIe 4.0 Interface (up to 16 GT/s)
- SATA Controller (up to 6Gb/sec)
- Advanced Host Controller Interface (AHCI)

1.3 Special Features

Recovery from AC Power Loss

The Basic I/O System (BIOS) provides a setting that determines how the system will respond when AC power is lost and then restored to the system. You can choose for the system to remain powered off (in which case you must press the power switch to turn it back on), or for it to automatically return to the power-on state. Refer to the Advanced section for this setting. The default setting is **Last State**.

1.4 System Health Monitoring

Onboard Voltage Monitors

An onboard voltage monitor will scan the voltages of the onboard chipset, memory, CPU, and battery continuously. Once a voltage becomes unstable, a warning is given, or an error message is sent to the screen. The user can adjust the voltage thresholds to define the sensitivity of the voltage monitor.

Fan Status Monitor with Firmware Control

PC health monitoring in the BIOS can check the RPM status of the cooling fans. The onboard CPU and chassis fans are controlled by Thermal Management via SIO.

Environmental Temperature Control

The thermal control sensor monitors the CPU temperature in real time and will turn on the thermal control fan whenever the CPU temperature exceeds a user-defined threshold. The overheat circuitry runs independently from the CPU. Once the thermal sensor detects that the CPU temperature is too high, it will automatically turn on the thermal fans to prevent the CPU from overheating. The onboard chassis thermal circuitry can monitor the overall system temperature and alert the user when the chassis temperature is too high.



Note: To avoid possible system overheating, please be sure to provide adequate air-flow to your system.

System Resource Alert

This feature is available when used with SuperDoctor 5 in the Windows OS or in the Linux environment. SuperDoctor is used to notify the user of certain system events. For example, you can configure SuperDoctor to provide you with warnings when the system temperature, CPU temperatures, voltages and fan speeds go beyond a predefined range.

1.5 ACPI Features

The Advanced Configuration and Power Interface (ACPI) defines a flexible and abstract hardware interface that provides a standard way to integrate power management features throughout a computer system, including its hardware, operating system and application software. This enables the system to automatically turn on and off peripherals such as CD-ROMs, network cards, hard disk drives and printers.

In addition to enabling operating system-directed power management, ACPI also provides a generic system event mechanism for Plug and Play, and an operating system-independent interface for configuration control. ACPI leverages the Plug and Play BIOS data structures, while providing a processor architecture-independent implementation that is compatible with appropriate Windows operating systems. For detailed information regarding OS support, please refer to the Supermicro website.

Slow Blinking LED for Suspend-state Indicator

When the CPU goes into a suspend state, the chassis power LED will start to blink to indicate that the CPU is in suspend mode. When the user presses any key, the CPU will "wake up," and the LED will automatically stop blinking and remain on.

1.6 Power Supply

As with all computer products, a stable power source is necessary for proper and reliable operation. It is even more important for processors that have high CPU clock rates where noisy power transmission is present.

The C9Z590-CG/-CGW motherboard accommodates a 24-pin ATX power supply. Although most power supplies generally meet the specifications required by the CPU, some are inadequate. In addition, one 12V 8-pin power connection is also required to ensure adequate power supply to the system. Also, your power supply must supply 1.5A for the Ethernet ports.

Warning: To avoid damaging the power supply or the motherboard, be sure to use a power supply that contains a 24-pin and an 8-pin power connector. Be sure to connect the power supplies to the 24-pin power connector (JPW1), and the 8-pin power connector (JPW2) on the motherboard. Failure in doing so may void the manufacturer warranty on your power supply and motherboard.

It is strongly recommended that you use a high quality power supply that meets ATX power supply Specification 2.02 or later. It must also be SSI compliant.

1.7 Serial Header

The C9Z590-CG/-CGW motherboard supports one serial communication connection. The COM header can be used for input/output. The UART provides legacy speeds with a baud rate of up to 115.2 Kbps as well as an advanced speed with baud rates of 250 K, 500 K, or 1 Mb/s, which support high-speed serial communication devices.

1.8 Super I/O

The Super I/O supports one high-speed, 16550 compatible serial communication port (UART). Each UART includes a 16-byte send/receive FIFO, a programmable baud rate generator, complete modem control capability and a processor interrupt system. The UART provides legacy speed with a baud rate of up to 115.2 Kbps as well as an advanced speed with baud rates of 250 K, 500 K, or 1 Mb/s, which support higher speed modems.

The Super I/O provides functions that comply with Advanced Configuration and Power Interface (ACPI), which includes support of legacy and ACPI power management through an SMI or SCI function pin. It also features auto power management to reduce power consumption.

Chapter 2

Installation

2.1 Static-Sensitive Devices

Electrostatic Discharge (ESD) can damage electronic components including memory modules. To avoid damaging your motherboard or your system, it is important to handle them very carefully. The following measures are generally sufficient to protect your equipment from ESD.

Precautions

- Use a grounded wrist strap designed to prevent static discharge.
- Touch a grounded metal object before removing the board from the antistatic bag.
- Handle the motherboard by its edges only; do not touch its components, peripheral chips, memory modules or gold contacts.
- When handling chips or modules, avoid touching their pins.
- Put the motherboard and peripherals back into their antistatic bags when not in use.
- For grounding purposes, make sure that your computer chassis provides excellent conductivity between the power supply, the case, the mounting fasteners and the motherboard.
- Use only the correct type of onboard CMOS battery. Do not install the onboard battery upside down to avoid possible explosion.

Unpacking

The motherboard is shipped in antistatic packaging to avoid static damage. When unpacking the motherboard, make sure that the person handling it is static protected.

2.2 Processor and Heatsink Installation

- Use ESD protection.
- Unplug the AC power cord from all power supplies after shutting down the system.
- Check that the plastic protective cover is on the CPU socket and none of the socket pins are bent. If they are, contact your retailer.
- When handling the processor, avoid touching or placing direct pressure on the LGA lands (gold contacts). Improper installation or socket misalignment can cause serious damage to the processor or CPU socket, which may require manufacturer repairs.
- Thermal grease is pre-applied on a new heatsink. No additional thermal grease is needed.
- Refer to the Supermicro website for updates on processor support.
- All graphics in this manual are for illustrations only. Your components may look different.

Installing the LGA1200 Processor

1. Press the load lever to release the load plate, which covers the CPU socket, from its locking position.

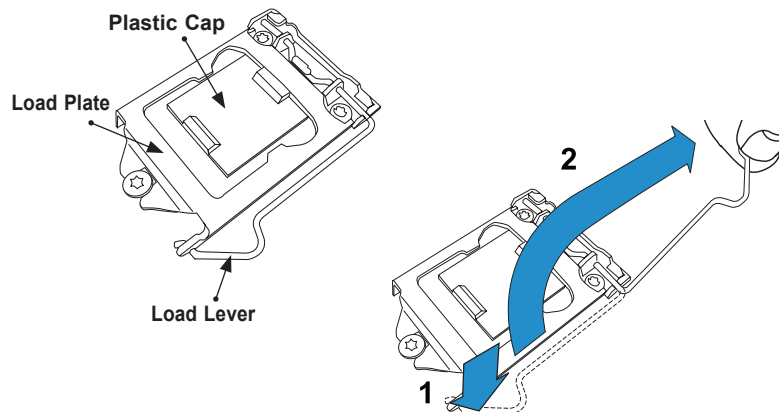

2. Gently lift the load lever to open the load plate. Remove the plastic cap.

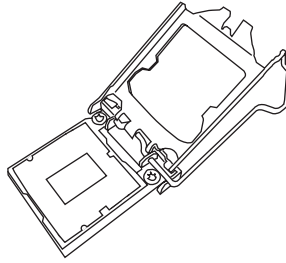

3. Use your thumb and your index finger to hold the CPU at the North center edge and the South center edge of the CPU.

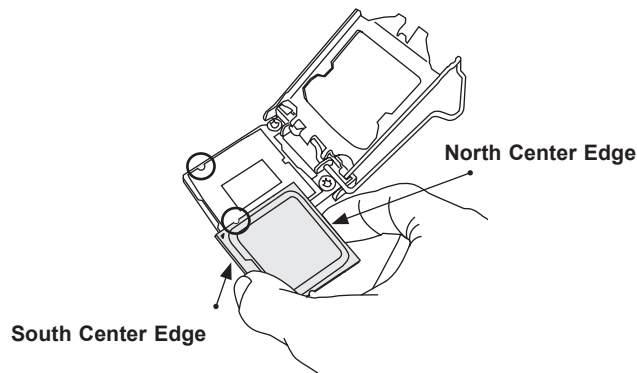

4. Align the small triangle marker on the CPU to its corresponding triangle marker on the load bracket. Once it is aligned, carefully lower the CPU straight down into the socket. (Do not drop the CPU on the socket, or move it horizontally or vertically.)

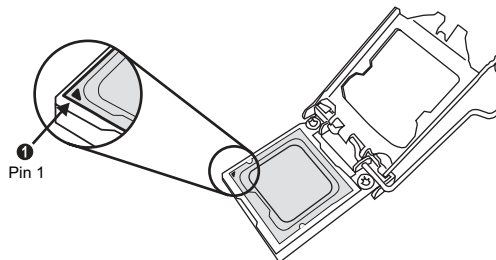

5. Do not rub the CPU against the surface or against any pins of the socket to avoid damaging the CPU or the socket.
6. With the CPU inside the socket, inspect the four corners of the CPU to make sure that the CPU is properly installed.
7. Use your thumb to gently push the load lever down to the lever lock.
8. Close the load plate with the CPU inside the socket. Lock the "Close 1st" lever first, then lock the "Open 1st" lever second. Gently push the load levers down to the lever locks.

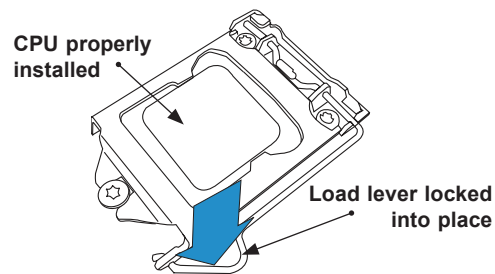

- ! **Attention!** You can only install the CPU inside the socket in one direction. Make sure that it is properly inserted into the CPU socket before closing the load plate. If it doesn't close properly, do not force it as it may damage your CPU. Instead, open the load plate again and double-check that the CPU is aligned properly.

Installing an Active CPU Heatsink with Fan

1. Apply the proper amount of thermal grease to the heatsink.
2. Place the heatsink on top of the CPU so that the four mounting holes on the heatsink are aligned with those on the retention mechanism.
3. Tighten the screws in the following order:

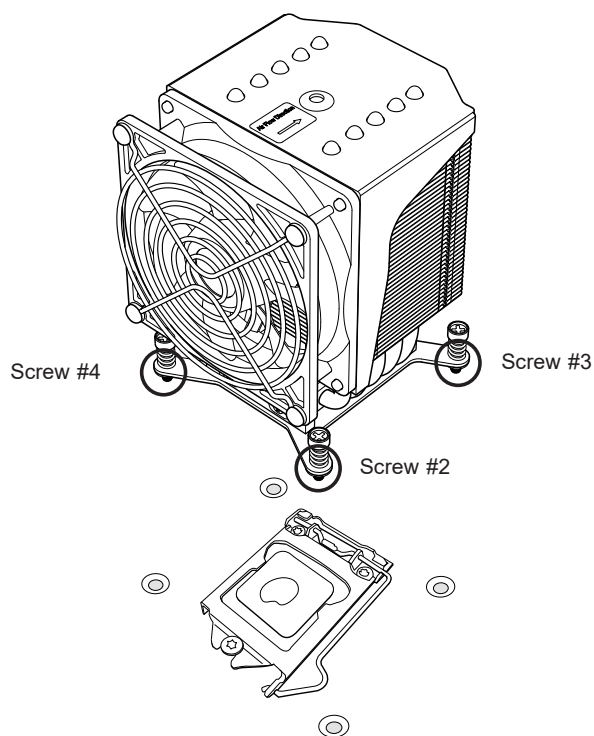

4. Once the screws are tightened, plug the power connector of cooler into either CPU_FAN1 or CPU_FAN2 header.



Note 1: Screw #1 is not shown in the illustration.

Note 2: Graphic drawings included in this manual are for reference only. They might look different from the components installed in your system.

Removing an Active CPU Heatsink with Fan

Warning: We do not recommend that the CPU or heatsink be removed. However, if you do need to remove the heatsink, please follow the instruction below to uninstall the heatsink to avoid damaging the CPU or other components.

1. Unplug the power cord from the power supply and power connector of cooler from fan header on the motherboard.
2. Loosen the screws in the order below.
3. Gently wiggle the heatsink to loosen it. Do not use excessive force when wiggling the heatsink.

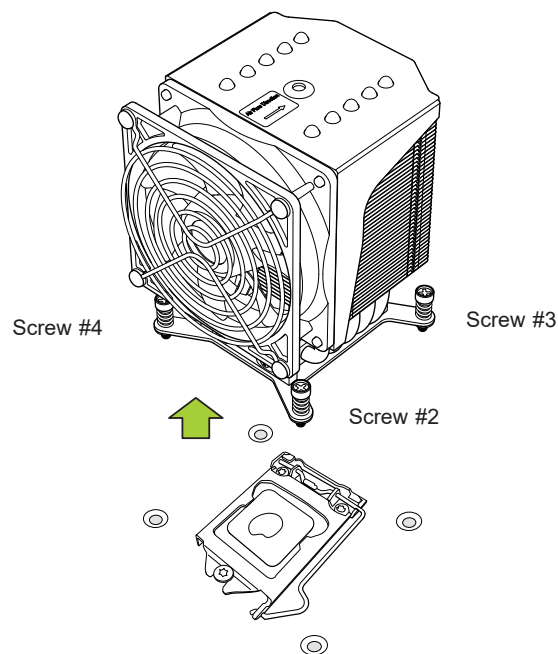

4. Once the heatsink is loosened, remove it from the motherboard.



Note: Screw #1 is not shown in the illustration.

2.3 Motherboard Installation

All motherboards have standard mounting holes to fit different types of chassis. Make sure that the locations of all the mounting holes for both the motherboard and the chassis match. Although a chassis may have both plastic and metal mounting fasteners, metal ones are highly recommended because they ground the motherboard to the chassis. Make sure that the metal standoffs click in or are screwed in tightly.

Tools Needed

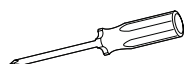

**Phillips
Screwdriver (1)**



Phillips Screws (9)



**Standoffs (9)
Only if Needed**

Location of Mounting Holes

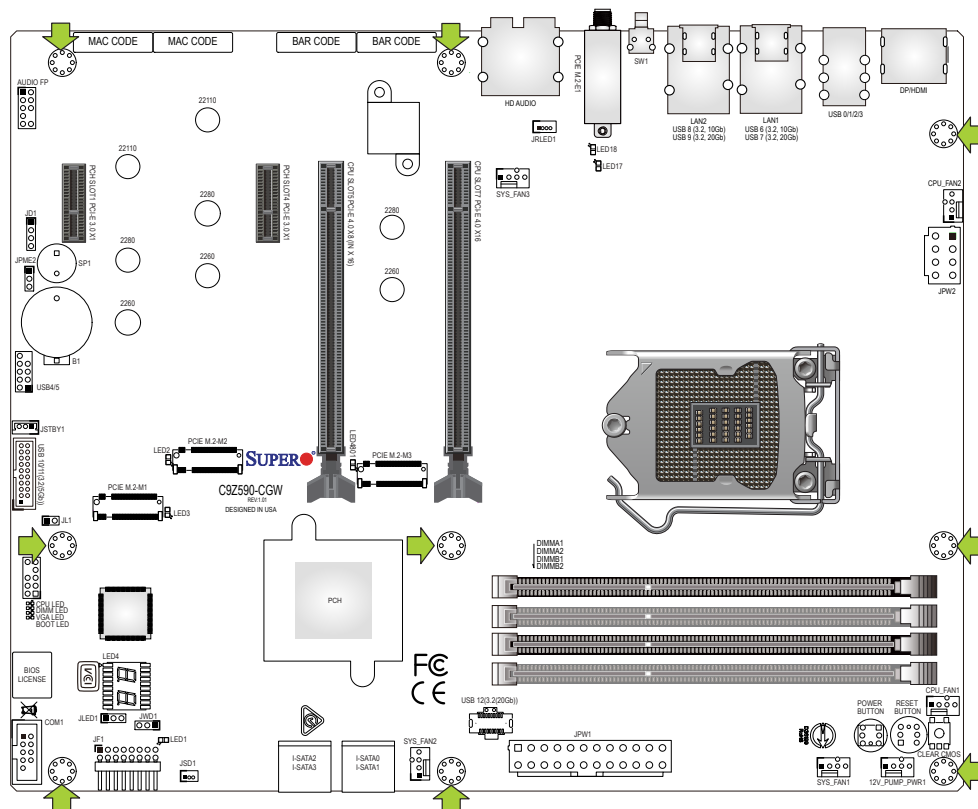

- Notes:**
1. To avoid damaging the motherboard and its components, please do not use a force greater than 8 lbf-in on each mounting screw during motherboard installation.
 2. Some components are very close to the mounting holes. Please take precautionary measures to avoid damaging these components when installing the motherboard to the chassis.

Installing the Motherboard

1. Install the I/O shield into the back of the chassis, if applicable.

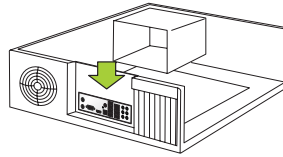

2. Locate the mounting holes on the motherboard. Refer to the previous page for the location.

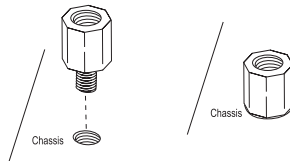

3. Locate the matching mounting holes on the chassis. Align the mounting holes on the motherboard against the mounting holes on the chassis.

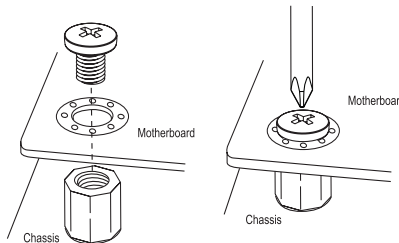

4. Install standoffs in the chassis as needed.
5. Install the motherboard into the chassis carefully to avoid damaging other motherboard components.
6. Using the Phillips screwdriver, insert a pan head #6 screw into a mounting hole on the motherboard and its matching mounting hole on the chassis.
7. Repeat Step 6 to insert #6 screws into all mounting holes.
8. Make sure that the motherboard is securely placed in the chassis.

 **Note:** Images displayed are for illustration only. Your chassis or components might look different from those shown in this manual.

2.4 Memory Support and Installation



Note: Check the Supermicro website for recommended memory modules.



Important: Exercise extreme care when installing or removing DIMM modules to prevent any possible damage.

General Guidelines for Optimizing Memory Performance

- When installing memory modules, the DIMM slots should be populated in the following order: DIMMA2, DIMMB2, then DIMMA1, DIMMB1.
- When installing only two memory modules, please use DIMMA2 and DIMMB2.
- Always use DDR4 memory of the same type, size, and speed.
- Mixed DIMM speeds can be installed. However, all DIMMs will run at the speed of the slowest DIMM.
- The motherboard will support odd-numbered modules (one or three modules installed). However, to achieve the best memory performance, a balanced memory population is recommended.

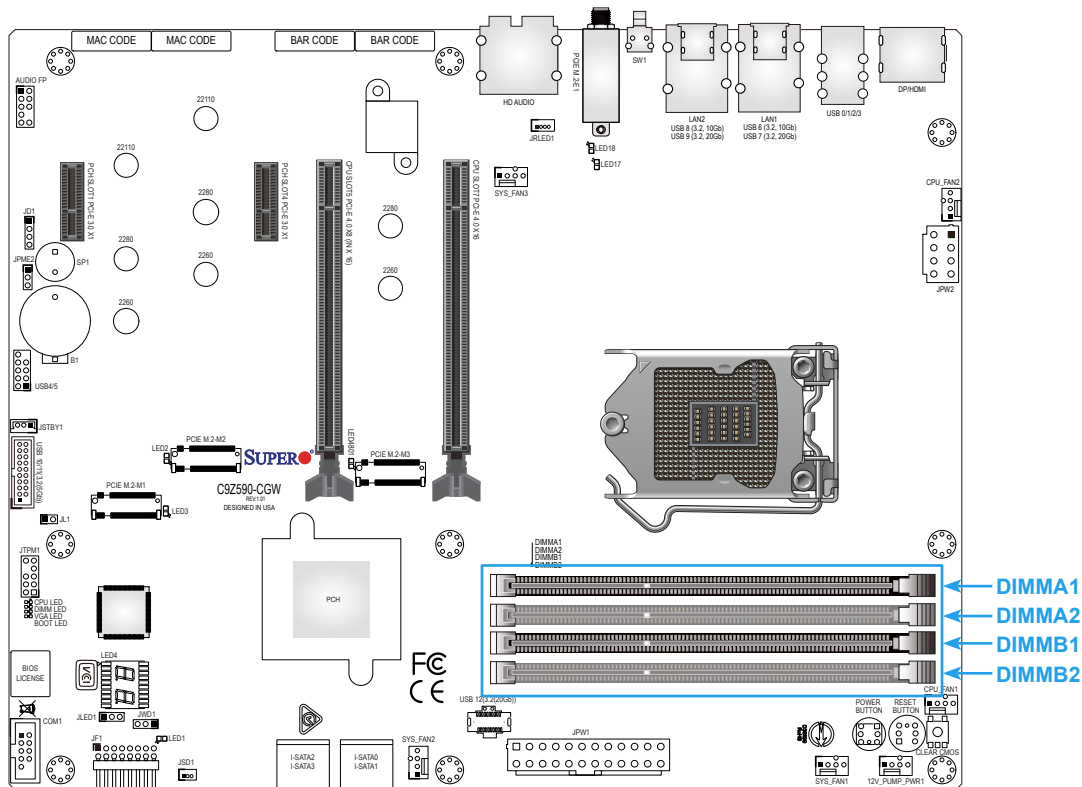

DIMM Installation

1. Insert DIMM modules in the following order: DIMMA2, DIMMB2, then DIMMA1, DIMMB1. For the system to work properly, use memory modules of the same type and speed.
2. Align the DIMM module key with the receptive point on the single-latch DIMM slot.
3. Push the release tab outwards to unlock the slot.
4. Align the notch on the end of the module against the receptive point on the end of the slot.
5. Press both ends of the module straight down into the slot until the module snaps into place.
6. Push the release tab to the lock position to secure the module into the slot.

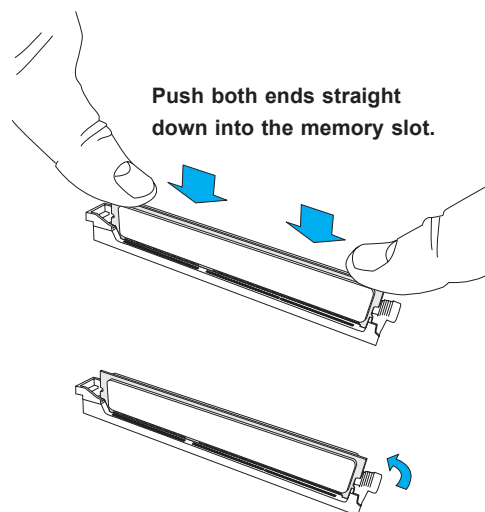
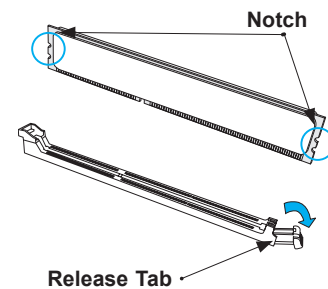
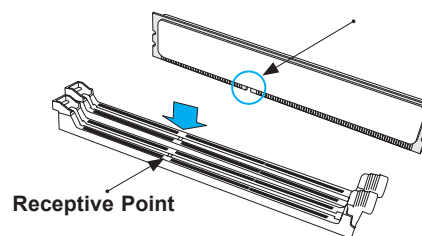
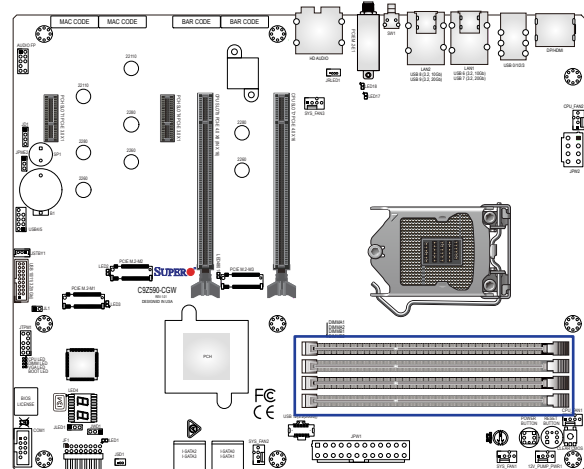

DIMM Removal

Reverse the steps above to remove the DIMM modules from the motherboard.

2.5 M.2 Installation (optional)

Three M.2 M key sockets are supported by the C9Z590-CG/-CGW. M.2 devices are used for solid state storage and internal expansion. Follow the steps below in order to install an M.2 device.

 **Note:** The steps below are examples of the M.2 installation, the motherboard you received may or may not look exactly the same.

1. Locate and remove the retaining screws on the M.2 heatsinks.

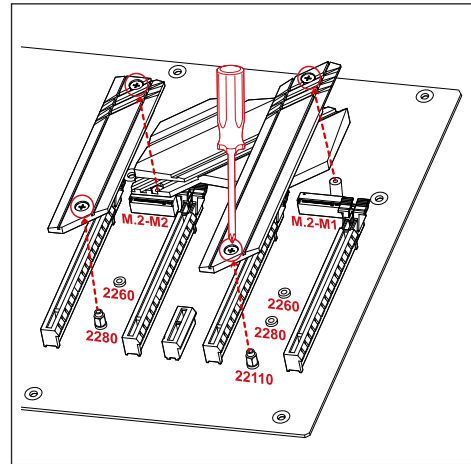

2. With the heatsink removed, locate the bundled standoff on the length of M.2 device if necessary.

 **Note:** Three standoffs have been pre-installed in the 2280 and 22110 mounting holes and designed for the heatsink installation. To plug the smaller M.2 device, please use other standoff bundled in the motherboard package.

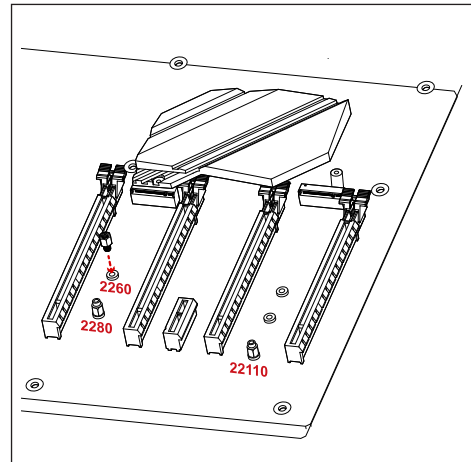

3. Carefully plug the M.2 device into the M.2 socket and lower the semi-circle notched end onto the standoff.

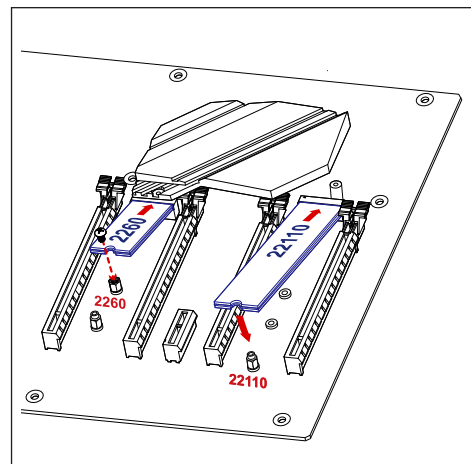

4. Remove the M.2 heatsink thermal pad cover.

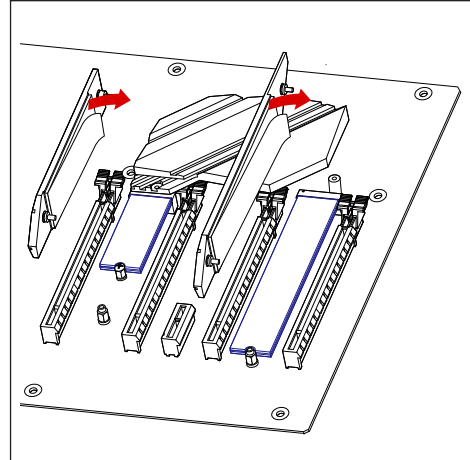

5. Replace the M.2 heatsink and the retaining screws.
Tighten the screws to secure the heatsink into place.

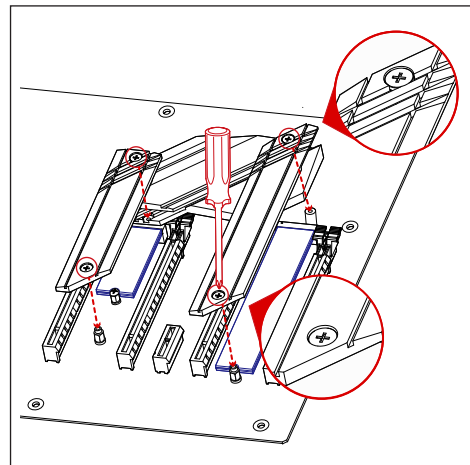

 **Notes:**

1. **DO NOT** install the bounded M.2 heatsink (refer to step 4 and 5) if the M.2 device has a heatsink installed.
2. Please assemble the M.2 heatsink back to the motherboard once the M.2 device has been removed.
3. Beware of the direction when assembling the heatsink (refer to step 5).

2.6 Rear I/O Ports

Refer to Figure 2-1 below for the locations and descriptions of the various I/O ports on the rear of the motherboard.

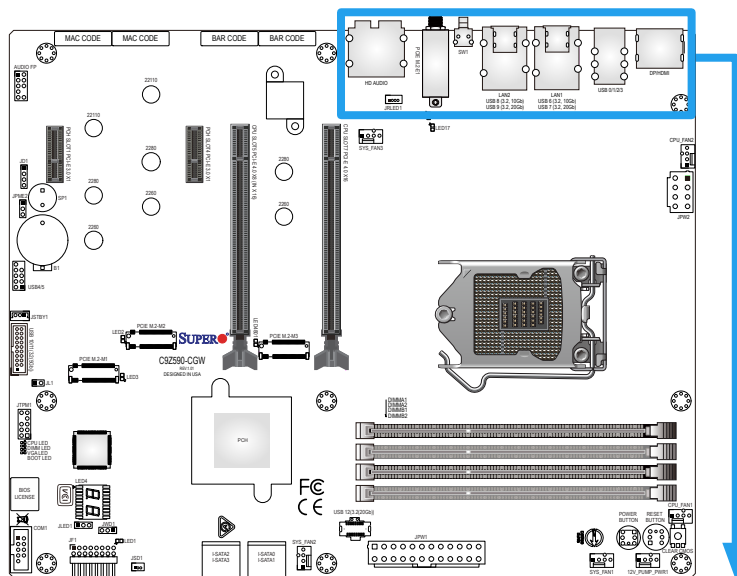
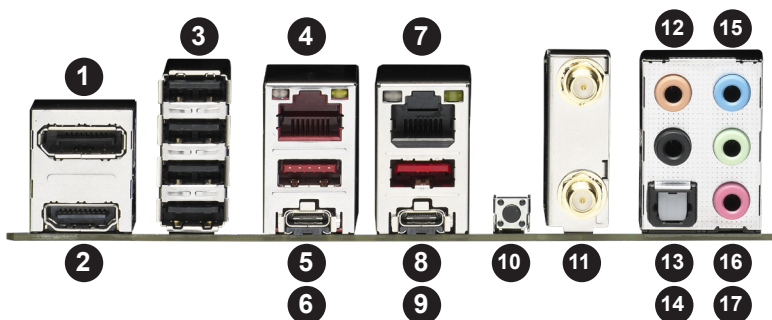

Figure 2-1. I/O Port Locations and Definitions



Rear I/O Ports			
#	Description	#	Description
1	DisplayPort 1.4a	10	SW1: CLEAR CMOS
2	HDMI Port 2.0b	11	WiFi 6+BT 5.1 (C9Z590-CGW only)
3	USB0/1/2/3: USB 2.0 (Type A)	12	Center/LFE Out
4	Ethernet RJ45 1GbE Port 1	13	Surround Out
5	USB6: USB 3.2 Gen 2 (10Gb, Type A)	14	S/PDIF Out
6	USB7: USB 3.2 Gen 2x2 (20Gb, Type C)	15	Line In
7	Ethernet RJ45 10GbE Port 2	16	Line Out
8	USB8: USB 3.2 Gen 2 (10Gb, Type A)	17	Mic In
9	USB9: USB 3.2 Gen 2x2 (20Gb, Type C)		

Back Panel High Definition Audio (HD Audio)

This motherboard features a 7.1+2 Channel High Definition Audio (HDA) codec that provides 10 DAC channels. The HD Audio connections simultaneously supports multiple-streaming 7.1 sound playback with 2 channels of independent stereo output through the front panel stereo out for front, rear, center and subwoofer speakers. Use the Advanced software included in the CD-ROM with your motherboard to enable this function.

Audio Configuration					
		2 Channel	4.1 Channel	5.1 Channel	7.1 Channel
1	Orange (Center/LFE Out)			Center/Subwoofer	Center/Subwoofer
2	Black (Surround)		Rear Speaker Out	Rear Speaker Out	Rear Speaker Out
3	Light Blue (Line In/Side Speaker Out)	Line In	Line In	Line In	Side Speaker Out
4	Lime (Line Out/Front Speaker Out)	Line Out	Front Speaker Out	Front Speaker Out	Front Speaker Out
5	Pink (Mic In)	Mic In	Mic In	Mic In	Mic In

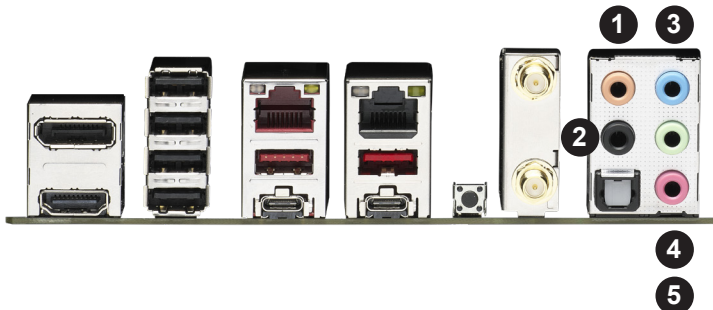

- 1. Center/LFE Out
- 2. Surround Out
- 3. Line In
- 4. Line Out
- 5. Mic In

DisplayPort Port

DisplayPort 1.4a, developed by the VESA consortium, delivers digital display at a fast refresh rate. It can connect to virtually any display device using a DisplayPort adapter for devices, such as VGA, DVI, and HDMI.

HDMI Port

One High-Definition Multimedia Interface (HDMI) 2.0b port is located on the I/O back panel. This port is used to display both high definition video and digital sound through an HDMI display, using a single HDMI cable (not included).

LAN Ports

Two RJ45 Ethernet LAN ports (LAN1/LAN2) are located on the I/O back panel to provide network connections. These ports accept RJ45 type cables.



Note: Please refer to Section 2.10 for LAN LED information.

LAN1 Port Pin Definitions				LAN2 Port Pin Definitions			
Pin#	Definition	Pin#	Definition	Pin#	Definition	Pin#	Definition
19	SGND	28	SGND	10	SGND	19	SGND
20	TD0+	29	Link 1000 LED (Yellow, +3V3SB)	11	TD0+	20	Link 1000 LED (Yellow, +3V3SB)
21	TD0-	30	Link 100 LED (Green, +3V3SB)	12	TD0-	21	Link 100 LED (Green, +3V3SB)
22	TD1+	31	P3V3SB	13	TD1+	22	P3V3SB
23	TD1-	32	Act LED	14	TD1-	23	Act LED
24	TD2+	33	Ground	15	TD2+	24	Ground
25	TD2-	34	Ground	16	TD2-	25	Ground
26	TD3+	35	Ground	17	TD3+	26	Ground
27	TD3-	36	Ground	18	TD3-	27	Ground

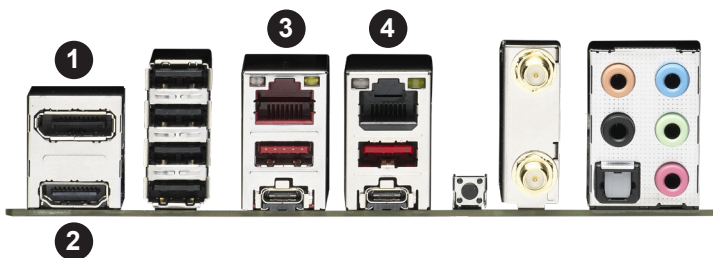

1. DisplayPort Port 1.4a
2. HDMI Port 2.0b
3. LAN1
4. LAN2

2.7 Front Control Panel

JF1 contains header pins for various buttons and indicators that are normally located on a control panel at the front of the chassis. These connectors are designed specifically for use with Supermicro chassis. Refer to the figure below for the descriptions of the front control panel buttons and LED indicators.

Note: You may connect the JF1 using the bundled S-Connector. The S-Connector is a plug designed to connect the front control panel header on the motherboard and front control panel cables of chassis. Please align the printed indications on the S-Connector with the corresponding pins on JF1 when plugging in. Refer to the checklist table in Section 1.1 and contact Supermicro for more detailed connector information.

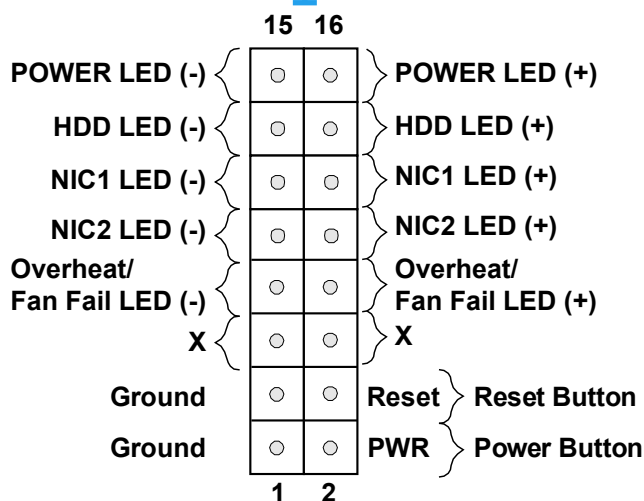
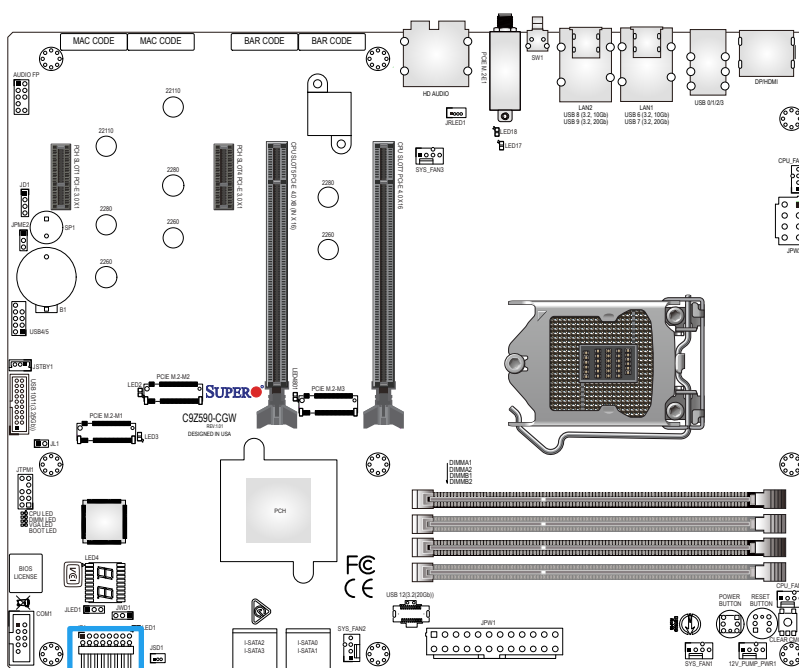

Power LED

The Power LED connection is located on pins 15 and 16 of JF1. Refer to the table below for pin definitions.

Power LED Pin Definitions (JF1)	
Pin#	Definition
15	Power LED (-)
16	Vcc / Power LED (+)

HDD LED

The HDD LED connection is located on pins 13 and 14 of JF1. Attach a cable here to indicate the status of HDD-related activities, including IDE and SATA activities. Refer to the table below for pin definitions.

HDD LED Pin Definitions (JF1)	
Pin#	Definition
13	HDD LED (-)
14	Vcc / HDD LED (+)

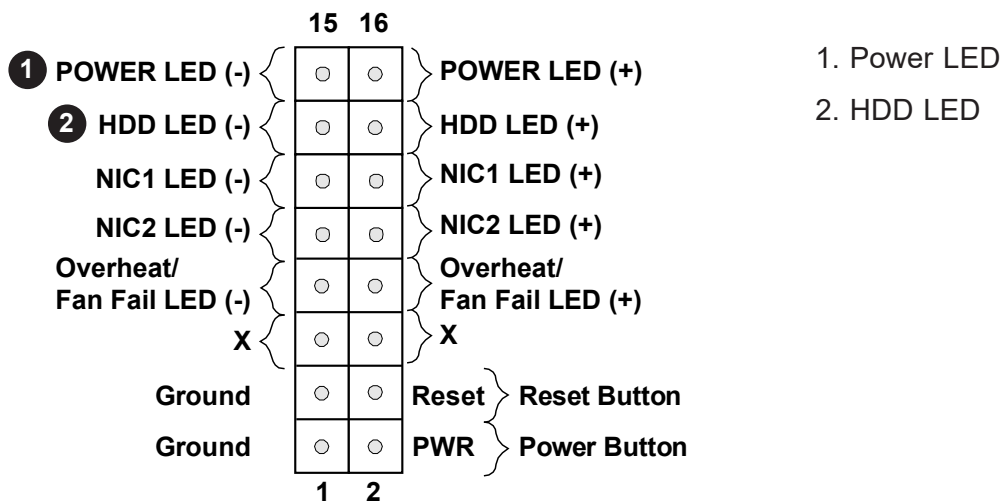

NIC1/NIC2 (LAN1/LAN2) LED

The Network Interface Controller (NIC) LED connection for LAN1/LAN2 is located on pins 9/11 and 10/12 of JF1. Attach an LED indicator to this header to display network activity. Refer to the table below for pin definitions.

NIC1/NIC2 LED Pin Definitions (JF1)	
Pin#	Definition
9/11	NIC2/NIC1 LED (-)
10/12	Vcc / NIC2/NIC1 LED (+)

Overheat (OH)/Fan Fail LED

Connect an LED cable to OH/Fan Fail connections on pins 7 and 8 of JF1 to provide warnings for chassis overheat/fan failure. Refer to the tables below for pin definitions.

OH/Fan Fail LED Pin Definitions (JF1)	
Pin#	Definition
7	OH/Fan Fail LED (-)
8	Vcc / OH/Fan Fail LED (+)

OH/Fan Fail Indicator Pin Definitions (JF1)	
State	Definition
Off	Normal
On	Overheat
Flashing	Fan Fail

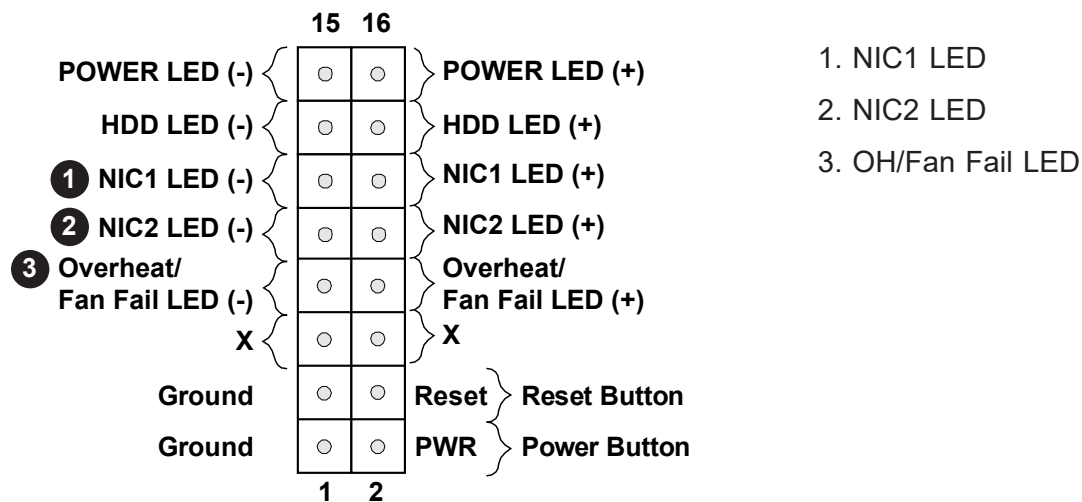

Reset Button

The Reset Button connection is located on pins 3 and 4 of JF1. Attach it to a hardware reset switch on the computer case to reset the system. Refer to the table below for pin definitions.

Reset Button Pin Definitions (JF1)	
Pin#	Definition
3	Ground
4	Reset Button

Power Button

The Power Button connection is located on pins 1 and 2 of JF1. Momentarily contacting both pins will power on/off the system. To turn off the power in the suspend mode, press the button for at least four seconds. Refer to the table below for pin definitions.

Power Button Pin Definitions (JF1)	
Pin#	Definition
1	Ground
2	Power Button

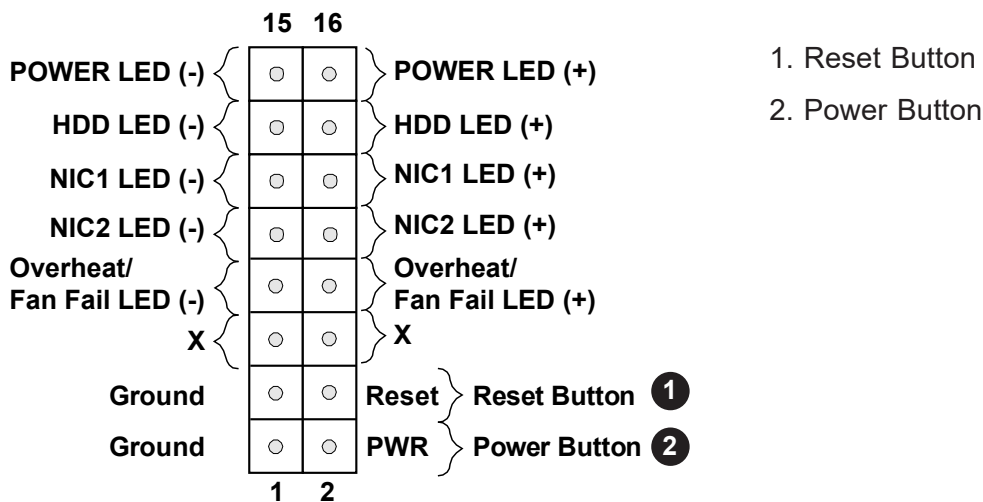

2.8 Connectors

This section provides brief descriptions and pinout definitions for onboard headers and connectors. Be sure to use the correct cable for each header or connector.

Power Connections

ATX Power Supply Connector

The 24-pin power supply connector (JPW1) meets the ATX SSI EPS 12V specification. You must also connect the 8-pin (JPW2) processor power connector to the power supply.

ATX Power Supply Connector Pin Definitions			
Pin#	Definition	Pin#	Definition
13	+3.3V	1	+3.3V
14	-12V	2	+3.3V
15	Ground	3	Ground
16	PS_ON	4	+5V
17	Ground	5	Ground
18	Ground	6	+5V
19	Ground	7	Ground
20	Res (NC)	8	PWR_OK
21	+5V	9	5VSB
22	+5V	10	+12V
23	+5V	11	+12V
24	Ground	12	+3.3V

Required Connection

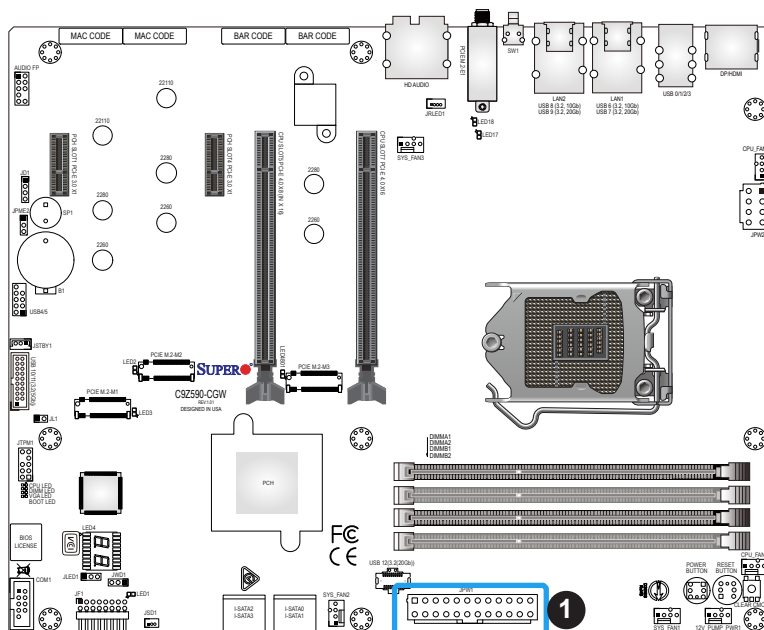

1. ATX Power Supply Connector

8-Pin Power Connector

JPW2 is an 8-pin 12V DC power input for the CPU that must be connected to the power supply. Refer to the table below for pin definitions.

8-pin Power Pin Definitions	
Pin#	Definition
1 - 4	Ground
5 - 8	+12V

Required Connection



Important: To provide adequate power supply to the motherboard, be sure to connect the 24-pin ATX PWR and the 8-pin PWR connectors to the power supply. Failure to do so may void the manufacturer warranty on your power supply and motherboard.

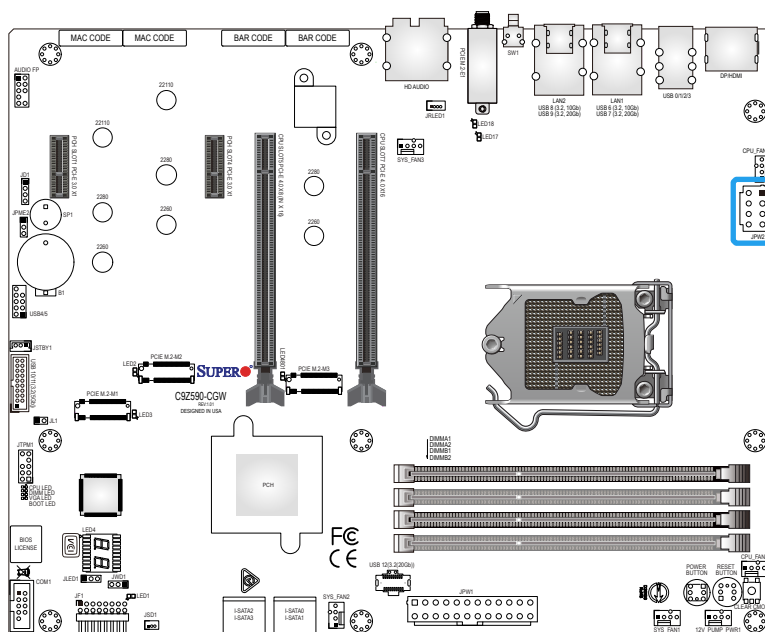

1. 8-Pin Power Connector

Headers

Fan Headers

There are five 4-pin fan headers (CPU_FAN1 ~ CPU_FAN2, SYS_FAN1 ~ SYS_FAN3) on the motherboard. Although pins 1-3 of the system fan headers are backwards compatible with the traditional 3-pin fans, the 4-pin fans are recommended to take advantage of the fan speed control. This allows fan speeds to be automatically adjusted based on the motherboard temperature. Refer to the table below for pin definitions.

Fan Headers Pin Definitions	
Pin#	Definition
1	Ground (Black)
2	2A/+12V (Red)
3	Tachometer
4	PWM_Control

Pump Power Header

This motherboard has one +12V header for optional CPU liquid cooling systems. When using a liquid cooling system, attach the pump power cable to the 12V_PUMP_PWR1 header.

Pump Power Header Pin Definitions	
Pin#	Definition
1	Ground (Black)
2	2A/+12V (Red)
3	N/A
4	N/A

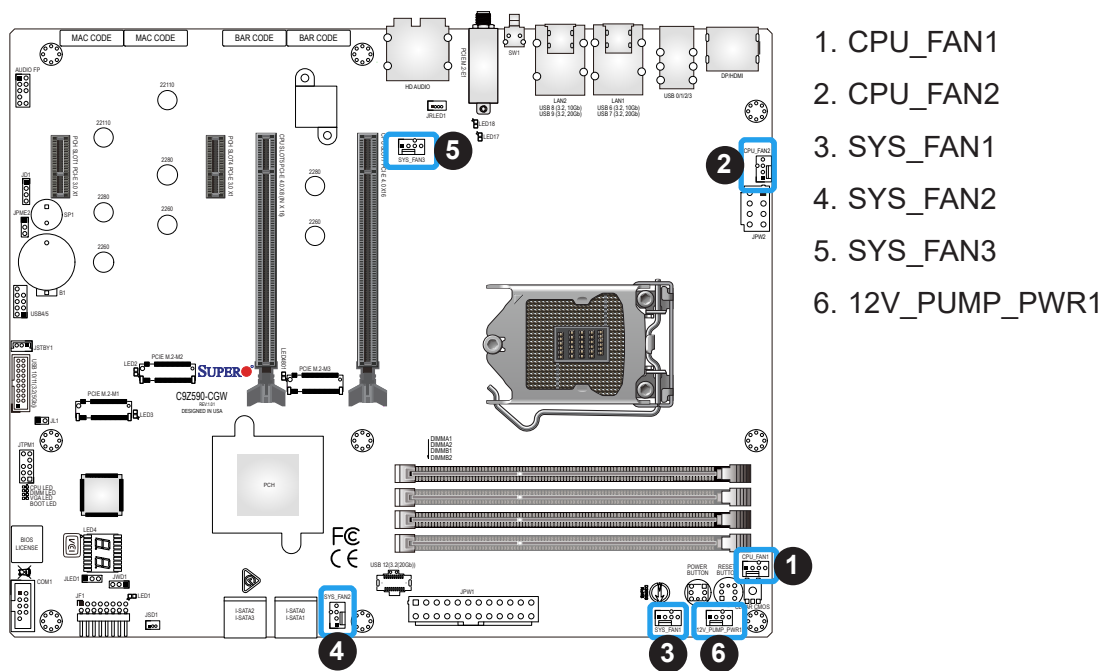

1. CPU_FAN1
2. CPU_FAN2
3. SYS_FAN1
4. SYS_FAN2
5. SYS_FAN3
6. 12V_PUMP_PWR1

Chassis Intrusion Header

A Chassis Intrusion header is located at JL1 on the motherboard. Attach the appropriate cable from the chassis to inform you of a chassis intrusion when the chassis is opened. Refer to the table below for pin definitions.

Chassis Intrusion Header Pin Definitions	
Pin#	Definition
1	Intrusion Input
2	Ground

Speaker Header

On the JD1 Header, pins 3 and 4 are used for the internal speaker. Close pins 3 and 4 with a cap to use the onboard speaker. If you wish to use an external speaker, close pins 1-4 with a cable. Refer to the table below for pin definitions.

Speaker Header Pin Definitions	
Pin#	Definition
3-4	Internal Speaker
1-4	External Speaker

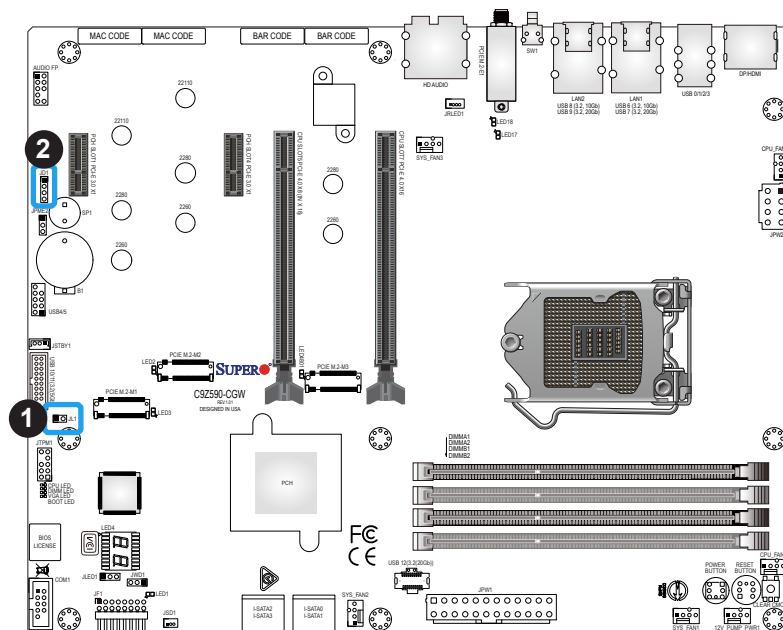

1. Chassis Intrusion Header
2. Speaker Header

Power LED Header

An onboard Power LED header is located at JLED1. This Power LED header is connected to the Front Control Panel located at JF1 to indicate the status of system power. Refer to the table below for pin definitions.

Power LED Header Pin Definitions	
Pin#	Definition
1	VCC / POWER LED (+) in JF1
2	POWER LED (-) in JF1
3	POWER LED (-) in JF1

White Light LED Header

This 4-pin connector provides the connection to white light LED board inside the I/O cover. It is located at JRLED1 on the motherboard. Refer to the table below for pin definitions.

White Light LED Header Pin Definitions	
Pin#	Definition
1	VCC
2	NC
3	NC
4	Ground

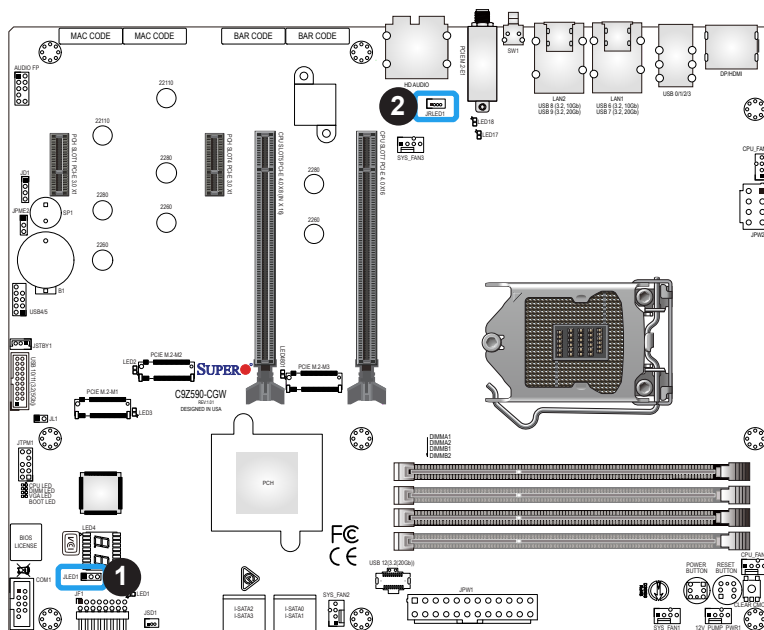

1. Power LED Header
2. White Light LED Header

DOM PWR Connector

The Disk-On-Module (DOM) power connector, located at JSD1, provides 5V power to a solid state DOM storage device connected to one of the SATA ports. Refer to the table below for pin definitions.

DOM PWR Connector Pin Definitions	
Pin#	Definition
1	5V
2	Ground
3	Ground

Standby Power Header

The Standby Power header is located at JSTBY1 on the motherboard. Refer to the table below for pin definitions.

Standby Power Header Pin Definitions	
Pin#	Definition
1	+5V Standby
2	Ground
3	Wake-up

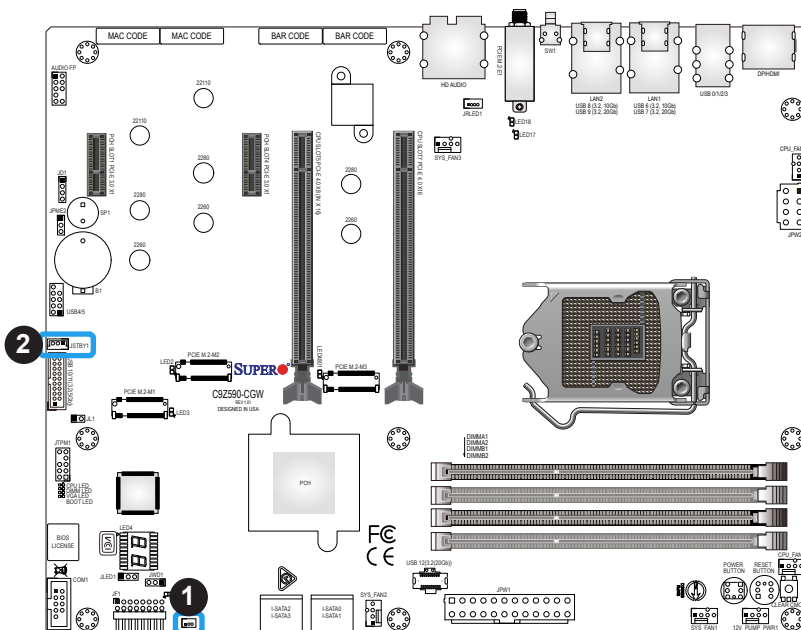

1. DOM PWR Connector
2. Standby Power Header

M.2 Sockets

M.2 sockets are designed for devices such as memory cards. These devices must conform to the PCIe M.2 specifications (formerly known as NGFF). There are three M.2 sockets (M-Key) located on the motherboard. Refer to the table below for more information.

Sockets	Bus Interface	Form Factors	RAID Levels
PCIE_M.2-M1 (attached to PCH)	PCIe 3.0 x4	2260, 2280 and 22110	0 and 1
PCIE_M.2-M2 (attached to PCH)	PCIe 3.0 x4	2260, 2280 and 22110	0 and 1
PCIE_M.2-M3 (attached to CPU)	PCIe 4.0 x4	2260 and 2280	0 and 1*

Note: PCIe M.2-M3 doesn't support RAID 0/1 for 3rd party NVMe SSD. To set up RAID 0/1 using the storage device installed in PCIe M.2-M3 socket, the device must be an Intel NVMe SSD.

SATA Ports

Four Serial ATA (SATA) 3.0 connectors (I-SATA 0~3) are supported on the motherboard. These I-SATA 3.0 ports are supported by the Intel Z590 PCH chip (supports RAID 0, 1, 5, and 10). SATA ports provide serial-link signal connections, which are faster than the connections of Parallel ATA.

Note: For more information on the SATA HostRAID configuration, please refer to the Intel SATA HostRAID user's guide posted on our website at <https://www.supermicro.com/support/manuals/>.

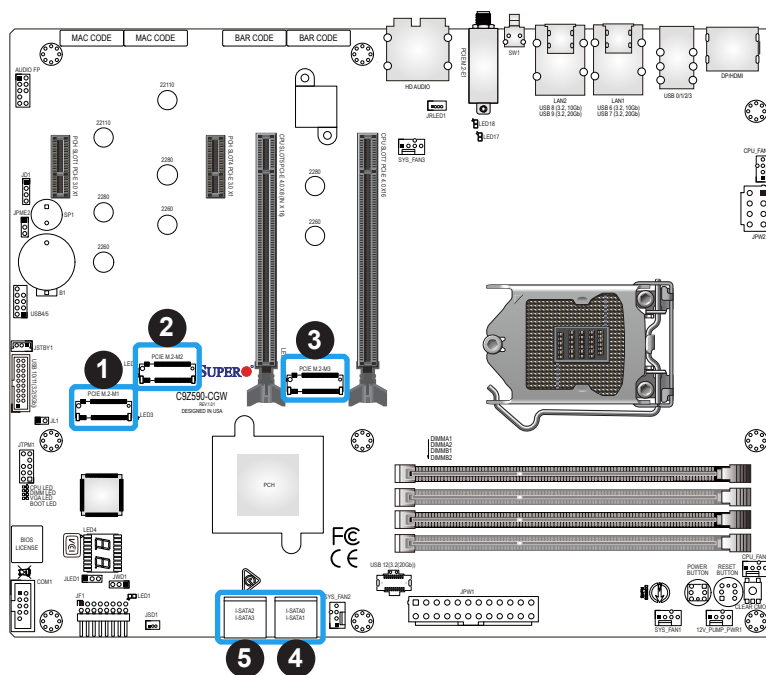

1. PCIe M.2-M1
2. PCIe M.2-M2
3. PCIe M.2-M3
4. I-SATA0/I-SATA1
5. I-SATA2/I-SATA3

Front Panel Audio Header

A 10-pin Audio header at AUDIO FP is supported on the motherboard. This header allows you to connect the motherboard to a front panel audio control panel, if needed. Connect an audio cable to the audio header to use this feature (not supplied). Refer to the table below for pin definitions.

Front Panel Audio Header Pin Definitions			
Pin#	Definition	Pin#	Definition
1	Microphone_Left	6	Ground
2	Audio_Ground	7	Jack_Detect
3	Microphone_Right	8	Key
4	Audio_Detect	9	Line_2_Left
5	Line_2_Right	10	Ground

Internal Speaker/Buzzer

The Internal Speaker/Buzzer (SP1) is used to provide audible indications for various beep codes. Refer to the table below for pin definitions.

Internal Buzzer Pin Definitions		
Pin#	Definition	
1	Pos (+)	Beep In
2	Neg (-)	Alarm Speaker

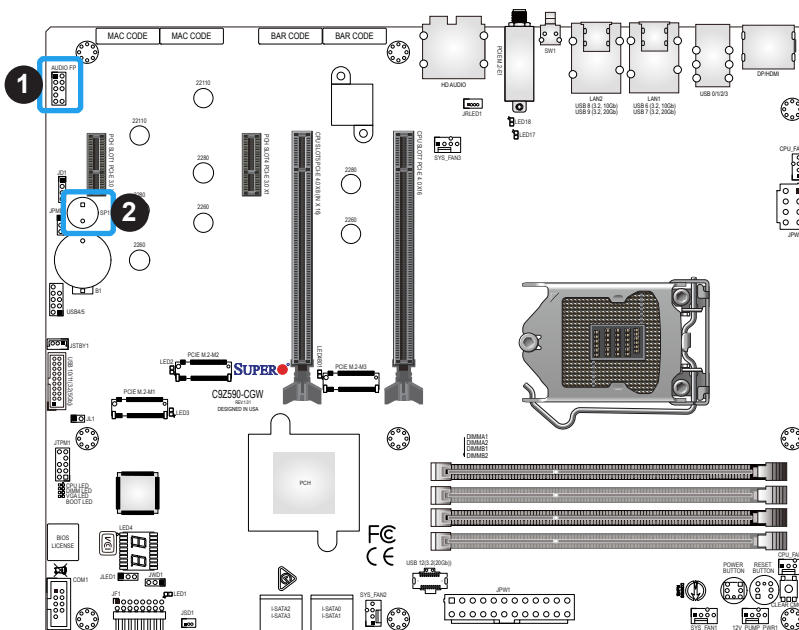

1. Front Panel Audio Header
2. Internal Speaker/Buzzer

Serial (COM) Header

There is one serial (COM port) header on the motherboard. COM1 is located next to the JF1 header. Refer to the table below for pin definitions.

Serial (COM) Header Pin Definitions			
Pin#	Definition	Pin#	Definition
1	DCD	6	DSR
2	RXD	7	RTS
3	TXD	8	CTS
4	DTR	9	RI
5	Ground	10	N/A

TPM/Port 80 Header

A Trusted Platform Module (TPM)/Port 80 header is located at JTPM1 to provide TPM support and Port 80 connection. Use this header to enhance system performance and data security. Refer to the table below for pin definitions. Please go to the following link for more information on the TPM: <http://www.supermicro.com/manuals/other/TPM.pdf>.

TPM/Port 80 Header Pin Definitions			
Pin#	Definition	Pin#	Definition
1	P3V3	2	SPI_TPM_CS_N
3	PCIE_RESET_N	4	SPI_PCB_MISO
5	SPI_PCH_CLK	6	GND
7	SPI_PCH_MOSI	8	X
9	P3V3_STBY	10	IRQ_TPM_SPI_N

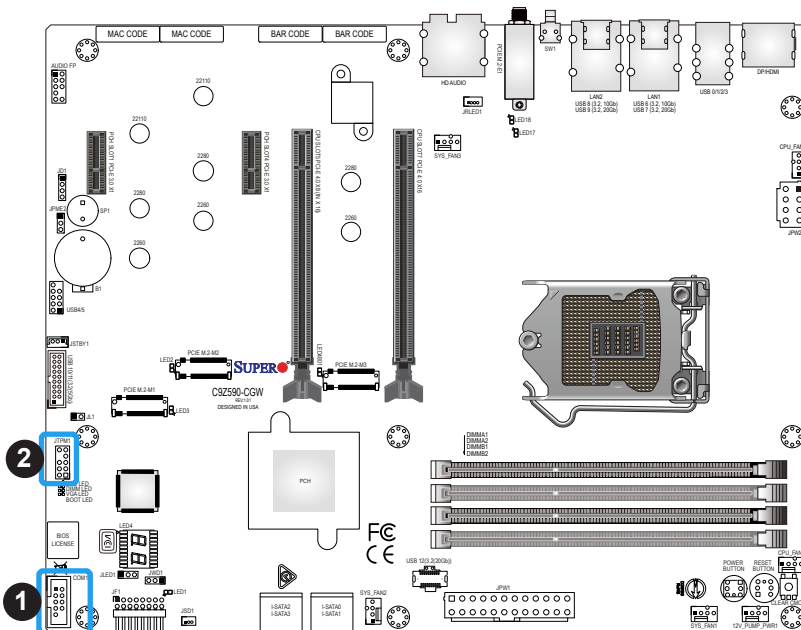

1. Serial (COM) Header
2. TPM/Port 80 Header

2.9 Jumper Settings

How Jumpers Work

To modify the operation of the motherboard, jumpers can be used to choose between optional settings. Jumpers create shorts between two pins to change the function of the connector. Pin 1 is identified with a square solder pad on the printed circuit board. Refer to the diagram below for an example of jumping pins 1 and 2. Refer to the motherboard layout page for jumper locations.

 **Note:** On two-pin jumpers, "Closed" means the jumper is on and "Open" means the jumper is off the pins.

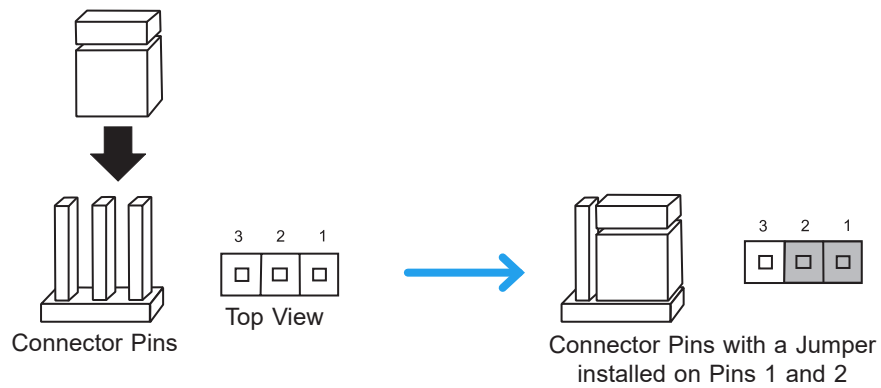

Clear CMOS/SW1 Button

Clear CMOS Button is used to clear the saved system setup configuration stored in the CMOS chip. All the settings will be erased and restored to the factory defaults after pressing this button. On this motherboard, there are two buttons which built-in this function. One is the SW1 button located on the I/O back panel and the other is the Clear CMOS button located next to the Reset Button.

Power Button

In addition to the soft power switch provided in JF1, your motherboard is equipped with a 'soft' power button on the motherboard. This switch works the same way as the soft power switch on JF1.

Reset Button

When pressed, the Reset Button will reset the system and reboot. This action will erase everything in memory and restart the system.

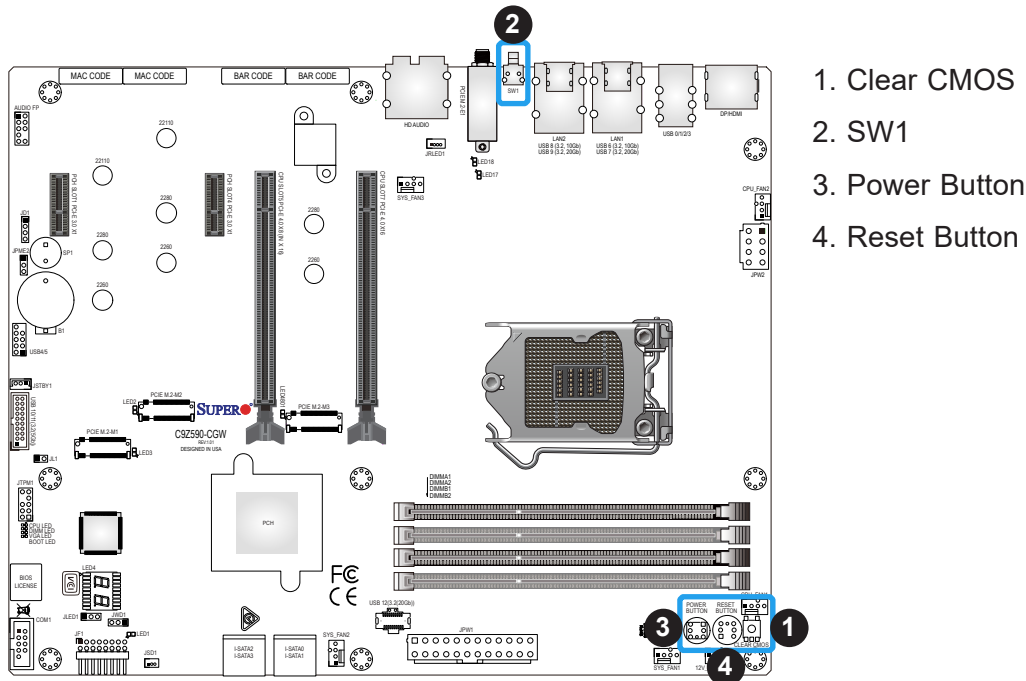

Manufacturing Mode

Close pins 2 and 3 of JPME2 to bypass SPI flash security and force the system to operate in Manufacturing Mode, allowing you to flash the system firmware from a host server for system setting modifications. Refer to the table below for jumper settings.

Manufacturing Mode Jumpers Settings	
Pin#	Definition
1-2	Normal (Default)
2-3	Manufacture Mode

Watch Dog

Watch Dog (JWD1) is a system monitor that can reboot the system when a software application hangs. Close pins 1 and 2 to reset the system if an application hangs. Close pins 2 and 3 to generate a non-maskable interrupt signal for the application that hangs. Refer to the table below for jumper settings.

Watch Dog Jumpers Settings	
Jumper Setting	Definition
Pins 1-2	Reset (Default)
Pins 2-3	NMI
Open	Disabled

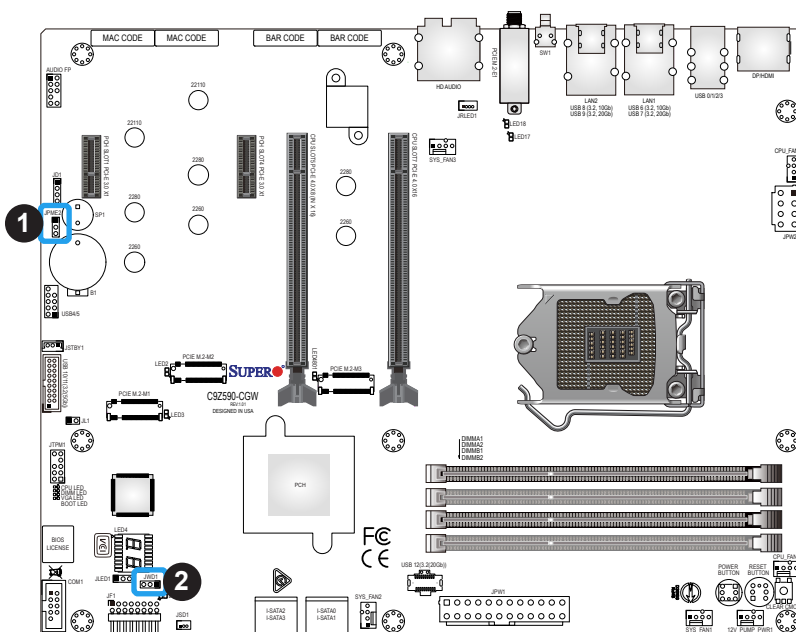

1. Manufacturing Mode
2. Watch Dog

2.10 LED Indicators

LAN1 LEDs

The LED of LAN1 on the left indicates the speed of the connection, and the LED of LAN1 on the right indicates activity. Refer to the tables below for more information.

LAN1 Link Indicator LED Settings	
LED Color	Definition
Off	10Mbps
Green	100Mbps
Amber	1 Gbps

LAN1 Activity Indicator LED Settings		
Color	Status	Definition
Yellow	Flashing	Active

LAN2 LEDs

The LED of LAN2 on the left indicates activity, and the LED of LAN2 on the right indicates the speed of the connection. Refer to the tables below for more information.

LAN2 Activity Indicator LED Settings		
Color	Status	Definition
Yellow	Flashing	Active

LAN2 Link Indicator LED Settings	
LED Color	Definition
Off	No Connection
Amber	5Gbps/2.5Gbps/ 1Gbps/100Mbps
Green	10 Gbps

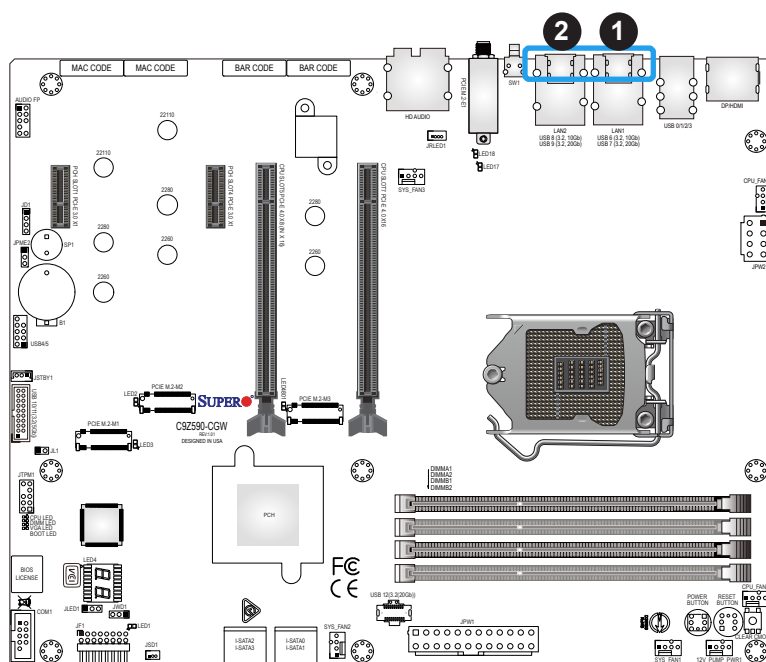

1. LAN1 LEDs
2. LAN2 LEDs

M.2 LED

Three M.2 LEDs are provided and indicated the status of connected M.2 devices. When an M.2 LED is blinking, the corresponding M.2 device is functioning normally. These LEDs are located nearby the corresponding M.2 sockets. Refer to the table below for the status information.

M.2 LED State	
LED Color	Definition
Green: On	Device detected
Green: Blinking	Device Working

BIOS POST Code LED

LED4 is made up of two alpha-numeric displays that will display a status or BIOS POST code, when the motherboard is powered on. For more information, refer to https://www.supermicro.com/manuals/other/AMI_AptioV_BIOS_POST_Codes_for_SM_Motherboards.pdf.

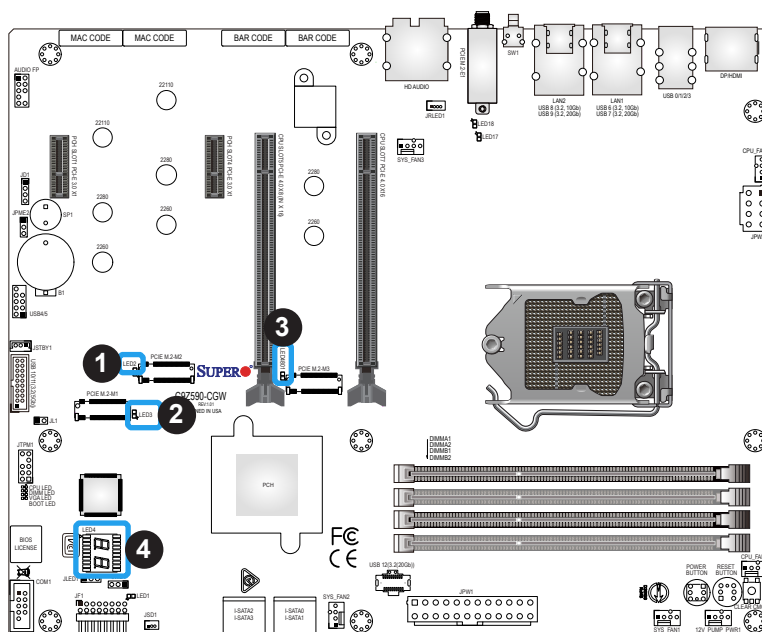
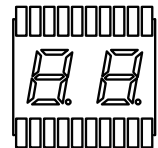

1. LED2 (PCIe M.2-M2)
2. LED3 (PCIe M.2-M1)
3. LED4801 (PCIe M.2-M3)
4. BIOS POST Code LED

Power LED

An Onboard Power LED is located at LED1 on the motherboard. When LED1 is on, the AC power cable is connected. Make sure to disconnect the power cable before removing or installing any component. Refer to the tables below for more information.

Power LED Indicator LED Status	
Status	Definition
Off	System Off
On	System on, or System off, and PWR Cable Connected

Power-On Self-Test (POST) LEDs

Multiple LEDs are built-in and used to display the status of system Power-On Self-Test (POST). These LEDs are located next to the JTPM1 header on the motherboard. Refer to the tables below for more information.

CPU LED State	
LED Color	Definition
Yellow	CPU POST Working
Off	CPU POST Completed

DIMM LED State	
LED Color	Definition
Blue	DIMM POST Working
Off	DIMM POST Completed

VGA LED State	
LED Color	Definition
Green	VGA POST Working
Off	VGA POST Completed

BOOT LED State	
LED Color	Definition
Orange	BOOT POST Working
Off	BOOT POST Completed

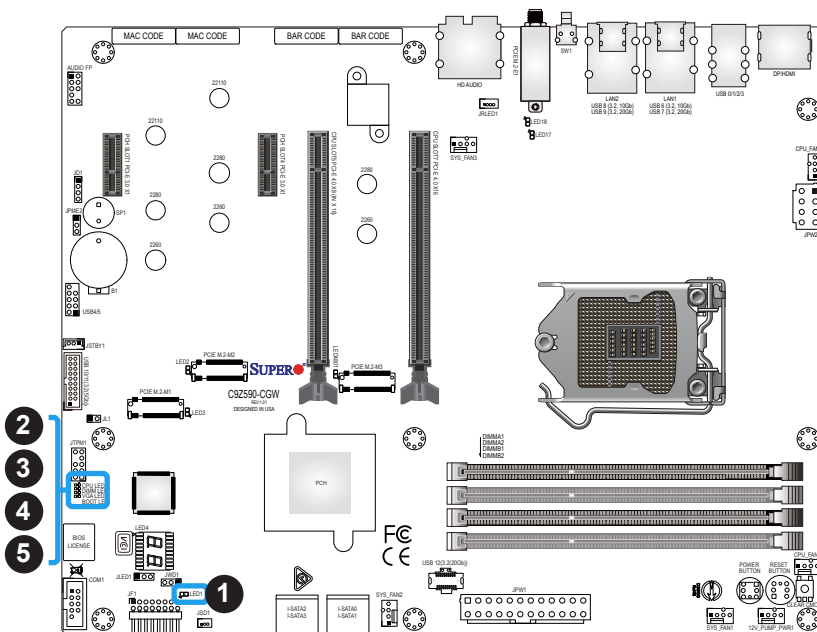

1. Power LED
2. CPU LED
3. DIMM LED
4. VGA LED
5. BOOT LED

Chapter 3

Troubleshooting

3.1 Troubleshooting Procedures

Use the following procedures to troubleshoot your system. If you have followed all of the procedures below and still need assistance, refer to the 'Technical Support Procedures' and/or 'Returning Merchandise for Service' section(s) in this chapter. Always disconnect the AC power cord before adding, changing or installing any non hot-swap hardware components.

Before Power On

1. Make sure that there are no short circuits between the motherboard and chassis.
2. Disconnect all ribbon/wire cables from the motherboard, including those for the keyboard and mouse.
3. Remove all add-on cards.
4. Install the CPU (making sure it is fully seated) and connect the front panel connectors to the motherboard.

No Power

1. Make sure that there are no short circuits between the motherboard and the chassis.
2. Make sure that the ATX power connectors are properly connected.
3. Check that the 115V/230V switch, if available.
4. Turn the power switch on and off to test the system, if applicable.
5. The battery on your motherboard may be old. Check to verify that it still supplies approximately 3VDC. If it does not, replace it with a new one.

No Video

1. If the power is on, but you have no video, remove all add-on cards and cables.
2. Use the speaker to determine if any beep codes are present. Refer to Appendix A for details on beep codes.
3. Remove all memory modules and turn on the system (if the alarm is on, check the specs of memory modules, reset the memory or try a different one).

System Boot Failure

If the system does not display Power-On-Self-Test (POST) or does not respond after the power is turned on, check the following:

1. Check for any error beep from the motherboard speaker.
 - If there is no error beep, try to turn on the system without DIMM modules installed. If there is still no error beep, replace the motherboard.
 - If there are error beeps, clear the CMOS settings by unplugging the power cord and pressing either the SW1 button or Clear CMOS button on the motherboard. Refer to Section Clear CMOS Button in Chapter 2.
2. Remove all components from the motherboard, especially the DIMM modules. Make sure that system power is on and that memory error beeps are activated.
3. Turn on the system with only one DIMM module installed. If the system boots, check for bad DIMM modules or slots by following the Memory Errors Troubleshooting procedure in this chapter.

Memory Errors

When a no-memory beep code is issued by the system, check the following:

1. Make sure that the memory modules are compatible with the system and are properly installed. Refer to Chapter 2 for installation instructions. (For memory compatibility, refer to the "Tested Memory List" link on the motherboard's product website page to see a list of supported memory.)
2. Check if different speeds of DIMMs have been installed. It is strongly recommended that you use the same memory type and speed for all DIMMs in the system.
3. Make sure that you are using the correct type of non-ECC UDIMM DDR4 modules recommended by the manufacturer.
4. Check for bad DIMM modules or slots by swapping a single module among all memory slots and check the results.

Losing the System's Setup Configuration

1. Make sure that you are using a high-quality power supply. A poor-quality power supply may cause the system to lose the CMOS setup information. Refer to Section 1.6 Power Supply for details on recommended power supplies.
2. The battery on your motherboard may be old. Check to verify that it still supplies approximately 3VDC. If it does not, replace it with a new one.
3. If the above steps do not fix the setup configuration problem, contact your vendor for repairs.

When the System Becomes Unstable

A. If the system becomes unstable during or after OS installation, check the following:

1. CPU/BIOS support: Make sure that your CPU is supported and that you have the latest BIOS installed in your system.
2. Memory support: Make sure that the memory modules are supported by testing the modules using memtest86 or a similar utility.



Note: Click on the "Tested Memory List" link on the motherboard's product website page to see a list of supported memory.

3. HDD support: Make sure that all hard disk drives (HDDs) work properly. Replace the bad HDDs with good ones.
4. System cooling: Check the system cooling to make sure that all heatsink fans and CPU/system fans, etc., work properly. Also check the front panel Overheat LED and make sure that it is not on.
5. Adequate power supply: Make sure that the power supply provides adequate power to the system. Make sure that all power connectors are connected. Please refer to our website for more information on the minimum power requirements.
6. Proper software support: Make sure that the correct drivers are used.

B. If the system becomes unstable before or during OS installation, check the following:

1. Source of installation: Make sure that the devices used for installation are working properly, including boot devices such as CD/DVD.
2. Cable connection: Check to make sure that all cables are connected and working properly.
3. Use the minimum configuration for troubleshooting: Remove all unnecessary components (starting with add-on cards first), and use the minimum configuration (but with the CPU and a memory module installed) to identify the trouble areas. Refer to the steps listed in Section A above for proper troubleshooting procedures.

4. Identify bad components by isolating them: If necessary, remove a component in question from the chassis, and test it in isolation to make sure that it works properly. Replace a bad component with a good one.
5. Check and change one component at a time instead of changing several items at the same time. This will help isolate and identify the problem.
6. To find out if a component is good, swap this component with a new one to see if the system will work properly. If so, then the old component is bad. You can also install the component in question in another system. If the new system works, the component is good and the old system has problems.

3.2 Technical Support Procedures

Before contacting Technical Support, please take the following steps. Also, please note that as a motherboard manufacturer, Supermicro also sells motherboards through its channels, so it is best to first check with your distributor or reseller for troubleshooting services. They should know of any possible problems with the specific system configuration that was sold to you.

1. Please go through the Troubleshooting Procedures and Frequently Asked Questions (FAQ) sections in this chapter or see the FAQs on our website (<http://www.supermicro.com/FAQ/index.php>) before contacting Technical Support.
2. BIOS upgrades can be downloaded from our website (http://www.supermicro.com/ResourceApps/BIOS_IPMI_Intel.html).
3. If you still cannot resolve the problem, include the following information when contacting Supermicro for technical support:
 - Motherboard model and PCB revision number
 - BIOS release date/version (This can be seen on the initial display when your system first boots up.)
 - System configuration
4. An example of a Technical Support form is on our website at <http://www.supermicro.com/RmaForm/>.
5. Distributors: For immediate assistance, please have your account number ready when placing a call to our Technical Support department. We can be reached by email at support@supermicro.com.

3.3 Frequently Asked Questions

Question: What type of memory does my motherboard support?

Answer: The motherboard supports non ECC UDIMM modules. To enhance memory performance, do not mix memory modules of different speeds and sizes. Please follow all memory installation instructions given in Section 2.4.

Question: How do I update my BIOS under UEFI Shell?

Answer: It is recommended that you do not upgrade your BIOS if you are not experiencing any problems with your system. Updated BIOS files are located on our website at http://www.supermicro.com/ResourceApps/BIOS_IPMI_Intel.html. Please check our BIOS warning message and the information on how to update your BIOS on our website. Select your motherboard model and download the BIOS file to your computer. Also, check the current BIOS revision to make sure that it is newer than your BIOS before downloading. To update your BIOS under the UEFI shell, please unzip the BIOS file onto a USB device formatted with the FAT/FAT32 file system. When the UEFI shell prompt appears, type `fs#` to change the device directory path. Go to the directory that contains the BIOS package you extracted earlier. Enter `flash.nsh BIOSname#.###` at the prompt to start the BIOS update process. Reboot the system when you see the message that BIOS update has completed. Refer to Appendix D UEFI BIOS Recovery and/or the readme file for more information.

Warning: Do not shut down or reset the system while updating the BIOS to prevent possible system boot failure!



Note: The SPI BIOS chip used on this motherboard cannot be removed. Send your motherboard back to our RMA Department at Supermicro for repair. For BIOS Recovery instructions, please refer to the AMI BIOS Recovery Instructions posted at <http://www.supermicro.com/support/manuals/>.

3.4 Battery Removal and Installation

Battery Removal

To remove the onboard battery, follow the steps below:

1. Power off your system and unplug your power cable.
2. Locate the onboard battery as shown below.
3. Using a tool such as a pen or a small screwdriver, push the battery lock outwards to unlock it. Once unlocked, the battery will pop out from the holder.
4. Remove the battery.

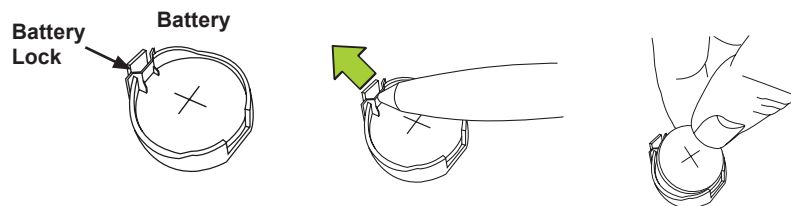

Proper Battery Disposal

Warning: Please handle used batteries carefully. Do not damage the battery in any way; a damaged battery may release hazardous materials into the environment. Do not discard a used battery in the garbage or a public landfill. Please comply with the regulations set up by your local hazardous waste management agency to dispose of your used battery properly.

Battery Installation

1. To install an onboard battery, follow steps 1 and 2 above and continue below:
2. Identify the battery's polarity. The positive (+) side should be facing up.
3. Insert the battery into the battery holder and push it down until you hear a click to ensure that the battery is securely locked.

Warning: When replacing a battery, be sure to only replace it with the same type.

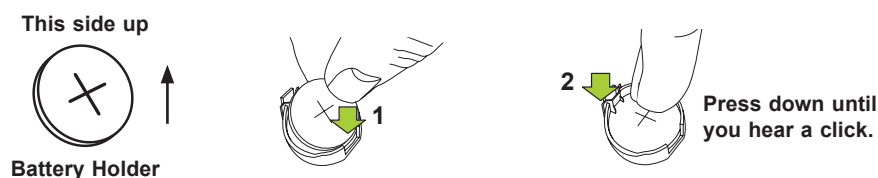

3.5 Returning Merchandise for Service

A receipt or copy of your invoice marked with the date of purchase is required before any warranty service will be rendered. You can obtain service by calling your vendor for a Returned Merchandise Authorization (RMA) number. When returning the motherboard to the manufacturer, the RMA number should be prominently displayed on the outside of the shipping carton, and the shipping package is mailed prepaid or hand-carried. Shipping and handling charges will be applied for all orders that must be mailed when service is complete. For faster service, you can also request a RMA authorization online (<http://www.supermicro.com/RmaForm/>).

This warranty only covers normal consumer use and does not cover damages incurred in shipping or from failure due to the alternation, misuse, abuse or improper maintenance of products.

During the warranty period, contact your distributor first for any product problems.

Chapter 4

UEFI BIOS

4.1 Introduction

This chapter describes the AMIBIOS™ Setup utility for the motherboard. The BIOS is stored on a chip and can be easily upgraded using a flash program.

 **Notes:** 1. Due to periodic changes to the BIOS, some settings may have been added or deleted and might not yet be recorded in this manual. Please refer to the Manual Download area of our website for any changes to the BIOS that may not be reflected in this manual. 2. This motherboard supports only UEFI mode.

Starting the Setup Utility

To enter the BIOS Setup Utility, hit the <Delete> key while the system is booting up. (In most cases, the <Delete> key is used to invoke the BIOS setup screen. There are a few cases when other keys are used, such as <F1>, <F2>, etc.) Each main BIOS menu option is described in this manual.

Each BIOS menu option is described in this manual. The Advanced Mode BIOS Setup screen has two main areas. The top area (1) is the main Navigation, and the bottom (2) area is for the Information Section. Icons that do not respond when the mouse pointer is hovering on top are not configurable.

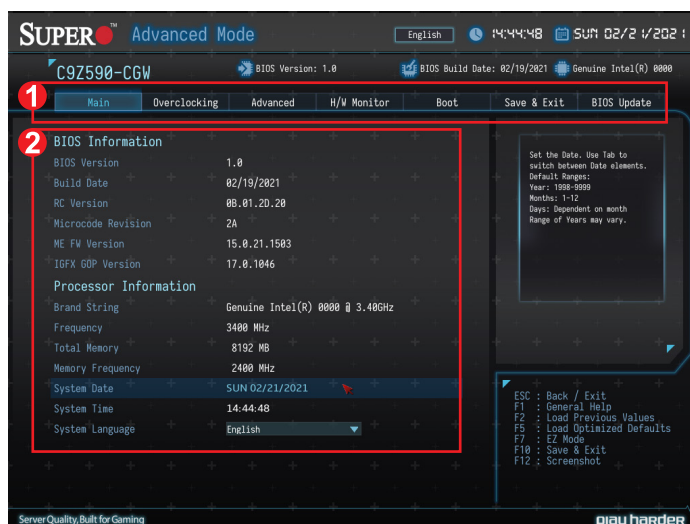

The AMI BIOS GUI Setup Utility uses a mouse pointer navigation system similar to standard graphical user interfaces. Hover and click an icon to select a section, click a down arrow to select from an options list.

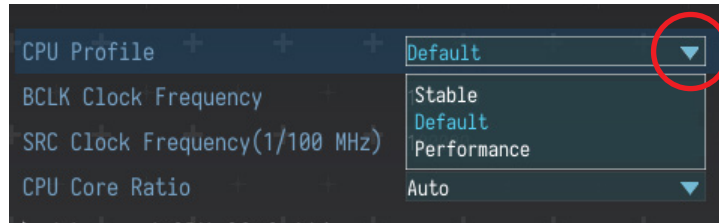

You may press the <F1> on any screen under the Setup Section to see a list of Hot Keys that are available. Press <F12> to print the screen.

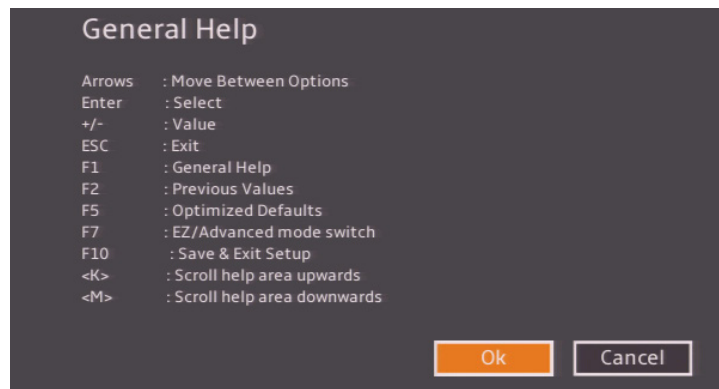

The keyboard's Escape key <ESC> cancels the current screen and will return you back to the previous screen.

 **Note:** For AMI BIOS Recovery, please refer to the UEFI BIOS Recovery Instructions in Appendix D.

Changing Between EZ Mode and Advanced Mode

To change between EZ Mode and Advanced Mode, hit F7 on the keyboard. When in EZ Mode (refer to Section 4.2), select feature options and an overview of hardware status are displayed. When in Advanced Mode (from Section 4.3 to 4.9), all following configuration menus and their contents become available.

4.2 EZ Mode

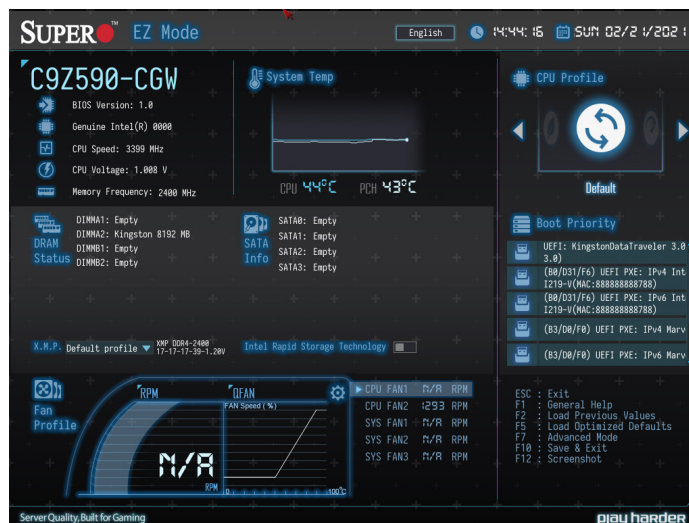

While in EZ Mode, the following information will be displayed:

- **BIOS Version** - The current BIOS version.
- **CPU Information** - The model, speed, and voltage of installed CPU.
- **Memory Frequency** - The frequency of installed memory.
- **System Temp** - Displays CPU and PCH temperatures.
- **CPU Profile** - Allows changing of the CPU profile by clicking the left or right arrows.
- **DRAM Status** - Status of all DIMM slots.
- **SATA Info** - Displays which SATA ports are connected to storage devices.
- **Boot Priority** - Allows changing of the boot order.
- **X.M.P.** - Allows changing the X.M.P. profile.
- **Intel Rapid Storage Technology** - Allows for enabling Intel Rapid Storage Technology.
- **Fan Profile** - Displays current fan speeds, or click the SMC QFAN Setting (⚙️) using the mouse cursor for more advanced adjustments.

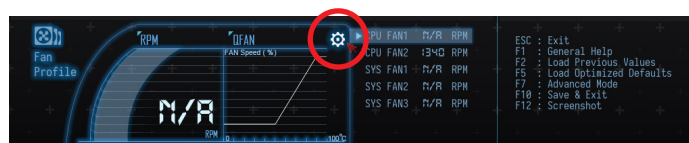

SMC QFan Setting





 **Note:** The SMC QFAN Setting page has a user friendly graphical interface. You can also configure these features in the section of H/W Monitor > Fan Control in the Advanced mode.

1. Select and click the fan connector that you want to adjust.
2. Use this feature to select System Fan Control Mode. The options are Auto, **PWM Mode** (Pulse Width Modulation Mode), and DC Mode.
3. Use this feature to select Fan Speed Control Mode. The CPU temperature and the fan speed are correlative. When the CPU on-die temperature increases, the fan speed will also increase for effective system cooling. Select "Full Speed" to allow the onboard fans to run at full speed (of 100% Pulse Width Modulation Duty Cycle) for maximum cooling. This setting is recommended for special system configuration or debugging. Select "Stable" for the onboard fans to run at 50% of the Initial PWM Cycle in order to balance the needs between system cooling and power saving. This setting is recommended for regular systems with normal hardware configurations. Select "Quiet" to optimize for minimal fan noise and Custom to enter user-specific settings. The options are **Quiet**, Stable, Full Speed, and Customize.

Customizing Fan Speed

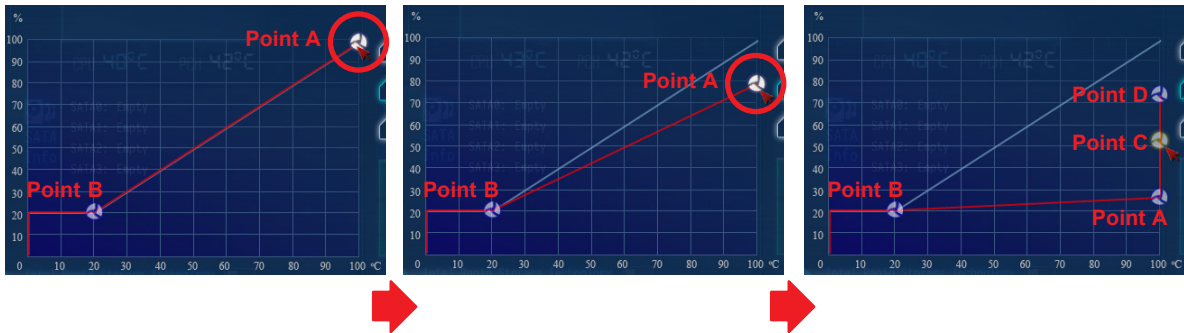
When you set the Fan Speed Control Mode to Customize, adjust the control points by clicking and dragging the mouse. By default, there are two control points, and can be up to four control points. To add extra control points, drag the control point A to lower than temperature 100, then move the point A to release the point C and D by pressing and dragging the mouse left button. Adjust these control points to the locations you prefer, or you may click Undo button to return to the previous step. Once the configuration above has been completed, follow the step 4 to save and apply the settings



 **Note:** You may refer to the temperatures in the bottom right corner of the setting page as references when adjusting the control points. T1 presents the temperature 1, and P1 is PWM1. These items are the same as the features in the section of Fan Control in the Advanced mode.

4. Click Apply for the changes to take effect or click Exit to return to the EZ Mode page.

4.3 Main

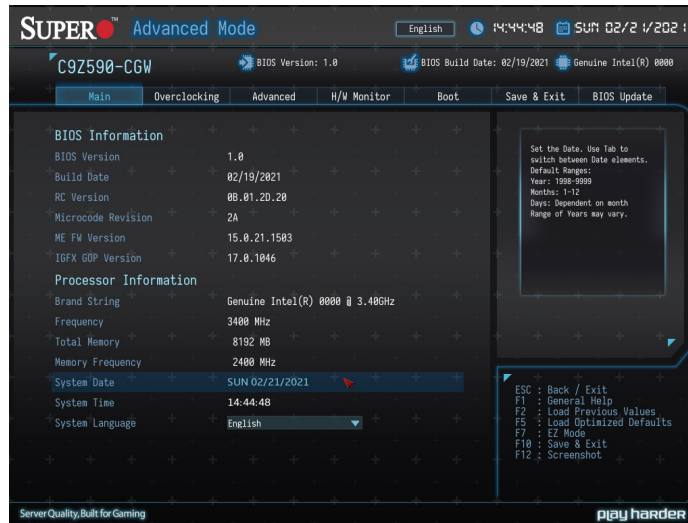

BIOS Information

The following items will be displayed:

BIOS Version - This feature displays the version of the BIOS ROM used in the system.

Build Date - This feature displays the date of when the BIOS ROM version used in the system was built.

RC Version - This feature displays the memory RC version.

Microcode Revision - This feature displays the CPU's microcode patch version.

ME FW Version - This feature displays the ME Firmware Version.

IGFX GOP Version - This feature displays the Integrated Graphics GOP version.

 **Note:** Invisible if the installed CPU doesn't support graphic function.

Processor Information

The following items will be displayed:

Brand String - This feature displays the brand, model name, model number of the CPU, and its rated clock speed.

Frequency - This feature displays the detected CPU speed.

Total Memory - This feature displays the total size of memory available in the system.

Memory Frequency - This feature displays the detected memory speed.

System Date/System Time

Use this feature to change the system date and time. Highlight **System Date** or **System Time** using the arrow keys. Enter new values using the keyboard. Press the <Tab> key or the arrow keys to move between fields. The date must be entered in MM/DD/YYYY format. The time is entered in HH:MM:SS format.



Note: The time is in the 24-hour format. For example, 5:30 P.M. appears as 17:30:00.
The date's default value is the BIOS build date after RTC reset.

System Language

Use this feature to set the system language. The options are **English**, 中文(繁體), 中文(简体), 日本語, and 한국어.

4.4 Overclocking



CPU Profile

This feature allows for preset CPU overclocking profiles to be selected. The options are Stable, **Default**, and Performance.

BCLK Clock Frequency

Enter a value to set the SRC Clock frequency. The default is **100.000**.

CPU Core Ratio

This feature determines the core ratio of CPU. The options are **Auto**, Sync All Cores, and Per Core.

****If the feature of CPU Core Ratio is set to Sync All Cores, the following feature will become available for configuration:***

Turbo Ratio Limit Ratio0 (TRLR)

Enter a value to apply for all cores. The default is **50**.

****If the feature of CPU Core Ratio is set to Per Core, the following feature will become available for configuration:***

Turbo Ratio Limit Ratio0~X (TRLR)

Set a value for each core individually. The default is **50**.



Note: The number of X is depending on the CPU installed on the motherboard.

► Advanced CPU OC Setting

Processor

BCLK Aware Adaptive Voltage

This feature enables BCLK Aware Adaptive Voltage, which helps avoid high voltage overrides by forcing pcode to be aware of the BCLK frequency when making calculations. The options are Disabled and **Enabled**.

Core Max OC Ratio

This feature controls the general maximum overclocking ratio for the CPU cores and Ring. The default is **50**.

AVX

This feature enables the AVX 2/3 Instructions. This is applicable for big core only. The options are **Enabled** and Disabled.

****If this feature above is set to Enabled, the following feature will become available for configuration:***

AVX2 Ratio Offset

Enter a numeric value for AVX Ratio Offset. The default is 0.

AVX3

This feature enables the AVX 3 Instructions. This is applicable for big core only. The options are **Enabled** and Disabled.

****If this feature above is set to Enabled, the following feature will become available for configuration:***

AVX512 Ratio Offset

Enter a numeric value for AVX512 Ratio Offset. The default is 0.

TjMax Offset

Enter a numeric value to change the Tj-Max value. The default is **0**.

CPU Flex Ratio Override

Select Enabled to activate CPU Flex Ratio programming. The flex ratio should be under the CPU's max ratio. The options are **Disabled** and Enabled.

****If this feature above is set to Enabled, the following features will become available for configuration:***

CPU Flex Ratio Settings

The value must be between the maximum efficiency ratio and maximum non-turbo ratio. The default value is dependent on the CPU.

Unlimited ICCMAX

This feature enables the unlimited ICCMAX. The options are **Disabled** and Enabled.

Power Limit 1 Override

This feature disables or enables the Power Limit 1 Override. If this option is disabled, the BIOS will program the default values for Power Limit 1 and Power Limit 1 Time Window. The options are **Disabled** and Enabled.

****If this feature above is set to Enabled, the following features will become available for configuration:***

Power Limit 1

This feature configures the Power Limit 1 in milliwatts. When the limit is exceeded, the CPU ratio is lowered after a period of time (see item below). A lower limit can save power and protect the CPU, while a higher limit improves performance. This value must be between Min Power Limit TDP limit. If value is 0, the BIOS will program the TDP value. Use the number keys on your keyboard to enter the value.

Power Limit 1 Time Window

This feature determines how long the time window over which the TDP value is maintained. The default setting is **8**. This value may vary between 0~128.

Power Limit 2 Override

This feature disables or enables the Power Limit 2 Override. If this option is disabled, the BIOS will program the default values for Power Limit 2. The options are **Disabled** and **Enabled**.

****If this feature above is set to Enabled, the following feature will become available for configuration:***

Power Limit 2

This feature configures the Power Limit 2 in milliwatts. If the value is 0, the BIOS will set PL2 as 1.25* TDP. Use the number keys on your keyboard to enter the value.

Thermal Voltage Boost (TVB)

TVB Ratio Clipping

This feature controls the core frequency reduction caused by high package temperature for the processor that implements the Intel Thermal Velocity Boost (TVB). It is required to be disabled for supporting overclocking. The options are **Disabled** and Enabled.

TVB Voltage Optimizations

This feature enables thermal base voltage optimizations for processor that implements the Intel Thermal Velocity Boost (TVB). The options are **Disabled** and Enabled.

► CPU feature

CPU Feature

Hyper-Threading

This feature enables hyper-threading, which is a software method to control logical processor threads. The options are Disabled and **Enabled**.

Pre-core HT Disable

Defines the per-core HT disable. Use the number keys on your keyboard to enter the value. The default setting is **0**.

Boot Performance Mode

This feature controls the performance state that the BIOS will set initially. The options are Max Battery, **Max Non-Turbo Performance**, and Turbo Performance.

Race To Halt (RTH)

This feature enables Race To Halt, which dynamically increases CPU frequency in order to enter package C-State faster. This will reduce overall power consumption. The options are **Disabled** and Enabled.

Intel(R) Speed Shift Technology

This feature enables Intel Speed Shift, which allows the operating system to hand control of CPU frequency and voltage to the processor. This increases P-state change speed and improves power efficiency. The options are Disabled and **Enabled**.

Intel(R) Turbo Boost Max Technology 3.0

This feature enables Intel Turbo Boost Max Technology 3.0 support. The options are Disabled and **Enabled**.

C States

C-State architecture, a processor power management platform developed by Intel, can further reduce power consumption from the basic C1 (Halt State) state that blocks clock cycles to the CPU. Select Enabled for CPU C-State support. The options are Disabled and **Enabled**.

Thermal Monitor

This feature enables CPU thermal monitor. The options are Disabled and **Enabled**.

Energy Efficient Turbo

Select Enabled to activate Energy Efficient Turbo. This feature will opportunistically lower the turbo frequency to increase efficiency. We recommend to leave this enabled and disable only in overclocking situations where the turbo frequency must remain constant. The options are **Disabled**, Enabled, and Auto.

Turbo Mode

This feature enables Turbo Mode if EMTTM is also enabled. The options are Disabled and **Enabled**.

► Ring

Ring

Ring Max OC Ratio

Enter a numeric value for the maximum overclock ratio for CPU ring. The default is **Auto**.

Ring Voltage Mode

Use this feature to select the CPU ring voltage mode. In adaptive mode, the voltage is interpolated only in turbo mode. In override mode, the voltage selected will be applied over all operating frequencies. The options are **Adaptive** and Override.

****If the feature of Ring Voltage Mode is set to Adaptive, the following feature will become available for configuration:***

Ring Extra Turbo Voltage

Use this feature to specify the extra turbo voltage applied while ring is operating in turbo mode.

****If the feature of Ring Voltage Mode is set to Override, the following features will become available for configuration:***

Ring Voltage Override

Use this feature to specify the override voltage applied to the ring domain in millivolts.

VF Point Offset Mode

Use this feature to set VF Point Offset mode. In Legacy mode, sets a global offset for the entire VF curve. In Selection mode, sets a selected VF point. The options are **Legacy** and Selection.

**If the feature of VF Point Offset Mode is set to Legacy, the following features will become available for configuration:*

Ring Voltage Offset

Enter a value for the offset voltage (in mV) that will be applied to the ring domain.

Offset Prefix

Use this feature to set the prefix value as a positive (+) or a negative (-). The options are “+” and “-”.

**If the feature of VF Point Offset Mode is set to Selection, the following features will become available for configuration:*

VF Point 1 Offset / VF Point 2 Offset / VF Point 3 Offset / VF Point 4 Offset / VF Point 5 Offset / VF Point 6 Offset / VF Point 7 Offset / VF Point 8 Offset

Enter a value for the offset voltage (in mV) that will be applied to the Selected VF Point 1 (~8).

VF Point 1 Offset Prefix / VF Point 2 Offset Prefix / VF Point 3 Offset Prefix / VF Point 4 Offset Prefix / VF Point 5 Offset Prefix / VF Point 6 Offset Prefix / VF Point 7 Offset Prefix / VF Point 8 Offset Prefix

Use this feature to set the prefix value as a positive (+) or a negative (-). The options are “+” and “-”.

VF Point 1 Ratio / VF Point 2 Ratio / VF Point 3 Ratio / VF Point 4 Ratio / VF Point 5 Ratio / VF Point 6 Ratio / VF Point 7 Ratio / VF Point 8 Ratio

Ring Down Bin

This feature enables Ring Down Bin. If set to Enabled, the maximum ring ratio will not be observed. The options are Disabled and **Enabled**.

Min Ring Ratio Limit

Enter a numeric value for the minimum ratio limit for CPU Ring. The default is **Auto**.

Max Ring Ratio Limit

Enter a numeric value for the maximum ratio limit for CPU Ring. The default is **Auto**.

► CPU VR Settings

CPU VR Settings

VR Power Delivery Design

This feature is intended for motherboard validation purposes. The specifies the RKL-S board design for VR settings override values. The default is **Auto**.

PSYS Slope

Enter a numeric value for the PSYS Slope. The range is 0-200. The default is **0**.

PSYS Offset

Enter a numeric value for the PSYS Offset. The range is 0-255. The default is **0**.

PSYS Prefix

Use this feature to set the prefix value as a positive (+) or a negative (-). The options are “+” and “-”.

PSYS PMax Power

Enter a numeric value for the PSYS PMax Power. The range is 0-8192. The default is **0**.

Min Voltage Override

Use this feature to enable override minimum voltage for runtime and C8. The options are **Disabled** and Enabled.

► Acoustic Noise Settings

Acoustic Noise Settings

Acoustic Noise Mitigation

This feature enables Acoustic Noise Mitigation, which mitigates acoustic noise on certain CPUs when they are in deep C-states. The options are **Disabled** and Enabled.

****If this feature above is set to Enabled, the following features will become available for configuration:***

Pre Wake Time / Ramp Up Time / Ramp Down Time

Enter a numeric value for the desired feature. The range is 0-255. The default is **0**.

IA VR Domain / GT VR Domain / SA VR Domain

Disable Fast PKG C State Ramp for IA Domain

This feature disables fast package C-state ramping in a specific domain. If set to FALSE, the selected domain will continue to fast ramp. If set to True, the selected domain will disable fast ramping. The options are **False** and True.

Slow Slew Rate for IA Domain

This feature controls the slow slew rate for a specific domain. The options are **Fast/2**, **Fast/4**, **Fast/8**, and **Fast/16**.

► System Agent VR Settings

System Agent VR Domain

VR Config Enable

This feature enables VR Config. The options are Disabled and **Enabled**.

**If this feature above is set to Enabled, the following features will become available for configuration:*

Current AC Loadline

Current DC Loadline

Current PSi1 Threshold

Current PSi2 Threshold

Current PSi3 Threshold

Current Imon Slope

Current Imon Offset

Current VR current Limit

Current VR Voltage Limit

Current Tdc Current Limit

AC Loadline

Enter a numeric value for AC Loadline. The default is **0**.

DC Loadline

Enter a numeric value for DC Loadline. The default is **0**.

PS Current Threshold1

Enter a value for PS Current Threshold1. The range is 0-512. The default is **0**.

PS Current Threshold2

Enter a value for PS Current Threshold2. The range is 0-512. The default is **0**.

PS Current Threshold3

Enter a value for PS Current Threshold3. The range is 0-512. The default is **0**.

PS3 Enable

This feature enables PS3. The options are Disabled and **Enabled**.

PS4 Enable

This feature enables PS4. The options are Disabled and **Enabled**.

IMON Slope

Enter a value for IMON Slope. The range is 0-200. The default is **0**.

IMON Offset

Enter a value for IMON Offset. The range is 0-63999. The default is **0**.

IMON Prefix

Use this feature to set the prefix value as a positive (+) or a negative (-). The options are “+” and “-”.

VR Current Limit

Enter a value for the voltage regulator current limit, with each whole number equating to 1/4A (i.e., 400 = 100A). Enter 0 for Auto.

VR Voltage Limit

Enter a value (in mV) for the voltage regulator voltage limit. The range is 0-7999. Enter 0 for Auto.

TDC Enable

This feature enables TDC. The options are **Disabled** and **Enabled**.

TDC Current Limit

Enter a value for the TDC Current Limit, with each whole number equating to 1/8A (i.e., 1000 = 125A). The range is 0-32767. The default is **0**.

TDC Time Windows

This feature controls the TDC Time Window. The options are **1 ms**, 2 ms, 3 ms, 4 ms, 5 ms, 6 ms, 7 ms, 8 ms, and 10 ms.

TDC Lock

This feature enables TDC Lock. The options are **Disabled** and Enabled.

► Core/IA VR Settings

Core/IA VR VR Domain

VR Config Enable

This feature enables VR Config. The options are Disabled and **Enabled**.

****If this feature above is set to Enabled, the following features will become available for configuration:***

Current AC Loadline

Current DC Loadline

Current PSi1 Threshold

Current PSi2 Threshold

Current PSi3 Threshold

Current Imon Slope

Current Imon Offset

Current VR current Limit

Current VR Voltage Limit

Current Tdc Current Limit

AC Loadline

Enter a numeric value for AC Loadline. The default is **0**.

DC Loadline

Enter a numeric value for DC Loadline. The default is **0**.

PS Current Threshold1

Enter a value for PS Current Threshold1. The range is 0-512. The default is **0**.

PS Current Threshold2

Enter a value for PS Current Threshold2. The range is 0-512. The default is **0**.

PS Current Threshold3

Enter a value for PS Current Threshold3. The range is 0-512. The default is **0**.

PS3 Enable

This feature enables PS3. The options are Disabled and **Enabled**.

PS4 Enable

This feature enables PS4. The options are Disabled and **Enabled**.

IMON Slope

Enter a value for IMON Slope. The range is 0-200. The default is **0**.

IMON Offset

Enter a value for IMON Offset. The range is 0-63999. The default is **0**.

IMON Prefix

Use this feature to set the prefix value as a positive (+) or a negative (-). The options are “+” and “-”.

VR Current Limit

Enter a value for the voltage regulator current limit, with each whole number equating to 1/4A (i.e., 400 = 100A). Enter 0 for Auto.

VR Voltage Limit

Enter a value (in mV) for the voltage regulator voltage limit. The range is 0-7999. Enter 0 for Auto.

TDC Enable

This feature enables TDC. The options are Disabled and **Enabled**.

TDC Current Limit

Enter a value for the TDC Current Limit, with each whole number equating to 1/8A (i.e., 1000 = 125A). The range is 0-32767. The default is **0**.

TDC Time Windows

This feature controls the TDC Time Window. The default is **1 ms**.

TDC Lock

This feature enables TDC Lock. The options are **Disabled** and Enabled.

IRMS

This feature enables IRMS. The options are **Disabled** and **Enabled**.

►GT VR Settings

GT Domain

VR Config Enable

This feature enables VR Config. The options are **Disabled** and **Enabled**.

If this feature above is set to **Enabled, the following features will become available for configuration:*

Current AC Loadline

Current DC Loadline

Current PSi1 Threshold

Current PSi2 Threshold

Current PSi3 Threshold

Current Imon Slope

Current Imon Offset

Current VR current Limit

Current VR Voltage Limit

Current Tdc Current Limit

AC Loadline

Enter a numeric value for AC Loadline. The default is **0**.

DC Loadline

Enter a numeric value for DC Loadline. The default is **0**.

PS Current Threshold1

Enter a value for PS Current Threshold1. The range is 0-512. The default is **0**.

PS Current Threshold2

Enter a value for PS Current Threshold2. The range is 0-512. The default is **0**.

PS Current Threshold3

Enter a value for PS Current Threshold3. The range is 0-512. The default is **0**.

PS3 Enable

This feature enables PS3. The options are Disabled and **Enabled**.

PS4 Enable

This feature enables PS4. The options are Disabled and **Enabled**.

IMON Slope

Enter a value for IMON Slope. The range is 0-200. The default is **0**.

IMON Offset

Enter a value for IMON Offset. The range is 0-63999. The default is **0**.

IMON Prefix

Use this feature to set the prefix value as a positive (+) or a negative (-). The options are “+” and “-”.

VR Current Limit

Enter a value for the voltage regulator current limit, with each whole number equating to 1/4A (i.e., 400 = 100A). Enter 0 for Auto.

VR Voltage Limit

Enter a value (in mV) for the voltage regulator voltage limit. The range is 0-7999. Enter 0 for Auto.

TDC Enable

This feature enables TDC. The options are **Disabled** and Enabled.

TDC Current Limit

Enter a value for the TDC Current Limit, with each whole number equating to 1/8A (i.e., 1000 = 125A). The range is 0-32767. The default is **1056**.

TDC Time Windows

This feature controls the TDC Time Window. The options are **1 ms**, 2 ms, 3 ms, 4 ms, 5 ms, 6 ms, 7 ms, 8 ms, and 10 ms.

TDC Lock

This feature enables TDC Lock. The options are **Disabled** and Enabled.

► RFI Settings

RFI Domain

RFI Current Frequency

RFI Frequency

Use this feature to set a desired RFI frequency (in increments of 100KHz).

FIVR Spread Spectrum

This feature enables or disables the FIVR Spread Spectrum. The options are Disabled and **Enabled**.

****If this feature above is set to Enabled, the following feature will become available for configuration***

RFI Spread Spectrum

Use this feature to set the Spread Spectrum. The options are 0.5%, 1%, **1.5%**, 2%, 3%, 4%, 5%, and 6%.

► GT

GT Domain

GT OverClocking Frequency

Enter a value for the overclocked RP0 frequency (in multiples of 50 MHz) in the GT domain. The default is **0**.

GT Voltage Mode

This feature controls the voltage mode in the GT domain. The options are **Adaptive** and Override.

****If the feature of GT Voltage Mode is set to Adaptive, the following feature will become available for configuration:***

GT Extra Turbo Voltage

Enter a value for the extra turbo voltage (in mV) that will be applied while GT is operating in turbo mode. The default is **0**.

**If the feature of GT Voltage Mode is set to Override, the following features will become available for configuration:*

GT Voltage Override

Use this feature to specify the override voltage applied to the GT domain in millivolts.

GT Voltage Offset

Enter a value for the offset voltage (in mV) that will be applied to the GT domain. The default is **0**.

Offset Prefix

Use this feature to set the prefix value as a positive (+) or a negative (-). The options are “+” and “-”.

Memory Profile

This feature controls the memory profile. The options are **Default profile**, Custom profile, XMP profile 1, and XMP profile 2.

**If the feature of Memory Profile is set to Custom profile, the following memory configurations become available:*

Memory Reference Clock

This feature controls the memory reference clock, in MHz. The options are **133** and 100.

Memory Frequency

Use this feature to set the frequency of the memory installed. The options are **Auto**, DDR4-533MHz, DDR4-800MHz, DDR4-1067MHz, DDR4-1333MHz, DDR4-1600MHz, DDR4-1867MHz, DDR4-2133MHz, DDR4-2400MHz, DDR4-2667MHz, DDR4-2933MHz, DDR4-3200MHz, DDR4-3467MHz, DDR4-3733MHz, DDR4-4000Hz, DDR4-4267MHz, DDR4-4533MHz, DDR4-4800MHz, DDR4-5067MHz, DDR4-5333MHz, DDR4-5600MHz, DDR4-5867MHz, DDR4-6133MHz, DDR4-6400MHz, DDR4-6667MHz, DDR4-6933MHz, DDR4-7200MHz, DDR4-7467MHz, DDR4-7733MHz, DDR4-8000MHz, and DDR4-8267MHz.

► Advanced Memory OC Setting

**The features below are available when the Memory Profile is set to Custom profile.*

Realtime Memory Timing

This feature enables Realtime Memory Timing changes to be made after MRC_DONE. The options are **Disabled** and Enabled.

tCL

This feature configures the Cas Latency Range. Enter a numeric value between 0-31. The default is **17**.

tRCD/tRP

This feature configures the RAS to CAS delay time. Enter a numeric value between 1-63. The default is **17**.

tRAS

This feature configures the Ras Active Time. Enter a numeric value between 1-64. The default is **39**.

tCWL

This feature configures the Minimum CAS Write Latency Time. Enter a numeric value between 1-20. The default is **Auto**.

tFAW

This feature configures the Minimum Four Activate Window Delay Time. Enter a numeric value between 0-63. The default is **Auto**.

tREFI

This feature configures the Maximum tREFI Time (Average Periodic Refrech Interval). Enter a numeric value between 0-65535. The default is **Auto**.

tRFC

This feature configures the Minimum Refrech Recovery Delay Time. Enter a numeric value between 0-1023. The default is **Auto**.

tRRD

This feature configures the Minimum Row Active to Row Active Delay Time. Enter a numeric value between 0-31. The default is **Auto**.

tRTP

This feature configures the Minimum Internal Read to Precharge Command Delay Time. The default is **Auto**.

tCCD_L

Enter a numeric value for desired tCCD_L. The default is **Auto**.

tWR

This feature configures the Minimum Write Recovery Time. The default is **18**.

tWTR

This feature configures the Minimum Internal Write to Read Command Delay Time. Enter a numeric value between 0-28. The default is **Auto**.

NMode

This feature configures the System Command Rate. Enter a numeric value between 0-2. The default is **Auto**.

tRRD_sg**tRRD_dg****tRDRD_sg****tRDRD_dg****tRDRD_dr****tRDRD_dd****tRDWR_sg****tRDWR_dg****tRDWR_dr****tRDWR_dd****tWRRD_sg****tWRRD_dg****tWRRD_dr****tWRRD_dd****tWRWR_sg****tWRWR_dg****tWRWR_dr****tWRWR_dd****tCKE****ODT RTT WR****ODT RTT PARK****ODT RTT NOM****RTL R2**

IOL R2

SCompDq StageDelayPS

SCompCmd StageDelayPS

SCompCtl StageDelayPS

SCompClk StageDealyPS

RcompTarget[RdOdt]

RcompTarget[WrDS]

RcompTarget[WrDSCmd]

RcompTarget[WrDSCtl]

RcompTarget[WrDSClk]

Load line Calibration

This feature controls the load line calibration. The options are Disabled, Level 1, Level 2, Level 3, Level 4, Level 5, Level 6, Level 7, and **Auto**.

Core Voltage Mode

This feature controls the core voltage mode. The options are **Adaptive** and Override.

****If the feature of Core Voltage Mode is set to Adaptive, the following feature will become available for configuration:***

Core Extra Turbo Voltage

Enter a numeric value for the extra turbo voltage (in mV) that will be applied while IA Core is operating in turbo mode. The default is **Auto**.

****If the feature of Core Voltage Mode is set to Override, the following features will become available for configuration:***

SVID

Use this feature to enable or disable the SVID. The options are Disabled and **Enabled**.

Core Voltage Override

Use this feature to specify the override voltage applied to the IA Core domain in millivolts. The default is **Auto**.

VF Point Offset Mode

Use this feature to set VF Point Offset mode. In Legacy mode, sets a global offset for the entire VF curve. In Selection mode, sets a selected VF point. The options are **Legacy** and Selection.

****If the feature of VF Point Offset Mode is set to Legacy, the following feature will become available for configuration:***

VF Configuration Scope

Use this feature to configure the VF curve. The options are **All-core** and **Pre-core**.

****If the feature of VF Configuration Scope is set to All-core, the following features will become available for configuration:***

Core Voltage Offset

Enter a value for the offset voltage (in mV) that will be applied to Global IA Core 0 domain.

Offset Prefix

Use this feature to set the prefix value as a positive (+) or a negative (-). The options are “+” and “-”.

****If the feature of VF Configuration Scope is set to Pre-core, the following features will become available for configuration:***

Core 0 Voltage Offset / Core 1 Voltage Offset / Core 2 Voltage Offset / Core 3 Voltage Offset / Core 4 Voltage Offset / Core 5 Voltage Offset / Core 6 Voltage Offset / Core 7 Voltage Offset

Enter a value for the offset voltage (in mV) that will be applied to the IA Core 0 (~8) domain.

Offset Prefix

Use this feature to set the prefix value as a positive (+) or a negative (-). The options are “+” and “-”.

****If the feature of VF Point Offset Mode is set to Selection, the following features will become available for configuration:***

VF Point 1 Offset / VF Point 2 Offset / VF Point 3 Offset / VF Point 4 Offset / VF Point 5 Offset / VF Point 6 Offset / VF Point 7 Offset / VF Point 8 Offset

Enter a value for the offset voltage (in mV) that will be applied to the Selected VF Point 1 (~8).

VF Point 1 Offset Prefix / VF Point 2 Offset Prefix / VF Point 3 Offset Prefix / VF Point 4 Offset Prefix / VF Point 5 Offset Prefix / VF Point 6 Offset Prefix / VF Point 7 Offset Prefix / VF Point 8 Offset Prefix

Use this feature to set the prefix value as a positive (+) or a negative (-). The options are “+” and “-”.

VF Point 1 Ratio / VF Point 2 Ratio / VF Point 3 Ratio / VF Point 4 Ratio / VF Point 5 Ratio / VF Point 6 Ratio / VF Point 7 Ratio / VF Point 8 Ratio

Memory Voltage

Enter a numeric value for the memory voltage override. The default is **Auto**.

CPU_IO Voltage

Enter a numeric value for the CPU IO voltage override. The default is **Auto**.

▶ Advanced Voltage OC Setting

Voltage Configuration

VPP Voltage

VCC PLL OC

VCC DMI Voltage

Vcc_ST1

Vcc_ST2

Vcc_PLL

Enter a desired numeric value above for each feature. The default of these features is **Auto**.

▶ GT

GT Domain

GT OverClocking Frequency

Enter a value for the overclocked RP0 frequency (in multiples of 50 MHz) in the GT domain. The default is **0**.

GT Voltage Mode

This feature controls the voltage mode in the GT domain. The options are **Adaptive** and **Override**.

****If the feature of GT Voltage Mode is set to Adaptive, the following feature will become available for configuration:***

GT Extra Turbo Voltage

Enter a value for the extra turbo voltage (in mV) that will be applied while GT is operating in turbo mode. The default is **0**.

****If the feature of GT Voltage Mode is set to Override, the following feature will become available for configuration:***

GT Voltage Override

Use this feature to specify the override voltage applied to the GT domain (in mV). The default is **0**.

GT Voltage Offset

Enter a value for the offset voltage (in mV) that will be applied to the GT domain. The default is **0**.

Offset Prefix

Use this feature to set the prefix value as a positive (+) or a negative (-). The options are “+” and “-”.

► Uncore

Uncore

Uncore Voltage Mode

Use this feature to select the Uncore voltage mode. In adaptive mode, the voltage is interpolated only in turbo mode. In override mode, the voltage selected will be applied over all operating frequencies. The options are **Adaptive** and **Override**.

****If the feature of Uncore Voltage Mode is set to Adaptive, the following feature will become available for configuration:***

GT Extra Turbo Voltage

Enter a value for the extra turbo voltage (in mV) that will be applied while GT is operating in turbo mode. The default is **0**.

****If the feature of Uncore Voltage Mode is set to Override, the following feature will become available for configuration:***

GT Voltage Override

Use this feature to specify the override voltage applied to the SA Uncore domain (in mV). The default is **Auto**.

Uncore Voltage Offset

Enter a value for the offset voltage (in mV) that will be applied to the Uncore domain. The default is **Auto**.

Offset Prefix

Use this feature to set the prefix value as a positive (+) or a negative (-). The options are “+” and “-”.

▶ Voltage PLL Trim Controls

Voltage PLL Trim Controls

Core PLL Voltage Offset

GT PLL Voltage Offset

Ring PLL Voltage Offset

System Agent PLL Voltage Offset

Memory Controller PLL Voltage Offset

Enter a desired numeric value above for each feature. The range is 0-63 and the default is **0**.

4.5 Advanced

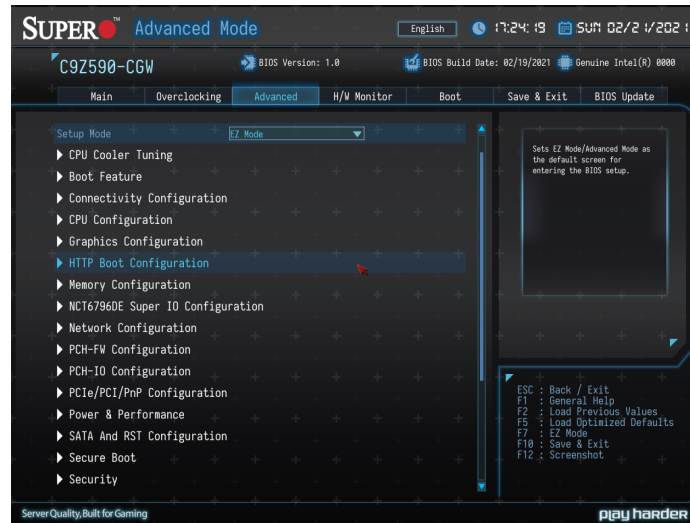

Setup Mode

This feature sets the default mode to start in after entering BIOS. The options are **EZ Mode** and **Advanced Mode**.

► CPU Cooler Tuning

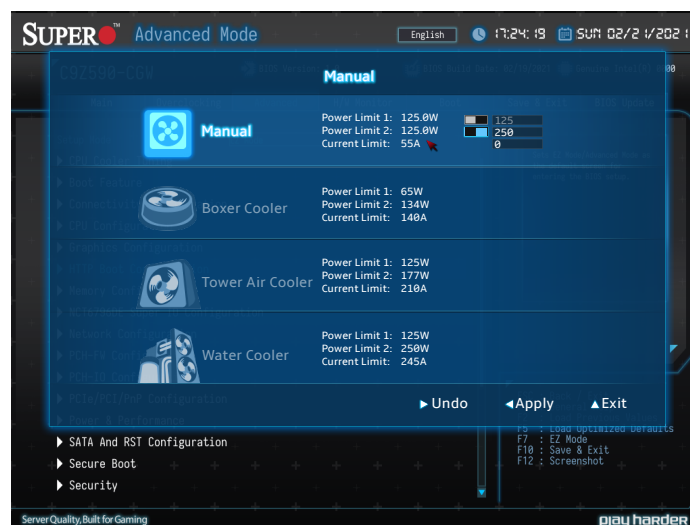

Use this feature to tune the coolers for the system. A pop-up window will appear when pressing <Enter> on this feature. Use the mouse cursor to select the desired cooler mode or enter a customized value on the feature of Manual using the number key on your keyboard. Once the setting has been completed, click the Apply for the change to take effect.

► Boot Feature

Boot Feature

Fast Boot

This feature enables the system to boot with a minimal set of required devices to launch. This has no effect on BBS boot options. The options are **Disabled** and Enabled.

Quiet Boot

Use this feature to select the screen display between the POST messages and the OEM logo upon boot up. Uncheck the box to display the POST messages. Check the box to display the OEM logo instead of the normal POST messages. The default is **Checked**.

Bootup NumLock State

Use this feature to set the Power-on state for the <Numlock> key. The options are **On** and Off.

Wait For "F1" If Error

Use this feature to force the system to wait until the "F1" key is pressed if an error occurs. The options are Disabled and **Enabled**.

Re-try Boot

If this feature is enabled, the BIOS will automatically reboot the system from a specified boot device after its initial boot failure. The options are **Disabled** and EFI Boot.

Power Configuration

Watch Dog Function

If enabled, the Watch Dog Timer will allow the system to reset or generate NMI based on jumper settings when it is expired for more than five minutes. The options are **Disabled** and Enabled.

AC Loss Policy Depend on

Use this feature to set the power state after a power outage. Select Stay Off for the system power to remain off after a power loss. Select Power On for the system power to be turned on after a power loss. Select Last State to allow the system to resume its last power state before a power loss. The options are Stay Off, Power On, and **Last State**.

Power Button Function

This feature controls how the system shuts down when the power button is pressed. Select 4 Seconds Override for you to power off the system after pressing and holding the power button for four seconds or longer. Select Instant Off to instantly power off the system as soon as you presses the power button. The options are **Instant Off** and 4 Seconds Override.



Note: This feature is available only for non-ACPI OS and Pre-OS.

DeepSx Power Policies

This feature enables DeepSx Power Policy configuration. The options are **Disabled**, Enabled in S4-S5, and Enabled in S5.

► Connectivity Configuration



Note: This submenu becomes configurable when a CNVi device is plugged into the motherboard. It's already built-in in C9Z590-CGW.

Connectivity Configuration

The following information will be displayed:

- **CNVi present** - display the status of wireless connection.

CNVi Configuration

CNVi WiFi&BT

This feature enables CNVi WiFi and Bluetooth support. The options are **Disabled** and **Enabled**.

► CPU Configuration

CPU Configuration

The following CPU information will be displayed:

Brand String - the brand and speed of installed CPU

Frequency - the frequency of installed CPU

ID - the unique CPU ID

Stepping - the processor stepping

Number of Processors - the number of cores detected / the number of threads detected

Advanced Option - enabled (Checked) or disabled (Unchecked) the advanced features

**If this feature above is set to Checked, the following information will be displayed:*

Microcode Revision

GT Info

IGFX GOP Version (Available if the CPU installed supports IGFX GOP.)

L1 Data Cache

L1 Instruction Cache

L2 Cache

L3 Cache

VMX

SMX/TXT

C6DRAM

This feature enables moving DRAM contents to PRM memory when the CPU is in a C6 state. The options are Disabled and **Enabled**.



Note: This feature is available depending on the CPU installed.

Hardware Prefetcher

If set to Enabled, the hardware prefetcher will prefetch streams of data and instructions from the main memory to the L2 cache to improve CPU performance. The options are Disabled and **Enabled**.

Adjacent Cache Line Prefetch

Select Enabled for the CPU to prefetch both cache lines for 128 bytes as comprised. Select Disabled for the CPU to prefetch both cache lines for 64 bytes. The options are Disabled and **Enabled**.

Intel (VMX) Virtualization Technology

Select Enabled to use the Intel Virtualization Technology to allow one platform to run multiple operating systems and applications in independent partitions, creating multiple "virtual" systems in one physical computer. The options are Disabled and **Enabled**.

Active Processor Cores

Use this feature to select the number of active processor cores. The default option is **All**. The available options depend on how many cores are supported by the CPU.

Hyper-Threading

Select Enabled to support Intel Hyper-threading Technology to enhance CPU performance. The options are Disabled and **Enabled**.

BIST

Select Enabled to activate the Built-In Self Test (BIST) on reset. The options are **Disabled** and Enabled.

AES

Select Enabled for Intel CPU Advanced Encryption Standard (AES) Instructions support to enhance data integrity. The options are Disabled and **Enabled**.

Machine Check

Select Enabled to activate Machine Check. The options are Disabled and **Enabled**.

MonitorMWait

Select Enabled to activate MonitorMWait. The options are Disabled and **Enabled**.

Reset AUX Content

Use this feature to reset the TPM Auxiliary content. The options are Yes and **No**.

 **Note:** This feature is available for configuring when the Intel Virtualization Technology is set to Enabled and Active Processor Cores is set to All.

► Graphics Configuration

Graphics Configuration

 **Note:** Only the feature of Primary Display is available for configuring in this submenu if the installed CPU doesn't have integrated graphics.

Graphics Turbo IMON Current

Enter a value for the graphics turbo IMON current. The range is 14-31. The default is **31**.

Skip Scanning of External Gfx Card

This feature disables scanning for external graphics cards. When this feature is set to Enabled, the system will not scan for external graphics cards on PEG and PCH PCIe ports. The options are **Disabled** and Enabled.

Primary Display

This feature controls which graphics device will be used as the primary display. The options are **Auto**, IGFX, PEG, and PCI.

Internal Graphics

This item keeps the Internal Graphics Device (IGD) enabled, based on setup options. The options are **Auto**, Enabled and Disabled.

GTT Size

This feature controls the memory allocation size for the graphics translation table (GTT). The options are 2MB, 4MB, and **8MB**.

Aperture Size

This feature controls the graphics aperture size. For optimal performance, select the size that matches the installed graphics card's size. The options are 128MB, **256MB**, 512MB, 1024MB, and 2048MB.

DVMT Pre-Allocated

This feature controls the DVMT 5.0 Pre-allocated graphics memory size to be used by the internal graphics device. The options are 0M, **32M**, 64M, 4M, 8M, 12M, 16M, 20M, 24M, 28M, 32M/F7, 36M, 40M, 44M, 48M, 52M, 56M, and 60M.

DVMT Total Gfx Mem

This feature controls the DVMT 5.0 total graphics size to be used by the internal graphics device. The options are 128M, **256M**, and MAX.

PM Support

This feature enables PM support. The options are **Enabled**, and Disabled.

PAVP Enable

This feature enables PAVP support. The options are **Enabled** and Disabled.

Cdynmax Clamping Enable

This feature enables Cdynmax Clamping. The options are **Enabled** and Disabled.

Graphics Clock Frequency

This feature controls the graphics clock frequency. Select the highest clock frequency supported by the platform. The options are 192 Mhz, 312 Mhz, 324 Mhz, 552 Mhz, 648Mhz, and **Max CdClock freq based on Reference Clk**.

► HDD Security Configuration



Note: This feature appears when a hard drive is detected.

HDD Security Configuration

HDD Password Configuration

Information for the following is displayed:

P0

Security Supported

Security Enabled

Security Locked

Security Frozen

HDD User Pwd Status

HDD Master Pwd Status

► Set User Password

Press <Enter> to create a new or change an existing HDD password.



Note: This feature is available for configuring when the status of Security Frozen is No.

► HTTP BOOT Configuration

HTTP BOOT Configuration

HTTP Boot Policy

Use this feature to select the policy of HTTP Boot. The options are Apply to all LANs, **Apply to each LAN**, and Boot Priority #1 instantly.



Note: To configure each LAN port, please select Apply to each LAN or Boot Priority #1 instantly. Only the Instance of Priority 1 appears when selecting the option of Apply to all LANs.

Priority of HTTP Boot

Instance of Priority 1

Use this feature to rank the targeted port.

Select IPv4 or IPv6

Use this feature to select the Targeted LAN port that is boot from IPv4 or IPv6. The options are **IPv4** and IPv6.

Boot Description

Use this feature to input the HTTP boot option description, otherwise the boot option for the URI will not be created. The maximum length should not more than 75 characters.

Boot URI

Use this feature to input the URI address for HTTP Boot feature. The maximum length should not more than 128 characters.

Instance of Priority X

Use this feature to rank the targeted port.

 **Notes:** 1. The number of X is depending on the motherboard's hardware and available for configuring when the HTTP Boot Policy is set to Apply to each LAN or Boot Priority #1 instantly. 2. The features below will be hidden if the option of Instance of Priority X sets to 0.

Select IPv4 or IPv6

Use this feature to select the Targeted LAN port that is boot from IPv4 or IPv6. The options are **IPv4** and IPv6.

Boot Description

Use this feature to input the HTTP boot option description, otherwise the boot option for the URI will not be created. The maximum length should not more than 75 characters.

Boot URI

Use this feature to input the URI address for HTTP Boot feature. The maximum length should not more than 128 characters.

► Memory configuration

Memory configuration

The following memory information will be displayed:

Memory RC Version - displays the memory reference code version.

Memory Frequency - displays the frequency of the installed memory.

Memory Timings (tCL-tRCD-tRP-tRAS)

DIMMA1 - displays if a DIMM is installed on this slot, and the DIMM size.

DIMMA2 - displays if a DIMM is installed on this slot, and the DIMM size.

DIMMB1 - displays if a DIMM is installed on this slot, and the DIMM size.

DIMMB2 - displays if a DIMM is installed on this slot, and the DIMM size.

Maximum Memory Frequency

This feature selects the type/speed of the memory installed. The default is **Auto** and all values are in MHz.

Max TOLUD (Top of Low Usable DRAM)

This feature sets the maximum TOLUD value, which specifies the "Top of Low Usable DRAM" memory space to be used by internal graphics devices, GTT Stolen Memory, and TSEG, respectively, if these devices are enabled. The options are **Dynamic**, 1 GB, 1.25 GB, 1.5 GB, 1.75 GB, 2 GB, 2.25 GB, 2.5 GB, 2.75 GB, 3 GB, 3.25 GB, and 3.5 GB.



Note: TSEG is a block of memory that is only accessible by the processor while operating in System Management Mode (SMM).

Memory Scrambler

This feature enables memory scrambler support for memory error correction. The options are Disabled and **Enabled**.

Force ColdReset

Use this feature when ColdBoot is required during MRC execution. The options are Enabled and **Disabled**.

Force Single Rank

When enabled, only Rank0 will be use in each DIMM. The options are **Disabled** and Enabled.

Memory Remap

PCI memory resources will overlap with the total physical memory if 4GB of memory (or above) is installed on the motherboard. When this occurs, enable this function to reallocate the overlapped physical memory to a location above the total physical memory to resolve the memory overlap-ping situation. The options are **Enabled** and Disabled.

MRC Fast Boot

This feature enables or disables fast path through MRC. The options are Disabled and **Enabled**.

► NCT6796DE Super IO Configuration

NCT6796DE Super IO Configuration

Super IO Chip - NCT6796DE

► Serial Port 1 Configuration

Serial Port 1 Configuration

Serial Port

This feature will enable or disable Serial Port 1 (COM1). Check the box to enable Serial Port 1. The default is **Checked**.



Note: Select Checked to enable the features below.

Device Settings - IO=3F8h; IRQ=4;

Change Settings

This feature configures the IRQ setting for Serial Port 1 (COM1). The options for Serial Port 1 are **Auto**, "IO=3F8h; IRQ=4", "IO=3F8h; IRQ=3, 4, 5, 6, 7, 9, 10, 11, 12", "IO=2F8h; IRQ=3, 4, 5, 6, 7, 9, 10, 11, 12", "IO=3E8h; IRQ=3, 4, 5, 6, 7, 9, 10, 11, 12", and "IO=2E8h; IRQ=3, 4, 5, 6, 7, 9, 10, 11, 12".

► Network Configuration



Note: This submenu becomes configurable when the Onboard LAN1 Option ROM is set to UEFI.

Network Configuration

► Intel(R) Ethernet Connection (14) I219-V (XX:XX:XX:XX:XX:XX)

PORT CONFIGURATION INFORMATION

Information for the LAN port configuration is displayed.

UEFI Driver

Adapter PBA

PCI Device ID

PCI Address

MAC Address

► MAC: XXXXXXXXXXXXX-IPv4 Network Configuration

Configured

This feature indicates whether a network address configured successfully or not. The default is **Unchecked**.

**If the feature of Configured is set to checked, the following features will become available for configuration:*

Enable DHCP

Use this feature to set the DHCP. The default is **Unchecked**.

**If the feature of Enable DHCP is set to Unchecked, the following features will become available for configuration:*

Local IP Address - Enter an IP address in dotted-decimal notation

Local NetMask - Enter a NetMask in dotted-decimal notation

Local Gateway - Enter a Gateway in dotted-decimal notation

Local DNS Servers - Enter a DNS Servers in dotted-decimal notation

► Save Changes and Exit

Select this feature to save the changes you've made and return to the upper configuration page.

► MAC: XXXXXXXXXXXXX-IPv6 Network Configuration

Enter Configuration Menu

Information for the following is displayed:

Interface Name

Interface Type

MAC Address

Host Addresses

Route Table

Gateway addresses

DNS addresses

Interface ID

Enter an ID for the device

DAD Transmit Count

Enter a value for Duplicate Address Detection (DAD) Transmit Count. A value of zero indicates the DAD is not performed. The default is **1**.

Policy

Use this feature to set the Policy. The options are **Automatic** and Manual.

****If this feature above is set to Manual, the following features will become available for configuration:***

▶ **Advanced Configuration**

New IPv6 Address - Enter a new IPv6 address

New Gateway Addresses - Enter a Gateway address

New DNS Addresses - Enter a new DNS address

▶ **Commit Changes and Exit**

Select this feature to save the changes you've made and return to the upper configuration page.

▶ **Discard Changes and Exit**

Select this feature to discard all the changes and return to the upper configuration page.

▶ **Save Changes and Exit**

Select this feature to save the changes you've made and return to the upper configuration page.

► PCH-FW Configuration

PCH-FW Configuration

Information for the following is displayed:

ME Firmware Version

ME Firmware Mode

ME Firmware SKU

ME FW Image Re-Flash

This feature enables an update to the PCH firmware from an image in a USB flash drive attached to a USB port. The options are **Disabled** and **Enabled**.

► PCH-IO Configuration

PCH-IO Configuration

HD Audio

This feature controls the detection of HD Audio devices. The options are **Disabled** and **Enabled**.

Wake on LAN Enable

This feature enables integrated LAN to wake the system. The options are **Disabled** and **Enabled**.

PCIe PLL SSC

This feature controls the PCIe PLL SSC setting. The options are **Auto** and 0.0~2.0% (in 0.1% increments).

DMI Link ASPM Control

This feature configures Active State Power Management (ASPM) for DMI Link. The options are **Disabled**, **L0s**, **L1**, **L0sL1**, and **Auto**.

PCH SLOT4 ASPM

This feature configures the Active State Power Management (ASPM) settings for PCH Slot 4. The options are **Disabled**, **L0s**, **L1**, **L0sL1**, and **Auto**.

PCH SLOT4 L1 Substates

This feature configures the L1 substate for PCH Slot 4. The options are **Disabled**, **L1.1**, and **L1.1 & L1.2**.

PCIE M.2-M1 ASPM

This feature configures the Active State Power Management (ASPM) settings for M.2-M1. The options are Disabled, L0s, L1, L0sL1, and **Auto**.

PCIE M.2-M1 L1 Substates

This feature configures the L1 substate for M.2-M1. The options are Disabled, L1.1, and **L1.1 & L1.2**.

PCH SLOT3 ASPM

This feature configures the Active State Power Management (ASPM) settings for PCH Slot 3. The options are Disabled, L0s, L1, L0sL1, and **Auto**.

PCH SLOT3 L1 Substates

This feature configures the L1 substate for PCH Slot 3. The options are Disabled, L1.1, and **L1.1 & L1.2**.

PCIE M.2-M2 ASPM

This feature configures the Active State Power Management (ASPM) settings for M.2-M2. The options are Disabled, L0s, L1, L0sL1, and **Auto**.

PCIE M.2-M2 L1 Substates

This feature configures the L1 substate for M.2-M2. The options are Disabled, L1.1, and **L1.1 & L1.2**.

► PCIe/PCI/PnP Configuration

PCIe/PCI/PnP Configuration

CPU SLOT1 PCI-E 3.0 X1 OPROM

CPU SLOT4 PCI-E 3.0 X1 OPROM

PCH SLOT5 PCI-E 4.0 X8 (IN X16) OPROM

CPU SLOT7 PCI-E 4.0 X16 OPROM

PCIE M.2-M1 OPROM

PCIE M.2-M2 OPROM

PCIE M.2-M3 OPROM

PCIE M.2-E1 OPROM

Select Disabled to deactivate the selected slot or EFI to activate the slot in UEFI mode. The options are Disabled and **UEFI**.

Onboard LAN1 SUPPORT

Use this feature to enable the onboard LAN1 device. The options are Disabled and **Enabled**.

Onboard LAN2 SUPPORT

Use this feature to enable the onboard LAN2 device. The options are Disabled and **Enabled**.

Onboard LAN1 Option ROM

Use this feature to select a desired firmware function to be loaded for onboard LAN1. The options are Disabled and **UEFI**.

Onboard LAN2 Option ROM

Use this feature to select a desired firmware function to be loaded for onboard LAN2. The options are Disabled and **UEFI**.



Note: This feature is available for configuring when the Onboard LAN1 Option ROM set to Disabled.

Option ROM execution

Video

This feature controls which option ROM to execute for the Video device. The options are Do Not Launch and **EFI**.

Above 4GB MMIO BIOS Assignment

Select Enable for remapping of BIOS above 4GB. The options are **Enabled** and Disabled.

BME DMA Mitigation

Enable this feature to help block DMA attacks. The options are **Disabled** and Enabled

NVMe Firmware Source

Use this feature to select the NVMe firmware to support booting. The options are **Vendor Defined Firmware** and AMI Native Support. The default option, **Vendor Defined Firmware**, is pre-installed on the drive and may resolve errata or enable innovative functions for the drive. The other option, AMI Native Support, is offered by the BIOS with a generic method.

Consistent Device Name Support

Use this feature to enable device name support for onboard devices and slots. The options are **Disabled** and Enabled.

Network Stack

Select Enabled to enable Preboot Execution Environment (PXE) or Unified Extensible Firmware Interface (UEFI) for network stack support. The options are Disabled and **Enabled**.

****If this feature above is set to enabled, the following features will become available for configuration:***

IPv4 PXE Support

Select Enabled to enable IPv4 Preboot Execution Environment (PXE) for boot support. If this feature is set to Disabled, IPv4 PXE boot option will not be supported. The options are Disabled and **Enabled**.

IPv4 HTTP Support

Use this feature to enable IPv4 HTTP boot support. The options are **Disabled** and Enabled.

IPv6 PXE Support

Select Enabled to enable IPv6 Preboot Execution Environment (PXE) for boot support. If this feature is set to Disabled, IPv6 PXE boot option will not be supported. The options are Disabled and **Enabled**.

IPv6 HTTP Support

Use this feature to enable IPv6 HTTP boot support. The options are **Disabled** and Enabled.

PXE boot wait time

Enter a value for the wait time (in seconds) to press the <ESC> key to abort the PXE boot. The default is **0**.

Media detect count

Enter a value for the number of times the presence of media will be checked. The default is **1**.

► Power & Performance

Power & Performance

► CPU - Power Management Control

Boot Performance Mode

This feature controls the performance state that the BIOS will set initially. The options are Max Battery, **Max Non-Turbo Performance**, and Turbo Performance.

Intel(R) SpeedStep(tm)

Intel SpeedStep Technology allows the system to automatically adjust processor voltage and core frequency in an effort to reduce power consumption and heat dissipation. Please refer to Intel's website for detailed information. The options are Disabled and **Enabled**.

C-States

C-States architecture, a processor power management platform developed by Intel, can further reduce power consumption from the basic C1 (Halt State) state that blocks clock cycles to the CPU. Select Enabled for CPU C-States support. The options are Disabled and **Enabled**.

****If this feature above is set to enabled, the following features will become available for configuration:***

Enhanced C-states

This feature enables Enhanced C1 Power State to lower system energy consumption while all cores are in C-State. The options are Disabled and **Enabled**.

C-State Auto Demotion

When this feature is enabled, the CPU will conditionally demote C-State based on uncored auto-demote information. The options are Disabled and **C1**.

C-State Un-demotion

When this feature is enabled, the CPU will conditionally un-demote from demoted C3 or C1. The options are Disabled and **C1**.

Package C-State Demotion

This feature enables the Package C-State demotion. The options are **Disabled** and Enabled.

Package C-State Un-Demotion

When this feature is enabled, the CPU will conditionally un-demote from demoted Packaged Package C-State Un-Demotion. The options are **Disabled** and Enabled.

C-State Pre-Wake

This feature enables the C-State pre wake. The options are Disabled and **Enabled**.

IO MWAIT Redirection

When enabled, this feature will map and send the I/O read instructions to the I/O registers. The options are **Disabled** and Enabled.

Package C-State Limit

Select Auto for the AMI BIOS to automatically set the limit on the C-State package register. The options are C0/C1, C2, C3, C6, C7, C7S, C8, C9, C10, CPU Default, and **Auto**.

Package C-State Workaround

This feature enables a workaround for Package C-State 6/7. The options are **Disabled** and Enabled.

▶ GT - Power Management Control



Note: This submenu becomes configurable when the installed CPU has built-in integrated graphics.

GT - Power Management Control

RC6 (Render Standby)

Use this feature to enable Render Standby support. The options are Disabled and **Enabled**.

Maximum GT Frequency

This feature defines the Maximum GT Frequency. Choose between 100MHz (RPN) and 1200MHz (RP0). Any value beyond this range will be clipped to its min/max supported by the CPU. The options are **Default Max Frequency** and 100MHz~1200MHz (in increments of 50MHz).

****If this feature above is set to Default Max Frequency, the following feature will become available for configuration:***

Disable Turbo GT frequency

This feature disables Turbo GT frequency. If set to Enabled, Turbo GT frequency becomes disabled. If set to Disabled, GT frequency limiters will be removed. The options are **Disabled** and Enabled.

▶ SATA And RST Configuration

SATA And RST Configuration

SATA Controller(s)

This feature enables SATA device(s). The options are **Enabled** and Disabled.

****If the feature of SATA Controller(s) is set to Enabled, the following features will become available for configuration:***

SATA Mode Selection

This feature controls SATA mode(s). The options are **AHCI** and Intel RST Premium With Intel Optane System Acceleration.

****If the feature of SATA Mode Selection is set to Intel RST Premium With Intel Optane System Acceleration, the following features will become available for configuration:***

SATA Interrupt Selection

Select which interrupt will be available to the OS. The options are **Msi** and Msi.

PCIe M.2-M1/PCI-E M.2-M2/PCI-E M.2-M3

This feature appears if an M.2 device is plugged in and Intel RST Premium With Intel Optane System Acceleration is selected in the SATA Mode Selection feature. Use this feature to enable or disable RST PCIe storage remapping. The options are RST Controlled and **Not RST Controlled**.

RAID Device ID

Use this feature to select a RAID device ID. The options are **iRST Mode** and Alternate.

Storage Option ROM/UEFI Driver

This feature controls the execution of UEFI and legacy storage OpROM. The options are Do not launch and **UEFI**.

Aggressive LPM Support

This feature enables the PCH to aggressively enter link power state. The options are Disabled and **Enabled**.

Serial ATA Port0~3**Software Preserve****Hot Plug**

This feature designates the port specified for hot plugging. Set the setting to Enabled for hot-plugging support, which will allow you to replace a SATA disk drive without shutting down the system. The options are Disabled and **Enabled**.

Spin Up Device

When this feature is disabled, all drives will spin up at boot. When this option is enabled, it will perform Staggered Spin Up on any drive this option is activated. The options are **Disabled** and Enabled.

SATA Device Type

Use this feature to identify the type of HDD that is connected to the SATA port. The options are **Hard Disk Drive** and Solid State Drive.

▶ Secure Boot

Information for the following is displayed:

System Mode

Secure Boot

Secure Boot

Select Enabled for Secure Boot flow control. This feature is available when the platform key (PK) is pre-registered and enabled the Secure Boot, the platform operates in the user mode. The options are **Disabled** and Enabled.

Secure Boot Mode

This feature allows selection of the Secure Boot Mode between Standard and Custom. Selecting Custom enables users to change the Image Execution Policy and manage Secure Boot Keys. The options are **Custom** and Standard.

**If this feature above is set to Custom, the features below will become available for configuration:*

▶ Enter Audit Mode

This submenu can only be used if current System Mode is set to User (refer to Exit Deployed Mode). The PK variable will be erased on transition to Audit Mode.

▶ Exit Deployed Mode

Press <Enter> button to switch between Deployment and User Mode.

▶ Key Management

Key Management

▶ Restore Factory Keys

This feature resets the content of all UEFI Secure Boot key databases to factory defaults.

▶ Reset to Setup Mode

This feature deletes the contents of all UEFI Secure Boot key databases. This will result in entering Setup Mode.

▶ Export Secure Boot variables

This feature allows you to copy NVRAM content of Secure boot variables to files in a root folder on a file system device.

▶ Enroll EFI Image

This feature allows the image to run in Secure Boot Mode. Enroll SHA256 Hash Certificate of the image into the Authorized Signature Database.

Device Guard Ready

▶ Remove 'UEFI CA' from DB

Use this feature to remove the Microsoft UEFI CA certificate from the database.

▶ Restore DB Defaults

Select Yes to restore the DB defaults or select No to cancel.

Secure Boot Variable / Size / Keys / Key Source

▶ Platform Key (PK)

This feature allows you to configure the settings of the platform keys.

Details

Review details on current settings of the platform keys.

Export

This feature allows you to export Platform Keys to an available file system.

Update

Select Yes to load the new Platform Keys (PK) from the manufacturer's defaults. Select No to load the Platform Keys from a file.

Delete

Select OK to confirm deletion of the Platform Key from NVRAM.

► Key Exchange Keys

Details

Review details on current settings of the Key Exchange Keys.

Export

This feature allows you to export Key Exchange Keys to an available file system.

Update

Select Yes to load the KEK from the manufacturer's defaults. Select No to load the KEK from a file.

Append

Select Yes to add the KEK from the manufacturer's defaults list to the existing KEK. Select No to load the KEK from a file.

Delete

Select Yes to delete the Key Exchange Keys. Select No to delete only a certificate from the key database.

► Authorized Signatures

Details

Review details on current settings of Authorized Signatures.

Export

This feature allows you to export Authorized Signatures to an available file system.

Update

Select Yes to load the factory default DB. Select No to load the DB from an external file.

Append

Select Yes to add the database from the manufacturer's defaults to the existing DB. Select No to load the DB from a file.

Delete

Select Yes to delete the Authorized Signatures key database. Select No to delete only a certificate from the key database.

► Forbidden Signatures

Details

Review details on current settings of the Forbidden Signatures.

Export

This feature allows you to export Forbidden Signatures to an available file system.

Update

Select Yes to load the DBX factory default 'dbx.' Select No to load it from an external file.

Append

Select Yes to add the DBX from the manufacturer's defaults to the existing DBX. Select No to load the DBX from a file.

Delete

Select Yes to delete the Forbidden Signatures key database. Select No to delete only a certificate from the key database.

► Authorized TimeStamps

Details

Review details on current settings of the Authorized TimeStamps.

Export

This feature allows you to export Authorized TimeStamps to an available file system.

Update

Select Yes to load the DBT from the manufacturer's defaults. Select No to load the DBT from a file.

Append

Select Yes to add the DBT from the manufacturer's defaults list to the existing DBT. Select No to load the DBT from a file.

Delete

Select Yes to delete the Authorized TimeStamps key database. Select No to delete only a certificate from the key database.

► OsRecovery Signatures

Details

Review details on current settings of the OsRecovery Signatures.

Export

This feature allows you to export OsRecovery Signatures to an available file system.

Update

Select Yes to load the DBT from the manufacturer's defaults. Select No to load the DBT from a file.

Append

Select Yes to add the DBT from the manufacturer's defaults list to the existing DBT. Select No to load the DBT from a file.

Delete

Select Yes to delete the variable. Select No to delete only a certificate from the key database.

► Security

Security

Hard Drive Security Frozen

Use this feature to enable BIOS security frozen command to SATA and NVME devices. The options are Enabled and **Disabled**.

Password Check

Select Setup for the system to check for a password at Setup. Select Always for the system to check for a password at boot up or upon entering the BIOS Setup utility. The options are **Setup** and Always.

► Administrator Password

Press <Enter> to create a new, or change an existing, Administrator password.

****If the password has been created, the feature of User Password below will become available for configuration.***

User Password

Press <Enter> to create a new, or change an existing, Administrator password.

► SMC Security Erase Configuration

 **Notes:** 1. This submenu becomes configurable when a storage device has been plugged into the motherboard. 2. The features shown below are subject to change depending on the plugged device.

Information for the following is displayed:

HDD Name

HDD Serial Number

Security Mode

TCG Device Type

Estimated Time

HDD UserPwd Status

Security Function

Use this feature to set Security Function. The options are **Disabled**, Set Password, Security Erase - Password, Security Erase - PSID, and Security Erase - Without Password.

 **Note:** The option of Security Erase - PSID is subject to change depending on the plugged device.

Password

Enter a numeric value to set the password.

► Serial Port Console Redirection

Serial Port Console Configuration

COM1

COM1 Console Redirection

Check the box to enable console redirection support for a serial port specified by you. The options are **Unchecked** and Checked.

**If this feature above is set to Checked, the following features will become available for configuration:*

► COM1 Console Redirection Settings

COM1

Use this feature to specify how the host computer will exchange data with the client computer, which is the remote computer used by you.

COM1 Terminal Type

This feature allows you to select the target terminal emulation type for Console Redirection. Select VT100 to use the ASCII Character set. Select VT100+ to add color and function key support. Select ANSI to use the Extended ASCII Character Set. Select VT-UTF8 to use UTF8 encoding to map Unicode characters into one or more bytes. The options are VT100, **VT100+**, VT-UTF8, and ANSI.

COM1 Bits Per Second

Use this feature to set the transmission speed for a serial port used in Console Redirection. Make sure that the same speed is used in the host computer and the client computer. A lower transmission speed may be required for long and busy lines. The options are 9600, 19200, 38400, 57600, and **115200** (bits per second).

COM1 Data Bits

Use this feature to set the data transmission size for Console Redirection. The options are 7 Bits and **8 Bits**.

COM1 Parity

A parity bit can be sent along with regular data bits to detect data transmission errors. Select Even if the parity bit is set to 0, and the number of 1's in data bits is even. Select Odd if the parity bit is set to 0, and the number of 1's in data bits is odd. Select None if you do not want to send a parity bit with your data bits in transmission. Select Mark to add a mark as a parity bit to be sent along with the data bits. Select Space to add a Space as a parity bit to be sent with your data bits. The options are **None**, Even, Odd, Mark, and Space.

COM1 Stop Bits

A stop bit indicates the end of a serial data packet. Select 1 (Stop Bit) for standard serial data communication. Select 2 (Stop Bits) if slower devices are used. The options are **1** and **2**.

COM1 Flow Control

Use this feature to set the flow control for Console Redirection to prevent data loss caused by buffer overflow. Send a "Stop" signal to stop sending data when the receiving buffer is full. Send a "Start" signal to start sending data when the receiving buffer is empty. The options are **None** and Hardware RTS/CTS.

COM1 VT-UTF8 Combo Key Support

Check the box to enable VT-UTF8 Combination Key support for ANSI/VT100 terminals. The options are Unchecked and **Checked**.

COM1 Recorder Mode

Check the box to capture the data displayed on a terminal and send it as text messages to a remote server. The options are **Unchecked** and Checked.

COM1 Resolution 100x31

Check the box to enabled for extended terminal resolution support. The options are Unchecked and **Checked**.

COM1 Putty KeyPad

This feature selects the settings for Function Keys and KeyPad used for Putty, which is a terminal emulator designed for the Windows OS. The options are **VT100**, LINUX, XTERMR6, SCO, ESCN, and VT400.

COM1 Redirection After BIOS POST

Use this feature to enable or disable legacy console redirection after BIOS POST. When set to Bootloader, legacy console redirection is disabled before booting the OS. When set to Always Enable, legacy console redirection remains enabled when booting the OS. The options are **Always Enable** and Bootloader.

Serial Port for Out-of-Band management/ Windows Emergency Management Services (EMS)

Console Redirection

Check the box to use a COM port selected by you for EMS Console Redirection. The options are **Checked** and Unchecked.

**If this feature above is set to Checked, the following features will become available for configuration:*

► Console Redirection Settings

Console Redirection Settings

This feature allows you to specify how the host computer will exchange data with the client computer, which is the remote computer used by you.

Out-of-Band Mgmt Port - COM1

Terminal Type

Use this feature to select the target terminal emulation type for Console Redirection. Select VT100 to use the ASCII character set. Select VT100+ to add color and function key support. Select ANSI to use the extended ASCII character set. Select VT-UTF8 to use UTF8 encoding to map Unicode characters into one or more bytes. The options are VT100, VT100+, **VT-UTF8**, and ANSI.

Bits Per Second

This feature sets the transmission speed for a serial port used in Console Redirection. Make sure that the same speed is used in the host computer and the client computer. A lower transmission speed may be required for long and busy lines. The options are 9600, 19200, 57600, and **115200** (bits per second).

Flow Control

Use this feature to set the flow control for Console Redirection to prevent data loss caused by buffer overflow. Send a "Stop" signal to stop sending data when the receiving buffer is full. Send a "Start" signal to start sending data when the receiving buffer is empty. The options are **None**, Hardware RTS/CTS, and Software Xon/Xoff.

The setting for each of these features is displayed:

Data Bits

Parity

Stop Bits

► System Agent (SA) Configuration

System Agent (SA) Configuration

The following information will be displayed:

SA PCIe Code Version

VT-d

► PEG Port Configuration

PEG Port Configuration

PEG 0:1:0

Enable Root Port

Select Enable to activate the Root Port. The options are Disabled, Enabled, and **Auto**.

VT-d

This feature enables VT-d capability. The options are Disabled and **Enabled**.

GNA Device (B0:D8:F0)

This feature enables the SA GNA device. The options are **Enabled** and Disabled.

X2APIC Opt Out

This feature enables X2APIC Opt Out. The options are Enabled and **Disabled**.



Note: This feature is subject to change depending on the CPU installed.

► Trusted Computing



Note: This feature is appeared and available for configuration when a TPM 2.0 device is installed.

Trusted Computing

The following information will be displayed:

TPM 2.0 Device Found

Firmware Version

Vendor

Security Device Support

This feature enables BIOS support for security devices. The options are Disabled and **Enabled**.

If this feature above is set to **Enabled and **Save & Exit**, the following features will become available for configuration:*

Active PCR banks

Available PCR banks

SHA-1 PCR Bank

This feature enables SHA-1 PCR Bank. The options are Disabled and **Enabled**.

SHA256 PCR Bank

This feature enables SHA256 PCR Bank. The options are Disabled and **Enabled**.

TPM State

This feature changes the TPM State. The options are Disabled and **Enabled**.

Pending operation

This feature schedules an operation for the security device. Changing this setting will reboot the system. The options are **None** and TPM Clear.



Note: This feature is available for configuring when the TPM State is set to Enabled.

Platform Hierarchy

This feature enables Platform Hierarchy. The options are Disabled and **Enabled**.

Storage Hierarchy

This feature enables Storage Hierarchy. The options are Disabled and **Enabled**.

Endorsement Hierarchy

This feature enables Endorsement Hierarchy. The options are Disabled and **Enabled**.

TPM 20 InterfaceType

Current Status Information

The following information will be displayed:

TPM Enabled Status**TPM Active Status****TPM Owner Status****Disable Block sid**

Select Enabled to allow SID authentication to be performed in TCG Storage devices. The options are **Disabled** and Enabled.

► USB Configuration**USB Configuration**

The following information will be displayed:

USB Module Version**USB Controllers****USB Devices****XHCI Hand-off**

This feature is a workaround solution for operating systems that do not support Extensible Host Controller Interface (XHCI) hand-off. The XHCI ownership change should be claimed by the XHCI driver. The options are **Enabled** and Disabled.

USB Mass Storage Driver Support

This feature enables USB mass storage driver support. The options are Disabled and **Enabled**.

► Intel(R) Rapid Storage Technology

This submenu will only appear if the following requirements are met when entering BIOS:

1. Set the SATA Mode Selection to **Intel RST Premium With Intel Optane System Acceleration**.
2. Set the Storage Option ROM/UEFI Driver to **UEFI**.

Information for installed storage drives will be viewable in this submenu when the settings above have completed.

▶ Driver Health

This submenu displays the health of the LAN and its related controller.

▶ TCG Storage Device Security Configuration

TCG Storage Device Security Configuration:

▶ Storage Device



Note: This feature is available if a TCG storage device is detected by the system.

Password Configuration:

Information for the following is displayed:

Security Subsystem Class

Security Supported

Security Enabled

Security Locked

Security Frozen

Admin Pwd Status

▶ Set Admin Password

Press <Enter> to create a new admin password.

Device Reset

Reset the device using 32 byte Physical Security Identification (PSID) value of the device.

4.6 H/W Monitor

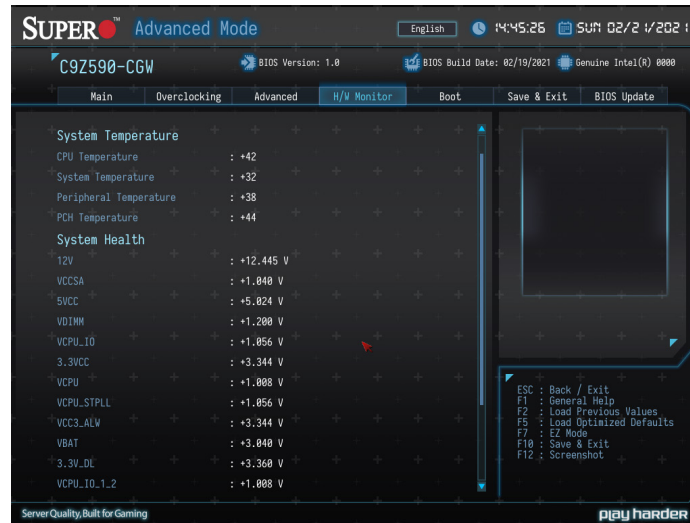

System Temperature

The following items will be displayed:

CPU Temperature - the CPU temperature detected by PECI

System Temperature - the system internal temperature

Peripheral Temperature - the detected peripheral device temperature

PCH Temperature - the detected PCH chip temperature

System Health

The voltages for the following items will be displayed:

12V

VCCSA

5VCC

VDIMM

VCPU_IO

3.3VCC

VCPU

VCPU_STPLL

VCC3_ALW

VBAT

3.3V_DL

VCPU_IO_1_2

VCCIN_AUX

► Fan Control

Fan Control Setting

Fan Speed Control Mode

This feature allows you to decide how the system controls the speeds of the onboard fans. The CPU temperature and the fan speed are correlative. When the CPU on-die temperature increases, the fan speed will also increase for effective system cooling. Select "Full Speed" to allow the onboard fans to run at full speed (of 100% Pulse Width Modulation Duty Cycle) for maximum cooling. This setting is recommended for special system configuration or debugging. Select "Stable" for the onboard fans to run at 50% of the Initial PWM Cycle in order to balance the needs between system cooling and power saving. This setting is recommended for regular systems with normal hardware configurations. Select "Quiet" to optimize for minimal fan noise and Custom to enter user-specific settings. The options are **Quiet**, **Stable**, **Full Speed**, and **Customize**.

****If this feature above is set to Customize, the following features will become available for configuration:***

CPU Fan1/CPU Fan2/SYS Fan1/SYS Fan2/SYS Fan3 Control

CPU Fan1/CPU Fan2/SYS Fan1/SYS Fan2/SYS Fan3 Reference Sensor

Use this feature to select the reference sensor of fan. The options are **CUP Temperature** and **PCH Temperature**.

Temperature 1~4/PWM1~4

Use this feature to set the temperature. The value should be set between 20~100.



Note: By default, only the temperature 1, 2, PWM1, and PWM 2 can be adjusted. Be sure the value you set on each feature must lower than 100 if you want to enable the temperature 3, 4, PWM3, and PWM4, except Temperature 1 and PWM1.

SYS Fan Control

Use this feature to set Fan Speed Control Mode. The options are **Auto**, **PWM Mode** and **DC Mode**.

4.7 Boot

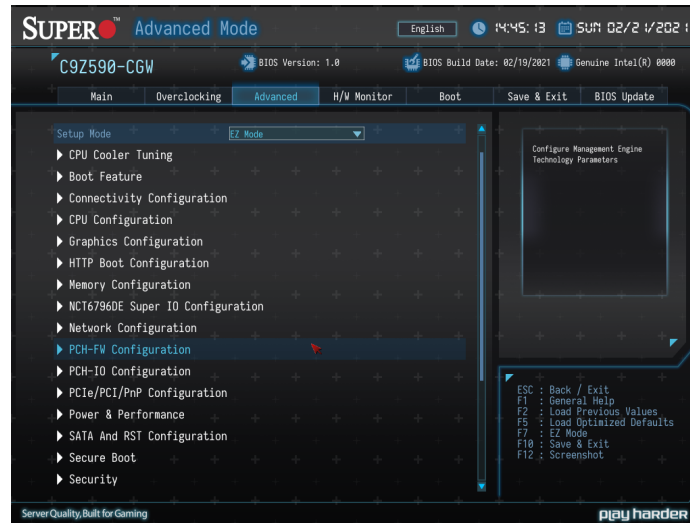

Fixed Boot order Priorities

This feature prioritizes the order of a bootable device from which the system will boot. Press <Enter> on each item sequentially to select devices.

UEFI Boot Option #1~#9

The options are **UEFI Hard Disk**, UEFI CD/DVD, UEFI USB Hard Disk, UEFI USB CD/DVD, USB Key, UEFI USB Floppy, UEFI USB Lan, UEFI Network, UEFI AP, and Disabled.

► Delete Boot Option

Delete Boot Option

Delete Boot Option

Removes an EFI boot option from the boot order.

►UEFI Hard Disk Drive BBS Priorities / UEFI CD/DVD Drive BBS Priorities / UEFI Application Boot Priorities / UEFI USB Hard Disk Drive BBS Priorities / UEFI USB CD/DVD Drive BBS Priorities / UEFI USB Key Drive BBS Priorities / UEFI USB Floppy Drive BBS Priorities / UEFI USB Lan Drive BBS Priorities / UEFI NETWORK Drive BBS Priorities / Hard Disk Drive BBS Priorities / CD/DVD Drive BBS Priorities / USB Hard Disk Drive BBS Priorities / USB CD/DVD Drive BBS Priorities / USB Key Drive BBS Priorities / USB Floppy Drive BBS Priorities / USB LAN Drive BBS Priorities / NETWORK Drive BBS Priorities



Note: These submenus are subject to change depending on the devices installed on this motherboard.

4.8 Save & Exit

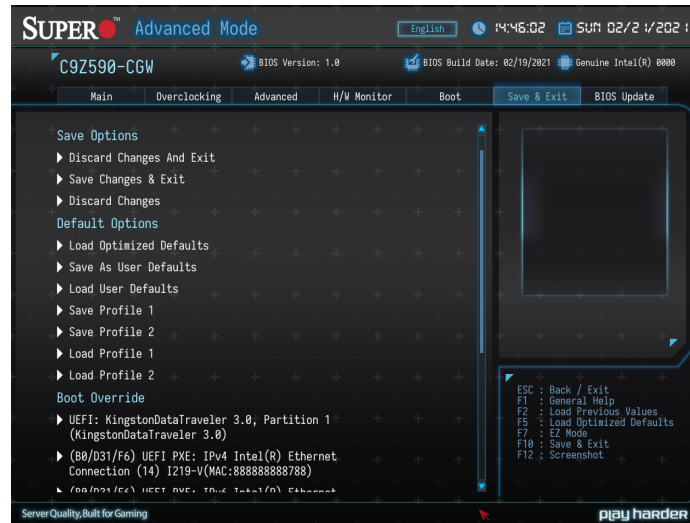

Save Options

► Discard Changes and Exit

Use this feature to exit the system without saving any changes and reboot the system.

► Save Changes and Exit

Use this feature to save the changes you have made and reboot the system.

► Discard Changes

Use this feature to discard the changes you have made and remain in setup mode.

Default Options

► Load Optimized Defaults

This feature will load the factory-stored optimized defaults.

► Save As User Defaults

This feature will save the changes as user-specified defaults.

► Load User Defaults

This feature will load previously-saved user-specified defaults.

► Save Profile 1/2

This feature will save the current overclocking profile into either Profile 1 or Profile 2 location. Click OK to save the profile, otherwise, click Cancel.

Load Profile 1/2

This feature will load a previously saved overclocking profile from either Profile 1 or Profile 2 location. Click OK to load the profile, otherwise, click Cancel.

Boot override

This feature allows you to override the Boot priorities sequence in the Boot menu, and immediately boot the system with a device specified by you instead of the one specified in the boot list. This is a one-time override.

4.9 BIOS Update

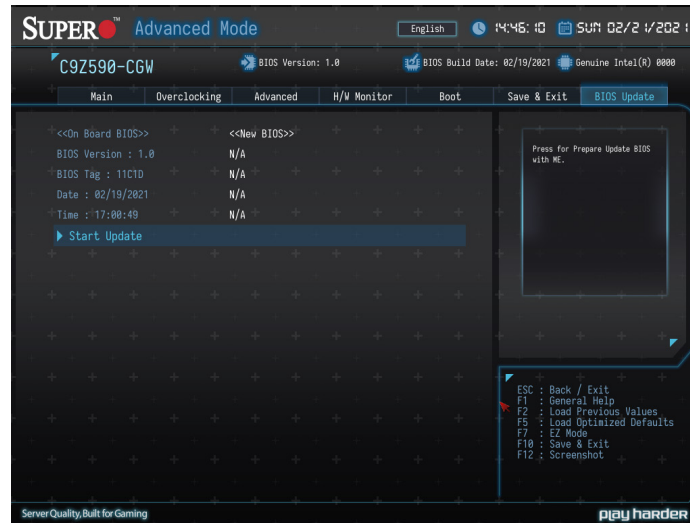

The following items will be displayed:

BIOS Version

BIOS Tag

Date

Time

► **Start Update**

Use this utility to prepare BIOS Update with ME.

1. Click "Start Update" enter the SuperFlash utility.
2. At the prompt, select "Yes" to reboot and configure the system to Flash mode. Select "No" to cancel and view the BIOS information.
3. After the system reboots to the flash mode, the system is ready to flash the BIOS. At the prompt, select "OK" to continue.
4. Select "Select File" and then in the pop-up menu select "General USB Flash Disk 1.00."
5. Select the filename (i.e., "C9Z590-CGW") in the pop-up menu.
6. Select "Start Flash" to flash the BIOS. A pop-up message will appear to show the progress of the BIOS flash.
7. If the flash is successful, a pop-up message will indicate the result. Select "OK" to complete the BIOS flash and to reboot the system. Check the System Information section of the BIOS Setup to check for the correct BIOS version.

Appendix A

BIOS Codes

A.1 BIOS Error POST (Beep) Codes

During the Power-On Self-Test (POST) routines, which are performed each time the system is powered on, errors may occur.

Non-fatal errors are those which, in most cases, allow the system to continue the boot-up process. The error messages normally appear on the screen.

Fatal errors are those which will not allow the system to continue the boot-up process. If a fatal error occurs, you should consult with your system manufacturer for possible repairs.

These fatal errors are usually communicated through a series of audible beeps. The table shown below lists some common errors and their corresponding beep codes encountered by users.

BIOS Beep (POST) Codes		
Beep Code	Error Message	Description
1 beep	Refresh	Circuits have been reset (Ready to power up)
5 short, 1 long	Memory error	No memory detected in system
5 long, 2 short	Display memory read/write error	Video adapter missing or with faulty memory
1 long continuous	System OH	System overheat condition

A.2 Additional BIOS POST Codes

The AMI BIOS supplies additional checkpoint codes, which are documented online at https://www.supermicro.com/manuals/other/AMI_AptioV_BIOS_POST_Codes_for_SM_Motherboards.pdf ("AMI BIOS POST Codes User's Guide").

When BIOS performs the Power On Self Test, it writes checkpoint codes to I/O port 0080h. If the computer cannot complete the boot process, a diagnostic card can be attached to the computer to read I/O port 0080h (Supermicro p/n AOM-SPI80-V).

For information on AMI updates, please refer to <http://www.ami.com/products/>.

Appendix B

Software

B.1 Driver Installation

The Supermicro website that contains drivers and utilities for your system is at <https://www.supermicro.com/wdl/driver/>. Some of these must be installed, such as the chipset driver.

After accessing the website, go into the CDR_Images (in the parent directory of the above link) and locate the ISO file for your motherboard. Download this file to a USB flash drive or a DVD. (You may also use a utility to extract the ISO file if preferred.)

Another option is to go to the Supermicro website at <http://www.supermicro.com/products/>. Find the product page for your motherboard and download the latest drivers and utilities. Insert the flash drive or disk and the screenshot shown below should appear.

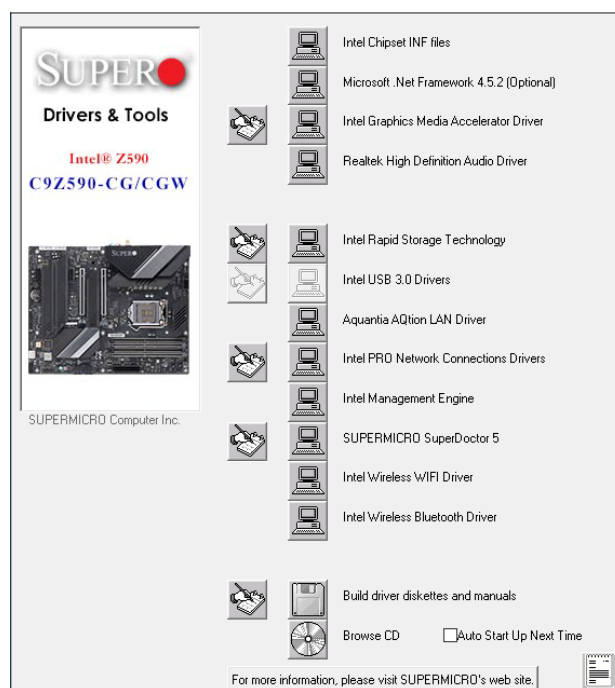



Figure B-1. Driver & Tool Installation Screen

 **Note:** Click the icons showing a hand writing on paper to view the readme files for each item. Click the computer icons to the right of these items to install each item (from top to bottom) one at a time. **After installing each item, you must reboot the system before moving on to the next item on the list.** The bottom icon with a CD on it allows you to view the entire contents.

B.2 SuperDoctor 5

The Supermicro SuperDoctor 5 is a program that functions in a command-line or web-based interface for Windows and Linux operating systems. The program monitors such system health information as CPU temperature, system voltages, system power consumption, fan speed, and provides alerts via email or Simple Network Management Protocol (SNMP).

SuperDoctor 5 comes in local and remote management versions and can be used with Nagios to maximize your system monitoring needs. With SuperDoctor 5 Management Server (SSM Server), you can remotely control power on/off and reset chassis intrusion for multiple systems with SuperDoctor 5 or IPMI. SuperDoctor 5 Management Server monitors HTTP and SMTP services to optimize the efficiency of your operation.

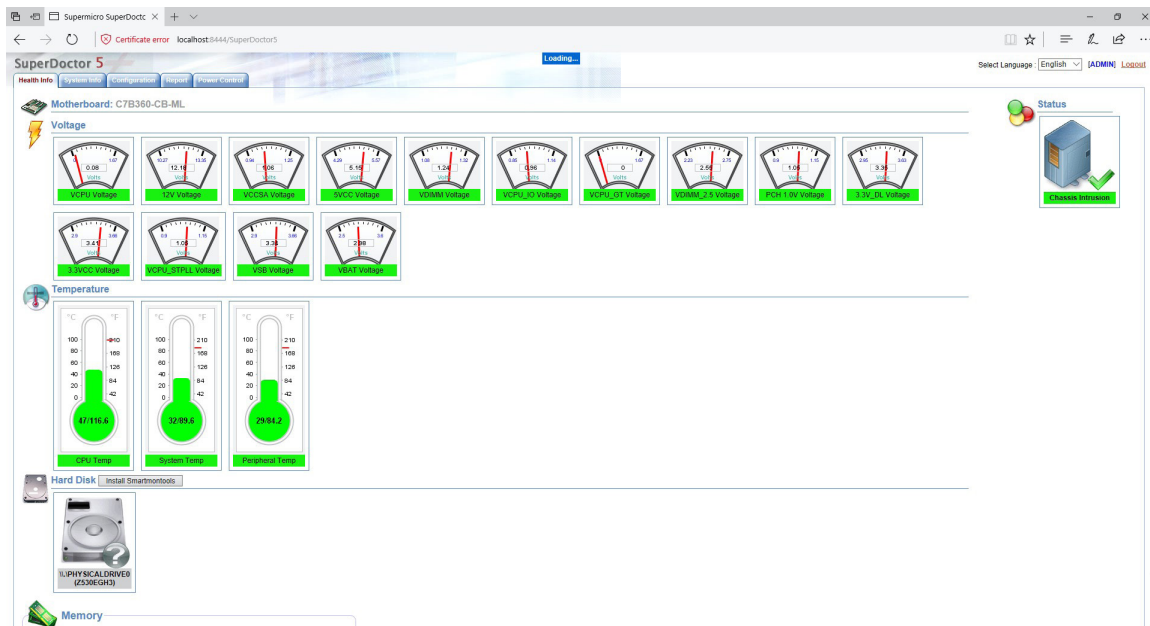

Figure B-2. SuperDoctor 5 Interface Display Screen (Health Information)

Appendix C

Standardized Warning Statements

The following statements are industry standard warnings, provided to warn the user of situations which have the potential for bodily injury. Should you have questions or experience difficulty, contact Supermicro's Technical Support department for assistance. Only certified technicians should attempt to install or configure components.

Read this section in its entirety before installing or configuring components.

These warnings may also be found on our website at http://www.supermicro.com/about/policies/safety_information.cfm.

Battery Handling



Warning! There is the danger of explosion if the battery is replaced incorrectly. Replace the battery only with the same or equivalent type recommended by the manufacturer. Dispose of used batteries according to the manufacturer's instructions

電池の取り扱い

電池交換が正しく行われなかった場合、破裂の危険性があります。交換する電池はメーカーが推奨する型、または同等のものを使用下さい。使用済電池は製造元の指示に従って処分して下さい。

警告

電池更換不當會有爆炸危險。請只使用同類電池或製造商推薦的功能相當的電池更換原有電池。請按製造商的說明處理廢舊電池。

警告

電池更換不當會有爆炸危險。請使用製造商建議之相同或功能相當的電池更換原有電池。請按照製造商的說明指示處理廢棄舊電池。

Warnung

Bei Einsetzen einer falschen Batterie besteht Explosionsgefahr. Ersetzen Sie die Batterie nur durch den gleichen oder vom Hersteller empfohlenen Batterietyp. Entsorgen Sie die benutzten Batterien nach den Anweisungen des Herstellers.

Attention

Danger d'explosion si la pile n'est pas remplacée correctement. Ne la remplacer que par une pile de type semblable ou équivalent, recommandée par le fabricant. Jeter les piles usagées conformément aux instructions du fabricant.

¡Advertencia!

Existe peligro de explosión si la batería se reemplaza de manera incorrecta. Reemplazar la batería exclusivamente con el mismo tipo o el equivalente recomendado por el fabricante. Desechar las baterías gastadas según las instrucciones del fabricante.

אזהרה!

קיימת סכנת פיצוץ של הסוללה במידה והוחלפה בדרך לא תקינה. יש להחליף את הסוללה בסוג התואם מחברת יצרן מומלצת. סילוק הסוללות המשומשות יש לבצע לפי הוראות היצרן.

هناك خطر من انفجار في حالة اسبدال البطارية بطريقة غير صحيحة فعلياً
اسبدال البطارية
فقط بنفس النوع أو ما يعادلها مما أوصت به الشركة المصنعة
جخلص من البطاريات المسعملة وفقاً لتعليمات الشركة الصانعة

경고!

배터리가 올바르게 교체되지 않으면 폭발의 위험이 있습니다. 기존 배터리와 동일하거나 제조사에서 권장하는 동등한 종류의 배터리로만 교체해야 합니다. 제조사의 안내에 따라 사용된 배터리를 처리하여 주십시오.

Waarschuwing

Er is ontploffingsgevaar indien de batterij verkeerd vervangen wordt. Vervang de batterij slechts met hetzelfde of een equivalent type die door de fabrikant aanbevolen wordt. Gebruikte batterijen dienen overeenkomstig fabrieksvoorschriften afgevoerd te worden.

Product Disposal



Warning! Ultimate disposal of this product should be handled according to all national laws and regulations.

製品の廃棄

この製品を廃棄処分する場合、国の関係する全ての法律・条例に従い処理する必要があります。

警告

本产品的废弃处理应根据所有国家的法律和规章进行。

警告

本產品的廢棄處理應根據所有國家的法律和規章進行。

Warnung

Die Entsorgung dieses Produkts sollte gemäß allen Bestimmungen und Gesetzen des Landes erfolgen.

¡Advertencia!

Al deshacerse por completo de este producto debe seguir todas las leyes y reglamentos nacionales.

Attention

La mise au rebut ou le recyclage de ce produit sont généralement soumis à des lois et/ou directives de respect de l'environnement. Renseignez-vous auprès de l'organisme compétent.

סילוק המוצר

אזהרה!

סילוק סופי של מוצר זה חייב להיות בהתאם להנחיות וחוקי המדינה.

عند التخلص النهائي من هذا المنتج ينبغي التعامل معه وفقا لجميع القوانين واللوائح الوطنية

경고!

이 제품은 해당 국가의 관련 법규 및 규정에 따라 폐기되어야 합니다.

Waarschuwing

De uiteindelijke verwijdering van dit product dient te geschieden in overeenstemming met alle nationale wetten en reglementen.

Appendix D

UEFI BIOS Recovery

Warning: Do not upgrade the BIOS unless your system has a BIOS-related issue. Flashing the wrong BIOS can cause irreparable damage to the system. In no event shall Supermicro be liable for direct, indirect, special, incidental, or consequential damages arising from a BIOS update. If you need to update the BIOS, do not shut down or reset the system while the BIOS is updating to avoid possible boot failure.

D.1 Overview

The Unified Extensible Firmware Interface (UEFI) provides a software-based interface between the operating system and the platform firmware in the pre-boot environment. The UEFI specification supports an architecture-independent mechanism that will allow the UEFI OS loader stored in an external storage device to boot the system. The UEFI offers clean, hands-off management to a computer during system boot.

D.2 Recovering the UEFI BIOS Image

A UEFI BIOS flash chip consists of a recovery BIOS block and a main BIOS block (a main BIOS image). The recovery block contains critical BIOS codes, including memory detection and recovery codes for the user to flash a healthy BIOS image if the original main BIOS image is corrupted. When the system power is turned on, the recovery block codes execute first. Once this process is complete, the main BIOS code will continue with system initialization and the remaining POST (Power-On Self-Test) routines.



Note 1: Follow the BIOS recovery instructions in Section D.3 for BIOS recovery when the main BIOS block crashes.

Note 2: If the recovery block processes stated in Section D.3 fail, you will need to follow the procedures to make a Returned Merchandise Authorization (RMA) request. Refer to Section 3.5 for more information about the RMA request.

D.3 Recovering the Main BIOS Block with a USB Device

This feature allows the user to recover the main BIOS image using a USB-attached device without additional utilities used. A USB flash device such as a USB Flash Drive, or a USB CD/DVD ROM/RW device can be used for this purpose. However, a USB hard disk drive cannot be used for BIOS recovery at this time. The file system supported by the recovery block is FAT (including FAT12, FAT16, and FAT32) which is installed on a bootable or non-bootable USB-attached device.

To perform UEFI BIOS recovery using a USB-attached device, follow the instructions below.

1. Please use a different machine to download the BIOS package for your motherboard or your system from the product page available on our website at www.supermicro.com.
2. Extract the BIOS package to a USB device and rename the BIOS ROM file [BIOSname#.###] that is included in the BIOS package to SUPER.ROM for BIOS recovery use.
3. Copy the SUPER.ROM file into the Root "\\" directory of the USB device.

 **Note:** Before recovering the main BIOS image, confirm that the SUPER.ROM file you have is the same version or a close version meant for your motherboard.

4. Insert the USB device that contains the SUPER.ROM file into the system before you power on the system.
5. After locating the SUPER.ROM file, the system will enter the BIOS Recovery menu as shown below.

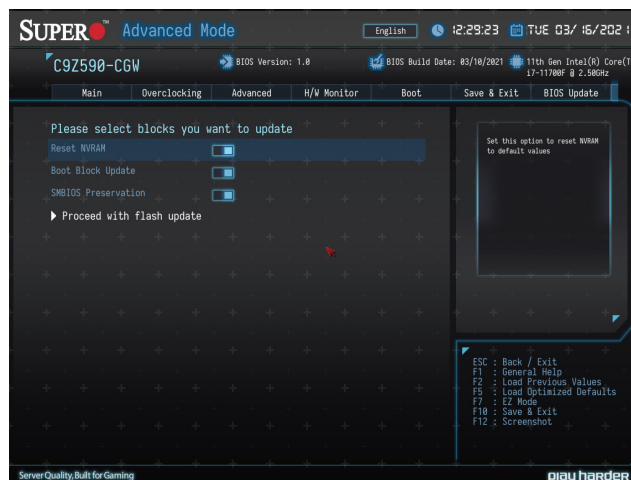

 **Note:** At this point, you may decide if you want to start the BIOS recovery. If you decide to proceed with BIOS recovery, follow the procedures below.

6. When the screen as shown above displays, use the arrow keys to select the item "Proceed with flash update" and press the <Enter> key. A progress bar will appear on the screen and indicate the update procedure is ongoing.

 **Note:** Do not interrupt the BIOS flashing process until it is completed.

7. After the BIOS recovery process is complete, press any key to reboot the system.

 **Note:** It is recommended that you update your BIOS after BIOS recovery. Please refer to Chapter 3 for BIOS update instructions.

8. Press during system boot to enter the BIOS Setup utility. From the top of the tool bar, select Boot to enter the submenu. From the submenu list, select Boot Option #1 as shown below. Then, set Boot Option #1 to [UEFI AP:UEFI: Built-in EFI Shell]. Press <F4> to save the settings and exit the BIOS Setup utility.

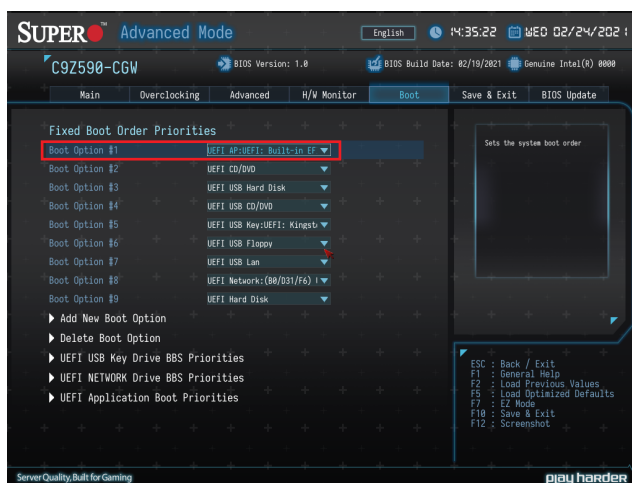

9. When the UEFI Shell prompt appears, type `fs#` to change the device directory path. Go to the directory that contains the BIOS package you extracted earlier in Step 2. Enter `flash.nsh BIOSname#.###` at the prompt to start the BIOS update process.

```
UEFI Interactive Shell v2.1
EDK II
UEFI v2.50 (American Megatrends, 0x0005000C)
Mapping Table
  FSD: Alias(s):HD0r0b:BLK1:
    PciRoot(0x0)/Pci(0x14,0x0)/USB(0x11,0x0)/HD(1,MBR,0x37901D72,0x800,0x1
C9559)
  BLK0: Alias(s):
    PciRoot(0x0)/Pci(0x14,0x0)/USB(0x11,0x0)
Press ESC in 1 seconds to skip startup.nsh or any other key to continue.
Shell # [FS0]
FS0:\> cd \EFI\UEFI
FS0:\EFI\UEFI> cd SHJPM2_03162017
FS0:\EFI\UEFI\SHJPM2_03162017> flash.nsh X110P07.314
```

 **Note:** Do not interrupt this process until the BIOS flashing is complete.

```
Done.
[ Access Cmos Port Ex ]
<Read>
Index 0x51: 0x10

Done.
*****
*
* Program BIOS and ME (including FDT) regions...
*
*****
| AMI Firmware Update Utility v5.09.01.1317
| Copyright (C)2017 American Megatrends Inc. All Rights Reserved.
|-----|
CPUID = 50652

Reading flash ..... done
- ME Data Size checking .. ok
- FR3 checksum ..... ok
- Check Rom_Layout ..... Ok.
Erasing Boot Block ..... done
Updating Boot Block ..... done
Verifying Boot Block ..... done
Erasing Main Block ..... 0x00132000 (0x)
```

