

SUPERMICRO[®]

SBI-7126T-S6 Blade Module



User's Manual

Revision 1.0a

The information in this User's Manual has been carefully reviewed and is believed to be accurate. The vendor assumes no responsibility for any inaccuracies that may be contained in this document, makes no commitment to update or to keep current the information in this manual, or to notify any person or organization of the updates. **Please Note: For the most up-to-date version of this manual, please see our web site at www.supermicro.com.**

Super Micro Computer, Inc. ("Supermicro") reserves the right to make changes to the product described in this manual at any time and without notice. This product, including software and documentation, is the property of Supermicro and/or its licensors, and is supplied only under a license. Any use or reproduction of this product is not allowed, except as expressly permitted by the terms of said license.

IN NO EVENT WILL SUPERMICRO BE LIABLE FOR DIRECT, INDIRECT, SPECIAL, INCIDENTAL, SPECULATIVE OR CONSEQUENTIAL DAMAGES ARISING FROM THE USE OR INABILITY TO USE THIS PRODUCT OR DOCUMENTATION, EVEN IF ADVISED OF THE POSSIBILITY OF SUCH DAMAGES. IN PARTICULAR, SUPERMICRO SHALL NOT HAVE LIABILITY FOR ANY HARDWARE, SOFTWARE, OR DATA STORED OR USED WITH THE PRODUCT, INCLUDING THE COSTS OF REPAIRING, REPLACING, INTEGRATING, INSTALLING OR RECOVERING SUCH HARDWARE, SOFTWARE, OR DATA.

Any disputes arising between manufacturer and customer shall be governed by the laws of Santa Clara County in the State of California, USA. The State of California, County of Santa Clara shall be the exclusive venue for the resolution of any such disputes. Super Micro's total liability for all claims will not exceed the price paid for the hardware product.

FCC Statement: This equipment has been tested and found to comply with the limits for a Class A digital device pursuant to Part 15 of the FCC Rules. These limits are designed to provide reasonable protection against harmful interference when the equipment is operated in a commercial environment. This equipment generates, uses, and can radiate radio frequency energy and, if not installed and used in accordance with the manufacturer's instruction manual, may cause harmful interference with radio communications. Operation of this equipment in a residential area is likely to cause harmful interference, in which case you will be required to correct the interference at your own expense.

California Best Management Practices Regulations for Perchlorate Materials: This Perchlorate warning applies only to products containing CR (Manganese Dioxide) Lithium coin cells. Perchlorate Material-special handling may apply. See www.dtsc.ca.gov/hazardouswaste/perchlorate for further details.



WARNING: HANDLING OF LEAD SOLDER MATERIALS USED IN THIS PRODUCT MAY EXPOSE YOU TO LEAD, A CHEMICAL KNOWN TO THE STATE OF CALIFORNIA TO CAUSE BIRTH DEFECTS AND OTHER REPRODUCTIVE HARM.

Manual Revision 1.0a

Release Date: August 30, 2011

Unless you request and receive written permission from Super Micro Computer, Inc., you may not copy any part of this document.

Information in this document is subject to change without notice. Other products and companies referred to herein are trademarks or registered trademarks of their respective companies or mark holders.

Copyright © 2011 by Super Micro Computer, Inc.
All rights reserved.

Printed in the United States of America

Preface

About this Manual

This manual is written for professional system integrators, Information Technology professionals, service personnel and technicians. It provides information for the installation and use of Supermicro's SBI-7126T-S6 blade module. Installation and maintenance should be performed by experienced professionals only.

Manual Organization

Chapter 1: Introduction

The first chapter provides a checklist of the main components included with the SBI-7126T-S6 blade module and describes its main features.

Chapter 2: System Safety

You should familiarize yourself with this chapter for a general overview of safety precautions that should be followed when installing and servicing the SBI-7126T-S6 blade module.

Chapter 3: Setup and Installation

Refer to this chapter for details on installing the SBI-7126T-S6 blade module into the Superblade chassis. Other sections cover the installation and placement of memory modules and the installation of hard disk drives into the blade module.

Chapter 4: Blade Module Features

This chapter covers features and component information about the SBI-7126T-S6 blade module. Included here are descriptions and information for mainboard components, connectors, LEDs and other features of the blade module.

Chapter 5: RAID Setup Procedure

RAID setup and operations for the SBI-7126T-S6 blade module are covered in this chapter.

Chapter 6: BIOS

BIOS setup is covered in this chapter for the SBI-7126T-S6 blade module.

Appendix A: BIOS POST Codes

BIOS POST Codes for the SBI-7126T-S6 blade module are explained in this appendix.

Notes

Table of Contents

Chapter 1 Introduction	1-1
1-1 Overview.....	1-1
1-2 Product Checklist of Typical Components.....	1-1
1-3 Blade Module Features.....	1-2
Processors.....	1-2
Memory.....	1-2
Storage.....	1-3
Density.....	1-3
1-4 Contacting Supermicro.....	1-4
Chapter 2 System Safety	2-1
2-1 Electrical Safety Precautions.....	2-1
2-2 General Safety Precautions.....	2-2
2-3 Electrostatic Discharge Precautions.....	2-2
2-4 Operating Precautions.....	2-2
Chapter 3 Setup and Installation	3-1
3-1 Overview.....	3-1
3-2 Installing Blade Modules.....	3-1
Powering Up a Blade Unit.....	3-1
Powering Down a Blade Unit.....	3-1
Removing a Blade Unit from the Enclosure.....	3-1
Removing/Replacing the Blade Cover.....	3-2
Installing a Blade Unit into the Enclosure.....	3-2
3-3 Processor Installation.....	3-4
3-4 Onboard Battery Installation.....	3-5
3-5 Memory Installation.....	3-6
Populating Memory Slots.....	3-6
DIMM Installation.....	3-8
3-6 Hard Disk Drive Installation.....	3-9
3-7 Installing the Operating System.....	3-11
Installing with an External USB CD-ROM Drive.....	3-11
Installing via PXE Boot.....	3-11
Installing via Virtual Media (Drive Redirection).....	3-12
3-8 Management Software.....	3-12

3-9 Configuring and Setting up RAID	3-12
Chapter 4 Blade Module Features	4-1
4-1 Control Panel	4-2
Power Button	4-3
KVM Button	4-3
LED Indicators	4-3
KVM Connector	4-3
4-2 Mainboard	4-4
Jumpers	4-6
CMOS Clear	4-6
4-3 Blade Unit Components	4-7
Memory Support	4-8
Hard Disk Drives	4-8
Chapter 5 RAID Setup Procedure	5-1
Chapter 6 BIOS	6-1
6-1 Introduction	6-1
System BIOS	6-1
How To Change the Configuration Data	6-1
Starting the Setup Utility	6-1
6-2 BIOS Updates	6-2
Flashing BIOS	6-2
6-3 Running Setup	6-3
6-4 Main BIOS Setup	6-4
6-5 Advanced Setup	6-5
6-6 Security	6-15
6-7 Boot	6-17
6-8 Exit	6-19
6-9 Hardware Health Information	6-20
CPU Temperature	6-20
System Temperature	6-21
Voltage Monitoring	6-21

Appendix A BIOS POST Codes	A-1
A-1 BIOS POST Messages	A-1
A-2 BIOS POST Codes.....	A-3
Recoverable POST Errors	A-4
Terminal POST Errors.....	A-4

Notes

List of Figures

Figure 1-1. Full Rack of Blade Enclosures and Blade Servers	1-3
Figure 3-1. Inserting a Blade into the Enclosure	3-3
Figure 3-2. Locking the Blade into Position.....	3-3
Figure 3-3. Installing a Processor in a Socket.....	3-5
Figure 3-4. Installing the Onboard Battery	3-6
Figure 3-5. 12-Slot DIMM Numbering	3-7
Figure 3-6. Installing a DIMM into a Memory Slot.....	3-8
Figure 3-7. Installing a Hard Drive in a Carrier.....	3-10
Figure 4-1. SBI-7126T-S6 Blade Module Front View.....	4-1
Figure 4-2. Blade Control Panel.....	4-2
Figure 4-3. B8DT6 Mainboard.....	4-4
Figure 4-4. Intel 5500 Tylersburg Chipset Block Diagram	4-5
Figure 4-5. Exploded View of SBI-7126T-S6 Blade Module	4-7
Figure 6-1. Main Setup Menu Screen	6-4
Figure 6-2. Advanced Setup Menu	6-5
Figure 6-3. Security Setup Menu	6-15
Figure 6-4. Boot Setup Menu	6-17
Figure 6-5. Exit Setup Menu	6-19

Notes

List of Tables

Table 1-1. SBI-7126T-S6 Blade Specification Features	1-2
Table 3-1. Populating Twelve Memory Slots for Interleaved Operation.....	3-6
Table 4-1. SBI-7126T-S6 Blade Module Features.....	4-1
Table 4-2. Blade Control Panel.....	4-2
Table 4-3. Blade Module LED Indicators	4-3
Table 4-4. B8DT6 Mainboard Layout.....	4-5
Table 4-5. Main Components of SBI-7126T-S6 Blade Module.....	4-7
Table 6-1. Main BIOS Setup Menu Options.....	6-5
Table 6-2. Advanced Setup Menu Options	6-6
Table 6-3. CPU and Clock Configuration Sub-menu	6-7
Table 6-4. IDE Configuration Menu.....	6-7
Table 6-5. PCIPnP Configuration Sub-menu	6-8
Table 6-6. SuperIO Configuration Sub-menu.....	6-9
Table 6-7. Chipset Configuration Sub-menu.....	6-9
Table 6-8. ACPI Configuration Sub-menu.....	6-11
Table 6-9. AHCI Configuration Sub-menu	6-12
Table 6-10. Event Log Configuration Sub-menu.....	6-12
Table 6-11. IPMI Configuration Sub-menu.....	6-12
Table 6-12. MPS Configuration Sub-menu	6-14
Table 6-13. PCI Express Configuration Sub-menu.....	6-14
Table 6-14. SMBIOS Configuration Sub-menu.....	6-14
Table 6-15. Remote Access Configuration Sub-menu.....	6-14
Table 6-16. System Health Monitor Sub-menu.....	6-15
Table 6-17. Security Menu Options.....	6-16
Table 6-18. Boot Setup Menu Options.....	6-17
Table 6-19. Exit Menu Options.....	6-19
Table A-1. BIOS POST Messages.....	A-1
Table A-2. Terminal POST Errors	A-4
Table A-3. Boot Block Flash ROM Terminal POST Errors.....	A-8

Notes

Chapter 1

Introduction

1-1 Overview

The SBI-7126T-S6 blade module is a compact self-contained server that connects into a pre-cabled enclosure that provides power, cooling, management and networking functions. One enclosure for the SBI-7126T-S6 blade module can hold ten blade units.

In this manual, “blade system” refers to the entire system (including the enclosure and blades units), “blade” or “blade unit” refers to a single blade module and “blade enclosure” is the chassis that the blades, power supplies and modules are housed in.

Please refer to our web site for information on operating systems that have been certified for use with the SuperBlade (www.supermicro.com/products/superblade/).

1-2 Product Checklist of Typical Components

Your blade module ships with its mainboard already installed in its chassis. Memory, hard disk drives and the CPU must all be installed by the user after shipment. See [Chapter 3: "Setup and Installation" on page 3-1](#) for details on installation of these components.

Additionally, you may require a key for the J1BTN1 RAID 5 connector on your blade's mainboard in order to activate RAID 5 configurations for your blade.

Aside from the blade module unit itself, the following optional Mezzanine add-on cards may be ordered for your blade module:

For Infiniband Switch:

- AOC-IBH-XDD
- AOC-IBH-XDS
- AOC-IBH-XQS
- AOC-IBH-XQD

For 10G Switch:

- AOC-XEH-iN2

See the [Supermicro website](#) and the *Superblade Network Modules User's Manual* on your Superblade system's CD-ROM for more details on these add-on cards including instructions on how to install them.



NOTE: Some of these add-on cards may not be available at the time of this manual's publication. Please refer to the [Supermicro website](#) for their availability.

1-3 Blade Module Features

Table 1-1 lists the main features of the SBI-7126T-S6 blade module. See the proceeding section for components typically included in a blade system and other optional components. Specific details on the SBI-7126T-S6 blade module is found in [Chapter 4: "Blade Module Features" on page 4-1](#).

Table 1-1. SBI-7126T-S6 Blade Specification Features

Mainboard	B8DT6 (proprietary form factor) Chassis Dimensions (HxWxD): 11.32" x 1.67" x 18.9"
Processors	Single or dual Intel™ Xeon® 5500/5600 series processors. Please refer to our web site for a complete listing of supported processors.
FSB Speed	1333/1066/800 MHz front side (system) bus speed
Chipset	Intel 5500 Tylersburg
Graphics Controller	Hermon
BIOS	32 MB SPI Flash EEPROM with AMI® BIOS
Memory Capacity	Twelve 240-pin DIMM sockets supporting up to 192GB/48GB of ECC Registered/Unbuffered ECC DDR3-1333/1066/800 SDRAM.
Drive Controller	LSI SAS2 on-board controller for six SAS(2) or SATA
Hard Drive Bays	Six (6) hot-swap drive bays for 2.5" SAS(2) or SATA disk drives

Processors

The SBI-7126T-S6 blade module supports up to dual 1366-pin Intel Xeon 5500/5600 series processors.

Refer to the Supermicro web site for a complete listing of supported processors (<http://www.supermicro.com/products/superblade>). Please note that you will need to check the detailed specifications of a particular blade module for a list of the CPUs it supports.

Details on installation of the processor into the SBI-7126T-S6 blade module are found in [Chapter 3: "Setup and Installation" on page 3-1](#).

Memory

The SBI-7126T-S6 blade module has twelve 240-pin DIMM sockets that can support up to 192GB/48GB of ECC Registered/Unbuffered ECC DDR3-1333/1066/800 SDRAM. Memory is interleaved, which requires modules of the same size and speed to be installed in groups (of two or three).

Please refer to the Supermicro web site for a list of supported memory (www.supermicro.com/products/superblade). The detailed specifications for a blade module will contain a link to a list of recommended memory sizes and manufacturers.

Details on installation of memory modules into the SBI-7126T-S6 blade module are found in [Chapter 3: "Setup and Installation" on page 3-1](#).

Storage

The SBI-7126T-S6 blade module can have six 2.5" SAS(2) or SATA (Serial ATA) hard disk drives in front-mounted easy removable carriers. See [Chapter 3: "Setup and Installation" on page 3-1](#) for storage installation details.

Density

A maximum of ten blade modules may be installed into a single blade enclosure. Each blade enclosure is a 7U form factor, so a standard 42U rack may accommodate up to six enclosures with sixty blade modules, or the equivalent of sixty 1U servers. With the inclusion of six CMM modules, twelve Gigabit Ethernet switches and six InfiniBand switches, this would occupy up to 108U space in a conventional 1U server configuration.

[Figure 1-1](#) displays a view of a full rack with six blade enclosures in it, each with ten blades to an enclosure.

Figure 1-1. Full Rack of Blade Enclosures and Blade Servers



1-4 Contacting Supermicro

Headquarters

Address: Super Micro Computer, Inc.
980 Rock Ave.
San Jose, CA 95131 U.S.A.

Tel: +1 (408) 503-8000

Fax: +1 (408) 503-8008

Email: marketing@supermicro.com (General Information)
support@supermicro.com (Technical Support)

Web Site: www.supermicro.com

Europe

Address: Super Micro Computer B.V.
Het Sterrenbeeld 28, 5215 ML
's-Hertogenbosch, The Netherlands

Tel: +31 (0) 73-6400390

Fax: +31 (0) 73-6416525

Email: sales@supermicro.nl (General Information)
support@supermicro.nl (Technical Support)
rma@supermicro.nl (Customer Support)

Asia-Pacific

Address: Super Micro Computer, Inc.
4F, No. 232-1, Liancheng Rd.
Chung-Ho 235, Taipei County
Taiwan, R.O.C.

Tel: +886-(2) 8226-3990

Fax: +886-(2) 8226-3991

Web Site: www.supermicro.com.tw

Technical Support:

Email: support@supermicro.com.tw

Tel: +886-2-8228-1366, ext. 132 or 139

Chapter 2

System Safety

2-1 Electrical Safety Precautions

Basic electrical safety precautions should be followed to protect yourself from harm and the SuperBlade from damage:

- Be aware of how to power on/off the enclosure power supplies and the individual blades as well as the room's emergency power-off switch, disconnection switch or electrical outlet. If an electrical accident occurs, you can then quickly remove power from the system.
- Do not work alone when working with high voltage components.
- Power should always be disconnected from the blade module when removing or installing such system components as the mainboard, memory modules and processors.
- When working around exposed electrical circuits, another person who is familiar with the power-off controls should be nearby to switch off the power if necessary.
- Use only one hand when working with powered-on electrical equipment. This is to avoid making a complete circuit, which will cause electrical shock. Use extreme caution when using metal tools, which can easily damage any electrical components or circuit boards they come into contact with.
- Do not use mats designed to decrease electrostatic discharge as protection from electrical shock. Instead, use rubber mats that have been specifically designed as electrical insulators.
- The power supply power cords must include a grounding plug and must be plugged into grounded electrical outlets. Power input requires 110-240 VAC, depending upon your power supply module.
- Mainboard Battery: This battery must be replaced only with the same or an equivalent type recommended by the manufacturer (CR2032 Lithium 3V battery). Dispose of used batteries according to the manufacturer's instructions.



WARNING: There is a danger of explosion if the onboard battery is installed upside down, which will reverse its polarities.

- Mainboard replaceable soldered-in fuses: Self-resetting PTC (Positive Temperature Coefficient) fuses on the mainboard must be replaced by trained service technicians only. The new fuse must be the same or equivalent as the one replaced. Contact technical support for details and support.

2-2 General Safety Precautions

Follow these rules to ensure general safety:

- Keep the area around the SuperBlade clean and free of clutter.
- Place the blade module cover and any system components that have been removed away from the system or on a table so that they won't accidentally be stepped on.
- While working on the system, do not wear loose clothing such as neckties and unbuttoned shirt sleeves, which can come into contact with electrical circuits or be pulled into a cooling fan.
- Remove any jewelry or metal objects from your body, which are excellent metal conductors that can create short circuits and harm you if they come into contact with printed circuit boards or areas where power is present.
- After accessing the inside of the system, replace the blade module's cover before installing it back into the blade enclosure.

2-3 Electrostatic Discharge Precautions

Electrostatic discharge (ESD) is generated by two objects with different electrical charges coming into contact with each other. An electrical discharge is created to neutralize this difference, which can damage electronic components and printed circuit boards.

The following measures are generally sufficient to neutralize this difference **before** contact is made to protect your equipment from ESD:

- Use a grounded wrist strap designed to prevent static discharge.
- Keep all components and printed circuit boards (PCBs) in their antistatic bags until ready for use.
- Touch a grounded metal object before removing the board from the antistatic bag.
- Do not let components or PCBs come into contact with your clothing, which may retain a charge even if you are wearing a wrist strap.
- Handle a board by its edges only; do not touch its components, peripheral chips, memory modules or contacts.
- When handling chips or modules, avoid touching their pins.
- Put the mainboard and peripherals back into their antistatic bags when not in use.
- For grounding purposes, make sure the blade enclosure provides excellent conductivity between the power supplies, the blade modules and the mainboard.

2-4 Operating Precautions

Care must be taken to assure that the cover of the blade unit is in place when the blade is operating to assure proper cooling. Out of warranty damage to the blade can occur if this practice is not strictly followed.

Any drive carrier without a hard drive installed must remain fully installed in the drive bay when the blade module is operating to ensure proper airflow.

Chapter 3

Setup and Installation

3-1 Overview

This chapter covers the setup and installation of the blade module and its components.

3-2 Installing Blade Modules

Up to ten SBI-7126T-S6 blade modules may be installed into a single blade enclosure (depending upon your enclosure and blade). Blade modules with Windows and Linux operating systems may be mixed together in the same blade enclosure.

Powering Up a Blade Unit

Each blade unit may be powered on and off independently from the rest of the blades installed in the same enclosure. A blade unit may be powered up in two ways:

- Press the power button on the blade unit.
- Use IPMIView or the web-browser based management utility to apply power using either a CMM module, or by the use of the onboard BMC chip in the blade module.

Powering Down a Blade Unit

A blade unit may be powered down in either of five ways:

- Press the power button on the blade unit.
- Use IPMIView or the web-browser based management utility to power down (if you have Operator or Admin privileges on the CMM).
- Use IPMItool when connected to the CMM to power down (if you have Operator or Admin privileges on the CMM).
- Use IPMIview or a browser connected to the onboard BMC chip attached to the blade to power down.
- Use IPMItool to use a Command Line Interface (CLI) to the onboard BMC chip (if you have Operator or Admin privileges).

Removing a Blade Unit from the Enclosure

Although the blade system may continue to run, individual blades should always be powered down before removing them from the enclosure.

Removing a Blade Unit from the Enclosure

1. Power down the blade unit (see "[Powering Down a Blade Unit](#)" above).
2. Squeeze both handles to depress the red sections then pull out both handles completely and use them to pull the blade unit from the enclosure.



NOTE: Blade Modules can be Hot-Plugged from the enclosure.

Removing/Replacing the Blade Cover

The blade cover must be removed to access the mainboard when you need to install or remove processors, memory units, the onboard battery and so on.

Removing/Replacing the Blade Cover

1. Remove the blade unit from the enclosure (see "[Removing a Blade Unit from the Enclosure](#)" above).
2. Depress the two buttons on the cover while pushing the cover toward the rear of the blade unit. When it stops, lift the cover off the blade unit.
3. To replace the cover, fit the six grooves in the cover into the studs in the sides of the blade, then slide the cover toward the front of the blade to lock it into place.

Installing a Blade Unit into the Enclosure

Make sure the cover of the blade unit has been replaced first before installing a blade unit in the enclosure.

Installing a Blade Unit into the Enclosure

1. Slowly push the blade unit into its bay with the handles fully pulled out (see [Figure 3-1](#)).
2. When the blade stops, push the handles back in to their locked position, making sure the notches in both handles catch the lip of the enclosure (see [Figure 3-2](#)).



NOTE: Blade Modules can be Hot-Plugged into the enclosure.



WARNING: Use extreme caution when inserting a blade module into the enclosure. If the blade's power connector becomes damaged, it can damage pins on other blade bays that it is inserted into.

Figure 3-1. Inserting a Blade into the Enclosure

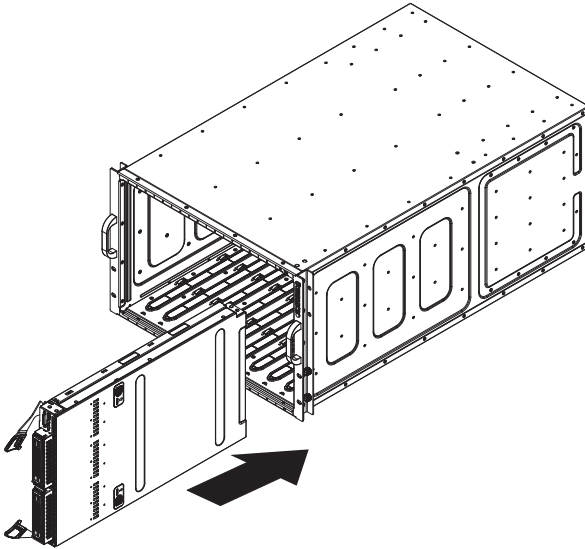
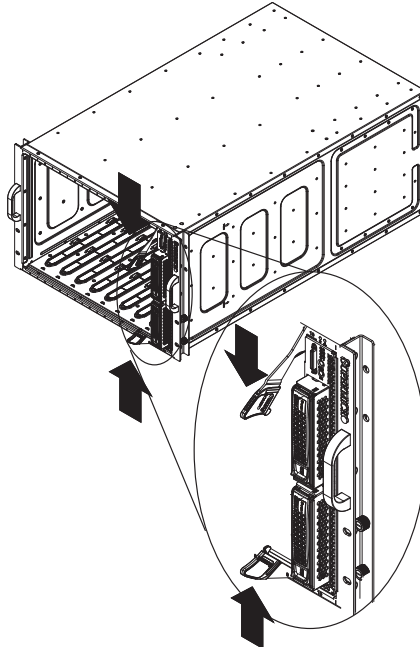

Figure 3-2. Locking the Blade into Position



3-3 Processor Installation

One or two processors may be installed to the mainboard of each blade unit. See [Chapter 1](#) for general information on the features of the blade unit and the [Supermicro web site](#) for further details including processor, memory and operating system support.



WARNING: This action should only be performed by a trained service technician. Allow the processor heatsink to cool before removing it.

Removing a Processor

1. Power down and remove the blade unit from the enclosure (see [Section 3-2: Installing Blade Modules on page 3-1](#) for details).
2. Remove the cover of the blade unit (see "[Removing/Replacing the Blade Cover](#)" on [page 3-2](#)).
3. Loosen the four screws that secure the heatsink to the mainboard.
4. Remove the heatsink by *gently* rotating it back-and-forth sideways with your fingers to release it from the processor. Set the heatsink aside and upside-down so that nothing comes into contact with the thermal grease on its underside.
5. Raise the lever of the processor socket up until the processor is released from the socket, then lift the silver cover plate and remove the processor.



WARNING: This action should only be performed by a trained service technician.

Installing a Processor

1. If present, remove the protective black PnP cap from the processor socket.
2. Raise the lever of the processor socket until it reaches its upper limit.
3. Lift the silver cover plate completely up and out of the way.



NOTE: Be careful not to damage the pins protruding from the CPU socket.

4. Align pin 1 of the processor with pin 1 of the socket (both are marked with a small gold triangle) and gently seat the processor into the socket ([Figure 3-3](#)).
5. Check to make sure the processor is flush to the socket and fully seated.
6. Lower the socket lever until it locks.
7. To install the heatsink, apply thermal grease to the top of the processor. (If reinstalling a heatsink, first clean off the old thermal grease with a clean, lint-free cloth.)

- Place the heatsink on the processor then tighten two diagonal screws until snug, then the other two screws.
- When all four screws are snug, tighten them all to secure the heatsink to the mainboard.



NOTE: Do not overtighten the screws as this may damage the processor or the heatsink.

- Replace the cover on the blade unit and finish by installing the unit back into the blade enclosure.

Figure 3-3. Installing a Processor in a Socket

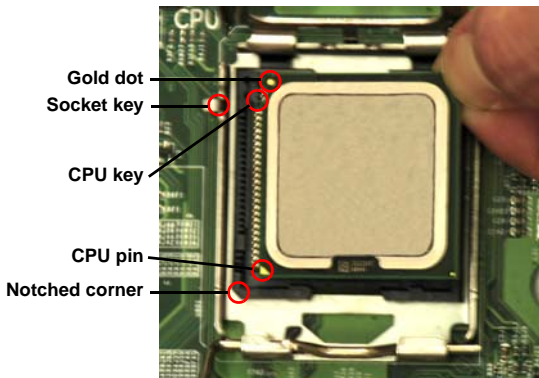

3-4 Onboard Battery Installation

A battery is included on the mainboard to supply certain volatile memory components with power when power has been removed from the blade module. If this battery dies, it must be replaced with an equivalent CR2032 Lithium 3V battery. Dispose of used batteries according to the manufacturer's instructions. See [Figure 3-4](#) for a diagram of installing a new onboard battery.



WARNING: There is a danger of explosion if the onboard battery is installed upside down, which reverses its polarities.

Figure 3-4. Installing the Onboard Battery

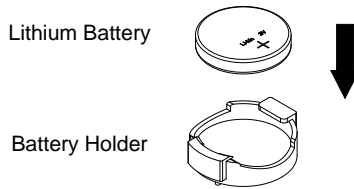

3-5 Memory Installation

The mainboard of each blade unit must be populated with DIMMs (Dual In-line Memory Modules) to provide system memory. **The DIMMs should all be of the same size and speed and from the same manufacturer due to compatibility issues.** See details below on supported memory and our web site (www.supermicro.com/products/superblade) for recommended memory.

Populating Memory Slots

The mainboard of a SBI-7126T-S6 blade module has twelve memory slots, depending upon the blade model. Both interleaved and non-interleaved memory are supported, so you may populate any number of DIMM slots.

Populating three slots at a time (DIMM1A + DIMM2A+ DIMM3A, etc.) with memory modules of the same size and of the same type will result in dual-channel, interleaved memory, which is faster than single-channel, non-interleaved memory. See [Table 3-1](#) and [Figure 3-5](#) for details.

For an interleaved configuration, memory modules of the same size and speed must be installed in pairs. You should not mix DIMMs of different sizes and speeds.

Table 3-1. Populating Twelve Memory Slots for Interleaved Operation

Number of DIMMs	Processor 1						Processor 2					
	Channel 0		Channel 1		Channel 2		Channel 0		Channel 1		Channel 2	
2 DIMMs	1A						1A					
4 DIMMs	1A		2A				1A		2A			
6 DIMMs	1A		2A		3A		1A		2A		3A	
8 DIMMs	1A	1B	2A		3A		1A	1B	2A		3A	
10 DIMM	1A	1B	2A	2B	3A		1A	1B	2A	2B	3A	
12 DIMM	1A	1B	2A	2B	3A	3B	1A	1B	2A	2B	3A	3B



NOTE: The DIMM slot number specified in [Table 3-1](#) equals the DIMM slot to be populated. A “---” indicates that the DIMM slot should be left unpopulated.



NOTE: Though multiple DIMM memory module types and speeds may be supported, you need to use DIMM memory modules of the same speed and type.

Figure 3-5. 12-Slot DIMM Numbering

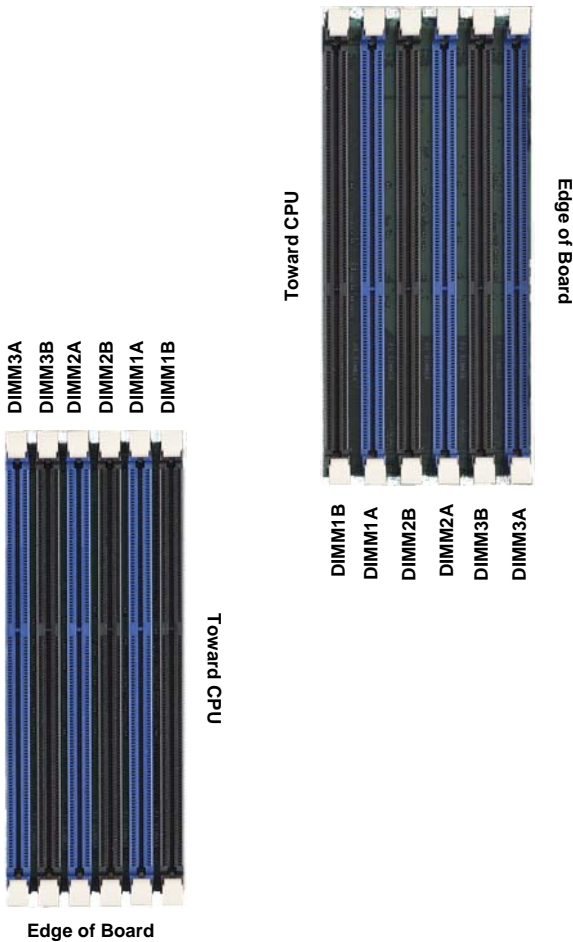

DIMM Installation



WARNING: Exercise extreme care when installing or removing DIMM modules to prevent any possible damage.

Installing DIMM Memory Modules

1. Power down the blade module (see ["Powering Down a Blade Unit" on page 3-1](#)).
2. Remove the blade from the enclosure and the cover from the blade (see ["Removing/Replacing the Blade Cover" on page 3-2](#)).
3. Remove the air shroud that covers the DIMM slots.
4. Insert each DIMM vertically into its slot, starting with slots 1A and 2A. Pay attention to the notch along the bottom of the module to prevent inserting the DIMM incorrectly (see [Figure 3-6](#)).

Figure 3-6. Installing a DIMM into a Memory Slot

To Install: Insert module vertically and press down until it snaps into place. Pay attention to the bottom notch.

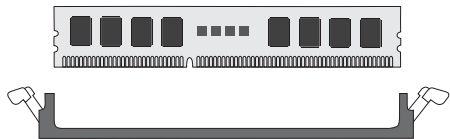

To Remove: Use your thumbs to gently push each release tab outward to free the DIMM from the slot.



5. Gently press down on the DIMM until it snaps into place in the slot. Repeat for all modules (see [Table 3-1](#) for installing DIMMs into the slots in the correct order).
6. Replace the air shroud and the blade cover and install the blade module back into the enclosure.
7. Power up the blade unit (see ["Powering Up a Blade Unit" on page 3-1](#)).

3-6 Hard Disk Drive Installation

Hard disk drives are installed in “carriers” which are hot-swappable and can be removed or replaced without powering down the blade unit they reside in. A blade module needs a hard disk drive with an operating system installed to operate.



WARNING: To maintain proper airflow, both hard drive bays must have drive carriers inserted during operation whether or not a drive is installed in the carrier.

To remove a hard drive carrier, do the following:

Removing a Hard Drive Carrier

1. Locate the colored “Open” button at the bottom of the drive carrier and press it with your thumb. This action releases the drive carrier from the drive bay.
2. Pull the release handle out about 45-degrees, then use it to pull the drive carrier out.

To Install a hard drive, use the following procedure:

Installing a Hard Drive

1. Remove a blank drive carrier from the blade (see removal procedure above).
2. Insert a drive into the carrier with the PCB side facing down and the connector end toward the rear of the carrier.
3. Align the drive in the carrier so that the screw holes of both line up. Note that there are holes in the carrier marked “SAS/SATA” to aid in correct installation.
4. Secure the drive to the carrier with four screws as shown in [Figure 3-7: "Installing a Hard Drive in a Carrier" on page 3-10](#).
5. Insert the drive carrier into its slot keeping the Open button at the bottom. When the carrier reaches the rear of the bay the release handle will retract.
6. Push the handle in until you hear the carrier click into its locked position.

Figure 3-7. Installing a Hard Drive in a Carrier

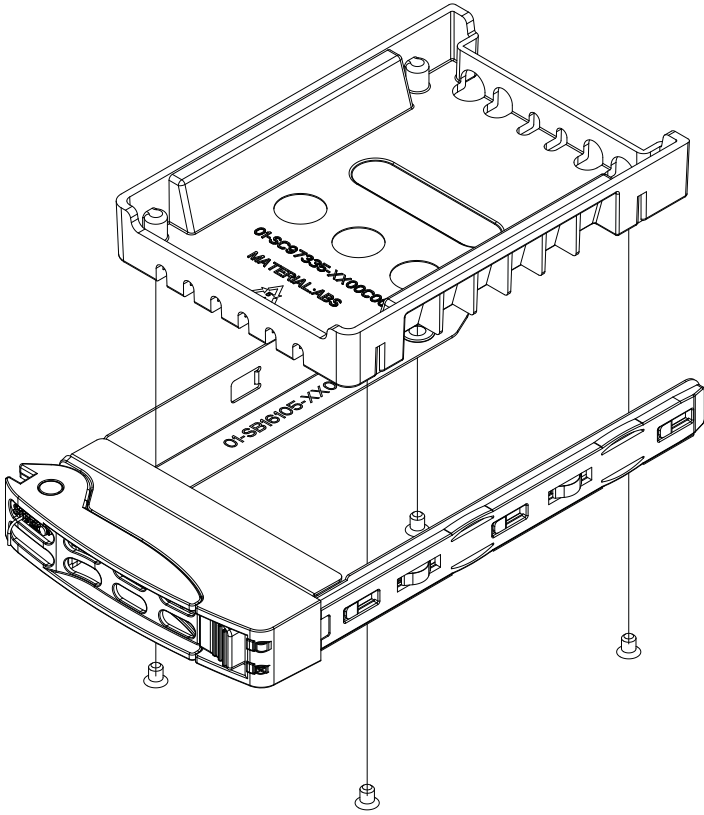

3-7 Installing the Operating System

An operating system (OS) must be installed on each blade module. Blades with Microsoft Windows OS and blades with Linux OS can both occupy and operate within the same blade enclosure. Refer to the SuperMicro web site for a complete list of supported operating systems.

There are several methods of installing an OS to the blade modules.

Installing with an External USB CD-ROM Drive

The most common method of installing the OS is with an external USB CD-ROM drive. Take the following steps to install the OS to a blade module:



WARNING: Installing the OS from an external CD-ROM drive may take several hours to complete.

1. Connect an SUV cable (Serial port/USB port/Video port cable) to the KVM connector on the front of the blade module. You will then need to attach a USB hub to the USB port on this cable to provide multiple USB ports.
2. Connect the external CD-ROM drive, a USB keyboard and a mouse to the USB hub. You will also need to connect a monitor to the video connector on the SUV cable. Turn on the blade module.
3. Insert the CD containing the OS into the CD-ROM drive.
4. Follow the prompts to begin the installation.

Installing via PXE Boot

PXE (Preboot Execution Environment) is used to boot a computer over a network. To install the OS via PXE, the following conditions must be met:

1. The PXE BOOT option in BIOS must be enabled.
2. A PXE server has been configured (this can be another blade in the system).
3. The PXE server must be connected over a network to the blade to be booted.
4. The blade has only non-partitioned/unformatted hard drives installed and no bootable devices attached to it.

Once these conditions are met, make sure the PXE server is running. Then turn on the blade on which you wish to boot and/or install the OS. The BIOS in the blade will look at all bootable devices and finding none will connect to the PXE server to begin the boot/install.

Notes

Installing via Virtual Media (Drive Redirection)

You can install the OS via Virtual Media through either the *IPMIview* (Java based client utility), *IPMITool* or the *Web-based Management Utility*. With this method, the OS is installed from an ISO image that resides on another system/blade.

Refer to the manuals on your Superblade CD-ROM for further details on the Virtual Media (CD-ROM or Drive Redirection) sections of these two utility programs.

3-8 Management Software

System management may be performed with either of three software packages: *IPMIview*, *IPMITool* or a *Web-based Management Utility*. These are designed to provide an administrator with a comprehensive set of functions and monitored data to keep tabs on the system and perform management activities.

Refer to the manuals on your Superblade CD-ROM for further details on the various functions provided by these management programs.

3-9 Configuring and Setting up RAID

Each blade module that supports two or more hard drives may be used to create a RAID array. The procedures for doing this vary depending upon the blade model chosen for your SuperBlade system.

See [Chapter 5](#) for details on how to configure and set up RAID on your blade module.

Chapter 4

Blade Module Features

Figure 4-1. SBI-7126T-S6 Blade Module Front View

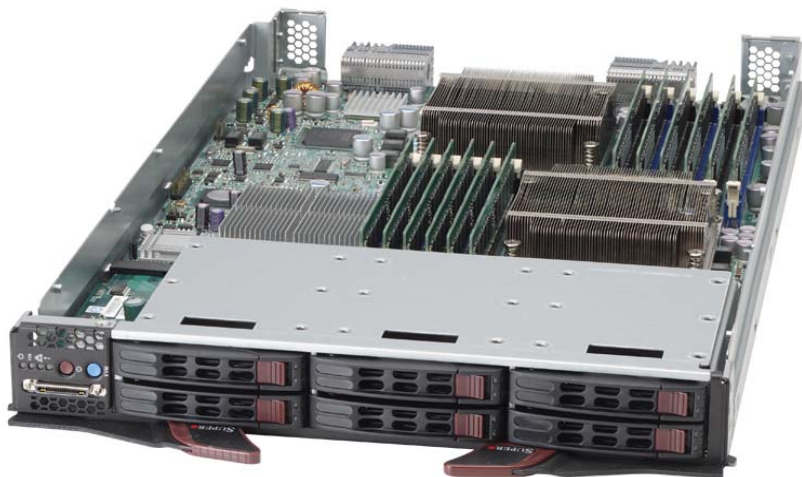

This chapter describes the SBI-7126T-S6 blade module. Installation and maintenance should be performed by experienced technicians only.

See [Figure 4-1](#) for a front view of the blade unit and [Table 4-1](#) for its features.

Table 4-1. SBI-7126T-S6 Blade Module Features

Feature	Description
Processors	Supports single or dual 1366-pin Intel Xeon 5500/5600 series processors
Memory	Supports up to 192GB/48GB of ECC Registered/Unbuffered ECC DDR3-1333/1066/800 SDRAM in twelve DIMM slots
Storage	Six 2.5" hot-plug SAS2/SATA hard disk drives
Ports	KVM port (1)
Features	Onboard Hermon graphics chip, IPMI 2.0, ATA/100, Plug and Play, APM 1.2, DMI 2.3, PCI 2.2, ACPI 1.0/2.0, SMBIOS 2.3, Real Time Clock, Watch Dog,
Power Consumption	Base Power Draw (~35W) / Power per CPU (60W/80W/95W) / Power per DIMM (typically 14.5W)

4-1 Control Panel

Each blade has a similar control panel (Figure 4-2) with power on/off button, a KVM connector, a KVM button and four LEDs on the top front of the unit. The numbers mentioned in Figure 4-2 are described in Table 4-2.

Figure 4-2. Blade Control Panel

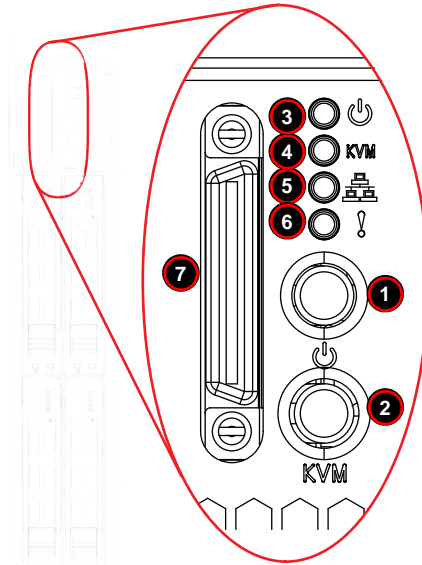

Table 4-2. Blade Control Panel

Item	Function	State	Description
1	Power Button	N/A	Turns blade module on and off
2	KVM Button	N/A	Initiates KVM function
3	Power LED	Green	Indicates power status "On"
		Orange	Indicates power status "Off" (with power cables plugged in)
4	KVM/UID LED	Blue	Indicates KVM being utilized on blade unit
		Flashing Blue	Indicates UID activated on blade module
5	Network/IB LED	Flashing Green	Indicates network activity over LAN
		Flashing Orange	Indicates network activity over InfiniBand module
6	System Fault LED	Red	Indicates a memory error, overheat, VGA error or any error that prevents booting
7	KVM Connector	N/A	Connector for SUV/KVM cable

Power Button

Each blade has its own power button so that individual blade units within the enclosure may be turned on or off independently of the others. Press the power button (#1) to turn on the blade server. The power LED (#3) will turn green. To turn off, press and hold the power button for >4 seconds and the power LED will turn orange.

KVM Button

KVM stands for Keyboard/Video/Mouse. With KVM, a user can control multiple blades with a single keyboard/video/mouse setup. Connect your keyboard, mouse and monitor to the USB and VGA connectors on the CMM module, then push the KVM button on the control panel of the blade module you wish to access.

LED Indicators

Blade module LEDs are described below in [Table 4-3](#).

Table 4-3. Blade Module LED Indicators

LED	State	Description
Power LED	Green	Power On
	Amber	Standby
	Red	Power Failure ^a
KVM/UID LED (Blue)	Steady On	Indicates that KVM has been initialized on this blade module
	Flashing	Serves as a UID indicator (the UID function is activated with a management program)
Network LED (Green)	Flashing	Flashes on and off to indicate traffic (Tx and Rx data) on the LAN connection to this blade module.
System Fault LED (Red)	Steady On	This LED illuminates red when a fatal error occurs. This may be the result of a memory error, a VGA error or any other fatal error that prevents the operating system from booting up.

- a. In the event of a power failure, the N+1 Redundant Power Supply (if included in your system's configuration) picks up the system load to provide uninterrupted operation. The failed power supply should be replaced with a new one as soon as possible.

KVM Connector

Alternatively, you may connect a KVM cable (CBL-0218L, with a keyboard/video/mouse attached) to the KVM connector (#7) of the blade you wish to access. To switch to another blade, disconnect the cable then reconnect it to the new blade.

See the *Web-based Management Utility User's Manual* on your Superblade system CD-ROM for further details on using the KVM function remotely.

4-2 Mainboard

The mainboard of the SBI-7126T-S6 blade unit is a proprietary design, which is based on the Intel 5500 Tylersburg chipset. See [Figure 4-4](#) for a block diagram of this chipset, [Figure 4-3](#) for a view of the B8DT6 Mainboard and [Figure 4-5](#) for an exploded view diagram of the blade unit.

Figure 4-3. B8DT6 Mainboard

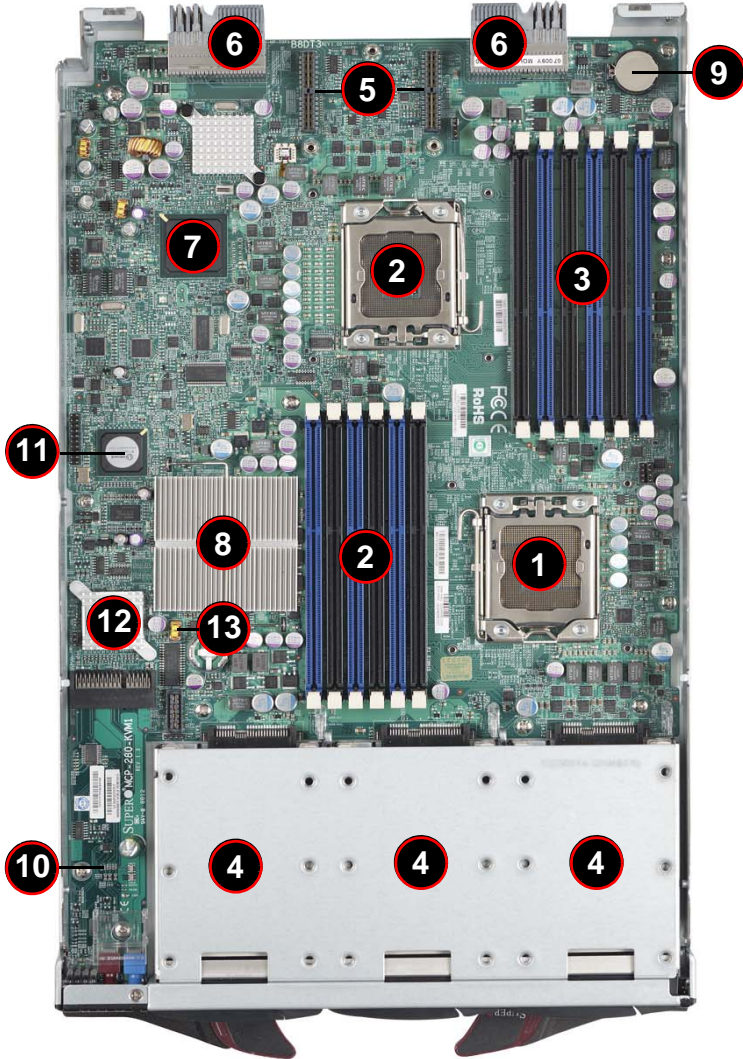
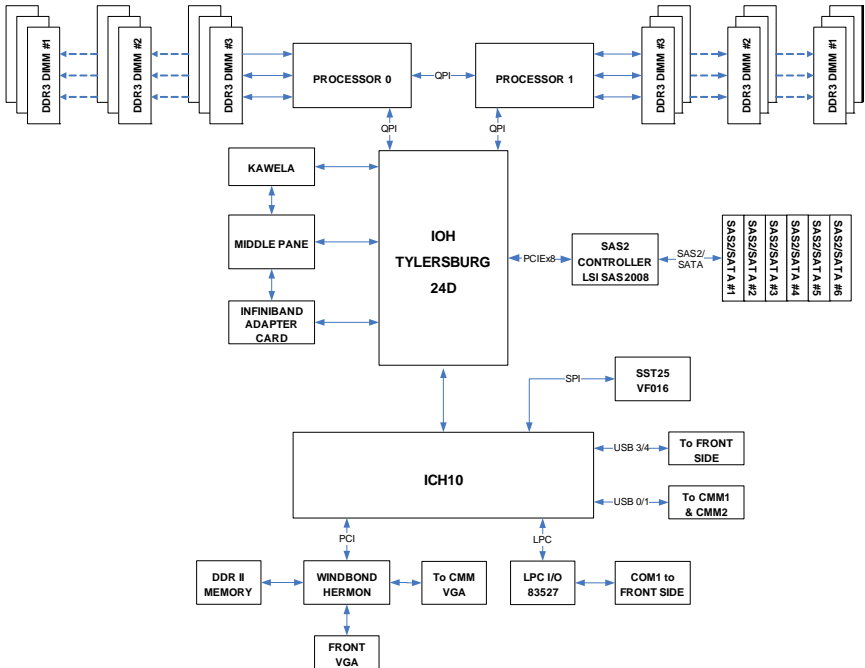

Table 4-4. B8DT6 Mainboard Layout

Item	Description
1	LGA 1366 CPU1 Socket
2	LGA 1366 CPU2 Socket
3	DIMM Slots (see Figure 3-5: "12-Slot DIMM Numbering" on page 3-7 for details)
4	6 SAS2/SATA Hard Drive Bays
5	InfiniBand Connectors (for InfiniBand cards)
6	Gbx Connectors (for power and logic to backplane)
7	ICH10R (South Bridge chip)
8	Intel 5500 Tylersburg (North Bridge chip)
9	Onboard Battery
10	KVM Module
11	BIOS Chip
12	LSI 2008 SAS2 Controller
13	J1BTN1 RAID 5 Key Connector

Figure 4-4. Intel 5500 Tylersburg Chipset Block Diagram



Jumpers

Most of the jumpers present on the mainboard are used by the manufacturer only; the only jumper used to configure the operation of the mainboard is

J1BTN1 RAID 5 Connector

The J1BTN1 RAID 5 Key connector activates RAID 5 configuration for the blade when a key is installed in the connector.

CMOS Clear

JBT1 is used to clear CMOS and will also clear any passwords. JBT1 consists of two contact pads located near the BIOS chip (#12 in [Figure 4-5](#)).

Clearing CMOS

1. First power down the blade and remove it from the enclosure.
2. Remove the blade cover to access the mainboard (see ["Removing/Replacing the Blade Cover"](#) on [page 3-2](#) for further details). Short the CMOS pads with a metal object such as a small screwdriver.
3. Replace the cover, install the blade back into the enclosure and power it on.

4-3 Blade Unit Components

Figure 4-5. Exploded View of SBI-7126T-S6 Blade Module

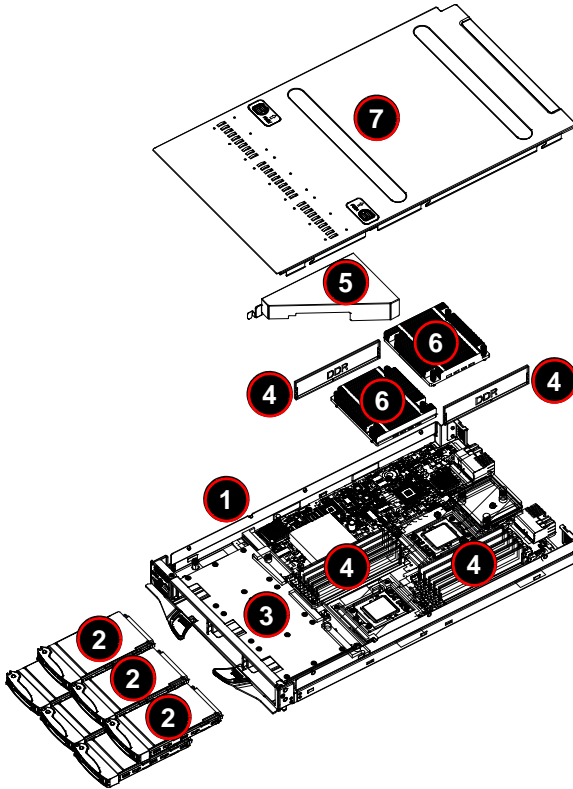

Main components of the SBI-7126T-S6 blade module are shown in [Figure 4-5](#) and described in [Table 4-5](#).

Table 4-5. Main Components of SBI-7126T-S6 Blade Module

Item	Description
1	Blade Unit/Module
2	SAS2/SATA Hard Drives (six per blade module)
3	SAS2/SATA Hard Drive Bays
4	DIMMs (system memory)
5	Airflow Deflector
6	CPU Heatsinks
7	Top Cover

Notes

Memory Support

The SBI-7126T-S6 blade module supports up to 192GB/48GB of ECC Registered/Unbuffered ECC DDR3-1333/1066/800 SDRAM in twelve DIMM sockets. See [Section 3-5](#) for further details on mainboard memory installation.

Hard Disk Drives

The SBI-7126T-S6 blade unit accommodates up to six 2.5" SAS2/SATA hard disk drives, which are mounted in drive "carriers". The drives are hot-swappable and can be removed or replaced without powering down the blade unit they reside in. The six drives can be used to set up a RAID array or JBOD. These drives use a yellow color for the Blade HDD active LED.



WARNING: To maintain proper airflow, both hard drive bays must have drive carriers inserted during operation whether or not a drive is installed in the carrier.

Chapter 5

RAID Setup Procedure

Each SBI-7126T-S6 blade module supports six hard drives, which may be used to create a RAID array. Use the *LSI MegaRAID Software Configuration Utility* found on your system's CD-ROM disc for your RAID setup. Go to <http://www.supermicro.com/support/manuals/> to download the installation guide and manual for this utility.

Important Notes

Please read the following notes and warnings before setting up your RAID array.



NOTE: Before adding a new drive to an array, back up any data contained on the new drive. Otherwise, all data will be lost.



NOTE: A RAID 1 created using the QUICK INIT option may return some data mismatches if you later run a consistency check. This is normal and is not a cause for concern.



NOTE: The *ACU* allows you to use drives of different sizes in an array. However, during a build operation, only the smaller drive can be selected as the source or first drive.



NOTE: When migrating from single volume to RAID 0, migrating from a larger drive to a smaller drive is allowed. However, the destination drive must be at least half the capacity of the source drive.



NOTE: To activate RAID 5 configuration you need to insert a key into the J1BTN1 connector on the mainboard. This will activate RAID 5 for your use in creating a RAID configuration.



WARNING: Adaptec does not recommend that you migrate or build an array on Windows dynamic disks (volumes), as it will result in data loss.



WARNING: Do not interrupt the creation of a RAID 0 using the MIGRATE option. If you do, you will not be able to restart or to recover the data that was on the source drive.

Notes

Chapter 6

BIOS

6-1 Introduction

This chapter describes the BIOS for Intel SuperBlade modules. The Intel Blade modules use a AMI™ ROM BIOS that is stored in a flash chip. This BIOS can be easily upgraded using a floppy disk-based program.



NOTE: Due to periodic changes to the BIOS, some settings may have been added or deleted and might not yet be recorded in this manual. Please refer to the <http://www.supermicro.com/products/SuperBlade/module/> web site for further details on BIOS setup and the BIOS menus for your SuperBlade blade module.

System BIOS

BIOS stands for Basic Input Output System. The AMI BIOS flash chip stores the system parameters, types of disk drives, video displays, etc. in the CMOS. The CMOS memory requires very little electrical power. When the blade unit is turned off, a backup battery provides power to the BIOS flash chip, enabling it to retain system parameters. Each time the blade is powered on it is configured with the values stored in the BIOS ROM by the system BIOS, which gains control at boot up.

How To Change the Configuration Data

The CMOS information that determines the system parameters may be changed by entering the BIOS Setup utility. This Setup utility can be accessed by pressing the <DELETE> key at the appropriate time during system boot. (See "[Starting the Setup Utility](#)" below.)

Starting the Setup Utility

Normally, the only visible POST (Power-On Self-Test) routine is the memory test. As the memory is being tested, press the <DELETE> key to enter the main menu of the BIOS Setup utility. From the main menu, you can access the other setup screens, such as the Security and Power menus.



WARNING: To prevent possible boot failure, do not shut down or reset the system while updating the BIOS.

6-2 BIOS Updates

It may be necessary to update the BIOS used in the blade modules on occasion. However, it is recommended that you not update BIOS if you are not experiencing problems with a blade module.

Updated BIOS files are located on our web site(www.supermicro.com/products/superblade/). Please check the current BIOS revision and make sure it is newer than your current BIOS before downloading.

There are several methods you may use to upgrade (flash) your BIOS. After downloading the appropriate BIOS file (in a zip file format), follow one of the methods described below to flash the new BIOS.

Flashing BIOS

Use the procedures below to “Flash” your BIOS with a new update using the KVM dongle, USB ports on the CMM module or by use of a Floppy disk.

Flashing a BIOS using the KVM Dongle:

For this method, you must use a KVM “dongle” cable (CBL-0218L, included with the system).

1. Copy the contents of the zip file to a bootable USB pen drive.
2. Connect the KVM dongle (CBL-0218L) to the KVM connector at the front of the blade you will be flashing the BIOS to.
3. Connect your bootable USB pen drive to one of the two USB slots on the KVM dongle.
4. Boot to the USB pen drive and go to the directory where you saved the contents of the zip file.
5. Type **flash filename.rom** (replace *filename.rom* by the actual ROM file name).

Flashing a BIOS using the USB Ports on the CMM:

1. Copy the contents of the zip file to a bootable USB pen drive.
2. Connect your bootable USB pen drive to one of the two USB slots on the CMM (located on the back side of the enclosure).
3. Boot to the USB pen drive and go to the directory where you saved the contents of the zip file.
4. Type **flash filename.rom** (replace *filename.rom* by the actual ROM file name).

Flashing a BIOS using a Floppy Image File

This method must be performed remotely.

1. Copy the image file from the zip file to your desktop.
2. Use the web browser or IPMIView to access your CMM remotely using its IP Address.

3. Go to the VIRTUAL MEDIA menu and select FLOPPY IMAGE UPLOAD.
4. BROWSE or OPEN to locate the *.img file on your desktop and select it.
5. Press the UPLOAD button and wait a few seconds for the image to upload to the CMM.
6. Once the upload finishes, turn on the blade module and press to enter the BIOS setup utility.
7. In the BOOT MENU, bring **USB LS120: PEPPCMM VIRTUAL DISC 1** to the top of the boot priority list.
8. Exit while saving the changes. The blade module will boot to the virtual media (floppy image) **A:\>**.
9. Type **flash filename.rom**.



NOTE: Replace *filename.rom* by the actual ROM file name (such as **B8DTE142.rom** for example) in the command.

6-3 Running Setup



NOTE: Default settings are in **bold** text unless otherwise noted.

The BIOS setup options described in this section are selected by choosing the appropriate text from the MAIN BIOS SETUP screen. All displayed text is described in this section, although the screen display is often all you need to understand how to set the options.

When you first power on the computer, the BIOS is immediately activated.

While the BIOS is in control, the Setup program can be activated in one of two ways:

1. By pressing <DELETE> immediately after turning the system on, or
2. When the message **Press the <Delete> key to enter Setup** appears briefly at the bottom of the screen during the POST, press the <DELETE> key to activate the main SETUP menu:

6-4 Main BIOS Setup

All Main Setup options are described in this section.

Use the UP/DOWN arrow keys to move among the different settings in each menu. Use the LEFT/RIGHT arrow keys to change the options for each setting.

Press the <ESC> key to exit the CMOS SETUP menu. The next section describes in detail how to navigate through the menus.

Items that use sub-menus are indicated with the ► icon. With the item highlighted, press the <ENTER> key to access the submenu.

Menu options found in the MAIN BIOS SETUP menu are shown in [Figure 6-1](#) and described in [Table 6-1](#).

Figure 6-1. Main Setup Menu Screen

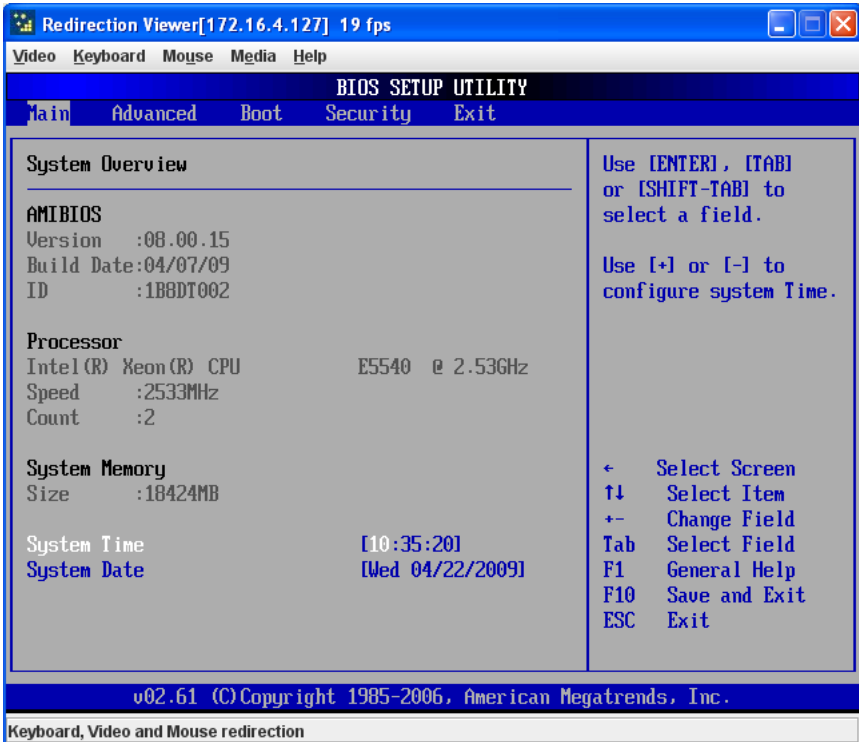
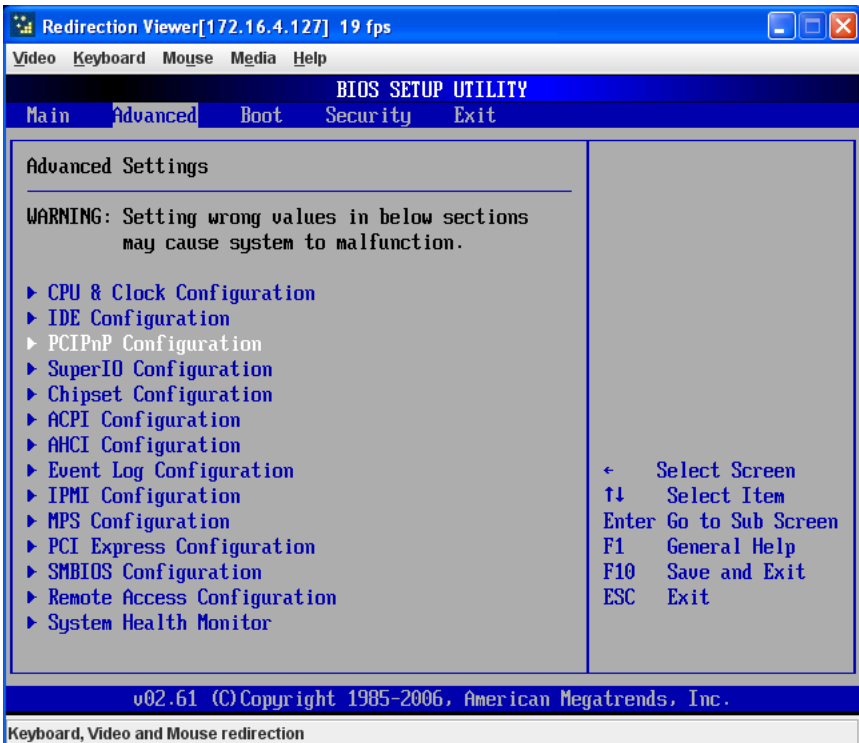

Table 6-1. Main BIOS Setup Menu Options

Menu Option	Description
System Time	To set the system date and time, key in the correct information in the appropriate fields. Then press the <Enter> key to save the data.
System Date	Using the arrow keys, highlight the month, day and year fields, and enter the correct data for the system date. Press the <Enter> key to save the data.
BIOS Date	The BIOS Date field displays the date when this version of the BIOS was built. This option is not configurable.

6-5 Advanced Setup

Figure 6-2. Advanced Setup Menu



Choose **Advanced** from the BIOS Setup Utility main menu with the arrow keys to display the ADVANCED SETUP menu (Figure 6-2).

The items with a triangle beside them are sub-menus that can be accessed by highlighting the item and pressing <ENTER>. Options for PIR settings are displayed by highlighting the setting option using the arrow keys and pressing <ENTER>.

Table 6-2 describes all sub-menus found in the ADVANCED SETUP menu.

Table 6-2. Advanced Setup Menu Options

Sub-menu	Description
▶ CPU and Clock Configuration	See Table 6-3 for a description of BIOS setup menu options in this sub-menu.
▶ IDE Configuration	See Table 6-4 for a description of BIOS setup menu options in this sub-menu.
▶ PCIPnP Configuration	Access this submenu to make changes to settings for PCI/PnP devices. See Table 6-5 for a description of BIOS setup menu options in this sub-menu.
▶ SuperIO Configuration	See Table 6-6 for a description of BIOS setup menu options in this sub-menu.
▶ Chipset Configuration	See Table 6-7 for a description of BIOS setup menu options in this sub-menu.
▶ ACPI Configuration	See Table 6-8 for a description of BIOS setup menu options in this sub-menu.
▶ AHCI Configuration	See Table 6-9 for a description of BIOS setup menu options in this sub-menu.
▶ Event Log Configuration	See Table 6-10 for a description of BIOS setup menu options in this sub-menu.
▶ IPMI Configuration	See Table 6-11 for a description of BIOS setup menu options in this sub-menu.
▶ MPS Configuration	See Table 6-12 for a description of BIOS setup menu options in this sub-menu.
▶ PCI Express Configuration	See Table 6-13 for a description of BIOS setup menu options in this sub-menu.
▶ SMBIOS Configuration	See Table 6-14 for a description of BIOS setup menu options in this sub-menu.
▶ Remote Access Configuration	See Table 6-15 for a description of BIOS setup menu options in this sub-menu.
▶ System Health Monitor	See Table 6-16 for a description of BIOS setup menu options in this sub-menu.

Table 6-3. CPU and Clock Configuration Sub-menu

Menu Option	Description
Ratio CMOS Setting	Sets the ratio between CPU core clock and the FSB frequency. The default setting depends upon the type of CPU installed on the mainboard. The default setting for the CPU installed in your mainboard is 18 . Press + or - on your keyboard to change this value. NOTE: If an invalid ratio is entered, the AMI BIOS will restore the setting to a previous state.
Hardware Prefetcher	If set to Enabled , the hardware prefetcher will prefetch streams of data and instructions from the main memory to the L2 cache in the forward or backward manner to improve CPU performance. Options are Enabled and DISABLED . For UP platforms leave it enabled. for DP/MP servers, this setting may be used to tune performance to the specific application.
Adjacent Cache Line Prefetch	The CPU fetches the cache line for 64-bytes if this option is set to DISABLED . The CPU fetches both cache lines for 128-bytes as comprised if Enabled . For UP platforms leave it enabled. for DP/MP servers, this setting may be used to tune performance to the specific application.
Max CPUID Value Limit	This setting is Disabled for Windows systems.
Intel® Virtualization Tech	Select Enabled to use this Virtualization Technology feature to allow one platform to run multiple operating systems and applications in independent partitions, creating multiple "virtual" systems in one physical computer system. The options are Enabled and DISABLED . Please refer to the Intel website for further detailed information. NOTE: A full reset of the system is required when you change this setting.
Execute-Disable Bit Capability	The Execute Disable Bit allows the processor to designate areas in the system memory where an application code can be executed, and where it cannot. This prevents a worm or virus from flooding illegal codes into the system to overwhelm the processor or damage the system during an attack. The default setting is Enabled . Please refer to the Intel and Microsoft websites for more information.
Intel HT Technology	When this setting is DISABLED , only one thread per enabled core is enabled. The default for this setting is Enabled .
Active Processor Cores	Sets the number of cores to enable in each processor package. Default is ALL .

Table 6-4. IDE Configuration Menu

Menu Option	Description
SATA#1 Configuration	If Compatible is selected, this sets SATA#1 to legacy compatibility mode. Selecting Enhanced sets SATA#1 to native SATA mode. The options are DISABLED , Compatible and ENHANCED .
Configure SATA#1 as	This setting allows you to select the drive type for SATA#1. The options are IDE , RAID and AHCI . Choosing the RAID or AHCI changes which further menu options appear on the screen.
Max Ports on SATA#1	This setting allows you to specify the max ports for SATA#1 when RAID configuration is selected for SATA#1 Configuration. The options are 4 PORTS or 6 Ports .

Table 6-4. IDE Configuration Menu (Continued)

Menu Option	Description
RAID ID Support	This setting allows you to select either the Intel or ADAPTEC RAID Configuration Utility to be used for configuring your RAID setup. This setting is only available when RAID is selected for SATA#1 Configuration.
Hot Plug	This setting allows you to enable the Hot Plug feature when using RAID for your SATA devices when RAID is selected for your SATA#1 Configuration. Options include ENABLED or Disabled .
SATA#2 Configuration	Selecting Enhanced sets SATA#2 to native SATA mode. The options are DISABLED and Enhanced .
Hard Disk Write Protect	This setting Enables/Disables device write protection and is effective only if the device is accessed through BIOS. The default is Enabled .
IDE Detect Tie Out (Sec)	This setting allows you to select the time out value for detecting ATA?ATAPI devices. Press + or - on your keyboard to change this value. The default is 35 .
ATA(P) 80Pin Cable Detection	This setting allows you to select the mechanism for detecting 80P in ATA(P) cable. The default is Host & Device .

Table 6-5. PCIPnP Configuration Sub-menu

Menu Option	Description
Clear NVRAM	This setting allows you to clear NVRAM during a system boot. The options are No and Yes .
Plug & Play O/S	Selecting Yes allows the OS to configure Plug & Play devices. Select No to allow the AMI BIOS to configure all devices in your system. NOTE: This is not required for system boot (select No) if your system has an OS that supports Plug & Play.
PCI Latency Timer	This sets the latency timer of each PCI device installed on a PCI bus. For example, select 64 to set the PCI latency to 64 PCI clock cycles. The options are 32, 64 , 96, 128, 160, 192, 224 and 248.
Allocate IRQ to PCI VGA	Select Yes to assign IRQ to the PCI VGA card if the card requests IRQ. Selecting No does not assign IRQ to the PCI VGA card even if the card requests an IRQ.
Palette Snooping	When ENABLED , this informs PCI devices that an ISA graphics device is installed in the system so the card will function correctly. The default is Disabled .
PCI IDE BusMaster	When enabled, the BIOS uses PCI bus mastering for reading/writing to IDE devices. The options are DISABLED and Enabled .
Offboard PCI/ISA IDE Card	Some PCI IDE cards may require this setting to be set to the PCI slot number that is holding the card. The default Auto setting works for most PCI IDE cards.
IRQ3 ~ IRQ11	When each of these settings is set to Available , the specified IRQ is available to be used by PCI/PnP devices. If set to RESERVED , the IRQ is reserved for use by legacy ISA devices.

Table 6-6. SuperIO Configuration Sub-menu

Menu Option	Description
Serial Port1 Address	This option specifies the base I/O port address and the Interrupt Request address of Serial Port 1. Select Disabled to prevent the serial port from accessing any system resources. When this option is Disabled, the serial port physically becomes unavailable. Select 3F8/IRQ4 to allow the serial port to use 3F8 as its I/O port address and IRQ 4 for its interrupt address. Options are DISABLED, 3F8/IRQ4 , 3E8/IRQ4 and 2E8/IRQ3.
Serial Port2 Address	Same as above, but options are DISABLED, 2F8/IRQ3, 3E8/IRQ4 and 2E8/IRQ3.
Serial Port2 Mode	This setting allows the BIOS to select the mode for Serial Port 2. Options are Normal , IrDA and ASK IR.

Table 6-7. Chipset Configuration Sub-menu

Menu Option	Description
► CPU Bridge Configuration	This sub-menu configures CPU Bridge features
QPI Links Speed	This option allows you to transition QPI links to Full-Speed or leave them in SLOW-MODE for the QPI data transfer speed.
QPI Frequency	This option selects the desired QPI frequency. Option include Auto , 4.800 GT, 5.866 GT and 6.400 GT.
QPI L0s and L1	This option enables the QPI power state to low power with L0s and L1 automatically selected by the mainboard. The options are Disabled and ENABLED .
Memory Frequency	This feature forces a DDR3 frequency slower than what the system has detected. The available options are Auto , DDR-800, FORCE DDR-1066 and FORCE DDR-1333.
Memory Mode	This option sets the system memory mode. Options are the following: <ul style="list-style-type: none"> • Independent (default) – All DIMMs are available to the operating system. • CHANNEL MIRROR – The mainboard maintains two identical copies of all data in memory for redundancy. • LOCKSTEP – The mainboard uses two areas of memory to run the same set of operations in parallel. • SPARING – A preset threshold of correctable errors is used to trigger fail-over. The spare memory is put online and used as active memory in place of the failed memory.
Demand Scrubbing	This feature is a memory error-correction scheme whereby the processor writes corrected data back into the memory block from where it was read by the processor. The options are ENABLED or Disabled .
Patrol Scrubbing	This feature is a memory error-correction scheme that works in the background looking for and correcting resident errors. The options are ENABLED or Disabled .
NUMA Support	This feature allows you to enable NUMA support for your system. Options are Enabled or DISABLED.
DIMM CE Event Log	This feature enables/disables a NUMA Correctable Error Event Log. The options are ENABLED or Disabled .

Table 6-7. Chipset Configuration Sub-menu (Continued)

Menu Option	Description
Serial Debug Message Level	This feature specifies what level of debug messages to display. The default option is None .
▶North Bridge Configuration	This sub-menu configures North Bridge features
Crystal Beach/DMA	This feature works with Intel's I/O Acceleration Technology (AT) to accelerate the performance of TOE devices. When this feature is set to ENABLED , it will enhance overall system performance by providing direct memory access for data transferring. Options include ENABLED and DISABLED . NOTE: A TOE device is a specialized, dedicated processor that is installed on an add-on card or a network card to handle some or all packet processing of the card.
Crystal Beach/DCA	This feature allows you to enable Crystal Beach/DCA support for your system. Options include ENABLED and DISABLED .
Intel VT-d	Select ENABLED to enable Intel's Virtualization Technology support for Direct I/O VT-d by reporting the I/O device assignments to VMM through the DMAR ACPI Tables. This feature offers fully protected I/O resource-sharing across Intel platforms, providing you with greater reliability, security and availability in networking and data-sharing. Options include ENABLED and DISABLED .
▶South Bridge Configuration	This sub-menu configures South Bridge features.
USB Functions	This feature allows you to enable USB functions in your system. Options are Enabled or DISABLED .
USB Port Configure	This feature allows you to configure USB ports in your system. Options include 6x6 USB Ports and 8x4 USB PORTS .
▶USB Configuration	This submenu contains further USB configuration options.
Legacy USB Support	This option allows you to enable the use of Legacy USB devices. If this option is set to AUTO , legacy USB support will be automatically enabled if a legacy USB device is installed on the mainboard, and vice versa. The options include DISABLED , Enabled and AUTO .
USB 2.0 Controller Mode	This setting allows you to select the USB 2.0 Controller mode. Options include Hi-Speed (480 Mbps) and FULL SPEED (12 MBPS) .
BIOS EHCI Hand-Off	This option allows you to enable BIOS Enhanced Host Controller Interface support in order to provide a workaround solution for an operating system that does not have EHCI Hand-Off support. When Enabled , the EHCI Interface will be changed from the BIOS-controlled to the OS-controlled. Options include Enabled and DISABLED .
Hotplug USB FDD Support	This option allows you to create a dummy Floppy Disk Drive (FDD) that will be associated with the hotplugged FDD later. AUTO creates this dummy device only if there is no USB FDD present. Options include DISABLED , ENABLED and Auto .
SMBUS Controller	This option allows you to enable your SMBUS controller in your system. Options include Enabled and DISABLED .

Table 6-7. Chipset Configuration Sub-menu (Continued)

Menu Option	Description
Restore on AC Power Loss	This option allows you to specify what your system will do when power is restored after an AC power loss. Options include Power Off , POWER ON and LAST STATE .
Power Button Function	This option allows you to specify the power button function for turning off your system. Options include 4 SECOND OVERRIDE and Instant Off .

Table 6-8. ACPI Configuration Sub-menu

Menu Option	Description
►Advanced ACPI Configuration	This sub-menu allows you to configure Advanced Configuration and Power Interface (ACPI) power management setting for your system. Please refer to ACPI's website http://www.acpi.info/ for more information.
ACPI Version Features	This option allows you to enable RSDP pointers to 64-bit fixed system description tables. Options include ACPI v1.0 , ACPI v2.0 and ACPI v3.0 .
ACPI APIC Support	This option allows you to include an ACPI APIC table pointer in the Root System Description Table (RSDT) pointer list. Options include Enabled and DISABLED .
AMI OEMB Table	This option allows you to include the OEMB table pointer to R(x)SDT pointer lists. Options include Disabled or ENABLED .
Headless Mode	This option allows you to enable your system to function without a keyboard, monitor or mouse attached. Options include Disabled or ENABLED .
►Chipset ACPI Configuration	This sub-menu allows you to configure Chipset ACPI configurations.
Energy Lake Feature	This option allows you to enable the Energy Lake Feature in your system. Options include Enabled and DISABLED .
APIC ACPI SCI IRQ	This option allows you to enable the APIC ACPI SCI IRQ in your system. Options include Enabled and DISABLED .
USB Device Wakeup From S3/S4	This option allows you to enable/disable USB device wakeup from S3/S4. Options include Disabled or ENABLED .
High Performance Event Timer	Select Enabled to activate the High Performance Event Timer (HPET). This produces periodic interrupts at a much higher frequency than a Real-time Clock (RTC) does in synchronizing multimedia streams, providing smooth playback and reducing the dependency on other timestamp calculation devices, such as an x86 RDTSC Instruction embedded in the CPU. The HPET is used to replace the 8254 Programmable Interval Timer. Options include Enabled and DISABLED .
HPET Memory Address	This option allows you to set your HPET Memory Address for your system. Options include FED0000h , FED01000h , FED02000h and FED03000h .

Table 6-9. AHCI Configuration Sub-menu

Menu Option	Description
AHCI BIOS Support	This option enables AHCI BIOS support on your system. Options include Enabled and DISABLED .
AHCI CD/DVD Boot Time Out	This sets the timeout time in seconds for AHCI CD/DVD boot drives. Some SATA CD/DVD drives in AHCI mode need to wait longer than others. Options include 0 (sec), 5, 10, 15, 20, 25, 30 and 35 .
▶AHCI Port0~Port5	While entering setup, BIOS auto detects the presence of IDE devices. This setting displays the status of auto detection of IDE devices.
SATA Port0 ~ Port5	For this setting, select the type of device connected to the system. Select Auto to allow the AMI BIOS to automatically detect a hard disk drive in your system. Options include Auto and NOT INSTALLED .
S.M.A.R.T.	Self-Monitoring Analysis and Reporting Technology (SMART) can help predict impending drive failures. Select DISABLED to prevent the AMI BIOS from using S.M.A.R.T in your system. Selecting Enabled allows the AMI BIOS to use S.M.A.R.T to support the hard disk drive. Option include DISABLED and Enabled .

Table 6-10. Event Log Configuration Sub-menu

Menu Option	Description
View Event Log	Selecting this option allows you to view all unread events on the Event Log.
Mark All Events as Read	This option makrs all events as read. Options ae OK and Cancel when selected.
Clear Event Log	This option clears the Event Log memory of all messages. Options are OK and Cancel .

Table 6-11. IPMI Configuration Sub-menu

Menu Option	Description
Status of BMC	The Baseboard Management Controller (BMC) manages the interface between the system management software and platform hardware. This non-configurable informational feature shows the status code of the BMC micro controller.
▶View BMC System Event Log	<p>This feature displays the BMC System Event Log (SEL). This log shows the total number of entries of BMC system events. To view an event, select an entry number and press <ENTER> to display the information as shown in the screen. This screen contains the following information:</p> <ul style="list-style-type: none"> • Total Number of Entries • SEL Entry Number • SEL Record ID • SEL Record Type • Timestamp, Generator ID • Event Message Format User • Event Sensor Type • Event Sensor Number • Event Dir Type • Event Data

Table 6-11. IPMI Configuration Sub-menu (Continued)

Menu Option	Description
Clear BMC System Event Log	This option allows you to clear the BMC system log. Select Cancel to keep the BMC system log and Ok with the <ENTER> key to clear the BMC system log. WARNING: Any cleared information is unrecoverable. Make absolutely sure that you no longer need any data stored in the log before clearing the BMC Event Log.
▶ Set LAN Configuration	This sub-menu is used to configure the IPMI LAN adapter with a network address.
Channel Number	This static display shows the channel number for the SET LAN Config command.
Channel Number Status	This static display shows the channel status for the channel number. It will either display CHANNEL NUMBER IS OK or WRONG CHANNEL NUMBER.
IP Address Source	Use this option for selecting the IP Address source. Options include STATIC or DHCP .
▶ IP Address	This sub-menu contains static displays and options for specifying the IP address for your system. This should be in decimal and in dotted quad form (such as 192.168.10.253). The value of each three-digit number separated by dots should not exceed 255.
Parameter Selector	This static display shows the parameter of your IP Address configuration.
IP Address	The BIOS will automatically enter the IP address of your system; however it may be over-ridden. IP addresses are 6 two-digit hexadecimal numbers (base 16, 0-9, A, B, C, D, E and F) separated by dots (such as 00.30.48.D0.D4.60).
Current IP Address in BMC	This static display shows the current IP address used for your IPMI connection.
▶ MAC Address	Enter the MAC address for your system using this sub-menu. This should be in decimal and dotted quad form (such as 192.168.10.253). The value of each three-digit number separated by dots should not exceed 255.
Parameter Selector	This static display shows the parameter of your MAC Address configuration.
MAC Address	The BIOS will automatically enter the MAC address of your system; however it may be over-ridden. MAC addresses are 6 two-digit hexadecimal numbers (base 16, 0-9, A, B, C, D, E and F) separated by dots (such as 00.30.48.D0.D4.60).
Current MAC Address in BMC	This static display shows the current MAC address used for your IPMI connection.
▶ Subnet Mask	Subnet masks tell the network which subnet this system belongs. The value of each three-digit number separated by dots should not exceed 255.
Parameter Selector	This static display shows the parameter of your Subnet Masks configuration.
Subnet Mask	This static display shows the current Subnet Mask setting for your IPMI connection.
Current Subnet Mask in BMC	This static display shows the current Subnet Mask used for your IPMI connection.

Notes

Table 6-12. MPS Configuration Sub-menu

Menu Option	Description
MPS Revision	This option allows you to select the MPS revision used for your system. Options include 1.1 and 1.4.

Table 6-13. PCI Express Configuration Sub-menu

Menu Option	Description
Active State Power-Management	This option allows you to enable/disable PCI Express L0s and L1 link power in your system. Options include Enabled and DISABLED .

Table 6-14. SMBIOS Configuration Sub-menu

Menu Option	Description
SMI Support	This option enables SMBIOS SMI Wrapper support for Plug-and-Play Func 50h-54h. Options include Enabled and DISABLED .

Table 6-15. Remote Access Configuration Sub-menu

Menu Option	Description
Remote Access	This option allows you to select your remote access type. Options include COM1 and COM2 .
Serial Port Number	This option allows you to select a serial port for console redirection if the selected port is enabled. Options include COM1 and COM2 . The Base Address IRQ is displayed statically under this option for your reference.
Serial Port Mode	Use this option to select the serial port mode setting. Options include 115200 8,n,1 / 57600 8,n,1 / 38400 8,n,1 / 19200 8,n,1 / 09600 8,n,1
Flow Control	This option allows you to select Flow Control for redirection. Options include None , HARDWARE or SOFTWARE .
Redirection After BIOS POST	This option allows you to specify redirection after BIOS POST. Options include the following: <ul style="list-style-type: none"> • DISABLE – Turns off the redirection after POST • BOOT LOADER – Redirection is active during Boot Loader • Always – Redirection is always active. NOTE: Some operating systems may not work if set to Always .
Terminal Type	This option allows you to select the Terminal Type for your system. Options include ANSI , VT100 and VT-UTF8 .
VT-UTF8 Combo Key Support	Use this option to enable VT-UTF8 Combination Key support for ANSI/VT100 terminals. Options include Enabled and DISABLED .
Sredir Memory Display Delay	This option gives the delay in seconds to display memory information. Options include No Delay , DELAY IN 1 SEC , DELAY IN 2 SEC and DELAY IN 4 SEC .

Table 6-16. System Health Monitor Sub-menu

Menu Option	Description
System Health Monitor Screen	<p>This screen displays information about your system's health and includes the following health information:</p> <ul style="list-style-type: none"> • CPU Temperatures (for both CPUs) • System Temperature • CPU Vcore (for both CPUs) • 3.3V Vcc (V) • +5Vin • +12V Vcc (V) • 5V Standby • Battery Voltage <p>See Section 6-9: Hardware Health Information on page 6-20 for further details on the health information listed above.</p>

6-6 Security

Figure 6-3. Security Setup Menu



Choose **Security** from the AMI BIOS Setup Utility main menu with the arrow keys to bring up the SECURITY SETUP menu (Figure 6-3). Security setting options are displayed by highlighting the setting using the arrow keys and pressing <ENTER>. All Security BIOS settings are described in Table 6-17 below.

Table 6-17. Security Menu Options

Menu Option	Description
Supervisor Password	This displays whether a supervisor password has been entered for the system. "Not Installed" means that a Supervisor password has not been used.
User Password	This displays whether a user password has been entered for the system. "Not Installed" means that a User password has not been used.
Change Supervisor Password	Select this option and hit the <ENTER> key to access the sub-menu and then type in the Supervisor's password in the dialogue box to set or change the Supervisor password, which allows access to the System's BIOS.
Change User Password	Select this option and hit the <ENTER> key to access a sub-menu with the following options; <ul style="list-style-type: none"> • Full Access (default) – This grants full user read and write acces to the BIOS Setup Utility. • VIEW ONLY – This allows access to the BIOS Setup Utility, but does not allow the fields to be changed. • LIMITED – This allows only limited fields to be changed such as DATE and TIME. • No Access – This prevents User access to the BIOS Setup Utility. NOTE: This option is only available when the Supervisor Password has been set above.
Clear User Password	This option allows you to clear a user password after it has been entered.
Password Check	This item allows you to check a password after it has been entered. The options include Setup and ALWAYS.
Boot Sector Virus Protection	When ENABLED, the AMI BIOS displays a warning when any program or virus issues a Disk Format command or attempts to write to the boot sector of the hard disk drive. Options include ENABLED and Disabled .

6-7 Boot

Figure 6-4. Boot Setup Menu



Choose **Boot** from the AMI BIOS Setup Utility main menu with the arrow keys to bring up the BOOT SETUP menu (Figure 6-4). Security setting options are displayed by highlighting the setting using the arrow keys and pressing <ENTER>. All Security BIOS settings are described in Table 6-18 below.

Table 6-18. Boot Setup Menu Options

Menu Option	Description
▶ Boot Settings Configuration	This sub-menu allows you configure settings during system system boot.
Quick Boot	This option allows BIOS to skip certain tests while booting. This will decrease the time needed to boot the system. Options include Enabled or DISABLED .
Quiet Boot	When ENABLED , your system displays its OEM Logo instead of POST messages and beeps. When Disabled , your system displays and emits normal POST messages.

Table 6-18. Boot Setup Menu Options (Continued)

Menu Option	Description
AddOn ROM Display Mode	This option allows you to set the display mode for Option ROM. Options include Force BIOS or KEEP CURRENT .
Bootup Num-Lock	Use this option to select a Power-on state for Numlock during boot-up. Options include On (Power-on state) or OFF .
PS/2 Mouse Support	Use this option to select support for a PS/2 mouse in your system. Options include Auto (for automatically detecting if a PS/2 mouse is present), DISABLED or ENABLED .
Wait for 'F1' If Error	This option, when Enabled , causes your system to wait for the F1 key to be pressed if an error occurs during bootup. Options include Enabled and DISABLED .
Hit 'Del' Message Display	When enabled, this feature displays a "Press DEL to run Setup" message in POST. Options are Enabled and DISABLED .
Interrupt 19 Capture	When enabled, this feature allows option ROMs to trap Interrupt 19. Options include Enabled and DISABLED .
▶ Boot Device Priority	<p>This sub-menu feature allows you to specify the sequence of priority for the boot device (such as hard disk drives, USB devices, CD-ROM drives and so on). The menu options are for 1ST BOOT DEVICE, 2ND BOOT DEVICE and 3RD BOOT DEVICE. Each numbered boot device can be set to a specific device installed in your system or to DISABLED.</p> <p>NOTE: A device enclosed in parenthesis has been disabled in the corresponding type menu.</p>
▶ Hard Disk Drives	This sub-menu feature allows you to specify the boot sequence from all available hard disk drives installed on your system. The settings for each are list of all available hard disk drives in your system that have been detected or DISABLED .

6-8 Exit

Figure 6-5. Exit Setup Menu

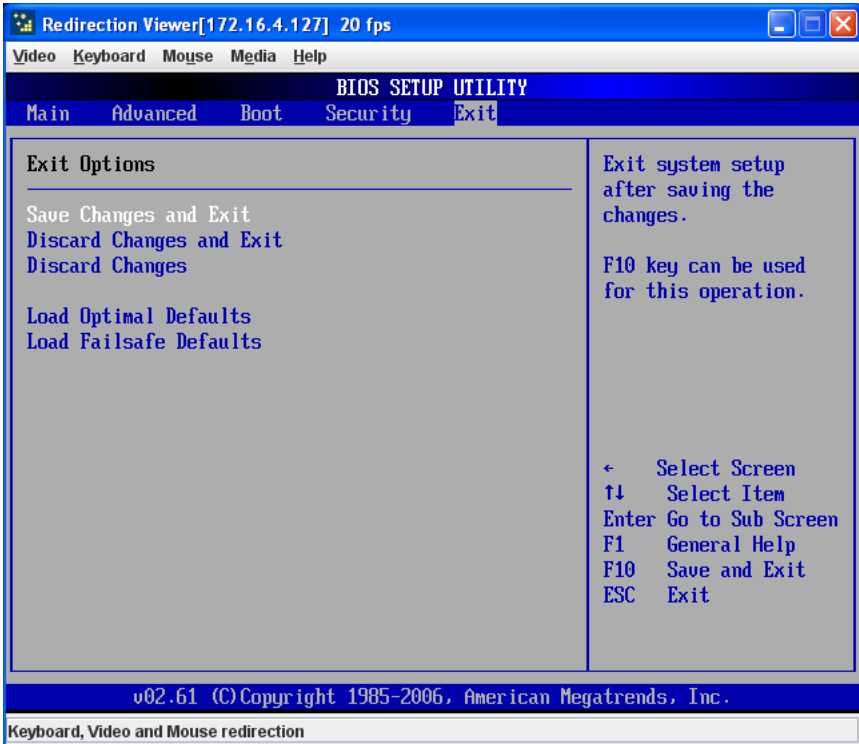

Choose EXIT from the AMI BIOS Setup Utility main menu with the arrow keys to display the EXIT SETUP menu (Figure 6-5). All Exit BIOS settings are described in Table 6-19 below.

Table 6-19. Exit Menu Options

Menu Option	Description
Save Changes and Exit	Highlight this item and hit <ENTER> to save any changes you made and to exit the BIOS Setup utility. The system will reboot and implement the changes you have made to the BIOS Setup.
Discard Changes and Exit	Highlight this item and hit <ENTER> to exit the BIOS Setup utility without saving any changes you may have made. Any changes you have made to the BIOS Setup will not take effect upon system bootup.
Discard Changes	Highlight this item and hit <ENTER> to discard (cancel) any changes you made. You will remain in the Setup utility.

Table 6-19. Exit Menu Options (Continued)

Menu Option	Description
Load Optimal Defaults	Highlight this item and hit <ENTER> to load the default settings for all items in the BIOS Setup. These are the safest settings to use and are designed for maximum system performance, but may not work best for all computer applications.
Load Fail Safe Defaults	Highlight this item and hit <ENTER> to load fail-safe settings that are designed for maximum system stability, but not for maximum performance.

6-9 Hardware Health Information

This section provides further details concerning the SYSTEM HEALTH MONITOR screen information described briefly in [Table 6-16](#).

CPU Temperature

This feature displays current temperature readings for the CPUs installed in your system.

The CPU's temperature is read by the mainboard in order for it to take different actions at different temperatures (such as increasing CPU fan speed, triggering overheat alarms and so on). Since CPUs can have differing temperature tolerances, the installed CPU sends information to the mainboard on what its 'Temperature Tolerance' is so temperature management can be undertaken.

Supermicro uses this feature in its mainboard's by assigning a temperature status to certain thermal conditions in the processor (Low, Medium and High). This makes it easier for you to understand the CPU's temperature status, rather than by simply seeing a temperature reading (such as 25° C). This CPU Temperature feature displays the CPU temperature status as detected by the BIOS:

- Low – This level is considered as the 'normal' operating state. The CPU temperature is well below the CPU 'Temperature Tolerance' and mainboard fans and CPU will run normally.
- Medium – The processor is running warmer. This is a 'precautionary' level and generally means that there may be factors contributing to this condition, but the CPU is still within its normal operating state and below the CPU 'Temperature Tolerance'. The fans may adjust to a faster speed.

No user action is required, but you may consider checking the CPU fans and the chassis ventilation for blockage.

- High – The processor is running hot. This is a 'caution' level since the CPU's 'Temperature Tolerance' has been reached (or has been exceeded) and may activate an overheat alarm.

If the system buzzer and Overheat LED has activated, take action immediately by checking the system fans, chassis ventilation and room temperature to correct any problems.



NOTE: The system may shut down if this high level continues for a long period in order to prevent damage to the CPU.

System Temperature

The system temperature is displayed (in degrees Celsius and Fahrenheit) as it is detected by the BIOS.

Voltage Monitoring

The following voltage information is displayed:

- CPU Vcore (for both CPUs)
- 3.3V Vcc (V)
- +5Vin
- +12V Vcc (V)
- 5V Standby
- Battery Voltage

Notes

Appendix A

BIOS POST Codes

A-1 BIOS POST Messages

During the Power-On Self-Test (POST), the BIOS will check for problems. If a problem is found, the BIOS will activate an alarm or display a message. The following is a list of such BIOS messages.

Table A-1. BIOS POST Messages

BIOS Message	Description
Failure Fixed Disk	Fixed disk is not working or not configured properly. Check to see if fixed disk is attached properly. Run Setup. Find out if the fixed-disk type is correctly identified.
Stuck key	Stuck key on keyboard.
Keyboard error	Keyboard not working.
Keyboard Controller Failed	Keyboard controller failed test. May require replacing keyboard controller.
Keyboard locked - Unlock key switch	Unlock the system to proceed.
Monitor type does not match CMOS - Run SETUP	Monitor type not correctly identified in Setup
Shadow Ram Failed at offset: nnnn	Shadow RAM failed at offset nnnn of the 64k block at which the error was detected.
System RAM Failed at offset: nnnn	System RAM failed at offset nnnn of in the 64k block at which the error was detected.
Extended RAM Failed at offset: nnnn	Extended memory not working or not configured properly at offset nnnn .
System battery is dead - Replace and run SETUP	The CMOS clock battery indicator shows the battery is dead. Replace the battery and run Setup to reconfigure the system.
System CMOS checksum bad - Default configuration used	System CMOS has been corrupted or modified incorrectly, perhaps by an application program that changes data stored in CMOS. The BIOS installed Default Setup Values. If you do not want these values, enter Setup and enter your own values. If the error persists, check the system battery or contact your dealer.
System timer error	The timer test failed. Requires repair of system board.
Real time clock error	Real-Time Clock fails BIOS hardware test. May require board repair.
Check date and time settings	BIOS found date or time out of range and reset the Real-Time Clock. May require setting legal date (1991-2099).

Table A-1. BIOS POST Messages (Continued)

BIOS Message	Description
Previous boot incomplete - Default configuration used	Previous POST did not complete successfully. POST loads default values and offers to run Setup. If the failure was caused by incorrect values and they are not corrected, the next boot will likely fail. On systems with control of wait states , improper Setup settings can also terminate POST and cause this error on the next boot. Run Setup and verify that the waitstate configuration is correct. This error is cleared the next time the system is booted.
Memory Size found by POST differed from CMOS	Memory size found by POST differed from CMOS.
Diskette drive A error Diskette drive B error	Drive A: or B: is present but fails the BIOS POST diskette tests. Check to see that the drive is defined with the proper diskette type in Setup and that the diskette drive is attached correctly.
Incorrect Drive A type - run SETUP	Type of floppy drive A: not correctly identified in Setup.
Incorrect Drive B type - run SETUP	Type of floppy drive B: not correctly identified in Setup.
System cache error - Cache disabled	RAM cache failed and BIOS disabled the cache. On older boards, check the cache jumpers. You may have to replace the cache. See your dealer. A disabled cache slows system performance considerably.
CPU ID:	CPU socket number for Multi-Processor error.
EISA CMOS not writeable	ServerBIOS2 test error: Cannot write to EISA CMOS.
DMA Test Failed	ServerBIOS2 test error: Cannot write to extended DMA (Direct Memory Access) registers.
Software NMI Failed	ServerBIOS2 test error: Cannot generate software NMI (Non-Maskable Interrupt).
Fail-Safe Timer NMI Failed	ServerBIOS2 test error: Fail-Safe Timer takes too long.
device Address Conflict	Address conflict for specified device .
Allocation Error for: device	Run ISA or EISA Configuration Utility to resolve resource conflict for the specified device .
CD ROM Drive	CD ROM Drive identified.
Entering SETUP...	Starting Setup program
Failing Bits: nnnn	The hex number nnnn is a map of the bits at the RAM address which failed the memory test. Each 1 (one) in the map indicates a failed bit. See errors 230, 231, or 232 above for offset address of the failure in System, Extended, or Shadow memory.
Fixed Disk n	Fixed disk n (0-3) identified.
Invalid System Configuration Data	Problem with NVRAM (CMOS) data.
I/O device IRQ conflict	I/O device IRQ conflict error.
PS/2 Mouse Boot Summary Screen:	PS/2 Mouse installed.

Table A-1. BIOS POST Messages (Continued)

BIOS Message	Description
nxxx kB Extended RAM Passed	Where xxxx is the amount of RAM in kilobytes successfully tested.
nxxx Cache SRAM Passed	Where xxxx is the amount of system cache in kilobytes successfully tested.
xxxx kB Shadow RAM Passed	Where xxxx is the amount of shadow RAM in kilobytes successfully tested.
xxxx kB System RAM Passed	Where xxxx is the amount of system RAM in kilobytes successfully tested.
One or more I2O Block Storage Devices were excluded from the Setup Boot Menu	There was not enough room in the IPL table to display all installed I2O block-storage devices.
Operating system not found	Operating system cannot be located on either drive A: or drive C:. Enter Setup and see if fixed disk and drive A: are properly identified.
Parity Check 1 nxxx	Parity error found in the system bus. BIOS attempts to locate the address and display it on the screen. If it cannot locate the address, it displays ???? . Parity is a method for checking errors in binary data. A parity error indicates that some data has been corrupted.
Parity Check 2 nxxx	Parity error found in the I/O bus. BIOS attempts to locate the address and display it on the screen. If it cannot locate the address, it displays ???? .
Press <F1> to resume, <F2> to Setup, <F3> for previous	Displayed after any recoverable error message. Press <F1> to start the boot process or <F2> to enter Setup and change the settings. Press <F3> to display the previous screen (usually an initialization error of an Option ROM , i.e., an add-on card). Write down and follow the information shown on the screen.
Press <F2> to enter Setup	Optional message displayed during POST. Can be turned off in Setup.
PS/2 Mouse:	PS/2 mouse identified.
Run the I2O Configuration Utility	One or more unclaimed block storage devices have the Configuration Request bit set in the LCT. Run an I2O Configuration Utility (e.g. the SAC utility).
System BIOS shadowed	System BIOS copied to shadow RAM.
UMB upper limit segment address: nxxx	Displays the address xxxx of the upper limit of Upper Memory Blocks , indicating released segments of the BIOS which can be reclaimed by a virtual memory manager.
Video BIOS shadowed	Video BIOS successfully copied to shadow RAM.

A-2 BIOS POST Codes

This section lists the POST (Power-On Self-Test) codes for the AMI BIOS. POST codes are divided into two categories: recoverable and terminal.

Recoverable POST Errors

When a recoverable type of error occurs during POST, the BIOS will display an POST code that describes the problem. BIOS may also issue one of the following beep codes:

- **One long and two short beeps** – video configuration error
- **One repetitive long beep** – no memory detected

Terminal POST Errors

If a terminal type of error occurs, BIOS will shut down the system. Before doing so, BIOS will write the error to *port 80h*, attempt to initialize video and write the error in the top left corner of the screen.

The following is a list of codes that may be written to *port 80h*.

Table A-2. Terminal POST Errors

Post Code	Description
02h	Verify Real Mode
03h	Disable Non-Maskable Interrupt (NMI)
04h	Get CPU type
06h	Initialize system hardware
07h	Disable shadow and execute code from the ROM.
08h	Initialize chipset with initial POST values
09h	Set IN POST flag
0Ah	Initialize CPU registers
0Bh	Enable CPU cache
0Ch	Initialize caches to initial POST values
0Eh	Initialize I/O component
0Fh	Initialize the local bus IDE
10h	Initialize Power Management
11h	Load alternate registers with initial POST values
12h	Restore CPU control word during warm boot
13h	Initialize PCI Bus Mastering devices
14h	Initialize keyboard controller
16h	1-2-2-3 BIOS ROM checksum
17h	Initialize cache before memory Auto size
18h	8254 timer initialization
1Ah	8237 DMA controller initialization
1Ch	Reset Programmable Interrupt Controller
20h	1-3-1-1 Test DRAM refresh

Table A-2. Terminal POST Errors (Continued)

Post Code	Description
22h	1-3-1-3 Test 8742 Keyboard Controller
28h	Auto size DRAM
29h	Initialize POST Memory Manager
2Ah	Clear 512 kB base RAM
2Ch	1-3-4-1 RAM failure on address line xxxx*
2Eh	1-3-4-3 RAM failure on data bits xxxx* of low byte of memory bus
2Fh	Enable cache before system BIOS shadow
32h	Test CPU bus-clock frequency
33h	Initialize Phoenix Dispatch Manager
36h	Warm start shut down
38h	Shadow system BIOS ROM
3Ah	Auto size cache
3Ch	Advanced configuration of chipset registers
3Dh	Load alternate registers with CMOS values
41h	Initialize extended memory for RomPilot
42h	Initialize interrupt vectors
45h	POST device initialization
46h	2-1-2-3 Check ROM copyright notice
47h	Initialize I20 support
48h	Check video configuration against CMOS
49h	Initialize PCI bus and devices
4Ah	Initialize all video adapters in system
4Bh	QuietBoot start (optional)
4Ch	Shadow video BIOS ROM
4Eh	Display BIOS copyright notice
4Fh	Initialize MultiBoot
50h	Display CPU type and speed
51h	Initialize EISA board
52h	Test keyboard
54h	Set key click if enabled
55h	Enable USB devices
58h	2-2-3-1 Test for unexpected interrupts
59h	Initialize POST display service
5Ah	Display prompt "Press F2 to enter SETUP"
5Bh	Disable CPU cache

Table A-2. Terminal POST Errors (Continued)

Post Code	Description
5Ch	Test RAM between 512 and 640 kB
60h	Test extended memory
62h	Test extended memory address lines
64h	Jump to UserPatch1
66h	Configure advanced cache registers
67h	Initialize Multi Processor APIC
68h	Enable external and CPU caches
69h	Setup System Management Mode (SMM) area
6Ah	Display external L2 cache size
6Bh	Load custom defaults (optional)
6Ch	Display shadow-area message
6Eh	Display possible high address for UMB recovery
70h	Display error messages
72h	Check for configuration errors
76h	Check for keyboard errors
7Ch	Set up hardware interrupt vectors
7Dh	Initialize Intelligent System Monitoring
7Eh	Initialize coprocessor if present
80h	Disable onboard Super I/O ports and IRQs
81h	Late POST device initialization
82h	Detect and install external RS232 ports
83h	Configure non-MCD IDE controllers
84h	Detect and install external parallel ports
85h	Initialize PC-compatible PnP ISA devices
86h	Re-initialize onboard I/O ports.
87h	Configure Motherboard Configurable Devices (optional)
88h	Initialize BIOS Data Area
89h	Enable Non-Maskable Interrupts (NMIs)
8Ah	Initialize Extended BIOS Data Area
8Bh	Test and initialize PS/2 mouse
8Ch	Initialize floppy controller
8Fh	Determine number of ATA drives (optional)
90h	Initialize hard-disk controllers
91h	Initialize local-bus hard-disk controllers
92h	Jump to UserPatch2

Table A-2. Terminal POST Errors (Continued)

Post Code	Description
93h	Build MPTABLE for multi-processor boards
95h	Install CD ROM for boot
96h	Clear huge ES segment register
98h	1-2 Search for option ROMs. One long, two short beeps on check-sum failure
99h	Check for SMART Drive (optional)
9Ah	Shadow option ROMs
9Ch	Set up Power Management
9Dh	Initialize security engine (optional)
9Eh	Enable hardware interrupts
9Fh	Determine number of ATA and SCSI drives
A0h	Set time of day
A2h	Check key lock
A4h	Initialize typematic rate
A8h	Erase F2 prompt
AAh	Scan for F2 key stroke
ACh	Enter SETUP
A Eh	Clear Boot flag
B0h	Check for errors
B1h	Inform RomPilot about the end of POST.
B2h	POST done - prepare to boot operating system
B4h	1 One short beep before boot
B5h	Terminate QuietBoot (optional)
B6h	Check password (optional)
B7h	Initialize ACPI BIOS
B9h	Prepare Boot
BAh	Initialize SMBIOS
BBh	Initialize PnP Option ROMs
BCh	Clear parity checkers
BDh	Display MultiBoot menu
BEh	Clear screen (optional)
BFh	Check virus and backup reminders
C0h	Try to boot with INT 19
C1h	Initialize POST Error Manager (PEM)
C2h	Initialize error logging
C3h	Initialize error display function

Table A-2. Terminal POST Errors (Continued)

Post Code	Description
C4h	Initialize system error handler
C5h	PnPnd dual CMOS (optional)
C6h	Initialize note dock (optional)
C7h	Initialize note dock late
C8h	Force check (optional)
C9h	Extended checksum (optional)
CAh	Redirect Int 15h to enable remote keyboard
CBh	Redirect Int 13h to Memory Technologies Devices such as ROM, RAM, PCMCIA, and serial disk
CCh	Redirect Int 10h to enable remote serial video
CDh	Re-map I/O and memory for PCMCIA
CEh	Initialize digitizer and display message
D2h	Unknown interrupt

The following are for the boot block in Flash ROM:

Table A-3. Boot Block Flash ROM Terminal POST Errors

Post Code	Description
E0h	Initialize the chipset
E1h	Initialize the bridge
E2h	Initialize the CPU
E3h	Initialize system timer
E4h	Initialize system I/O
E5h	Check force recovery boot
E6h	Checksum BIOS ROM
E7h	Go to BIOS
E8h	Set Huge Segment
E9h	Initialize Multi Processor
EAh	Initialize OEM special code
EBh	Initialize PIC and DMA
ECh	Initialize Memory type
EDh	Initialize Memory size
EEh	Shadow Boot Block
EFh	System memory test
F0h	Initialize interrupt vectors
F1h	Initialize Run Time Clock

:

Table A-3. Boot Block Flash ROM Terminal POST Errors (Continued)

Post Code	Description
F2h	Initialize video
F3h	Initialize System Management Manager
F4h	Output one beep
F5h	Clear Huge Segment
F6h	Boot to Mini DOS
F7h	Boot to Full DOS

If the BIOS detects error 2C, 2E, or 30 (base 512K RAM error), it displays an additional word-bitmap (**xxxx**) indicating the address line or bits that failed. For example, "2C 0002" means address line 1 (bit one set) has failed. "2E 1020" means data bits 12 and 5 (bits 12 and 5 set) have failed in the lower 16 bits. The BIOS also sends the bitmap to the port-80 LED display. It first displays the checkpoint code, followed by a delay, the high-order byte, another delay, and then the low order byte of the error. It repeats this sequence continuously.

Notes

Disclaimer

The products sold by Supermicro are not intended for and will not be used in life support systems, medical equipment, nuclear facilities or systems, aircraft, aircraft devices, aircraft/emergency communication devices or other critical systems whose failure to perform be reasonably expected to result in significant injury or loss of life or catastrophic property damage. Accordingly, Supermicro disclaims any and all liability, and should buyer use or sell such products for use in such ultra-hazardous applications, it does so entirely at its own risk. Furthermore, buyer agrees to fully indemnify, defend and hold Supermicro harmless for and against any and all claims, demands, actions, litigation, and proceedings of any kind arising out of or related to such ultra-hazardous use or sale.
