

# SUPERMICRO<sup>®</sup>

## **SBI-7425C-S3/S3E Blade Modules**

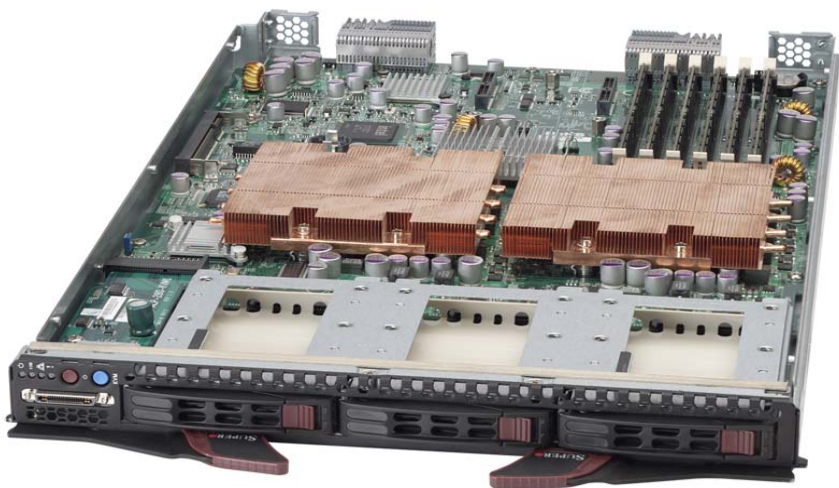

## **User's Manual**

Revision 1.0a

The information in this User's Manual has been carefully reviewed and is believed to be accurate. The vendor assumes no responsibility for any inaccuracies that may be contained in this document, makes no commitment to update or to keep current the information in this manual, or to notify any person or organization of the updates. **Please Note: For the most up-to-date version of this manual, please see our web site at [www.supermicro.com](http://www.supermicro.com).**

Super Micro Computer, Inc. ("Supermicro") reserves the right to make changes to the product described in this manual at any time and without notice. This product, including software and documentation, is the property of Supermicro and/or its licensors, and is supplied only under a license. Any use or reproduction of this product is not allowed, except as expressly permitted by the terms of said license.

IN NO EVENT WILL SUPERMICRO BE LIABLE FOR DIRECT, INDIRECT, SPECIAL, INCIDENTAL, SPECULATIVE OR CONSEQUENTIAL DAMAGES ARISING FROM THE USE OR INABILITY TO USE THIS PRODUCT OR DOCUMENTATION, EVEN IF ADVISED OF THE POSSIBILITY OF SUCH DAMAGES. IN PARTICULAR, SUPERMICRO SHALL NOT HAVE LIABILITY FOR ANY HARDWARE, SOFTWARE, OR DATA STORED OR USED WITH THE PRODUCT, INCLUDING THE COSTS OF REPAIRING, REPLACING, INTEGRATING, INSTALLING OR RECOVERING SUCH HARDWARE, SOFTWARE, OR DATA.

Any disputes arising between manufacturer and customer shall be governed by the laws of Santa Clara County in the State of California, USA. The State of California, County of Santa Clara shall be the exclusive venue for the resolution of any such disputes. Super Micro's total liability for all claims will not exceed the price paid for the hardware product.

FCC Statement: This equipment has been tested and found to comply with the limits for a Class A digital device pursuant to Part 15 of the FCC Rules. These limits are designed to provide reasonable protection against harmful interference when the equipment is operated in a commercial environment. This equipment generates, uses, and can radiate radio frequency energy and, if not installed and used in accordance with the manufacturer's instruction manual, may cause harmful interference with radio communications. Operation of this equipment in a residential area is likely to cause harmful interference, in which case you will be required to correct the interference at your own expense.

California Best Management Practices Regulations for Perchlorate Materials: This Perchlorate warning applies only to products containing CR (Manganese Dioxide) Lithium coin cells. Perchlorate Material-special handling may apply. See [www.dtsc.ca.gov/hazardouswaste/perchlorate](http://www.dtsc.ca.gov/hazardouswaste/perchlorate) for further details.



**WARNING: HANDLING OF LEAD SOLDER MATERIALS USED IN THIS PRODUCT MAY EXPOSE YOU TO LEAD, A CHEMICAL KNOWN TO THE STATE OF CALIFORNIA TO CAUSE BIRTH DEFECTS AND OTHER REPRODUCTIVE HARM.**

Manual Revision 1.0a

Release Date: May 18, 2011

Unless you request and receive written permission from Super Micro Computer, Inc., you may not copy any part of this document.

Information in this document is subject to change without notice. Other products and companies referred to herein are trademarks or registered trademarks of their respective companies or mark holders.

Copyright © 2011 by Super Micro Computer, Inc.  
All rights reserved.

**Printed in the United States of America**

---

---

# Preface

## About this Manual

This manual is written for professional system integrators, Information Technology professionals, service personnel and technicians. It provides information for the installation and use of Supermicro's SBI-7425C-S3/S3E Blade Module. Installation and maintenance should be performed by experienced professionals only.

## Manual Organization

### Chapter 1: Introduction

The first chapter provides a checklist of the main components included with SBI-7425C-S3/S3E Blade Module and describes their main features.

### Chapter 2: System Safety

You should familiarize yourself with this chapter for a general overview of safety precautions that should be followed when installing and servicing SBI-7425C-S3/S3E Blade Module.

### Chapter 3: Setup and Installation

Refer to this chapter for details on installing the SBI-7425C-S3/S3E Blade Module into the SuperBladeSuperBlade chassis. Other sections cover the installation and placement of memory modules and the installation of hard disk drives into the blade module.

### Chapter 4: Blade Module Features

This chapter covers features and component information about SBI-7425C-S3/S3E Blade Module. Included here are descriptions and information for mainboard components, connectors, LEDs and other features of the blade module.

### Chapter 5: RAID Setup Procedure

RAID setup and operations for SBI-7425C-S3/S3E Blade Module are covered in this chapter.

### Chapter 6: BIOS

BIOS setup is covered in this chapter for SBI-7425C-S3/S3E Blade Module.

### Appendix A: BIOS POST Codes

BIOS POST Codes for SBI-7425C-S3/S3E Blade Module are explained in this appendix.

### Appendix B: iSCSI Setup Procedure

The iSCSI setup procedure for the blade module is described in this appendix.

## Notes

---

---

# Table of Contents

<b>Chapter 1 Introduction</b> .....	1-1
1-1 Overview.....	1-1
1-2 Product Checklist of Typical Components.....	1-1
1-3 Blade Module Features.....	1-2
Processors.....	1-2
Memory.....	1-2
Storage.....	1-3
Density.....	1-3
1-4 Contacting Supermicro.....	1-4
<b>Chapter 2 System Safety</b> .....	2-1
2-1 Electrical Safety Precautions.....	2-1
2-2 General Safety Precautions.....	2-2
2-3 Electrostatic Discharge Precautions.....	2-2
2-4 Operating Precautions.....	2-2
<b>Chapter 3 Setup and Installation</b> .....	3-1
3-1 Overview.....	3-1
3-2 Installing Blade Modules.....	3-1
Powering Up a Blade Unit.....	3-1
Powering Down a Blade Unit.....	3-1
Removing a Blade Unit from the Enclosure.....	3-1
Removing/Replacing the Blade Cover.....	3-2
Installing a Blade Unit into the Enclosure.....	3-2
3-3 Processor Installation.....	3-4
3-4 Onboard Battery Installation.....	3-5
3-5 Memory Installation.....	3-6
Populating Memory Slots.....	3-6
DIMM Installation.....	3-7
3-6 Hard Disk Drive Installation.....	3-8
3-7 Installing the Operating System.....	3-9
Installing with an External USB CD-ROM Drive.....	3-10
Installing via PXE Boot.....	3-10
Installing via Virtual Media (Drive Redirection).....	3-10
3-8 Management Software.....	3-11

3-9 Configuring and Setting up RAID .....	3-11
<b>Chapter 4 Blade Module Features</b> .....	<b>4-1</b>
4-1 Control Panel .....	4-2
Power Button .....	4-3
KVM Button .....	4-3
LED Indicators .....	4-3
KVM Connector .....	4-3
4-2 Mainboard .....	4-4
Jumpers .....	4-6
CMOS Clear .....	4-6
4-3 Blade Unit Components .....	4-6
Memory Support .....	4-7
Hard Disk Drives .....	4-7
<b>Chapter 5 RAID Setup Procedure</b> .....	<b>5-1</b>
5-1 RAID Configurations .....	5-1
5-2 Preparing for Setup .....	5-1
5-3 RAID Setup Procedure .....	5-2
Starting The MegaRAID BIOS Configuration Utility .....	5-2
Using Easy Configuration .....	5-3
Using New Configuration and View/Add Configuration .....	5-4
Initializing Virtual Drives .....	5-6
First Initialization Method .....	5-6
Second Initialization Method .....	5-7
<b>Chapter 6 BIOS</b> .....	<b>6-1</b>
6-1 Introduction .....	6-1
System BIOS .....	6-1
How To Change the Configuration Data .....	6-1
Starting the Setup Utility .....	6-1
6-2 BIOS Updates .....	6-2
Flashing BIOS .....	6-2
6-3 Running Setup .....	6-3
6-4 Main BIOS Setup .....	6-4
6-5 Advanced Setup .....	6-5
Boot Features Submenu .....	6-7
Memory Cache Submenu .....	6-8
PCI Configuration Submenu .....	6-10

Advanced Chipset Control Submenu .....	6-11
Advanced Processor Options Submenu .....	6-12
I/O Device Configuration Submenu .....	6-14
DMI Event Logging Submenu .....	6-15
Console Redirection Submenu .....	6-16
Hardware Monitor Submenu .....	6-17
IPMI Submenu .....	6-19
6-6 Security .....	6-20
6-7 Boot .....	6-21
Boot Priority Order/Excluded from Boot Order.....	6-22
6-8 Exit.....	6-22
<b>Appendix A BIOS POST Codes .....</b>	<b>A-1</b>
A-1 BIOS POST Messages .....	A-1
A-2 BIOS POST Codes.....	A-3
Recoverable POST Errors .....	A-4
Terminal POST Errors.....	A-4
<b>Appendix B iSCSI Setup Procedure.....</b>	<b>B-1</b>

## Notes

---

---

# List of Figures

Figure 1-1. Full Rack of Blade Enclosures and Blade Servers .....	1-3
Figure 3-1. Inserting a Blade into the Enclosure .....	3-3
Figure 3-2. Locking the Blade into Position.....	3-3
Figure 3-3. Installing a Processor in a Socket.....	3-5
Figure 3-4. Installing the Onboard Battery .....	3-6
Figure 3-5. 6-slot DIMM Numbering.....	3-7
Figure 3-6. Installing a DIMM into a Memory Slot.....	3-8
Figure 3-7. Installing a Hard Drive in a Carrier.....	3-9
Figure 4-1. SBI-7425C-S3/S3E Blade Unit Front View .....	4-1
Figure 4-2. Blade Control Panel.....	4-2
Figure 4-3. B7DC3 Mainboard .....	4-4
Figure 4-4. Intel 5100/Intel ICH9R Chipset: Block Diagram.....	4-5
Figure 4-5. Exploded View of a SBI-7425C-S3/S3E Blade Module .....	4-6
Figure 5-1. RAID Configuration Utility Management Menu Screen.....	5-2
Figure 5-2. Virtual Drives Configured Screen .....	5-4
Figure 5-3. Virtual Drives List Screen .....	5-7
Figure 6-1. Main BIOS Setup Menu .....	6-4
Figure 6-2. Advanced Setup Menu .....	6-5
Figure 7. Boot Features Submenu .....	6-7
Figure 6-1. Memory Cache Submenu .....	6-8
Figure 6-2. PCI Configuration Submenu .....	6-10
Figure 6-3. Advanced Chipset Control Submenu.....	6-11
Figure 6-4. Advanced Processor Options Submenu.....	6-12
Figure 6-5. I/O Device Configuration Submenu .....	6-14
Figure 6-6. DMI Event Logging Submenu .....	6-15
Figure 6-7. Console Redirection Submenu .....	6-16
Figure 6-8. Hardware Monitor Submenu.....	6-17
Figure 6-9. Security Menu .....	6-20
Figure 6-10. Boot Menu .....	6-21
Figure 6-11. Exit Menu.....	6-22
Figure B-1. Microsoft MPIO Multipathing Support for iSCSI Check Box.....	B-2
Figure B-2. Configure iSCSI Network Boot Support Check Box .....	B-3

## Notes

---

---

# List of Tables

Table 1-1. SBI-7425C-S3/S3E Blade Specification Features .....	1-2
Table 3-1. Populating Eight Memory Slots for Interleaved Operation .....	3-6
Table 4-1. SBI-7425C-S3/S3E Blade Unit Features .....	4-1
Table 4-2. Blade Control Panel .....	4-2
Table 4-3. Blade Module LED Indicators .....	4-3
Table 4-4. B7DC3 Mainboard Layout .....	4-5
Table 4-5. Main Components of a SBI-7425C-S3/S3E Blade Module .....	4-7
Table 6-1. Main BIOS Setup Menu Options .....	6-4
Table 6-2. Advanced Setup Menu Options .....	6-5
Table 6-3. Boot Features Submenu Menu Options .....	6-7
Table 6-4. Memory Cache Submenu Menu Options .....	6-9
Table 6-5. PCI Configuration Submenu Menu Options .....	6-10
Table 6-6. Advanced Chipset Control Submenu Menu Options .....	6-11
Table 6-7. Advanced Processor Options Submenu Menu Options .....	6-13
Table 6-8. I/O Device Configuration Submenu Menu Options .....	6-14
Table 6-9. DMI Event Logging Submenu Menu Options .....	6-15
Table 6-10. Console Redirection Submenu Menu Options .....	6-17
Table 6-11. Hardware Monitor Submenu Menu Options .....	6-18
Table 6-12. IPMI Submenu Menu Options .....	6-19
Table 6-13. Security Menu Options .....	6-20
Table 6-14. Exit Menu Options .....	6-23
Table A-1. BIOS POST Messages .....	A-1
Table A-2. Terminal POST Errors .....	A-4
Table A-3. Boot Block Flash ROM Terminal POST Errors .....	A-8

## Notes

---

---

# Chapter 1

## Introduction

### 1-1 Overview

This user's manual covers both the SBI-7425C-S3 and SBI-7425C-S3E blade modules. The only difference between these two modules and their respective B7DC3 and B7DC3-IB mainboards is the Infiniband support found in the SBI-7125C-S3E blade module.

The SBI-7425C-S3/S3E blade modules are compact self-contained servers that connect into a pre-cabled enclosure that provides power, cooling, management and networking functions. One enclosure for the SBI-7425C-S3/S3E blade modules can hold fourteen blade units.

In this manual, "blade system" refers to the entire system (including the enclosure and blades units), "blade" or "blade unit" refers to a single blade module and "blade enclosure" is the chassis that the blades, power supplies and modules are housed within.

Please refer to our web site for information on operating systems that have been certified for use with the SuperBlade ([www.supermicro.com/products/superblade/](http://www.supermicro.com/products/superblade/)).

### 1-2 Product Checklist of Typical Components

Your blade module ships with its mainboard already installed in its chassis. Memory, hard disk drives and the CPU must all be installed by the user after shipment. See [Chapter 3: "Setup and Installation" on page 3-1](#) for details on installation of these components.

Aside from the blade module unit itself, the following optional add-on cards may be ordered for your blade module:

- Blade IPMI Add-on Card: AOC-SIMPL
- Mezzanine Cards (with Infiniband Switch): AOC-IBH-001, AOC-IBH-002 or AOC-IBH-003

See the [Supermicro website](#) and the *SuperBlade Network Modules User's Manual* on your SuperBlade system's CD-ROM for more details on these add-on cards.

## 1-3 Blade Module Features

**Table 1-1** lists the main features of the SBI-7425C-S3/S3E blade modules. See the proceeding section for components typically included in a blade system and other optional components. Specific details on the SBI-7425C-S3/S3E blade modules is found in **Chapter 4: "Blade Module Features"** on page 4-1.

**Table 1-1. SBI-7425C-S3/S3E Blade Specification Features**

Mainboard	B7DC3/B7DC3-IB (proprietary form factor) Chassis Dimensions (HxWxD): 11.32" x 1.19" x 18.9"
Processors	Dual or quad core Intel™ Xeon® 5400/5300/5200/5100/5000 Sequence processors. Please refer to our web site for a complete listing of supported processors.
FSB Speed	1333/1066 MHz front side (system) bus speed
Chipset	Intel 5100/Intel ICH9R
Graphics Controller	Onboard ATI ES1000 graphics chip with 32 MB of SDRAM
BIOS	16 Mb Phoenix® Flash ROM
Memory Capacity	Six 240-pin DIMM sockets supporting up to 24 GB of ECC Registered DDR2-667/533 SDRAM.
SATA Controller	Intel ICH9R on-chip controller for three Serial ATA drives
Hard Drive Bays	Includes three hot-swap drive bays for 2.5" SATA disk drives

### Processors

The SBI-7425C-S3/S3E blade modules support dual 771-pin Intel Xeon 5400/5300/5200/5100/5000 series processors.

Refer to the Supermicro web site for a complete listing of supported processors (<http://www.supermicro.com/products/superblade>). Please note that you will need to check the detailed specifications of a particular blade module for a list of the CPUs it supports.

Details on installation of the processor into the SBI-7425C-S3/S3E blade modules are found in **Chapter 3: "Setup and Installation"** on page 3-1.

### Memory

Both the SBI-7425C-S3/S3E blade modules have eight 240-pin DIMM sockets that can support up to 24 GB of ECC Registered DDR2-667/533 SDRAM. Memory is interleaved, which requires modules of the same size and speed to be installed in groups (of two or three).

Please refer to the Supermicro web site for a list of supported memory ([www.supermicro.com/products/superblade](http://www.supermicro.com/products/superblade)). The detailed specifications for a blade module will contain a link to a list of recommended memory sizes and manufacturers.

Details on installation of memory modules into the SBI-7425C-S3/S3E blade modules are found in **Chapter 3: "Setup and Installation"** on page 3-1.

## Storage

The SBI-7425C-S3/S3E blade modules can have three 2.5-inch SATA (Serial ATA) hard disk drives in front-mounted easy removable carriers. See [Chapter 3: "Setup and Installation" on page 3-1](#) for storage installation details.

## Density

A maximum of fourteen blade modules may be installed into a single blade enclosure. Each blade enclosure is a 7U form factor, so a standard 42U rack may accommodate up to six enclosures with 84 blade modules, or the equivalent of 84 1U servers. With the inclusion of six CMM modules, twelve Gigabit Ethernet switches and six InfiniBand switches, this would occupy up to 108U space in a conventional 1U server configuration.

[Figure 1-1](#) displays a view of a full rack with six blade enclosures in it, each with fourteen blades to an enclosure.

**Figure 1-1. Full Rack of Blade Enclosures and Blade Servers**



## 1-4 Contacting Supermicro

### Headquarters

Address: Super Micro Computer, Inc.  
980 Rock Ave.  
San Jose, CA 95131 U.S.A.

Tel: +1 (408) 503-8000

Fax: +1 (408) 503-8008

Email: [marketing@supermicro.com](mailto:marketing@supermicro.com) (General Information)  
[support@supermicro.com](mailto:support@supermicro.com) (Technical Support)

Web Site: [www.supermicro.com](http://www.supermicro.com)

### Europe

Address: Super Micro Computer B.V.  
Het Sterrenbeeld 28, 5215 ML  
's-Hertogenbosch, The Netherlands

Tel: +31 (0) 73-6400390

Fax: +31 (0) 73-6416525

Email: [sales@supermicro.nl](mailto:sales@supermicro.nl) (General Information)  
[support@supermicro.nl](mailto:support@supermicro.nl) (Technical Support)  
[rma@supermicro.nl](mailto:rma@supermicro.nl) (Customer Support)

### Asia-Pacific

Address: Super Micro Computer, Inc.  
4F, No. 232-1, Liancheng Rd.  
Chung-Ho 235, Taipei County  
Taiwan, R.O.C.

Tel: +886-(2) 8226-3990

Fax: +886-(2) 8226-3991

Web Site: [www.supermicro.com.tw](http://www.supermicro.com.tw)

Technical Support:

Email: [support@supermicro.com.tw](mailto:support@supermicro.com.tw)

Tel: +886-2-8228-1366, ext. 132 or 139

---

---

# Chapter 2

## System Safety

### 2-1 Electrical Safety Precautions

Basic electrical safety precautions should be followed to protect yourself from harm and the SuperBlade from damage:

- Be aware of how to power on/off the enclosure power supplies and the individual blades as well as the room's emergency power-off switch, disconnection switch or electrical outlet. If an electrical accident occurs, you can then quickly remove power from the system.
- Do not work alone when working with high voltage components.
- Power should always be disconnected from the blade module when removing or installing such system components as the mainboard, memory modules and processors.
- When working around exposed electrical circuits, another person who is familiar with the power-off controls should be nearby to switch off the power if necessary.
- Use only one hand when working with powered-on electrical equipment. This is to avoid making a complete circuit, which will cause electrical shock. Use extreme caution when using metal tools, which can easily damage any electrical components or circuit boards they come into contact with.
- Do not use mats designed to decrease electrostatic discharge as protection from electrical shock. Instead, use rubber mats that have been specifically designed as electrical insulators.
- The power supply power cords must include a grounding plug and must be plugged into grounded electrical outlets. Power input requires 110-240 VAC, depending upon your power supply module.
- Mainboard Battery: This battery must be replaced only with the same or an equivalent type recommended by the manufacturer (CR2032 Lithium 3V battery). Dispose of used batteries according to the manufacturer's instructions.



**WARNING:** There is a danger of explosion if the onboard battery is installed upside down, which will reverse its polarities.

- Mainboard replaceable soldered-in fuses: Self-resetting PTC (Positive Temperature Coefficient) fuses on the mainboard must be replaced by trained service technicians only. The new fuse must be the same or equivalent as the one replaced. Contact technical support for details and support.

## 2-2 General Safety Precautions

Follow these rules to ensure general safety:

- Keep the area around the SuperBlade clean and free of clutter.
- Place the blade module cover and any system components that have been removed away from the system or on a table so that they won't accidentally be stepped on.
- While working on the system, do not wear loose clothing such as neckties and unbuttoned shirt sleeves, which can come into contact with electrical circuits or be pulled into a cooling fan.
- Remove any jewelry or metal objects from your body, which are excellent metal conductors that can create short circuits and harm you if they come into contact with printed circuit boards or areas where power is present.
- After accessing the inside of the system, replace the blade module's cover before installing it back into the blade enclosure.

## 2-3 Electrostatic Discharge Precautions

Electrostatic discharge (ESD) is generated by two objects with different electrical charges coming into contact with each other. An electrical discharge is created to neutralize this difference, which can damage electronic components and printed circuit boards.

The following measures are generally sufficient to neutralize this difference **before** contact is made to protect your equipment from ESD:

- Use a grounded wrist strap designed to prevent static discharge.
- Keep all components and printed circuit boards (PCBs) in their antistatic bags until ready for use.
- Touch a grounded metal object before removing the board from the antistatic bag.
- Do not let components or PCBs come into contact with your clothing, which may retain a charge even if you are wearing a wrist strap.
- Handle a board by its edges only; do not touch its components, peripheral chips, memory modules or contacts.
- When handling chips or modules, avoid touching their pins.
- Put the mainboard and peripherals back into their antistatic bags when not in use.
- For grounding purposes, make sure the blade enclosure provides excellent conductivity between the power supplies, the blade modules and the mainboard.

## 2-4 Operating Precautions

Care must be taken to assure that the cover of the blade unit is in place when the blade is operating to assure proper cooling. Out of warranty damage to the blade can occur if this practice is not strictly followed.

Any drive carrier without a hard drive installed must remain fully installed in the drive bay when the blade module is operating to ensure proper airflow.

---

---

# Chapter 3

## Setup and Installation

### 3-1 Overview

This chapter covers the setup and installation of the blade module and its components.

### 3-2 Installing Blade Modules

Up to fourteen SBI-7425C-S3/S3E blade modules may be installed into a single blade enclosure. Blade modules with Windows and Linux operating systems may be mixed together in the same blade enclosure.

#### Powering Up a Blade Unit

Each blade unit may be powered on and off independently from the rest of the blades installed in the same enclosure. A blade unit may be powered up in two ways:

- Press the power button on the blade unit.
- Use IPMIView or the web-browser based management utility to apply power using either a CMM module, or by the use of an installed SIMBL add-on card in the blade module.

#### Powering Down a Blade Unit

A blade unit may be powered down in either of five ways:

- Press the power button on the blade unit.
- Use IPMIView or the web-browser based management utility to power down (if you have Operator or Admin privileges on the CMM).
- Use IPMITool when connected to the CMM to power down (if you have Operator or Admin privileges on the CMM).
- Use IPMIView or a browser connected to the SIMBL card attached to the blade to power down.
- Use IPMITool to use a Command Line Interface (CLI) to the SIMBL (if you have Operator or Admin privileges).

#### Removing a Blade Unit from the Enclosure

Although the blade system may continue to run, individual blades should always be powered down before removing them from the enclosure.

### **Removing a Blade Unit from the Enclosure**

1. Power down the blade unit (see "[Powering Down a Blade Unit](#)" above).
2. Squeeze both handles to depress the red sections then pull out both handles completely and use them to pull the blade unit from the enclosure.



**NOTE:** Blade Modules can be Hot-Plugged from the enclosure.

### **Removing/Replacing the Blade Cover**

The blade cover must be removed to access the mainboard when you need to install or remove processors, memory units, the onboard battery and so on.

#### **Removing/Replacing the Blade Cover**

1. Remove the blade unit from the enclosure (see "[Removing a Blade Unit from the Enclosure](#)" above).
2. Depress the two buttons on the cover while pushing the cover toward the rear of the blade unit. When it stops, lift the cover off the blade unit.
3. To replace the cover, fit the six grooves in the cover into the studs in the sides of the blade, then slide the cover toward the front of the blade to lock it into place.

### **Installing a Blade Unit into the Enclosure**

Make sure the cover of the blade unit has been replaced first before installing a blade unit in the enclosure.

#### **Installing a Blade Unit into the Enclosure**

1. Slowly push the blade unit into its bay with the handles fully pulled out (see [Figure 3-1](#)).
2. When the blade stops, push the handles back in to their locked position, making sure the notches in both handles catch the lip of the enclosure (see [Figure 3-2](#)).



**NOTE:** Blade Modules can be Hot-Plugged into the enclosure.



**WARNING:** Use extreme caution when inserting a blade module into the enclosure. If the blade's power connector becomes damaged, it can damage pins on other blade bays that it is inserted into.

Figure 3-1. Inserting a Blade into the Enclosure

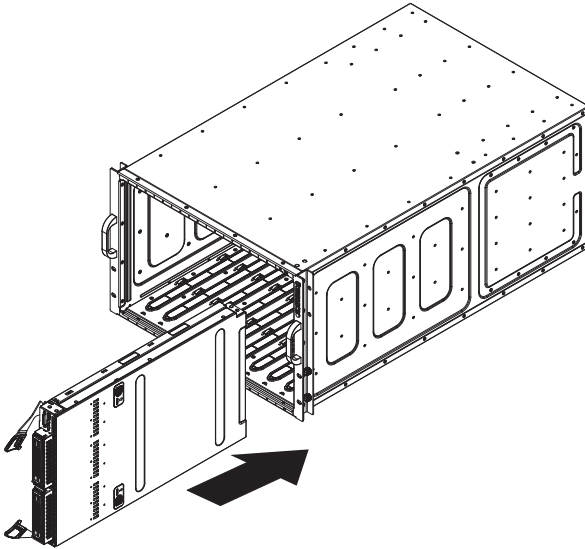
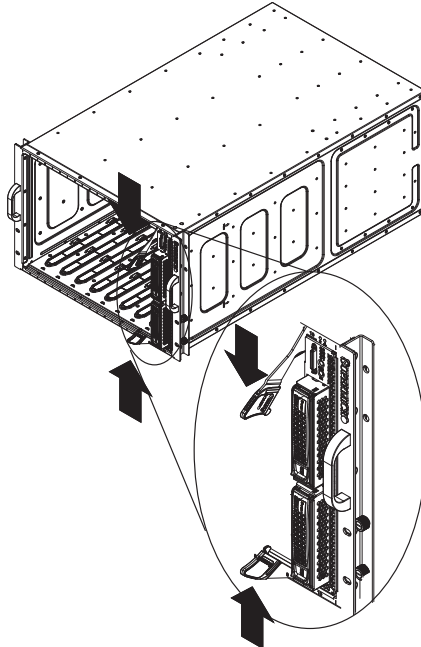

Figure 3-2. Locking the Blade into Position



### 3-3 Processor Installation

One or two processors may be installed to the mainboard of each blade unit. See [Chapter 1](#) for general information on the features of the blade unit and the [Supermicro web site](#) for further details including processor, memory and operating system support.



**WARNING:** This action should only be performed by a trained service technician. Allow the processor heatsink to cool before removing it.

#### *Removing a Processor*

1. Power down and remove the blade unit from the enclosure (see [Section 3-2: Installing Blade Modules on page 3-1](#) for details).
2. Remove the cover of the blade unit (see "[Removing/Replacing the Blade Cover](#)" on [page 3-2](#)).
3. Loosen the four screws that secure the heatsink to the mainboard.
4. Remove the heatsink by *gently* rotating it back-and-forth sideways with your fingers to release it from the processor. Set the heatsink aside and upside-down so that nothing comes into contact with the thermal grease on its underside.
5. Raise the lever of the processor socket up until the processor is released from the socket, then lift the silver cover plate and remove the processor.



**WARNING:** This action should only be performed by a trained service technician.

#### *Installing a Processor*

1. If present, remove the protective black PnP cap from the processor socket.
2. Raise the lever of the processor socket until it reaches its upper limit.
3. Lift the silver cover plate completely up and out of the way.



**NOTE:** Be careful not to damage the pins protruding from the CPU socket.

4. Align pin 1 of the processor with pin 1 of the socket (both are marked with a small gold triangle) and gently seat the processor into the socket ([Figure 3-3](#)).
5. Check to make sure the processor is flush to the socket and fully seated.
6. Lower the socket lever until it locks.
7. To install the heatsink, apply thermal grease to the top of the processor. (If reinstalling a heatsink, first clean off the old thermal grease with a clean, lint-free cloth.)

- Place the heatsink on the processor then tighten two diagonal screws until snug, then the other two screws.
- When all four screws are snug, tighten them all to secure the heatsink to the mainboard.



**NOTE:** Do not overtighten the screws as this may damage the processor or the heatsink.

- Replace the cover on the blade unit and finish by installing the unit back into the blade enclosure.

**Figure 3-3. Installing a Processor in a Socket**

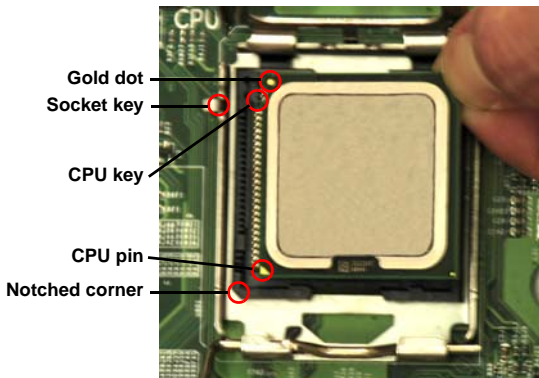

### 3-4 Onboard Battery Installation

A battery is included on the mainboard to supply certain volatile memory components with power when power has been removed from the blade module. If this battery dies, it must be replaced with an equivalent CR2032 Lithium 3V battery. Dispose of used batteries according to the manufacturer's instructions. See [Figure 3-4](#) for a diagram of installing a new onboard battery.



**WARNING:** There is a danger of explosion if the onboard battery is installed upside down, which reverses its polarities.

**Figure 3-4. Installing the Onboard Battery**

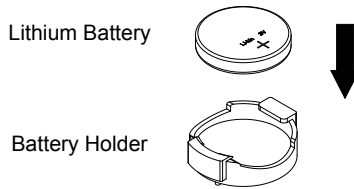

### 3-5 Memory Installation

The mainboard of each blade unit must be populated with DIMMs (Dual In-line Memory Modules) to provide system memory. **The DIMMs should all be of the same size and speed and from the same manufacturer due to compatibility issues.** See details below on supported memory and our web site ([www.supermicro.com/products/superblade](http://www.supermicro.com/products/superblade)) for recommended memory.



**WARNING:** For all SBI-7425 series blades, *ONLY*VLP (Very low profile) memory can be used.

#### Populating Memory Slots

The mainboard of a SBI-7425C-S3/S3E blade module has six memory slots. Both interleaved and non-interleaved memory are supported, so you may populate any number of DIMM slots.

Populating two slots at a time (DIMM1A + DIMM2A, DIMM3A + DIMM4A, etc.) with memory modules of the same size and of the same type will result in dual-channel, interleaved memory, which is faster than single-channel, non-interleaved memory. See [Table 3-1: "Populating Eight Memory Slots for Interleaved Operation" on page 3-6](#) for details.

**For an interleaved configuration, memory modules of the same size and speed must be installed in pairs. You should not mix DIMMs of different sizes and speeds.**

**Table 3-1. Populating Eight Memory Slots for Interleaved Operation**

Number of DIMMs	Channel 0		Channel 1		Channel 2		Channel 3	
	1A	---	2A	---	---	---	---	---
2 DIMMs	1A	---	2A	---	---	---	---	---
4 DIMMs	1A	---	2A	---	3A	---	4A	---
6 DIMMs	1A	1B	2A	2B	3A	3B	---	---



**NOTE:** The DIMM slot number specified in [Table 3-1](#) equals the DIMM slot to be populated. The “---” notation indicates that the DIMM slot should be left unpopulated.



**NOTE:** Though multiple DIMM memory module types and speeds may be supported, you need to use DIMM memory modules of the same speed and type.

**Figure 3-5. 6-slot DIMM Numbering**

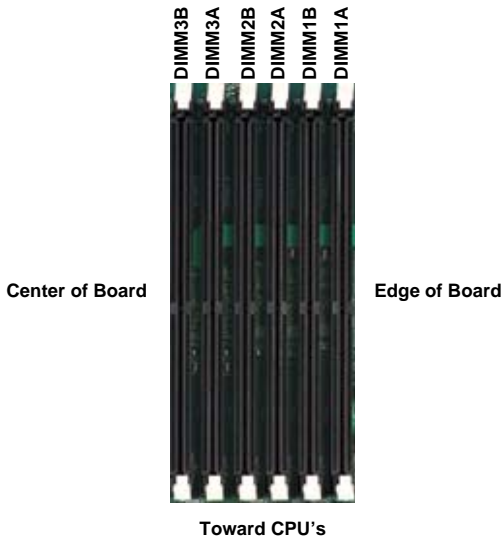

## DIMM Installation



**WARNING:** Exercise extreme care when installing or removing DIMM modules to prevent any possible damage.

### *Installing DIMM Memory Modules*

1. Power down the blade module (see ["Powering Down a Blade Unit"](#) on page 3-1).
2. Remove the blade from the enclosure and the cover from the blade (see ["Removing/Replacing the Blade Cover"](#) on page 3-2).
3. Remove the air shroud that covers the DIMM slots.

4. Insert each DIMM vertically into its slot, starting with slots 1A and 2A. Pay attention to the notch along the bottom of the module to prevent inserting the DIMM incorrectly (see [Figure 3-6](#)).

**Figure 3-6. Installing a DIMM into a Memory Slot**

**To Install:** Insert module vertically and press down until it snaps into place. Pay attention to the bottom notch.

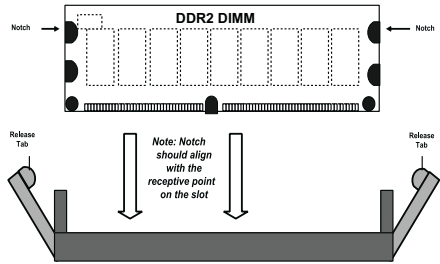

**To Remove:** Use your thumbs to gently push each release tab outward to free the DIMM from the slot.

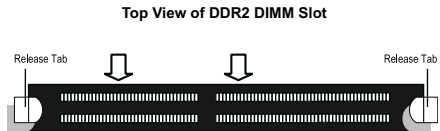

5. Gently press down on the DIMM until it snaps into place in the slot. Repeat for all modules (see [Table 3-1](#) for installing DIMMs into the slots in the correct order).
6. Replace the air shroud and the blade cover and install the blade module back into the enclosure.
7. Power up the blade unit (see ["Powering Up a Blade Unit"](#) on page 3-1).

## 3-6 Hard Disk Drive Installation

Hard disk drives are installed in "carriers" which are hot-swappable and can be removed or replaced without powering down the blade unit they reside in. A blade module needs a hard disk drive with an operating system installed to operate.



**WARNING:** To maintain proper airflow, both hard drive bays must have drive carriers inserted during operation whether or not a drive is installed in the carrier.

To remove a hard drive carrier, do the following:

### **Removing a Hard Drive Carrier**

1. Locate the colored "Open" button at the bottom of the drive carrier and press it with your thumb. This action releases the drive carrier from the drive bay.
2. Pull the release handle out about 45-degrees, then use it to pull the drive carrier out.

To Install a hard drive, use the following procedure:

### ***Installing a Hard Drive***

1. Remove a blank drive carrier from the blade (see removal procedure above).
2. Insert a drive into the carrier with the PCB side facing down and the connector end toward the rear of the carrier.
3. Align the drive in the carrier so that the screw holes of both line up. Note that there are holes in the carrier marked "SATA" to aid in correct installation.
4. Secure the drive to the carrier with six screws as shown in [Figure 3-7](#).
5. Insert the drive carrier into its slot keeping the Open button at the bottom. When the carrier reaches the rear of the bay the release handle will retract.
6. Push the handle in until you hear the carrier click into its locked position.

**Figure 3-7. Installing a Hard Drive in a Carrier**

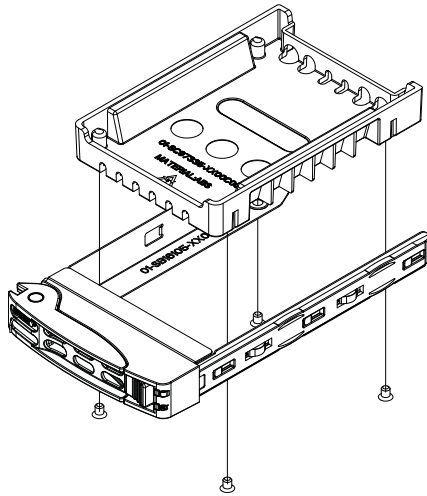

## **3-7 Installing the Operating System**

An operating system (OS) must be installed on each blade module. Blades with Microsoft Windows OS and blades with Linux OS can both occupy and operate within the same blade enclosure. Refer to the SuperMicro web site for a complete list of supported operating systems.

There are several methods of installing an OS to the blade modules.

## Installing with an External USB CD-ROM Drive

The most common method of installing the OS is with an external USB CD-ROM drive. Take the following steps to install the OS to a blade module:



**WARNING:** Installing the OS from an external CD-ROM drive may take several hours to complete.

1. Connect an SUV cable (Serial port/USB port/Video port cable) to the KVM connector on the front of the blade module. You will then need to attach a USB hub to the USB port on this cable to provide multiple USB ports.
2. Connect the external CD-ROM drive, a USB keyboard and a mouse to the USB hub. You will also need to connect a monitor to the video connector on the SUV cable. Turn on the blade module.
3. Insert the CD containing the OS into the CD-ROM drive.
4. Follow the prompts to begin the installation.

## Installing via PXE Boot

PXE (Preboot Execution Environment) is used to boot a computer over a network. To install the OS via PXE, the following conditions must be met:

1. The PXE BOOT option in BIOS must be enabled.
2. A PXE server has been configured (this can be another blade in the system).
3. The PXE server must be connected over a network to the blade to be booted.
4. The blade has only non-partitioned/unformatted hard drives installed and no bootable devices attached to it.

Once these conditions are met, make sure the PXE server is running. Then turn on the blade on which you wish to boot and/or install the OS. The BIOS in the blade will look at all bootable devices and finding none will connect to the PXE server to begin the boot/install.

## Installing via Virtual Media (Drive Redirection)

You can install the OS via Virtual Media through either the *IPMIview* (Java based client utility), *IPMItool* or the *Web-based Management Utility*. With this method, the OS is installed from an ISO image that resides on another system/blade.

Refer to the manuals on your SuperBlade CD-ROM for further details on the Virtual Media (CD-ROM or Drive Redirection) sections of these two utility programs.

## 3-8 Management Software

System management may be performed with either of three software packages: *IPMIview*, *IPMItool* or a *Web-based Management Utility*. These are designed to provide an administrator with a comprehensive set of functions and monitored data to keep tabs on the system and perform management activities.

Refer to the manuals on your SuperBlade CD-ROM for further details on the various functions provided by these management programs.

## 3-9 Configuring and Setting up RAID

Each blade module that supports two or more hard drives may be used to create a RAID array. The procedures for doing this vary depending upon the blade model chosen for your SuperBlade system.

See [Chapter 5](#) for details on how to configure and set up RAID on your blade module.

## Notes

---

---

# Chapter 4

## Blade Module Features

Figure 4-1. SBI-7425C-S3/S3E Blade Unit Front View

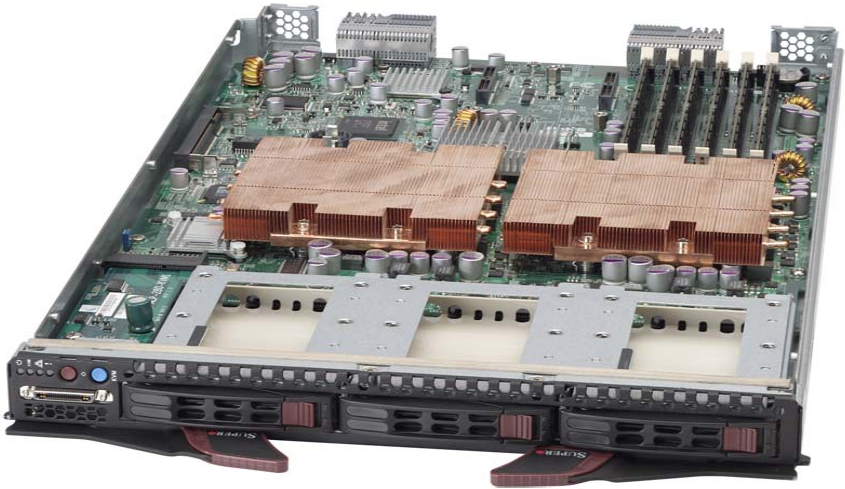

This chapter describes the SBI-7425C-S3/S3E blade unit. Installation and maintenance should be performed by experienced technicians only.

See [Figure 4-1](#) for a front view of the blade unit and [Table 4-1](#) for its features.

Table 4-1. SBI-7425C-S3/S3E Blade Unit Features

Feature	Description
Processors	Supports single or dual 771-pin Intel Xeon 5400/5300/5200/5100 series processors
Memory	Supports up to 24 GB of ECC Registered DDR2-667/533 SDRAM in six DIMM slots
Storage	Three hot-plug 2.5" hot-plug SAS/SATA hard disk drives
Ports	KVM port (1), SATA ports (3)
Features	Onboard ATI ES1000 graphics chip with 32MB of SDRAM, IPMI 2.0, ATA/100, Plug and Play, APM 1.2, DMI 2.3, PCI 2.2, ACPI 1.0/2.0, SMBIOS 2.3, Real Time Clock, Watch Dog,
Power Consumption	Base Power Draw (~35W) / Power per CPU (50W/80W/120W) / Power per DIMM (typically 14.5W)

## 4-1 Control Panel

Each blade has a similar control panel (Figure 4-2) with power on/off button, a KVM connector, a KVM button and four LEDs on the top front of the unit. The numbers mentioned in Figure 4-2 are described in Table 4-2.

Figure 4-2. Blade Control Panel

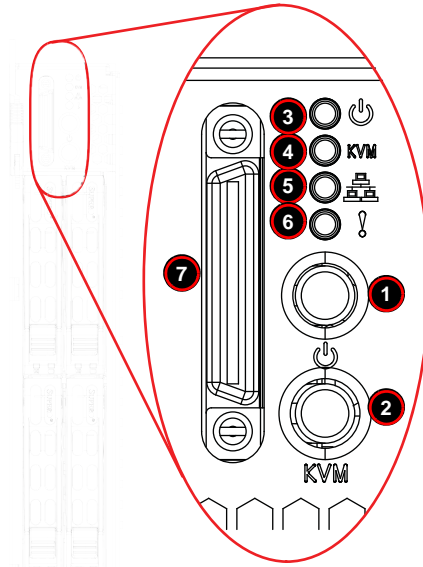

Table 4-2. Blade Control Panel

Item	Function	State	Description
1	Power Button	N/A	Turns blade module on and off
2	KVM Button	N/A	Initiates KVM function
3	Power LED	Green	Indicates power status "On"
		Orange	Indicates power status "Off" (with power cables plugged in)
4	KVM/UID LED	Blue	Indicates KVM being utilized on blade unit
		Flashing Blue	Indicates UID activated on blade module
5	Network/IB LED	Flashing Green	Indicates network activity over LAN
		Flashing Orange	Indicates network activity over InfiniBand module
6	System Fault LED	Red	Indicates a memory error, overheat, VGA error or any error that prevents booting
7	KVM Connector	N/A	Connector for SUV/KVM cable

## Power Button

Each blade has its own power button so that individual blade units within the enclosure may be turned on or off independently of the others. Press the power button (#1) to turn on the blade server. The power LED (#3) will turn green. To turn off, press and hold the power button for >4 seconds and the power LED will turn orange.

## KVM Button

KVM stands for Keyboard/Video/Mouse. With KVM, a user can control multiple blades with a single keyboard/video/mouse setup. Connect your keyboard, mouse and monitor to the USB and VGA connectors on the CMM module, then push the KVM button on the control panel of the blade module you wish to access.

## LED Indicators

Blade module LEDs are described below in [Table 4-3](#).

**Table 4-3. Blade Module LED Indicators**

LED	State	Description
Power LED	Green	Power On
	Amber	Standby
	Red	Power Failure <sup>a</sup>
KVM/UID LED (Blue)	Steady On	Indicates that KVM has been initialized on this blade module
	Flashing	Serves as a UID indicator (the UID function is activated with a management program)
Network LED (Green)	Flashing	Flashes on and off to indicate traffic (Tx and Rx data) on the LAN connection to this blade module.
System Fault LED (Red)	Steady On	This LED illuminates red when a fatal error occurs. This may be the result of a memory error, a VGA error or any other fatal error that prevents the operating system from booting up.

- a. In the event of a power failure, the N+1 Redundant Power Supply (if included in your system's configuration) automatically turns on and picks up the system load to provide uninterrupted operation. The failed power supply should be replaced with a new one as soon as possible.

## KVM Connector

Alternatively, you may connect a KVM cable (CBL-0218L, with a keyboard/video/mouse attached) to the KVM connector (#7) of the blade you wish to access. To switch to another blade, disconnect the cable then reconnect it to the new blade.

See the *Web-based Management Utility User's Manual* on your SuperBlade system CD-ROM for further details on using the KVM function remotely.

## 4-2 Mainboard

The mainboard of the SBI-7425C-S3/S3E blade unit is a proprietary design, which is based on the Intel 5100/Intel ICH9R chipset. See [Figure 4-4](#) for a block diagram of this chipset, [Figure 4-3](#) for a view of the B7DC3 mainboard and [Figure 4-5](#) for an exploded view diagram of the blade unit.

Figure 4-3. B7DC3 Mainboard

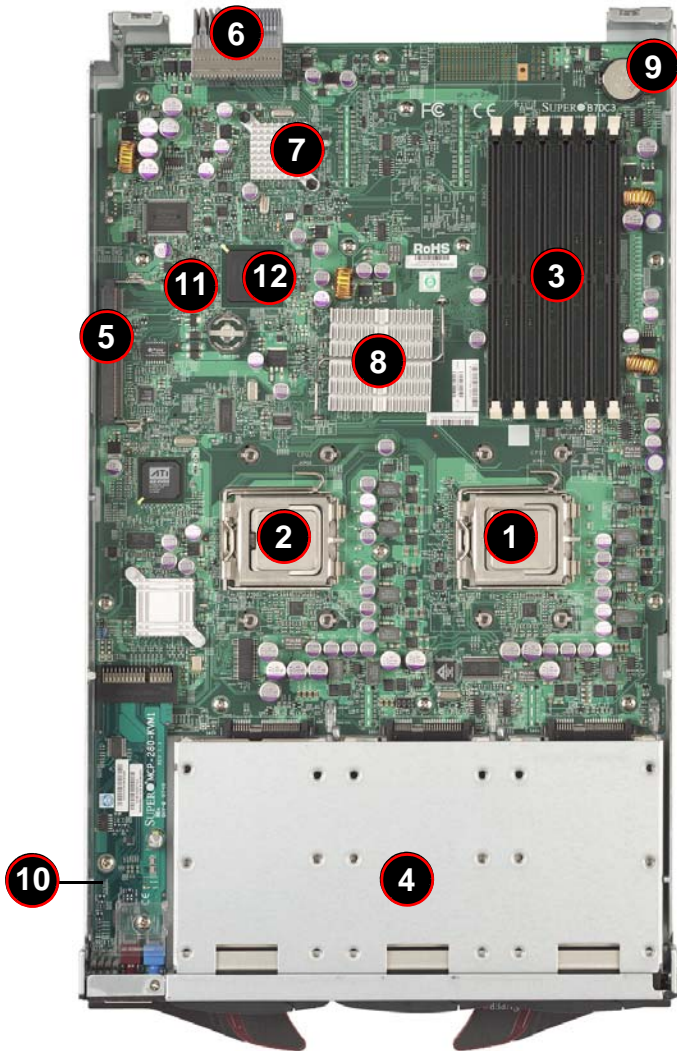
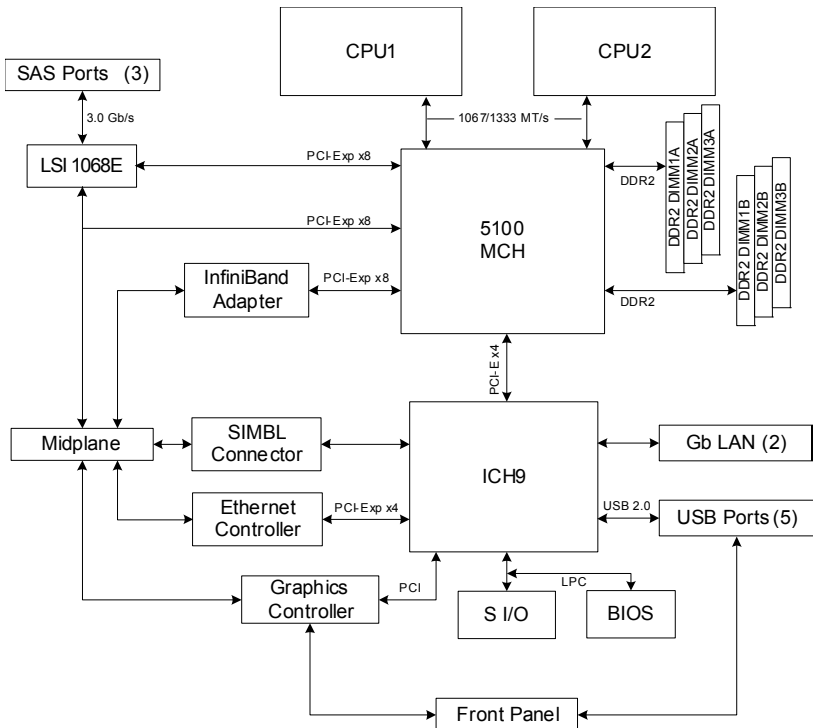

Table 4-4. B7DC3 Mainboard Layout

Item	Description
1	LGA 771 CPU1 Socket
2	LGA 771 CPU2 Socket
3	DIMM Slots (see <a href="#">Figure 3-5: "6-slot DIMM Numbering" on page 3-7</a> for details)
4	Three 2.5" SAS/SATA Hard Drive Bays
5	SIMBL Slot
6	Gbx Connectors (for power and logic to backplane)
7	Intel 82575EB (LAN Chip)
8	Intel 5100 (North Bridge chip)
9	Onboard Battery
10	KVM Module
11	BIOS Chip
12	ICH9R South Bridge Chip

Figure 4-4. Intel 5100/Intel ICH9R Chipset: Block Diagram



## Jumpers

The jumpers present on the mainboard are used by the manufacturer only; there are no jumpers used to configure the operation of the mainboard.

## CMOS Clear

JBT1 is used to clear CMOS and will also clear any passwords. JBT1 consists of two contact pads located near the BIOS chip (#10 in [Figure 4-3](#)).

### Clearing CMOS

1. First power down the blade and remove it from the enclosure.
2. Remove the blade cover to access the mainboard (see [Section : Removing/ Replacing the Blade Cover on page 3-2](#) for further details). Short the CMOS pads with a metal object such as a small screwdriver.
3. Replace the cover, install the blade back into the enclosure and power it on.

## 4-3 Blade Unit Components

Figure 4-5. Exploded View of a SBI-7425C-S3/S3E Blade Module

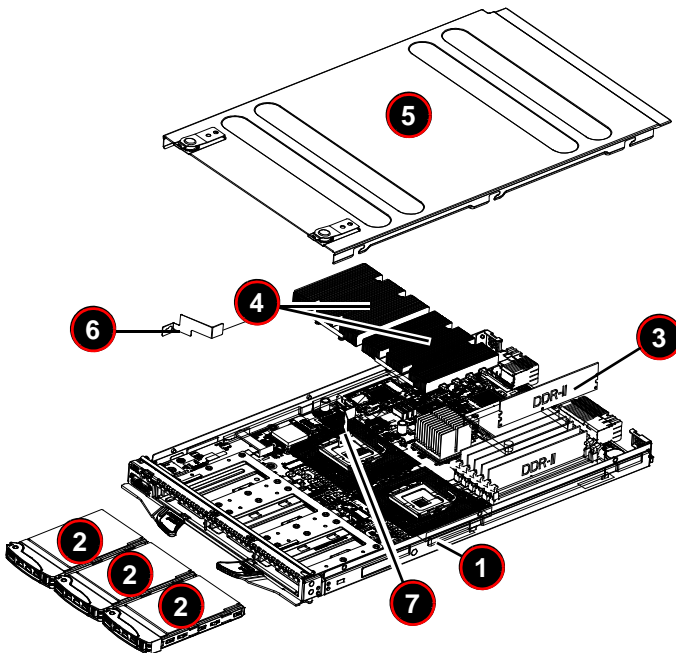

**Table 4-5. Main Components of a SBI-7425C-S3/S3E Blade Module**

Item	Description
1	Blade Unit/Module
2	2.5" Hard Drives
3	DIMMs (system memory)
4	CPU Heatsinks (2)
5	Top Cover
6	Air Shroud-L
7	Air Shroud-R

## Memory Support

The SBI-7425C-S3/S3E blade modules supports up to 24 GB of ECC Registered DDR2-667/533 SDRAM in six DIMM sockets. See [Section 3-5: Memory Installation on page 3-6](#) for further details on mainboard memory installation.

## Hard Disk Drives

The SBI-7425C-S3/S3E blade unit accommodates up to three 2.5" SATA hard disk drives, which are mounted in drive "carriers". The drives are hot-swappable and can be removed or replaced without powering down the blade unit they reside in. The three drives can be used to set up a RAID array (SATA RAID 0 or 1 only) or JBOD. These drives use a yellow color for the Blade HDD active LED. See [Chapter 5: "RAID Setup Procedure" on page 5-1](#) for further details on RAID Setup.



**WARNING:** To maintain proper airflow, both hard drive bays must have drive carriers inserted during operation whether or not a drive is installed in the carrier.

## Notes

---

---

# Chapter 5

## RAID Setup Procedure

Each SBI-7125C-S3 blade module supports up to three hard drives, which may be used to create a RAID 0, RAID 1 or Enhance RAID1 array. For RAID setup use the procedure below. This blade's BIOS has an IR mode F/W (integrated RAID mode) utility available in its setup.



**NOTE:** The software RAID mode for the B7DC3/B7DC3-IB mainboard used in the SBI-7425C-S3/S3E Blade module is the default mode.

Make sure the pins 1-2 of the jumper SWR5\_enable on the board are closed, thus enabling SR mode. Also make sure that the SR firmware is flashed.

### 5-1 RAID Configurations

With two or hard drives per blade, the following RAID configurations are supported:

- RAID 0 (Data Striping): this writes data in parallel, interleaved ("striped") sections on two hard drives. Data transfer rate is doubled over using a single disk.
- RAID1 (Data Mirroring): an identical data image from one drive is copied to another drive. The second drive must be the same size or larger than the first drive.
- Enhanced RAID 5 or RAID 10 (Data Mirroring): as RAID1 with data mirrored from one or more disks to one or more disks of a second, larger size. You can couple the disks from the source to create a virtual volume and use one or more disks of a second, larger size to provide a single larger volume (or multiple larger volumes) that serve as the mirroring drive or drives for the array.

### 5-2 Preparing for Setup

Before you begin the installation, verify the following:

1. The SBI-7425C-S3/S3E blade module has two or more hard drives installed.
2. These drives must not have an OS installed and must be non-partitioned (formatted is ok).
3. The installation procedure is done via KVM, so have a KVM cable (CBL-0218L) connected to the KVM connector on the blade module with a keyboard, mouse and monitor attached.



**NOTE:** You may also instead use IPMI or the Web-based Management utility to access the blade.

## 5-3 RAID Setup Procedure

This section provides instructions for configuring arrays and logical drives with the MegaRAID BIOS Configuration Utility.

It is recommended that you use drives with the same capacity when you create a storage configurations. If you use drives with different capacities in one array, the configuration utility limits each drive to the capacity of the smallest drive.

The number of physical drives in a specific array determines the possible RAID levels that you can implement with the array.

### Starting The MegaRAID BIOS Configuration Utility

Follow these steps to start the MegaRAID BIOS Configuration Utility:

1. During boot-up, wait for the following message to appear on the screen:

Press Ctrl-M to run LSI Software RAID Setup Utility

2. When you see this message, hold down the CTRL key while pressing the M-key.

The RAID CONFIGURATION UTILITY MANAGEMENT MENU screen appears, as shown in [Figure 5-1](#).

**Figure 5-1. RAID Configuration Utility Management Menu Screen**

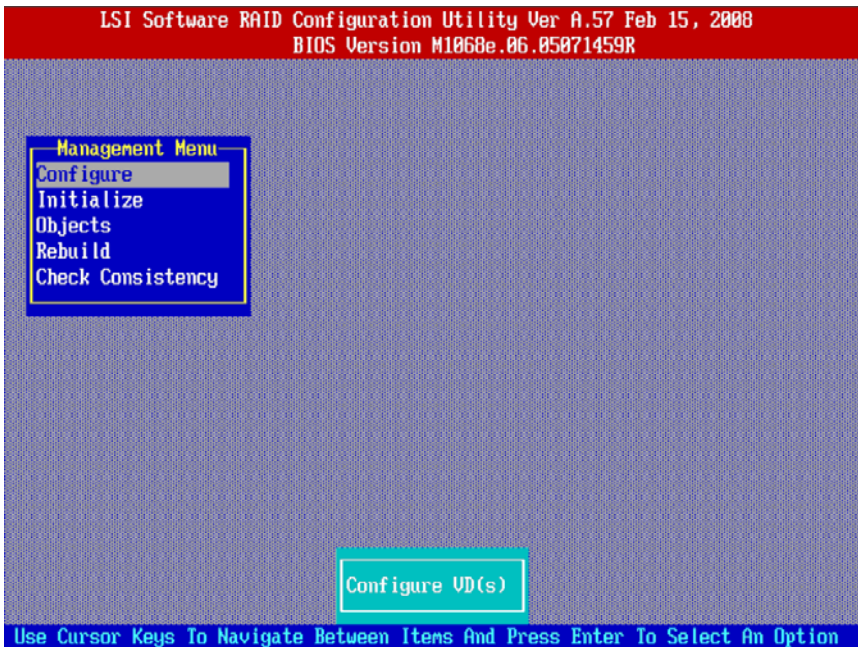

## Using Easy Configuration

When you select the **EASY CONFIGURATION** option, the configuration utility creates one or more arrays from the available physical drives and configures each array as a single virtual drive. If virtual drives have already been configured, the configuration utility does not change their configuration.

Follow the steps below to create a virtual drive using **EASY CONFIGURATION**:

1. Select **CONFIGURATION** → **EASY CONFIGURATION** from the **MANAGEMENT** menu.

A list of available (**READY**) physical drives appears.

2. Use the arrow keys to select the physical drives you want to include in the array.

- a. Press the **SPACEBAR** to add each selected physical drive to the new array.

When you select a physical drive, its status changes from **READY** to **ONLIN A[*array number*]-[*drive number*]**. For example,

`ONLIN A00-01` means array 0, disk drive 1.

- b. To create a global hotspare drive, highlight a **READY** disk drive and press **F4**. Then select **YES** from the pop-up menu.
- c. To define multiple arrays, select all the drives you want for the first array, then press **ENTER** to start selecting drives for the second array, and so on.

When you have selected drives for all desired arrays, press **F10**.

3. Press the **SPACEBAR** to select an array.

The **VIRTUAL DRIVES CONFIGURED** screen appears, as shown in [Figure 5-2](#). This screen shows the virtual drive number, RAID level, virtual drive size, number of stripes in the physical array, stripe size, and state of the virtual drive.

4. Press **F10** again.

Figure 5-2. Virtual Drives Configured Screen

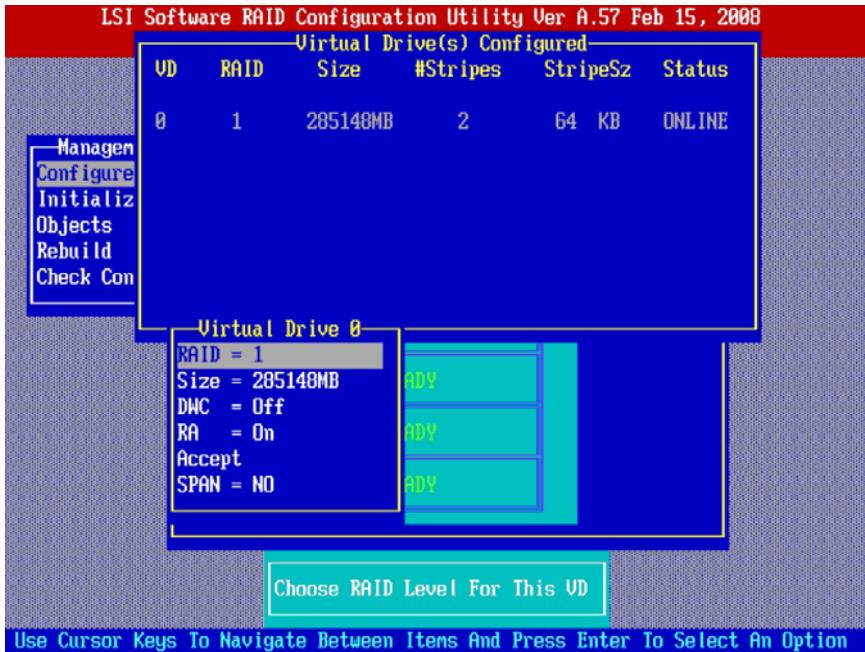

5. Highlight RAID and press ENTER.  
 The available RAID levels for the current virtual drive are displayed.
6. Select a RAID level for the virtual drive and press ENTER.
7. (Optional) Change the drive's default *Write Cache* and *Read Ahead* policies.
8. When you have finished defining the current virtual drive, select ACCEPT and press ENTER.
9. Save the configuration when prompted, and press any key to return to the MANAGEMENT menu.
13. Initialize the new virtual drive(s) (see "Initializing Virtual Drives" on page 5-6 for detailed instructions.)

### Using New Configuration and View/Add Configuration

When you select the NEW CONFIGURATION menu option, the configuration utility deletes the existing arrays and virtual drives and replaces them with the new configuration that you specify. The VIEW/ADD CONFIGURATION menu option lets you view the existing configuration or add to the existing configuration, if possible.



**WARNING:** If you want to keep the existing data on the storage configuration, use VIEW/ADD CONFIGURATION instead of NEW CONFIGURATION.

Follow these steps to configure a disk array using the NEW CONFIGURATION or VIEW/ADD CONFIGURATION option:

1. SELECT CONFIGURATION → NEW CONFIGURATION or CONFIGURATION → VIEW/ADD CONFIGURATION from the MANAGEMENT menu.

If you selected NEW CONFIGURATION, select YES to proceed and confirm that you are erasing the existing storage configuration.

The Configuration Utility displays an array selection window.



**NOTE:** The existing storage configuration will be erased only if you save the newly created configuration at the end of the process. If you do not save the new configuration, the Configuration Utility will restore the previously existing configuration.

2. Use the arrow keys to select physical drives for the new array.
3. Press the SPACEBAR to add each selected physical drive to the new array.

When you select a drive, its status changes from *READY* to *ONLIN A[array number] - [drive number]*. For example, *ONLIN A00-01* means array 0, disk drive 1.

4. To create a global hotspare drive, highlight a READY disk drive and press F4. Then select YES from the pop-up menu.

Make sure the capacity of the hotspare drive is equal to or larger than the capacity of the disks in the array and that it is the same type of drive (SAS or SATA).



**NOTE:** The hotspare drive will rebuild a failed drive even if it is SAS and the failed drive is SATA, or vice versa. Once the rebuilt is completed, however, it is recommended that you replace the new array member with a drive of the same type.

5. To define multiple arrays, select all the drives you want for the first array, then press ENTER to start selecting drives for the second array, and so on.
6. When you have selected drives for all desired arrays, press F10.
7. Press the SPACEBAR to select an array, if needed.

Press F10 to continue.

8. Highlight **RAID** and press ENTER.

A list of the available RAID levels for the current virtual drive appears.

9. Select a RAID level for the virtual drive and press ENTER.
10. (Optional) You may also set the logical drive size by highlighting SIZE and then pressing ENTER.

The minimum valid virtual drive size is 64 Mbytes. An error will appear if you try to create a virtual drive that is smaller 64 Mbytes.

By default, all the available space in the array is to the current virtual drive. For RAID 10 arrays, only one virtual can be defined for the entire array.

11. (Optional) You may change the disks's default *Write Cache* and *Read Ahead* policies.
12. When you have finished defining the current virtual drive, select **ACCEPT** and press **ENTER**.
13. Configure additional virtual drives on the same array, if desired.  
  
If you have created more than one array, configure a virtual drive on the second array.
14. Save the configuration when prompted, and press any key to return to the **MANAGEMENT** menu.
15. Initialize the new virtual drive(s). (See "[Initializing Virtual Drives](#)" on page 5-6 for detailed instructions.)

## Initializing Virtual Drives



**WARNING:** When you initialize a virtual drive all existing data on the virtual drive is erased.

This section explains the two methods of initializing a virtual drive with the MegaRAID BIOS Configuration Utility.

If the **FAST INIT** property is enabled, *fast initialization* is used. In fast initialization, the MegaRAID BIOS Configuration Utility quickly writes zeroes to the first and last 8 Mbyte regions of the new virtual drive.

If the **FAST INIT** property is *not* enabled, the MegaRAID BIOS Configuration Utility performs a *complete initialization* on the virtual drive. This may take a long time if the physical disk drives are large.

### ***First Initialization Method***

Follow these steps to initialize a virtual drive using the **INITIALIZE** menu.

1. On the **MANAGEMENT** menu, select **INITIALIZE**.
2. Use the **SPACEBAR** to highlight the virtual drive to initialize.

The virtual drive name is highlighted in yellow. To deselect it, highlight the virtual drive and press the **SPACEBAR** again.

3. Press **F10**.
4. Select **YES** at the prompt and press **ENTER** to begin the initialization.

A graph shows the progress of the initialization until it is complete.

- After the initialization is complete, press ESC to return to previous menus.

If you press ESC while initialization is in progress, the following options appear:

- Stop:** (Available only if *AutoResume* is enabled on the adapter: MANAGEMENT menu → OBJECTS → ADAPTER → AUTORESUME.) The initialization is stopped, and the Configuration Utility stores the percentage of the initialization already completed. If *AutoResume* is enabled, and if Fast Init is not enabled, the initialization resumes where it left off when you restart it, instead of starting over from zero percent.
- Continue:** The initialization continues normally.
- Abort:** The initialization is completely aborted. If you restart initialization, it begins at zero percent.

### Second Initialization Method

Follow these steps to initialize a virtual drive using the OBJECTS menu.

- From the MANAGEMENT menu, select OBJECTS → VIRTUAL DRIVE to bring up the VIRTUAL DRIVES LIST screen (Figure 5-3).

Figure 5-3. Virtual Drives List Screen

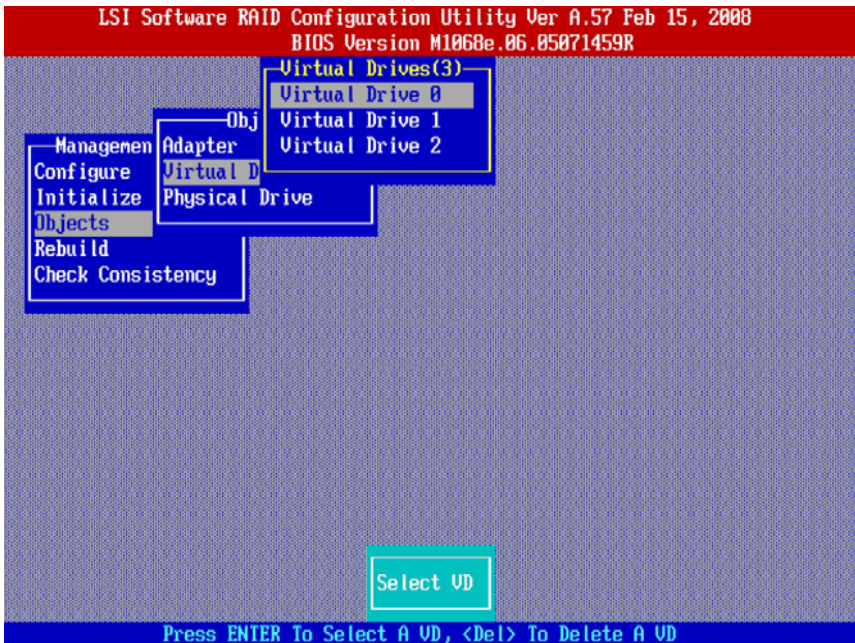

- Select a virtual drive, if there is more than one configured, and press ENTER.

3. Select INITIALIZE from the submenu and press ENTER.
4. Select YES at the prompt and press ENTER.

The Configuration Utility displays a bar graph showing the initialization progress.

5. When initialization completes, press Esc to return to the previous menu.

If you press Esc while initialization is in progress, the STOP, CONTINUE, and ABORT options are available, as explained earlier in "[First Initialization Method](#)", [step 5](#) above.

---

---

# Chapter 6

## BIOS

### 6-1 Introduction

This chapter describes the BIOS for Intel SuperBlade modules. The Intel Blade modules use a Phoenix™ ROM BIOS that is stored in a flash chip. This BIOS can be easily upgraded using a floppy disk-based program.



**NOTE:** Due to periodic changes to the BIOS, some settings may have been added or deleted and might not yet be recorded in this manual. Please refer to the <http://www.supermicro.com/products/SuperBlade/module/> web site for further details on BIOS setup and the BIOS menus for your SuperBlade blade module.

#### System BIOS

BIOS stands for Basic Input Output System. The Phoenix BIOS flash chip stores the system parameters, types of disk drives, video displays, etc. in the CMOS. The CMOS memory requires very little electrical power. When the blade unit is turned off, a backup battery provides power to the BIOS flash chip, enabling it to retain system parameters. Each time the blade is powered on it is configured with the values stored in the BIOS ROM by the system BIOS, which gains control at boot up.

#### How To Change the Configuration Data

The CMOS information that determines the system parameters may be changed by entering the BIOS Setup utility. This Setup utility can be accessed by pressing the <DELETE> key at the appropriate time during system boot. (See "Starting the Setup Utility" below.)

#### Starting the Setup Utility

Normally, the only visible POST (Power-On Self-Test) routine is the memory test. As the memory is being tested, press the <DELETE> key to enter the main menu of the BIOS Setup utility. From the main menu, you can access the other setup screens, such as the Security and Power menus.



**WARNING:** To prevent possible boot failure, do not shut down or reset the system while updating the BIOS.

## 6-2 BIOS Updates

It may be necessary to update the BIOS used in the blade modules on occasion. However, it is recommended that you not update BIOS if you are not experiencing problems with a blade module.

Updated BIOS files are located on our web site([www.supermicro.com/products/superblade/](http://www.supermicro.com/products/superblade/)). Please check the current BIOS revision and make sure it is newer than your current BIOS before downloading.

There are several methods you may use to upgrade (flash) your BIOS. After downloading the appropriate BIOS file (in a zip file format), follow one of the methods described below to flash the new BIOS.

### Flashing BIOS

Use the procedures below to “Flash” your BIOS with a new update using the KVM dongle, USB ports on the CMM module or by use of a Floppy disk.

#### ***Flashing a BIOS using the KVM Dongle:***

For this method, you must use a KVM “dongle” cable (CBL-0218L, included with the system).

1. Copy the contents of the zip file to a bootable USB pen drive.
2. Connect the KVM dongle (CBL-0218L) to the KVM connector at the front of the blade you will be flashing the BIOS to.
3. Connect your bootable USB pen drive to one of the two USB slots on the KVM dongle.
4. Boot to the USB pen drive and go to the directory where you saved the contents of the zip file.
5. Type **flash filename.rom** (replace *filename.rom* by the actual ROM file name).

#### ***Flashing a BIOS using the USB Ports on the CMM:***

1. Copy the contents of the zip file to a bootable USB pen drive.
2. Connect your bootable USB pen drive to one of the two USB slots on the CMM (located on the back side of the enclosure).
3. Boot to the USB pen drive and go to the directory where you saved the contents of the zip file.
4. Type **flash filename.rom** (replace *filename.rom* by the actual ROM file name).

#### ***Flashing a BIOS using a Floppy Image File***

This method must be performed remotely.

1. Copy the image file from the zip file to your desktop.
2. Use the web browser or IPMIView to access your CMM remotely using its IP Address.

3. Go to the VIRTUAL MEDIA menu and select FLOPPY IMAGE UPLOAD.
4. BROWSE or OPEN to locate the \*.img file on your desktop and select it.
5. Press the UPLOAD button and wait a few seconds for the image to upload to the CMM.
6. Once the upload finishes, turn on the blade module and press <DEL> to enter the BIOS setup utility.
7. In the BOOT MENU, bring **USB LS120: PEPPCMM VIRTUAL DISC 1** to the top of the boot priority list.
8. Exit while saving the changes. The blade module will boot to the virtual media (floppy image) **A:\>**.
9. Type **flash filename.rom**.



**NOTE:** Replace *filename.rom* by the actual ROM file name (such as **B7DBE142.rom** for example) in the command.

## 6-3 Running Setup



**NOTE:** Default settings are in **bold** text unless otherwise noted.

The BIOS setup options described in this section are selected by choosing the appropriate text from the MAIN BIOS SETUP screen. All displayed text is described in this section, although the screen display is often all you need to understand how to set the options.

When you first power on the computer, the BIOS is immediately activated.

While the BIOS is in control, the Setup program can be activated in one of two ways:

1. By pressing <DELETE> immediately after turning the system on, or
2. When the message **Press the <Delete> key to enter Setup** appears briefly at the bottom of the screen during the POST, press the <DELETE> key to activate the main SETUP menu:

## 6-4 Main BIOS Setup

Figure 6-1. Main BIOS Setup Menu

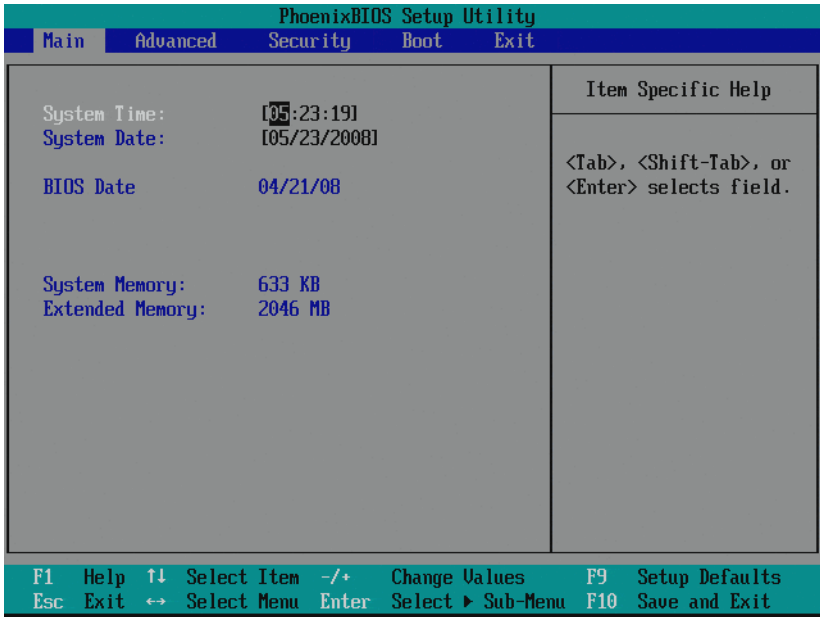

Menu options found in the MAIN BIOS SETUP menu (Figure 6-1) are shown in Table 6-1.

Table 6-1. Main BIOS Setup Menu Options

Menu Option	Description
System Time	To set the system date and time, key in the correct information in the appropriate fields. Then press the <ENTER> key to save the data.
System Date	Using the arrow keys, highlight the month, day and year fields, and enter the correct data for the system date. Press the <ENTER> key to save the data.
BIOS Date	The BIOS Date field displays the date when this version of the BIOS was built.
System Memory	This BIOS entry displays the installed system memory for the Blade server.
Extended Memory	This BIOS entry displays the extended memory for the Blade server.

## 6-5 Advanced Setup

Figure 6-2. Advanced Setup Menu

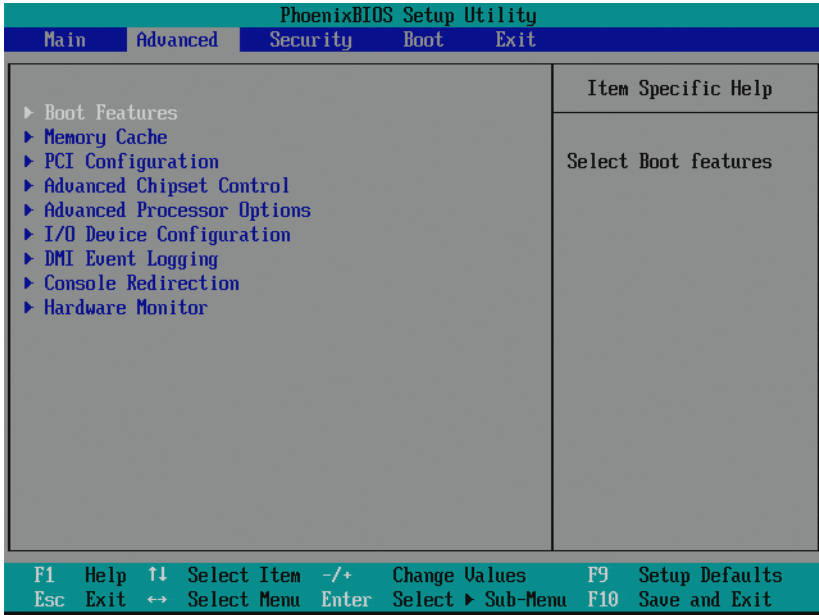

Choose **Advanced** from the BIOS Setup Utility main menu with the arrow keys to bring up the ADVANCED menu (Figure 6-2).

The items with a triangle beside them have sub menus that can be accessed by highlighting the item and pressing <ENTER>. Options for PIR settings are displayed by highlighting the setting option using the arrow keys and pressing <ENTER>.

Table 6-2 contains a list of all menu options found in the ADVANCED SETUP menu.

Table 6-2. Advanced Setup Menu Options

Submenu	Description
▶ Boot Features	Access this submenu to make changes to boot features. See Table 6-3 for a list of menu options in this submenu.
▶ Memory Cache	Access this submenu to make changes to settings for the memory cache. See Table 6-4 for a list of menu options in this submenu.
▶ PCI Configuration	Access this submenu to make changes to settings for PCI devices. See Table 6-5 for a list of menu options in this submenu.

Table 6-2. Advanced Setup Menu Options (Continued)

Submenu	Description
▶Advanced Chipset Control	Access this submenu to make changes to advanced chipset settings. See <a href="#">Table 6-6</a> for a list of menu options in this submenu. <b>WARNING:</b> Use caution when changing the Advanced settings. Incorrect values entered may cause a system malfunction. Also, a very high DRAM frequency or incorrect DRAM timing may cause system instability. When this occurs, revert to the default settings.
▶Advanced Processor Options	Access this submenu to make changes to advanced processor option settings. See <a href="#">Table 6-7</a> for a list of menu options in this submenu.
▶I/O Device Configuration	Access this submenu to make changes to I/O device configuration settings. See <a href="#">Table 6-8</a> for a list of menu options in this submenu.
▶DMI Event Logging	Access this submenu to make changes to DMI event logging settings. See <a href="#">Table 6-9</a> for a list of menu options in this submenu.
▶Console Redirection	Access this submenu to make changes to console redirection settings. See <a href="#">Table 6-10</a> for a list of menu options in this submenu.
▶Hardware Monitor	Access this submenu to make changes to the hardware monitor settings. See <a href="#">Table 6-11</a> for a list of menu options in this submenu.
▶IPMI	Access this submenu to make changes to the IPMI settings. See <a href="#">Table 6-12</a> for a list of menu options in this submenu. <b>NOTE:</b> The option is available only when an IPMI card is installed in the system.

## Boot Features Submenu

Figure 7. Boot Features Submenu

PhoenixBIOS Setup Utility		
Advanced		
Boot Features		Item Specific Help
QuickBoot Mode:	[Enabled]	Allows the system to skip certain tests while booting. This will decrease the time needed to boot the system.
QuietBoot Mode:	[Enabled]	
POST Errors:	[Enabled]	
ACPI Mode:	[Yes]	
Power Button Behavior	[4-sec Override]	
Power Loss Control	[Stay Off]	
Summary screen:	[Enabled]	
F1 Help ↑↓ Select Item -/+ Change Values F9 Setup Defaults Esc Exit ↔ Select Menu Enter Select ▶ Sub-Menu F10 Save and Exit		

Selecting **Boot Features** in the **ADVANCED** menu brings up the **BOOT FEATURES** submenu (Table 7). The menu options found in this submenu are shown in Table 6-3.

Table 6-3. Boot Features Submenu Menu Options

Menu Option	Description
Quick Boot Mode	If enabled, this feature will speed up the POST (Power-On Self-Test) routine by skipping certain tests after the computer is turned on. The settings are <b>Enabled</b> and <b>DISABLED</b> . If <b>DISABLED</b> , the POST routine will run at normal speed.
Quiet Boot Mode	This setting allows you to <b>Enable</b> or <b>Disable</b> the diagnostic screen during boot-up.
POST Errors	Enabling this setting pauses and displays the Setup entry or resume boot prompt if an error occurs on boot. If disabled, the system will always attempt to boot. The settings are <b>Enabled</b> and <b>DISABLED</b> .
ACPI Mode	Use this setting to determine if you want to employ ACPI (Advanced Configuration and Power Interface) power management on your system. The options are <b>Yes</b> and <b>No</b> .

**Table 6-3. Boot Features Submenu Menu Options (Continued)**

Menu Option	Description
Power Button Behavior	If set to Instant-Off, the system will power off immediately as soon as the user hits the power button. If set to 4-sec. override, the system will power off when the user presses the power button for 4 seconds or longer. The options are INSTANT-OFF and <b>4-sec override</b> .
Power Loss Control	This setting allows you to choose how the system will react when power returns after an unexpected loss of power. The options are <b>Stay Off</b> , POWER ON and LAST STATE.
Summary Screen	This setting allows you to <b>Enable</b> or disable the summary screen, which displays the system configuration during bootup.

### Memory Cache Submenu

Selecting **Memory Cache** in the ADVANCED menu brings up the MEMORY CACHE submenu (Table 6-1). The menu options found in this submenu are shown in Table 6-4.

**Figure 6-1. Memory Cache Submenu**

PhoenixBIOS Setup Utility	
Advanced	
Memory Cache	Item Specific Help
Cache System BIOS area: [Write Protect]	Controls caching of system BIOS area.
Cache Video BIOS area [Write Protect]	
Cache Base 0-512k: [Write Back]	
Cache Base 512k-640k: [Write Back]	
Cache Extended Memory Area: [Write Back]	
Discrete MTRR Allocation [Disabled]	
F1 Help ↑↓ Select Item -/+ Change Values F9 Setup Defaults	
Esc Exit ↔ Select Menu Enter Select ▶ Sub-Menu F10 Save and Exit	

Table 6-4. Memory Cache Submenu Menu Options

Menu Option	Description
Cache System BIOS Area	<p>This setting allows you to designate a reserve area in the system memory to be used as a system BIOS buffer into which the BIOS will write (cache) its data.</p> <p>Select <b>Write Protect</b> to enable this function, and this area will be reserved for BIOS ROM access only.</p> <p>Select <b>UNCACHED</b> to disable this function and make this area available for other devices.</p>
Cache Video BIOS Area	<p>This setting allows you to designate a reserve area in the system memory to be used as a Video BIOS buffer into which the BIOS will write (cache) its data.</p> <p>Select <b>Write Protect</b> to enable the function and this area will be reserved for Video BIOS ROM access only.</p> <p>Select <b>UNCACHED</b> to disable this function and make this area available for other devices.</p>
Cache Base 0-512k	<p>If enabled, this feature will allow the data stored in the base memory area (block 0-512k) to be cached (written) into a buffer, a storage area in the static DROM (SDROM) or to be written into the L1/L2/L3 cache in the CPU to speed up CPU operations.</p> <p>Select <b>UNCACHED</b> to disable this function.</p> <p>Select <b>WRITE THROUGH</b> to allow data to be cached into the buffer and written into the system memory at the same time.</p> <p>Select <b>WRITE PROTECT</b> to prevent data from being written into the base memory area of Block 0-512k.</p> <p>Select <b>Write Back</b> to allow the CPU to write data back directly from the buffer without writing data to the system memory for faster CPU operation.</p>
Cache Base 512k-640k	<p>If enabled, this feature will allow the data stored in memory area 512k-640k to be cached (written) into a buffer, a storage area in the static DROM (SDROM) or written into the L1/L2/L3 cache in the CPU to speed up CPU operations.</p> <p>Select <b>UNCACHED</b> to disable this function.</p> <p>Select <b>WRITE THROUGH</b> to allow data to be cached into the buffer and written into the system memory at the same time.</p> <p>Select <b>WRITE PROTECT</b> to prevent data from being written into the base memory area of Block 0-512k.</p> <p>Select <b>Write Back</b> to allow the CPU to write data back directly from the buffer without writing data to the system memory for faster CPU operation.</p>
Cache Extended Memory Area	<p>If enabled, this feature will allow the data stored in the extended memory area to be cached (written) into a buffer, a storage area in the static DROM (SDROM) or written into the L1/L2/L3 cache inside the CPU to speed up CPU operations.</p> <p>Select <b>UNCACHED</b> to disable this function.</p> <p>Select <b>WRITE THROUGH</b> to allow data to be cached into the buffer and written into the system memory at the same time.</p> <p>Select <b>WRITE PROTECT</b> to prevent data from being written into the base memory area of Block 0-512k.</p> <p>Select <b>Write Back</b> to allow CPU to write data back directly from the buffer without writing data to the system memory for faster CPU operation.</p>
Discrete MTRR Allocation	<p>If enabled, MTRRs (Memory Type Range Registers) are configured as distinct, separate units and cannot be overlapped. If enabled, the user can achieve better graphic effects when using a Linux graphic driver that requires the write-combining configuration with 4GB or more memory. The options are <b>ENABLED</b> and <b>Disabled</b>.</p>

## PCI Configuration Submenu

Figure 6-2. PCI Configuration Submenu

PhoenixBIOS Setup Utility	
Advanced	
PCI Configuration	Item Specific Help
Onboard G-LAN1 OPROM Configure: [Enabled]	Configure the capability to boot from LAN. (PXE feature)
Onboard G-LAN2 OPROM Configure: [Enabled]	
Reset Configuration Data: [No]	
Large Disk Access Mode: [DOS]	
F1 Help ↑↓ Select Item -/+ Change Values F9 Setup Defaults Esc Exit ↔ Select Menu Enter Select ► Sub-Menu F10 Save and Exit	

Selecting **PCI Configuration** in the **ADVANCED** menu brings up the **PCI CONFIGURATION** submenu (Table 6-2). The menu options found in this submenu are shown in Table 6-5.

Table 6-5. PCI Configuration Submenu Menu Options

Menu Option	Description
Onboard GLAN1 (Gigabit- LAN) OPROM Configure	Enabling this option provides the capability to boot from the GLAN1 Ethernet port. The options are <b>Enabled</b> and <b>DISABLED</b> .
Onboard GLAN2 (Gigabit- LAN) OPROM Configure	Enabling this option provides the capability to boot from the GLAN2 Ethernet port. The options are <b>Enabled</b> and <b>DISABLED</b> .
Reset Configuration Data	If set to Yes, this setting clears the Extended System Configuration Data (ESCD) area. The options are <b>Yes</b> and <b>No</b> .
Large Disk Access Mode	If installing new software, and the drive fails, change this selection and try again. Different operating systems require different representations of drive geometries. Default is <b>DOS</b> . Select <b>OTHER</b> for UNIX, Novell Netware or other operating systems.

## Advanced Chipset Control Submenu

Figure 6-3. Advanced Chipset Control Submenu

PhoenixBIOS Setup Utility	
Advanced	
Advanced Chipset Control	Item Specific Help
Clock Spectrum Feature:	[Disabled]
Crystal Beach Configure Enable	[Enabled]
SERR signal condition	[Single bit]
4GB PCI Hole Granularity	[256 MB]
Channel 0 Rank Sparing	[Disabled]
Channel 1 Rank Sparing	[Disabled]
Enhanced x8 Detection	[Enabled]
Demand Scrub	[Enabled]
Patrol Scrub	[Enabled]
Enable Multimedia Timer	[No]
USB Host Controller	[Enabled]
Legacy USB Support:	[Enabled]
F1 Help ↑↓ Select Item -/+ Change Values F9 Setup Defaults Esc Exit ↔ Select Menu Enter Select ▶ Sub-Menu F10 Save and Exit	

Selecting **Advanced Chipset Control** in the **ADVANCED** menu brings up the **ADVANCED CHIPSET CONTROL** submenu (Table 6-3). The menu options found in this submenu are shown in Table 6-6.

Table 6-6. Advanced Chipset Control Submenu Menu Options

Menu Option	Description
Clock Spectrum Feature	Enable this feature to limit peak EMI emission. Default is <b>Disabled</b> .
Crystal Beach Configure Enabled	Enabling this creates memory-mapped accesses to the Crystal Beach configuration space located in Device 8, Fn 0 and Fn 1. The options are <b>Enabled</b> and <b>DISABLED</b> .
SERR Signal Condition	This setting specifies the ECC Error conditions that an SERR# is to be asserted. The options are None, <b>Single Bit</b> , MULTIPLE BIT and BOTH.
4GB PCI Hole Granularity	This feature allows you to select the granularity of PCI hole for PCI slots. If MTRRs are not enough, this option may be used to reduce MTRR occupation. The options are <b>256 MB</b> , 512 MB, 1GB and 2GB.
Channel 0 Rank Sparing	Enables 0 Channel rank sparing feature. Default is <b>Disabled</b> .

**Table 6-6. Advanced Chipset Control Submenu Menu Options (Continued)**

Menu Option	Description
Channel 1 Rank Sparing	Enables 1 Channel rank sparing feature. Default is <b>Disabled</b> .
Enhanced x8 Detection	Enables enhanced x8 DRAM UC Error detection. Default is <b>Enabled</b> .
Demand Scrub	Enables Demand Scrub when selected. Default is <b>Enabled</b> .
Petrol Scrub	Enables Patrol Scrub when selected. Default is <b>Enabled</b> .
Enabling Multi-Media Timer	Select Yes to activate a set of timers that are alternative to the traditional 8254 timers for the OS use. The options are <b>Yes</b> and <b>No</b> .
USB Host Controller	Select Enabled to enable USB Host Controller 1. The options are <b>Enabled</b> and <b>DISABLED</b> .
Legacy USB Support	This setting allows you to enable support for Legacy USB devices. The options are <b>Enabled</b> and <b>DISABLED</b> .

## Advanced Processor Options Submenu

**Figure 6-4. Advanced Processor Options Submenu**

PhoenixBIOS Setup Utility		
Advanced		
Advanced Processor Options		Item Specific Help
CPU Speed	2.50 GHz	Select frequency ratio for the Processor
Frequency Ratio	[Default]	
Core Multi-Processing:	[Enabled]	"default" means no change to boot ratio.
Machine Checking	[Enabled]	
C1 Enhanced Mode	[Disabled]	
Execute Disable Bit	[Enabled]	
Adjacent Cache Line Prefetch	[Disabled]	
Hardware Prefetcher	[Enabled]	
Intel(R) Virtualization Technology	[Disabled]	
Intel EIST support:	[Disabled]	
▶ CPU Cache Control		

F1	Help	↑↓	Select Item	-/+	Change Values	F9	Setup Defaults
Esc	Exit	↔	Select Menu	Enter	Select ▶ Sub-Menu	F10	Save and Exit

Selecting **Advanced Processor Options** in the ADVANCED menu brings up the ADVANCED PROCESSOR OPTIONS submenu (Table 6-4). The menu options found in this submenu are shown in Table 6-7.

**Table 6-7. Advanced Processor Options Submenu Menu Options**

Menu Option	Description
CPU Speed	This is a display that indicates the speed of the installed processor.
Frequency Ratio	Selects the internal frequency multiplier of the CPU(s). Options are <b>Default</b> , x6 and x7.
Core Multi-Processing (Available when supported by the CPU)	Determines whether the 2nd CPU core is enabled. The options are <b>Enabled</b> and <b>DISABLED</b> .
Machine Checking	Enables machine checking when selected. Default is <b>Enabled</b> .
C1 Enhanced Mode (Available when supported by the CPU)	Set to <b>ENABLED</b> to enable Enhanced Halt State to lower the CPU voltage/ frequency to prevent overheating. The options are <b>ENABLED</b> and <b>Disabled</b> . Refer to the <a href="#">Intel web site</a> for detailed information.
Execute Disable Bit	Set to <b>Enable</b> to allow the processor to classify areas in memory where an application code can execute and where it cannot, and thus preventing a worm or a virus from inserting and creating a flood of codes to overwhelm the processor or damage the system during an attack. <b>Note:</b> this feature is available when your OS and your CPU support the Execute Disable Bit function. For more information, please refer to the <a href="#">Intel</a> and <a href="#">Microsoft</a> web sites.
Adjacent Cache Line Prefetch	Enables Adjacent Cache Line Prefetch when selected. Default is <b>Disabled</b> .
Hardware Prefetch	Enables Hardware Prefetch when selected. Default is <b>Enabled</b> .
Intel (R) Virtualization Technology	Select <b>Enabled</b> to use the feature of Virtualization Technology to allow one platform to run multiple operating systems and applications in independent partitions, creating multiple "virtual" systems in one physical computer. The options are <b>ENABLED</b> and <b>Disabled</b> . <b>NOTE:</b> If there is any change to this setting, you will need to power off and restart the system for the change to take effect. Please refer to Intel's website for detailed information.
Intel EIST Support	Select <b>Enabled</b> to use the Enhanced Intel SpeedStep Technology and allows the system to automatically adjust processor voltage and core frequency in an effort to reduce power consumption and heat dissipation. The options are <b>ENABLED</b> and <b>Disabled</b> . (Native mode support only.)
▶ CPU Cache Control	
DCU Prefetcher	Enables the DCU Prefetcher when selected. Default is <b>Disabled</b> .
IP Prefetcher	Enables the IP Prefetcher when selected. Default is <b>Enabled</b> .
Direct Cache Access	Enables Direct Cache Access when selected. Default is <b>Disabled</b> .

## I/O Device Configuration Submenu

Figure 6-5. I/O Device Configuration Submenu

PhoenixBIOS Setup Utility	
Advanced	
I/O Device Configuration	Item Specific Help
Serial port A: [Enabled] Base I/O address: [3F8] Interrupt: [IRQ 4] Serial port B: [Enabled] Mode: [Normal] Base I/O address: [2F8] Interrupt: [IRQ 3]	Configure serial port A using options:  [Disabled] No configuration  [Enabled] User configuration  [Auto] BIOS or OS chooses configuration  (OS Controlled) Displayed when controlled by OS
F1 Help ↑↓ Select Item -/+ Change Values	F9 Setup Defaults
Esc Exit ↔ Select Menu Enter Select ▶ Sub-Menu	F10 Save and Exit

Selecting **I/O Device Configuration** in the **ADVANCED** menu brings up the **I/O DEVICE CONFIGURATION** submenu (Table 6-5). The menu options found in this submenu are shown in Table 6-8.

Table 6-8. I/O Device Configuration Submenu Menu Options

Menu Option	Description
▶Serial Port A	This setting allows you to assign control of serial port A. The options are <b>Enabled</b> (user defined), <b>DISABLED</b> , and <b>AUTO</b> (BIOS or OS controlled).
Base I/O Address	This setting allows you to select the base I/O address for serial port A. The options are <b>3F8</b> , <b>2F8</b> , <b>3E8</b> , and <b>2E8</b> .
Interrupt	This setting allows you to select the <b>IRQ</b> (interrupt request) for serial port A. The options are <b>IRQ3</b> and <b>IRQ4</b> .
▶Serial Port B	This setting allows you to assign control of serial port B. The options are <b>Enabled</b> (user defined), <b>DISABLED</b> , <b>AUTO</b> (BIOS controlled) and <b>OS CONTROLLED</b> .
Mode	This setting allows you to set the type of device that will be connected to serial port B. The options are <b>Normal</b> and <b>IR</b> (for an infrared device).

Table 6-8. I/O Device Configuration Submenu Menu Options (Continued)

Menu Option	Description
Base I/O Address	This setting allows you to select the base I/O address for serial port B. The options are 3F8, 2F8, 3E8 and 2E8.
Interrupt	This setting allows you to select the IRQ (interrupt request) for serial port B. The options are IRQ3 and IRQ4.

## DMI Event Logging Submenu

Figure 6-6. DMI Event Logging Submenu

PhoenixBIOS Setup Utility			
Advanced			
DMI Event Logging		Item Specific Help	
Event log validity	Valid	View the contents of the DMI event log.	
Event log capacity	Space Available		
View DMI event log	[Enter]		
Event Logging	[Enabled]		
ECC Event Logging	[Enabled]		
Mark DMI events as read	[Enter]		
Clear all DMI event logs	[No]		
F1 Help ↑↓	Select Item -/+	Change Values	F9 Setup Defaults
Esc Exit ↔	Select Menu Enter	Select ▶ Sub-Menu	F10 Save and Exit

Selecting **DMI Event Logging** in the **ADVANCED** menu brings up the **DMI EVENT LOGGING** submenu (Table 6-6). The menu options found in this submenu are shown in Table 6-9.

Table 6-9. DMI Event Logging Submenu Menu Options

Menu Option	Description
Event Log Validity	This is a display to inform you of the event log validity. It is not a setting.
Event Log Capacity	This is a display to inform you of the event log capacity. It is not a setting.
View DMI Event Log	Highlight this item and press <ENTER> to view the contents of the event log.
Event Logging	This setting allows you to <b>Enable</b> or Disable event logging.

**Table 6-9. DMI Event Logging Submenu Menu Options (Continued)**

Menu Option	Description
ECC Event Logging	This setting allows you to <b>Enable</b> or Disable ECC event logging.
Mark DMI Events as Read	Highlight this item and press <ENTER> to mark the DMI events as read.
Clear All DMI Event Logs	Select Yes and press <ENTER> to clear all DMI event logs. The options are Yes and <b>No</b> .

## Console Redirection Submenu

**Figure 6-7. Console Redirection Submenu**

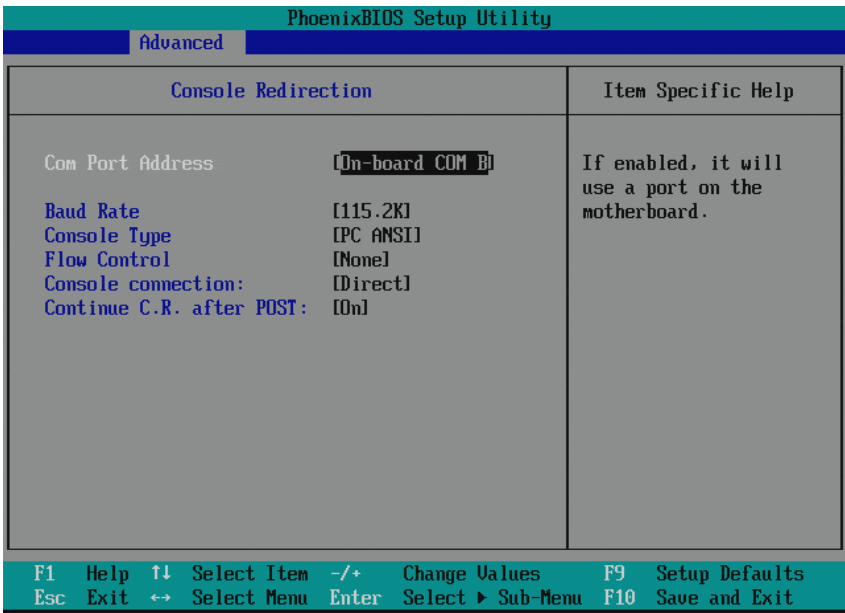

Selecting **Console Redirection** in the **ADVANCED** menu brings up the **CONSOLE REDIRECTION** submenu (Table 6-7). The menu options found in this submenu are shown in Table 6-10.

Table 6-10. Console Redirection Submenu Menu Options

Menu Option	Description
COM Port Address	This item allows you to specify to redirect the console to Onboard COM A or Onboard COM B. This setting can also be <b>Disabled</b> .
BAUD Rate	This item allows you to select the BAUD rate for console redirection. The options are 300, 1200, 2400, 9600, <b>19.2K</b> , 38.4K, 57.6K, and 115.2K.
Console Type	This item allows you to choose from the available options to select the console type for console redirection. The options are VT100, VT100 (8bit), PC-ANSI (7bit), <b>PC ANSI</b> , VT100+, and VT-UTF8.
Flow Control	This item allows you to choose from the available options to select the flow control for console redirection. The options are: None, XON/XOFF, and <b>CTS/RTS</b> .
Console Connection	This item allows you to choose select the console connection: either <b>Direct</b> or Via Modem.
Continue CR after POST	Choose whether to continue with console redirection after the POST routine. The options are On and <b>Off</b> .

## Hardware Monitor Submenu

Figure 6-8. Hardware Monitor Submenu

PhoenixBIOS Setup Utility	
Advanced	
Hardware Monitor	Item Specific Help
CPU1 Temperature: 30 °C CPU2 Temperature: 29 °C System Temperature: 30 °C  VcoreA: 1.148 V VcoreB: 1.142 V 1.8V: 1.824 V P1V5: 1.424 V +3.3V: 3.232 V +12V: 11.904 V 5Vsb: 4.920 V 5VDD: 4.920 V P_UTI: 1.074 V Vbat: 3.216 V	All items on this menu cannot be modified in user mode. If any items require changes, please consult your system Supervisor.
F1 Help ↑↓ Select Item -/+ Change Values F9 Setup Defaults Esc Exit ↔ Select Menu Enter Select ► Sub-Menu F10 Save and Exit	

Selecting **Hardware Monitor** in the **ADVANCED** menu brings up the **HARDWARE MONITOR** submenu (Table 6-8). The menu options found in this submenu are shown in Table 6-11.

**Table 6-11. Hardware Monitor Submenu Menu Options**

Menu Option	Description
CPU Temperature Threshold	<p>This option allows the user to set a CPU temperature threshold that will activate the alarm system when the CPU temperature reaches this pre-set temperature threshold. The hardcode default setting is <b>80°C</b>.</p> <p>The default setting for the Intel 5100 Series CPU is <b>75°C</b> and for the 5000 Series CPU is <b>80°C</b>.</p>
▶ Temperature Monitoring (Available if supported by the CPU)	<p>This function monitors the following PECEI (Platform Environment Control Interface) items.</p>
CPU1 Temperature	<p>This setting monitors CPU1 temperature.</p>
CPU2 Temperature	<p>This setting monitors CPU2 temperature.</p>
System Temperature	<p>This setting monitors the System temperature.</p>
Voltage Monitoring	<p>The following voltages are displayed:</p> <ul style="list-style-type: none"> <li>• VcoreA</li> <li>• VcoreB</li> <li>• +1.8V</li> <li>• P1V5</li> <li>• +3.3V</li> <li>• +12V</li> <li>• 5Vsb</li> <li>• 5VDD</li> <li>• P_VTT</li> <li>• Vbat</li> </ul> <p><b>NOTE:</b> In the Windows OS environment, the Supero Doctor III settings take precedence over the BIOS settings. When first installed, Supero Doctor III adopts the temperature threshold settings previously set in the BIOS. Any subsequent changes to these thresholds must be made within Supero Doctor, since the SD III settings override the BIOS settings. For the Windows OS to adopt the BIOS temperature threshold settings, please change the SDIII settings to be the same as those set in the BIOS.</p>

## IPMI Submenu

Selecting **IPMI** in the **ADVANCED** menu brings up the IPMI submenu. The menu options found in this submenu are shown in [Table 6-12](#).



**NOTE:** This option is only available when an IPMI card is installed in the system. If no card is installed, then this option is not shown in the BIOS setup.

**Table 6-12. IPMI Submenu Menu Options**

Menu Option	Description
0IP0M0000I Specification Version	This item displays the current IPMI Version.
Firmware Version	This item displays the current Firmware Version.
System Event Logging	Select <b>Enabled</b> to enable IPMI Event Logging. When this function is set to Disabled, the system will continue to log events received via system interface. The options are <b>Enabled</b> and <b>DISABLED</b> .
Clear System Event Logging	Enabling this function to force the BIOS to clear the system event logs during the next cold boot. The options are <b>ENABLED</b> and <b>Disabled</b> .
Existing Event Log Number	This item displays the number of the existing event log.
►Event Log Control	Use this setting to configure event log controls.
System Firmware Progress	This function enables you to log POST progress. The options are <b>ENABLED</b> and <b>Disabled</b> .
BIOS POST Errors	This function enables you to log POST errors. The options are <b>ENABLED</b> and <b>Disabled</b> .
BIOS POST Watch Dog	Set to Enabled to enable POST Watch Dog. The options are <b>ENABLED</b> and <b>Disabled</b> .
►OS Boot Watch Dog	Set to Enabled to enable OS Boot Watch Dog. The options are <b>ENABLED</b> and <b>Disabled</b> .
Timer for Loading OS (Minutes)	This feature allows the user to set the time value (in minutes) for the previous item: OS Boot Watch Dog by keying-in a desired number in the blank. The default setting is 10 (minutes.) <b>NOTE:</b> Please ignore this option when OS Boot Watch Dog is set to <b>DISABLED</b> .
Time Out Option	This feature allows the user to determine what action to take in an event of a system boot failure. The options are <b>No Action</b> , <b>RESET</b> , <b>POWER OFF</b> and <b>POWER CYCLES</b> .
►System Event Log/ System Event Log (List Mode)	These options display the System Event (SEL) Log and System Event (SEL) Log in List Mode. Items include: SEL (System Event Log) Entry Number, SEL Record ID, SEL Record Type, Time Stamp, Generator ID, SEL Message Revision, Sensor Type, Sensor Number, SEL Event Type, Event Description and SEL Event Data.
►Realtime Sensor Data	This feature display information from motherboard sensors, such as temperatures, fan speeds and voltages of various components.

## 6-6 Security

Figure 6-9. Security Menu

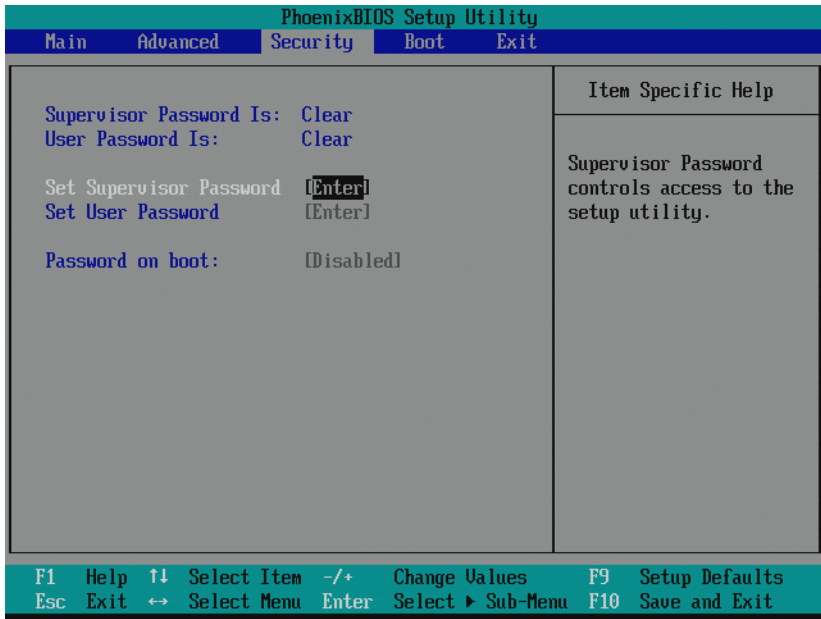

Choose **Security** from the Phoenix BIOS Setup Utility main menu with the arrow keys to bring up the SECURITY menu (Figure 6-9). Security setting options are displayed by highlighting the setting using the arrow keys and pressing <ENTER>.

All Security BIOS settings are described in Table 6-13 below.

Table 6-13. Security Menu Options

Menu Option	Description
Supervisor Password Is:	This displays whether a supervisor password has been entered for the system. CLEAR means such a password has not been used and SET means a supervisor password has been entered for the system.
User Password Is:	This displays whether a user password has been entered for the system. CLEAR means such a password has not been used and SET means a user password has been entered for the system.
Set Supervisor Password	When the item SET SUPERVISOR PASSWORD is highlighted, hit the <ENTER> key. When prompted, type the Supervisor's password in the dialogue box to set or to change supervisor's password, which allows access to the BIOS.

Table 6-13. Security Menu Options (Continued)

Menu Option	Description
Set User Password	When the item SET USER PASSWORD is highlighted, hit the <ENTER> key. When prompted, type the user's password in the dialogue box to set or to change the user's password, which allows access to the system at boot-up.
Password on Boot	This setting allows you to require a password to be entered when the system boots up. The options are ENABLED (password required) and DISABLED (password not required).

## 6-7 Boot

Figure 6-10. Boot Menu

PhoenixBIOS Setup Utility							
Main	Advanced	Security	Boot	Exit			
1: USB CDROM: PeppCMM Virtual Disc 2 2: ALL USB KEY 3: ALL USB CDROM 4: ALL PCI SCSI 5: ALL PCI BEV 6: ALL IDE HDD 7: ALL IDE CDROM 8: <ul style="list-style-type: none"> <li>: USB KEY: SanDisk Cruzer Micro-(USB(R/F)F</li> <li>: PCI SCSI: #0300 ID02 LUN0 ATA S</li> <li>: PCI BEV: IBA GE Slot 0400 v1270</li> <li>: PCI BEV: IBA GE Slot 0401 v1270</li> <li>: Legacy Network Card</li> <li>: Bootable Add-in Cards</li> </ul>			Item Specific Help  Keys used to view or configure devices: Up and Down arrows select a device. <+> and <-> moves the device up or down. <f> and <r> specifies the device fixed or removable. <x> exclude or include the device to boot. <Shift + 1> enables or disables a device. <1 - 4> Loads default boot sequence.				
F1	Help	↑↓	Select Item	-/+	Change Values	F9	Setup Defaults
Esc	Exit	↔	Select Menu	Enter	Select ▶ Sub-Menu	F10	Save and Exit

Choose **Boot** from the Phoenix BIOS Setup Utility main menu with the arrow keys. Highlighting a setting with a + or - will expand or collapse that entry. See details on how to change the order and specs of boot devices in the ITEM SPECIFIC HELP window.

## Boot Priority Order/Excluded from Boot Order

Use the UP and DOWN arrow keys to select a device. Use a <+> key or a <-> key to move the device up or down. Use the <f> key or the <r> key to specify the devices.

You can also use the keys indicated above to specify the priority of boot order of a device or to move items from the category of EXCLUDED FROM BOOT ORDER to the category of BOOT PRIORITY ORDER and vice versa. See details on how to change the priority of boot order of devices in the ITEM SPECIFIC HELP window.

Press X to select/deselect from order in boot sequence.

## 6-8 Exit

Figure 6-11. Exit Menu

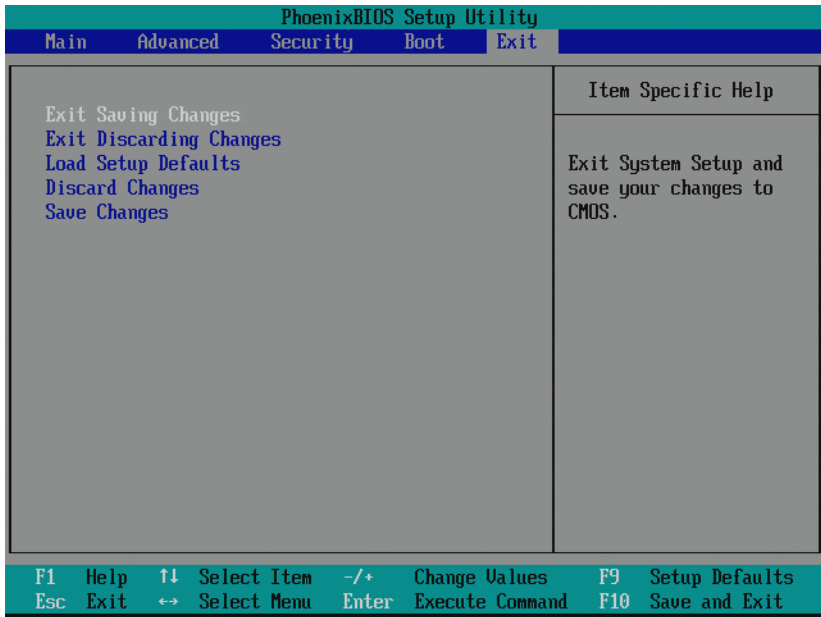

Choose EXIT from the Phoenix BIOS Setup Utility main menu with the arrow keys to bring up the EXIT menu (Figure 6-11). All Exit BIOS settings are described in Table 6-14 below.

**Table 6-14. Exit Menu Options**

<b>Menu Option</b>	<b>Description</b>
Exit Saving Changes	Highlight this item and hit <ENTER> to save any changes you made and to exit the BIOS Setup utility.
Exit Discarding Changes	Highlight this item and hit <ENTER> to exit the BIOS Setup utility without saving any changes you may have made.
Load Setup Defaults	Highlight this item and hit <ENTER> to load the default settings for all items in the BIOS Setup. These are the safest settings to use.
Discard Changes	Highlight this item and hit <ENTER> to discard (cancel) any changes you made. You will remain in the Setup utility.
Save Changes	Highlight this item and hit <ENTER> to save any changes you made. You will remain in the Setup utility.

## Notes

---

---

# Appendix A

## BIOS POST Codes

### A-1 BIOS POST Messages

During the Power-On Self-Test (POST), the BIOS will check for problems. If a problem is found, the BIOS will activate an alarm or display a message. The following is a list of such BIOS messages.

**Table A-1. BIOS POST Messages**

BIOS Message	Description
Failure Fixed Disk	Fixed disk is not working or not configured properly. Check to see if fixed disk is attached properly. Run Setup. Find out if the fixed-disk type is correctly identified.
Stuck key	Stuck key on keyboard.
Keyboard error	Keyboard not working.
Keyboard Controller Failed	Keyboard controller failed test. May require replacing keyboard controller.
Keyboard locked - Unlock key switch	Unlock the system to proceed.
Monitor type does not match CMOS - Run SETUP	Monitor type not correctly identified in Setup
Shadow Ram Failed at offset: nnnn	Shadow RAM failed at offset <b>nnnn</b> of the 64k block at which the error was detected.
System RAM Failed at offset: nnnn	System RAM failed at offset <b>nnnn</b> of in the 64k block at which the error was detected.
Extended RAM Failed at offset: nnnn	Extended memory not working or not configured properly at offset <b>nnnn</b> .
System battery is dead - Replace and run SETUP	The CMOS clock battery indicator shows the battery is dead. Replace the battery and run Setup to reconfigure the system.
System CMOS checksum bad - Default configuration used	System CMOS has been corrupted or modified incorrectly, perhaps by an application program that changes data stored in CMOS. The BIOS installed Default Setup Values. If you do not want these values, enter Setup and enter your own values. If the error persists, check the system battery or contact your dealer.
System timer error	The timer test failed. Requires repair of system board.
Real time clock error	Real-Time Clock fails BIOS hardware test. May require board repair.
Check date and time settings	BIOS found date or time out of range and reset the Real-Time Clock. May require setting legal date (1991-2099).

Table A-1. BIOS POST Messages (Continued)

BIOS Message	Description
Previous boot incomplete - Default configuration used	Previous POST did not complete successfully. POST loads default values and offers to run Setup. If the failure was caused by incorrect values and they are not corrected, the next boot will likely fail. On systems with control of <b>wait states</b> , improper Setup settings can also terminate POST and cause this error on the next boot. Run Setup and verify that the waitstate configuration is correct. This error is cleared the next time the system is booted.
Memory Size found by POST differed from CMOS	Memory size found by POST differed from CMOS.
Diskette drive A error Diskette drive B error	Drive A: or B: is present but fails the BIOS POST diskette tests. Check to see that the drive is defined with the proper diskette type in Setup and that the diskette drive is attached correctly.
Incorrect Drive A type - run SETUP	Type of floppy drive A: not correctly identified in Setup.
Incorrect Drive B type - run SETUP	Type of floppy drive B: not correctly identified in Setup.
System cache error - Cache disabled	RAM cache failed and BIOS disabled the cache. On older boards, check the cache jumpers. You may have to replace the cache. See your dealer. A disabled cache slows system performance considerably.
CPU ID:	CPU socket number for Multi-Processor error.
EISA CMOS not writeable	ServerBIOS2 test error: Cannot write to EISA CMOS.
DMA Test Failed	ServerBIOS2 test error: Cannot write to extended <b>DMA</b> (Direct Memory Access) registers.
Software NMI Failed	ServerBIOS2 test error: Cannot generate software NMI (Non-Maskable Interrupt).
Fail-Safe Timer NMI Failed	ServerBIOS2 test error: Fail-Safe Timer takes too long.
device Address Conflict	Address conflict for specified <b>device</b> .
Allocation Error for: device	Run ISA or EISA Configuration Utility to resolve resource conflict for the specified <b>device</b> .
CD ROM Drive	CD ROM Drive identified.
Entering SETUP...	Starting Setup program
Failing Bits: nnnn	The hex number <b>nnnn</b> is a map of the bits at the RAM address which failed the memory test. Each 1 (one) in the map indicates a failed bit. See errors 230, 231, or 232 above for offset address of the failure in System, Extended, or Shadow memory.
Fixed Disk n	Fixed disk <b>n</b> (0-3) identified.
Invalid System Configuration Data	Problem with NVRAM (CMOS) data.
I/O device IRQ conflict	I/O device IRQ conflict error.
PS/2 Mouse Boot Summary Screen:	PS/2 Mouse installed.

Table A-1. BIOS POST Messages (Continued)

BIOS Message	Description
nxxx kB Extended RAM Passed	Where <b>xxxx</b> is the amount of RAM in kilobytes successfully tested.
nxxx Cache SRAM Passed	Where <b>xxxx</b> is the amount of system cache in kilobytes successfully tested.
xxxx kB Shadow RAM Passed	Where <b>xxxx</b> is the amount of shadow RAM in kilobytes successfully tested.
xxxx kB System RAM Passed	Where <b>xxxx</b> is the amount of system RAM in kilobytes successfully tested.
One or more I2O Block Storage Devices were excluded from the Setup Boot Menu	There was not enough room in the IPL table to display all installed I2O block-storage devices.
Operating system not found	Operating system cannot be located on either drive A: or drive C:. Enter Setup and see if fixed disk and drive A: are properly identified.
Parity Check 1 nxxx	Parity error found in the system bus. BIOS attempts to locate the address and display it on the screen. If it cannot locate the address, it displays ??????. Parity is a method for checking errors in binary data. A parity error indicates that some data has been corrupted.
Parity Check 2 nxxx	Parity error found in the I/O bus. BIOS attempts to locate the address and display it on the screen. If it cannot locate the address, it displays ?????.
Press <F1> to resume, <F2> to Setup, <F3> for previous	Displayed after any recoverable error message. Press <F1> to start the boot process or <F2> to enter Setup and change the settings. Press <F3> to display the previous screen (usually an initialization error of an <b>Option ROM</b> , i.e., an add-on card). Write down and follow the information shown on the screen.
Press <F2> to enter Setup	Optional message displayed during POST. Can be turned off in Setup.
PS/2 Mouse:	PS/2 mouse identified.
Run the I2O Configuration Utility	One or more unclaimed block storage devices have the Configuration Request bit set in the LCT. Run an I2O Configuration Utility (e.g. the SAC utility).
System BIOS shadowed	System BIOS copied to shadow RAM.
UMB upper limit segment address: nxxx	Displays the address <b>xxxx</b> of the upper limit of <b>Upper Memory Blocks</b> , indicating released segments of the BIOS which can be reclaimed by a virtual memory manager.
Video BIOS shadowed	Video BIOS successfully copied to shadow RAM.

## A-2 BIOS POST Codes

This section lists the POST (Power-On Self-Test) codes for the Phoenix BIOS. POST codes are divided into two categories: recoverable and terminal.

## Recoverable POST Errors

When a recoverable type of error occurs during POST, the BIOS will display an POST code that describes the problem. BIOS may also issue one of the following beep codes:

- **One long and two short beeps** – video configuration error
- **One repetitive long beep** – no memory detected

## Terminal POST Errors

If a terminal type of error occurs, BIOS will shut down the system. Before doing so, BIOS will write the error to *port 80h*, attempt to initialize video and write the error in the top left corner of the screen.

The following is a list of codes that may be written to *port 80h*.

**Table A-2. Terminal POST Errors**

Post Code	Description
02h	Verify Real Mode
03h	Disable Non-Maskable Interrupt (NMI)
04h	Get CPU type
06h	Initialize system hardware
07h	Disable shadow and execute code from the ROM.
08h	Initialize chipset with initial POST values
09h	Set IN POST flag
0Ah	Initialize CPU registers
0Bh	Enable CPU cache
0Ch	Initialize caches to initial POST values
0Eh	Initialize I/O component
0Fh	Initialize the local bus IDE
10h	Initialize Power Management
11h	Load alternate registers with initial POST values
12h	Restore CPU control word during warm boot
13h	Initialize PCI Bus Mastering devices
14h	Initialize keyboard controller
16h	1-2-2-3 BIOS ROM checksum
17h	Initialize cache before memory Auto size
18h	8254 timer initialization
1Ah	8237 DMA controller initialization
1Ch	Reset Programmable Interrupt Controller
20h	1-3-1-1 Test DRAM refresh

Table A-2. Terminal POST Errors (Continued)

Post Code	Description
22h	1-3-1-3 Test 8742 Keyboard Controller
28h	Auto size DRAM
29h	Initialize POST Memory Manager
2Ah	Clear 512 kB base RAM
2Ch	1-3-4-1 RAM failure on address line <b>xxxx*</b>
2Eh	1-3-4-3 RAM failure on data bits <b>xxxx*</b> of low byte of memory bus
2Fh	Enable cache before system BIOS shadow
32h	Test CPU bus-clock frequency
33h	Initialize Phoenix Dispatch Manager
36h	Warm start shut down
38h	Shadow system BIOS ROM
3Ah	Auto size cache
3Ch	Advanced configuration of chipset registers
3Dh	Load alternate registers with CMOS values
41h	Initialize extended memory for RomPilot
42h	Initialize interrupt vectors
45h	POST device initialization
46h	2-1-2-3 Check ROM copyright notice
47h	Initialize I20 support
48h	Check video configuration against CMOS
49h	Initialize PCI bus and devices
4Ah	Initialize all video adapters in system
4Bh	QuietBoot start (optional)
4Ch	Shadow video BIOS ROM
4Eh	Display BIOS copyright notice
4Fh	Initialize MultiBoot
50h	Display CPU type and speed
51h	Initialize EISA board
52h	Test keyboard
54h	Set key click if enabled
55h	Enable USB devices
58h	2-2-3-1 Test for unexpected interrupts
59h	Initialize POST display service
5Ah	Display prompt "Press F2 to enter SETUP"
5Bh	Disable CPU cache

Table A-2. Terminal POST Errors (Continued)

Post Code	Description
5Ch	Test RAM between 512 and 640 kB
60h	Test extended memory
62h	Test extended memory address lines
64h	Jump to UserPatch1
66h	Configure advanced cache registers
67h	Initialize Multi Processor APIC
68h	Enable external and CPU caches
69h	Setup System Management Mode (SMM) area
6Ah	Display external L2 cache size
6Bh	Load custom defaults (optional)
6Ch	Display shadow-area message
6Eh	Display possible high address for UMB recovery
70h	Display error messages
72h	Check for configuration errors
76h	Check for keyboard errors
7Ch	Set up hardware interrupt vectors
7Dh	Initialize Intelligent System Monitoring
7Eh	Initialize coprocessor if present
80h	Disable onboard Super I/O ports and IRQs
81h	Late POST device initialization
82h	Detect and install external RS232 ports
83h	Configure non-MCD IDE controllers
84h	Detect and install external parallel ports
85h	Initialize PC-compatible PnP ISA devices
86h	Re-initialize onboard I/O ports.
87h	Configure Motherboard Configurable Devices (optional)
88h	Initialize BIOS Data Area
89h	Enable Non-Maskable Interrupts (NMIs)
8Ah	Initialize Extended BIOS Data Area
8Bh	Test and initialize PS/2 mouse
8Ch	Initialize floppy controller
8Fh	Determine number of ATA drives (optional)
90h	Initialize hard-disk controllers
91h	Initialize local-bus hard-disk controllers
92h	Jump to UserPatch2

Table A-2. Terminal POST Errors (Continued)

Post Code	Description
93h	Build MPTABLE for multi-processor boards
95h	Install CD ROM for boot
96h	Clear huge ES segment register
98h	1-2 Search for option ROMs. One long, two short beeps on check-sum failure
99h	Check for SMART Drive (optional)
9Ah	Shadow option ROMs
9Ch	Set up Power Management
9Dh	Initialize security engine (optional)
9Eh	Enable hardware interrupts
9Fh	Determine number of ATA and SCSI drives
A0h	Set time of day
A2h	Check key lock
A4h	Initialize typematic rate
A8h	Erase F2 prompt
AAh	Scan for F2 key stroke
ACh	Enter SETUP
A Eh	Clear Boot flag
B0h	Check for errors
B1h	Inform RomPilot about the end of POST.
B2h	POST done - prepare to boot operating system
B4h	1 One short beep before boot
B5h	Terminate QuietBoot (optional)
B6h	Check password (optional)
B7h	Initialize ACPI BIOS
B9h	Prepare Boot
BAh	Initialize SMBIOS
BBh	Initialize PnP Option ROMs
BCh	Clear parity checkers
BDh	Display MultiBoot menu
BEh	Clear screen (optional)
BFh	Check virus and backup reminders
C0h	Try to boot with INT 19
C1h	Initialize POST Error Manager (PEM)
C2h	Initialize error logging
C3h	Initialize error display function

**Table A-2. Terminal POST Errors (Continued)**

Post Code	Description
C4h	Initialize system error handler
C5h	PnPnd dual CMOS (optional)
C6h	Initialize note dock (optional)
C7h	Initialize note dock late
C8h	Force check (optional)
C9h	Extended checksum (optional)
CAh	Redirect Int 15h to enable remote keyboard
CBh	Redirect Int 13h to Memory Technologies Devices such as ROM, RAM, PCMCIA, and serial disk
CCh	Redirect Int 10h to enable remote serial video
CDh	Re-map I/O and memory for PCMCIA
CEh	Initialize digitizer and display message
D2h	Unknown interrupt

The following are for the boot block in Flash ROM:

**Table A-3. Boot Block Flash ROM Terminal POST Errors**

Post Code	Description
E0h	Initialize the chipset
E1h	Initialize the bridge
E2h	Initialize the CPU
E3h	Initialize system timer
E4h	Initialize system I/O
E5h	Check force recovery boot
E6h	Checksum BIOS ROM
E7h	Go to BIOS
E8h	Set Huge Segment
E9h	Initialize Multi Processor
EAh	Initialize OEM special code
EBh	Initialize PIC and DMA
ECh	Initialize Memory type
EDh	Initialize Memory size
EEh	Shadow Boot Block
EFh	System memory test
F0h	Initialize interrupt vectors
F1h	Initialize Run Time Clock

**Table A-3. Boot Block Flash ROM Terminal POST Errors (Continued)**

Post Code	Description
F2h	Initialize video
F3h	Initialize System Management Manager
F4h	Output one beep
F5h	Clear Huge Segment
F6h	Boot to Mini DOS
F7h	Boot to Full DOS

If the BIOS detects error 2C, 2E, or 30 (base 512K RAM error), it displays an additional word-bitmap (**xxxx**) indicating the address line or bits that failed. For example, "2C 0002" means address line 1 (bit one set) has failed. "2E 1020" means data bits 12 and 5 (bits 12 and 5 set) have failed in the lower 16 bits. The BIOS also sends the bitmap to the port-80 LED display. It first displays the checkpoint code, followed by a delay, the high-order byte, another delay, and then the low order byte of the error. It repeats this sequence continuously.

## Notes

---

---

# Appendix B

## iSCSI Setup Procedure

This appendix covers the iSCSI setup procedure for Supermicro blade systems. If you do not wish to employ this optional interface for your blades, then skip this procedure in your blade setup.



**NOTE:** iSCSI installation requires two (2) network switch/pass-thru modules to implement.

To implement iSCSI use in Supermicro blade systems, use the procedure below:

1. On boot-up press CTRL-D to go to the iSCSI PORT SELECTION screen.
2. Set one port to **Primary** and press <ENTER>.
3. Select the iSCSI BOOT CONFIGURATION option.
4. For DYNAMIC IP CONFIGURATION (DHCP) enter information for the following settings:
  - Initiator Name
  - Initiation IP
  - Subnet Mask
  - Gateway
  - VLAN ID
5. For USE DHCP FOR iSCSI TARGET INFORMATION enter information for the following settings, and then select OK to continue:
  - Target Name
  - Target IP
  - Target Port
  - Boot LUN
6. Select SAVE CHANGES AND EXIT on the setup screen.
7. Put the *Windows Installation CD* into the CD-ROM drive. In Windows press F6 to load the *Intel® iSCSI Setup* driver from the disc.
  - a. If you installed *Windows 2003 32-bit SP1 or SP1 R2* then install the *Microsoft Hotfix for Windows Server, KB902113 NDIS QFE*. Windows 2003 SP2 contains the QFE.
  - b. To Install Windows 2003 x64 you must first create an operating system installation media including a *Hot Fix* referenced from *KB article #934848* at:

<http://support.microsoft.com/kb/934848/en-us>

8. Copy the following Windows drivers to your desktop (or a convenient directory for later reference and use):
  - Intel Network Driver
  - Microsoft iSCSI Software Initiator with integrated software boot support
  - ISBOOT.exe
9. Bring up the WINDOWS DEVICE MANAGER screen, and under devices, highlight the second ETHERNET CONTROLLER (under OTHER DEVICES).
10. Select UPDATE DRIVER from the right-click menu. When prompted for the driver file, point to where you saved the driver files and windows will pick it up for installation.
11. Launch the MS ISCSI INITIATOR file that you saved previously, and do the following actions on the MICROSOFT ISCSI INITIATOR INSTALLATION screens that appear:
  - a. Go through the first two screens and on the third screen check the MICROSOFT MPIO MULTIPATHING SUPPORT FOR ISCSI check box (Figure B-1).

**Figure B-1. Microsoft MPIO Multipathing Support for iSCSI Check Box**

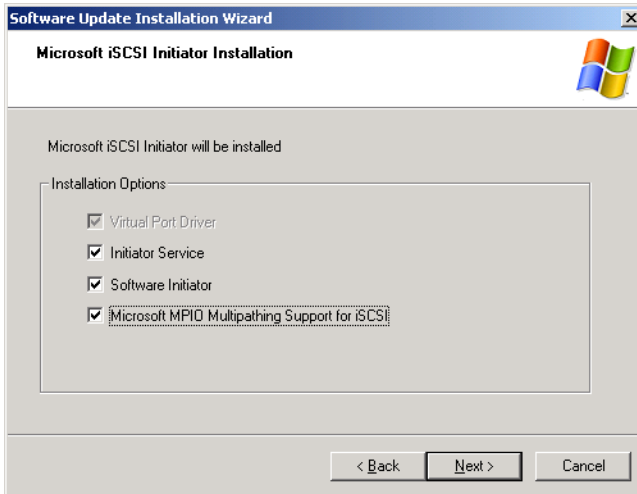

- b. On the next screen check the CONFIGURE ISCSI NETWORK BOOT SUPPORT check box and select the INTEL GIGABIT ADAPTER identified as **e1express** (Figure B-2).

Figure B-2. Configure iSCSI Network Boot Support Check Box

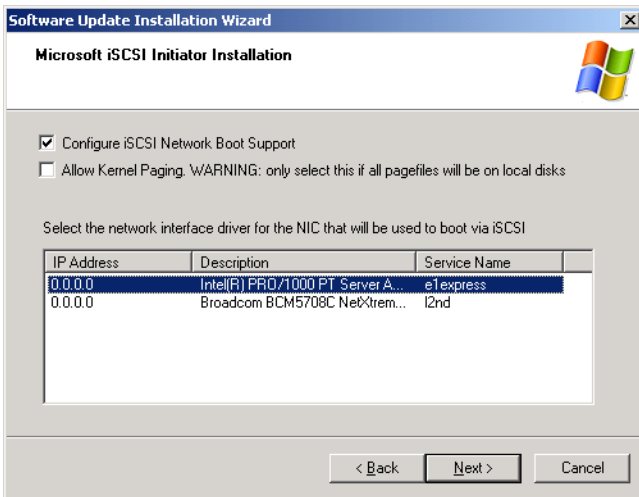

- c. In the next screen select AGREE.
  - d. In the final screen, click FINISH.
12. Reboot the system.
  13. Launch the *ISBOOT.exe* file. It will create an *Intel/12.3* folder on your system. In this new folder look for either the *WIN32* folder for 32-bit Windows installation, or the *WINX64* folder for 64-bit installation.
  14. In the *WIN32* folder launch the *iSCSIAPP.exe* file for 32-bit installation, or in the *WINX64* folder launch the *iSCSIAPP.exe* file. In the window that appears select first YES and then OK at the prompts.
  15. Reboot the system and press CTRL-D to go back to the iSCSI PORT SELECTION screen. In this screen disable the first primary port and then enable the second port to **Primary**.
  16. Repeat [step 3](#) through [step 6](#) above to configure the new port.
  17. Update the network driver in the WINDOWS DEVICE MANAGER for the **first** Ethernet controller by highlighting the first listed ETHERNET CONTROLLER (under OTHER DEVICES) and selecting UPDATE DRIVER from the right-click menu.  
  
When prompted for the driver file, point to where you saved the driver files and windows will pick it up for installation.
  18. Uninstall the *Intel @iSCSI Setup* driver in the WINDOWS DEVICE MANAGER window (right-click UNINSTALL).

19. Open the WINDOWS COMMAND PROMPT terminal window and type

**iscsibcg /verify /fix**

in the window and press <ENTER>.

20. Reboot the system.

---

---

# Disclaimer

The products sold by Supermicro are not intended for and will not be used in life support systems, medical equipment, nuclear facilities or systems, aircraft, aircraft devices, aircraft/emergency communication devices or other critical systems whose failure to perform be reasonably expected to result in significant injury or loss of life or catastrophic property damage. Accordingly, Supermicro disclaims any and all liability, and should buyer use or sell such products for use in such ultra-hazardous applications, it does so entirely at its own risk. Furthermore, buyer agrees to fully indemnify, defend and hold Supermicro harmless for and against any and all claims, demands, actions, litigation, and proceedings of any kind arising out of or related to such ultra-hazardous use or sale.

---

