

Information for Lot 9 of ErP (Ecodesign)

This addendum addresses European Union (EU) Ecodesign requirements for servers and storage products. All data and ratings within this addendum are in reference only to the Supermicro product(s) in the manual. The below information conforms to requirements laid down in Annex II of the Commission Regulation 2019/424.

- 3(1)(a): See Section 1.1 of the system manual for the product type.
- 3(1)(b): See the title page and preface of the system manual for the trademark and manufacturer's address.
- 3(1)(c): See the title page of the system manual for product model number(s).
- 3(1)(d): See the serial number on the physical system to determine the year of manufacture.
- 3(1)(e-j): **PSU Efficiency and Power Factor Value (Table) (From 80 Plus report)**

PSU Model #: PWS-1K27A-1R Watts: 1200W	PSU Efficiency				Power Factor
	10 %	20 %	50 %	100 %	
% of Rated Load	10 %	20 %	50 %	100 %	50 %
Single Output (AC-DC)	90.82%	95.06%	96.15%	94.55%	0.9946
Multiple Output (AC-DC)	N/A	N/A	N/A	N/A	N/A

System (EUT) Efficiency in **Idle State** Power (Table)

Representative Configurations	Measured Idle State Power (W)	Calculated Idle Power Allowance (W)
High-End Performance Configuration	330.0	492.90
Typical Configuration	N/A	N/A
Low-End Performance Configuration	142.8	305.97

System (EUT) Efficiency in **Active State** Power (Table)

Representative Configurations	Active State Efficiency Score (Effserver)	Minimum Active State Efficiency for 2-Socket Server
High-End Performance Configuration	36.9	9.5
Typical Configuration	N/A	
Low-End Performance Configuration	32.9	

3(1)(k): The operating condition class is **A2**.

Operating Condition Class	Dry Bulb Temp °C		Humidity Range (Non-Condensing)		Max Dew Point (°C)	Max Rate of Change (°C/hr.)
	Allowable Range	Recommended Range	Allowable Range Dew Point (DP) Relative Humidity (RH)	Recommend Range		
A1	15-32	18-27	- 12 °C DP and 8 % RH to 17 °C DP and 80 % RH	-9°C DP to 15°C and 60% RH	21	5/20
A2	10-35	18-27	- 12 °C DP and 8 % RH to 21 °C DP and 80 % RH	Same as A1	21	5/20
A3	5-40	18-27	- 12 °C DP and 8 % RH to 24 °C DP and 85 % RH	Same as A1	24	5/20
A4	5-45	18-27	- 12 °C DP and 8 % RH to 24 °C DP and 90 % RH	Same as A1	24	5/20

3(1)(l): The idle state power at the higher boundary temperature of the operating conditions class is 330.0 W.

3(1)(m): The active state efficiency and performance is 36.9.

3(1)(n): There are two methods by which a user can securely delete data from this system. The user performing secure data deletion should be an IT professional.

The first is with a Unified Extensible Firmware Interface (UEFI) shell utility. This utility works on X10/X11/X12/H11/H12/M11 motherboard series with onboard SATA/NVMe devices. Any user may access and download this utility through following link:
https://www.supermicro.com/about/policies/disclaimer.cfm?url=/wftp/utility/Lot9_Secure_Data_Deletion_Utility/

Download the shell utility package and extract it to a USB flash drive, then plug the drive into the server for which secure data deletion is necessary. Then turn the system on. Navigate to the BIOS setup menu, then place the server system into the UEFI shell environment. Follow the instructions in the README file to invoke the utility and complete the deletion.

The second method is through the secure data deletion tool provided by the original manufacturer of the hard drive. This should be used in a scenario where the shell utility is not applicable. Each manufacturer should have the tool available on their website. If needed, please look on the hard drive label for the name of the manufacturer and model information.

3(1)(o): List of recommended combinations of blade servers with chassis: N/A.

3(1)(p): List of all current SKUs within this product family: SYS-121C-TN2R.

3(3)(a): There is no use of cobalt in batteries in this product.

The indicative weight range of Neodymium in the HDD is 0.0 if manufactured by Western Digital, and is between 5-25 grams if manufactured by Seagate.

3(3)(b): Please see the disassembly instructions on the next page.

Illustrated System Disassembly Instructions

Please note: All the illustrations in the below disassembly instructions are for demonstration only. Components shown here may not match exactly with the components in your system.

CAUTION: Always power off the system and unplug the power cord(s) first before disassembling the system!

1. Chassis Cover

Type and number of fastenings: One (1) knob.

Tools required: None.

Procedure: Loosen the knob on the chassis rear window. Apply pressure to the corners of the chassis lid and slide the cover toward the rear. Lift the top cover up from chassis.

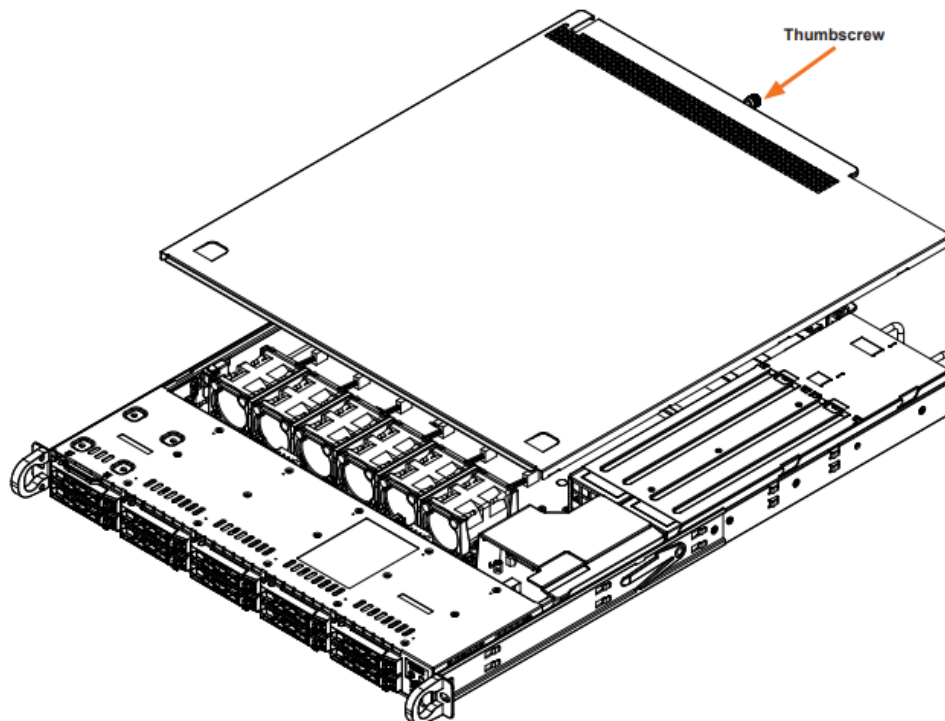

2. Data Storage Devices

Type and number of fastenings: One (1) latch and two (2) locking clasps.

Tools required: None.

Procedure: Press the release button on the drive carrier to extend the drive carrier handle. Swing the handle open and pull the carrier out of its bay. Pull out the two blue locking clasps on the left outer side of the carrier and lift out the drive.

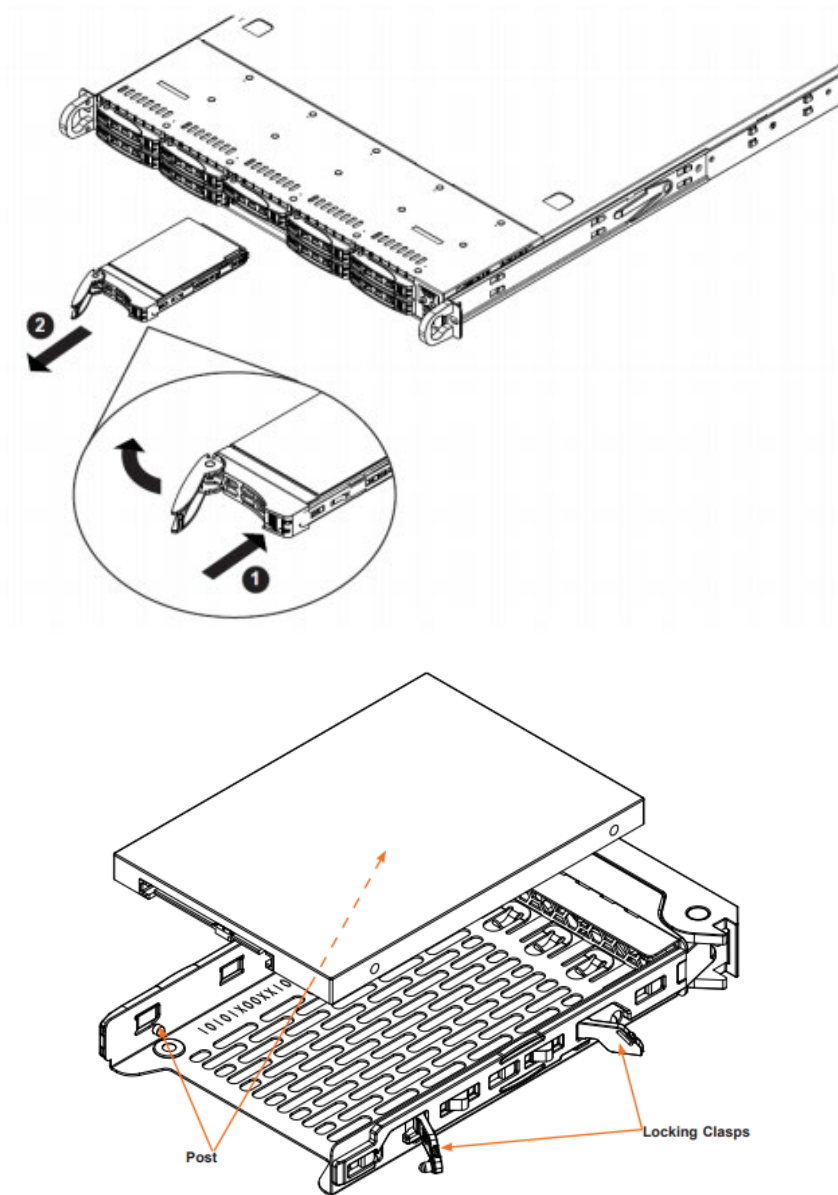

3. Memory

Type and number of fastenings: Two (2) latches per DIMM.

Tools required: None.

Procedure: Press both release tabs at the ends of the DIMM to unlock. Once the module pops out, remove it from the memory slot.

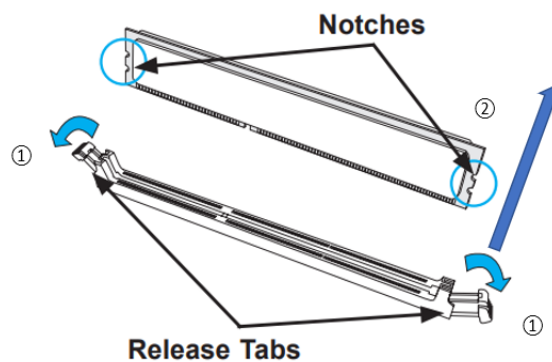

4. Processor

Type and number of fastenings: Four (4) T30 Torx screws.

Tools required: Screwdriver with T30 Torx bit.

Procedure:

1. Use a T30-bit screwdriver to loosen the four peek nuts on the heatsink in the sequence of A, B, C, and D.

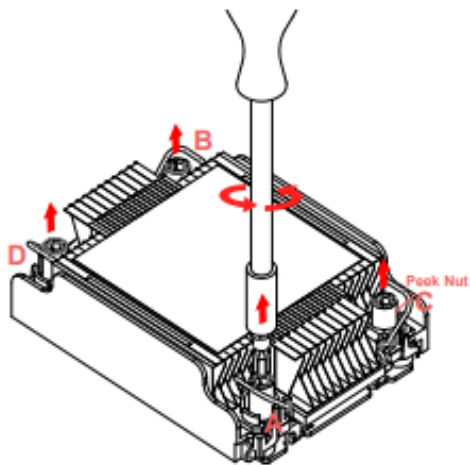

2. Press the four rotating wires inward to unlatch the processor heatsink module as shown below.

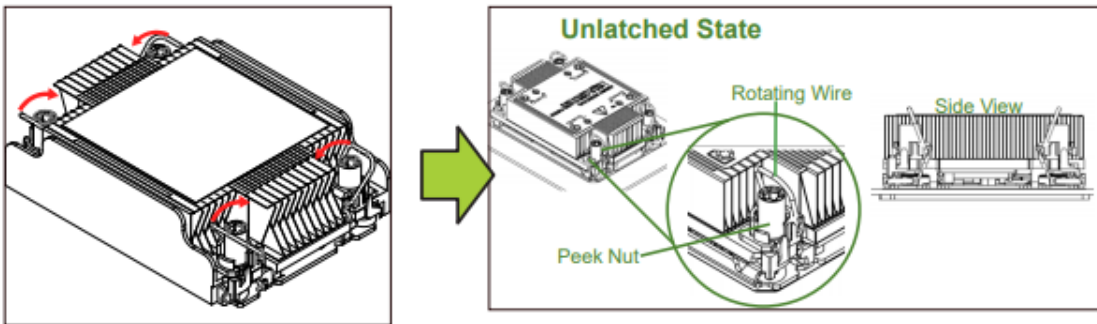

3. Gently lift the processor heatsink module upward to remove it from the processor socket.

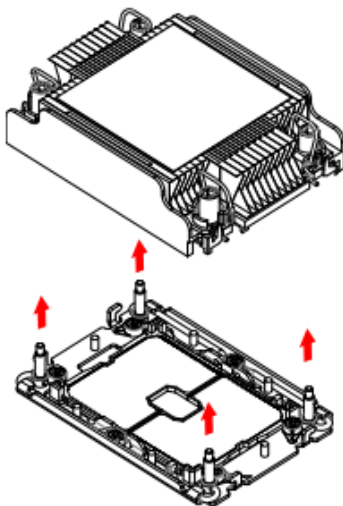

4. Unlock the lever from its locked position and push it upward to disengage the processor from the carrier as shown in the picture. Carefully remove the processor from the carrier. Handle the processor with care to avoid damage.

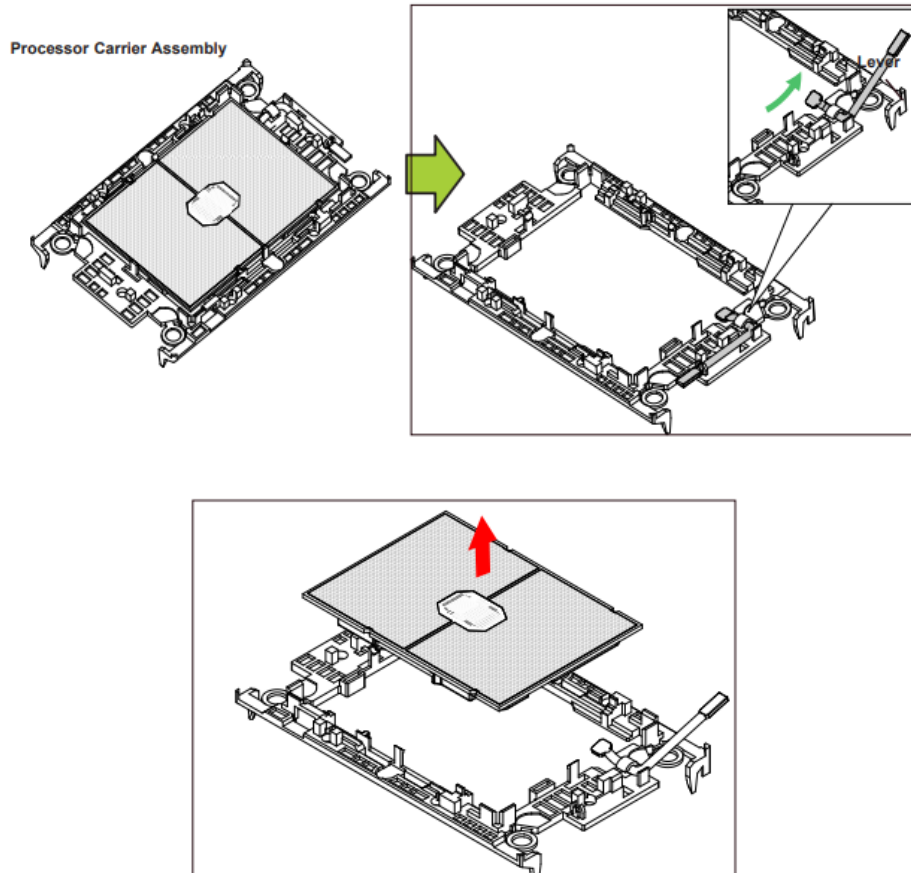

5. PCIe Expansion/Graphic Card and AIOM

Type and number of fastenings: One (1) latch on each riser bracket, and one (1) thumbscrew on AIOM card or AIOM window.

Tools required: Screwdriver with PH2 bit.

Procedure: Pull the riser bracket up and out along with the sections of the chassis in the rear. After lifting it up and away from the system, open the window latch and carefully slide the PCIe card away from the riser card slot.

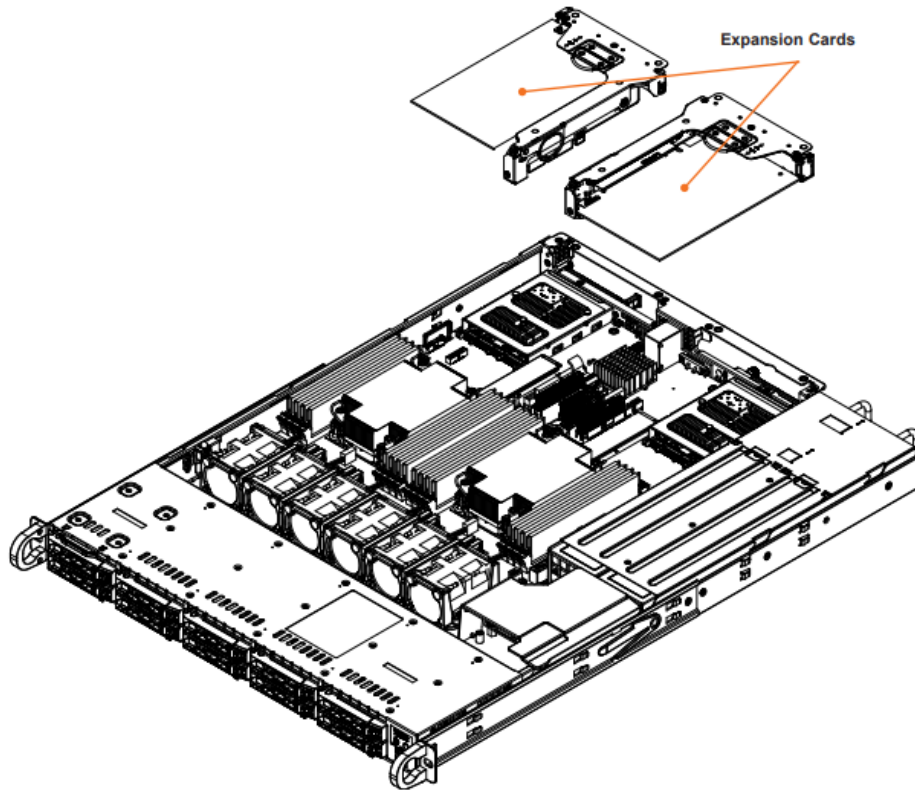

To remove the AIOM, remove the blank cover plate window by unscrewing the thumbscrew on the AIOM, then pulling out the AIOM card from the slot.

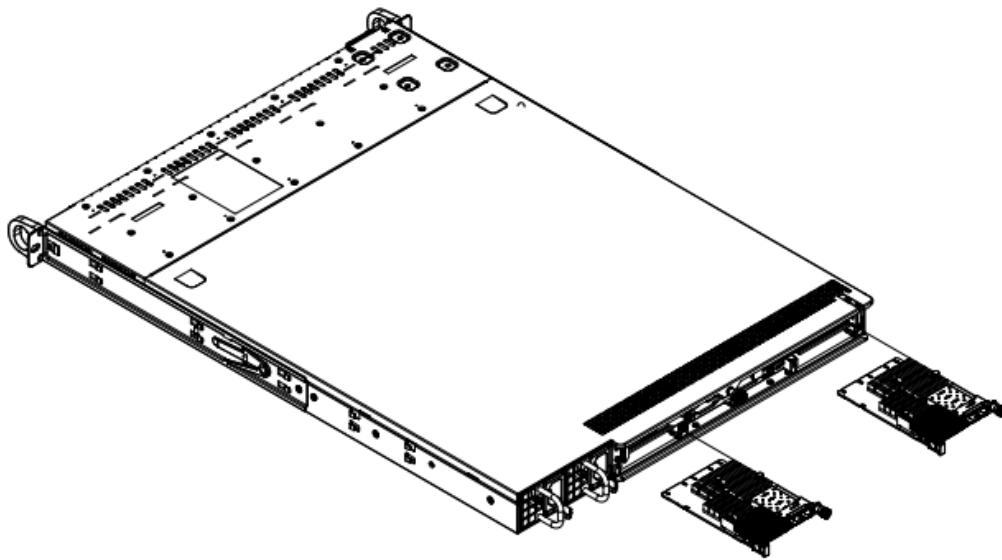

6. Batteries

Type and number of fastenings: One (1) latch.

Tools required: None.

Procedure: Push aside the small clamp that covers the edge of the battery. When the battery is released, lift it out of the holder.

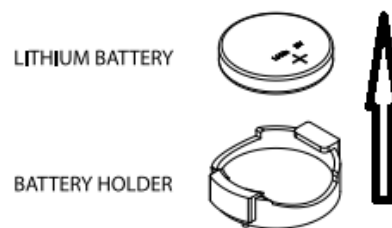

7. Riser Card

Type and number of fastenings: Two (2) Phillips screws on each riser bracket.

Tools required: Screwdriver with PH2 bit.

Procedure: Pull the riser bracket up and out along with the sections of the chassis in the rear. Remove the Phillips screws from both left and right riser cards to detach the riser cards from the bracket.

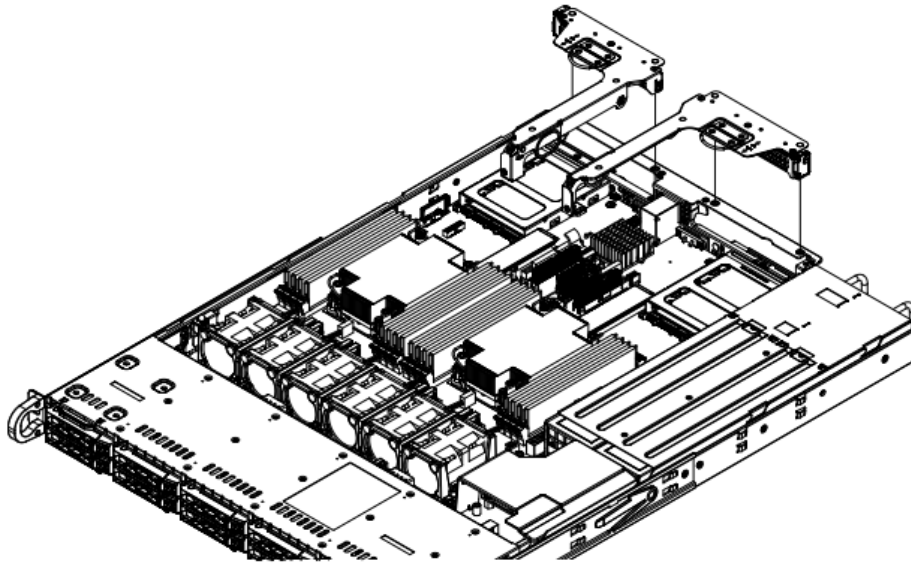

8. Fans

Type and number of fastenings: One (1) fan header per fan.

Tools required: None.

Procedure: Disconnect the fan wiring from the fan header on the motherboard. Pull out the fan from the fan tray.

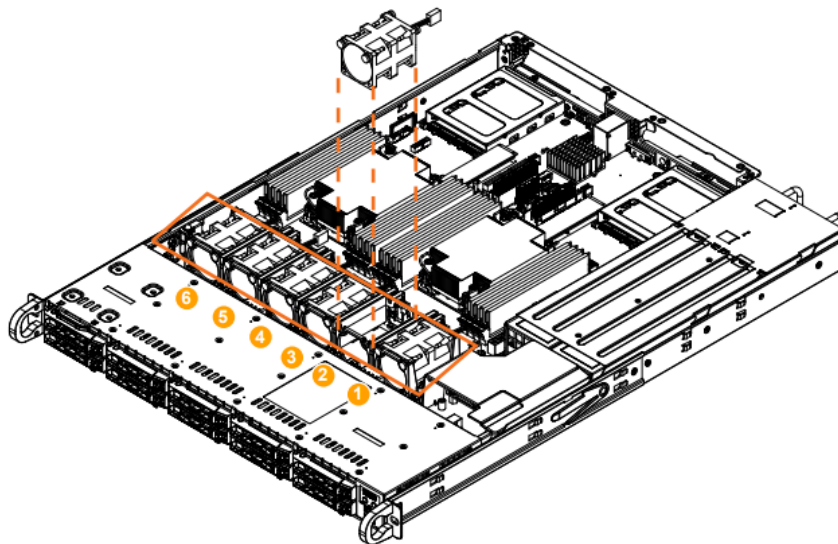

9. Power Supply

Type and number of fastenings: One (1) latch per power supply.

Tools required: None.

Procedure: Unplug the power cord from power supply. Push the release tab on the back of the power supply to the side and pull the module straight out.

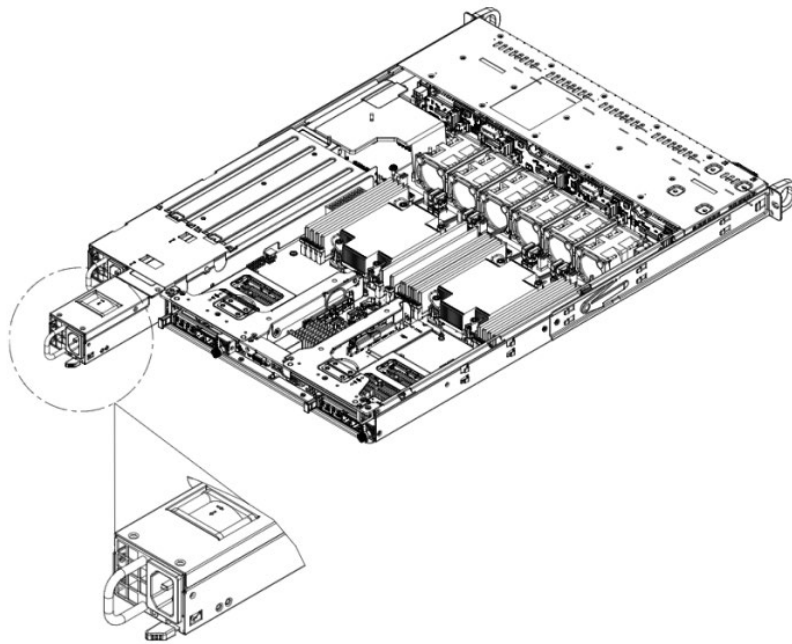

10. Motherboard

Type and number of fastenings: Seven (7) Phillips screws.

Tools required: Screwdriver with PH2 bit.

Procedure: Remove all seven Phillips screws. Gently lift the board from its base.

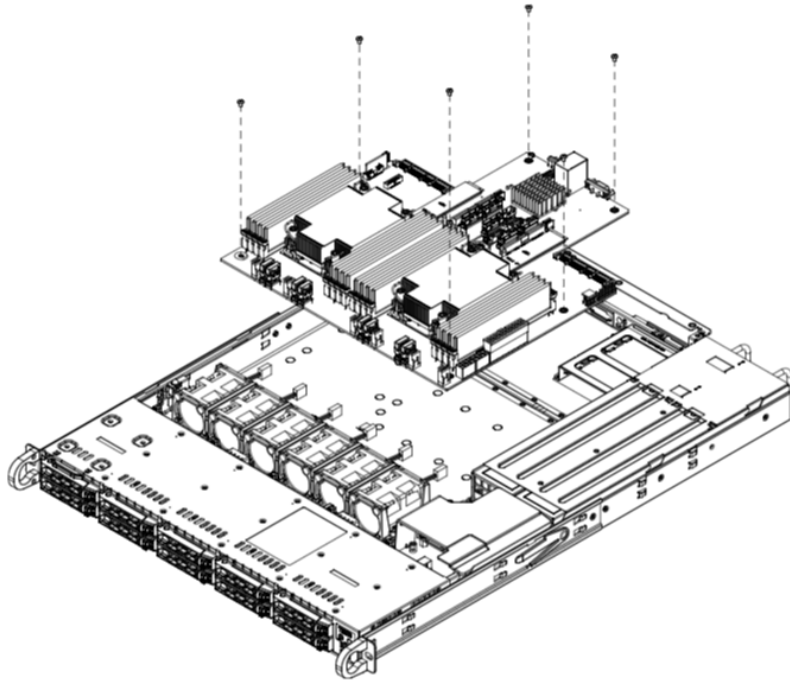

11. Backplane

Type and number of fastenings: Five (5) Phillips screws.

Tools required: Screwdriver with PH2 bit.

Procedure: Disconnect all cables. Remove the five Phillips screws to release and remove the backplane.

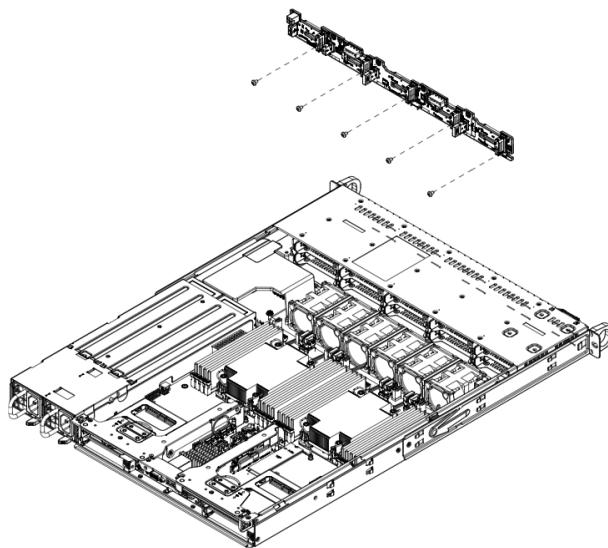

12. Power Distribution Board

Type and number of fastenings: Four (4) Phillips screws.

Tools required: Screwdriver with PH2 bit.

Procedure: Remove the power supplies and disconnect all power cables going to the motherboard and backplane. Take out the cover and remove the four Phillips screws to detach the power distribution board.

