

## Information for Lot 9 of ErP (Ecodesign)

This addendum addresses European Union (EU) Ecodesign requirements for servers and storage products. All data and ratings within this addendum are in reference only to the Supermicro product(s) in the manual. The below information conforms to requirements laid down in Annex II of the Commission Regulation 2019/424.

- 3(1)(a): See Section 1.1 of the system manual for the product type.
- 3(1)(b): See the title page and preface of the system manual for the trademark and manufacturer's address.
- 3(1)(c): See the title page of the system manual for product model number(s).
- 3(1)(d): See the serial number on the physical system to determine the year of manufacture.
- 3(1)(e-j): **PSU Efficiency and Power Factor Value (Table) (From 80 Plus report)**

<b>PSU Model #: PWS-407P-1R Watts: 400W</b>	<b>PSU Efficiency</b>				<b>Power Factor</b>
<b>% of Rated Load</b>	<b>10 %</b>	<b>20 %</b>	<b>50 %</b>	<b>100 %</b>	<b>50 %</b>
Single Output (AC-DC)	85.64 %	92.05 %	94.43 %	93.17 %	0.98

### **System (EUT) Efficiency in Idle State Power (Table)**

<b>Representative Configurations</b>	<b>Measured Idle State Power (W)</b>	<b>Calculated Idle Power Allowance (W)</b>
High-End Performance Configuration	69.50	290.72
Typical Configuration	N/A	N/A
Low-End Performance Configuration	51.20	195.21

### **System (EUT) Efficiency in Active State Power (Table)**

<b>Representative Configurations</b>	<b>Active State Efficiency Score (Effserver)</b>	<b>Minimum Active State Efficiency</b>
High-End Performance Configuration	17.7	9
Typical Configuration	N/A	
Low-End Performance Configuration	14.1	

3(1)(k): The operating condition class is **A2**.

Operating condition class	Dry bulb temp °C		Humidity range, non-condensing		Max dew point (°C)	Maximum rate of change (°C/hr)
	Allowable range	Recommended range	Allowable range	Recommended range		
A1	15- 32	18-27	- 12 °C Dew Point (DP) and 8 % relative humidity (RH) to 17 °C DP and 80 % RH	- 9 °C DP to 15 °C DP and 60 % RH	17	5/20
A2	10-35	18-27	- 12 °C DP and 8 % RH to 21 °C DP and 80 % RH	Same as A1	21	5/20
A3	5-40	18-27	- 12 °C DP and 8 % RH to 24 °C DP and 85 % RH	Same as A1	24	5/20
A4	5-45	18-27	- 12 °C DP and 8 % RH to 24 °C DP and 90 % RH	Same as A1	24	5/20

3(1)(l): The idle state power at the higher boundary temperature of the operating conditions class is 82.01 W.

3(1)(m): The active state efficiency and performance is a minimum of 14.1.

3(1)(n): There are two methods by which a user can securely delete data from this system. The user performing secure data deletion should be an IT professional.

The first is with a Unified Extensible Firmware Interface (UEFI) shell utility. This utility works on X12/X11/H11/H12/M11 motherboard series with onboard SATA/NVMe devices. Any user may access and download this utility through following link:  
[https://www.supermicro.com/about/policies/disclaimer.cfm?url=/wftp/utility/Lot9\\_Secure\\_Data\\_Deletion\\_Utility/](https://www.supermicro.com/about/policies/disclaimer.cfm?url=/wftp/utility/Lot9_Secure_Data_Deletion_Utility/)

Download the shell utility package and extract it to a USB flash drive, then plug the drive into the server for which secure data deletion is necessary. Then turn the system on. Navigate to the BIOS setup menu, and then place the server system into the UEFI shell

environment. Follow the instructions in the README file to invoke the utility and complete the deletion.

The second method is through the secure data deletion tool provided by the original manufacturer of the hard drive. This should be used in a scenario where the shell utility is not applicable. Each manufacturer should have the tool available on their website. If needed, please look on the hard drive label for the name of the manufacturer and model information.

3(1)(o): List of recommended combinations of blade servers with chassis: N/A.

3(1)(p): List of all current SKUs within this product family: SYS-510T-MR.

3(3)(a): There is no use of cobalt in batteries in this product.

The indicative weight range of neodymium in the HDD is 0.0 if manufactured by Western Digital, and is between 5-25 grams if manufactured by Seagate.

3(3)(b): Please see the disassembly instructions on the next page.

## Illustrated System Disassembly Instructions

*Please note:* All the illustrations in the below disassembly instructions are for demonstration only. Components shown here may not match exactly with the components in your system.

**CAUTION: Always power off the system and unplug the power cord(s) first before disassembling the system!**

### 1. Data Storage Devices

*Type and number of fastenings:* One (1) latch and six (6) Phillips screws.

*Tools required:* Screwdriver with PH2 bit.

*Procedure:* Push the release button on the carrier. Swing the handle fully. Grasp the handle and pull the drive carrier out of its bay.

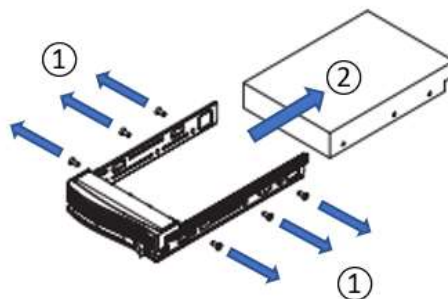
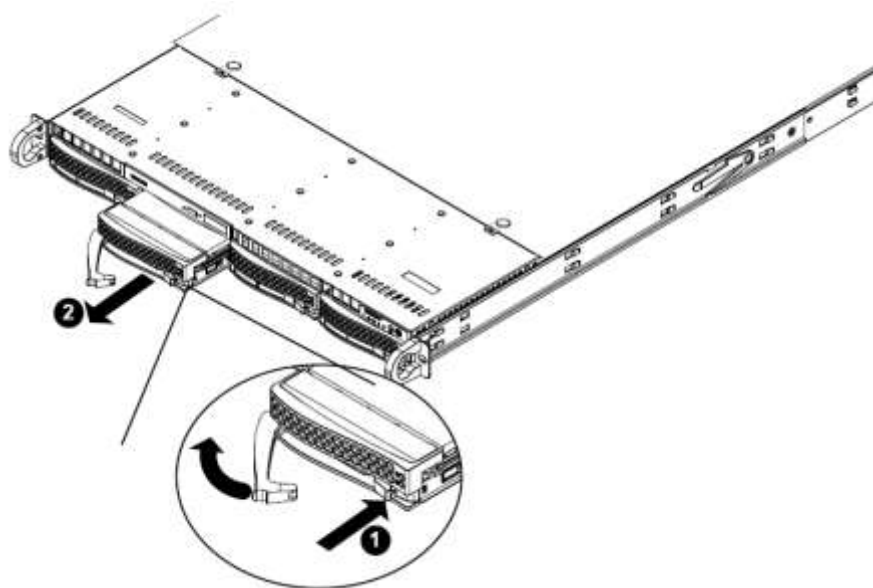

---

## 2. Memory

Type and number of fastenings: Two (2) latches per memory module.

Tools required: None.

Procedure: Press both release tabs on the ends of the memory module to unlock it. Once the module is loosened, remove it from the memory slot.

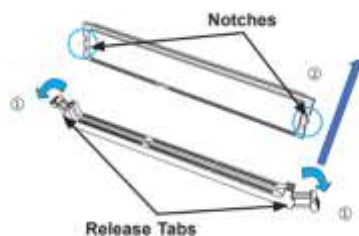

---

## 3. Processor (LGA-4189)

Type and number of fastenings: Four (4) T30 Torx screws.

Tools required: Screwdriver with T30 Torx bit.

Procedure: Using a T30 Torx-bit screwdriver, loosen the four peek nuts in the sequence of 4, 3, 2, then 1. Ensure that the four rotating wires are in an "up" (unlocked) position. Gently lift the module up to remove it from the socket. Flip the processor heatsink module with the gold contacts facing up. Unlock the lever and gently remove the processor.

### Removing the Processor Heatsink Module

1. Using a T30 Torx-bit screwdriver, loosen the four peek nuts in a backward sequence of 4, 3, 2, 1.
2. Ensure that the four rotating wires are in an "up" (unlocked) position.
3. Gently lift the module up to remove it from the socket.
4. Flip the PHM with the gold contacts facing up. Unlock the lever and gently remove the CPU.

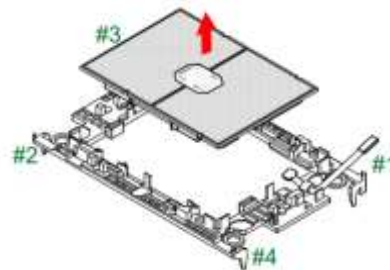

## Processor (LGA-1200)

Type and number of fastenings: Four (4) Phillips screws.

Tools required: Screwdriver with PH2 bit.

**Procedure:** Remove the screws in the sequence of 4, 3, 2, then 1, as marked in the illustration below. After removing the screws, lift the processor heatsink module off the processor socket. Press the load lever to release the load plate from its locked position. Gently lift the load lever to open the load plate and carefully remove the processor from its socket.

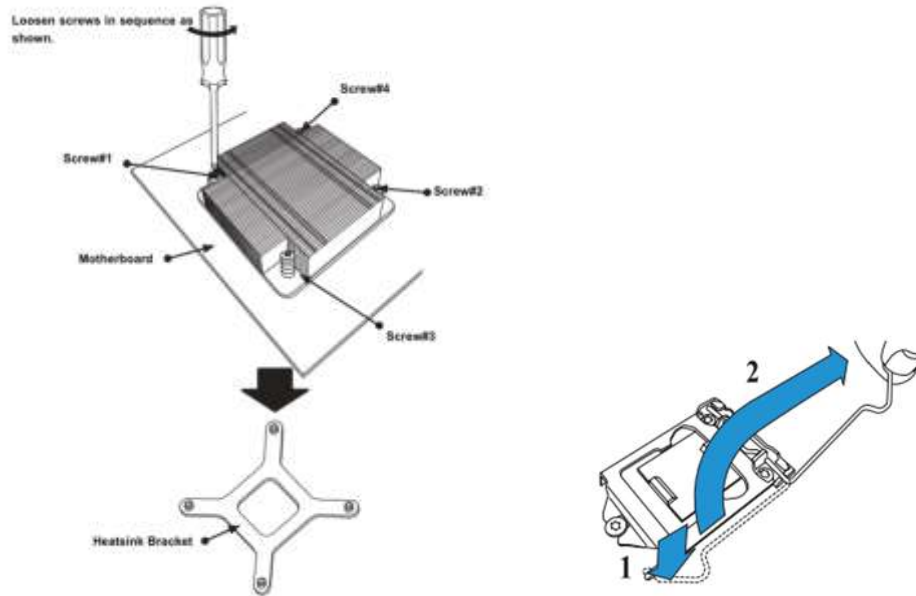

#### 4. Motherboard

**Type and number of fastenings:** Phillips screws (number may vary).

**Tools required:** Screwdriver with PH2 bit.

**Procedure:** Remove all Phillips screws. Lift the motherboard from its base.

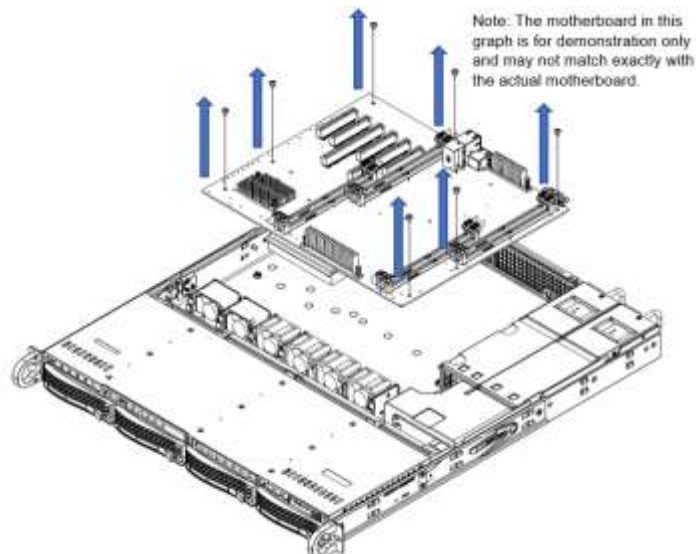

---

## 5. Expansion Card

Type and number of fastenings: One (1) guide pin.

Tools required: None.

Procedure: Using both hands, carefully lift up the expansion slot structure and remove it from the motherboard. Open the tool-less latch on the side of the expansion slot structure to remove the expansion card.

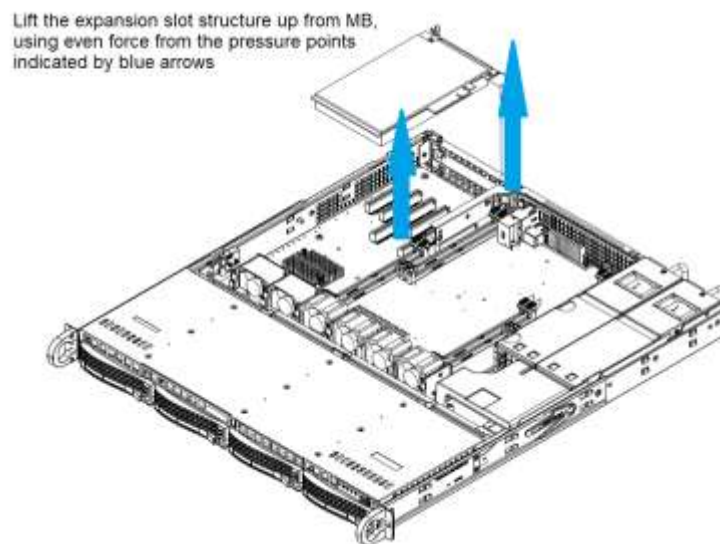

---

## 6. Power Supply Module

Type and number of fastenings: One (1) latch per module (for redundant power supplies), or four (4) Phillips screws (for single power supply).

Tools required: None (redundant power supplies), or screwdriver with PH2 bit (single power supply).

Procedure:

*(For model with redundant power supplies)* Unplug the power cord from the power supply. Push the release tab on the back of the power supply module to the side and pull the module straight out.

*(For model with single power supply)* Remove the two Phillips screws at the bottom of the chassis and two more at the rear end of the chassis. Pull the module straight out.

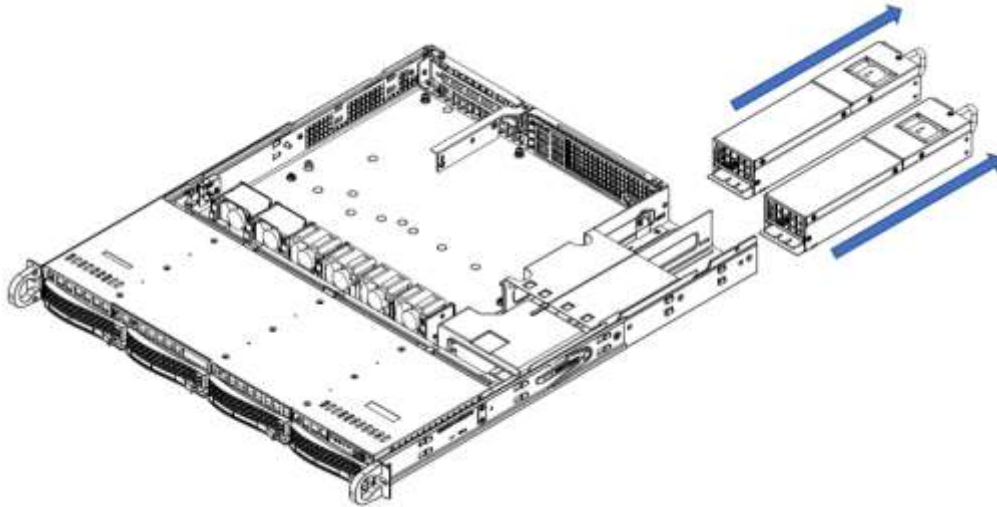

## 7. Chassis Cover

*Type and number of fastenings:* Up to two (2) latches.

*Tools required:* None.

*Procedure:*

*(For 815/813M chassis)* Push down on the two buttons simultaneously while pushing the top cover off toward the rear end of the system.

*(For 116 chassis)* Loosen the knob at the rear of the system. Push down on the chassis cover and off toward the rear end of the system.

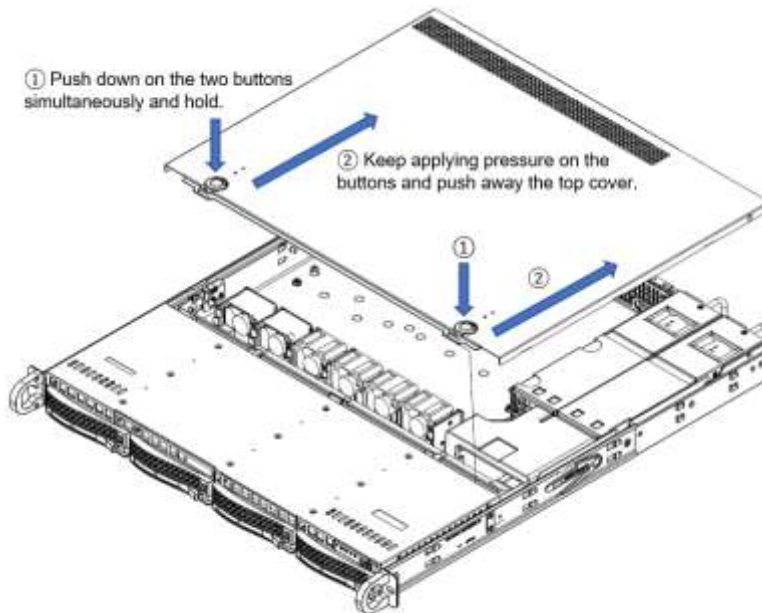

---

## 8. Batteries

*Type and number of fastenings:* One (1) latch.

*Tools required:* None.

*Procedure:* Push aside the small clamp that covers the edge of the battery. When the battery is released, lift it out of the holder.

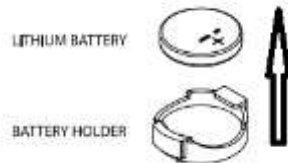

---

## 9. Riser Card

*Type and number of fastenings:* Phillips screws (number may vary).

*Tools required:* Screwdriver with PH2 bit.

*Procedure:* Remove the expansion slot structure from the motherboard. Remove the screws on the side of the expansion slot structure to free the butterfly riser card.

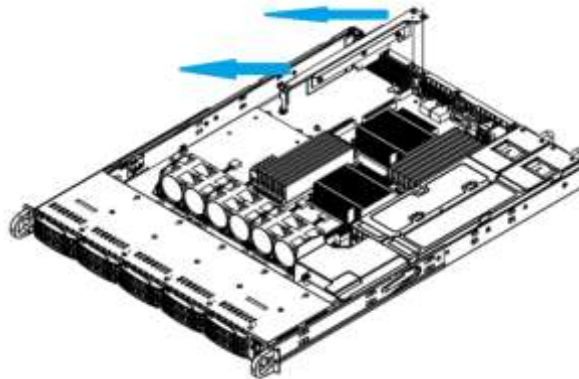

---

## 10. Fans

*Type and number of fastenings:* One (1) fan header per fan.

*Tools required:* None.

**Procedure:** Disconnect the fan wiring from the fan header on the motherboard. Then remove the fan from the fan tray.

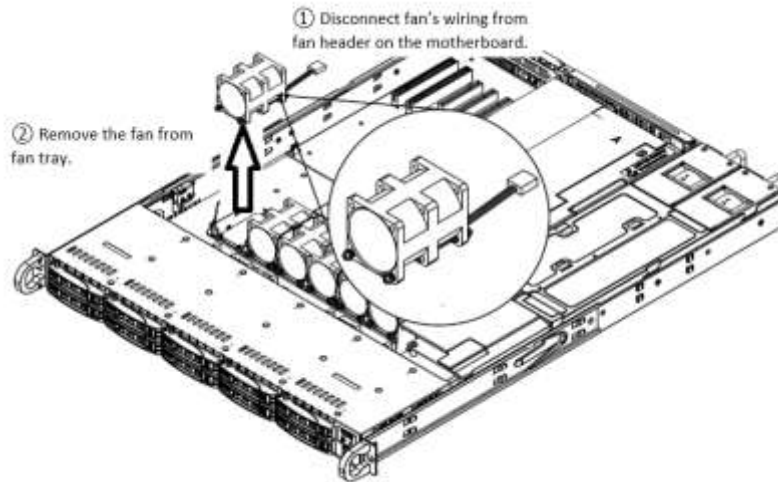

---

## 11. Power Distribution Board

**Type and number of fastenings:** Four (4) Phillips screws.

**Tools required:** Screwdriver with PH2 bit.

**Procedure:** Remove the four Phillips screws. Lift the power distribution board from its base.

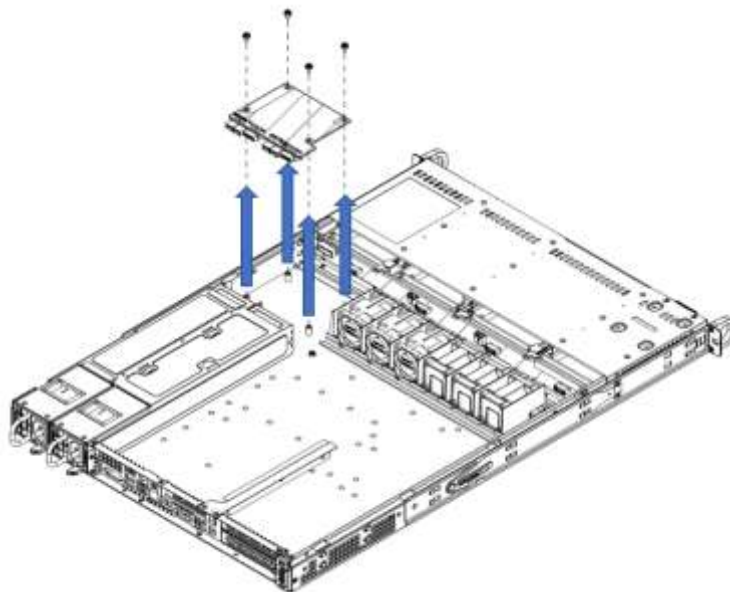

---

## 12. Backplane

Type and number of fastenings: Phillips screws (number may vary).

Tools required: Screwdriver with PH2 bit.

Procedure: Remove all Phillips screws. Then carefully slide the backplane up and away from its base.

