

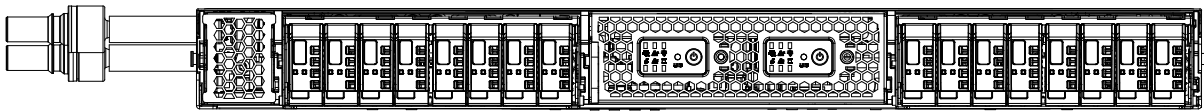

# SuperServer<sup>®</sup> ARS-111GL-DNHR-LCC



USER'S MANUAL

Revision 1.0

The information in this User's Manual has been carefully reviewed and is believed to be accurate. The vendor assumes no responsibility for any inaccuracies that may be contained in this document, and makes no commitment to update or to keep current the information in this manual, or to notify any person or organization of the updates. Please Note: For the most up-to-date version of this manual, please see our website at [www.supermicro.com](http://www.supermicro.com).

Super Micro Computer, Inc. ("Supermicro") reserves the right to make changes to the product described in this manual at any time and without notice. This product, including software and documentation, is the property of Supermicro and/or its licensors, and is supplied only under a license. Any use or reproduction of this product is not allowed, except as expressly permitted by the terms of said license.

IN NO EVENT WILL Super Micro Computer, Inc. BE LIABLE FOR DIRECT, INDIRECT, SPECIAL, INCIDENTAL, SPECULATIVE OR CONSEQUENTIAL DAMAGES ARISING FROM THE USE OR INABILITY TO USE THIS PRODUCT OR DOCUMENTATION, EVEN IF ADVISED OF THE POSSIBILITY OF SUCH DAMAGES. IN PARTICULAR, SUPER MICRO COMPUTER, INC. SHALL NOT HAVE LIABILITY FOR ANY HARDWARE, SOFTWARE, OR DATA STORED OR USED WITH THE PRODUCT, INCLUDING THE COSTS OF REPAIRING, REPLACING, INTEGRATING, INSTALLING OR RECOVERING SUCH HARDWARE, SOFTWARE, OR DATA.

Any disputes arising between manufacturer and customer shall be governed by the laws of Santa Clara County in the State of California, USA. The State of California, County of Santa Clara shall be the exclusive venue for the resolution of any such disputes. Supermicro's total liability for all claims will not exceed the price paid for the hardware product.

FCC Statement: This equipment has been tested and found to comply with the limits for a Class A or Class B digital device pursuant to Part 15 of the FCC Rules. These limits are designed to provide reasonable protection against harmful interference when the equipment is operated in industrial environment for Class A device or in residential environment for Class B device. This equipment generates, uses, and can radiate radio frequency energy and, if not installed and used in accordance with the manufacturer's instruction manual, may cause harmful interference with radio communications. Operation of this equipment in a residential area is likely to cause harmful interference, in which case you will be required to correct the interference at your own expense.

California Best Management Practices Regulations for Perchlorate Materials: This Perchlorate warning applies only to products containing CR (Manganese Dioxide) Lithium coin cells. "Perchlorate Material-special handling may apply. See [www.dtsc.ca.gov/hazardouswaste/perchlorate](http://www.dtsc.ca.gov/hazardouswaste/perchlorate)".



WARNING: This product can expose you to chemicals including lead, known to the State of California to cause cancer and birth defects or other reproductive harm. For more information, go to [www.P65Warnings.ca.gov](http://www.P65Warnings.ca.gov).

The products sold by Supermicro are not intended for and will not be used in life support systems, medical equipment, nuclear facilities or systems, aircraft, aircraft devices, aircraft/emergency communication devices or other critical systems whose failure to perform be reasonably expected to result in significant injury or loss of life or catastrophic property damage. Accordingly, Supermicro disclaims any and all liability, and should buyer use or sell such products for use in such ultra-hazardous applications, it does so entirely at its own risk. Furthermore, buyer agrees to fully indemnify, defend and hold Supermicro harmless for and against any and all claims, demands, actions, litigation, and proceedings of any kind arising out of or related to such ultra-hazardous use or sale.

Manual Revision 1.0

Release Date: May 22, 2024

Unless you request and receive written permission from Super Micro Computer, Inc., you may not copy any part of this document. Information in this document is subject to change without notice. Other products and companies referred to herein are trademarks or registered trademarks of their respective companies or mark holders.

Copyright © 2024 by Super Micro Computer, Inc.  
All rights reserved.

**Printed in the United States of America**

# Preface

## About this Manual

This manual is written for professional system integrators and PC technicians. It provides information for the installation and use of the server. Installation and maintenance should be performed by certified service technicians only.

Please refer to the ARS-111GL-DNHR-LCC server specifications page on our website for updates on supported memory, processors, and operating systems (<http://www.supermicro.com>).

## Notes

For your system to work properly, please follow the links below to download all necessary drivers/utilities and the user's manual for your server.

- Supermicro product manuals: <http://www.supermicro.com/support/manuals/>
- Product drivers and utilities: <https://www.supermicro.com/wdl>
- Product safety info: [http://www.supermicro.com/about/policies/safety\\_information.cfm](http://www.supermicro.com/about/policies/safety_information.cfm)

If you have any questions, please contact our support team at:  
[support@supermicro.com](mailto:support@supermicro.com)

This manual may be periodically updated without notice. Please check the Supermicro website for possible updates to the manual revision level.

## Secure Data Deletion

A secure data deletion tool designed to fully erase all data from storage devices can be found on our website: [https://www.supermicro.com/about/policies/disclaimer.cfm?url=/wdl/utility/Log9\\_Secure\\_Data\\_Deletion\\_Utility/](https://www.supermicro.com/about/policies/disclaimer.cfm?url=/wdl/utility/Log9_Secure_Data_Deletion_Utility/)

## Warnings

Special attention should be given to the following symbols used in this manual.



**Warning!** Indicates important information given to prevent equipment/property damage or personal injury.



**Warning!** Indicates high voltage may be encountered when performing a procedure.

# Contents

Contacting Supermicro.....	7
<b>Chapter 1 Introduction</b>	
1.1 Overview.....	8
1.2 System Features .....	9
Front View .....	9
Drive Carrier Indicators.....	10
Power Supply Indicators.....	10
Control Panel.....	11
Rear View.....	13
Top View.....	14
Grace Hopper™ Superchip.....	15
1.3 Motherboard Layout .....	16
Quick Reference Table.....	17
Motherboard Block Diagram .....	19
<b>Chapter 2 Chassis Installation</b>	
2.1 Overview.....	20
2.2 Preparing for Setup.....	20
Choosing a Setup Location.....	20
Rack Precautions .....	21
System/Chassis Precautions.....	21
Rack Mounting Considerations .....	22
Ambient Operating Temperature.....	22
Airflow .....	22
Mechanical Loading.....	22
Circuit Overloading .....	22
Reliable Ground.....	22

---

---

2.3	Installing the System into a Rack.....	23
	Separating the Sections of the Rack Rails.....	23
	Releasing the Inner Rail.....	24
	Installing the Inner Rails on the Chassis .....	25
	Installing the Outer Rails on the Rack.....	26
	Installing into the Rack.....	27
	Removing the Chassis from the Rack .....	28
	Removing the Outer Rails from the Rack.....	29
<b><i>Chapter 3 Maintenance and Component Installation</i></b>		
3.1	Removing Power .....	30
3.2	Accessing the System.....	31
	Removing the Top Cover .....	31
3.3	Processor and Cold Plate Installation.....	32
3.4	Memory Support.....	36
3.5	Motherboard Battery.....	37
3.6	Chassis Components .....	38
	SSD Storage Modules.....	38
	Carrier .....	38
	Removing the I/O and PCIe Modules.....	39
	System Fans .....	40
	Power Supply .....	41
3.7	M.2 Solid State Drive Installation.....	42
<b><i>Chapter 4 Motherboard Connections</i></b>		
4.1	Power Connections .....	43
4.2	Headers and Connectors .....	46
4.3	LED Indicators.....	51
<b><i>Chapter 5 Software</i></b>		
5.1	Ubuntu® Server 22.04 ISO Installation.....	53
5.2	Red Hat Enterprise Linux (RHEL) 9.3 ISO Installation.....	72
5.3	SUSE Linux Enterprise Server 15 Installation .....	96
5.4	SuperDoctor® 5.....	119
5.5	IPMI .....	119

---

---

## ***Chapter 6 Troubleshooting and Support***

6.1 Information Resources .....	120
Website .....	120
Direct Links for the ARS-111GL-DNHR-LCC System.....	120
Direct Links for General Support and Information .....	120
6.2 Baseboard Management Controller (BMC).....	121
6.3 Troubleshooting Procedures .....	122
Before Power On .....	122
No Power .....	122
No Video .....	122
System Boot Failure .....	122
Losing the System's Setup Configuration.....	123
When the System Becomes Unstable .....	123
6.4 Where to Get Replacement Components .....	124
6.5 Technical Support Procedures .....	124
Returning Merchandise for Service.....	125
6.6 Feedback.....	125
6.7 Contacting Supermicro.....	126

## ***Appendix A Standardized Warning Statements for AC Systems***

## ***Appendix B System Specifications***

## Contacting Supermicro

### Headquarters

Address: Super Micro Computer, Inc.  
980 Rock Ave.  
San Jose, CA 95131 U.S.A.

Tel: +1 (408) 503-8000

Fax: +1 (408) 503-8008

Email: marketing@supermicro.com (General Information)  
Sales-USA@supermicro.com (Sales Inquiries)  
Government\_Sales-USA@supermicro.com (Gov. Sales Inquiries)  
support@supermicro.com (Technical Support)  
RMA@supermicro.com (RMA Support)  
Webmaster@supermicro.com (Webmaster)

Website: [www.supermicro.com](http://www.supermicro.com)

### Europe

Address: Super Micro Computer B.V.  
Het Sterrenbeeld 28, 5215 ML  
's-Hertogenbosch, The Netherlands

Tel: +31 (0) 73-6400390

Fax: +31 (0) 73-6416525

Email: Sales\_Europe@supermicro.com (Sales Inquiries)  
Support\_Europe@supermicro.com (Technical Support)  
RMA\_Europe@supermicro.com (RMA Support)

Website: [www.supermicro.nl](http://www.supermicro.nl)

### Asia-Pacific

Address: Super Micro Computer, Inc.  
3F, No. 150, Jian 1st Rd.  
Zhonghe Dist., New Taipei City 235  
Taiwan (R.O.C)

Tel: +886-(2) 8226-3990

Fax: +886-(2) 8226-3992

Email: Sales-Asia@supermicro.com.tw (Sales Inquiries)  
Support@supermicro.com.tw (Technical Support)  
RMA@supermicro.com.tw (RMA Support)

Website: [www.supermicro.com.tw](http://www.supermicro.com.tw)

# Chapter 1

## Introduction

### 1.1 Overview

This chapter provides an outline of the functions and features of the SuperServer ARS-111GL-DNHR-LCC. This is a high-density system with an integrated Nvidia® H100 GPU, ideal for AI and HPC applications. The following provides an overview of the specifications and capabilities of the system.

System Overview	
<b>Motherboard</b>	G1SMH-G
<b>Chassis</b>	CSE-MG102TS-R000NDFP-2N
<b>Processor (per node)</b>	Nvidia GH200 Grace CPU Superchip via two Mirror Mezz connectors
<b>Memory (per node)</b>	Embedded 480 GB ECC LPDDR5X with up to 500 GB/s throughput 96 GB of HBM3 memory with up to 4 TB/s of memory bandwidth
<b>GPU (per node)</b>	One NVIDIA® H100 Tensor Core GPU on GH200 Grace Hopper™ Superchip (Liquid-cooled), highest GPU communication using NVIDIA NVLINK™
<b>Storage (per node)</b>	Two front E1.S NVMe drive bays Two M.2 NVMe slots (M-key)
<b>Expansion Slots (per node)</b>	Two PCIe 5.0 x16 slots (one FHFL, one low profile)
<b>I/O Ports (per node)</b>	One RJ45 1 GbE Dedicated IPMI LAN port One rear USB port One mini-DP port
<b>System Cooling (per system)</b>	Seven heavy-duty 4-cm fans with optimal fan speed control
<b>Power</b>	Two redundant 2700 W Titanium Level power supplies
<b>Form Factor</b>	1U rackmount: 17.33" x 1.75" x 37" (440 x 44 x 940 mm) (W x H x D)

**Notes:** A Quick Reference Guide can be found on the product page of the Supermicro website. The following safety models associated with the ARS-111GL-DNHR-LCC have been certified as compliant with UL and CSA: MG102LC-R27G1 and MG102-GH200.

## 1.2 System Features

The following views of the system display the main features. Refer to [Appendix B](#) for additional specifications.

### Front View

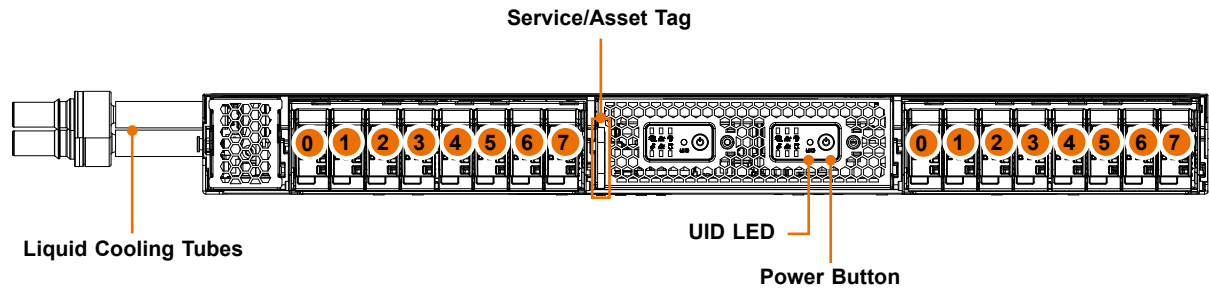

Figure 1-1. Front View

System Features: Front	
Feature	Description
Liquid Cooling Tubes	Circulates liquid coolant through the chassis and out to an external Coolant Distribution Unit (CDU) and back.
UID LED	The unit identification (UID) button turns on or off the blue light function of the Information LED and a blue LED on the rear of the chassis. This button can also be used to reset the BMC.
Power Button	The main power switch applies or removes primary power from the power supply to the server but maintains standby power.
Service Tag	Service Tag with <a href="#">BMC Password Reset</a>

Logical Storage Drive Numbers	
Number	Description
0 to 7	Eight E1.S drive bays (Each bay supports two E1.S slots 0 and 2 only, other six slots cannot be used.)

### ***Drive Carrier Indicators***

Each E1.S NVMe SSD drive has two LED indicators: an activity indicator and a status indicator.

<b>Back Panel I/O Ports</b>			
<b>LED</b>	<b>Color</b>	<b>Blinking Pattern</b>	<b>Behavior for Device</b>
Activity LED	Blue	Solid on	Idle SAS/NVMe drive installed
	Blue	Blinking	I/O activity
	Off		Idle SATA drive installed
Status LED	Red	Solid On	Failure of drive with RSTe support
	Red	Blinking at 1 Hz	Rebuild drive with RSTe support
		Blinking with two blinks and one stop at 1 Hz	Hot spare for drive with RSTe support
	Red	On for five seconds, then off	Power on for drive with RSTe support
	Red	Blinking at 4 Hz	Identify drive with RSTe support
	Green	Solid on	Safe to remove NVMe drive
	Amber	Blinking at 1 Hz	Do not remove NVMe drive

### ***Power Supply Indicators***

<b>Power Supply Indicators</b>	
<b>LED Color and State</b>	<b>Power Supply Condition</b>
Solid Green	Indicates that the power supply is on
Blinking Green	Indicates that the power supply is plugged in and turned off by the system.
Blinking Amber	Indicates that the power supply has a warning condition and continues to operate.
Solid Amber	Indicates that the power supply is plugged in, and is in an abnormal state. The system might need service. Please contact Supermicro technical support.
Off	No AC power to modules

## Control Panel

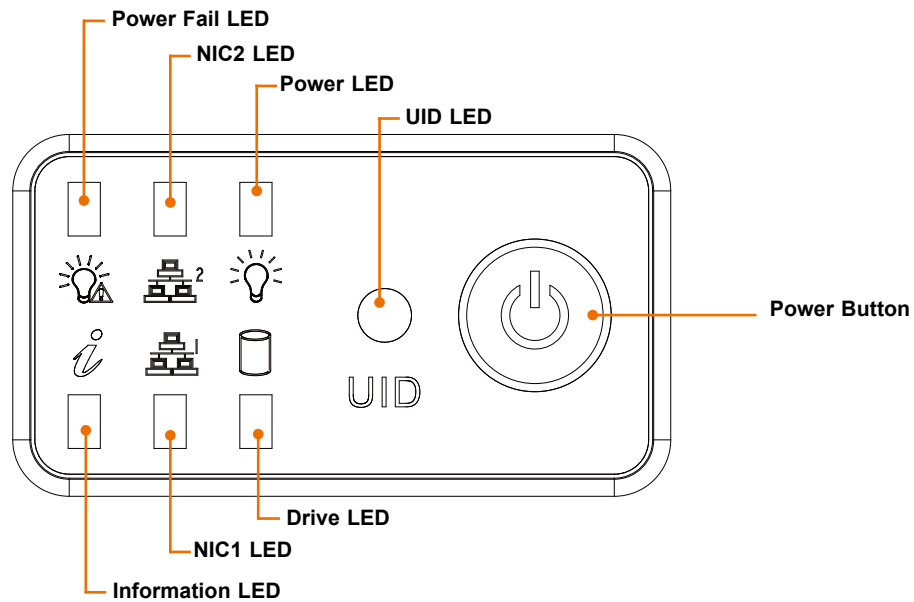

**Figure 1-2. Control Panel**

Control Panel Features	
Features	Description
Power Button	The main power switch applies or removes primary power from the power supply to the server but maintains standby power.
UID Button/LED	The unit identification (UID) button turns on or off the blue light function of the Information LED and a blue LED on the rear of the chassis.
Power LED	Indicates power is being supplied to the system power supply. This LED should normally be illuminated when the system is operating.
Drive LED	Indicates activity on the storage drives when flashing.
NIC1/2 LEDs	Indicates network activity on the LAN1/2 port when flashing
Power Fail LED	Indicates a power supply module has failed.
Information LED	Alerts operator to several states (noted in the table below).

Information LED	
Color, Status	Description
Red, solid	An overheating condition has occurred
Red, blinking at 1 Hz	Fan failure, check for an inoperative fan
Red, blinking at 0.25 Hz	Power failure, check for a non-operational power supply
Red, blinking at 10 Hz	CPLD recovery mode error
Blue, solid	Unit ID has been activated by switch
Blue, blinking at 1 Hz	Unit ID has been activated using the BMC
Blue, blinking at 2 Hz, and BMC Heartbeat LED on the motherboard is green	BMC is resetting
Blue, blinking at 4 Hz	BMC is setting factory defaults
Blue, blinking at 10 Hz	BIOS/BMC is recovering or updating
Red, blinking at 10 Hz and the rear UID LED is blue, blinking at 10 Hz	CPLD recovery or update is in progress

## Rear View

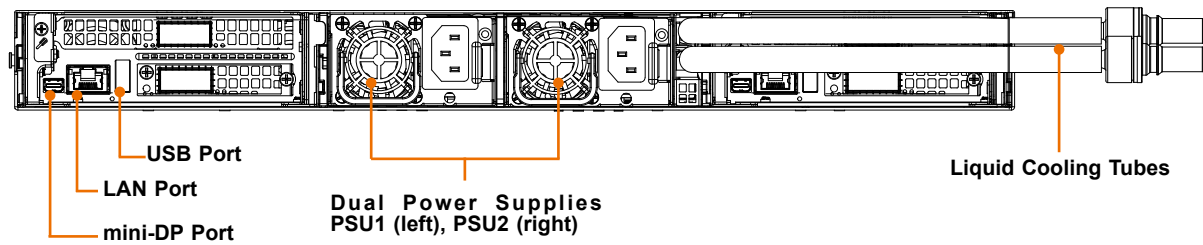

Figure 1-3. Rear View

Input/Output Panel	
Feature	Description
Liquid Cooling Tubes	Circulates liquid coolant through the chassis and out to an external Coolant Distribution Unit (CDU) and back.
Power Supplies	PWS-2K71A-1R, two 2700 W redundant modules, 80Plus Titanium level
Mini DisplayPort (per node)	One Mini DisplayPort for digital audio/visual interface
LAN Port (per node)	One RJ45 1 GbE dedicated IPMI LAN port
USB Port (per node)	One USB port

## Top View

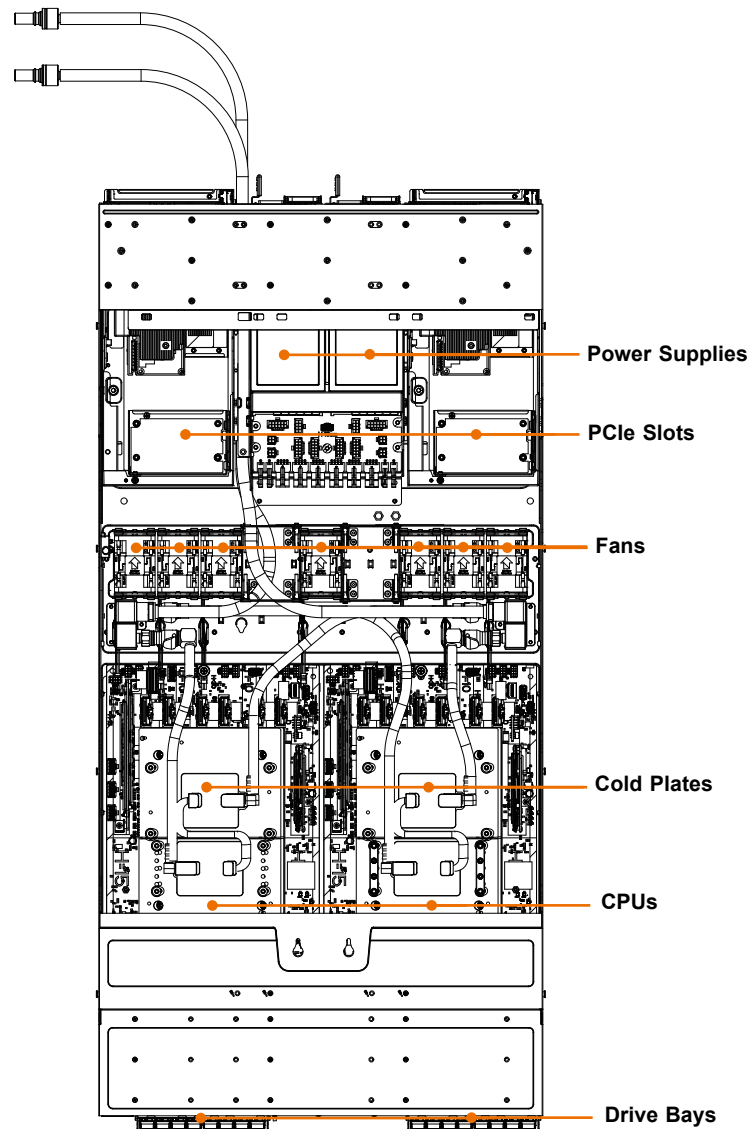

Figure 1-5. Motherboard Tray: Top View

System Features: Top	
Feature	Description
Power Supplies	Two 2700 W redundant Titanium Level power supplies
PCIe Slots	Two PCIe 5.0 x16 slots per node supporting NVIDIA BlueField®-3 or ConnectX®-7
Fans	Seven removable heavy-duty 4-cm fans
Cold Plates (per node)	One Direct to Chip (D2C) Cold Plate (optional)
Drive Bays (per node)	Eight E1.S drive bays (Each bay supports two E1.S slots 0 and 2 only, other six slots cannot be used.)
CPUs (per node)	One NVIDIA GH200 Grace Hopper™ Superchip

## Grace Hopper™ Superchip

The ARS-111GL-DNHR-LCC features two Grace Hopper Superchips with attached LPDDR5x memory on a mezzanine module, and a 900 GB/s NVLink, chip-to-chip on the module. There is no off-the-module NVLink support

Grace Hopper™ Superchip Overview	
<b>Core Count</b>	72 Arm Neoverse V2 Cores with 4 x128b SVE2
<b>L1 Cache</b>	64 KB i-cache + 64 KB d-cache
<b>L2 Cache</b>	1 MB per core
<b>L3 Cache</b>	234 MB
<b>LPDDR5x Size</b>	480 GB on-module memory options
<b>Memory Bandwidth</b>	Up to 1 TB/s
<b>NVIDIA MLink-C2C Bandwidth</b>	900 GB/s
<b>PCIe Links</b>	Up to four PCIe Gen5 x16 option to bifurcate
<b>Module Thermal Design Power (TDP)</b>	1000 W TDP with memory
<b>Form Factor</b>	Superchip module
<b>Thermal Solution</b>	Air cooled or liquid cooled



Figure 1-6. Grace Hopper™ Superchip



## Quick Reference Table

LED	Description	Status
HB_LED1	CPLD Initialization	Green Blinking: CPLD initialized
LED1	EROT Detected	Before pressing PWRBTN1: Yellow Solid After pressing PWRBTN1: Yellow Off
LED2	EROT Not Detected	Red Solid: EROT is not detected
LED3	Normal Power Detected	Before pressing PWRBTN1: Green Blinking After pressing PWRBTN1: Green Solid
LED4	Standby Power Detected	Before pressing PWRBTN1: Orange Solid After pressing PWRBTN1: Orange Off
PWR_LED1	Motherboard Power	Solid green after pressing PWRBTN1
UID_LED1	UID Activity	Blinks blue after pressing UIDBTN1

Connector	Description
BT1	Onboard Battery
CPU1, GPU1	CPU and GPU Connector
FAN1-FAN9	System Cooling Fans
J1, J2	GPU NVLINK Network Signal Connector
J6	BMC SMBUS Debug Header
J7	CPU JTAG TRST and NVSEL Debug Header
J9	BMC Debug Console Header
J10	CPU Pulse Per Second Header
J11	Global Write Protect Header
J12	CPU Debug Console Header
J24	BMC SMBUS Debug Header
J26	M.2 Riser Card Sideband and Power Connector
J44	CPU JTAG Debug Header
J46	FPGA JTAG Debug Header
J49	BMC SMBUS Debug Header
J48	Debug Dongle Only
JBMC1	BMC DC-SCM Module Card Connector
JDP1	Debug Display Connector
JFP1	Front Control Panel Header
JLFP1	Left Front Control Panel Header
JL1, JL2	Chassis Intrusion Header

### Notes:

- See [Chapter 4](#) for detailed information on jumpers, LEDs and connections.
- Use only the correct type of onboard CMOS battery as specified by the manufacturer. To avoid possible explosion, do not install the onboard battery upside down.

Connector	Description
JNCSIBF3	NVIDIA BlueField-3 DPU Card NCSI Sideband Connector
JPFR1	PFR Debug
JPFR2	PFR Operation
JPFR3	PFR Force Recovery
JPWR1	48 V 6-Pin GPU Power Supply Connector
JPWR2-JPWR4	12 V 8-Pin Main Power Supply Connector
JPWR6	12 V 8-Pin IO Board Power Supply Connector
JPWR7	12 V 2-Pin Main Power Supply Connector
JPWR8	12 V 2-Pin IO Board Power Supply Connector
JSB1	74-Pin IO Sideband Signals Connector
JSB2	20-Pin Main Sideband Signals Connector
JSB3	Front Control Board Debug Header
JTAG1	CPLD JTAG Debug Header
JTPM1	TPM (Trusted Platform Module)/Port 80
PWRBTN1	Power Button
UIDBTN1	UID Button

**Note:** Jumpers, connectors, switches, and LED indicators that are not described in the preceding tables are for manufacturing testing purposes only, and are not covered in this manual.

## Motherboard Block Diagram

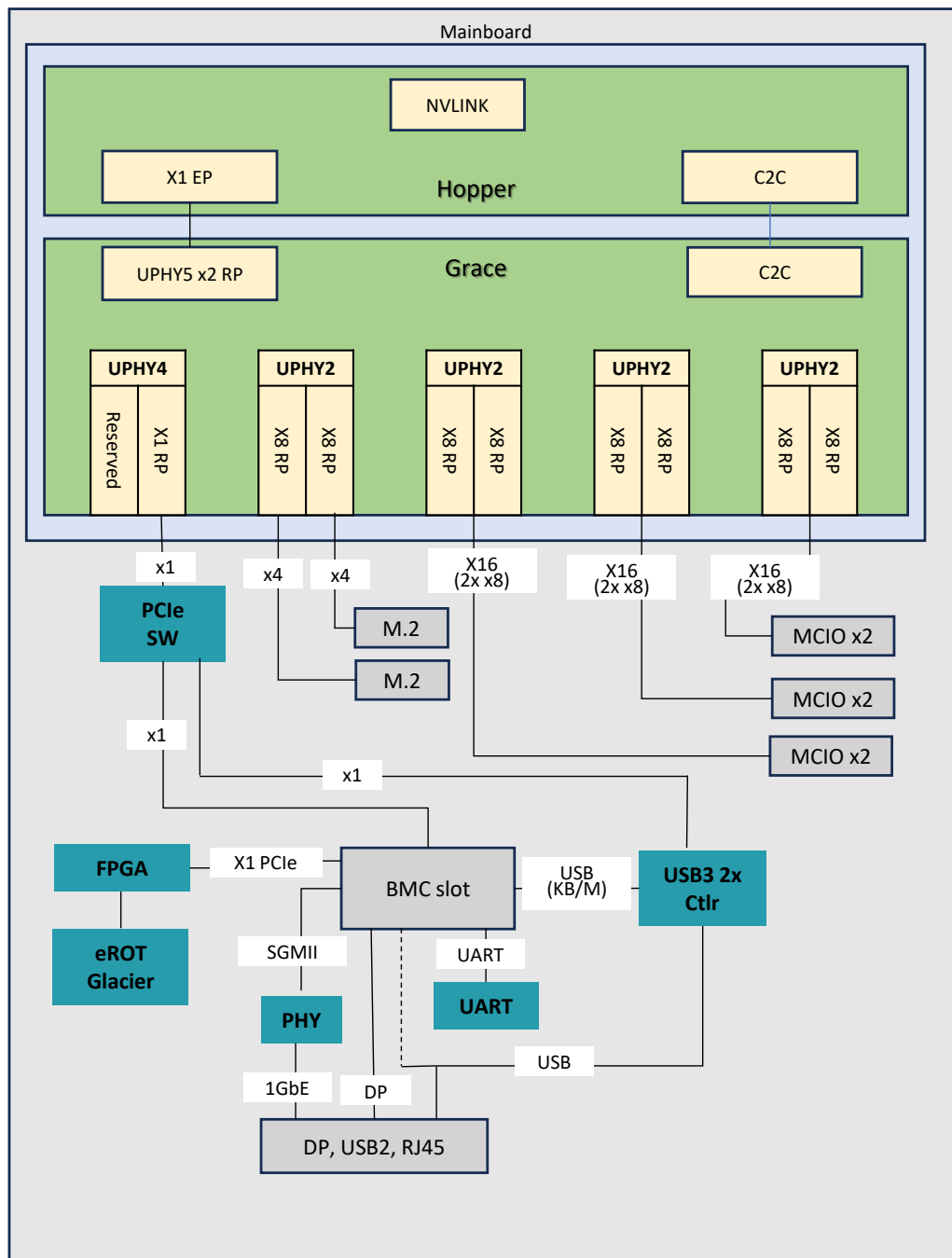

**Figure 1-7. Motherboard Block Diagram**

**Note:** This is a general block diagram and may not exactly represent the features on your motherboard. See the previous pages for the actual specifications of your motherboard.

## Chapter 2

# Chassis Installation

## 2.1 Overview

This chapter provides advice and instructions for mounting your chassis in a server rack. If your chassis is not already fully integrated with processors, system memory etc., refer to [Chapter 3](#) for details on installing those specific components.

**Caution:** Electrostatic Discharge (ESD) can damage electronic components. To prevent such damage to PCBs (printed circuit boards), it is important to use a grounded wrist strap, handle all PCBs by their edges and keep them in anti-static bags when not in use.

## 2.2 Preparing for Setup

The box in which the chassis was shipped should include the rackmount hardware needed to install it into the rack. Please read this section in its entirety before you begin the installation.

### Choosing a Setup Location

- The chassis should be situated in a clean, dust-free area that is well ventilated. Avoid areas where heat, electrical noise and electromagnetic fields are generated.
- Leave enough clearance in front of the rack so that you can open the front door completely (~25 inches) and approximately 30 inches of clearance in the back of the rack to allow sufficient space for airflow and access when servicing.
- This product should be installed only in a Restricted Access Location (dedicated equipment rooms, service closets, etc.).
- This product is not suitable for use with visual display workplace devices according to §2 of the German Ordinance for Work with Visual Display Units.

## Rack Precautions

- Ensure that the leveling jacks on the bottom of the rack are extended to the floor so that the full weight of the rack rests on them.
- In single rack installations, stabilizers should be attached to the rack. In multiple rack installations, the racks should be coupled together.
- Always make sure the rack is stable before extending a server or other component from the rack.
- You should extend only one server or component at a time - extending two or more simultaneously may cause the rack to become unstable.

## System/Chassis Precautions

- Review the electrical and general safety precautions in [Appendix A](#).
- Determine the placement of each component in the rack before you install the rails.
- Install the heaviest server components at the bottom of the rack first and then work your way up.
- Use a regulating uninterruptible power supply (UPS) to protect the server from power surges and voltage spikes and to keep your system operating in case of a power failure.
- Allow any drives and power supply modules to cool before touching them.
- When not servicing, always keep the front door of the rack and all covers/panels on the servers closed to maintain proper cooling.

## Rack Mounting Considerations

### *Ambient Operating Temperature*

If installed in a closed or multi-unit rack assembly, the ambient operating temperature of the rack environment may be greater than the room's ambient temperature. Therefore, consideration should be given to installing the equipment in an environment compatible with the manufacturer's maximum rated ambient temperature (TMRA).

### *Airflow*

Equipment should be mounted into a rack so that the amount of airflow required for safe operation is not compromised.

### *Mechanical Loading*

Equipment should be mounted into a rack so that a hazardous condition does not arise due to uneven mechanical loading.

### *Circuit Overloading*

Consideration should be given to the connection of the equipment to the power supply circuitry and the effect that any possible overloading of circuits might have on overcurrent protection and power supply wiring. Appropriate consideration of equipment nameplate ratings should be used when addressing this concern.

### *Reliable Ground*

A reliable ground must be maintained at all times. To ensure this, the rack itself should be grounded. Particular attention should be given to power supply connections other than the direct connections to the branch circuit (i.e. the use of power strips, etc.).



To prevent bodily injury when mounting or servicing this unit in a rack, you must take special precautions to ensure that the system remains stable. The following guidelines are provided to ensure your safety:

- This unit should be mounted at the bottom of the rack if it is the only unit in the rack.
- When mounting this unit in a partially filled rack, load the rack from the bottom to the top with the heaviest component at the bottom of the rack.
- If the rack is provided with stabilizing devices, install the stabilizers before mounting or servicing the unit in the rack.

## 2.3 Installing the System into a Rack

This section provides information on installing the CSE-MG102TS-R000NDFP-2N chassis into a rack unit with the quick-release rails provided. There are a variety of rack units on the market, which may mean the assembly procedure will differ slightly. You should also refer to the installation instructions that came with the rack unit you are using.

**Note:** This rail will fit a rack between 26.5" and 36.4" deep.

### Separating the Sections of the Rack Rails

The chassis package includes two rail assemblies in the rack mounting kit. Each assembly consists of three sections: An inner rail that secures directly to the chassis, an outer rail that secures to the rack, and a middle rail that slides in the outer rail. These assemblies are specifically designed for the left and right side of the chassis.

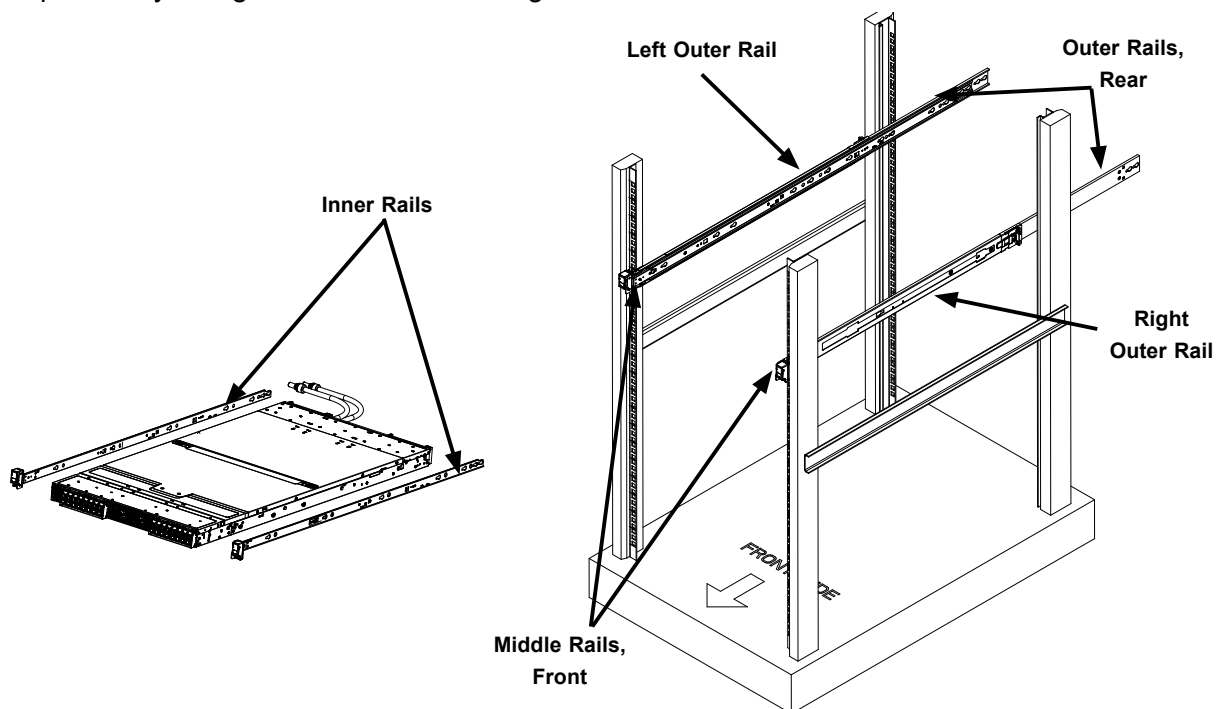

**Figure 2-1. Identifying the Inner Rails, Middle Rails and Outer Rails**

**Note:** Figures are for illustrative purposes only. Your actual chassis may differ. Always install servers into racks from the bottom up.



Slide rail mounted equipment is not to be used as a shelf or a work space.



**Warning:** Do not pick up the server with the front handles. They are designed to pull the system from a rack only.

## Releasing the Inner Rail

It is necessary to release the inner rail from the middle and outer rails before installing the inner rail on the chassis.

### *Releasing the Inner Rail from the Middle and Outer Rails*

1. Lift the front latch on the inner rail and pull the inner rail out of the middle rail, and the middle rail out of the outer rail until the rails are fully extended.
2. Press down the locking lever on the inside of the inner rail to release the inner rail. Continue to pull the inner rail out of the middle rail.

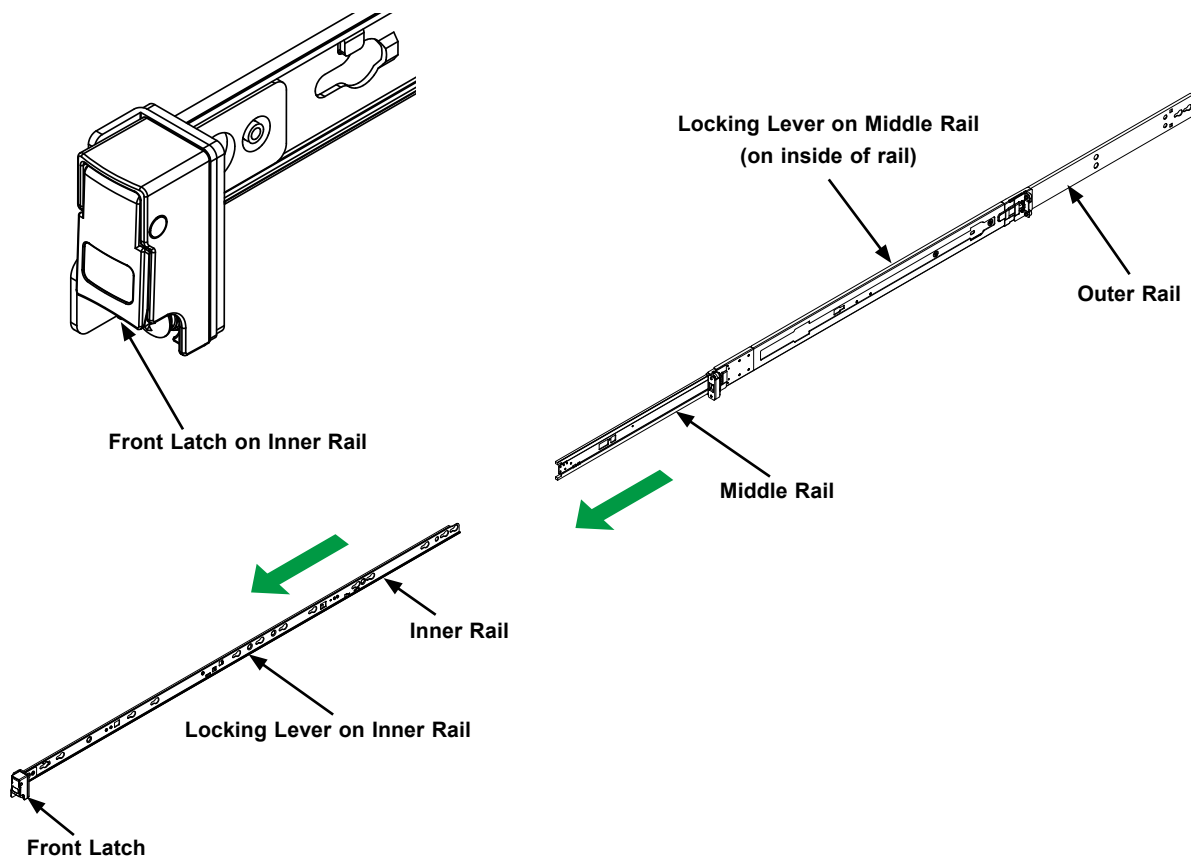

Figure 2-2. Extending the Rails and Releasing the Inner Rail



**Warning:** Stability hazard. The rack stabilizing mechanism must be in place, or the rack must be bolted to the floor before you slide the unit out for servicing. Failure to stabilize the rack can cause the rack to tip over.

## Installing the Inner Rails on the Chassis

### *Installing the Inner Rails*

1. Confirm that the left and right inner rails have been correctly identified.
2. Place the inner rail firmly against the side of the chassis, aligning the pins on the side of the chassis with the slotted thru holes in the inner rail.
3. Slide the inner rail toward the rear of the chassis until the pins are at the end of the narrow slot, which secures the inner rail to the chassis. An optional screw may be added for extra security.
4. Repeat for the other inner rail.

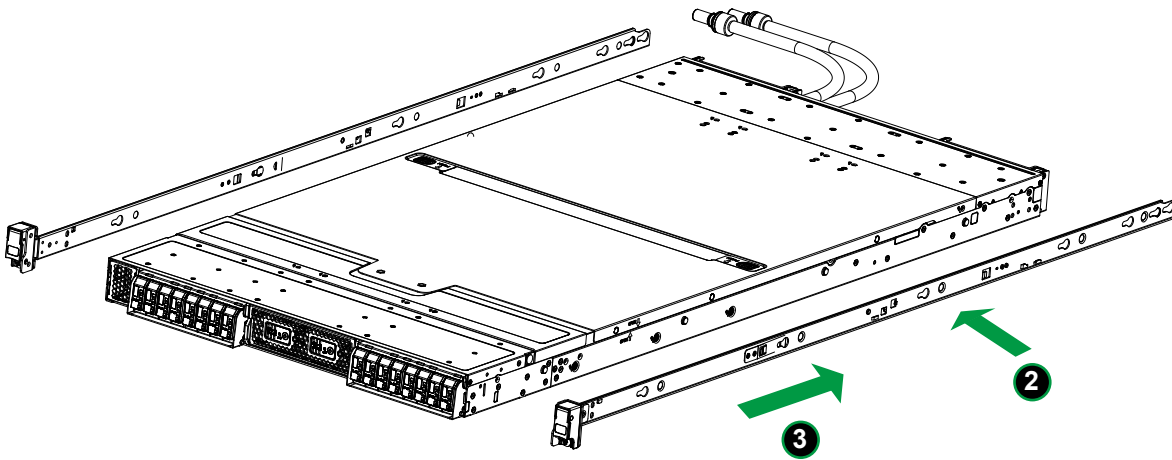
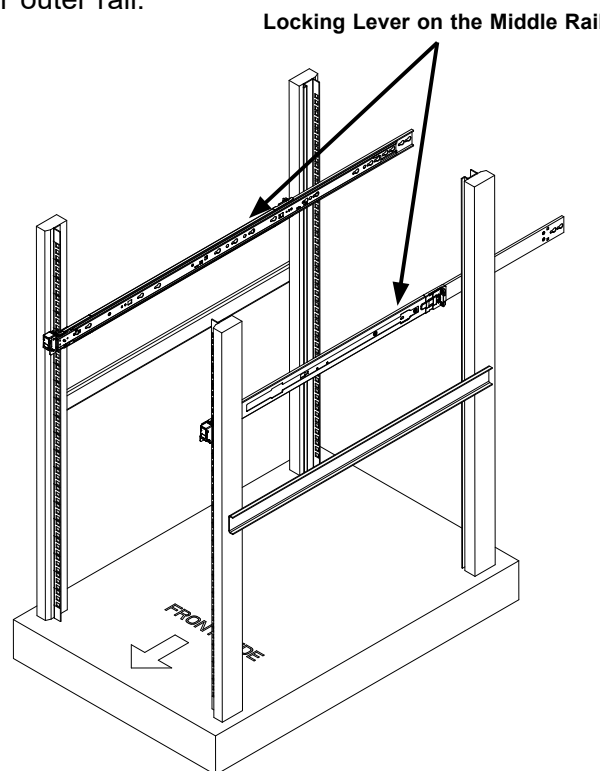

**Figure 2-3. Installing the Inner Rails**

## Installing the Outer Rails on the Rack

### *Installing the Outer Rails*

1. Confirm that the left and right outer rails have been correctly identified.
2. Release the small locking lever on the inside of the middle rail and push the middle rail back into the outer rail.
3. Insert the pins at the front of the outer rail into the square holes on the front of the rack. Push until the latch snaps into place.
4. The outer rail is actually two pieces that slide to lengthen. Pull out the rear of the outer rail, adjusting the length until the square pin assembly passes, then fits against the back of the rear post. Be careful to keep the rail level.
5. Insert the pins at the rear of the outer rail into the square holes on the rear of the rack. Push until the latch snaps into place.
6. Repeat for the other outer rail.



**Figure 2-4. Installing the Outer Rails**

**Note:** Figures are for illustrative purposes only. Your actual chassis may differ. Always install servers into racks from the bottom up.

## Installing into the Rack

After the rails are installed on the chassis and on the rack, the server can be installed in the rack. It is heavy and requires two to three people to lift.

### *Installing the Chassis into a Rack*

1. Pull both middle rails out the front of the outer rail until each clicks to a stop.
2. Align the inner rails on the chassis with the front of the middle rails.
3. Slide the inner rails on the chassis into the middle rails, keeping the pressure even on both sides. When partially in, the locking levers will stop further progress.
4. Press down the locking levers on the inside of the inner rails and push the chassis all the way into the rear of the rack. The front latches will click into place.

The chassis is now mounted in the rack. It can be pulled partially out for service by lifting both front latches.

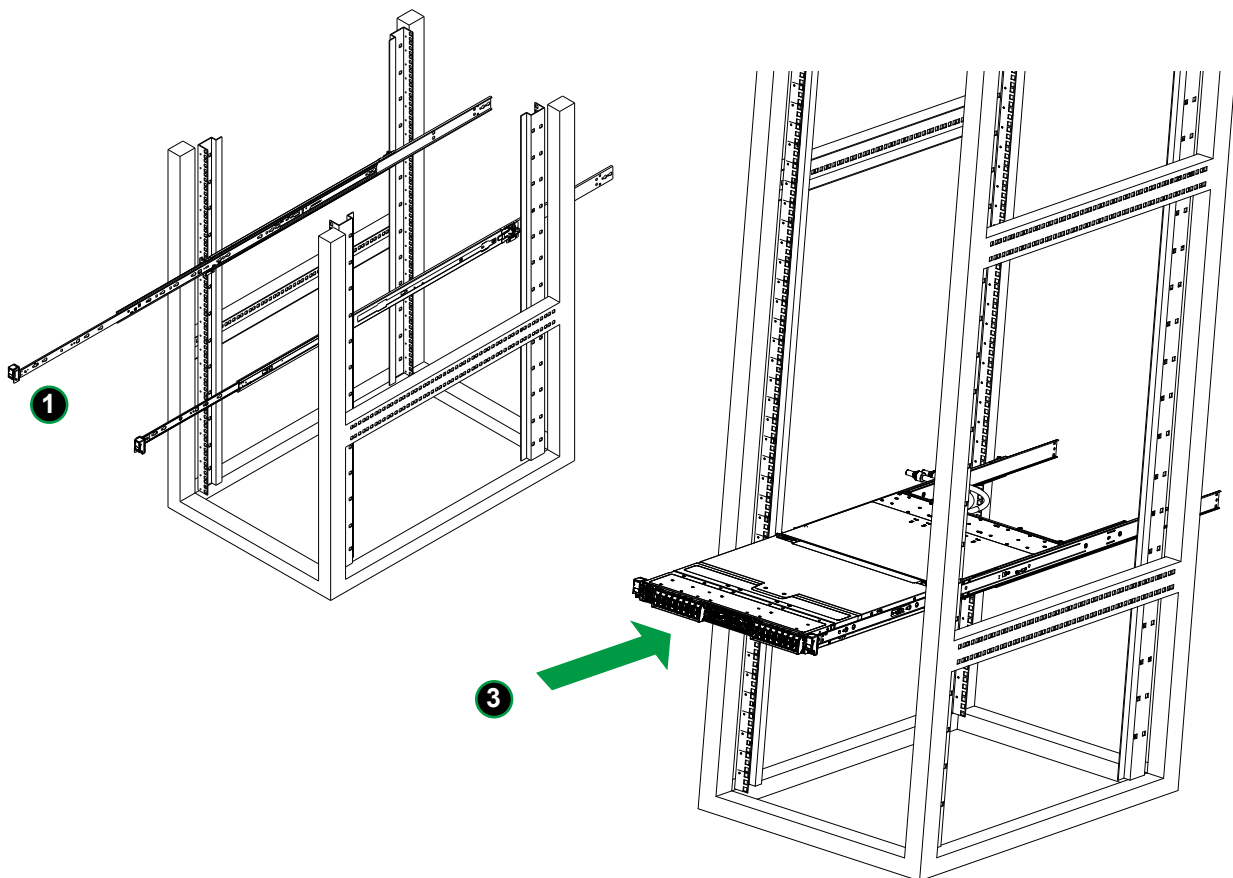

**Figure 2-5. Installing the Chassis into the Rack**

**Note:** Figures are for illustrative purposes only. Your actual chassis may differ. Always install servers into racks from the bottom up.

## Removing the Chassis from the Rack

**Caution:** The chassis is heavy and requires two to three people to lift it out.

### *Removing the Chassis*

1. Lift the right and left front latches on either side of the front panel.
2. Pull the chassis forward until it clicks to a stop.
3. Press down the locking lever on the inside of the inner rail (Figure 2-2) to release the chassis. Continue to pull the chassis out of the middle rails.

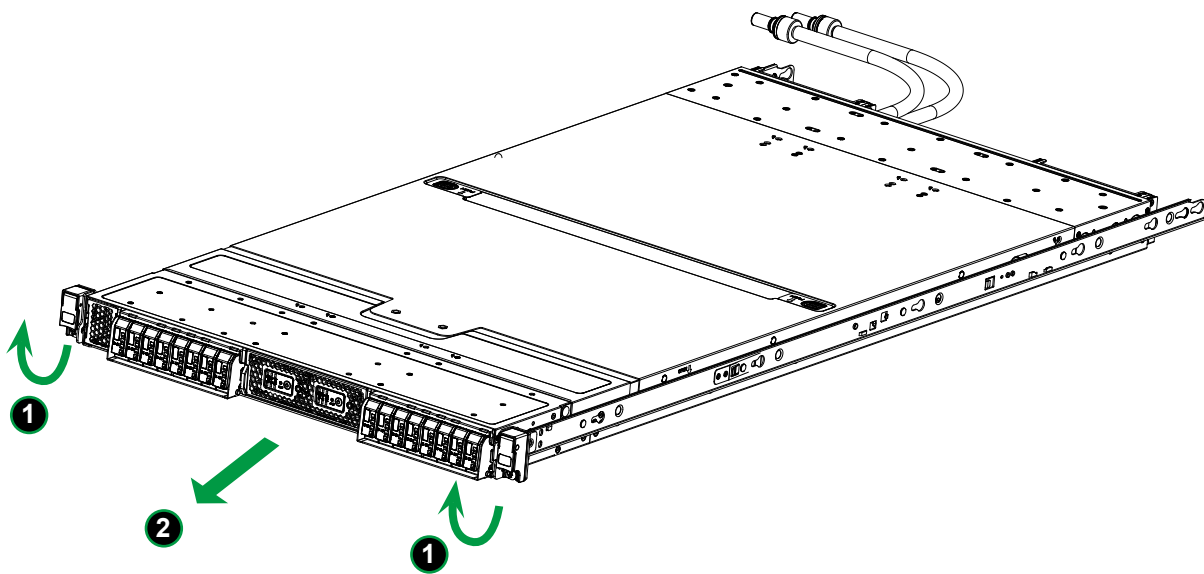

Figure 2-6. Removing the Chassis from the Rack

## Removing the Outer Rails from the Rack

In the uncommon event that it is necessary to remove the outer rails from the rack, follow these instructions. The chassis must be out of the rack.

### *Releasing the Outer Rails*

1. On the front of the outer rail, slide the small plastic safety slider up and hold it while pushing the plastic release button just below it.
2. While holding the release button in, pull the outer rail forward to disengage the pins and the front of the rail from the rack.
3. Support the front of the outer and middle rail assembly while releasing the rear.
4. Remove the outer rail from the rear of the rack in the same way as the front. Slide the safety slider up and push and hold the release button, then pull the rear pins out of the rack and remove the rail.

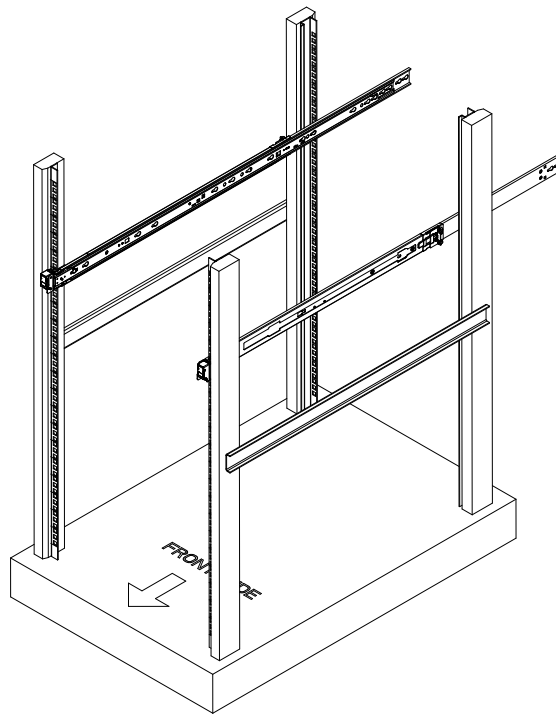

**Figure 2-7. Removing the Outer Rails**

## Chapter 3

# Maintenance and Component Installation

This chapter provides instructions on installing and replacing main system components. To prevent compatibility issues, only use components that match the specifications and/or part numbers given.

Installation or replacement of most components require that power first be removed from the system. Please follow the procedures given in each section.

**Caution:** Electrostatic Discharge (ESD) can damage electronic components. To prevent such damage to printed circuit boards (PCBs), it is important to use a grounded wrist strap, handle all PCBs by their edges and keep them in anti-static bags when not in use.

### 3.1 Removing Power

Use the following procedure to ensure that power has been removed from the system. This step is necessary when removing or installing non hot-swap components or when replacing a non-redundant power supply.

1. Use the operating system to power down the system.
2. After the system has completely shut-down, disconnect the AC power cord(s) from the power strip or outlet. (If your system has more than one power supply, remove the AC power cords from all power supply modules.)
3. Disconnect the power cord(s) from the power supply module(s).

## 3.2 Accessing the System

**Note:** The chassis features a removable top cover for access to the internal components. When performing service on components inside the system, remove the system from the rack and place it on a work bench or desk. Do not service with the system extended from the rack.

### Removing the Top Cover

The top cover can be removed to access the chassis fans while the server continues to operate.

#### **Removing the Chassis Cover**

Remove the screws securing the cover (if used), then push the release buttons towards the front of the chassis. Push/slide the cover towards front, then lift clear of the chassis.

**Warning:** Except for short periods of time, do not operate the server without the cover in place. The chassis cover must be in place to allow for proper airflow and to prevent overheating.

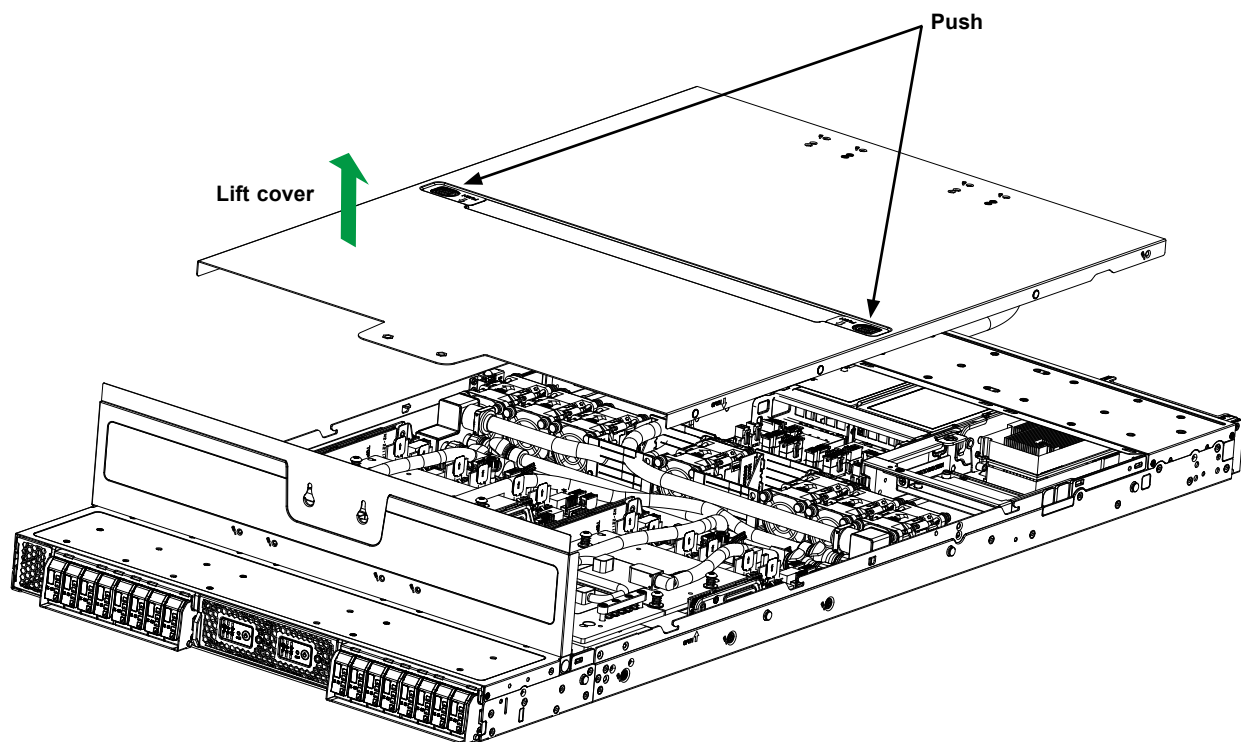

Figure 3-1. Removing the System Cover

### 3.3 Processor and Cold Plate Installation

#### Important:

- For the NVIDIA GH200 Grace Hopper™ Superchip module and heatsink installation, you need to use a **T15 torque driver set to 5 in-lbf** (5.8 kgf-cm).
- Always connect the power cord last, and always remove it before adding, removing or changing any hardware components.
- If you buy a NVIDIA GH200 Grace Hopper Superchip module separately, make sure that you use an NVIDIA-certified multi-directional heatsink only.
- Make sure to install the motherboard into the chassis before you install the module heatsink.
- Refer to the Supermicro website for updates on the NVIDIA GH200 Grace Hopper Superchip module support.

#### *Installing the Superchip onto the Motherboard*

1. Remove the plastic protector on the CPU and GPU connector.

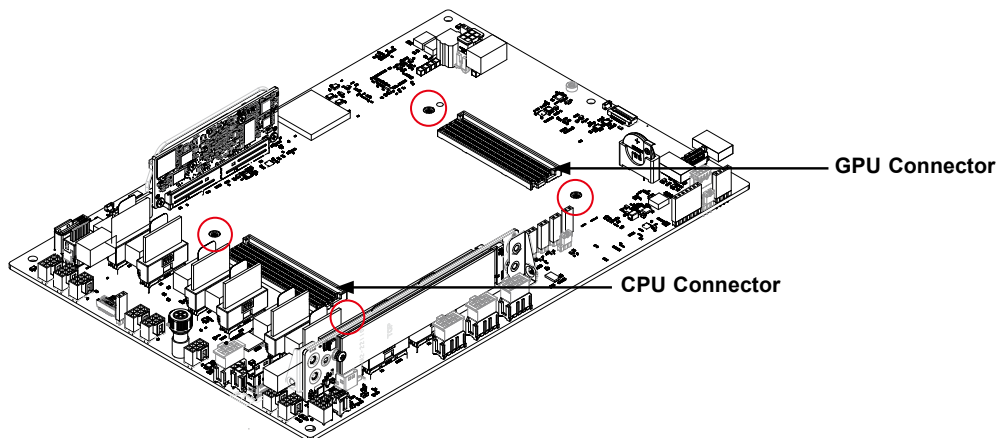

2. Using a torque of **1 in-lbf** (1.2 kgf-cm), tighten the screws on top of the Superchip in the order shown in the drawing below.

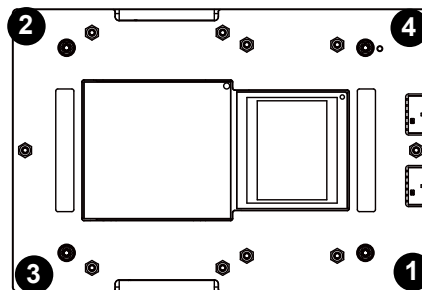

**Superchip Top View**

3. Align the module with its guide pins to the holes circled in red on the motherboard.

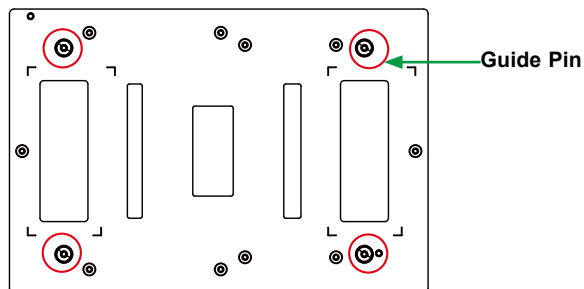

**Superchip Bottom View**

4. Before the springs underneath the NVIDIA GH200 Grace Hopper Superchip module are compressed, check the alignment of the guide pins and the holes on the motherboard again.
5. Fasten the four screws using a **torque of 5 in-lbf (5.8 kgf-cm)** to complete the NVIDIA GH200 Grace Hopper Superchip module installation.

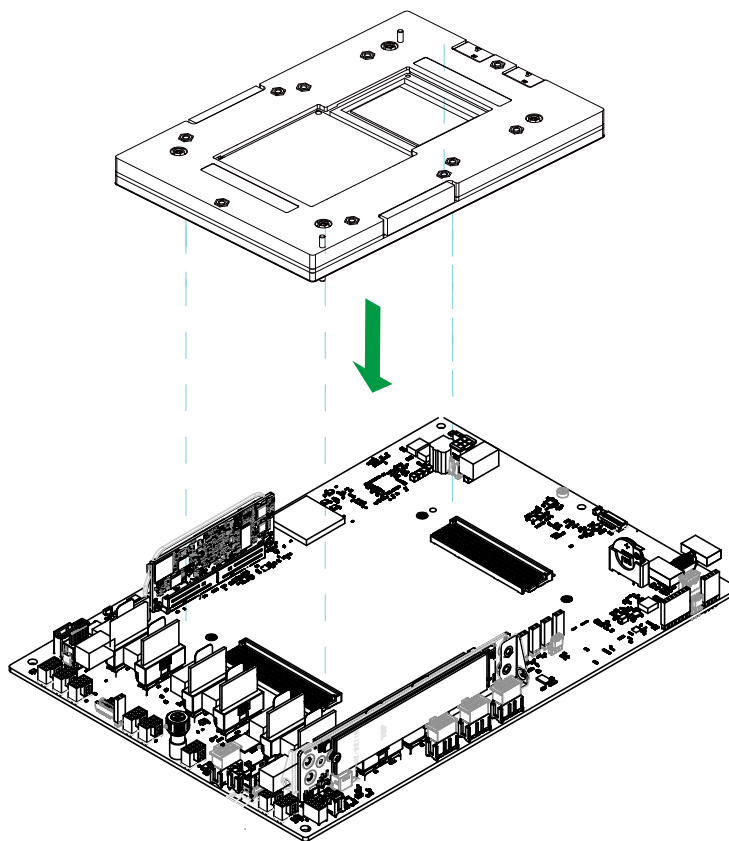

6. Place thermal pads on the module. The thermal pads are shown as red rectangles below.
7. Peel off the thermal pad protector underneath each cold plate.

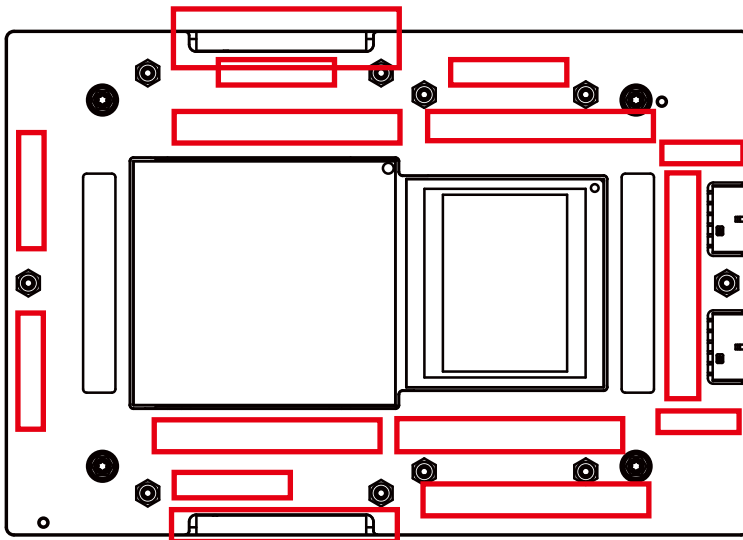

**Superchip Top View**

8. Place the cold plates top of the NVIDIA GH200 Grace Hopper Superchip module.

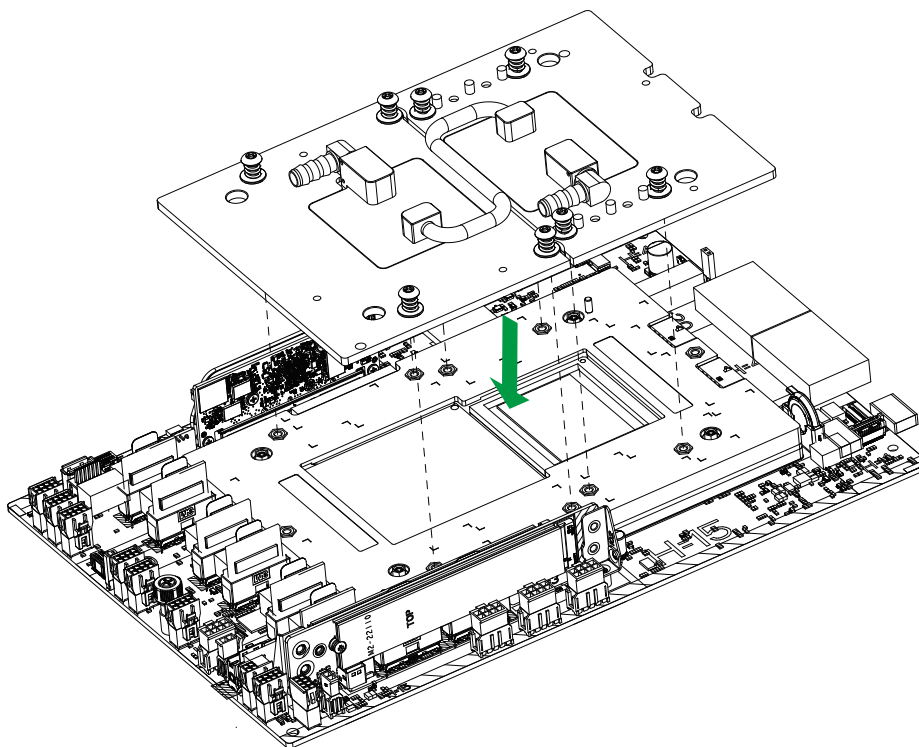

9. Using a **torque of 5 in-lbf (5.8 kgf-cm)**, secure each cold plate onto the NVIDIA GH200 Grace Hopper Superchip module with eight screws.

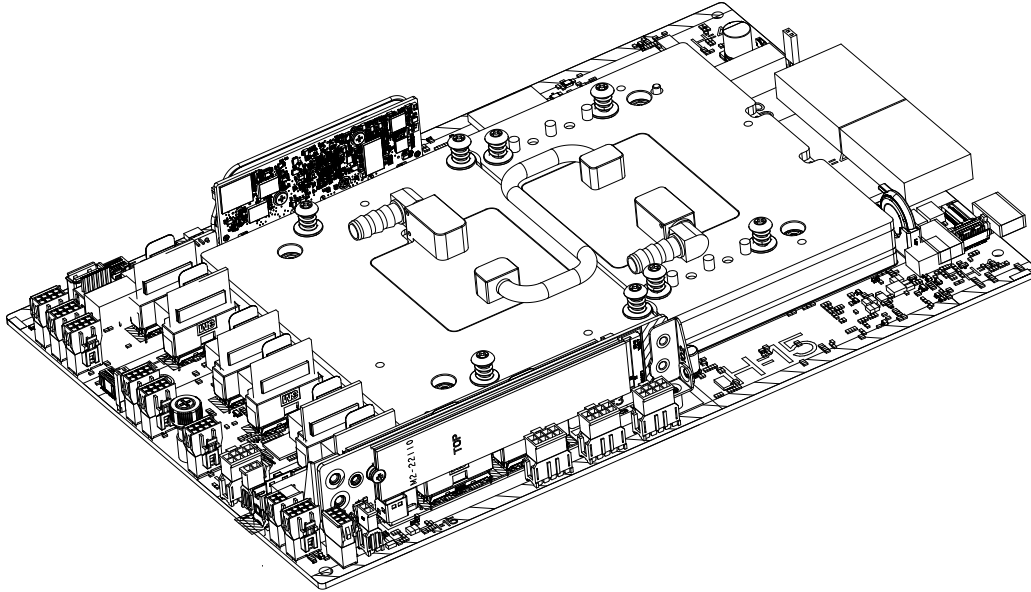

### ***Un-installing the NVIDIA GH200 Grace Hopper Superchip Module and Heatsinks***

1. Use the screwdriver to loosen the screws on the heatsink.
2. Remove the heatsinks attached to the top of the module by reversing the installation procedure.
3. Clean the thermal grease and thermal pads left by the heatsink on the module top to limit the risk of it contaminating the Mirror Mezz connectors.
4. Remove the screws from the modules.
5. Lift the module off from the motherboard.

## **3.4 Memory Support**

The G1SMH-G supports up to 480 GB of ECC LPDDR5 and 96 GB of HBM. The memory is embedded and no installation is required.

## 3.5 Motherboard Battery

The motherboard uses non-volatile memory to retain system information when system power is removed. This memory is powered by a lithium battery residing on the motherboard.

### ***Replacing the Battery***

Begin by removing power from the system.

1. Push aside the small clamp that covers the edge of the battery. When the battery is released, lift it out of the holder.
2. To insert a new battery, slide one edge under the lip of the holder with the positive (+) side facing up. Then push the other side down until the clamp snaps over it.

**Note:** Handle used batteries carefully. Do not damage the battery in any way; a damaged battery may release hazardous materials into the environment. Do not discard a used battery in the garbage or a public landfill. Please comply with the regulations set up by your local hazardous waste management agency to dispose of your used battery properly.

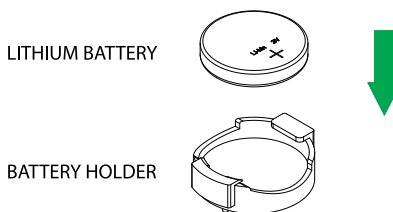

**Figure 3-2. Installing the Onboard Battery**



**Warning:** There is a danger of explosion if the onboard battery is installed upside down (which reverses its polarities). This battery must be replaced only with the same or an equivalent type recommended by the manufacturer (CR2032).

## 3.6 Chassis Components

### SSD Storage Modules

The CSE-MG102TS-R000NDFP-2N chassis supports up to two E1.S NVMe SSD drives using mounting trays or carriers. **Note:** Enterprise-level storage drives are recommended for use in Supermicro servers. For information on recommended drives, visit the Supermicro website.

#### Carrier

The storage drives are mounted in carriers to simplify their installation and removal from the chassis. The ARS-111GL-DNHR-LCC supports two E1.S NVMe drives in the locations shown below.

In the event that a driver needs to be removed from the chassis, please follow the instructions below.

#### Removing Drives from the Chassis

1. Lift up on the bottom of the drive module that you want to remove.
2. Pull the carrier out of the chassis.

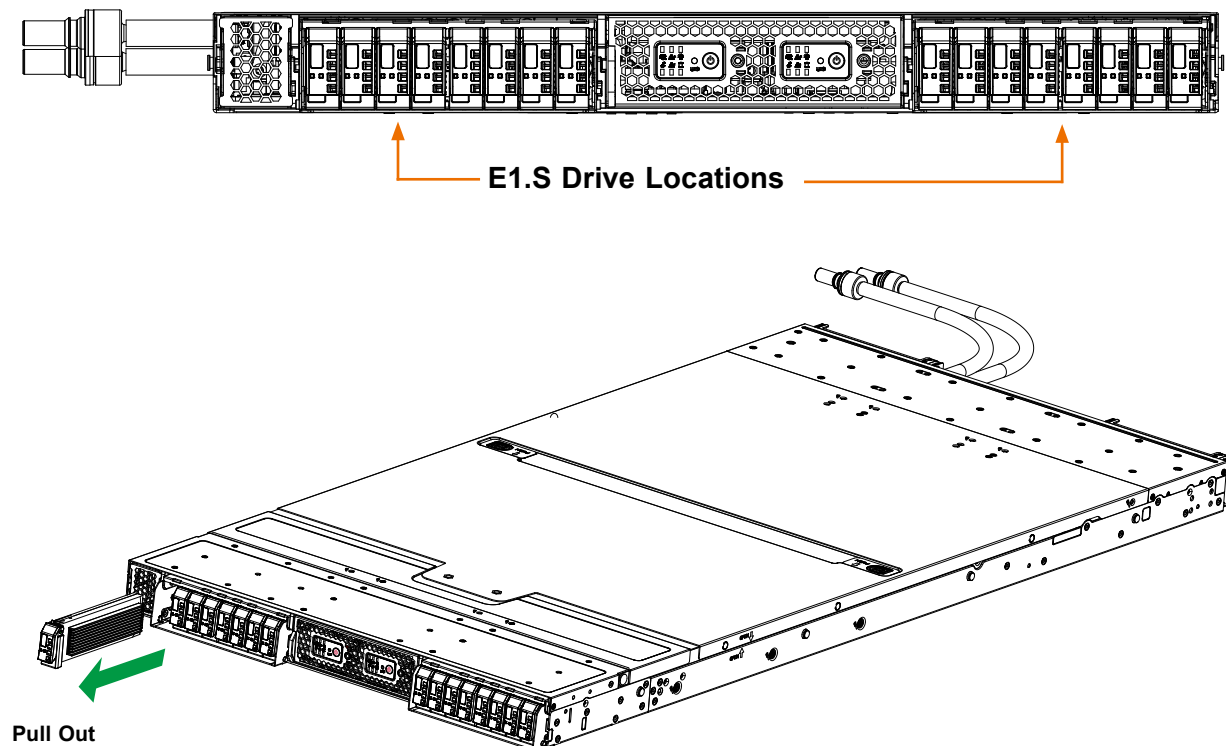

Figure 3-3. Removing a Drive Carrier

## Removing the I/O and PCIe Modules

The CSE-MG102TS-R000NDFP-2N chassis provides one PCIe bay and an I/O module. The PCIe bay has a pull-out module. Removal of the pull-out module is shown below. The I/O module is where the communication ports are located. Unless this module needs to be serviced, it is seldom removed and is shown here for information purposes.

### *Installing an Expansion Card*

1. Power down the system and remove the top cover as described in [Section 3.2](#).
2. Remove all cables connected to the PCIe bay, then pull the bay out.
3. On the back of the chassis, pull the module towards the rear, there are no screws to remove.
4. Unscrew and remove the PCIe slot cover from the module.
5. Secure the PCIe card and bracket into the module's PCIe slot using the screw previously set aside.
6. Replace the PCIe assembly back into the chassis.
7. Replace the top covers and power up the system.

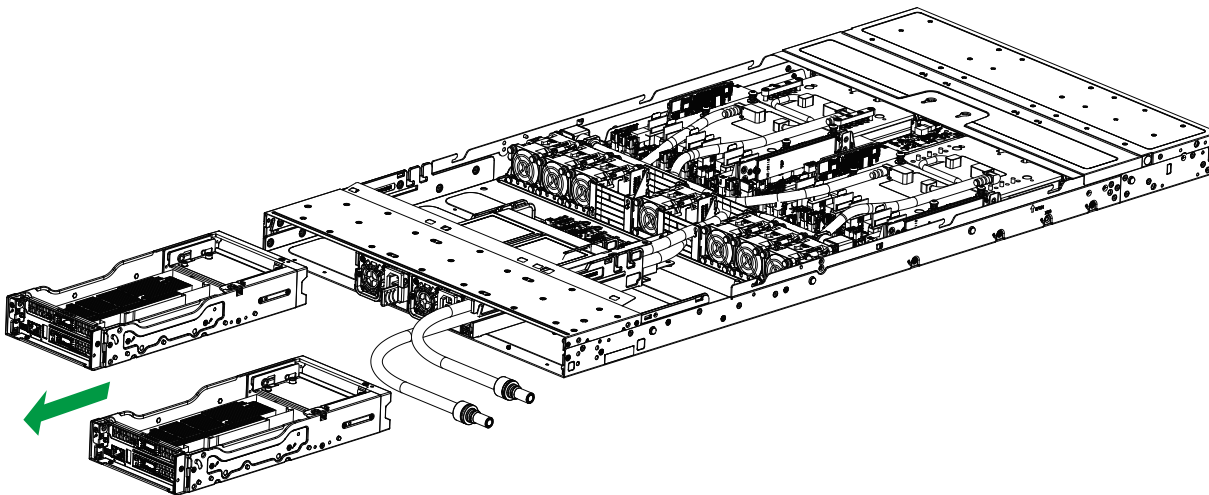

**Figure 3-4. Removing the I/O and PCIe Modules**

## System Fans

Up to seven heavy-duty fans provide cooling for the system. These fans are not hot-swap; power must be removed from the system before replacing.

### *Replacing a System Fan*

1. If necessary, open the chassis while the power is running to determine which fan requires changing. (Never run the server for an extended period of time with the chassis open.)
2. Power down the system.
3. Remove the chassis from the rack and seat it on a work bench (safety area). Open the chassis cover as described earlier in this section.
4. Unplug and pull up on the failed fan to remove it completely out of the chassis. There are no screws to remove.
5. Place the new fan into the vacant space in the housing while making sure the arrows on the top of the fan (indicating air direction) point in the same direction as the arrows on the other fans. Plug the fan into the motherboard and ensure the fan is working properly.
6. The fan will automatically begin running at the correct speed.

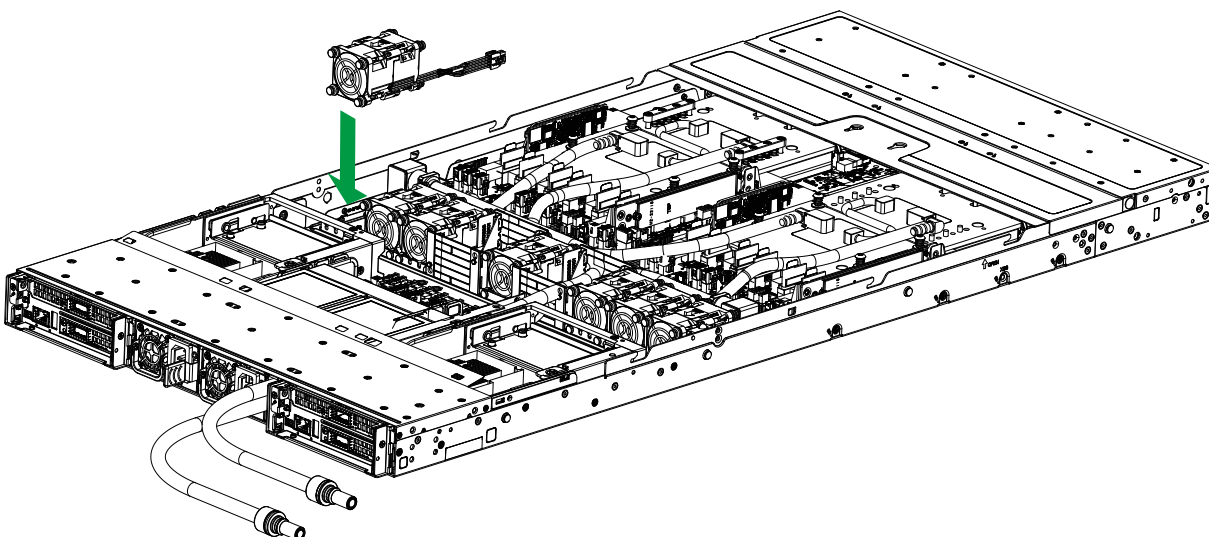

**Figure 3-5. Replacing a System Fan**

## Power Supply

The CSE-MG102TS-R000NDFP-2N features two redundant 2700 W power supplies. Each power supply can be changed without powering down the system. New units can be ordered directly from Supermicro or authorized distributors.

These power supplies are auto-switching capable. This feature enables them to automatically sense and operate with an input voltage of 100-120 V or 180-240 V. An amber light will be illuminated on the power supply when the power is off. An illuminated green light indicates that the power supply is operating.

### *Changing the Power Supply*

1. Unplug the AC cord from the module to be replaced.
2. Push the release lever on the back of the power supply as illustrated.
3. Pull the power supply out using the handle provided.

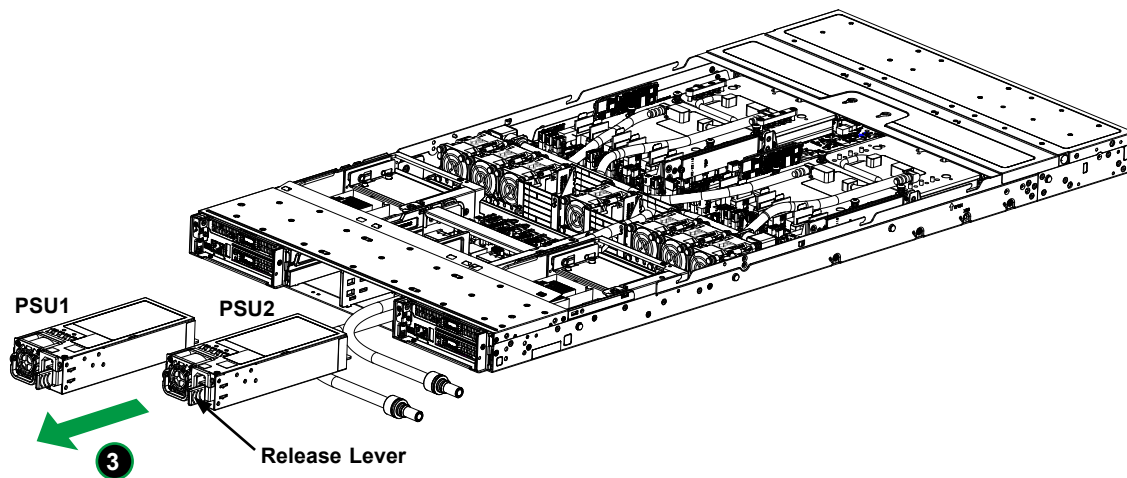

**Figure 3-6. Changing a Power Supply**

4. Replace the failed power module with the same model.
5. Push the new power supply module into the power bay until the release lever clicks.
6. Plug the AC power cord back into the module.

## 3.7 M.2 Solid State Drive Installation

The M.2 carrier must be installed before the processor and heatsink.

### ***Installing M.2 Carrier***

1. On the M.2 carrier, install M.2 SSDs, if necessary.
2. On the motherboard, locate slots C1U2-1 and C1U2-2.
3. See the M.2 carrier drawing below for the connectors that belong to the C1U2-1 and C1U2-2 slots.

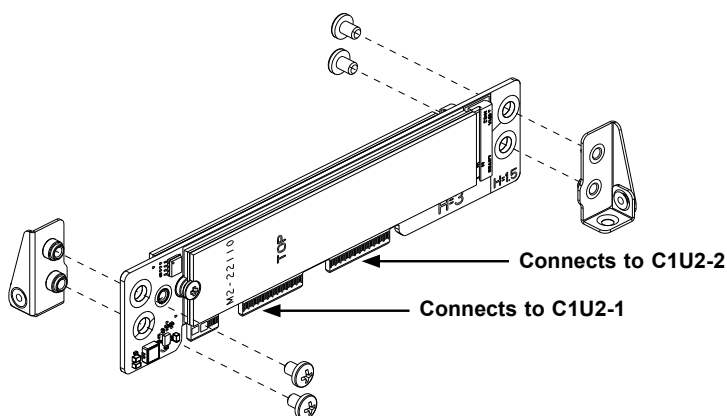

4. Install the brackets onto the M.2 carrier.
5. Install the M.2 carrier on to the motherboard.

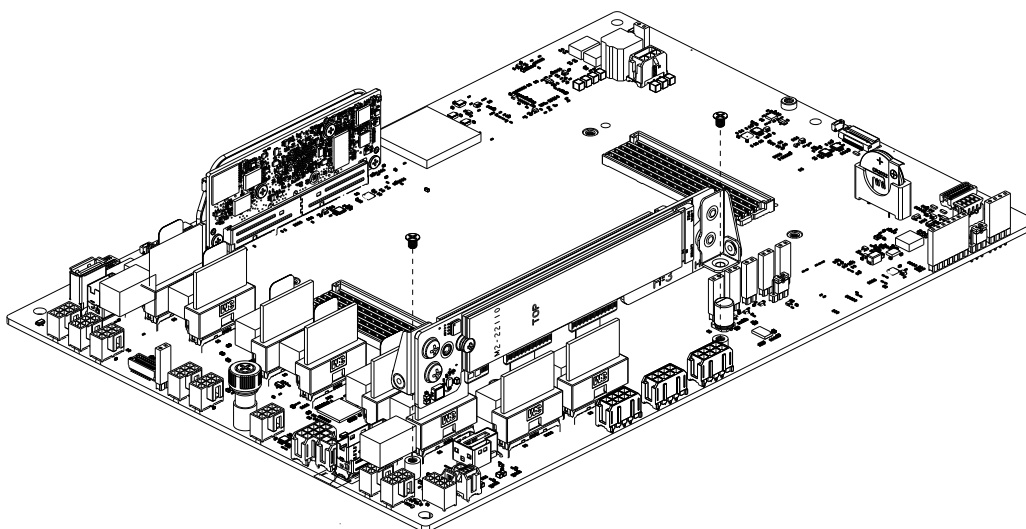

## Chapter 4

# Motherboard Connections

This section describes the connections on the motherboard and provides pinout definitions. Note that depending on how the system is configured, not all connections are required. The LEDs on the motherboard are also described here. A motherboard layout indicating component locations may be found in [Chapter 1](#). More detail can be found in the [Motherboard Manual](#). Please review the Safety Precautions in [Appendix A](#) before installing or removing components.

### 4.1 Power Connections

#### 48 V 6-pin GPU Power Supply Connector (JPWR1)

JPWR1 is a 6-pin MICRO POWER PLUS power input to provide primary power to the GPU module. Refer to the table below for pin definitions.

48 V 6-pin GPU Power Connector Pin Definitions			
Pin#	Definition	Pin#	Definition
1	Ground	4	+48 V
2	Ground	5	+48 V
3	Ground	6	+48 V

#### 12 V 8-pin Main Power Supply Connector (JPWR2-JPWR4)

JPWR2-4 is an 8-pin MICRO POWER PLUS power input to provide primary power to the motherboard. Refer to the table below for pin definitions.

12 V 8-pin Main Power Connector Pin Definitions			
Pin#	Definition	Pin#	Definition
1	Ground	5	+12 V
2	Ground	6	+12 V
3	Ground	7	+12 V
4	Ground	8	+12 V

#### 12 V 2-pin Main Power Supply Connector (JPWR7)

JPWR7 is a 2-pin MICRO POWER PLUS power input to provide primary power to the motherboard. Refer to the table below for pin definitions.

12 V 2-pin Main Power Connector Pin Definitions			
Pin#	Definition	Pin#	Definition
1	Ground	2	+12 V

### 12 V 8-pin IO Board Power Supply Connector (JPWR6)

JPWR6 is an 8-pin MICRO POWER PLUS power input to provide power to the I/O board. Refer to the table below for pin definitions.

12 V 8-pin IO Board Power Connector Pin Definitions			
Pin#	Definition	Pin#	Definition
1	Ground	5	+12 V
2	Ground	6	+12 V
3	Ground	7	+12 V
4	Ground	8	+12 V

### 12 V 2-pin IO Board Power Supply Connector (JPWR8)

JPWR8 is a 2-pin MICRO POWER PLUS power input to provide power to the I/O board. Refer to the table below for pin definitions.

12 V 8-pin IO Board Power Connector Pin Definitions			
Pin#	Definition	Pin#	Definition
1	Ground	2	+12 V

### 20-pin Main Sideband Power Connector (JSB2)

JSB2 is a 20-pin MICRO POWER PLUS power input to provide power to the sideband connector. Refer to the table below for pin definitions.

20-pin Main Sideband Power Connector Pin Definitions			
Pin#	Definition	Pin#	Definition
1	PSU1_PRSNT	11	N.A.
2	PSU2_PRSNT	12	SMB_DATA
3	PSU3_PRSNT	13	N.A.
4	PSU4_PRSNT	14	SMB_SCL
5	PSU1_PWROK	15	N.A.
6	PSU2_PWROK	16	Ground
7	PSU3_PWROK	17	N.A.
8	PSU4_PWROK	18	PSU_12V_SENSE
9	PSU_PWRON	19	N.A.
10	SMB_ALERT	20	PSU_12V_SENSE_RTN

### 74-pin IO Sideband Power Supply Connector (JSB1)

JSB1 is a 74-pin MICRO POWER PLUS power input to provide power to the sideband connector. Refer to the table below for pin definitions.

74-pin IO Sideband Power Connector Pin Definitions			
Pin#	Definition	Pin#	Definition
A1	Ground	B1	Ground
A2	HSO0_P	B2	HSI0_P
A3	HSO0_N	B3	HSI0_N
A4	Ground	B4	Ground
A5	IOB_DP_TXD0_P	B5	IOB_DP_TXD1_P
A6	IOB_DP_TXD0_N	B6	IOB_DP_TXD1_N
A7	Ground	B7	Ground
A8	BUTTON_POWER_ON_N	B8	UART5_BMC_TX
A9	FP_PWR_LED_N	B9	UART5_BMC_RX
A10	SYS_RST_IN_L	B10	
A11	FP_UID_RESET_SW_N	B11	UART1_CONN1_TX
A12	CPLD_UID_LED	B12	UART1_CONN1_RX
A13	Ground	B13	Ground
A14	IOB_PERST_N	B14	NC_NCSI_CRD_DV
A15	IOB_WAKE_N	B15	NC_NCSI_TX_EN_GPIO3
A16	Ground	B16	Ground
A17	NC_NCSI_RX_D0_GPIO6	B17	NC_NCSI_TX_D0_GPIO4
A18	NC_NCSI_RX_D1_GPIO7	B18	NC_NCSI_TX_D1_GPIO5
A19	Ground	B19	Ground
A20	MODULE_PWR_GOOD_3V3	B20	NC_CLK_50M_IOB_NCSI
A21		B21	IOB_PRST_N
A22	Ground	B22	Ground
A23	PE_REFCLK3_P	B23	B2B_IOEXP_INT_L
A24	PE_REFCLK3_N	B24	IOB_DP_HPD
A25	Ground	B25	Ground
A26	B2B_SMCLK_3V3	B26	IOB_OCI_N
A27	B2B_SMDAT_3V3	B27	
A28	Ground	B28	BMC_PHY_RST_N
A29	IOB_SCL	B29	I2C_BMC_BUS5_SCL
A30	IOB_SDA	B30	I2C_BMC_BUS5_SDA
A31	Ground	B31	Ground
A32	IOB_DP_AUX_P	B32	U2_DP2
A33	IOB_DP_AUX_N	B33	U2_DN2
A34	Ground	B34	Ground
A35	U3_RX_DP2	B35	U3_TX_DP2
A36	U3_RX_DN2	B36	U3_TX_DN2
A37	Ground	B37	Ground

## 4.2 Headers and Connectors

### TPM/Port 80 Header

A Trusted Platform Module (TPM)/Port 80 header is located at JTPM1 to provide TPM support and Port 80 connection. Use this header to enhance system performance and data security. Refer to the table below for pin definitions. Please go to the following link for more information on the TPM: <http://www.supermicro.com/manuals/other/TPM.pdf>.

Trusted Platform Module Header Pin Definitions			
Pin#	Definition	Pin#	Definition
1	+3.3 V	6	GND
2	SPI_CS#	7	SPI_MOSI
3	RESET#	8	N.A.
4	SPI_MOSI	9	+3.3V_STBY
5	SPI_CLK	10	SPI_IRQ#

### Expansion Slots

The motherboard can support seven expansion slots via a PCIe Gen 5 riser card. The table below describes each slot's type and speed.

Expansion Slots	
Name	Description
LWIO	Left-hand riser card slot supports PCIe 5.0 x16
RWIO	Right-hand riser card slot supports PCIe 5.0 x16
AIOM1	AIOM (Advanced I/O Module) supports PCIe 5.0 x16 with NCSI
AIOM2	AIOM (Advanced I/O Module) supports PCIe 5.0 x16

### Onboard Battery (BT1)

The onboard back up battery is located at BT1. The onboard battery provides backup power to the on-chip CMOS, which stores the BIOS setup information. It also provides power to the Real Time Clock (RTC) to keep it running.

### Chassis Intrusion (JL1)

A Chassis Intrusion header is located at JL1 on the motherboard. Attach the appropriate cable from the chassis to the header to inform you when the chassis has been opened.

Chassis Intrusion Pin Definitions	
Pins	Definition
1	Intrusion Input
2	Ground

### Power SMB Header (PWRI2C)

Power System Management Bus (I<sup>2</sup>C) header monitors power supply, fan and system temperatures. See the table below for pin definitions.

Power SMB Header Pin Definitions	
Pin#	Definition
1	Clock
2	Data
3	Alert
4	Ground
5	+3.3 V

## Front Control Panel

JFP1 contains header pins for various buttons and indicators that are normally located on a control panel at the front of the chassis. These connectors are designed specifically for use with Supermicro chassis. See the figure below for the location of JFP1.

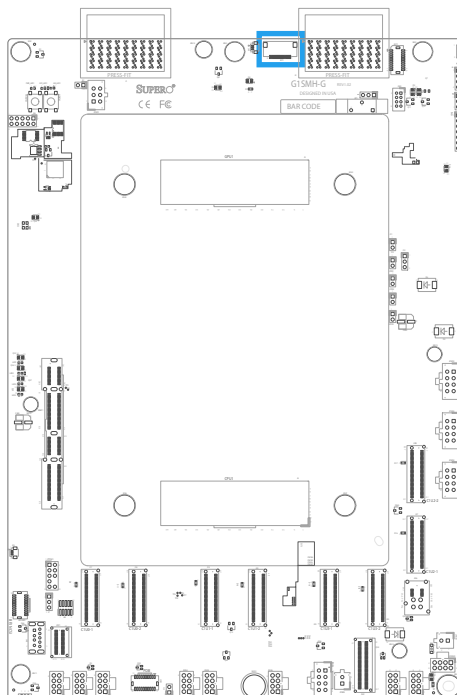

### JFP1

1	○	Power Button
2	○	UID Reset Switch
3	○	UID LED
4	○	Power Fail LED
5	○	N/A
6	○	N/A
7	○	Drive Activity LED
8	○	Standby Power LED
9	○	Normal Power LED
10	○	3.3 V Standby Power
11	○	Ground
12	○	I2C Data Temperature Sensor
13	○	I2C Clock Temperature Sensor
14	○	Ground
15	○	N/A
16	○	N/A
17	○	N/A
18	○	N/A
19	○	N/A
20	○	Ground

Figure 2-2. JFP1 Pin Definitions

### Power LED

The Power LED connection is located on pins 8 and 9 of JFP1. Refer to the table below for pin definitions.

Power LED Pin Definitions (JFP1)	
Pin#	Definition
8	Standby Power LED
9	Normal Power LED

### Drive LED

The drive LED connection is located on pin 7 of JFP1. Attach a drive LED cable here to display drive activity detected on the motherboard's built-in drive controllers. See the table below for pin definitions.

Drive LED Pin Definitions (JFP1)	
Pin#	Definition
7	Drive Activity LED

### Power Fail LED

The Power Fail LED connection is located on pin 4 of JFP1. Refer to the table below for pin definitions.

Power Fail LED Pin Definitions (JFP1)	
Pin#	Definition
4	Power Fail LED

### UID LED

The UID LED is on pin 3 of JFP1. Connect the front panel UID LED to this header to indicate when the rear UID switch is turned on. Refer to the table below for pin definitions.

UID LED Pin Definitions (JFP1)	
Pin#	Definition
3	UID LED

### UID Reset Button

The UID Reset Button connection is located on pins 2 and 11 of JFP1. Attach the hardware UID reset switch from the computer case to this header to reset the system. Refer to the table below for pin definitions.

UID Reset Button Pin Definitions (JFP1)	
Pin#	Definition
2	UID Reset Switch
11	Ground

### Power Button

The Power Button connection is located on pins 1 and 11 of JFP1. Momentarily contacting both pins will power on/off the system. This button can also be configured to function as a suspend button (with a setting in the BIOS). To turn off the power in the suspend mode, press the button for at least 4 seconds. Refer to the table below for pin definitions.

Power Button Pin Definitions (JFP1)	
Pin#	Definition
1	Power Button
11	Ground

## 4.3 LED Indicators

### UID LED (UID\_LED1)

The UID LED is located next to two buttons at one of the corners of the motherboard. One of the buttons is the UIDBTN1 button. Press this button and the LED will blink blue to show that the UID is active. Press the UIDBTN1 button for one second and the LED will turn solid blue. Use this UID LED to 'mark' the system, so the motherboard can be easily identified. See the table below for more information.

UID LED States		
Color	State	Definition
None	Off	UID Off
Blue	Solid On	Unit Identified by Local Site
Blue	Slow Blinking	Unit Identified by Remote Site
Blue	Slow Blinking	System Recovery

### CPLD Initialization LED (HB\_LED1)

The CPLD Initialization LED is located next to two buttons at one of the corners of the motherboard. When the the LED is blinking green it indicates that the CPLD has been initialized. See the table below for more information.

CPLD Initialization LED States		
Color	State	Definition
None	Off	CPLD Uninitialized
Green	Blinking	CPLD Initialization OK

### Motherboard Power LED (PWR\_LED1)

A motherboard power LED is located next to two buttons at one of the corners of the motherboard. Press the PWRBTN1 and the LED will be solid green. See the table below for more information.

Motherboard Power LED State		
Color	State	Definition
Green	Solid On	BMC is not ready
Green	Blinking	BMC Normal
Green	Fast Blinking	BMC: Initializing

## M.2 Activity LEDs

ACT\_LED1 and ACT\_LED2 are onboard M.2 LEDs. When these LEDs are blinking green, the M.2 SSD is active.

M.2 Activity LEDs		
LED Color	State	Definition
None	Off	M.2 Inactive
Green	Blinking	M.2 Active

## EROT Detected LEDs (LED1 and LED2)

The EROT Detected OK LED (LED1) and the EROT Detected Fail LED (LED2) shows the status of the Root-of-Trust (RoT). LED1 is solid yellow if the RoT is in a good state. LED2 is solid red if there is an error. See the tables below for more information.

Root-of-Trust LED1 State		
Color	State	Definition
Yellow	Solid On	Root-of-Trust is OK

Root-of-Trust LED2 State		
Color	State	Definition
Red	Solid On	Error detected

## Normal Power Detected LED (LED3)

The Normal Power Detected LED indicates the motherboard is on normal power. Before pressing PWRBTN1, the LED blinks green. After pressing PWRBTN1, the LED turns solid green.

Normal Power Detected LED State		
Color	State	Definition
Green	Blinking	Normal Power not detected
Green	Solid	Normal Power detected

## Standby Power Detected LED (LED4)

The Standby Power Detected LED indicates the motherboard is on standby power. Before pressing PWRBTN1, the LED is solid orange. After pressing PWRBTN1, the LED turns off.

BMC Heartbeat LED State		
Color	State	Definition
Orange	Solid	Standby Power detected
Orange	Off	Stanby Power not detected

## Chapter 5

# Software

After the hardware has been installed, you can boot the Operating System (OS). In addition, the following software is supported on the G1SMH-G.

### 5.1 Ubuntu® Server 22.04 ISO Installation

#### Prerequisites

Obtaining the Ubuntu Server ISO for ARM image (aarch64) and save it to your local disk or a shared server. It's recommended to use Ubuntu Server 22.04.4 LTS. Please refer to [Ubuntu Server for ARM](#) for the ISO packages.

### Ubuntu Server

This is the default iso image of the Ubuntu Server installer.

[Download 22.04.4 LTS](#)

[Download 23.10](#)

[Alternative and previous releases >](#) [How to install >](#)

#### Connecting to BMC network

To utilize the BMC remote functionality, ensure that the network is connected to the BMC.

#### Connecting to Ethernet Using a Network Card

During the Ubuntu 22.04 installation process, network configuration is essential to test the connection to mirror locations for Ubuntu repositories and archives. Please ensure Ethernet connectivity by using a network card. If there's a firewall configuration within your network, the mirror location test may fail. In such cases, disconnect the Ethernet cable for the OS installation. The OS installation can still be successful without an Ethernet connection for obtaining the latest updates. For further details, please refer to [Step 6. Installing Ubuntu 22.04 OS](#).

## Installing Ubuntu 22.04 OS

### Step 1. Obtaining the BMC IP Address

Connect the system to a monitor or display using a Mini DisplayPort (Mini DP) or a Mini DisplayPort-to-DisplayPort (DP) adapter. Ensure that network is connected to BMC using a network cable and power on the system. The BMC IP address will appear on the right corner of the Supermicro Logo screen.



### Step 2. Accessing the BMC Remote Server

#### Log in to the BMC Remote Server

1. In the terminal, execute a ping command to the BMC IP address, such as 172.30.195.94, to verify its connectivity.
2. Launch a new web browser and input the BMC IP address into the URL field. **Outcome:** The BMC Remote Console login screen will be displayed.

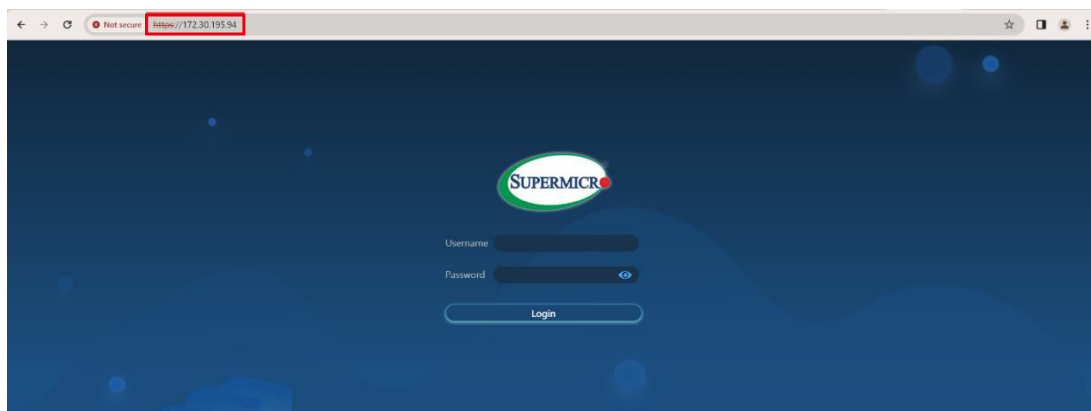

- Input the username "**ADMIN**" and the unique BMC password, which is located on the label on the opposite side of the service tag of the system. Click the "**Login**" to proceed.

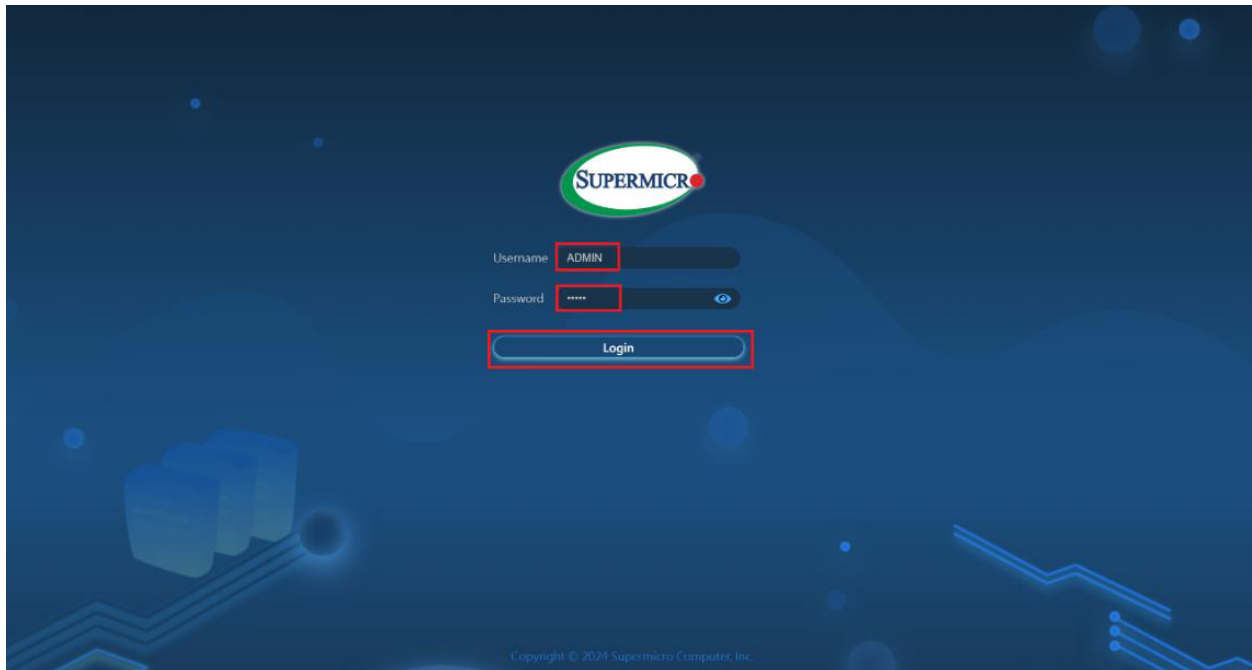

**Outcome:** The BMC Dashboard offers insights into system overview, configuration, health status, and maintenance.

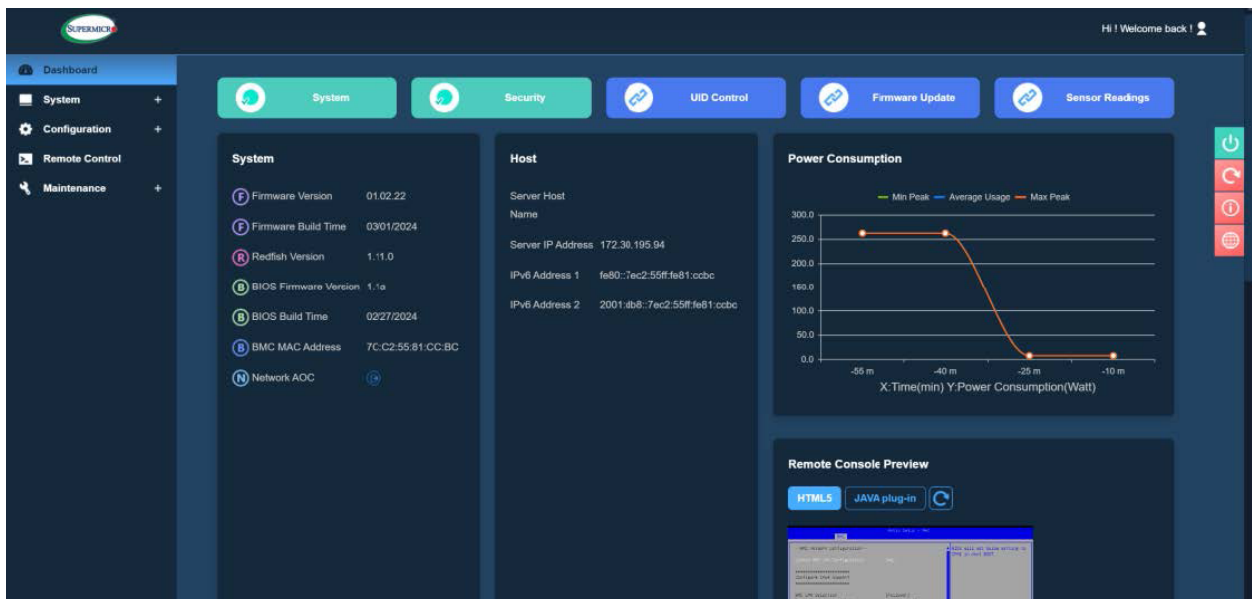

### Step 3. Controlling the BMC Remotely

1. The Remote Control menu in the BMC Remote Server enables remote server operations.

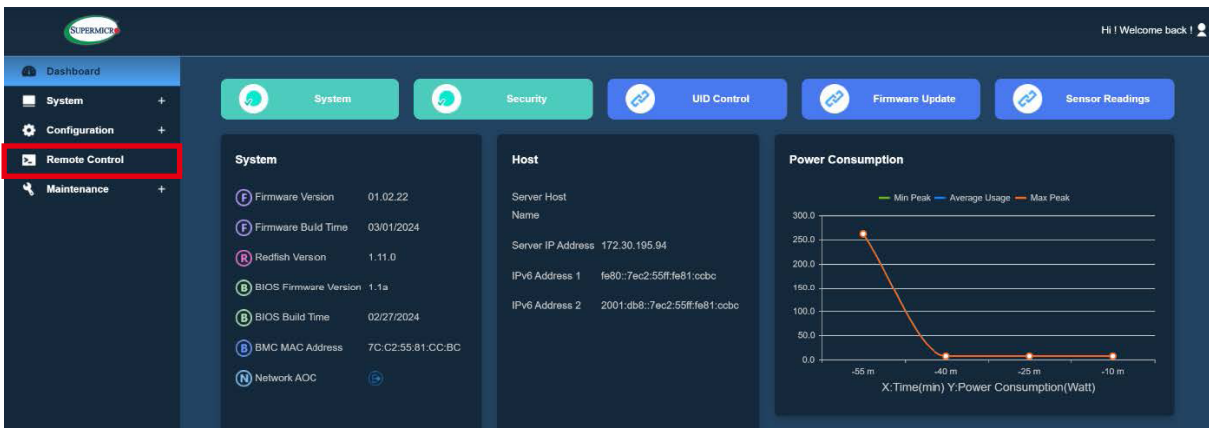

2. Use the Launch Console section to configure the remote console interface settings. Choose between the HTML5 interface or a JAVA plug-in.

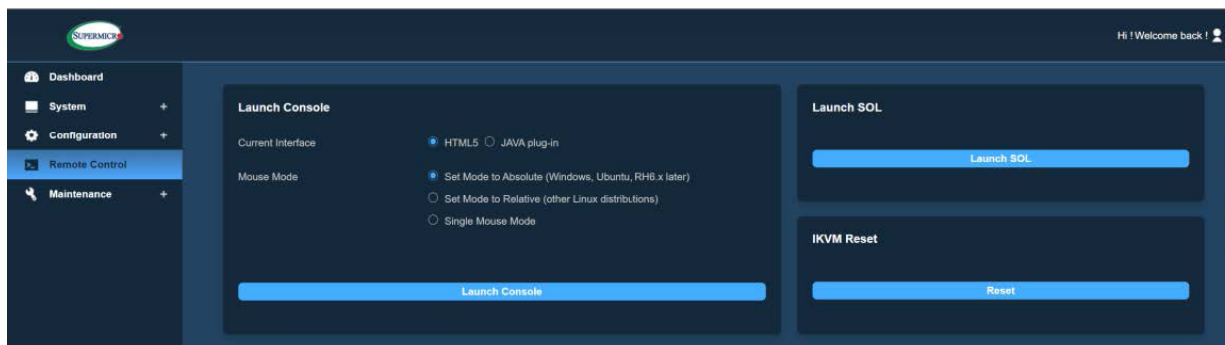

### Launch an HTML5 Remote Browser

1. Set HTML5 as the current interface.
2. Choose the mouse mode according to your operating system, such as **"Set Mode to Absolute (Windows, Ubuntu, RH6.x, or later)"**.
3. Click the **"Launch Console"** button to open a console in a new browser window.

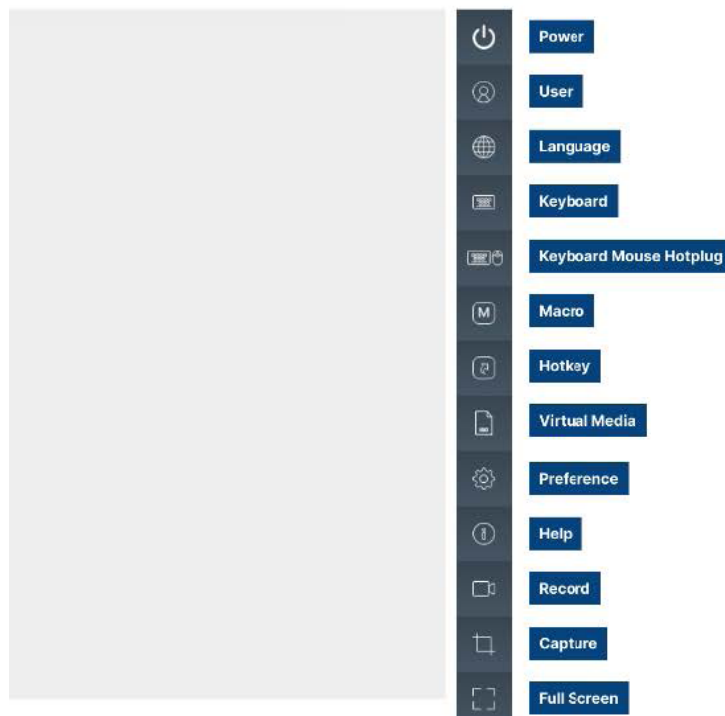
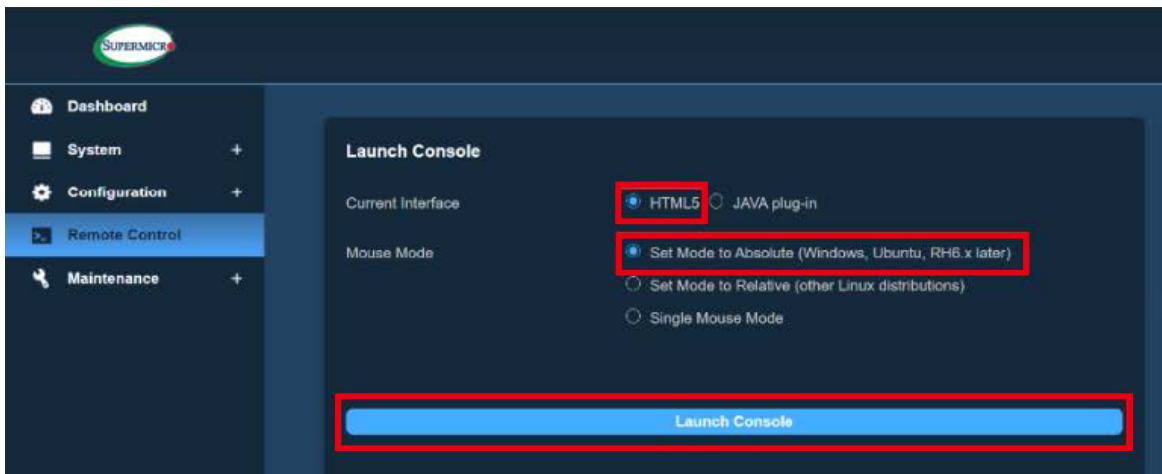

#### Step 4. Mounting the ISO image

There are two methods to mount ISO images. If the ISO files are stored locally on your disk, you can mount them directly within the remote control browser. Alternatively, if the ISO files are located on a shared server, you can mount them via the Configuration > Virtual Media menu.

##### *Method One: Mount the ISO image using a local file*

1. In the remote control browser, click the "**Virtual Media**" icon. This action will prompt a dialogue box to appear, enabling you to select the image type and files for mounting.

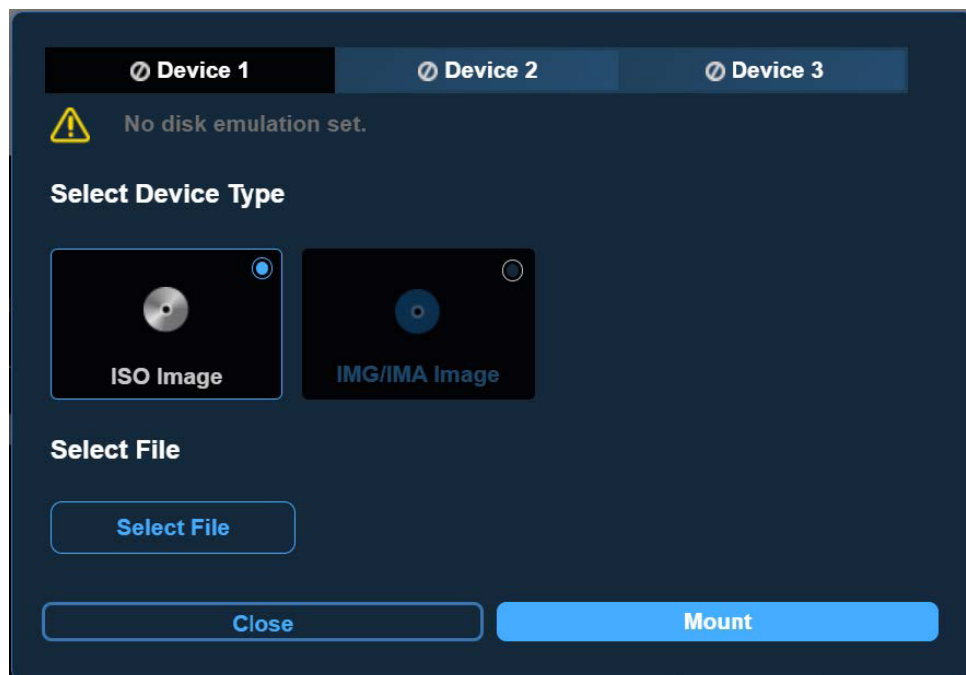
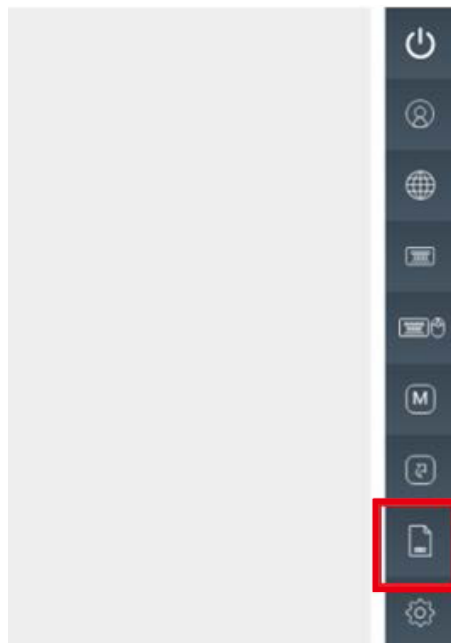

2. Select the **"Choose File"** button to browse and select the Ubuntu ISO image on your local disk for use.

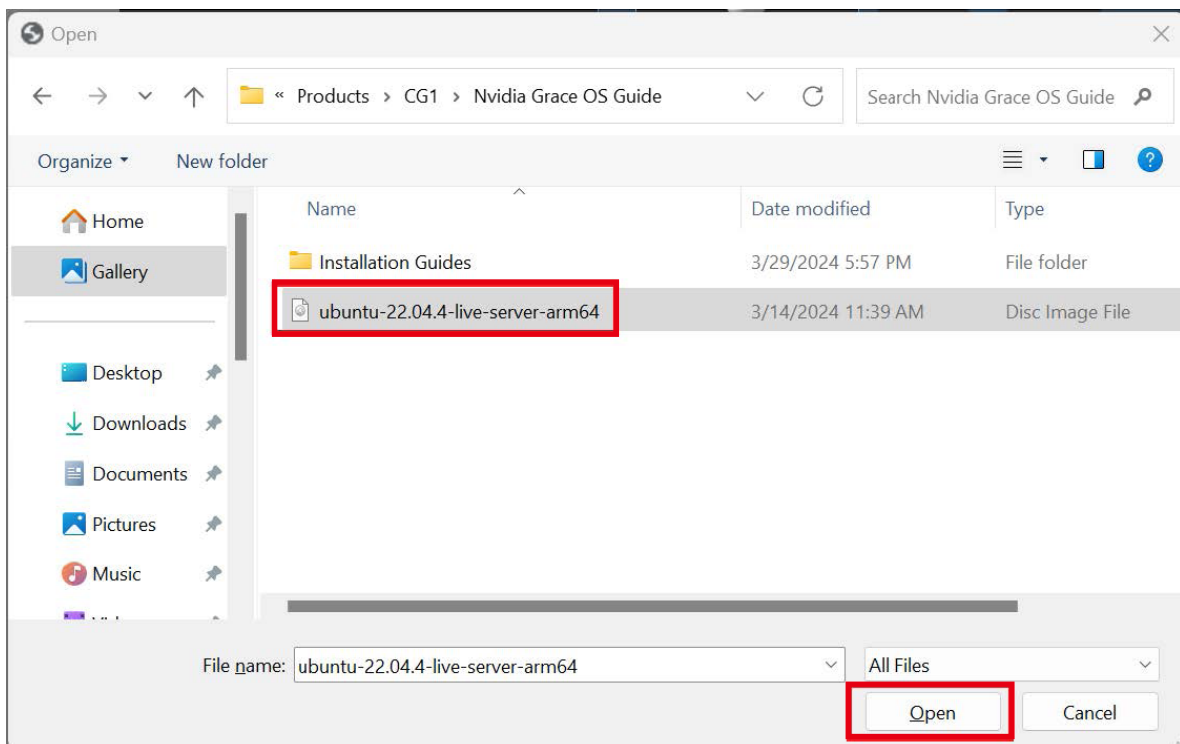
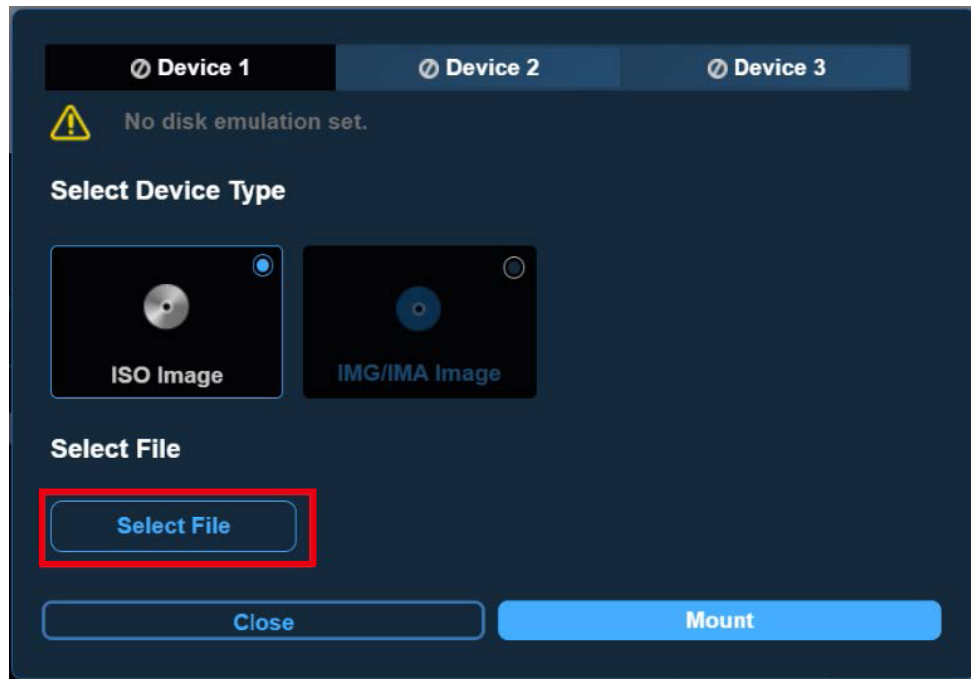

3. Click the **"Mount"** button to attach the chosen ISO image.

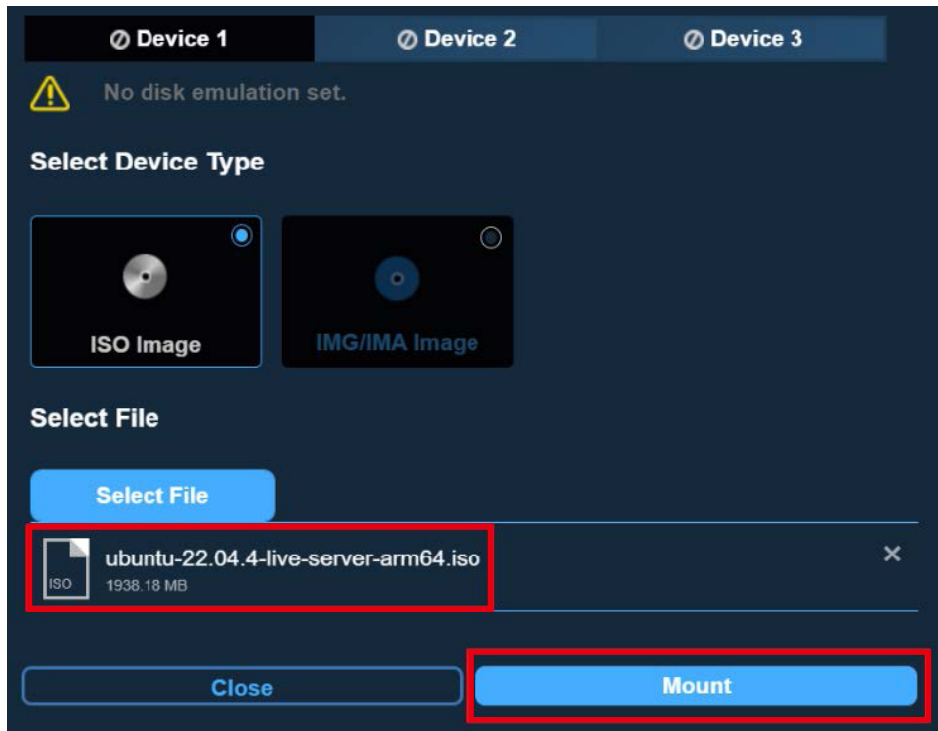

**Result:** Upon successful mounting of the ISO image, a green indicator will appear in the "Device" tab. Close the dialogue to continue.

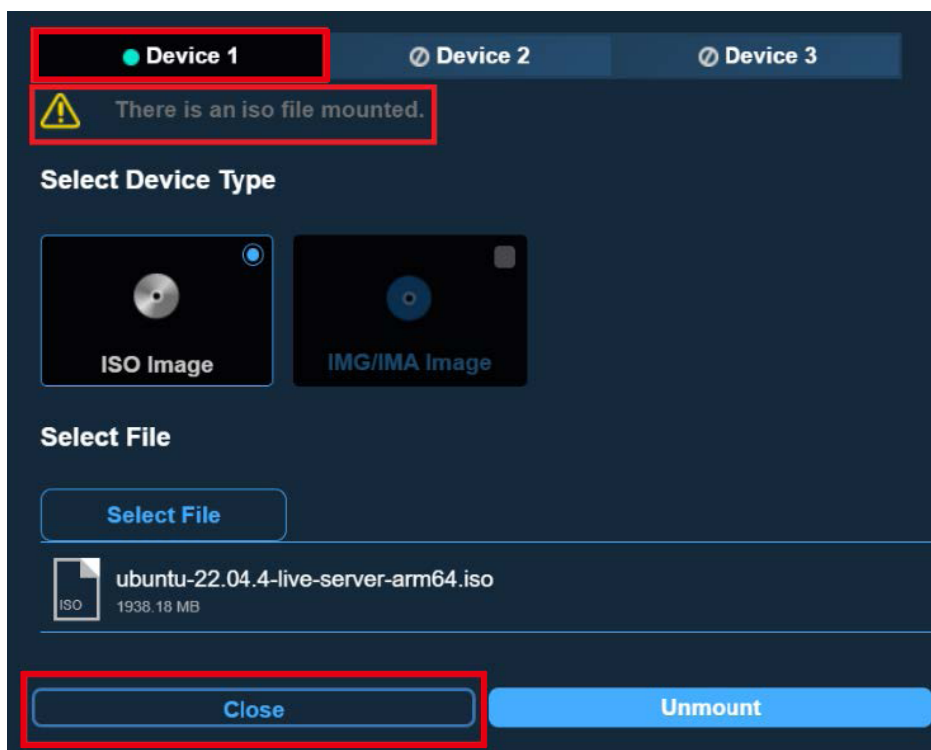

### **Method Two: Mount the ISO image through a shared server**

1. On the BMC dashboard, go to Configuration > Virtual Media, this allows you to attach an ISO image from the server.

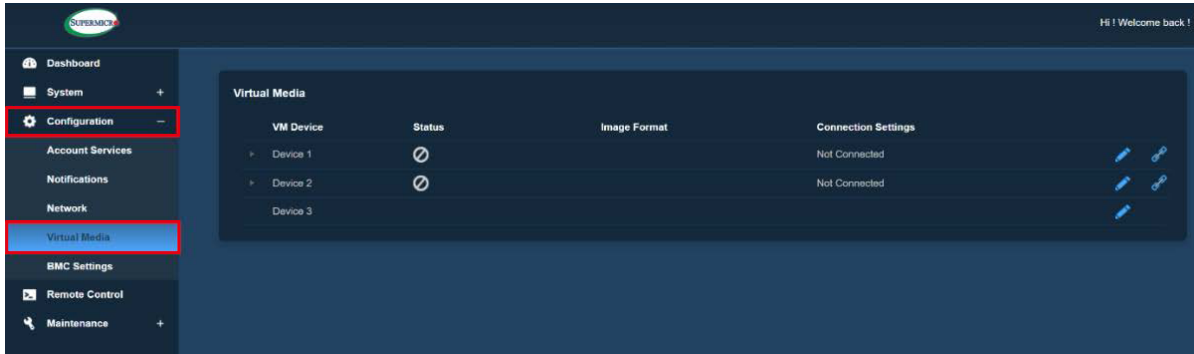

2. Click the "Edit" icon to adjust the VM configuration. Enter the server host address and the path to the ISO image. Then, click the "Save" to apply the changes.

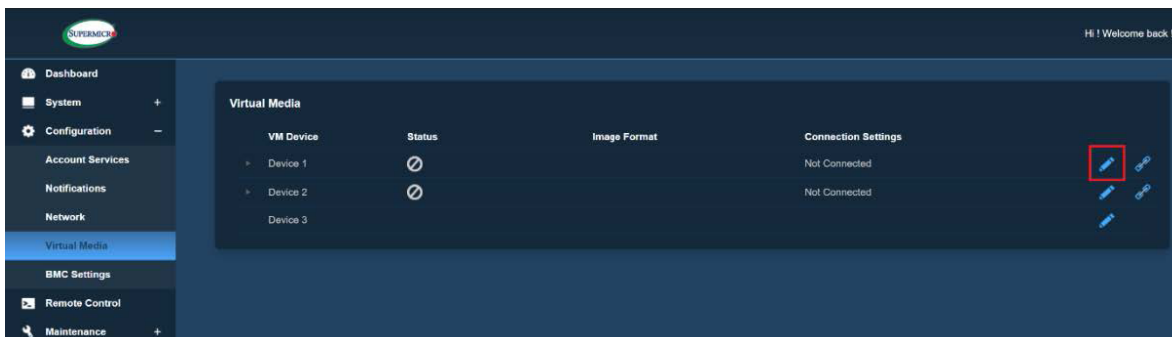

#### Edit VM Connection

Share Host \*

Verify the certification of the server  
 Accept the self-signed certificates

Path to Image \*

Users

Password

3. Click the **"Connect"** icon to mount the virtual media. The device status will display as green once the VM is successfully configured.

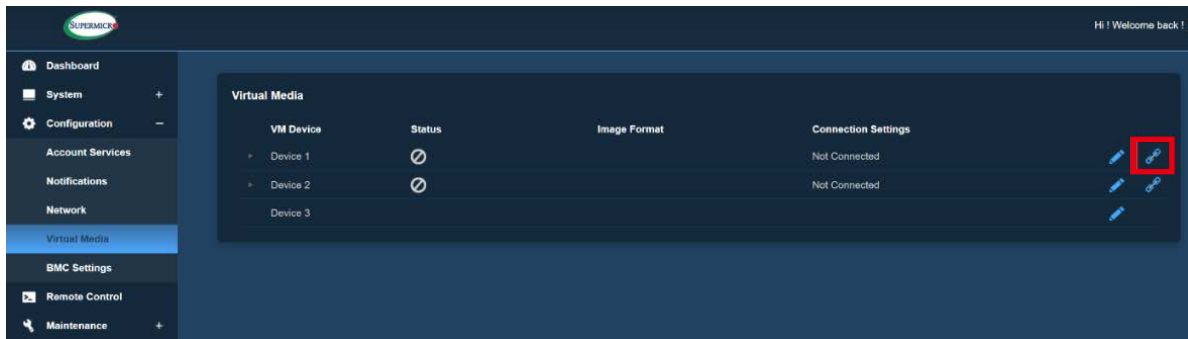

The device status will display as green once the VM is successfully configured.

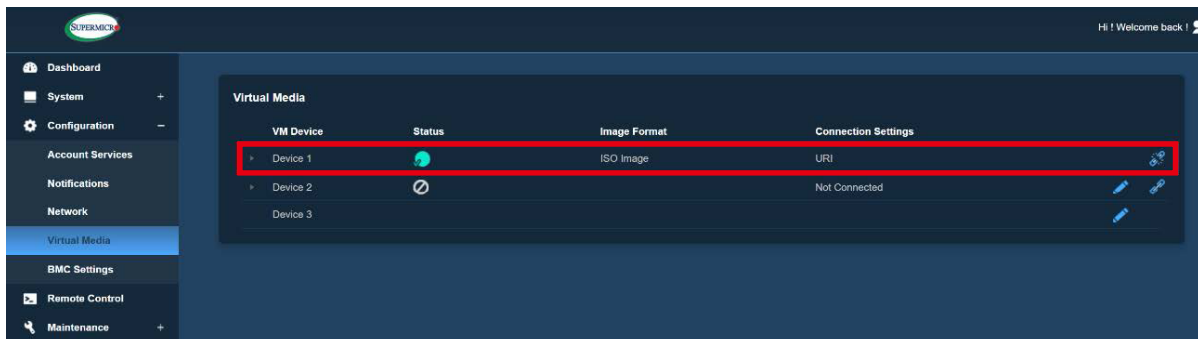

### Step 5. Setting Boot Override in UEFI BIOS

To configure the boot option from the mounted image in virtual media, users must manually adjust the boot settings in the BIOS setup.

1. Power on the system and wait for the Log screen to display. To access the BIOS setup menu, repeatedly press <DEL> until "Entering Setup..." appears at the bottom left corner of the screen. Subsequently, the UEFI BIOS screen is displayed.



Subsequently, the UEFI BIOS screen is displayed.



2. Navigate to the **"Save & Exit"** menu using the arrow keys, then select **"UEFI: ATEN Virtual CDROM YSOJ"** as the boot option. This selection presents the ISO image mounted in Virtual Media. Hit **"Enter"** to proceed.

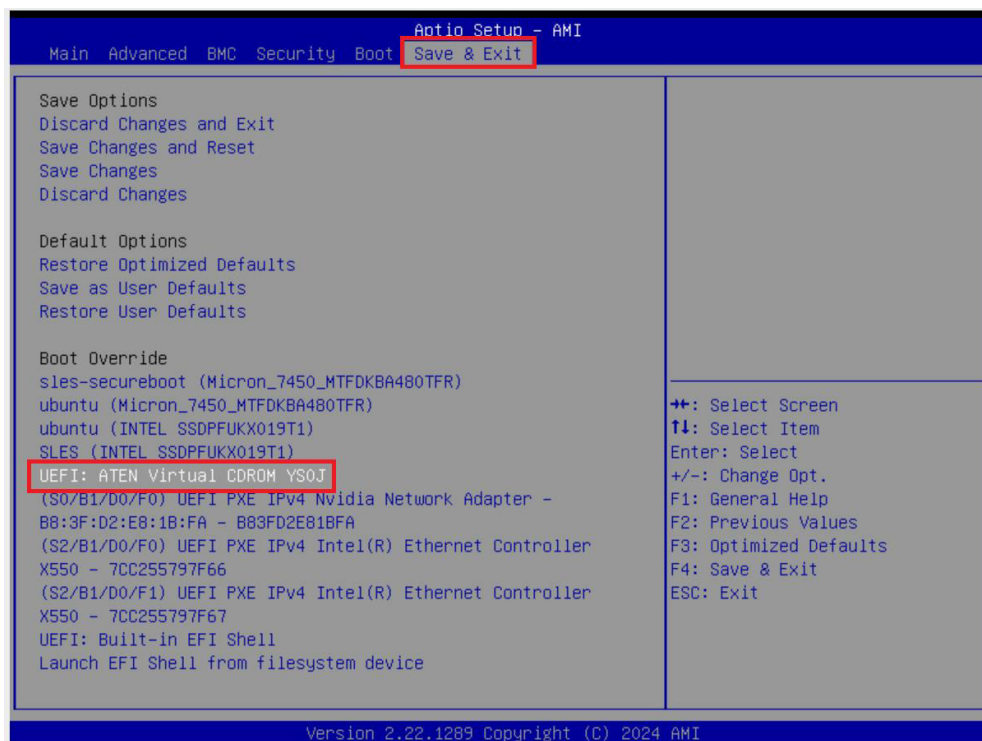

3. Follow the Ubuntu installer steps to continue installation. Choose "**Ubuntu Server with the HWE kernel**" to proceed.

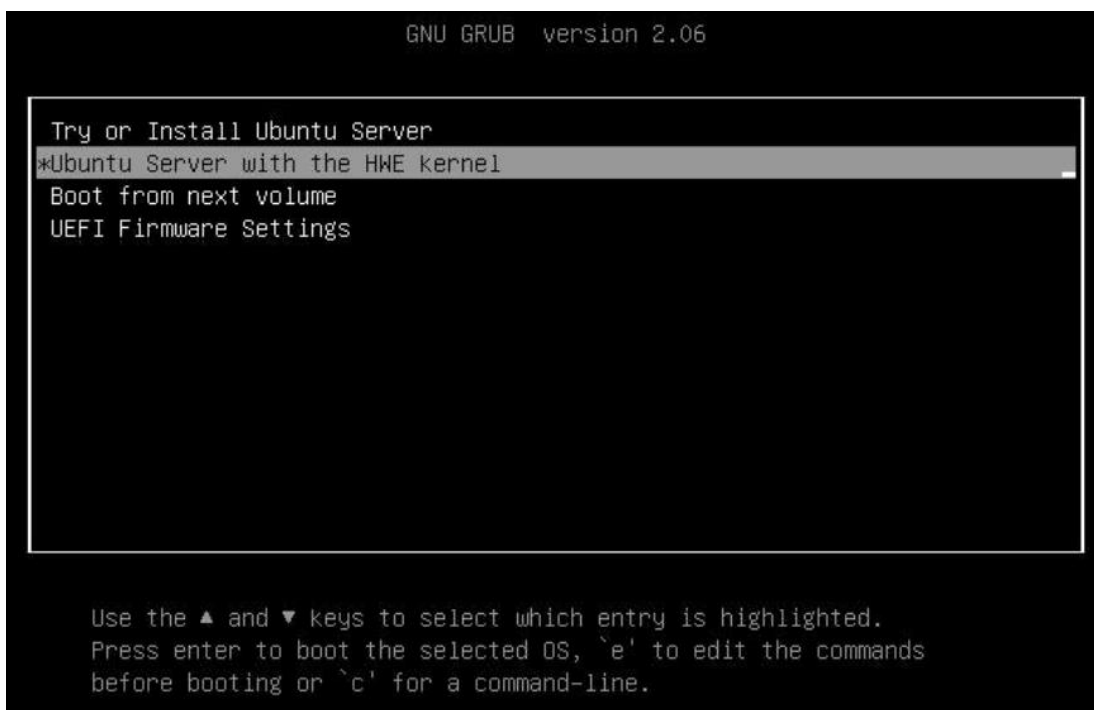

### Step 6. Installing Ubuntu 22.04 OS

1. In the Ubuntu installer, select the **language**.

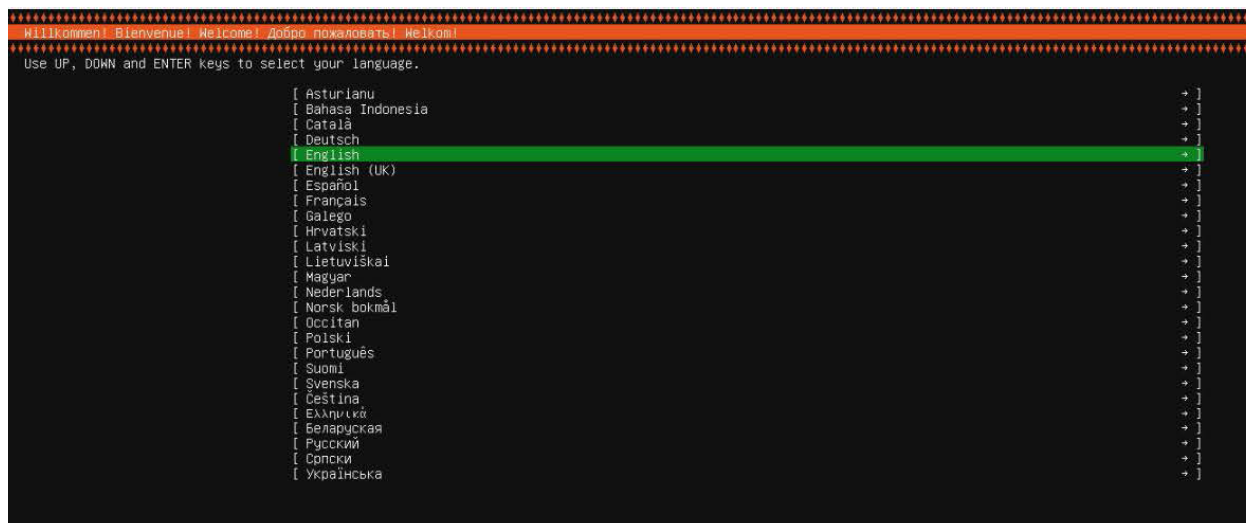

2. Configure the keyboard options.



3. Select **"Ubuntu Server"** as the base for the installation.

4. Configure the network connection to proceed. If an Ethernet network connection is available, proceed by selecting at least one network configuration option displayed on the installation UI.

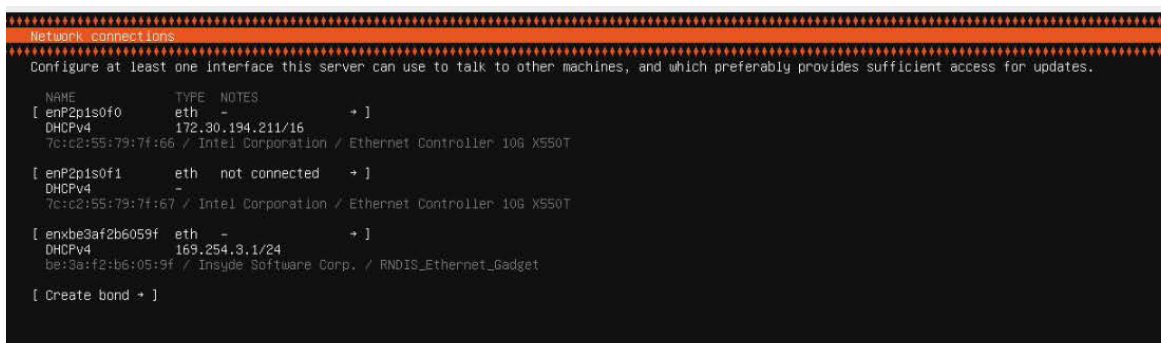

If Ethernet is disconnected during the installation process, proceed by selecting the **"Continue without network"** button.

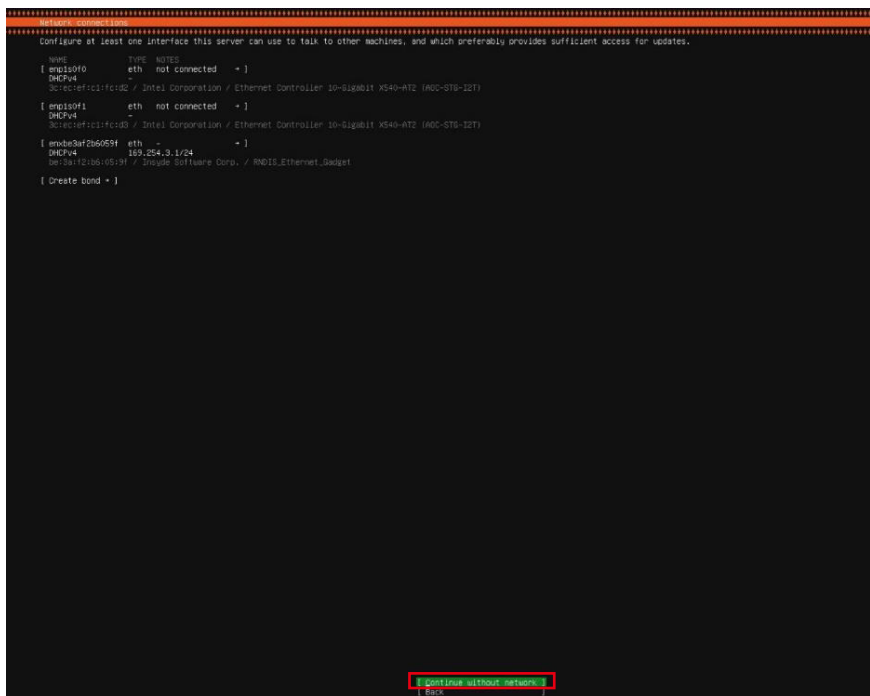

- Configure the Ubuntu archive mirror address and run the test. Proceed with the following message **"This mirror location passed tests."**

```

Configure Ubuntu archive mirror
-----
If you use an alternative mirror for Ubuntu, enter its details here.

Mirror address: https://ports.ubuntu.com/ubuntu-ports
                You may provide an archive mirror that will be used instead of the default.

This mirror location passed tests.

Get:1 http://ports.ubuntu.com/ubuntu-ports jammy InRelease [270 kB]
Get:2 http://ports.ubuntu.com/ubuntu-ports jammy-updates InRelease [119 kB]
Get:3 http://ports.ubuntu.com/ubuntu-ports jammy-backports InRelease [109 kB]
Error: Timeout was reached
       fetched 497 kB in 3s (149 kB/s)
       Reading package lists...

```

- If Ethernet is disconnected during the installation process, please proceed with the following message: **"The mirror location cannot be checked because no network has been**

```

Configure Ubuntu archive mirror
-----
If you use an alternative mirror for Ubuntu, enter its details here.

Mirror address: https://ports.ubuntu.com/ubuntu-ports
                You may provide an archive mirror that will be used instead of the default.

The mirror location cannot be checked because no network has been configured.

```

**configured."**

- Configure the storage layout.

```

guided storage configuration
-----
Configure a guided storage layout, or create a custom one:

( ) Use an entire disk
   [ INTEL_SSDPFUK019T1_PHY2010000R1P8G0L1 local disk 1,746T + ]
   [X] Set up this disk as an LVM group
       [ ] Encrypt the LVM group with LUKS
           Passphrase:
           Confirm passphrase:
       [ ] Also create a recovery key.
           The key will be stored as ~/recovery-key.txt in the live system and will be copied to /var/log/installer/ in the target system.

(X) Custom storage layout

```

- Set one of the drives as the boot device. You may choose either a hard disk or a USB drive as your boot device.

```
Storage configuration
-----
To continue you need to: Mount a filesystem at /
                        Select a boot disk

FILE SYSTEM SUMMARY

No disks or partitions mounted.

AVAILABLE DEVICES

DEVICE                                TYPE          SIZE
[ INTEL_SSDPFUKX019T1_PHAY3010000R1P9BGN_1    local disk    1.746T + ]
  partition 1 existing, unused ESP, already formatted as vfat    1.049G +
  partition 2 existing, already formatted as ext4, not mounted    1.700T +
[ Micron_7450_MTFDKBA480TFR_233242C34ACB_1    local disk    447.131G + ]
  free space                                     447.128G +

[ Create software RAID (md) + ]
[ Create volume group (LVM) + ]

USED DEVICES

No used devices
```

```
+ (close)
Info
Reformat
Format
Remove from RAID/LVM
Use As Boot Device
```

- Create GPT partitions from the free space in the disk. To continue installation, at least two partitions are required to proceed: one mount point at `/boot/efi` and the other mount point at `/`.

```
Storage configuration
-----
To continue you need to: Mount a filesystem at /

FILE SYSTEM SUMMARY

MOUNT_POINT  SIZE  TYPE  DEVICE TYPE
[ /boot/efi   1.049G  new fat32  new partition of local disk + ]

AVAILABLE DEVICES

DEVICE                                TYPE          SIZE
[ INTEL_SSDPFUKX019T1_PHAY3010000R1P9BGN_1    local disk    1.746T + ]
  partition 1 existing, unused ESP, already formatted as vfat    1.049G +
  partition 2 existing, already formatted as ext4, not mounted    1.700T +
[ Micron_7450_MTFDKBA480TFR_233242C34ACB_1    local disk    447.131G + ]
  free space                                     446.079G +

[ Create software RAID (md) + ]
[ Create volume group (LVM) + ]

USED DEVICES

DEVICE                                TYPE          SIZE
[ Micron_7450_MTFDKBA480TFR_233242C34ACB_1    local disk    447.131G + ]
  partition 1 new, primary ESP, to be formatted as fat32, mounted at /boot/efi    1.049G +
```

```
+ (close)
Add GPT Partition
```

9. Select the size, format, and mount point when adding GPT partition to the boot disk.

```

Storage configuration [ Help ]
-----
To continue you need to: Mount a filesystem at /

FILE SYSTEM SUMMARY

MOUNT POINT      SIZE  TYPE      DEVICE TYPE
[ /boot/efi      1.049G new fat32 new partition of local disk + ]

AVAILABLE DEVICES

DEVICE                                     TYPE      SIZE
[ INTEL_SSDPFUKX019T1_PHAY3010000R1P9BGN_1  local disk 1.746T + ]
partition 1 existing, unused ESP, already formatted as vfat 1.049G +
partition 2 existing, already formatted as ext4, not mounted 1.700T +

[ Micron_74 free spac + ]
[ Create so + ]
[ Create vo + ]

USED DEVICE

DEVICE                                     TYPE      SIZE
[ Micron_74 partition + ]

Adding GPT partition to Micron_7450_MTFDKBA480TFR_233242C34ACB_1 + ]
Size (max 446.079G): 48G + ]
Format: [ ext4 + ]
Mount: [ / + ]

[ Create ]
[ Cancel ]

```

```

Storage configuration [ Help ]
-----
FILE SYSTEM SUMMARY

MOUNT POINT      SIZE  TYPE      DEVICE TYPE
[ /              48.000G new ext4  new partition of local disk + ]
[ /boot/efi      1.049G new fat32 new partition of local disk + ]

AVAILABLE DEVICES

DEVICE                                     TYPE      SIZE
[ INTEL_SSDPFUKX019T1_PHAY3010000R1P9BGN_1  local disk 1.746T + ]
partition 1 existing, unused ESP, already formatted as vfat 1.049G +
partition 2 existing, already formatted as ext4, not mounted 1.700T +

[ Micron_7450_MTFDKBA480TFR_233242C34ACB_1  local disk 447.131G + ]
free space 398.079G +

[ Create software RAID (md) + ]
[ Create volume group (LVM) + ]

USED DEVICES

DEVICE                                     TYPE      SIZE
[ Micron_7450_MTFDKBA480TFR_233242C34ACB_1  local disk 447.131G + ]
partition 1 new, primary ESP, to be formatted as fat32, mounted at /boot/efi 1.049G +
partition 2 new, to be formatted as ext4, mounted at / 48.000G +

[ Done ]
[ Back ]

```

## 10. Create the profile name, server name, username, and password.



## 11. Wait until the installation is complete and reboot the system.

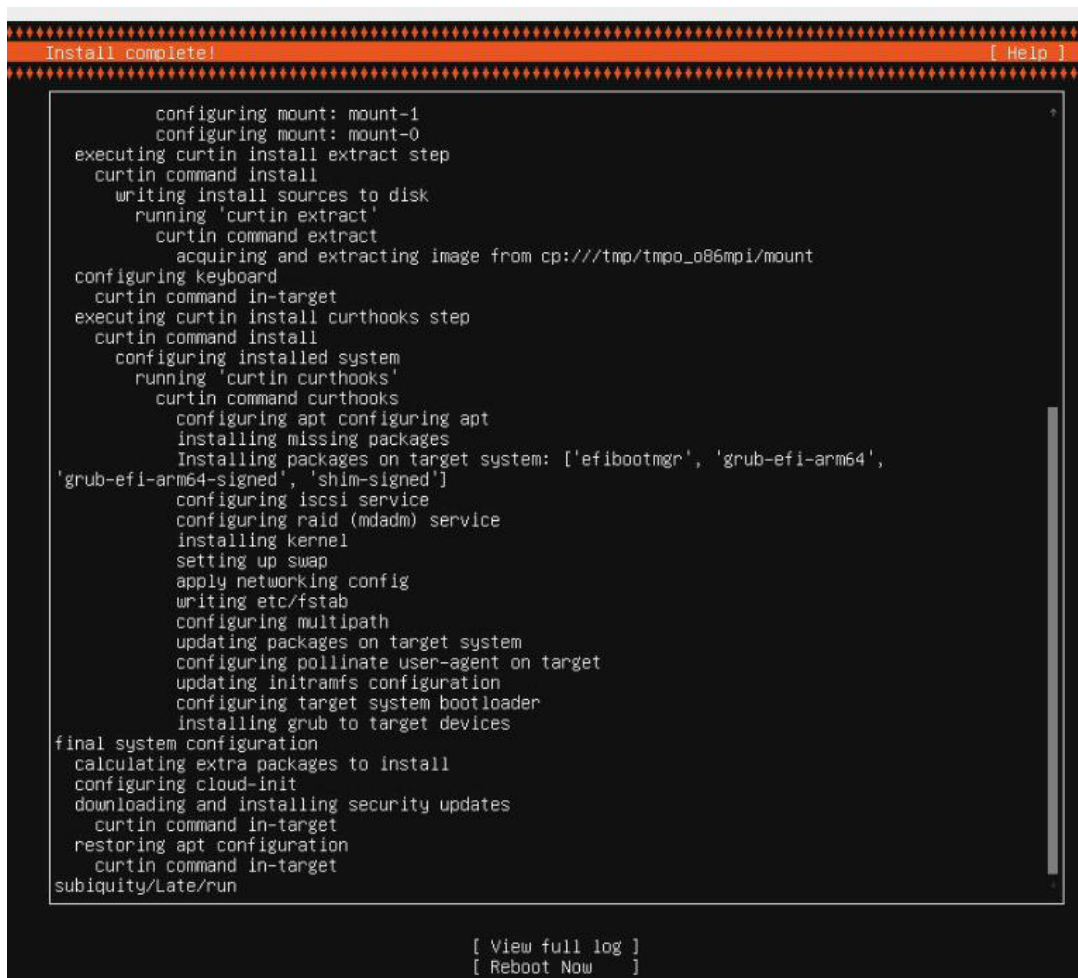

12. Enter username and password to log in.

```
Ubuntu 22.04.4 LTS cg1-server001 tty1
cg1-server001 login: _
```

Log in successfully.

```
Ubuntu 22.04.4 LTS cg1-server001 tty1
cg1-server001 login: pm002
Password:
Welcome to Ubuntu 22.04.4 LTS (GNU/Linux 5.15.0-101-generic aarch64)

* Documentation:  https://help.ubuntu.com
* Management:    https://landscape.canonical.com
* Support:        https://ubuntu.com/pro

System information as of Thu Mar 21 10:03:16 PM UTC 2024

System load:                0.06494140625
Usage of /:                  23.4% of 46.95GB
Memory usage:                0%
Swap usage:                  0%
Temperature:                 56.0 C
Processes:                   764
Users logged in:             0
IPv4 address for enP2p1s0f0: 172.30.181.251
IPv6 address for enP2p1s0f0: 2001:db8::7ec2:55ff:fe79:7f66

Expanded Security Maintenance for Applications is not enabled.

11 updates can be applied immediately.
To see these additional updates run: apt list --upgradable

Enable ESM Apps to receive additional future security updates.
See https://ubuntu.com/esm or run: sudo pro status

The programs included with the Ubuntu system are free software;
the exact distribution terms for each program are described in the
individual files in /usr/share/doc/*/copyright.

Ubuntu comes with ABSOLUTELY NO WARRANTY, to the extent permitted by
applicable law.

To run a command as administrator (user "root"), use "sudo <command>".
See "man sudo_root" for details.

pm002@cg1-server001:~$ _
```

## 5.2 Red Hat Enterprise Linux (RHEL) 9.3 ISO Installation

### Prerequisites

Obtain RHEL 9.3 ISO for the ARM image (aarch64) and save it to your local disk or a shared server. It's recommended to use the RHEL 9.3 AArch64 DVD ISO image file. Please refer to [Downloading a RHEL installation ISO image](#) for the ISO packages.

### Installing RHEL 9.3 OS

#### *Step 1. Obtaining BMC IP Address*

Connect the system to a monitor or display using a Mini DisplayPort (Mini DP) or a Mini DisplayPort-to-DisplayPort (DP) adapter. Ensure that the network is connected to the BMC using a network cable and power on the system. The BMC IP address will appear on the right corner of the Supermicro Logo screen.



#### *Step 2. Accessing the BMC Remote Server*

##### *Log in to the BMC Remote Server*

1. In the terminal, execute a ping command to the BMC IP address, such as 172.30.195.94, to verify its connectivity.

2. Launch a new web browser and input the BMC IP address into the URL field.

**Outcome:** The BMC Remote Console login screen will be displayed.

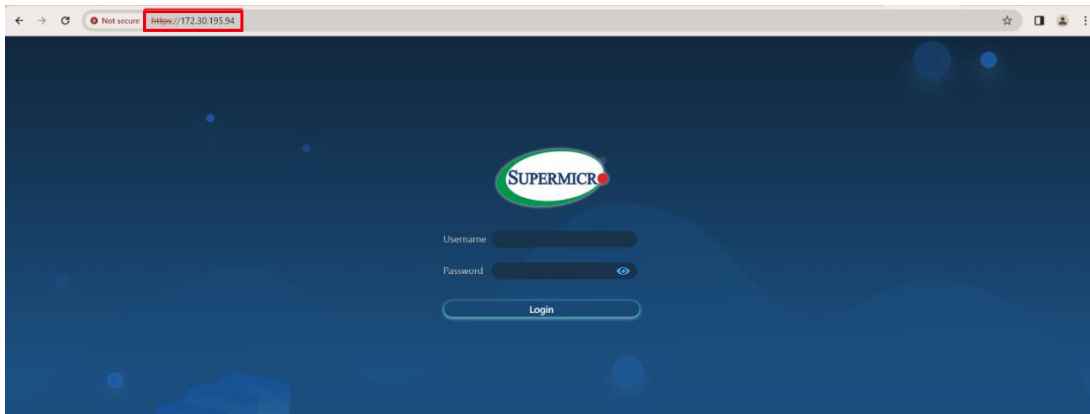

3. Input the username "**ADMIN**" and the unique BMC password, which is located on the label on the opposite side of the service tag of the system. Click the "**Login**" to proceed.

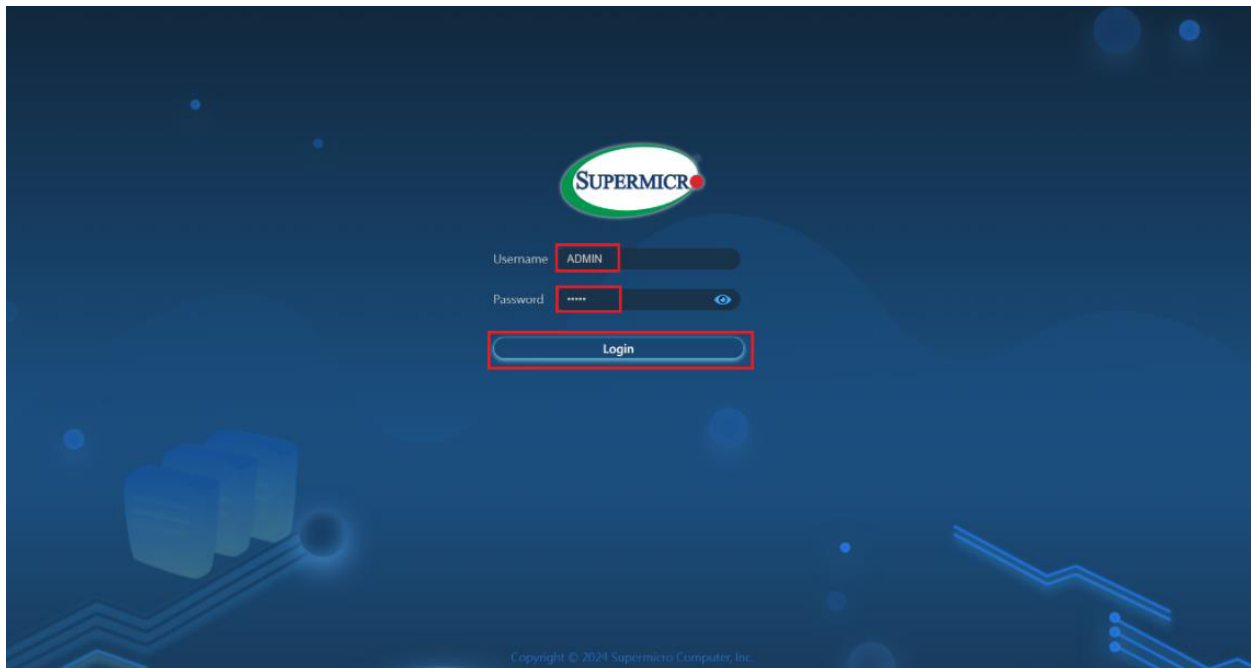

**Outcome:** The BMC Dashboard offers insights into system overview, configuration, health status, and maintenance.

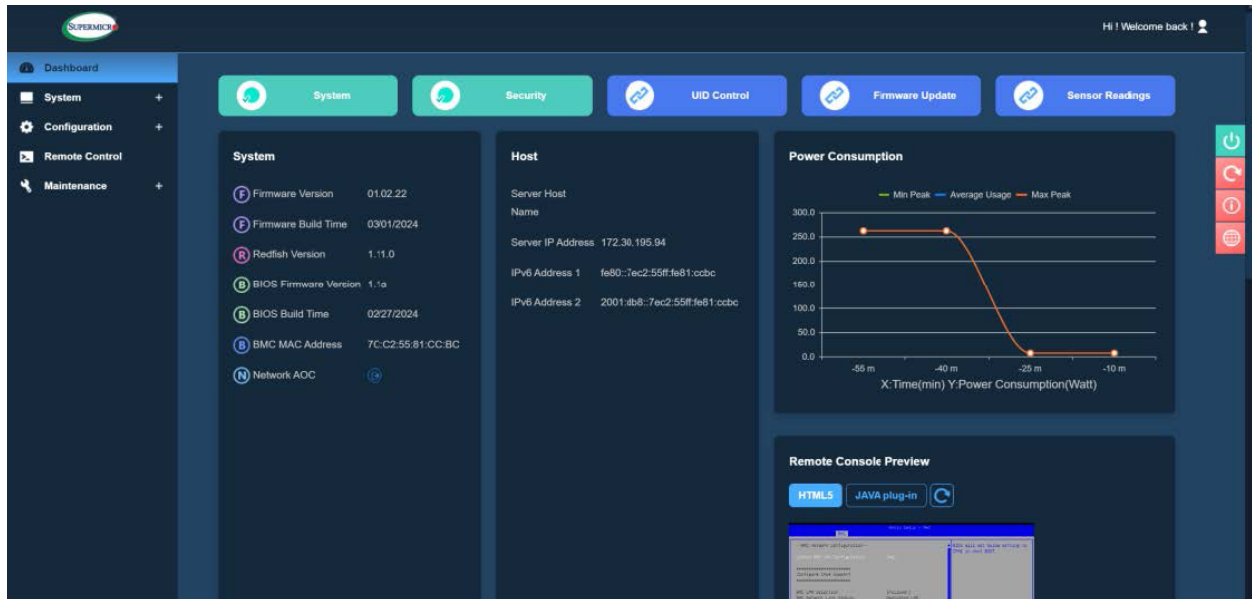

### Step 3. Controlling the BMC Remotely

1. The Remote Control menu in the BMC Remote Server enables remote server operations.

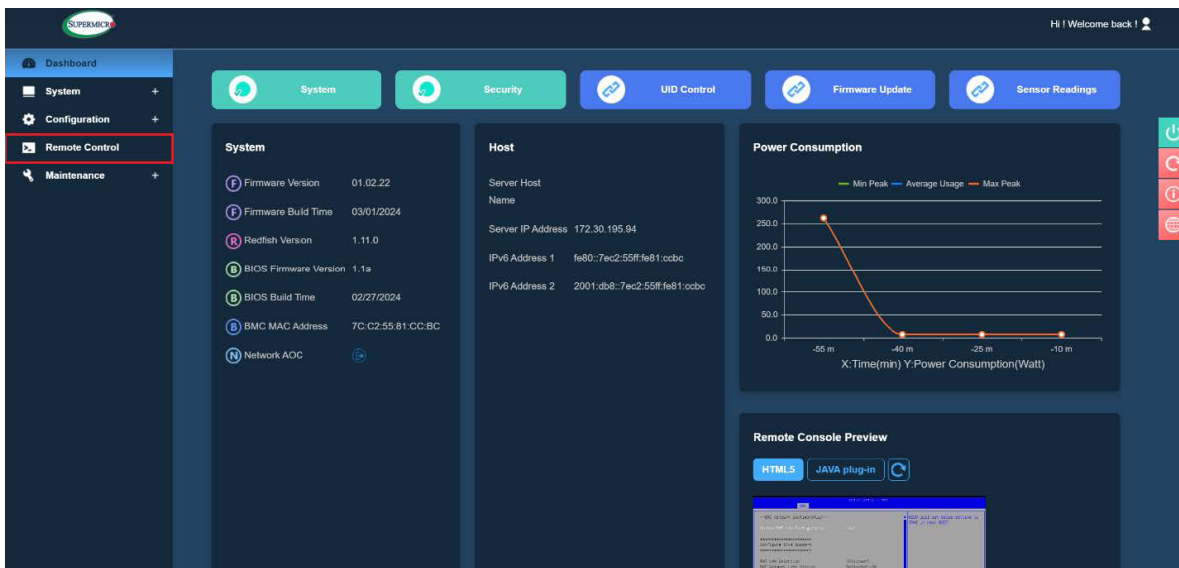

- Use the Launch Console section to configure the remote console interface settings. Choose between the HTML5 interface or a JAVA plug-in.

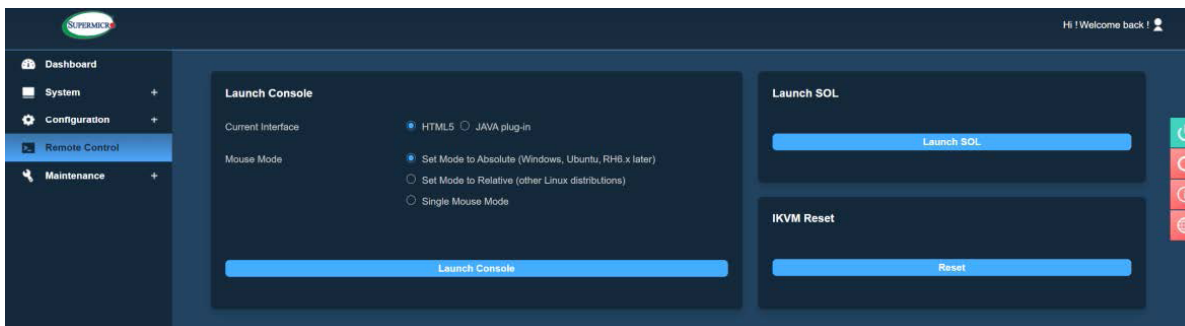

### *Launch an HTML5 Remote Browser*

- Set HTML5 as the current interface.
- Choose the mouse mode according to your operating system, such as "**Set Mode to Absolute (Windows, Ubuntu, RH6.x, or later).**"
- Click the "**Launch Console**" button to open a console in a new browser window.

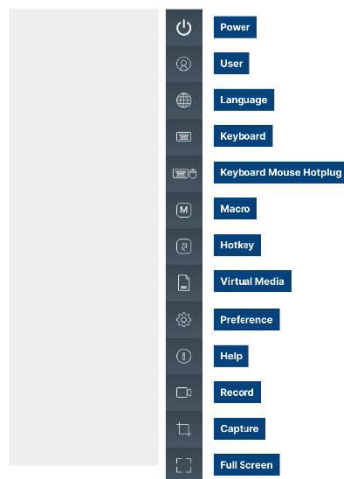
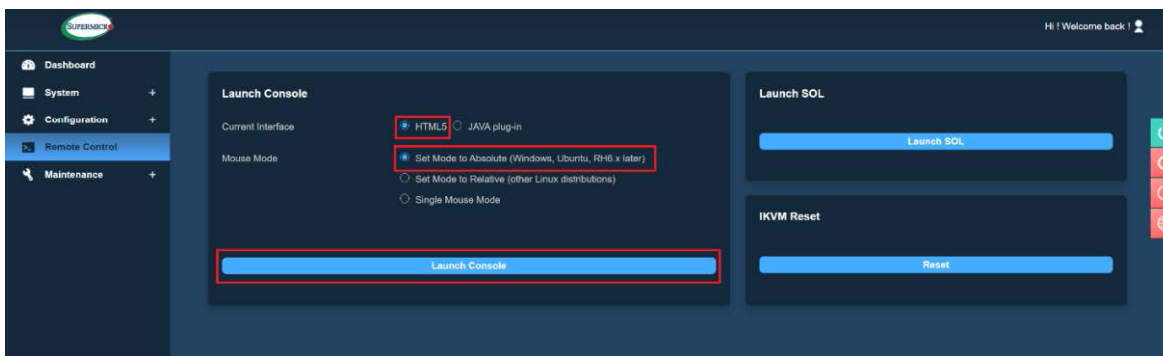

## Step 4. Mounting the ISO image

There are two methods to mount ISO images. If the ISO files are stored locally on your disk, you can mount them directly within the remote control browser. Alternatively, if the ISO files are located on a shared server, you can mount them via the Configuration > Virtual Media menu.

### *Method 1: Mount the ISO Image Using a Local File*

1. In the remote control browser, click the **"Virtual Media"** icon. This action will prompt a dialogue box to appear, enabling you to select the image type and files for mounting.

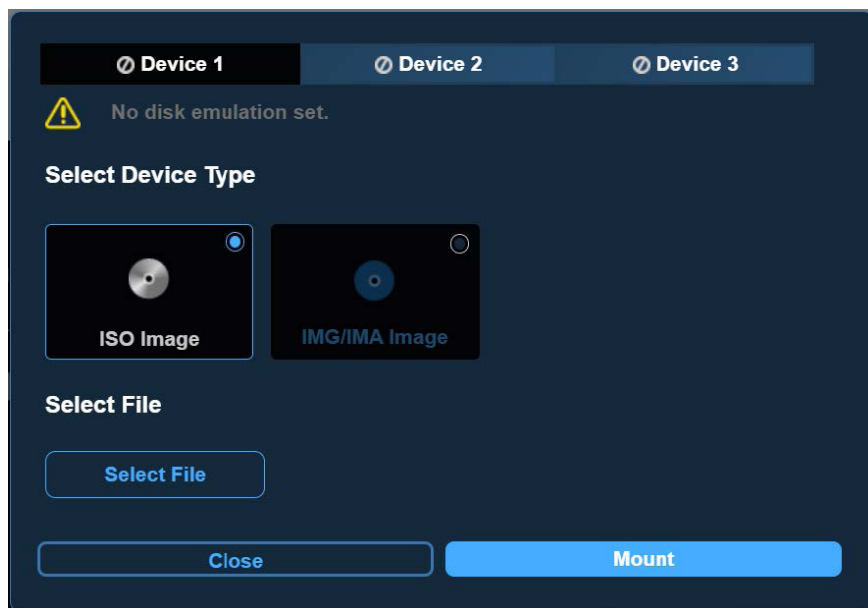
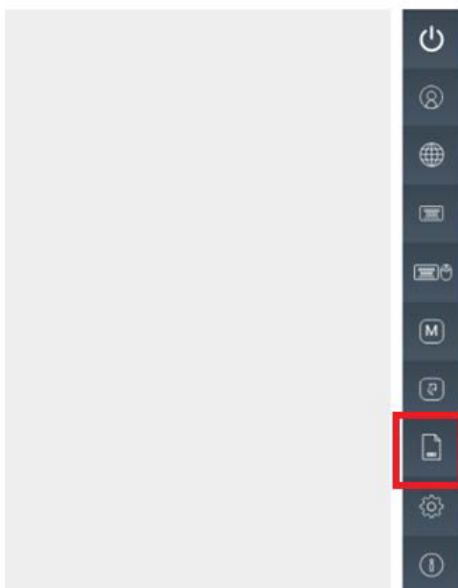

2. Select the **"Choose File"** button to browse and select the RHEL ISO image on your local disk for use.

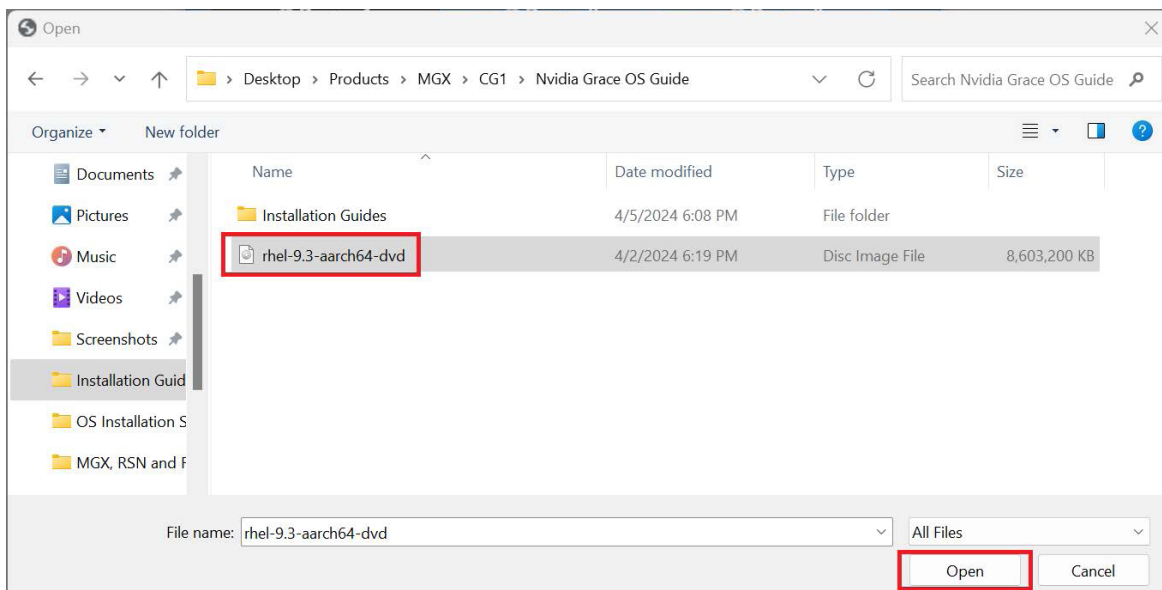
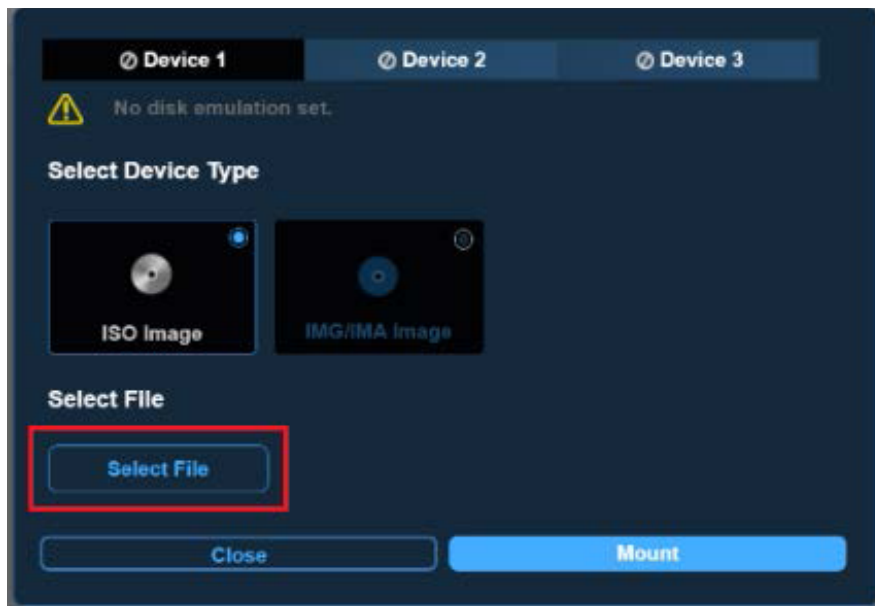

3. Click the **"Mount"** button to attach the chosen ISO image.

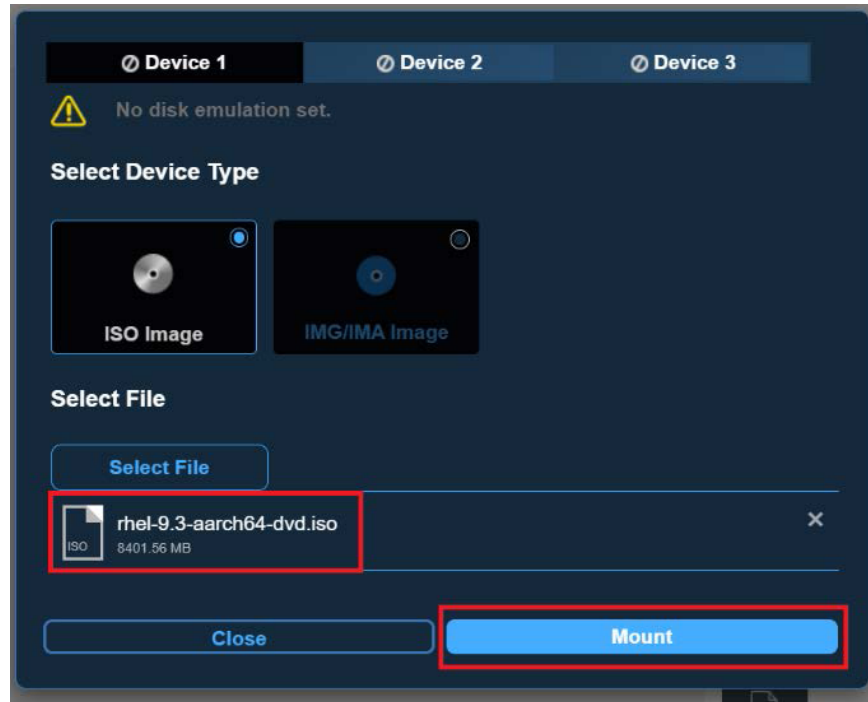

**Result:** Upon successful mounting of the ISO image, a green indicator will appear in the "Device" tab. Close the dialogue to continue.

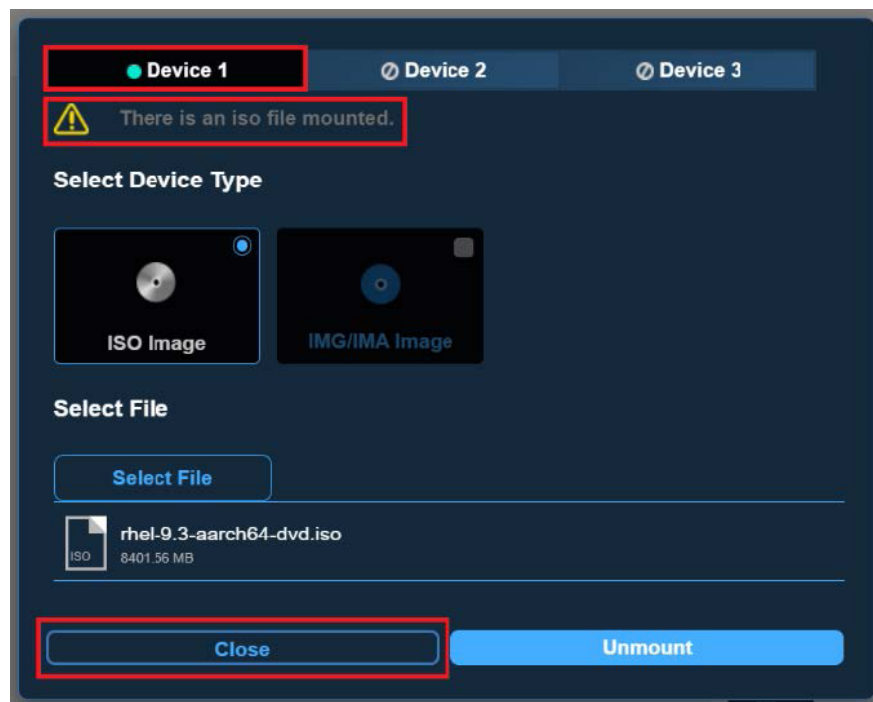

## Method 2: Mount the ISO Image through a Shared Server

1. On the BMC dashboard, go to Configuration > Virtual Media. This allows you to attach an ISO image from the server.

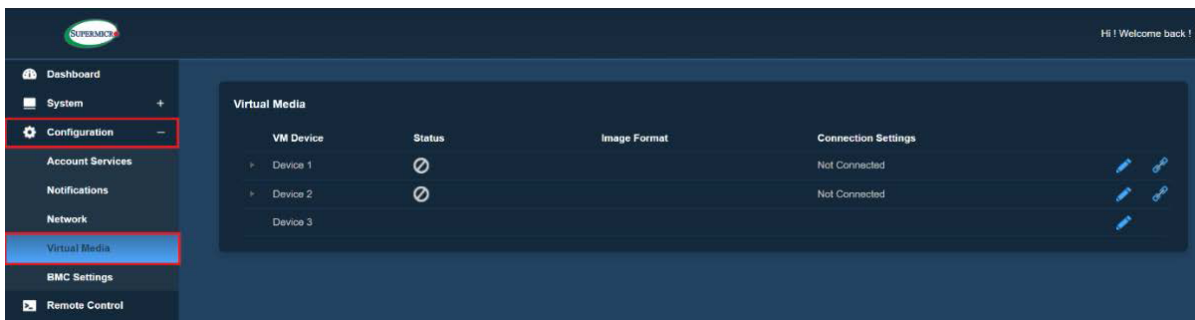

2. Click the "Edit" icon to adjust the VM configuration. Enter the server host address and the path to the ISO image. Then, click the "Save" to apply the changes.

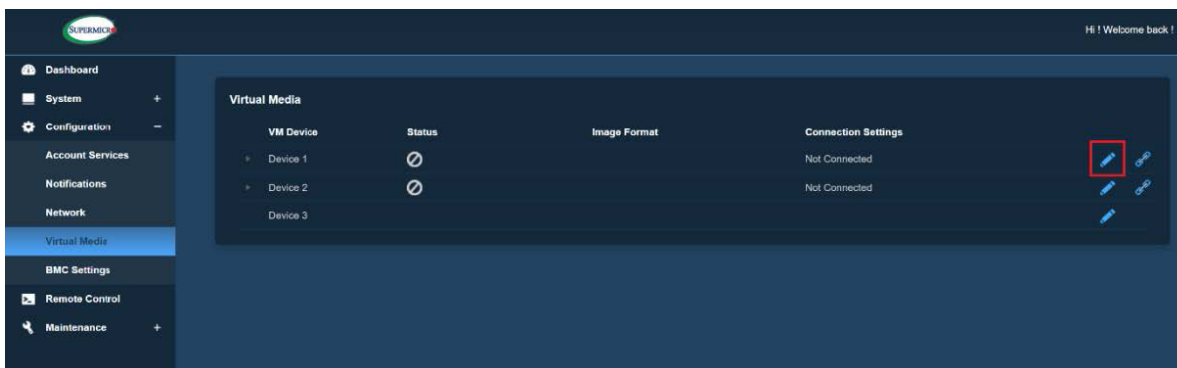

### Edit VM Connection

Share Host \*

Verify the certification of the server

Accept the self-signed certificates

Path to Image \*

Users

Password

- Click the **"Connect"** icon to mount the virtual media.

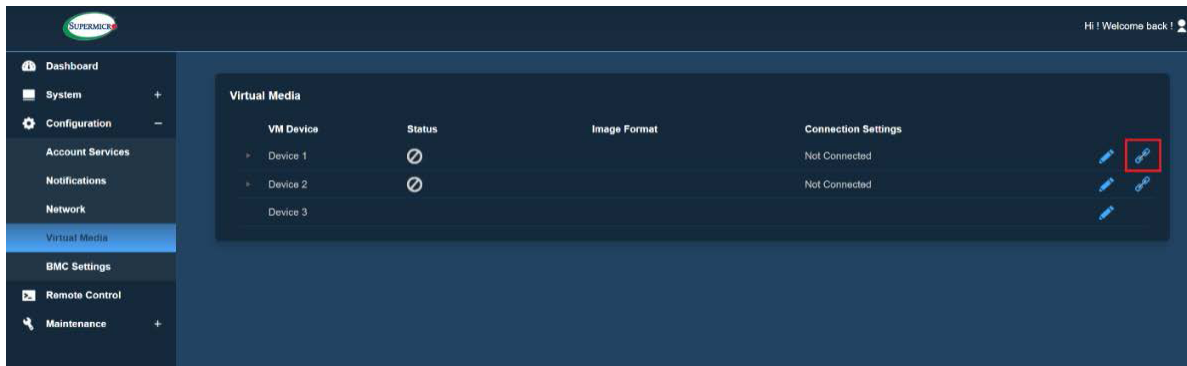

- The device status will display as green once the VM is successfully configured.

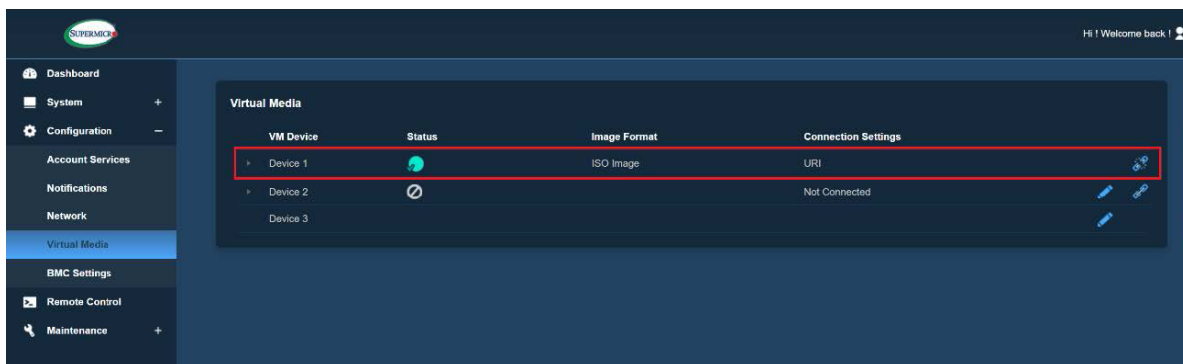

## Step 5. Setting Boot Override in UEFI BIOS

To configure the boot option from the mounted image in virtual media, users must manually adjust the boot settings in the BIOS setup.

- Power on the system and wait for the Log screen to display. To access the BIOS setup menu, repeatedly press **<DEL>** until **"Entering Setup..."** appears at the bottom left corner of the screen.



Subsequently, the UEFI BIOS screen is displayed.



2. Navigate to the **"Save & Exit"** menu using the arrow keys, then select **"UEFI: ATEN Virtual CDROM YSOJ"** as the boot option. This selection presents the ISO image mounted in Virtual Media. Hit **"Enter"** to proceed.

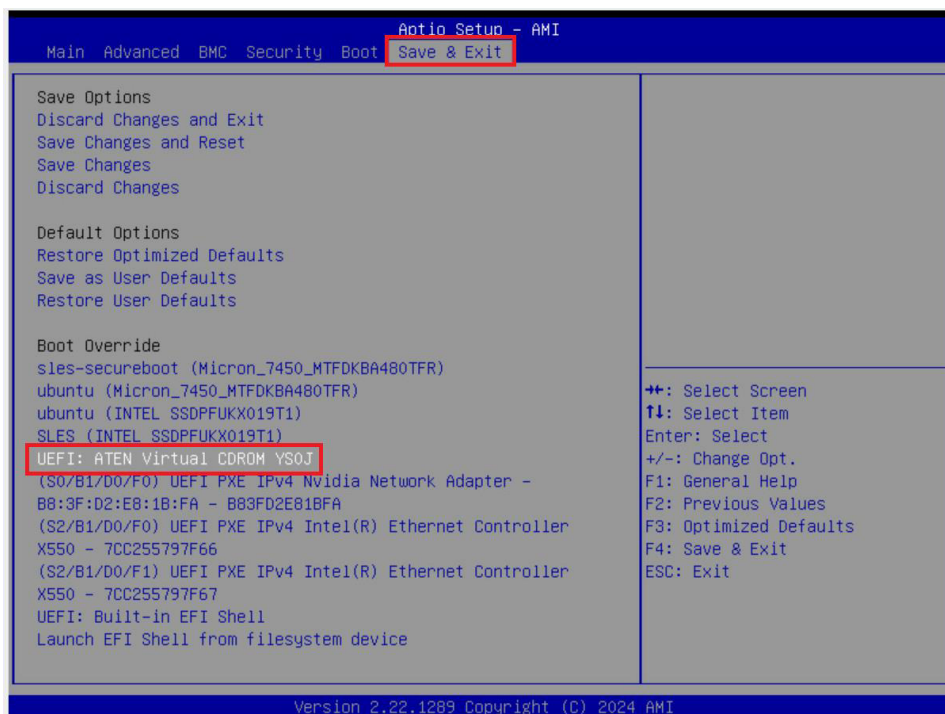

3. Follow the RHEL installer steps to continue installation. Choose "Install Red Hat Enterprise Linux 9.3" to proceed.

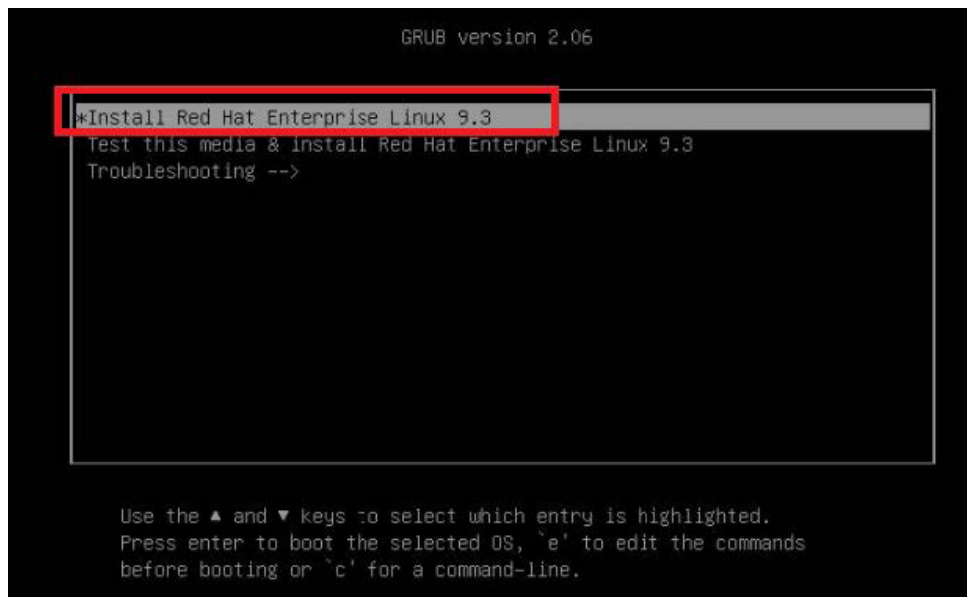

## Step 6. Installing RHEL 9.3 OS

1. In the RHEL installer, select the language.

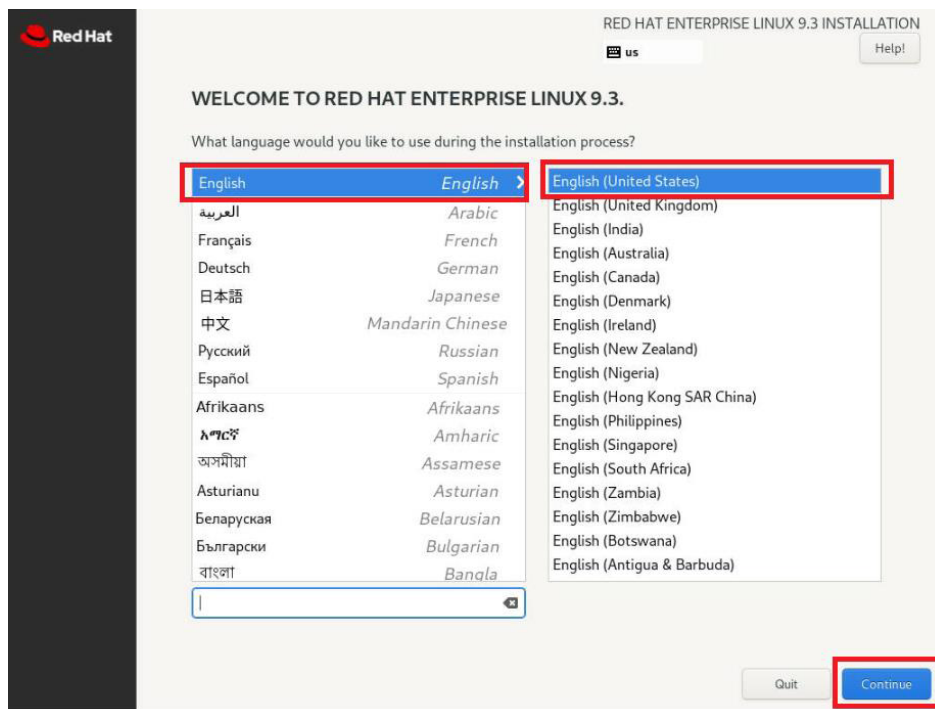

- The Installation Summary window provides a glance of the configuration you need before you begin the installation.

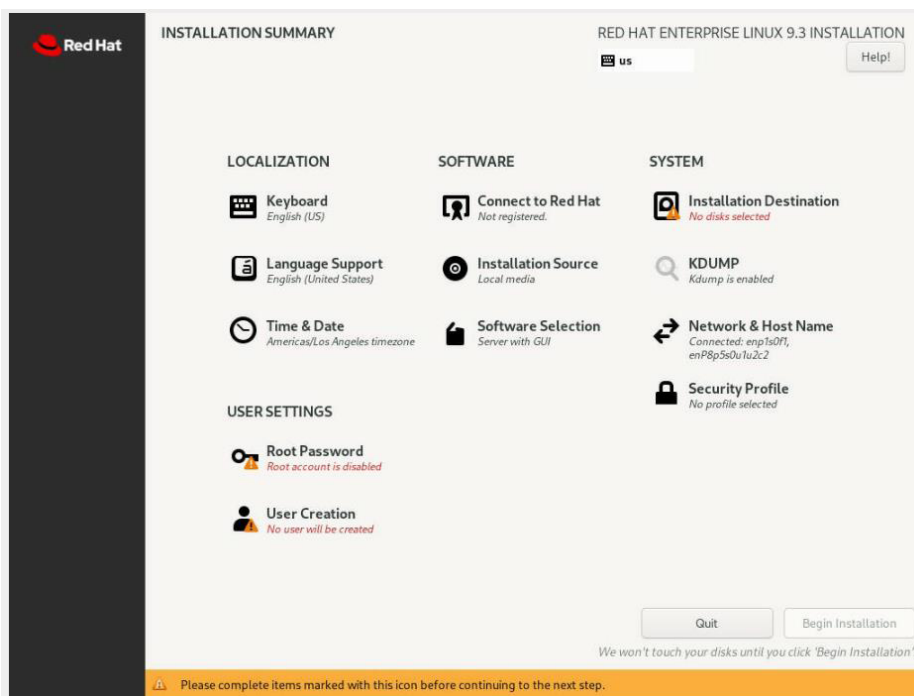

- Click the "Installation Destination" button to select the storage disk.

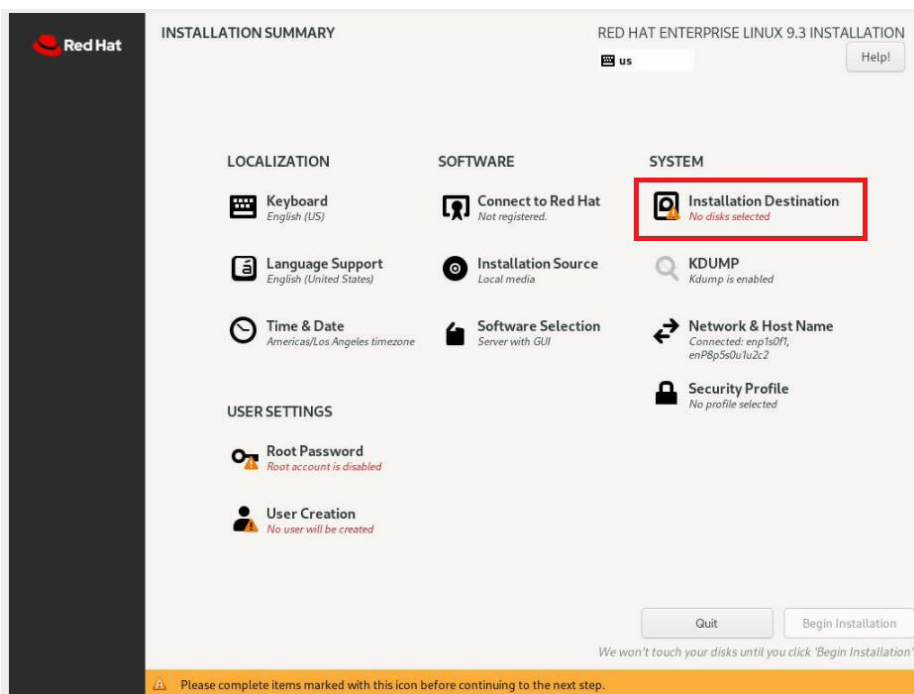

4. Select the disk to which you want to install the RHEL OS.

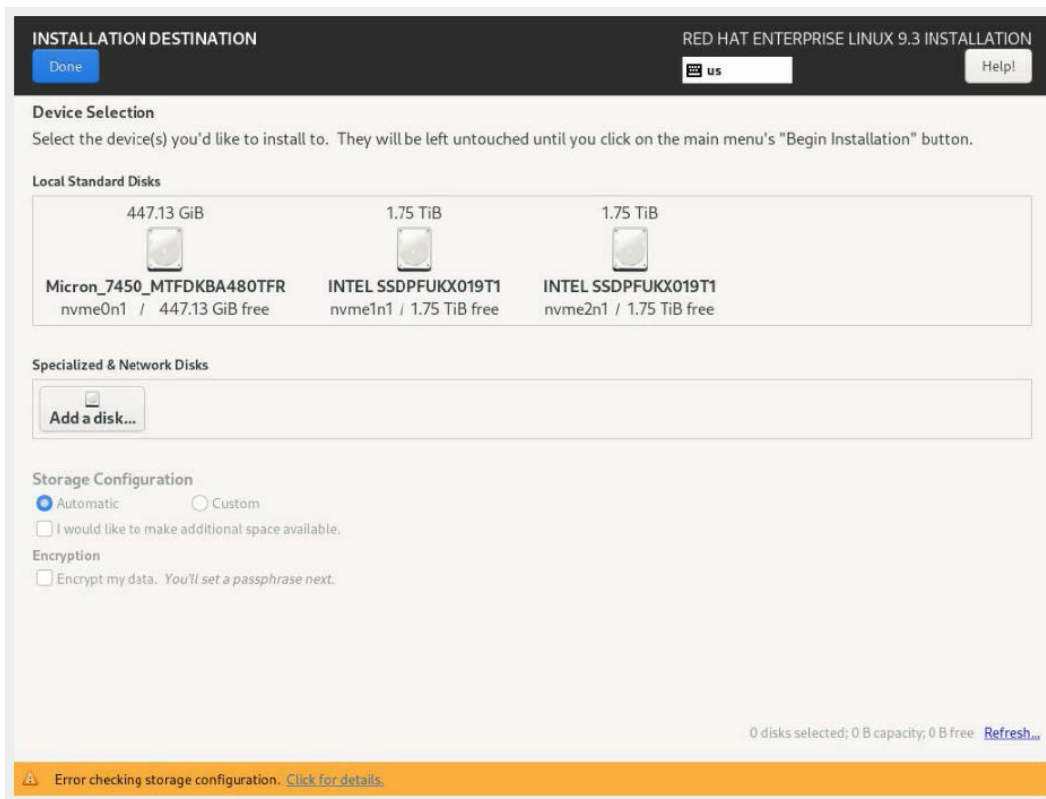

5. Select one of the disks and select "Custom" if you want to customize the volume of the disk.

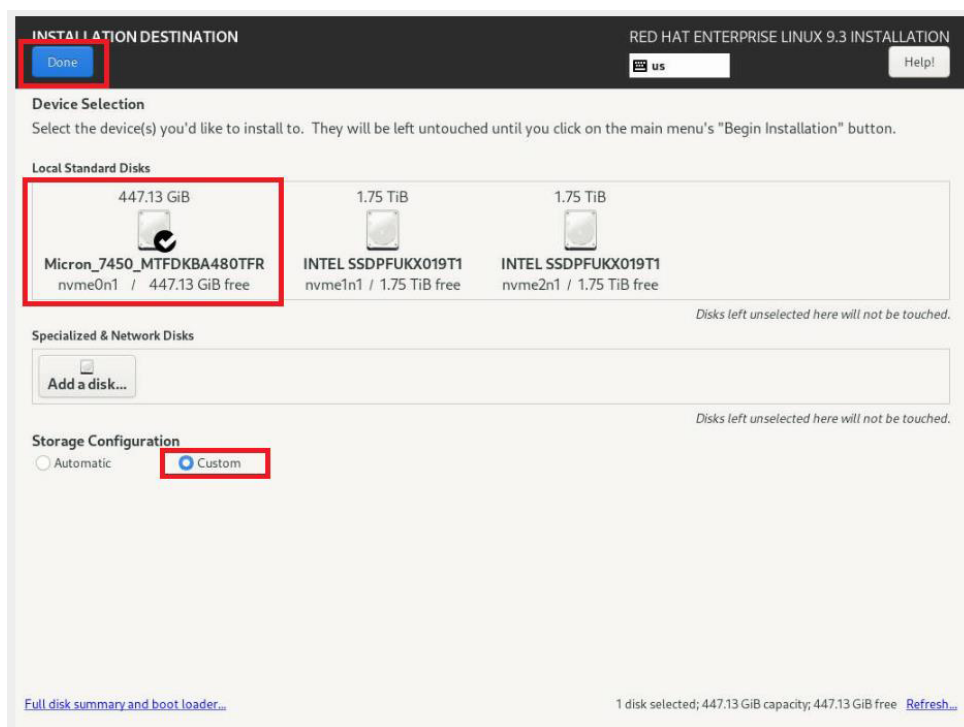

It will show you the space of the disk you selected.

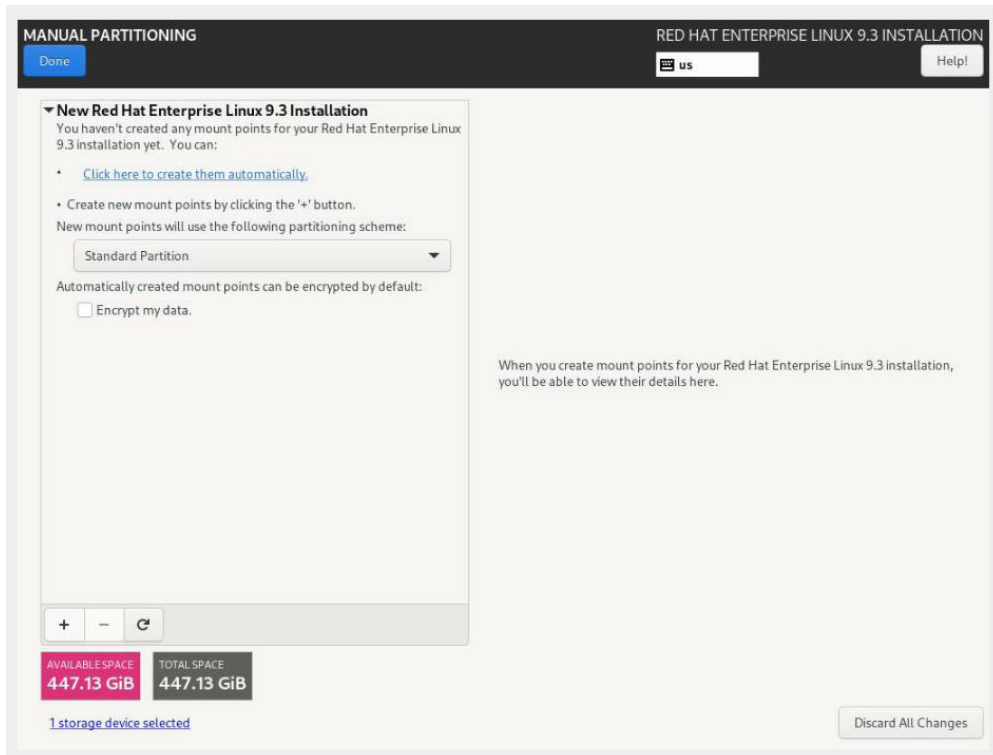

6. For RHEL, you need to have at least three mount points (`/boot/efi`, `/`, and `swap`). Click the "+" button to create new mount point `"/boot/efi"` as the boot partition for EFI system.

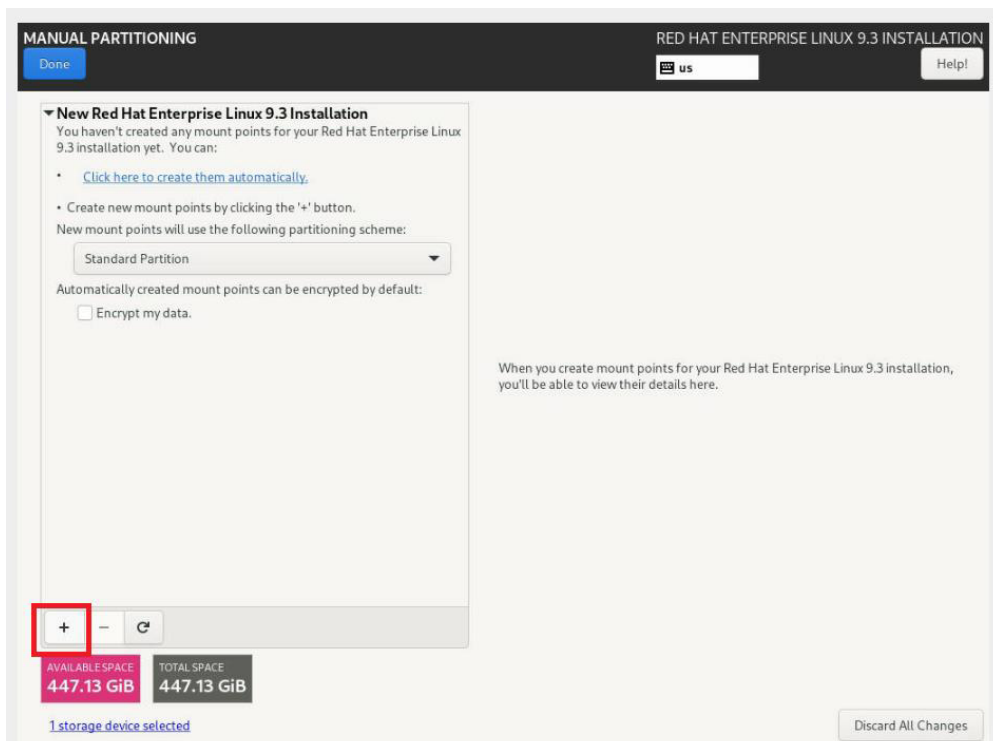

7. The "Add a new mount point" dialogue will pop up. Select the mount point `/boot/efi` and the storage size. Then, click the "Add mount point" button.

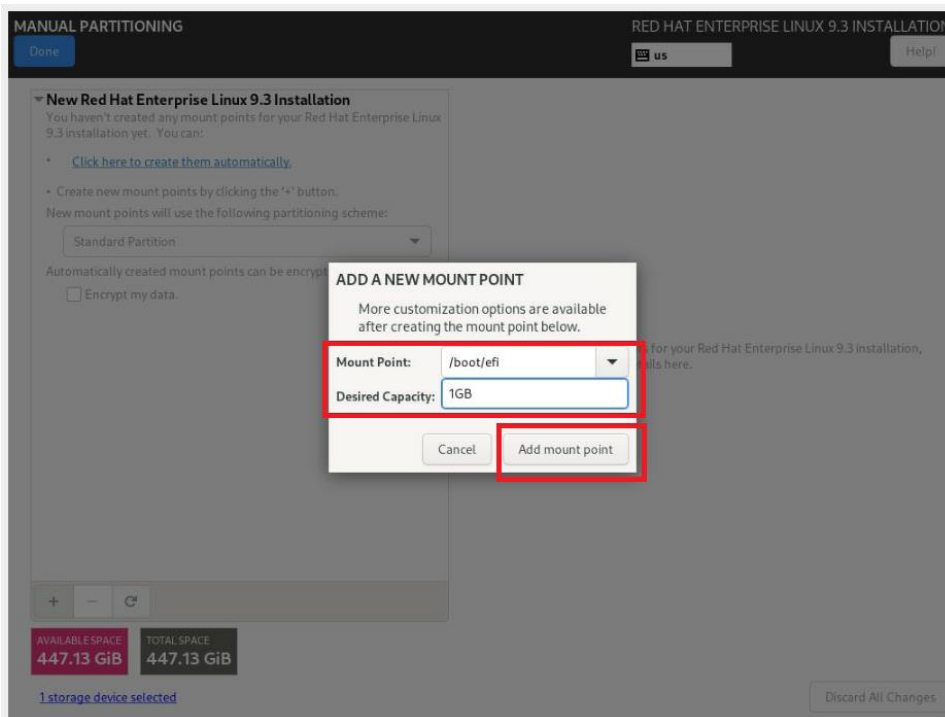

**Result:** The new mount point `/boot/efi` will be added under the "New Red Hat Enterprise Linux 9.3 Installation".

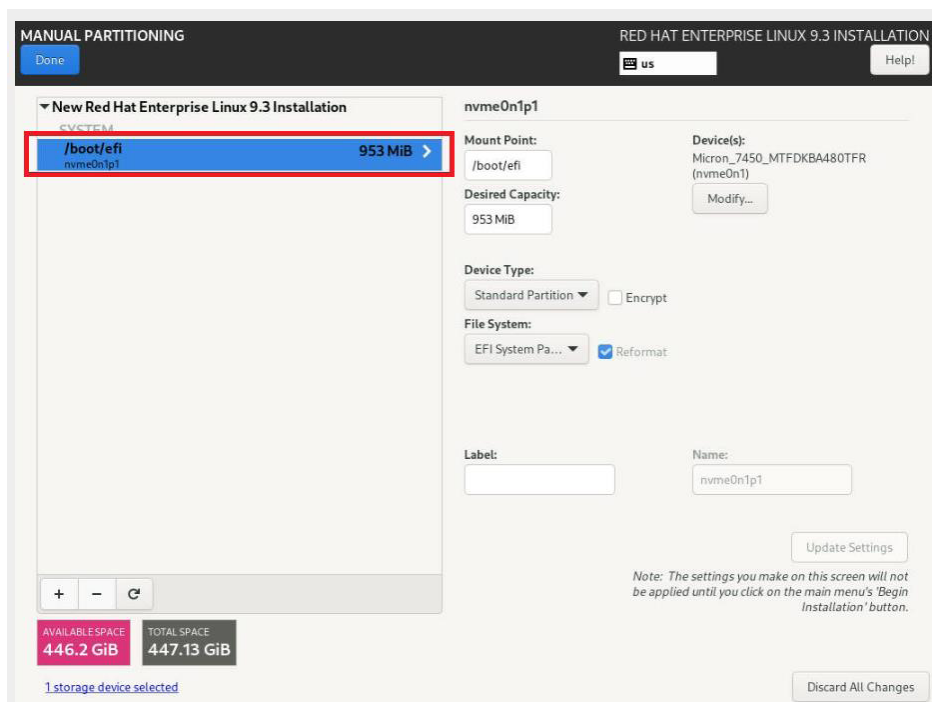

- Click the "+" button to create another new mount point "/" as the root directory. Configure the mount point "/" and the desired storage size. Then, click the "Add mount point" button.

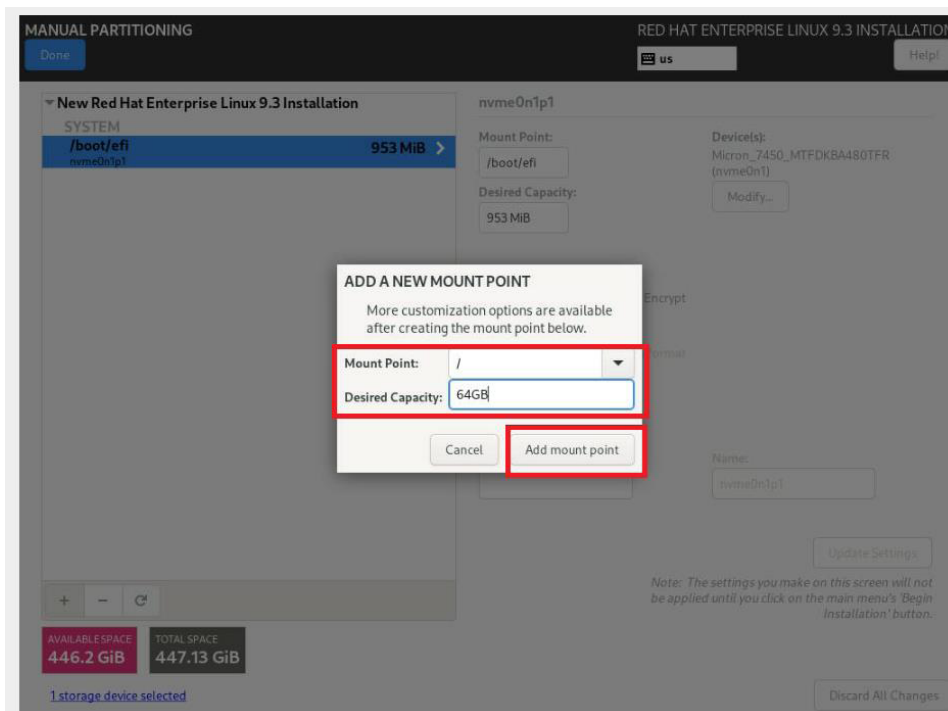

**Result:** The new mount point "/" will be added under the "New Red Hat Enterprise Linux 9.3 Installation".

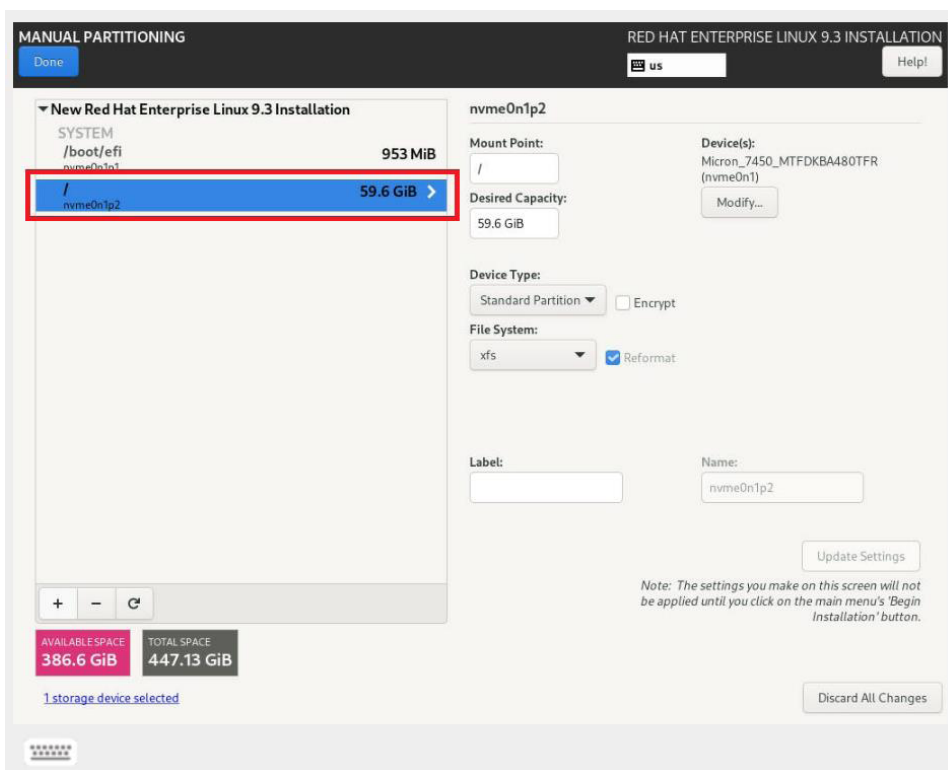

- Click the "+" button to create another new mount point **"swap"** for virtual memory space. Configure the mount point **"swap"** and the desired storage size. Then, click the **"Add mount point"** button.

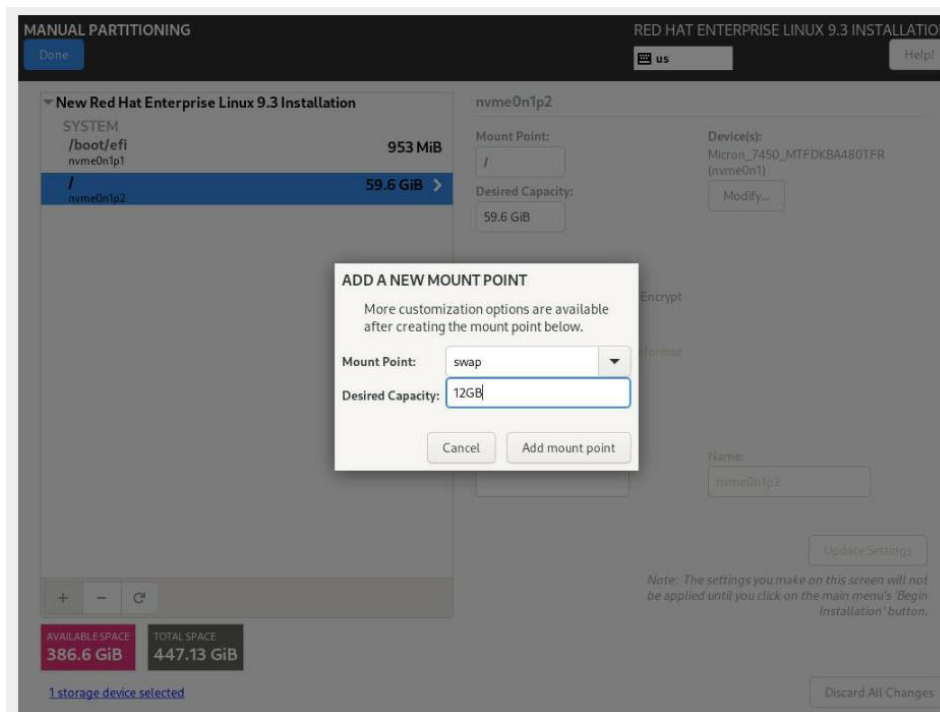

**Result:** The new mount point **"swap"** will be added under the **"New Red Hat Enterprise Linux 9.3 Installation"**.

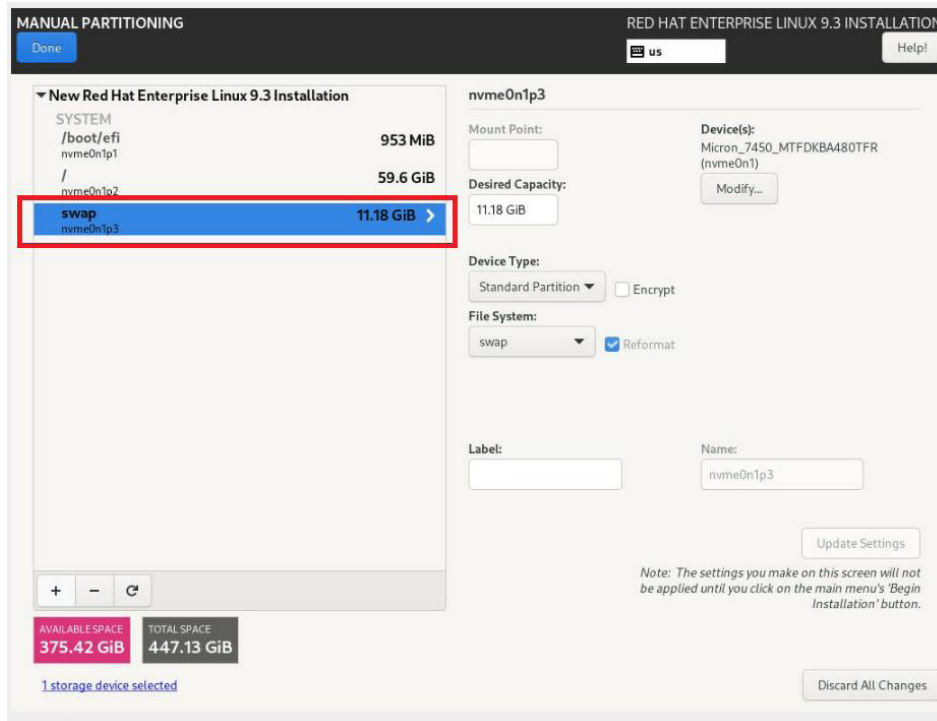

10. Click the **"Done"** button at the left top corner after all the required partitions are created.

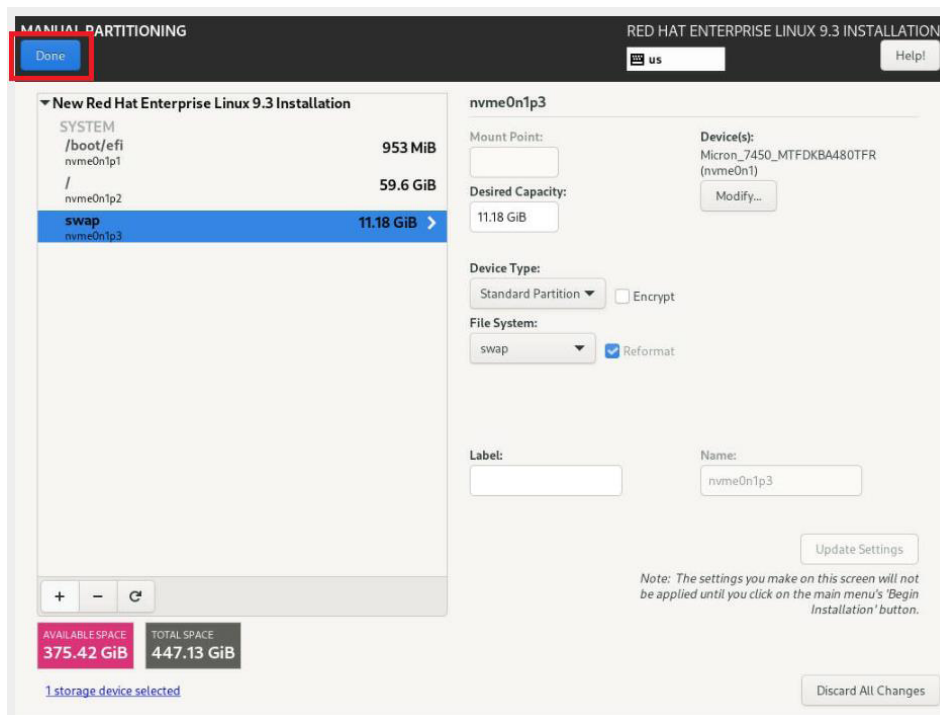

11. Accept the changes for customize partitions.

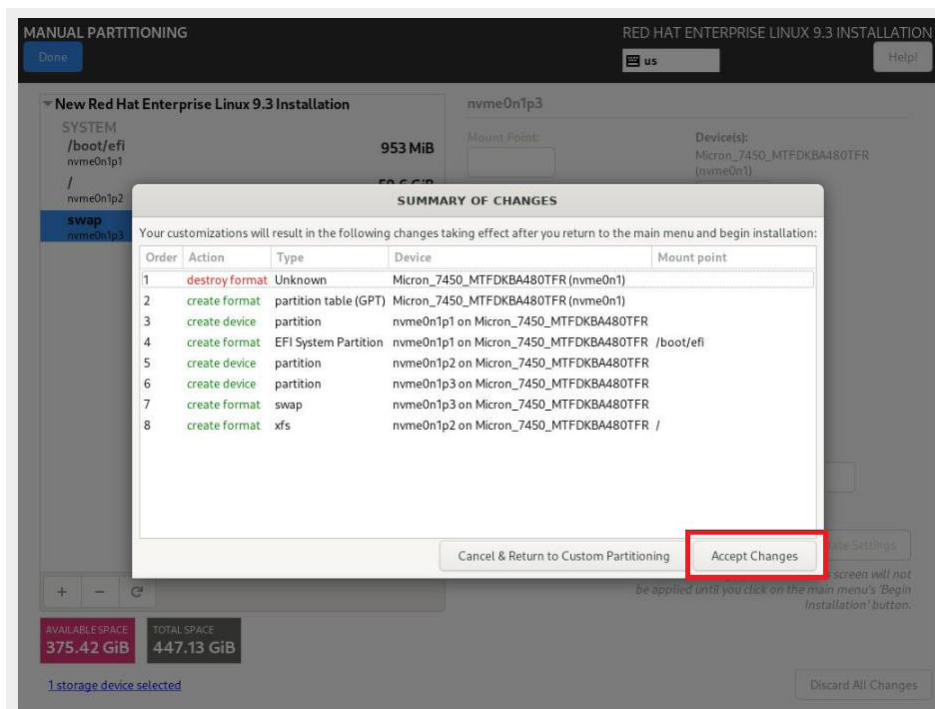

**Result:** In the "Installation Summary" screen, Installation Destination has been updated to "Custom partitioning selected."

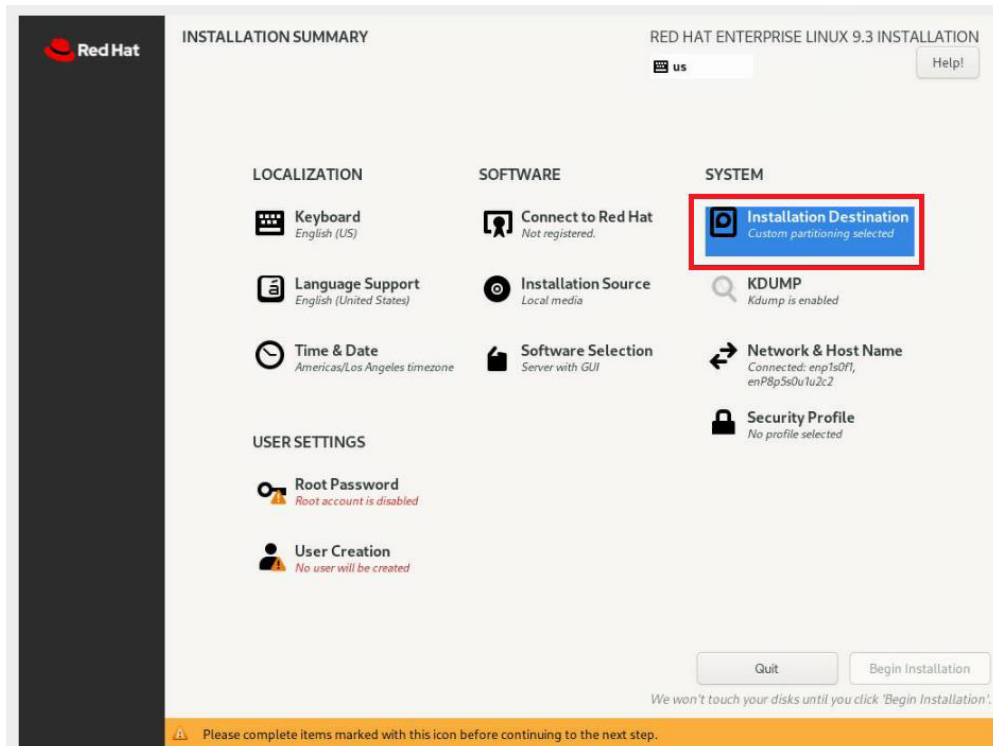

12. Click the "Root Password" in the "Installation Summary".

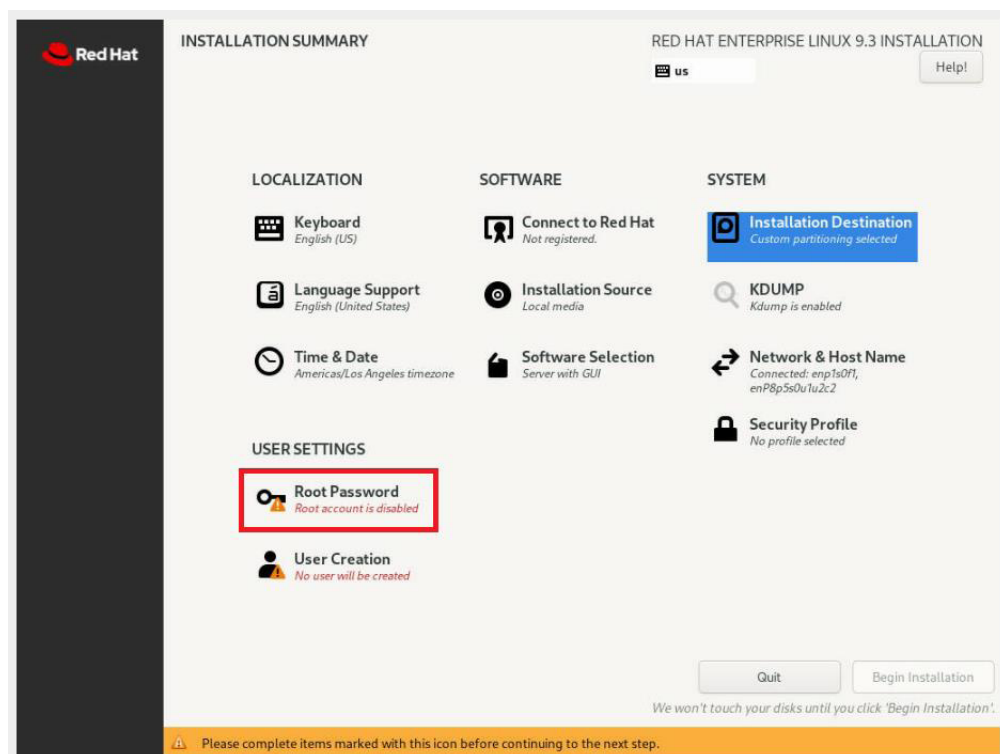

13. Enter the password for the root user.

ROOT PASSWORD

RED HAT ENTERPRISE LINUX 9.3 INSTALLATION

Done

The root account is used for administering the system. Enter a password for the root user.

Root Password: [password field] Good

Confirm: [password field]

Lock root account

Allow root SSH login with password

**Result:** The status of the Root User becomes "Root Password is set".

Red Hat

INSTALLATION SUMMARY

RED HAT ENTERPRISE LINUX 9.3 INSTALLATION

us

Help!

**LOCALIZATION**

- Keyboard: English (US)
- Language Support: English (United States)
- Time & Date: Americas/Los Angeles timezone

**SOFTWARE**

- Connect to Red Hat: Not registered.
- Installation Source: Local media
- Software Selection: Server with GUI

**SYSTEM**

- Installation Destination: Custom partitioning selected
- KDUMP: Kdump is enabled
- Network & Host Name: Connected: enp1s0f1, enP8p5s0u1u2c2
- Security Profile: No profile selected

**USER SETTINGS**

- Root Password**: Root password is set
- User Creation: No user will be created

Quit Begin Installation

We won't touch your disks until you click 'Begin Installation'.

14. Click the "User Password" in "Installation Summary".

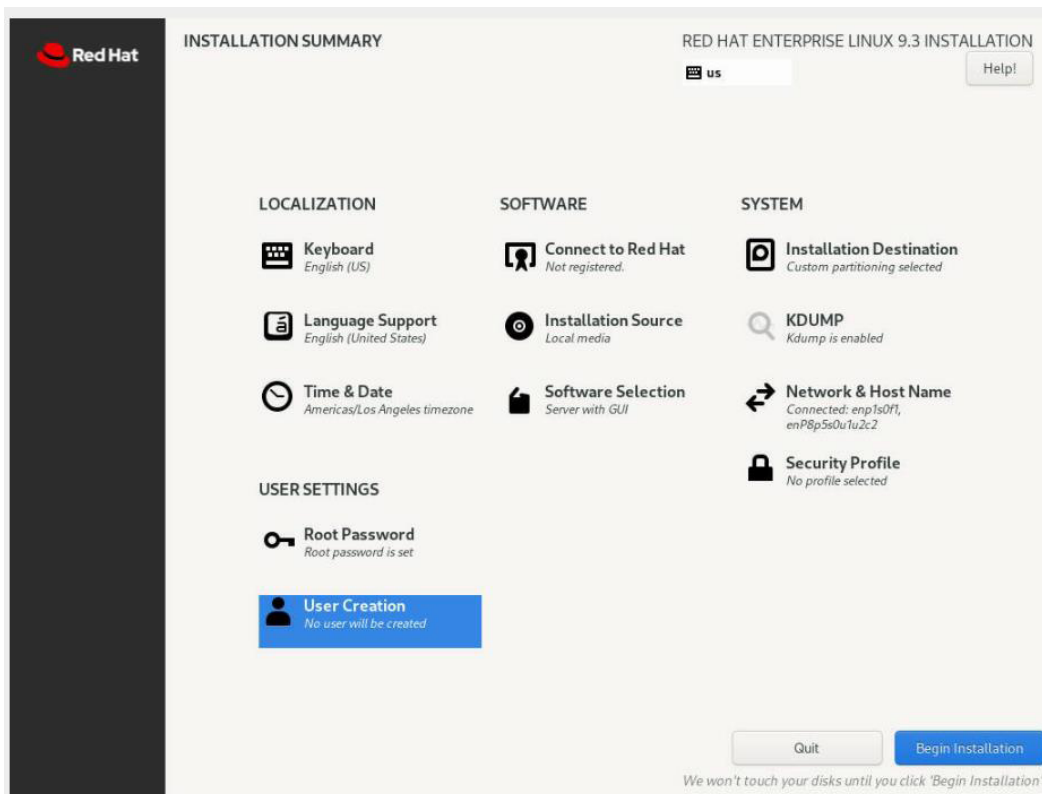

15. Enter "Full Name", "User Name", "Password" and "Confirm Password" details. Once done, click the "Done" button.

**Result:** The status of **User Creation** becomes "User username is set".

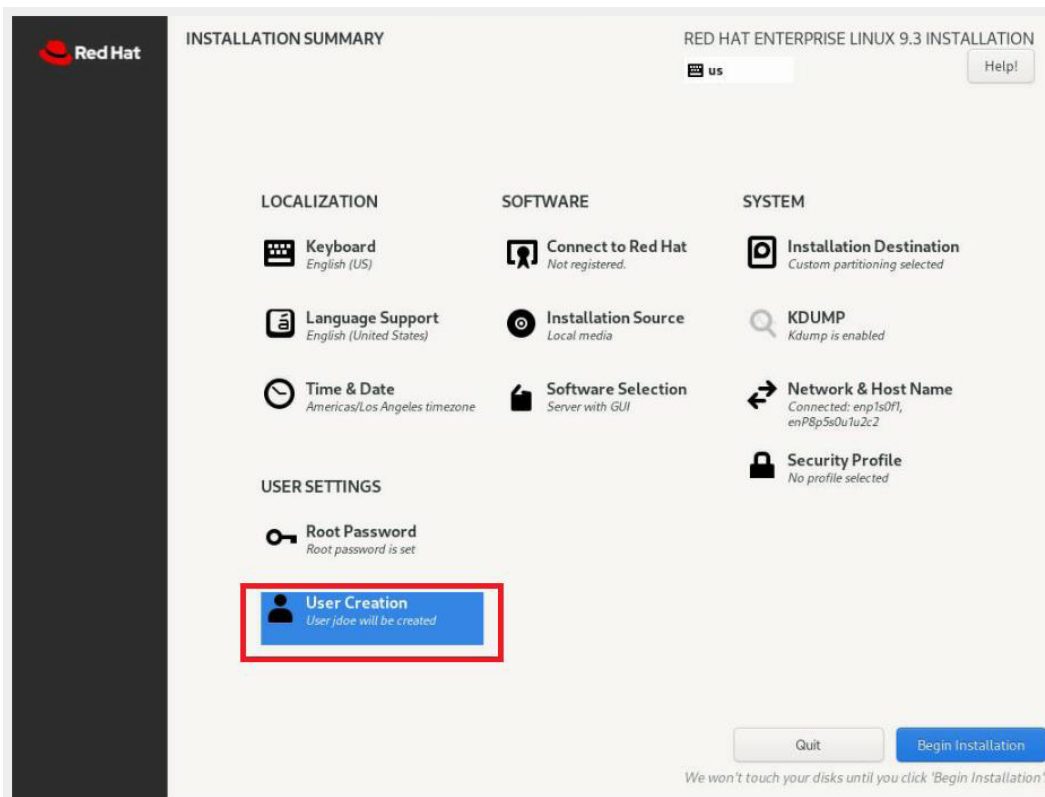

16. After completing all the above steps, click the "Begin Installation" to start the installation process.

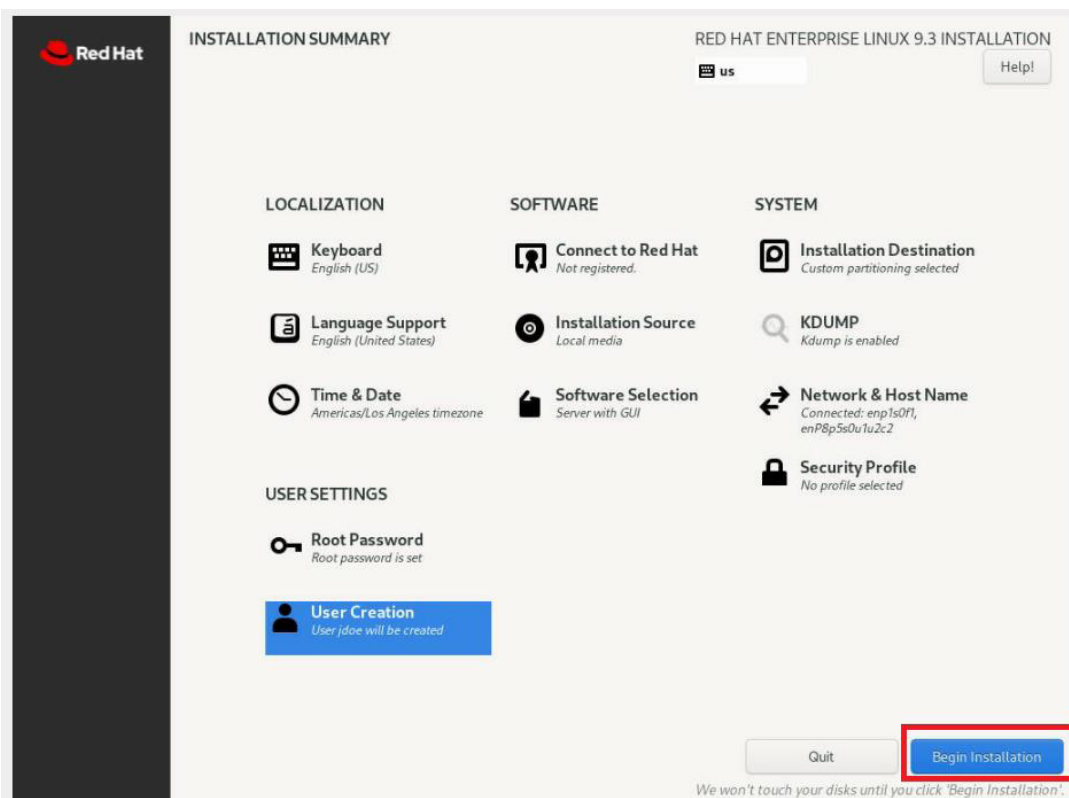

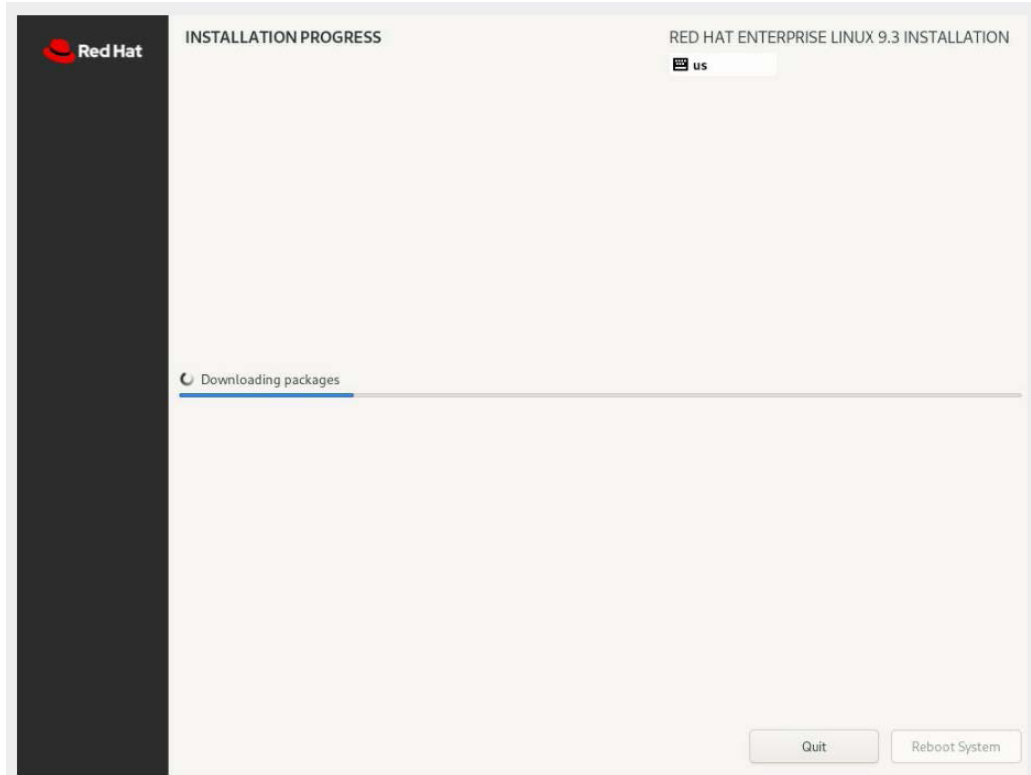

17. After the installation is complete, click the **"Reboot System"** to reboot.

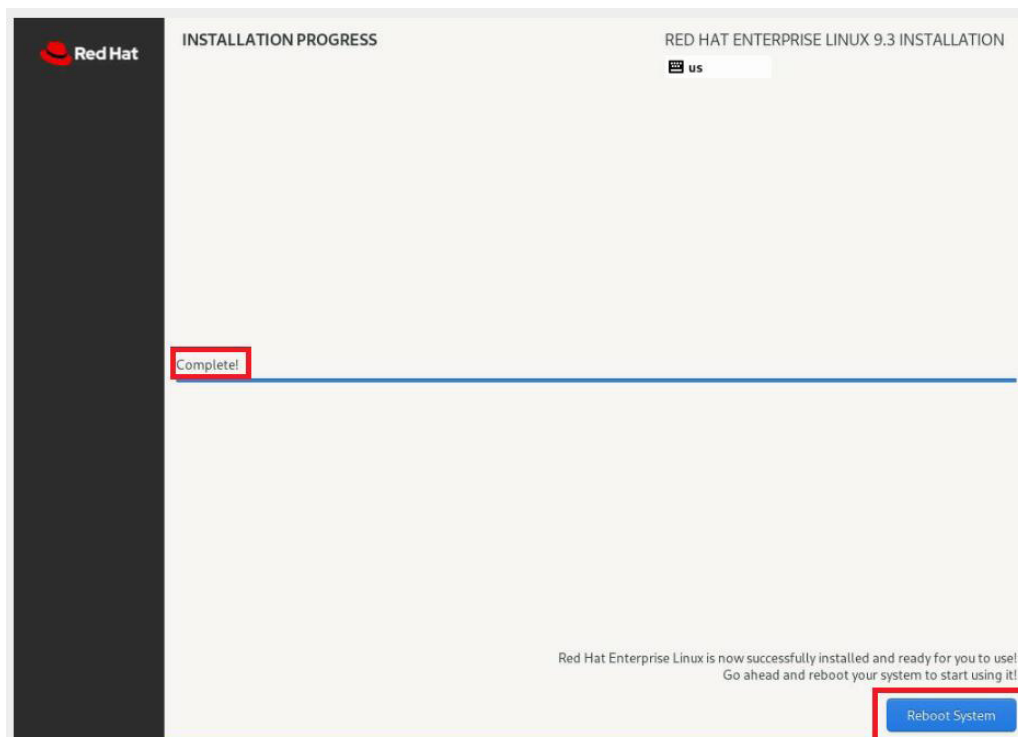

18. After rebooting, the user login page shows up. Enter the user password to log in.

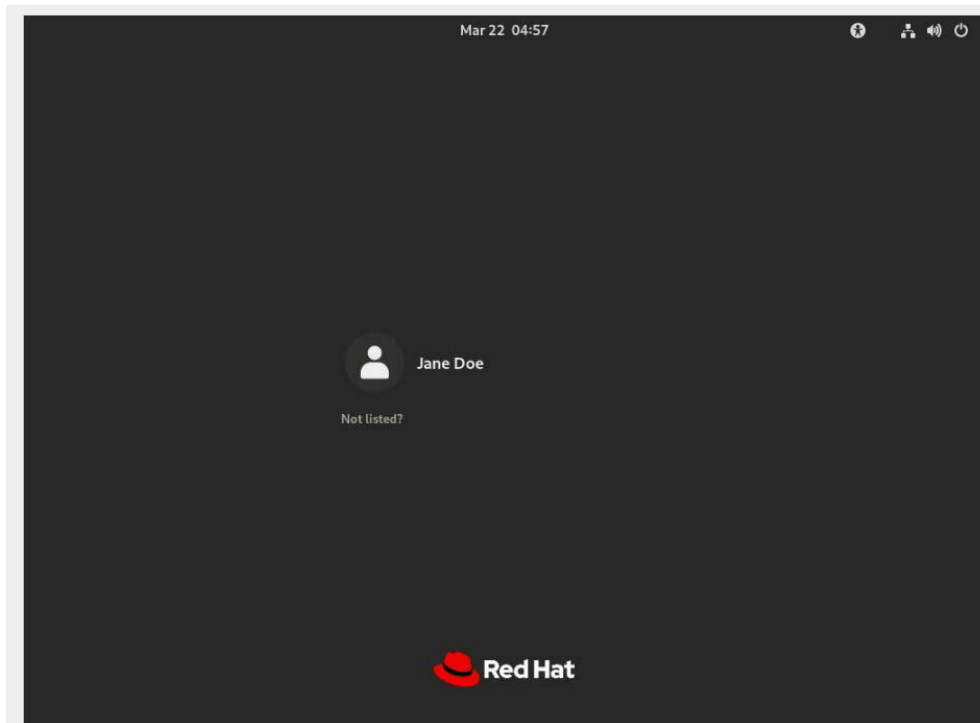

**Result:** Log in successfully. You can start using this system.

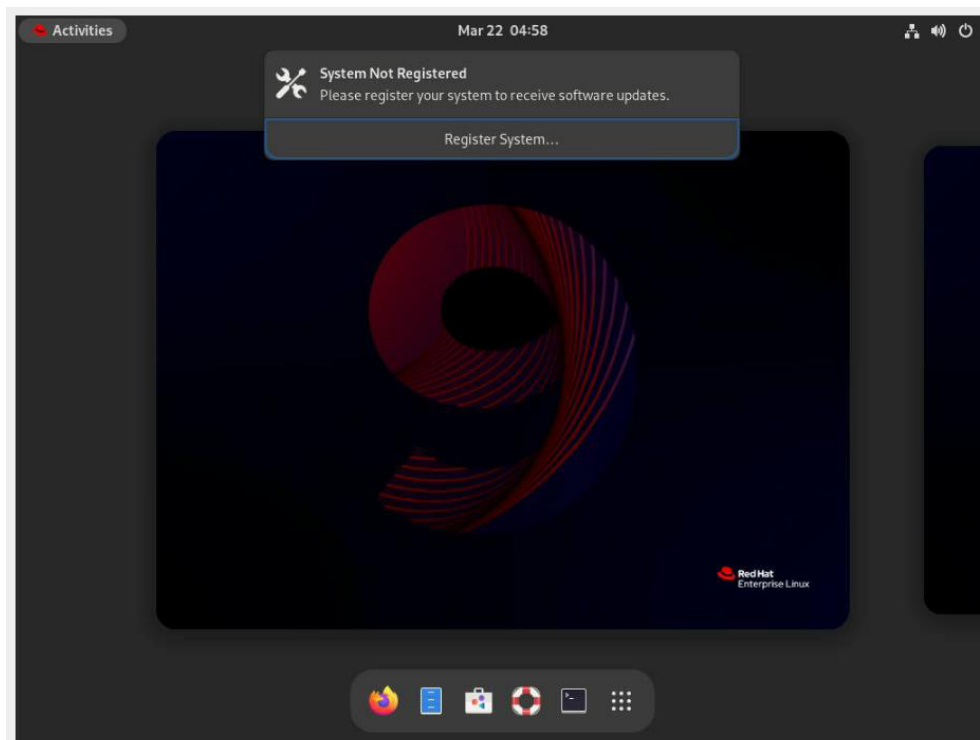

## 5.3 SUSE Linux Enterprise Server 15 Installation

### Prerequisites

Obtain the SUSE Linux Enterprise Server 15 ISO for ARM image (aarch64) and save it to your local disk or a shared server. It's recommended to use the SLES 15SP5 ISO image file. Please refer to [Downloading a SLES 15 installation ISO image](#) for the ISO packages.

### Connecting to BMC network

To utilize BMC remote functionality, ensure that the network is connected to the BMC.

### Opening SSH to the BMC from PuTTY terminal

Set up an SSH connection to the BMC IP Address (See [Step 1. Obtaining BMC IP Address](#)) through a PuTTY terminal.

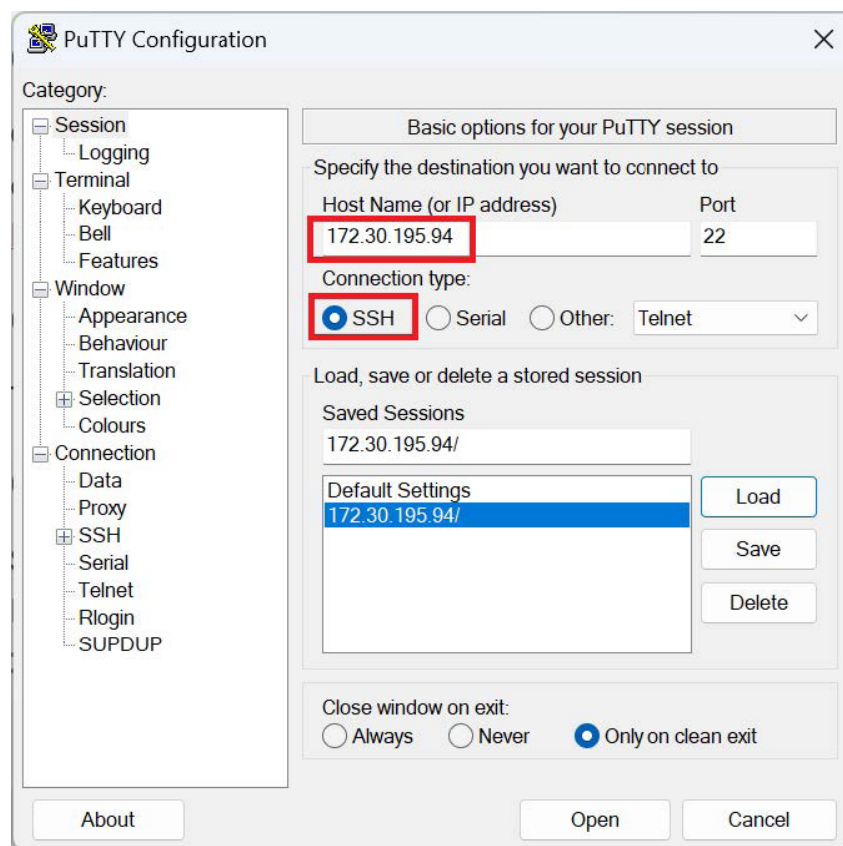

## Installing SLES 15 OS

### *Step 1. Obtaining the BMC IP Address*

Connect the system to a monitor or display using a Mini DisplayPort (Mini DP) or a Mini DisplayPort-to-DisplayPort (DP) adapter. Ensure that network is connected to the BMC using a network cable and power on the system. The BMC IP address will appear on the right corner of the Supermicro Logo screen.



### *Step 2. Accessing the BMC Remote Server*

#### *Log in to BMC Remote Server*

1. In the terminal, execute a ping command to the BMC IP address, such as 172.30.195.94, to verify its connectivity.
2. Launch a new web browser and input the BMC IP address into the URL field.

**Outcome:** The BMC Remote Console login screen will be displayed.

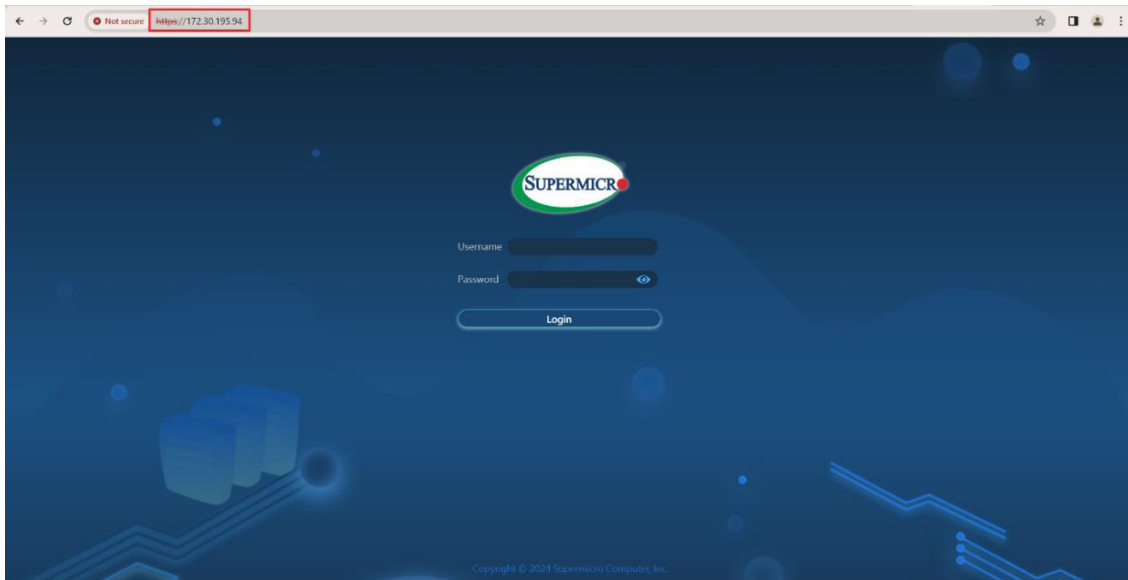

3. Input the username "**ADMIN**" and the unique BMC password, which is located on the label on the opposite side of the service tag of the system. Click the "**Login**" to proceed.

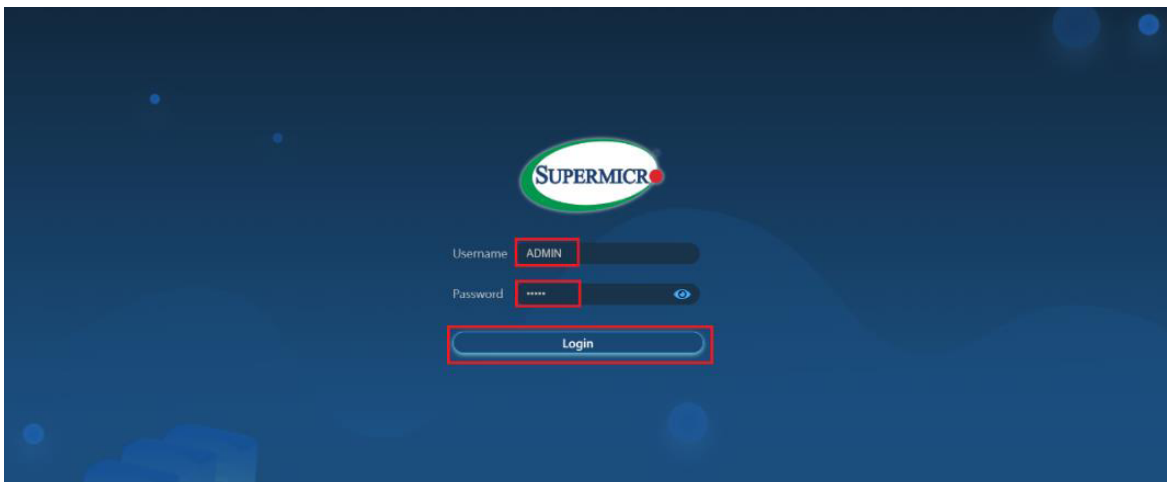

**Outcome:** The BMC Dashboard offers insights into system overview, configuration, health status, and maintenance.

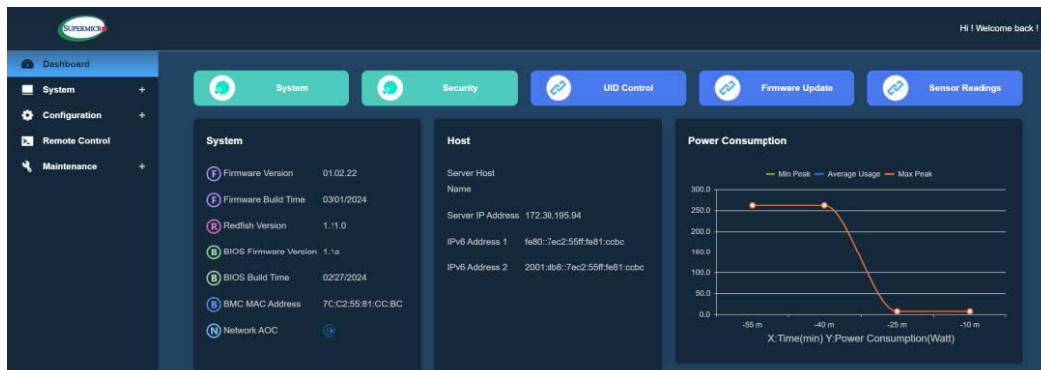

### Step 3. Controlling the BMC Remotly

1. The Remote Control menu in the BMC Remote Server enables remote server operations.

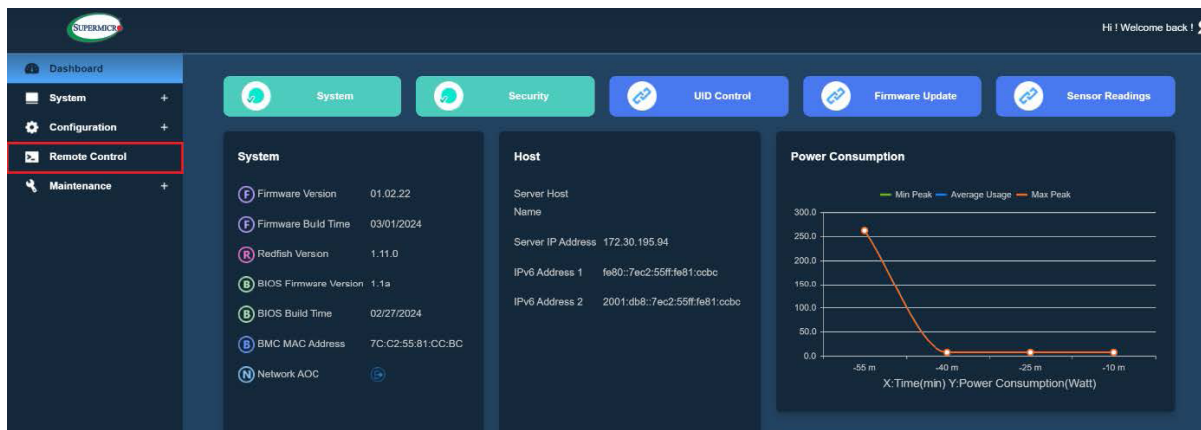

2. Use the Launch Console section to configure the remote console interface settings. Choose between the HTML5 interface or a JAVA plug-in. Launch an HTML5 remote browser.

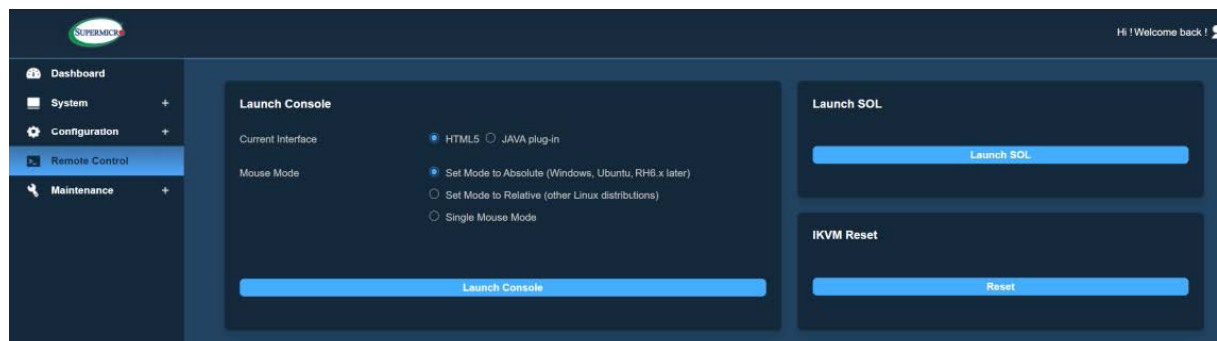

### To launch an HTML5 Remote Browser

1. Set HTML5 as the current interface.
2. Choose the mouse mode according to your operating system, such as **"Set Mode to Absolute" (Windows, Ubuntu, RH6.x, or later).**
3. Click the **"Launch Console"** button to open a console in a new browser window.

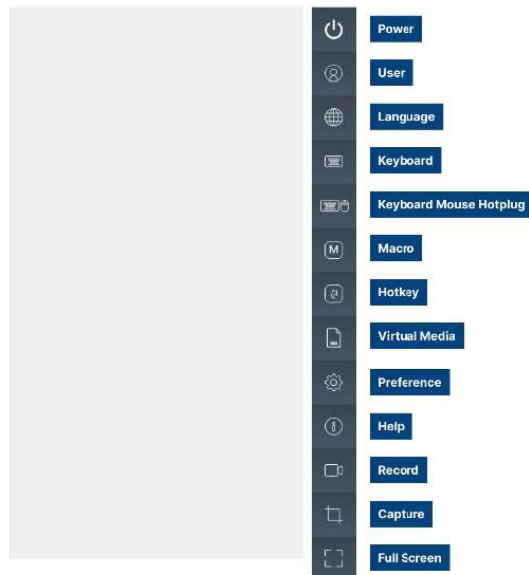

### Step 4. Mounting the ISO Image

There are two methods to mount ISO images. If the ISO files are stored locally on your disk, you can mount them directly within the remote control browser. Alternatively, if the ISO files are located on a shared server, you can mount them via the Configuration > Virtual Media menu.

#### Method 1: Mount the ISO Image Using a Local File

1. In the remote control browser, click the "**Virtual Media**" icon. This action will prompt a dialogue box to appear, enabling you to select the image type and files for mounting.

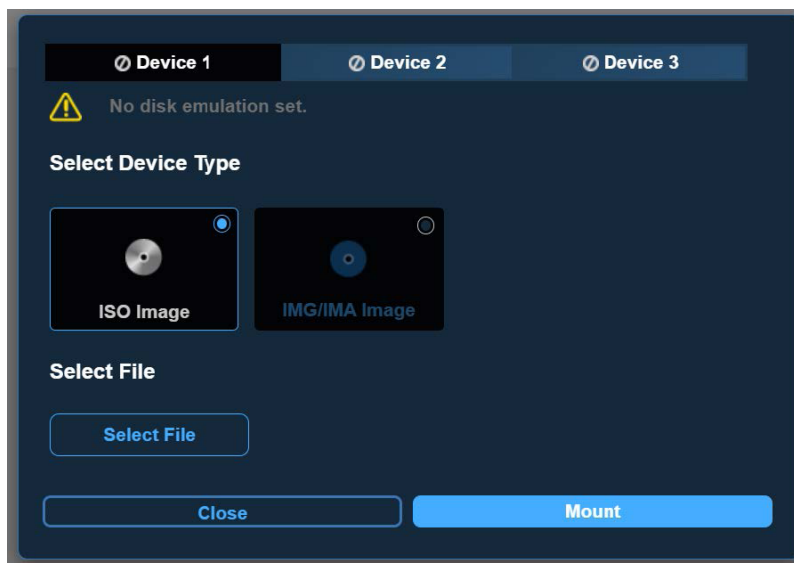
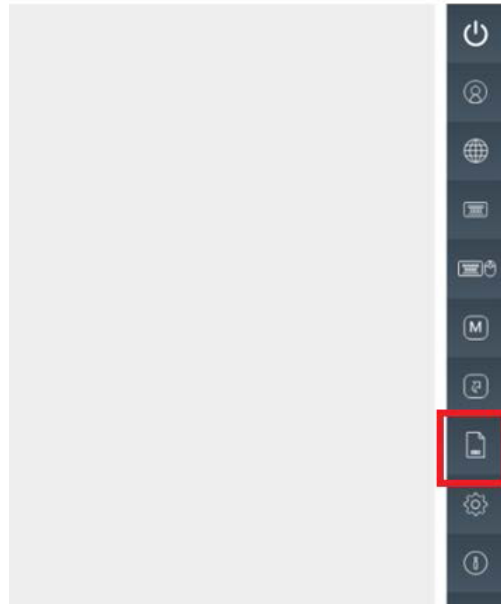

2. Select the "**Choose File**" button to browse and select the SLES ISO image on your local disk for use.

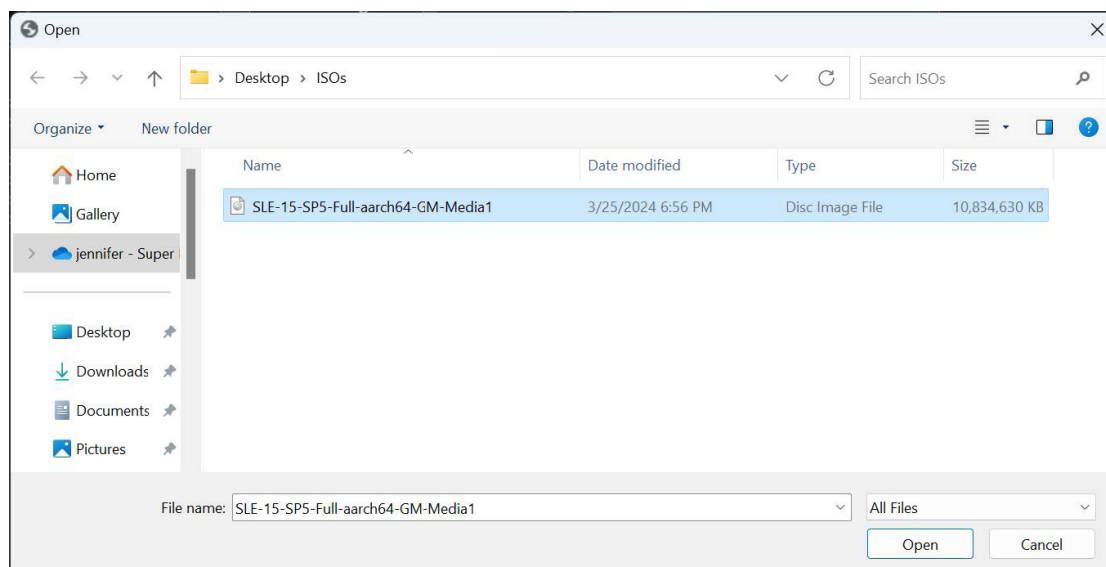
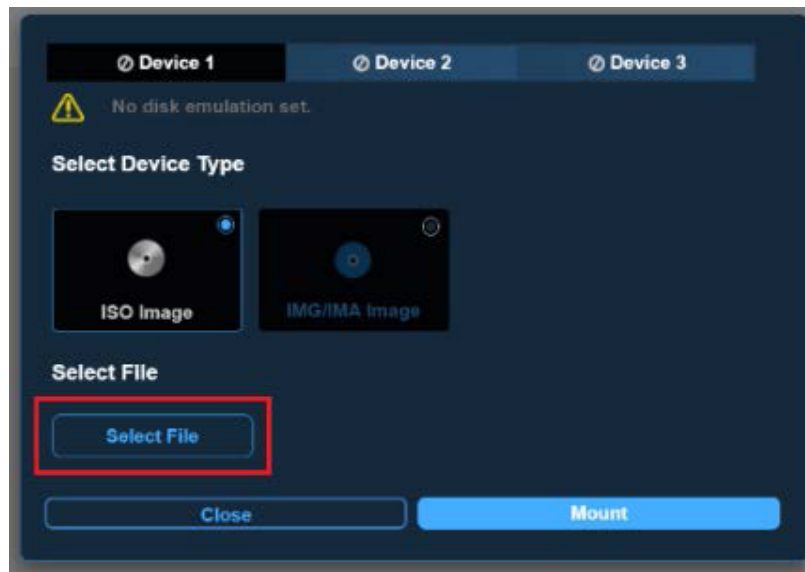

3. Click the **"Mount"** button to attach the chosen ISO image.

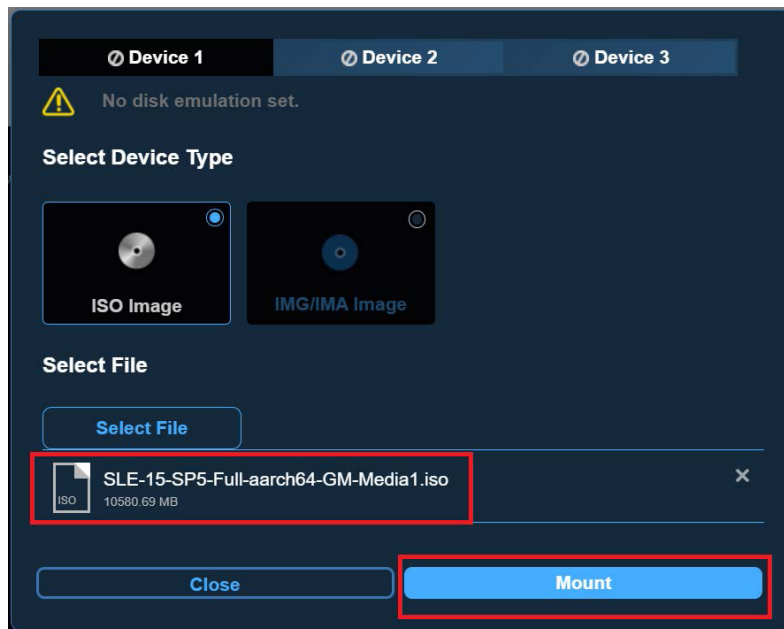

**Result:** Upon successful mounting of the ISO image, a green indicator will appear in the "Device" tab. Close the dialogue to continue.

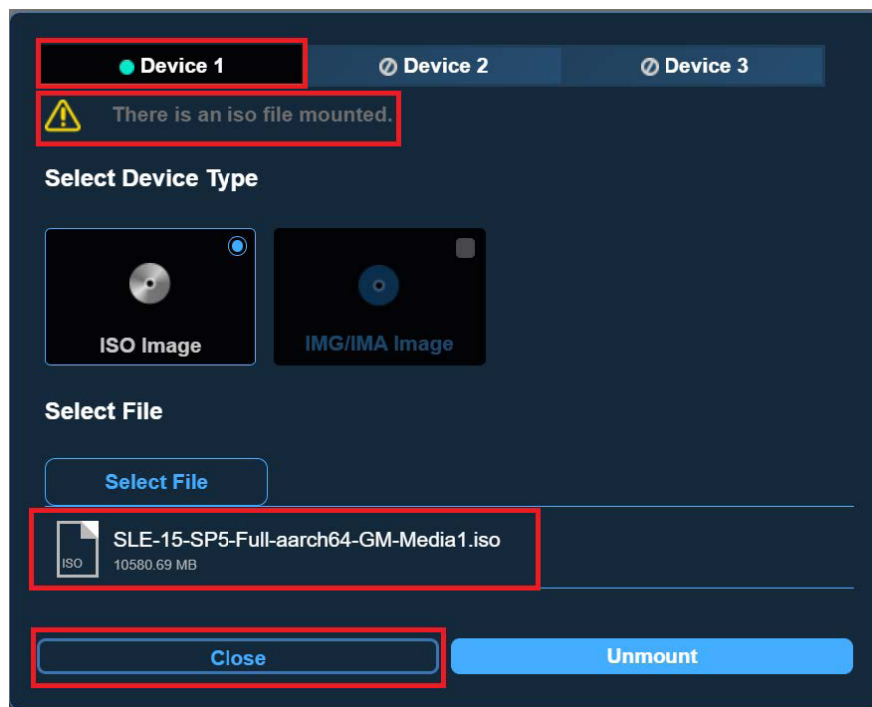

## Method 2: Mount the ISO image through shared server

1. On the BMC dashboard, go to Configuration > Virtual Media. This allows you to attach an ISO image from the server.

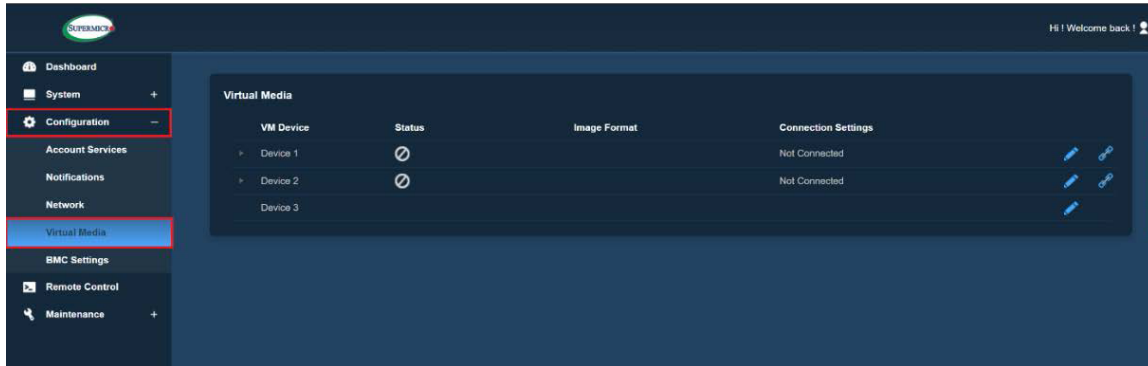

2. Click the "Edit" icon to adjust the VM configuration. Enter the server host address and the path to the ISO image. Then, click the "Save" to apply the changes.

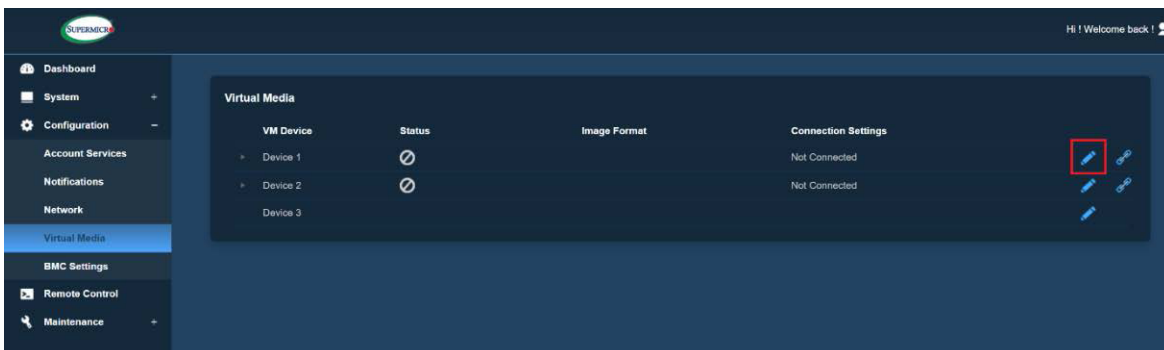

### Edit VM Connection

Share Host \*

Verify the certification of the server

Accept the self-signed certificates

Path to Image \*

Users

Password

- Click the **"Connect"** icon to mount the virtual media.

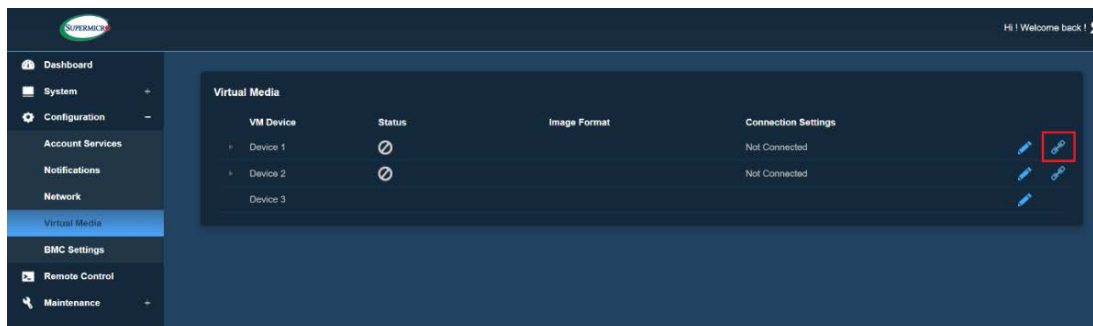

- The device status will display as green once the VM is successfully configured.

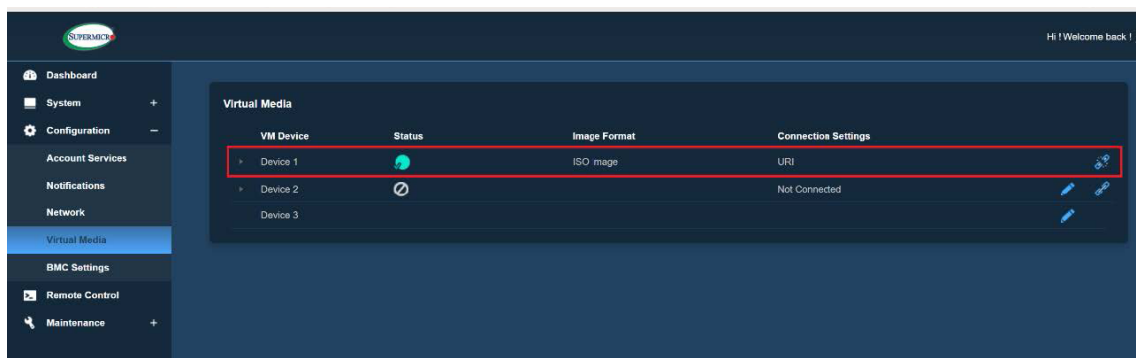

### **Step 5. Entering in UEFI BIOS Menu**

To configure the boot option from the mounted image in virtual media, users must manually adjust the boot settings in the BIOS setup.

- Power on the system and wait for the Log screen to display. To access the BIOS setup menu, repeatedly press **<DEL>** until **"Entering Setup..."** appears at the bottom left corner of the screen.





Subsequently, the UEFI BIOS screen is displayed.

### **Step 6. Opening a SSH SOL Connection in PuTTY**

Open a connection to the BMC IP address (For detailed instructions, refer to [Step 1. Obtaining BMC IP Address.](#)) and log in using the provided username and the unique BMC password through PuTTY. Once logged in, navigate to the directory by typing the command "**cd system1/sol1**". Then, initiate the SOL session by entering the command "**start**".

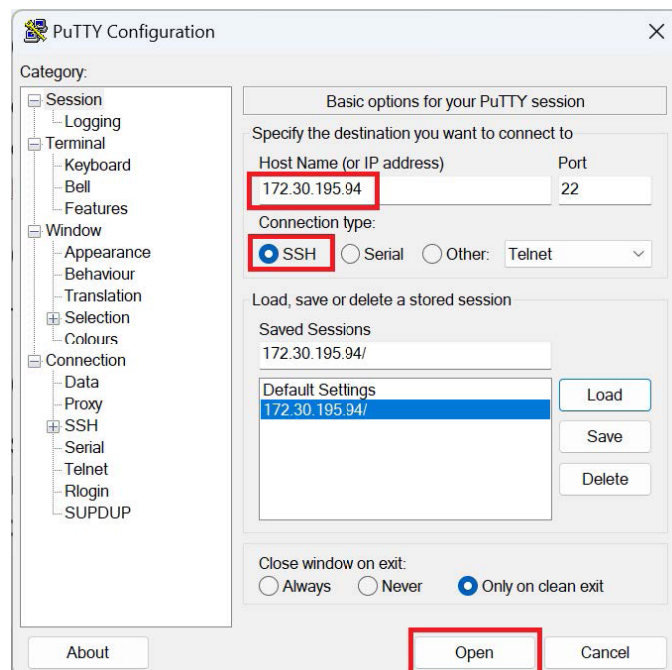

```

172.30.195.94 - PuTTY
login as: ADMIN
ADMIN@172.30.195.94's password:

ATEN SMASH-CLP System Management Shell, version 1.05
Copyright (c) 2008-2009 by ATEN International CO., Ltd.
All Rights Reserved

->

```

```

172.30.195.94 - PuTTY
login as: ADMIN
ADMIN@172.30.195.94's password:

ATEN SMASH-CLP System Management Shell, version 1.05
Copyright (c) 2008-2009 by ATEN International CO., Ltd.
All Rights Reserved

-> cd system1/soll
/system1/soll

-> start
/system1/soll
press <Enter>, <Esc>, and then <T> to terminate session
(press the keys in sequence, one after the other)

```

### Step 7. Setting the Boot Option in PuTTY Terminal

1. Navigate to the **"Save & Exit"** menu using the arrow keys in PuTTY terminal, then select **"UEFI: ATEN Virtual CDROM YSOJ"** as the boot option. This selection presents the ISO image mounted in Virtual Media. Hit **"Enter"** to proceed.

```

172.30.195.94 - PuTTY
Aptio Setup - AMI
Main Advanced BMC Security Boot Save & Exit

System Date [Tue 04/09/2024]
System Time [18:31:03]

Supermicro G1SMH-G
BIOS Version 1.1a
Build Date 02/27/2024
FPGA Version F2.00.8C

Memory Information
Total Memory 480 GB

Set the Date. Use Tab to
switch between Date elements.
Default Ranges:
Year: 1998-9999
Months: 1-12
Days: Dependent on month
Range of Years may vary.

><: Select Screen
: Select Item
Enter: Select
+/-: Change Opt.
F1: General Help
F2: Previous Values
F3: Optimized Defaults
F4: Save & Exit
ESC: Exit

Version 2.22.1289 Copyright (C) 2024 AMI

```

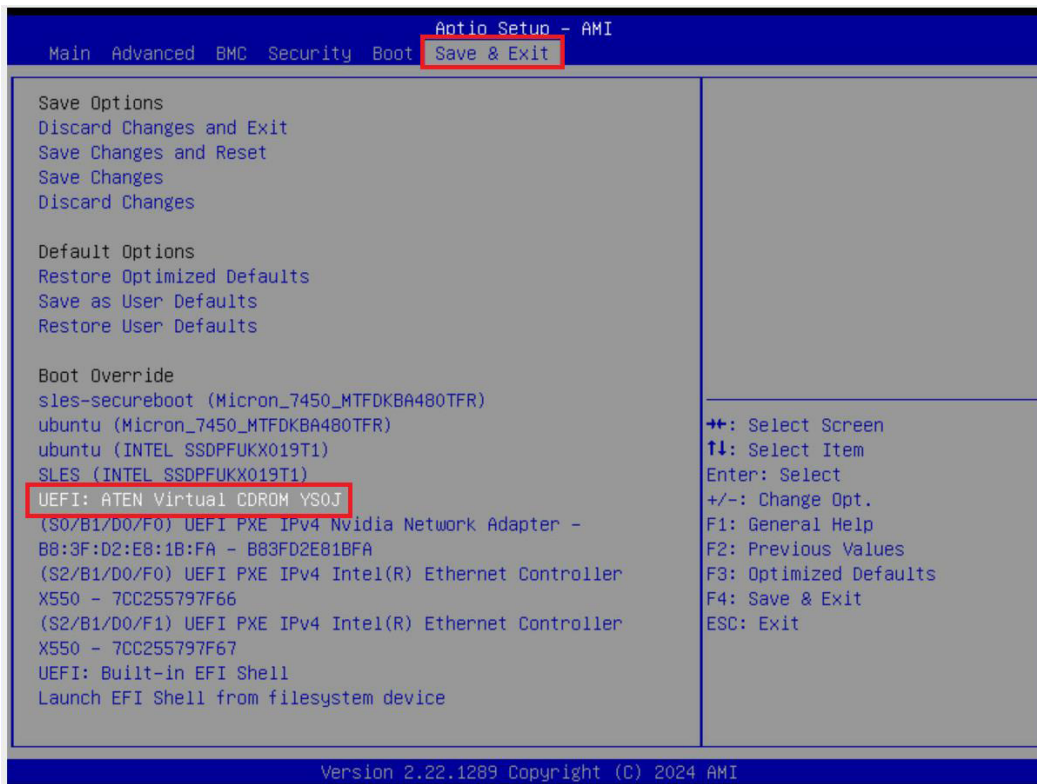

2. Select "Installation" and press "t" to show the boot menu in PuTTY terminal.

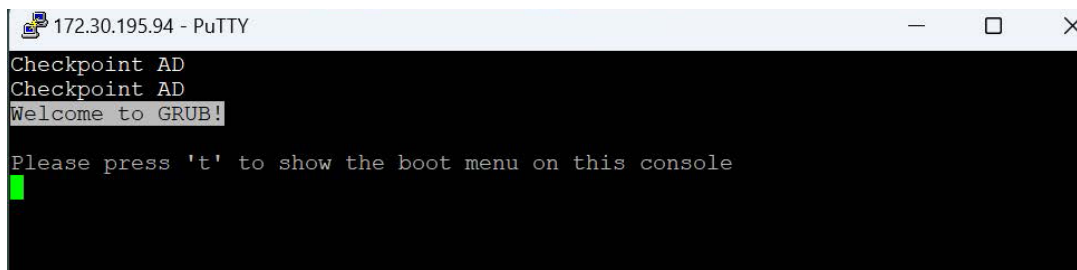
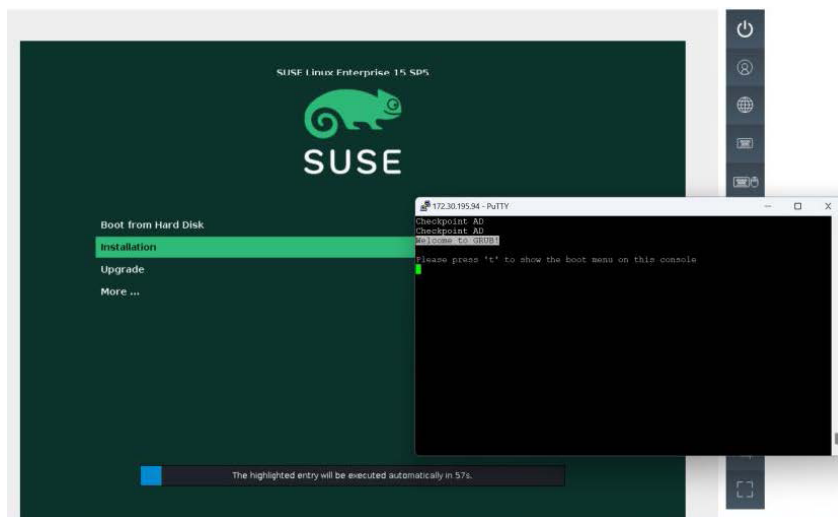

3. Highlight "Installation" and press "e" to edit the commands.

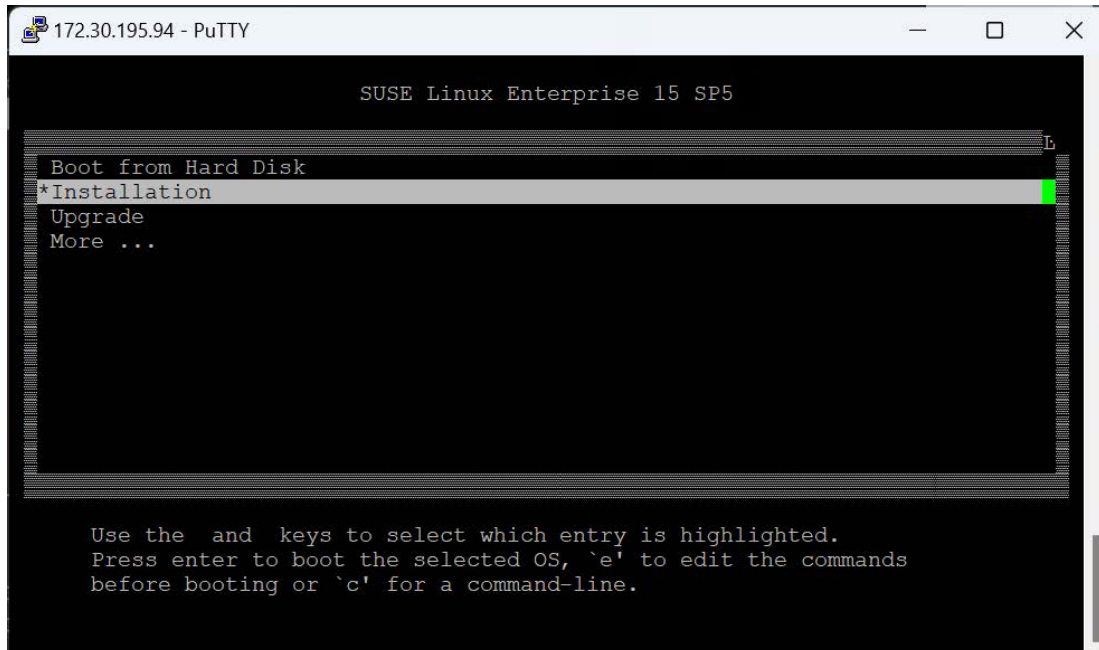

4. Append "**modprobe.blacklist=ast**" to the end of the list of kernel boot parameters. Boot the entry by clicking the **Ctrl-X** or pressing **F10**.

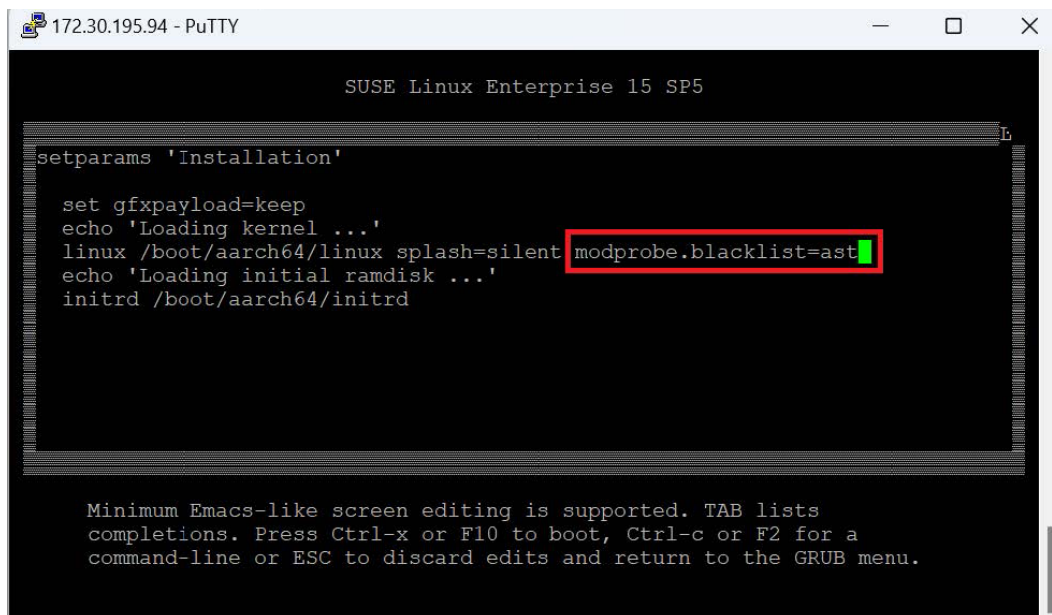

## Step 8. Installing SLES 15 OS

### Follow the SLES Installer Steps in PuTTY to Continue Installation

1. Initialize network configuration.

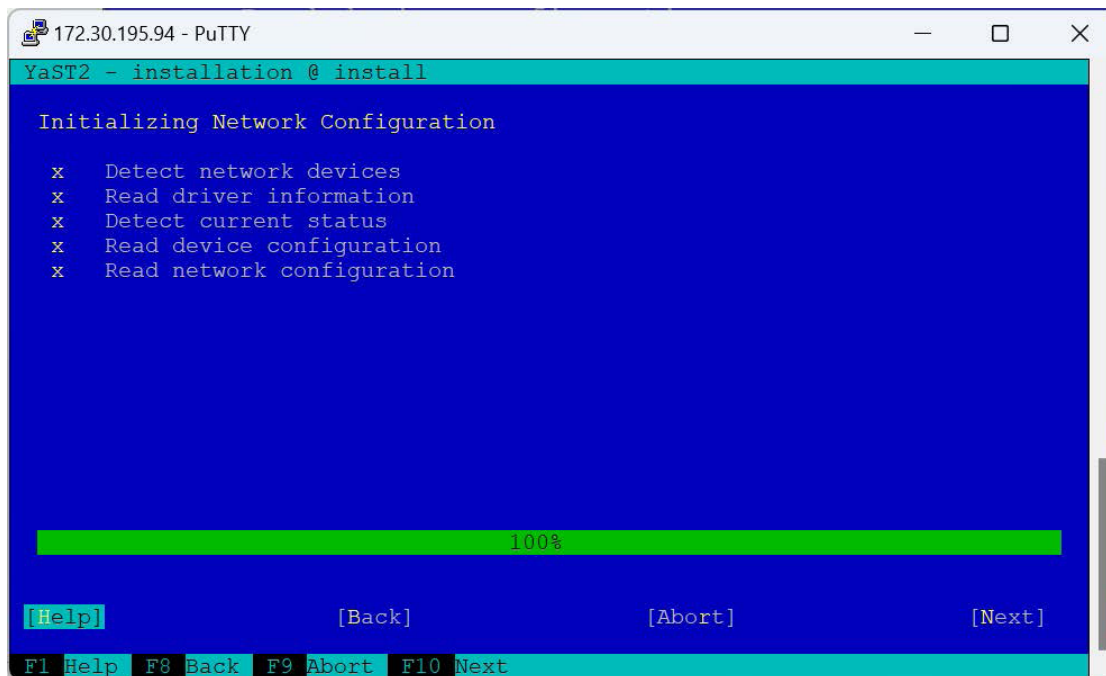

2. Select the Language, Keyboard, and Product to Install.

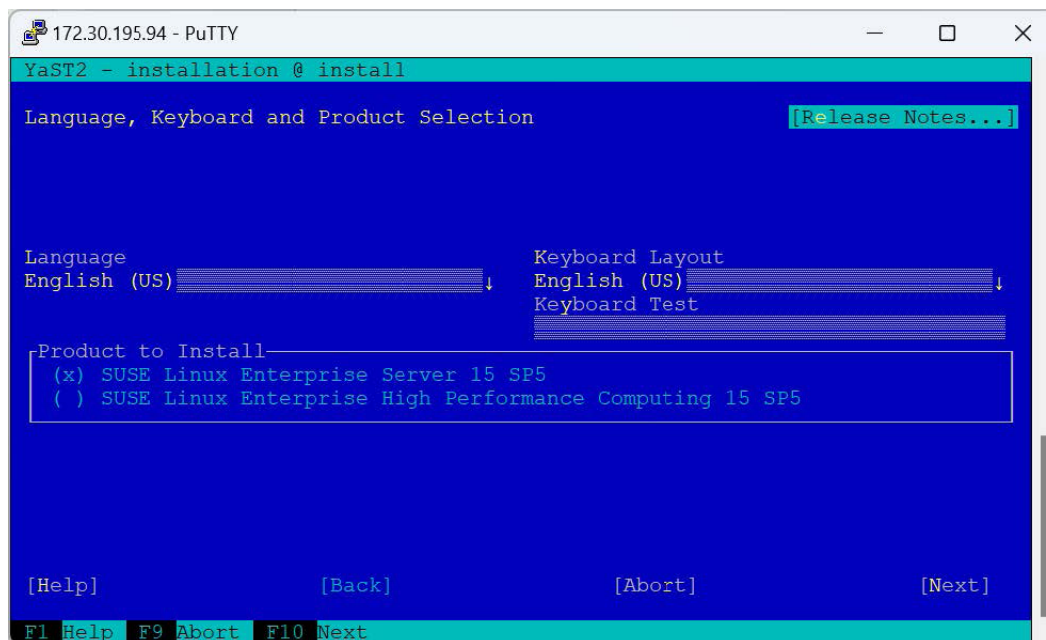

- Review the End User Agreement and proceed if you agree to the License Terms.

```

172.30.195.94 - PuTTY
YaST2 - installation @ install

SUSE Linux Enterprise Server 15 SP5 License Agreement [Release Notes...]
Language
English (US) ↓

End User License Agreement
for SUSE products

End User License Agreement for SUSE Products
PLEASE READ THIS AGREEMENT CAREFULLY. BY PURCHASING, INSTALLING,
DOWNLOADING OR OTHERWISE USING THE SOFTWARE (INCLUDING ITS
COMPONENTS), YOU AGREE TO THE TERMS OF THIS AGREEMENT. IF YOU DO NOT
AGREE WITH THESE TERMS, YOU ARE NOT PERMITTED TO DOWNLOAD, INSTALL
OR USE THE SOFTWARE AND YOU SHOULD NOTIFY THE PARTY FROM WHICH YOU
PURCHASED THE SOFTWARE TO OBTAIN A REFUND. AN INDIVIDUAL ACTING ON
BEHALF OF AN ENTITY REPRESENTS THAT HE OR SHE HAS THE AUTHORITY TO
ENTER INTO THIS AGREEMENT ON BEHALF OF THAT ENTITY.

[x] I Agree to the License Terms.
[Help] [Back] [Abort] [Next]

F1 Help F8 Back F9 Abort F10 Next

```

- Configure the Network settings.

```

172.30.195.94 - PuTTY
YaST2 - installation @ install

Network Settings [Release Notes...]
Overview—Hostname/DNS—Routing

Name | IP Address | Device | Note
-----|-----|-----|-----
Ethernet Controller 10G X550T | Not configured | eth0 |
Ethernet Controller 10G X550T | Not configured | eth1 |
RNDIS/Ethernet Gadget | Not configured | usb0 |

Ethernet Controller 10G X550T
MAC : 7c:c2:55:79:7f:66
BusID : 0002:01:00.0
Device Name: eth0
The device is not configured. Press Edit to configure.

[Add] [Edit] [Delete]

[Help] [Back] [Abort] [Next]

F1 Help F3 Add F4 Edit F5 Delete F8 Back F9 Abort F10 Next

```

## 5. Fill in the Registration details.

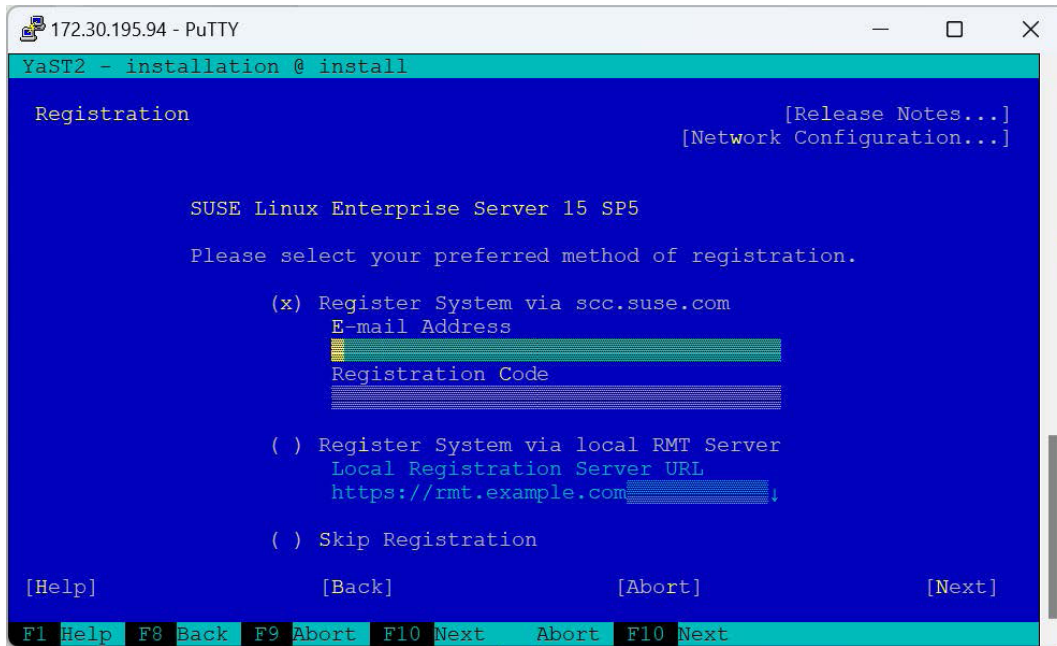

## 6. Select Add-on Products if you want to install.

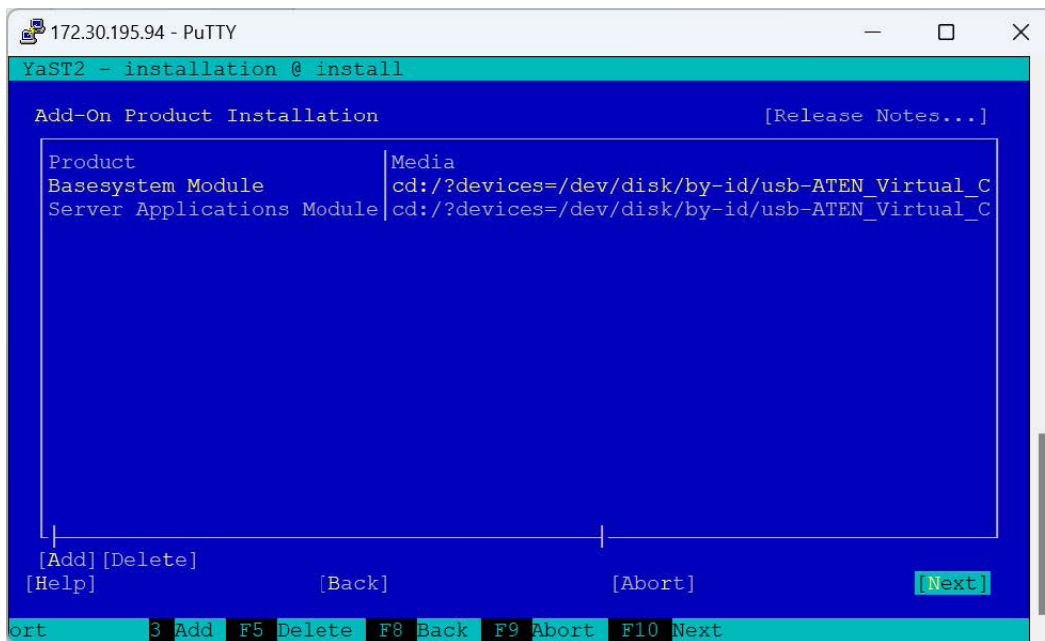

- Define the System Role based on your specific use case. This role will dictate the installation selections tailored to your requirements.

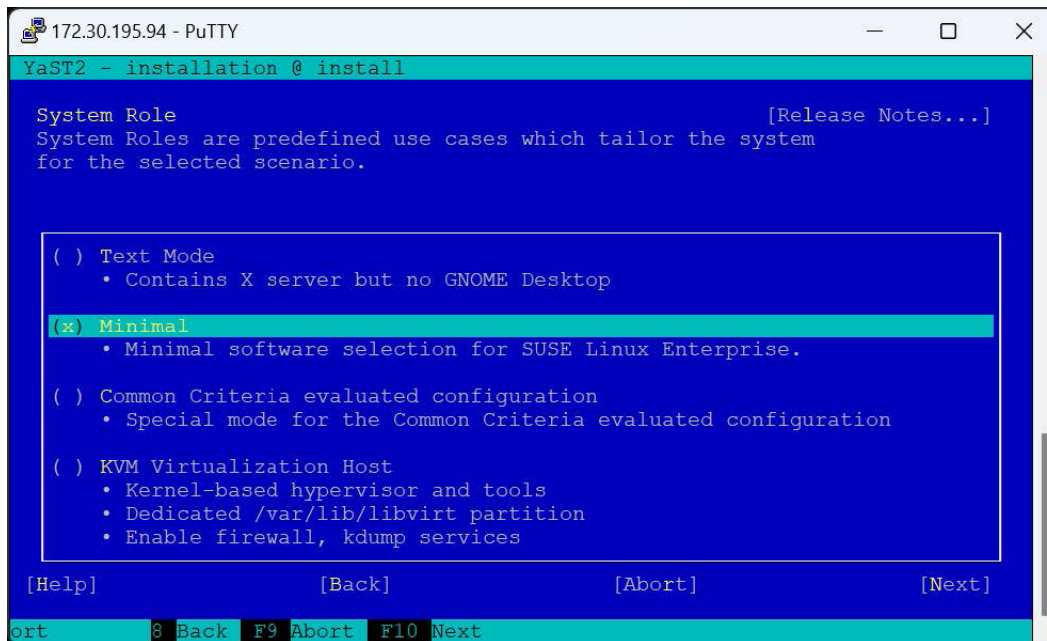

- Choose the partitioning scheme that best suits your requirements.

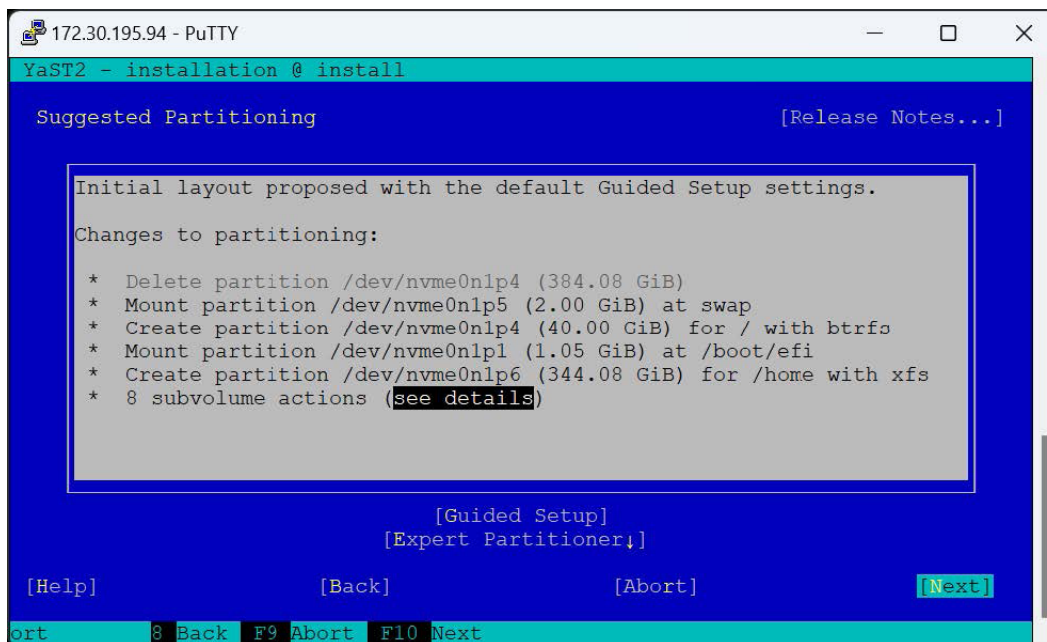

## 9. Select the Clock and Time Zone.



## 10. Set up local username and password.

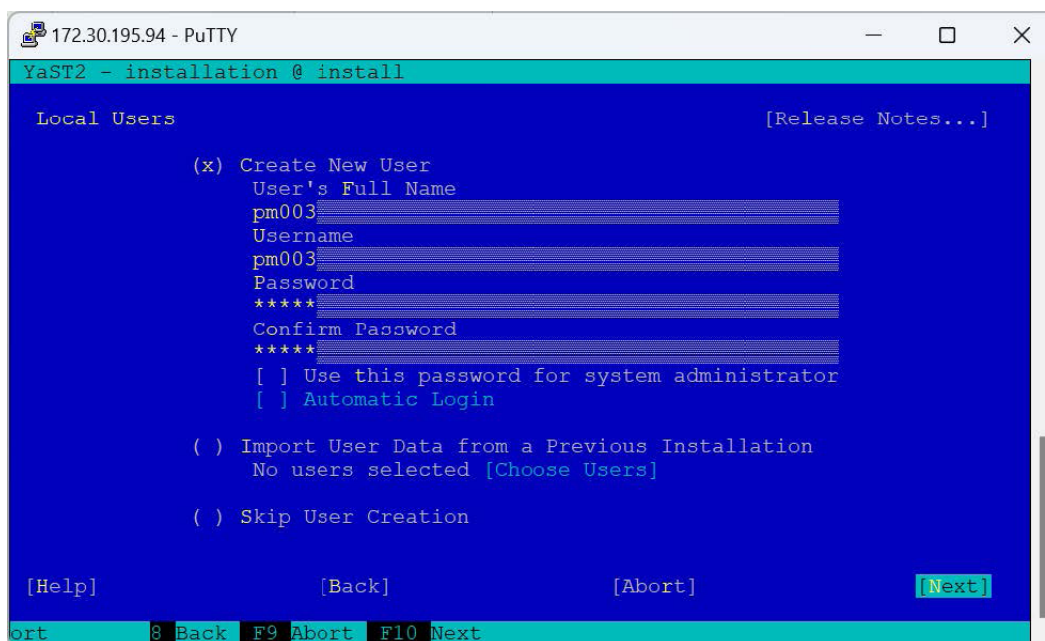

- Set up System administrator "**root**" and its password.

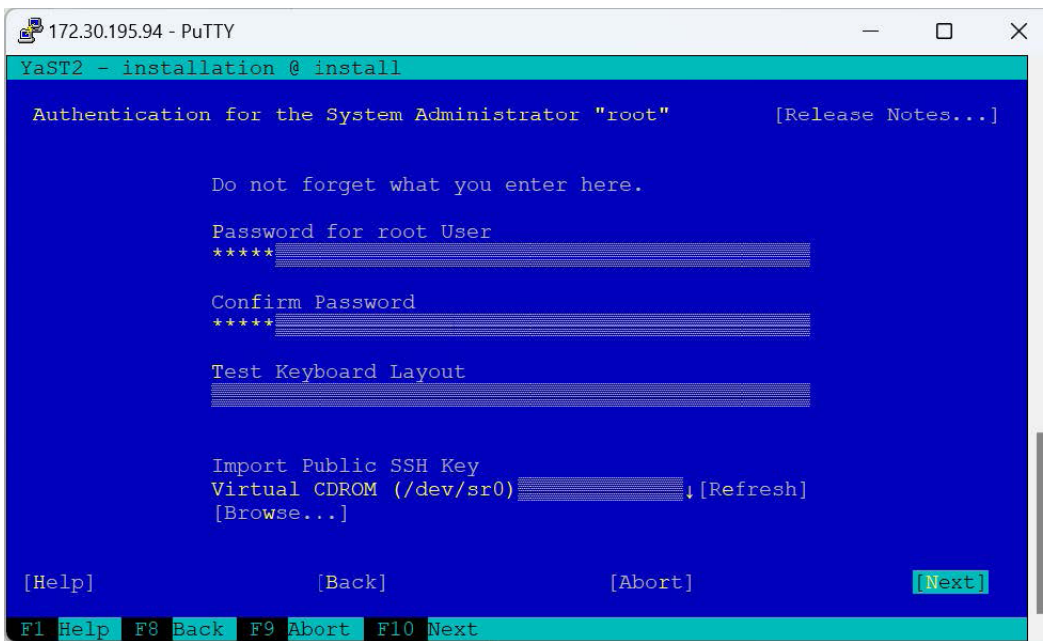

- Review the Installation Settings and click the "**Install**" to start the installation process.

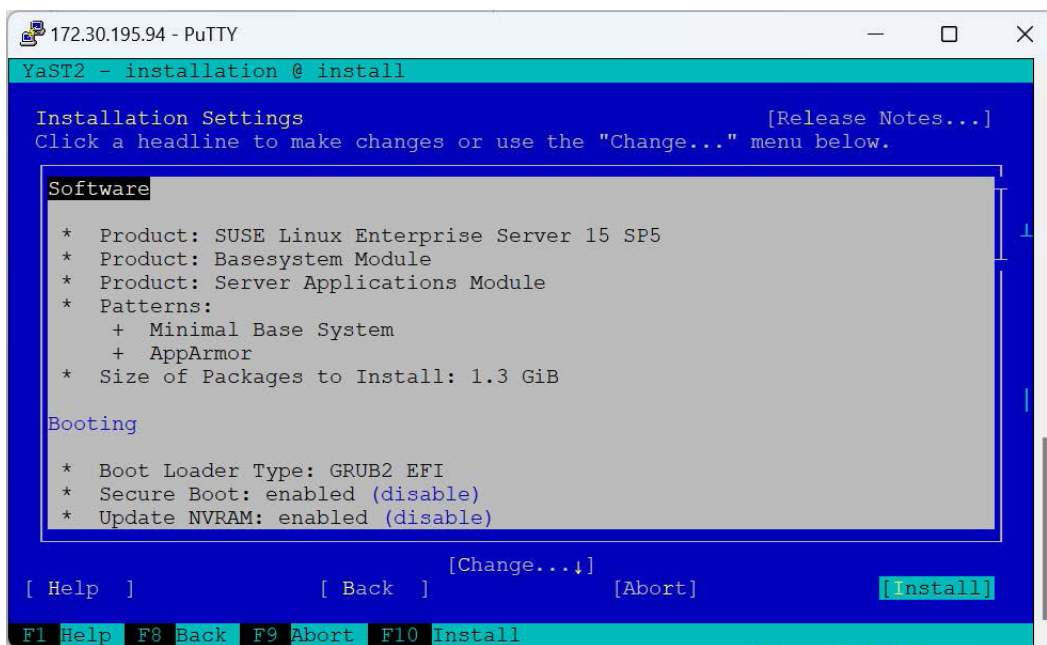

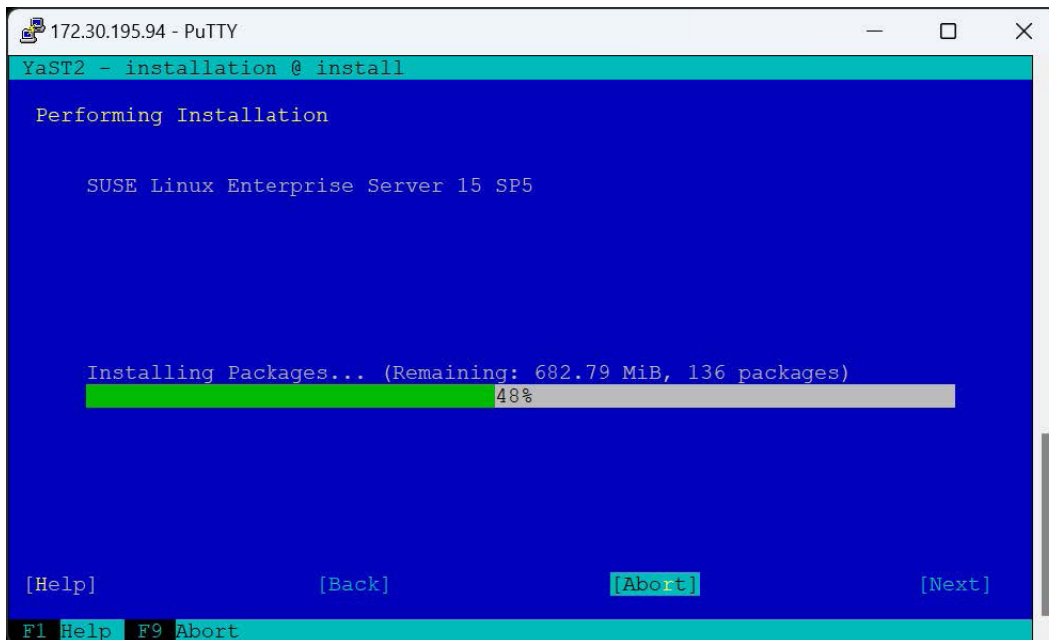
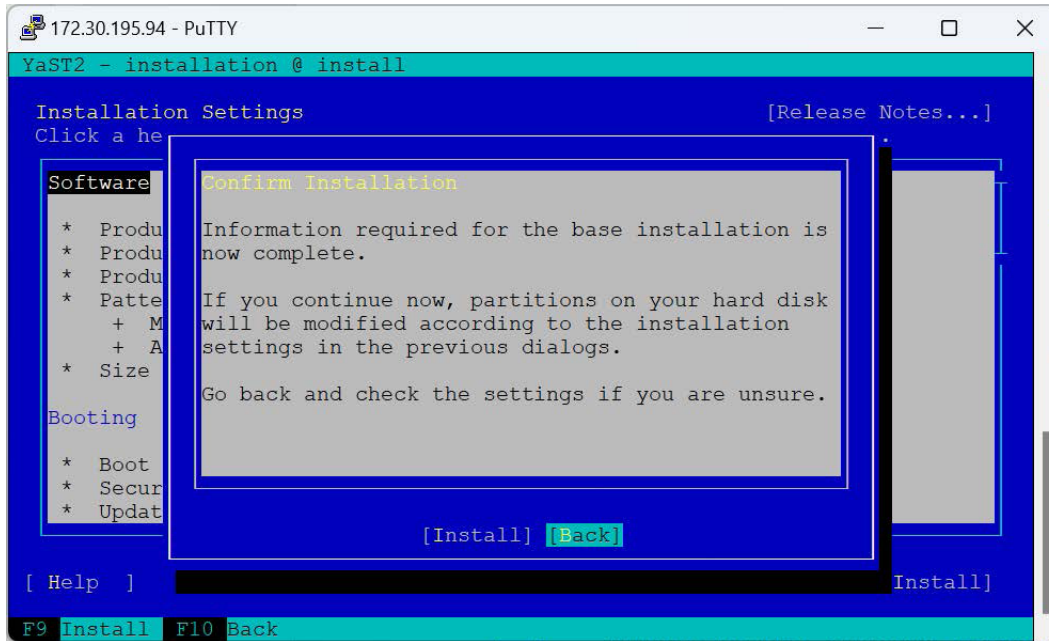

13. Once installation is complete, the system will reboot.

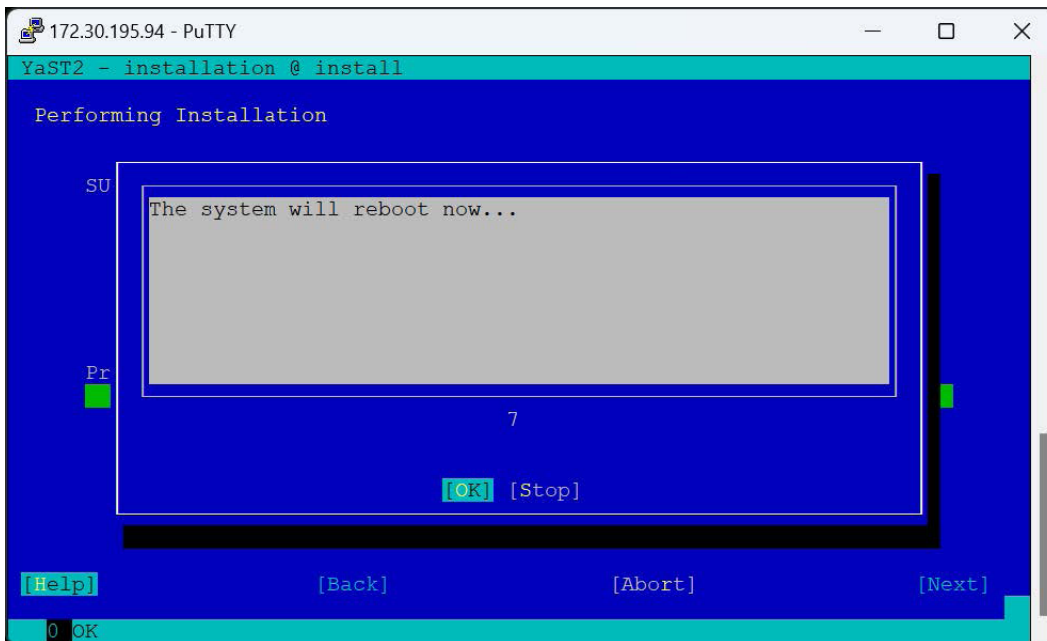

14. Select "SLES 15-SP5" and click the "Enter" to proceed in the remote control.

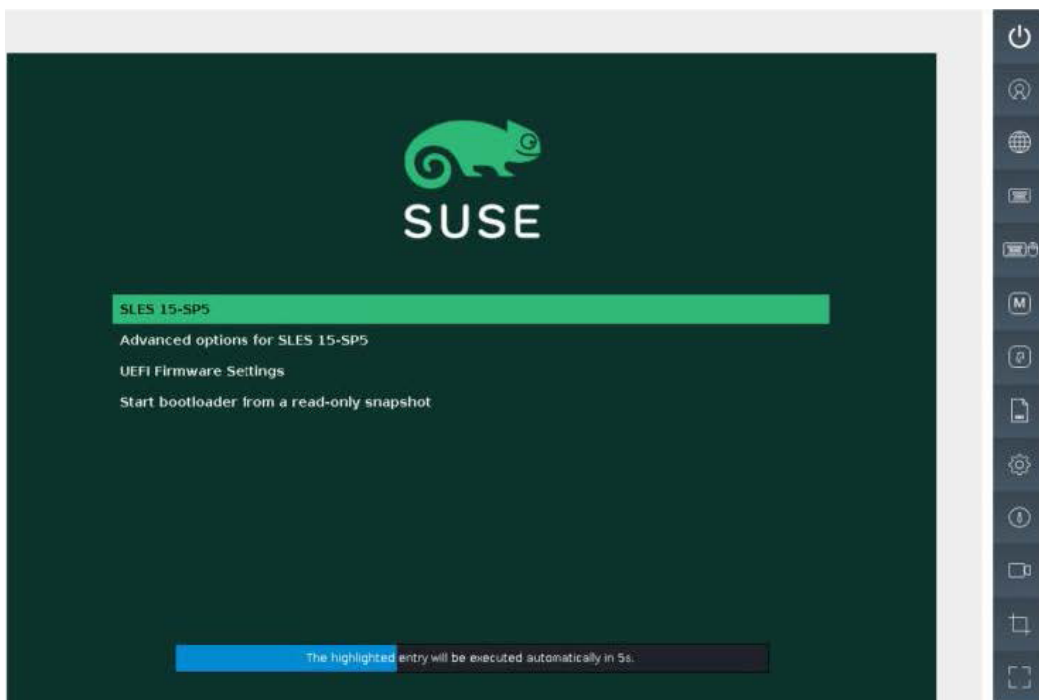

15. Enter username and password to login.

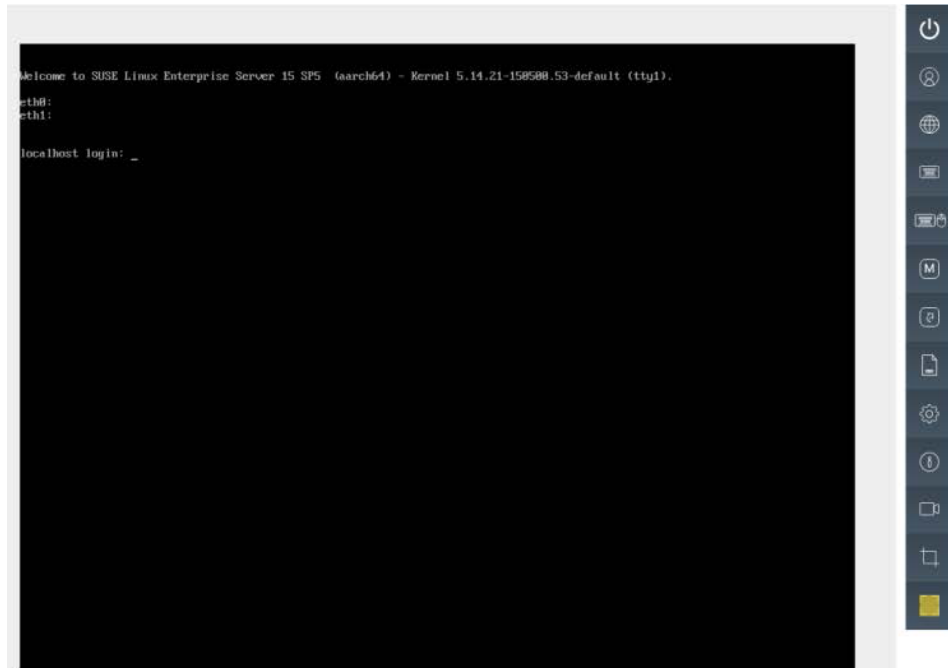

Log in successfully.

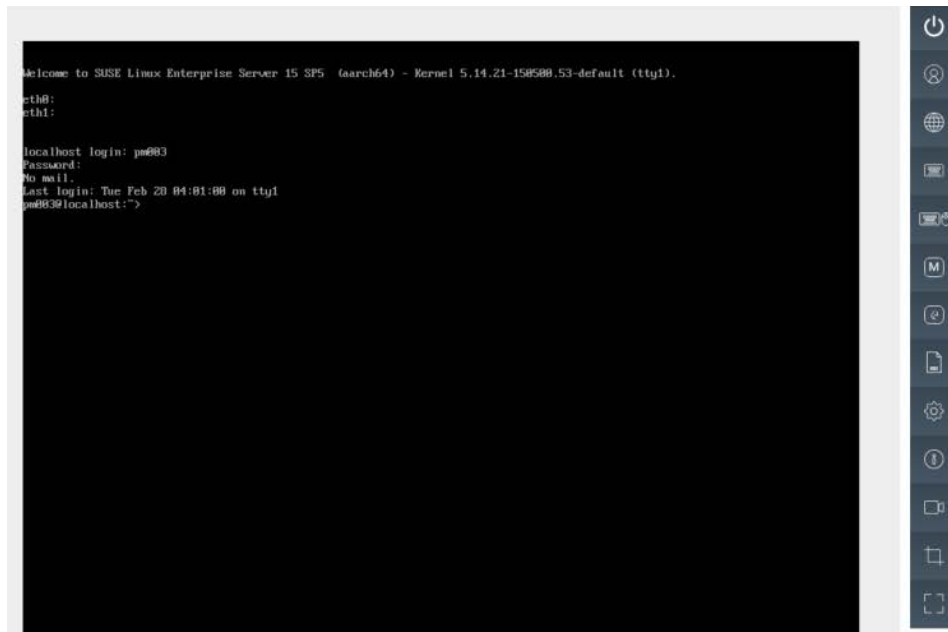

## 5.4 SuperDoctor® 5

The Supermicro SuperDoctor 5 is a program that functions in a command-line or web-based interface for Windows and Linux operating systems. The program monitors such system health information as CPU temperature, system voltages, system power consumption, fan speed, and provides alerts via email or Simple Network Management Protocol (SNMP).

SuperDoctor 5 comes in local and remote management versions and can be used with Nagios to maximize your system monitoring needs. With SuperDoctor 5 Management Server (SSM Server), you can remotely control power on/off and reset chassis intrusion for multiple systems with SuperDoctor 5 or IPMI. SuperDoctor 5 Management Server monitors HTTP, FTP, and SMTP services to optimize the efficiency of your operation.

[SuperDoctor® Manual and Resources](#)



Figure 5-1. SuperDoctor 5 Interface Display Screen (Health Information)

## 5.5 IPMI

The G1SMH-G supports the Intelligent Platform Management Interface (IPMI). IPMI is used to provide remote access, monitoring and management. There are several BIOS settings that are related to IPMI.

Supermicro ships standard products with a unique password for the BMC ADMIN user. This password can be found on a label on the motherboard.

For general documentation and information on IPMI, please visit our website at:

<http://www.supermicro.com/products/nfo/IPMI.cfm>.

## Chapter 6

# Troubleshooting and Support

## 6.1 Information Resources

### Website

A great deal of information is available on the Supermicro [website](#).



**Figure 6-1. Supermicro Website**

- Specifications for servers and other hardware are available by clicking **Products** option.
- The **Support** option offers downloads (manuals, BIOS/BMC, drivers, etc.), FAQs, RMA, warranty, and other service extensions.

### ***Direct Links for the ARS-111GL-DNHR-LCC System***

[ARS-111GL-DNHR-LCC specifications page](#)

[G1SMH-G motherboard page](#) for links to the Quick Reference Guide, User Manual, validated storage drives, etc.

### ***Direct Links for General Support and Information***

[Frequently Asked Questions](#)

[Add-on Card Descriptions](#)

[TPM User Guide](#)

[BMC User Guide](#)

[SuperDoctor5 Large Deployment Guide](#)

For validated memory, use our [Product Resources page](#).

### Direct Links (continued)

[Product Matrices](#) page for links to tables summarizing specs for systems, motherboards, power supplies, riser cards, add-on cards, etc.

[Security Center](#) for recent security notices

[Supermicro Phone and Addresses](#)

## 6.2 Baseboard Management Controller (BMC)

The system supports the Baseboard Management Controller (BMC). BMC is used to provide remote access, monitoring, and management. There are several BIOS settings that are related to BMC.

For general documentation and information on BMC, please visit our website at: <https://www.supermicro.com/en/solutions/management-software/bmc-resources>.

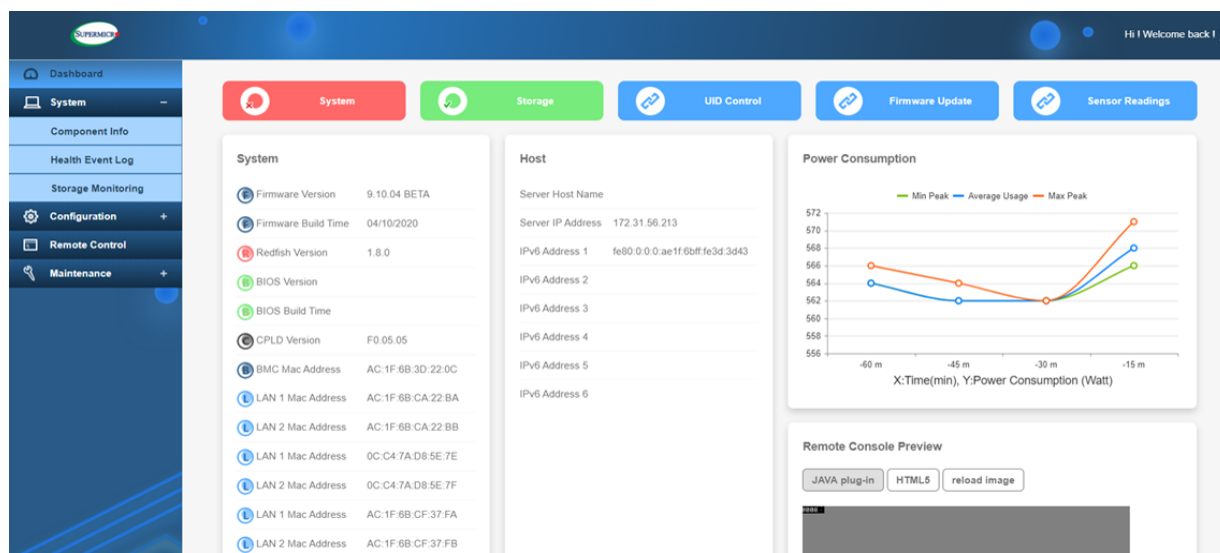

Figure 6-2. BMC Dashboard

## 6.3 Troubleshooting Procedures

Use the following procedures to troubleshoot your system. If you have followed all of the procedures below and still need assistance, refer to the [Technical Support Procedures](#) or [Returning Merchandise for Service](#) section(s) in this chapter. Always disconnect the AC power cables before adding, changing or installing any non hot-swap hardware components. If the below steps do not fix the setup configuration problem, contact your vendor for repairs.

### Before Power On

1. Make sure that there are no short circuits between the motherboard and the chassis.
2. Disconnect all ribbon/wire cables from the motherboard, including those for the keyboard and mouse.
3. Remove all add-on cards.
4. Install the CPU (making sure it is fully seated) and connect the front panel connectors to the motherboard.

### No Power

1. Make sure that there are no short circuits between the motherboard and the chassis.
2. The battery on your motherboard may be old. Check to verify that it still supplies approximately 3 VDC. If it does not, replace it with a new one.

### No Video

1. If the power is on, but you do not have video, remove all add-on cards and cables.
2. Remove all memory modules and turn on the system (if the alarm is on, check the specs of memory modules, reset the memory, or try a different one).

### System Boot Failure

If the system does not display POST (Power-On-Self-Test) or does not respond after the power is turned on, check the following:

1. Remove all components from the motherboard, especially the DIMM modules. Power on the system and check if the power-on LED (PWR\_LED1) is on and the system fans are spinning.
2. Turn on the system with only one DIMM module installed. If the system boots, check for bad DIMM modules or slots by following the Memory Errors Troubleshooting procedure in this chapter.

## Losing the System's Setup Configuration

1. Make sure that you are using a high-quality power supply. A poor-quality power supply may cause the system to lose the CMOS setup information. Refer to [Chapter 1](#) for details on recommended power supplies.
2. The battery on your motherboard may be old. Check to verify that it still supplies approximately 3 VDC. If it does not, replace it with a new one.

## When the System Becomes Unstable

### ***A. If the system becomes unstable during or after OS installation, check the following:***

1. CPU/BIOS support: Make sure that your CPU is supported and that you have the latest BIOS installed in your system.
2. Storage Drive support: Make sure that all storage drives work properly. Replace the failed storage drives with good ones.
3. System cooling: Check the system cooling to make sure that all heatsink fans and CPU/system fans, etc., work properly. Check the hardware monitoring settings in the BMC to make sure that the CPU and system temperatures are within the normal range. Also, check the front panel Overheat LED and make sure that it is not on.
4. Adequate power supply: Make sure that the power supply provides adequate power to the system. Make sure that all power connectors are connected. Please refer to our website for more information on the minimum power requirements.
5. Proper software support: Make sure that the correct drivers are used.

### ***B. If the system becomes unstable before or during OS installation, check the following:***

1. Source of installation: Make sure that the devices used for installation are working properly, including boot devices such as CD/Media drive.
2. Cable connection: Check to make sure that all cables are connected and working properly.
3. Using the minimum configuration for troubleshooting: Remove all unnecessary components (starting with add-on cards first), and use the minimum configuration (but with a CPU and a memory module installed) to identify the trouble areas. Refer to the steps listed in [Section 6.3](#) above for proper troubleshooting procedures.
4. Identifying bad components by isolating them. If necessary, remove a component in question from the chassis, and test it in isolation to make sure that it works properly. Replace a bad component with a good one.

5. Check and change one component at a time instead of changing several items at the same time. This will help isolate and identify the problem.
6. To find out if a component is good, swap this component with a new one to see if the system will work properly. If so, then the old component is bad. You can also install the component in question in another system. If the new system works, the component is good and the old system has problems.

## 6.4 Where to Get Replacement Components

If you need replacement parts for your system, to ensure the highest level of professional service and technical support, purchase exclusively from our Supermicro Authorized Distributors/System Integrators/Resellers. A list can be found at: <http://www.supermicro.com/>. Click the "Where to Buy" tab.

## 6.5 Technical Support Procedures

Before contacting Technical Support, please take the following steps. Also, please note that as a motherboard manufacturer, Supermicro also sells motherboards through its channels, so it is best to first check with your distributor or reseller for troubleshooting services. They should know of any possible problems with the specific system configuration that was sold to you.

1. Please go through the Troubleshooting Procedures and Frequently Asked Questions (FAQ) sections in this chapter or see the FAQs on our website (<http://www.supermicro.com/FAQ/index.php>) before contacting Technical Support.
2. BIOS upgrades can be downloaded from our website ([http://www.supermicro.com/ResourceApps/BIOS\\_BMC\\_Intel.html](http://www.supermicro.com/ResourceApps/BIOS_BMC_Intel.html)).
3. If you still cannot resolve the problem, include the following information when contacting Supermicro for technical support:
  - Motherboard model and PCB revision number
  - BIOS release date/version (This can be seen on the initial display when your system first boots up.)
  - System configuration
4. An example of a Technical Support form is on our website at <http://www.supermicro.com/RmaForm/>.
5. Distributors: For immediate assistance, please have your account number ready when placing a call to our Technical Support department. We can be reached by email at [support@supermicro.com](mailto:support@supermicro.com).

## Returning Merchandise for Service

A receipt or copy of your invoice marked with the date of purchase is required before any warranty service will be rendered. You can obtain service by calling your vendor for a Returned Merchandise Authorization (RMA) number. When returning to the manufacturer, the RMA number should be prominently displayed on the outside of the shipping carton, and mailed prepaid or hand-carried. Shipping and handling charges will be applied for all orders that must be mailed when service is complete.

For faster service, RMA authorizations may be requested online (<http://www.supermicro.com/support/rma/>).

This warranty only covers normal consumer use and does not cover damages incurred in shipping or from failure due to the alternation, misuse, abuse or improper maintenance of products.

During the warranty period, contact your distributor first for any product problems.

## 6.6 Feedback

Supermicro values your feedback as we strive to improve our customer experience in all facets of our business. To provide feedback on our manuals, please email us at [techwriterteam@supermicro.com](mailto:techwriterteam@supermicro.com).

## 6.7 Contacting Supermicro

### Headquarters

Address: Super Micro Computer, Inc.  
980 Rock Ave.  
San Jose, CA 95131 U.S.A.

Tel: +1 (408) 503-8000

Fax: +1 (408) 503-8008

Email: [marketing@supermicro.com](mailto:marketing@supermicro.com) (General Information)  
[Sales-USA@supermicro.com](mailto:Sales-USA@supermicro.com) (Sales Inquiries)  
[Government\\_Sales-USA@supermicro.com](mailto:Government_Sales-USA@supermicro.com) (Gov. Sales Inquiries)  
[support@supermicro.com](mailto:support@supermicro.com) (Technical Support)  
[RMA@supermicro.com](mailto:RMA@supermicro.com) (RMA Support)  
[Webmaster@supermicro.com](mailto:Webmaster@supermicro.com) (Webmaster)

Website: [www.supermicro.com](http://www.supermicro.com)

### Europe

Address: Super Micro Computer B.V.  
Het Sterrenbeeld 28, 5215 ML  
's-Hertogenbosch, The Netherlands

Tel: +31 (0) 73-6400390

Fax: +31 (0) 73-6416525

Email: [Sales\\_Europe@supermicro.com](mailto:Sales_Europe@supermicro.com) (Sales Inquiries)  
[Support\\_Europe@supermicro.com](mailto:Support_Europe@supermicro.com) (Technical Support)  
[RMA\\_Europe@supermicro.com](mailto:RMA_Europe@supermicro.com) (RMA Support)

Website: [www.supermicro.nl](http://www.supermicro.nl)

### Asia-Pacific

Address: Super Micro Computer, Inc.  
3F, No. 150, Jian 1st Rd.  
Zhonghe Dist., New Taipei City 235  
Taiwan (R.O.C)

Tel: +886-(2) 8226-3990

Fax: +886-(2) 8226-3992

Email: [Sales-Asia@supermicro.com.tw](mailto:Sales-Asia@supermicro.com.tw) (Sales Inquiries)  
[Support@supermicro.com.tw](mailto:Support@supermicro.com.tw) (Technical Support)  
[RMA@supermicro.com.tw](mailto:RMA@supermicro.com.tw) (RMA Support)

Website: [www.supermicro.com.tw](http://www.supermicro.com.tw)

## Appendix A

# Standardized Warning Statements for AC Systems

## About Standardized Warning Statements

The following statements are industry standard warnings, provided to warn the user of situations which have the potential for bodily injury. Should you have questions or experience difficulty, contact Supermicro's Technical Support department for assistance. Only certified technicians should attempt to install or configure components.

Read this appendix in its entirety before installing or configuring components in the Supermicro chassis.

These warnings may also be found on our website at [http://www.supermicro.com/about/policies/safety\\_information.cfm](http://www.supermicro.com/about/policies/safety_information.cfm).

## Warning Definition



**Warning!** This warning symbol means danger. You are in a situation that could cause bodily injury. Before you work on any equipment, be aware of the hazards involved with electrical circuitry and be familiar with standard practices for preventing accidents.

### 警告の定義

この警告サインは危険を意味します。

人身事故につながる可能性がありますので、いずれの機器でも動作させる前に、電気回路に含まれる危険性に注意して、標準的な事故防止策に精通して下さい。

此警告符号代表危險。

您正处于可能受到严重伤害的工作环境中。在您使用设备开始工作之前，必须充分意识到触电的危险，并熟练掌握防止事故发生的标准工作程序。请根据每项警告结尾的声明号码找到此设备的安全性警告说明的翻译文本。

此警告符號代表危險。

您正處於可能身體可能會受損傷的工作環境中。在您使用任何設備之前，請注意觸電的危險，並且要熟悉預防事故發生的標準工作程序。請依照每一注意事項後的號碼找到相關的翻譯說明內容。

## Warnung

### WICHTIGE SICHERHEITSHINWEISE

Dieses Warnsymbol bedeutet Gefahr. Sie befinden sich in einer Situation, die zu Verletzungen führen kann. Machen Sie sich vor der Arbeit mit Geräten mit den Gefahren elektrischer Schaltungen und den üblichen Verfahren zur Vorbeugung vor Unfällen vertraut. Suchen Sie mit der am Ende jeder Warnung angegebenen Anweisungsnummer nach der jeweiligen Übersetzung in den übersetzten Sicherheitshinweisen, die zusammen mit diesem Gerät ausgeliefert wurden.

BEWAHREN SIE DIESE HINWEISE GUT AUF.

### INSTRUCCIONES IMPORTANTES DE SEGURIDAD

Este símbolo de aviso indica peligro. Existe riesgo para su integridad física. Antes de manipular cualquier equipo, considere los riesgos de la corriente eléctrica y familiarícese con los procedimientos estándar de prevención de accidentes. Al final de cada advertencia encontrará el número que le ayudará a encontrar el texto traducido en el apartado de traducciones que acompaña a este dispositivo.

GUARDE ESTAS INSTRUCCIONES.

### IMPORTANTES INFORMATIONS DE SÉCURITÉ

Ce symbole d'avertissement indique un danger. Vous vous trouvez dans une situation pouvant entraîner des blessures ou des dommages corporels. Avant de travailler sur un équipement, soyez conscient des dangers liés aux circuits électriques et familiarisez-vous avec les procédures couramment utilisées pour éviter les accidents. Pour prendre connaissance des traductions des avertissements figurant dans les consignes de sécurité traduites qui accompagnent cet appareil, référez-vous au numéro de l'instruction situé à la fin de chaque avertissement.

CONSERVEZ CES INFORMATIONS.

## תקנון הזהרות אזהרה

הזהרות הבאות הן אזהרות על פי תקני התעשייה, על מנת להזהיר את המשתמש מפני חבלה פיזית אפשרית. במידה ויש שאלות או היתקלות בבעיה כלשהי, יש ליצור קשר עם מחלקת תמיכה טכנית של סופרמיקרו. טכנאים מוסמכים בלבד רשאים להתקין או להגדיר את הרכיבים. יש לקרוא את הנספח במלואו לפני התקנת או הגדרת הרכיבים במארזי סופרמיקרו.

اَكْ ف حالة وُكِي اَي تتسبب ف اصابة جسدهُ هذا الزهز عُ خطر! تحذُرُ .  
 قبل اَي تعول على اَي هعدات، كي على علن بالوخاطز ال اُجوة عي الذوائر  
 الكهزبائِة  
 وكي على دراةُ بالووارسات النقاىِة لو عُ وقع اَي حادث  
 استخدم رقن الب اى الو صُص ف هاةُ كل تحذُرُ للعشر تزجوتها

안전을 위한 주의사항

경고!

이 경고 기호는 위험이 있음을 알려 줍니다. 작업자의 신체에 부상을 야기 할 수 있는 상태에 있게 됩니다. 모든 장비에 대한 작업을 수행하기 전에 전기회로와 관련된 위험요소들을 확인하시고 사전에 사고를 방지할 수 있도록 표준 작업절차를 준수해 주시기 바랍니다.

해당 번역문을 찾기 위해 각 경고의 마지막 부분에 제공된 경고문 번호를 참조하십시오

## BELANGRIJKE VEILIGHEIDSINSTRUCTIES

Dit waarschuwings symbool betekent gevaar. U verkeert in een situatie die lichamelijk letsel kan veroorzaken. Voordat u aan enige apparatuur gaat werken, dient u zich bewust te zijn van de bij een elektrische installatie betrokken risico's en dient u op de hoogte te zijn van de standaard procedures om ongelukken te voorkomen. Gebruik de nummers aan het eind van elke waarschuwing om deze te herleiden naar de desbetreffende locatie.

BEWAAR DEZE INSTRUCTIES

## Installation Instructions



**Warning!** Read the installation instructions before connecting the system to the power source.

設置手順書

システムを電源に接続する前に、設置手順書をお読み下さい。

警告

将此系统连接电源前,请先阅读安装说明。

警告

將系統與電源連接前，請先閱讀安裝說明。

**Warnung**

Vor dem Anschließen des Systems an die Stromquelle die Installationsanweisungen lesen.

**¡Advertencia!**

Lea las instrucciones de instalación antes de conectar el sistema a la red de alimentación.

**Attention**

Avant de brancher le système sur la source d'alimentation, consulter les directives d'installation.

יש לקרוא את הוראות התקנה לפני חיבור המערכת למקור מתח.

اقر إرشادات التركيب قبل توصيل النظام إلى مصدر للطاقة

시스템을 전원에 연결하기 전에 설치 안내를 읽어주십시오.

**Waarschuwing**

Raadpleeg de installatie-instructies voordat u het systeem op de voedingsbron aansluit.

**Circuit Breaker**

**Warning!** This product relies on the building's installation for short-circuit (overcurrent) protection. Ensure that the protective device is rated not greater than: 250 V, 20 A.

**サーキット・ブレーカー**

この製品は、短絡(過電流)保護装置がある建物での設置を前提としています。

保護装置の定格が250 V、20 Aを超えないことを確認下さい。

**警告**

此产品的短路(过载电流)保护由建筑物的供电系统提供,确保短路保护设备的额定电流不大于250V,20A。

**警告**

此產品的短路(過載電流)保護由建築物的供電系統提供,確保短路保護設備的額定電流不大於250V,20A。

**Warnung**

Dieses Produkt ist darauf angewiesen, dass im Gebäude ein Kurzschluss- bzw. Überstromschutz installiert ist. Stellen Sie sicher, dass der Nennwert der Schutzvorrichtung nicht mehr als: 250 V, 20 A beträgt.

**¡Advertencia!**

Este equipo utiliza el sistema de protección contra cortocircuitos (o sobrecorrientes) del edificio. Asegúrese de que el dispositivo de protección no sea superior a: 250 V, 20 A.

**Attention**

Pour ce qui est de la protection contre les courts-circuits (surtension), ce produit dépend de l'installation électrique du local. Vérifiez que le courant nominal du dispositif de protection n'est pas supérieur à :250 V, 20 A.

מוצר זה מסתמך על הגנה המותקנת במבנים למניעת קצר חשמלי. יש לוודא כי המכשיר המגן מפני הקצר החשמלי הוא לא יותר מ-250VDC, 20A

هذا المنتج يعتمد على معدات الحماية مه الدوائر القصيرة التي تم تثبيتها في المبنى  
تأكد من أن تقييم الجهاز الوقائي ليس أكثر من : 20A, 250V

**경고!**

이 제품은 전원의 단락(과전류)방지에 대해서 전적으로 건물의 관련 설비에 의존합니다. 보호장치의 정격이 반드시 250V(볼트), 20A(암페어)를 초과하지 않도록 해야 합니다.

**Waarschuwing**

Dit product is afhankelijk van de kortsluitbeveiliging (overspanning) van uw elektrische installatie. Controleer of het beveiligde apparaat niet groter gedimensioneerd is dan 250V, 20A.

## Power Disconnection Warning



**Warning!** The system must be disconnected from all sources of power and the power cord removed from the power supply module(s) before accessing the chassis interior to install or remove system components (except for hot-swap components).



### 電源切断の警告

システムコンポーネントの取り付けまたは取り外しのために、シャーシ内部にアクセスするには、システムの電源はすべてのソースから切断され、電源コードは電源モジュールから取り外す必要があります。

### 警告

在你打开机箱并安装或移除内部器件前,必须将系统完全断电,并移除电源线。

### 警告

在您打開機殼安裝或移除內部元件前，必須將系統完全斷電，並移除電源線。

### Warnung

Das System muss von allen Quellen der Energie und vom Netzanschlusskabel getrennt sein, das von den Spg.Versorgungsteilmodulen entfernt wird, bevor es auf den Chassisinnenraum zurückgreift, um Systemsbestandteile anzubringen oder zu entfernen.

### ¡Advertencia!

El sistema debe ser disconnected de todas las fuentes de energía y del cable eléctrico quitado de los módulos de fuente de alimentación antes de tener acceso el interior del chasis para instalar o para quitar componentes de sistema.

### Attention

Le système doit être débranché de toutes les sources de puissance ainsi que de son cordon d'alimentation secteur avant d'accéder à l'intérieur du chassis pour installer ou enlever des composants de système.

אזהרה מפני ניתוק חשמלי

אזהרה!

יש לנתק את המערכת מכל מקורות החשמל ויש להסיר את כבל החשמלי מהספק לפני גישה לחלק הפנימי של המארז לצורך התקנת או הסרת רכיבים.

يجب فصل انظاؤ من جميع مصادر انطاقت وإزانت سهك انكهرباء من وحدة امداد انطاقت قيم

انصل إلى امناطق انداخييت نههيكم نشييج أو إزانت مكنناث الجهاز

경고!

시스템에 부품들을 장착하거나 제거하기 위해서는 새시 내부에 접근하기 전에 반드시 전원 공급장치로부터 연결되어있는 모든 전원과 전기코드를 분리해주어야 합니다.

Waarschuwing

Voordat u toegang neemt tot het binnenwerk van de behuizing voor het installeren of verwijderen van systeem onderdelen, dient u alle spanningsbronnen en alle stroomkabels aangesloten op de voeding(en) van de behuizing te verwijderen

## Equipment Installation



**Warning!** Only authorized personnel and qualified service persons should be allowed to install, replace, or service this equipment.

機器の設置

トレーニングを受け認定された人だけがこの装置の設置、交換、またはサービスを許可されています。

警告

只有经过培训且具有资格的人员才能进行此设备的安装、更换和维修。

警告

只有經過受訓且具資格人員才可安裝、更換與維修此設備。

Warnung

Nur autorisiertes Personal und qualifizierte Servicetechniker dürfen dieses Gerät installieren, austauschen oder warten..

¡Advertencia!

Sólo el personal autorizado y el personal de servicio calificado deben poder instalar, reemplazar o dar servicio a este equipo.

**Attention**

Seul le personnel autorisé et le personnel de maintenance qualifié doivent être autorisés à installer, remplacer ou entretenir cet équipement..

אזהרה!

יש לאפשר רק צוות מורשה ואנשי שירות מוסמכים להתקין, להחליף או לטפל בציוד זה.

ينبغي السماح فقط للموظفين المعتمدين وأفراد الخدمة المؤهلين بتركيب هذا الجهاز أو استبداله أو صيانته.

**경고!**

승인된 직원과 자격을 갖춘 서비스 담당자만이 이 장비를 설치, 교체 또는 서비스할 수 있습니다.

**Waarschuwing**

Alleen geautoriseerd personeel en gekwalificeerd onderhoudspersoneel mag deze apparatuur installeren, vervangen of onderhouden..

**Restricted Area**

**Warning!** This unit is intended for installation in restricted access areas. A restricted access area can be accessed only through the use of a special tool, lock and key, or other means of security. (This warning does not apply to workstations).

**アクセス制限区域**

このユニットは、アクセス制限区域に設置されることを想定しています。

アクセス制限区域は、特別なツール、鍵と錠前、その他のセキュリティの手段を用いてのみ出入りが可能です。

**警告**

此部件应安装在限制进出的场所，限制进出的场所指只能通过使用特殊工具、锁和钥匙或其它安全手段进出的场所。

**警告**

此裝置僅限安裝於進出管制區域，進出管制區域係指僅能以特殊工具、鎖頭及鑰匙或其他安全方式才能進入的區域。

**Warnung**

Diese Einheit ist zur Installation in Bereichen mit beschränktem Zutritt vorgesehen. Der Zutritt zu derartigen Bereichen ist nur mit einem Spezialwerkzeug, Schloss und Schlüssel oder einer sonstigen Sicherheitsvorkehrung möglich.

**¡Advertencia!**

Esta unidad ha sido diseñada para instalación en áreas de acceso restringido. Sólo puede obtenerse acceso a una de estas áreas mediante la utilización de una herramienta especial, cerradura con llave u otro medio de seguridad.

**Attention**

Cet appareil doit être installée dans des zones d'accès réservés. L'accès à une zone d'accès réservé n'est possible qu'en utilisant un outil spécial, un mécanisme de verrouillage et une clé, ou tout autre moyen de sécurité.

אזור עם גישה מוגבלת

אזהרה!

יש להתקין את היחידה באזורים שיש בהם הגבלת גישה. הגישה ניתנת בעזרת 'כלי אבטחה בלבד' (מפתח, מנעול וכד.).

تخصيص هذه انحدة نترك بُها ف مناطق محظورة تم .  
ممكن اننصل إن منطقت محظورة فقط من خلال استخداو أداة خاصت  
أو أ وس هُت أخري نلالأمما ققم ومفتاح

**경고!**

이 장치는 접근이 제한된 구역에 설치하도록 되어있습니다. 특수도구, 잠금 장치 및 키, 또는 기타 보안 수단을 통해서만 접근 제한 구역에 들어갈 수 있습니다.

**Waarschuwing**

Dit apparaat is bedoeld voor installatie in gebieden met een beperkte toegang. Toegang tot dergelijke gebieden kunnen alleen verkregen worden door gebruik te maken van speciaal gereedschap, slot en sleutel of andere veiligheidsmaatregelen.

## Battery Handling



**CAUTION:** There is risk of explosion if the battery is replaced by an incorrect type. Replace the battery only with the same or equivalent type recommended by the manufacturer. Dispose of used batteries according to the manufacturer's instructions

### 電池の取り扱い

バッテリーを間違ったタイプに交換すると爆発の危険があります。交換する電池はメーカーが推奨する型、または同等のものを使用下さい。使用済電池は製造元の指示に従って処分して下さい。

### 警告

如果更换的电池类型不正确，则存在爆炸危险。请只使用同类电池或制造商推荐的功能相当的电池更换原有电池。请按制造商的说明处理废旧电池。

### 警告

如果更換的電池類型不正確，則有爆炸危險。請使用製造商建議之相同或功能相當的電池更換原有電池。請按照製造商的說明指示處理廢棄舊電池。

### WARNUNG

Es besteht Explosionsgefahr, wenn die Batterie durch einen falschen Typ ersetzt wird. Ersetzen Sie die Batterie nur durch den gleichen oder vom Hersteller empfohlenen Batterietyp. Entsorgen Sie die benutzten Batterien nach den Anweisungen des Herstellers.

### ATTENTION

Il existe un risque d'explosion si la batterie est remplacée par un type incorrect. Ne la remplacer que par une pile de type semblable ou équivalent, recommandée par le fabricant. Jeter les piles usagées conformément aux instructions du fabricant.

### ADVERTENCIA

Existe riesgo de explosión si la batería se reemplaza por un tipo incorrecto. Reemplazar la batería exclusivamente con el mismo tipo o el equivalente recomendado por el fabricante. Desechar las baterías gastadas según las instrucciones del fabricante.

אזהרה!

קיימת סכנת פיצוץ אם הסוללה תוחלף בסוג שגוי. יש להחליף את הסוללה בסוג התואם מחברת יצרן מומלצת. סילוק הסוללות המשומשות יש לבצע לפי הוראות היצרן.

هناك خطر الانفجار إذا تم استبدال البطارية بنوع غير صحيح.  
 اسحبذال البطارية  
 فقط بنفس النوع أو ما يعادلها مما أوصت به الشركة المصنعة  
 جخلص من البطاريات المسحمة وفقا لعمليات الشركة الصانعة

경고!

배터리를 잘못된 종류로 교체하면 폭발의 위험이 있습니다. 기존 배터리와 동일하거나 제조사에서 권장하는 동등한 종류의 배터리로만 교체해야 합니다. 제조사의 안내에 따라 사용된 배터리를 처리하여 주십시오.

#### WAARSCHUWING

Er bestaat explosiegevaar als de batterij wordt vervangen door een verkeerd type. Vervang de batterij slechts met hetzelfde of een equivalent type die door de fabrikant aanbevolen wordt. Gebruikte batterijen dienen overeenkomstig fabrieksvoorschriften afgevoerd te worden.

### Redundant Power Supplies



**Warning!** This unit might have more than one power supply connection. All connections must be removed to de-energize the unit.

冗長電源装置

このユニットは複数の電源装置が接続されている場合があります。

ユニットの電源を切るためには、すべての接続を取り外さなければなりません。

警告

此部件连接的电源可能不止一个，必须将所有电源断开才能停止给该部件供电。

警告

此装置连接的电源可能不只一个，必须切断所有电源才能停止对该装置的供电。

Warnung

Dieses Gerät kann mehr als eine Stromzufuhr haben. Um sicherzustellen, dass der Einheit kein Strom zugeführt wird, müssen alle Verbindungen entfernt werden.

## ¡Advertencia!

Puede que esta unidad tenga más de una conexión para fuentes de alimentación. Para cortar por completo el suministro de energía, deben desconectarse todas las conexiones.

## Attention

Cette unité peut avoir plus d'une connexion d'alimentation. Pour supprimer toute tension et tout courant électrique de l'unité, toutes les connexions d'alimentation doivent être débranchées.

אם קיים יותר מספק אחד

אזהרה!

ליחידה יש יותר מחיבור אחד של ספק. יש להסיר את כל החיבורים על מנת לרוקן את היחידה.

قد يكون لهذا الجهاز عدة اتصالات بوحدات امداد الطاقة .

يجب إزالة كافة الاتصالات لعسل الوحدة عن الكهرباء

## 경고!

이 장치에는 한 개 이상의 전원 공급 단자가 연결되어 있을 수 있습니다. 이 장치에 전원을 차단하기 위해서는 모든 연결 단자를 제거해야만 합니다.

## Waarschuwing

Deze eenheid kan meer dan één stroomtoevoeraansluiting bevatten. Alle aansluitingen dienen verwijderd te worden om het apparaat stroomloos te maken.

## Backplane Voltage



**Warning!** Hazardous voltage or energy is present on the backplane when the system is operating. Use caution when servicing.

バックプレーンの電圧

システムの稼働中は危険な電圧または電力が、バックプレーン上にかかっています。

修理する際には注意ください。

警告

当系统正在进行时，背板上有很危险的电压或能量，进行维修时务必小心。

警告

當系統正在進行時，背板上危險的電壓或能量，進行維修時務必小心。

Warnung

Wenn das System in Betrieb ist, treten auf der Rückwandplatine gefährliche Spannungen oder Energien auf. Vorsicht bei der Wartung.

¡Advertencia!

Cuando el sistema está en funcionamiento, el voltaje del plano trasero es peligroso. Tenga cuidado cuando lo revise.

Attention

Lorsque le système est en fonctionnement, des tensions électriques circulent sur le fond de panier. Prendre des précautions lors de la maintenance.

מתח בפנל האחורי

אזהרה!

קיימת סכנת מתח בפנל האחורי בזמן תפעול המערכת. יש להיזהר במהלך העבודה.

هناك خطر من التيار الكهربائي أو الطاقة المتجددة على اللوحة  
عندما يكون النظام يعمل كه حذرا عند خدمة هذا الجهاز

경고!

시스템이 동작 중일 때 후면판 (Backplane)에는 위험한 전압이나 에너지가 발생 합니다.  
서비스 작업 시 주의하십시오.

Waarschuwing

Een gevaarlijke spanning of energie is aanwezig op de backplane wanneer het systeem in gebruik is. Voorzichtigheid is geboden tijdens het onderhoud.

## Comply with Local and National Electrical Codes



**Warning!** Installation of the equipment must comply with local and national electrical codes.

地方および国の電気規格に準拠

機器の取り付けはその地方および国の電気規格に準拠する必要があります。

警告

设备安装必须符合本地与本国电气法规。

警告

設備安裝必須符合本地與本國電氣法規。

Warnung

Die Installation der Geräte muss den Sicherheitsstandards entsprechen.

¡Advertencia!

La instalación del equipo debe cumplir con las normas de electricidad locales y nacionales.

Attention

L'équipement doit être installé conformément aux normes électriques nationales et locales.

תיאום חוקי החשמל הארצי  
אזהרה!  
התקנת הציוד חייבת להיות תואמת לחוקי החשמל המקומיים והארציים.

تركيب المعدات الكهربائية يجب أن يمتثل للقوايه المحلية والبطية المتعلقة  
بالكهرباء

경고!

현 지역 및 국가의 전기 규정에 따라 장비를 설치해야 합니다.

Waarschuwing

Bij installatie van de apparatuur moet worden voldaan aan de lokale en nationale elektriciteitsvoorschriften.

## Product Disposal



**Warning!** Ultimate disposal of this product should be handled according to all national laws and regulations.

製品の廃棄

この製品を廃棄処分する場合、国の関係する全ての法律・条例に従い処理する必要があります。

警告

本产品的废弃处理应根据所有国家的法律和规章进行。

警告

本產品的廢棄處理應根據所有國家的法律和規章進行。

Warnung

Die Entsorgung dieses Produkts sollte gemäß allen Bestimmungen und Gesetzen des Landes erfolgen.

¡Advertencia!

Al deshacerse por completo de este producto debe seguir todas las leyes y reglamentos nacionales.

## Attention

La mise au rebut ou le recyclage de ce produit sont généralement soumis à des lois et/ou directives de respect de l'environnement. Renseignez-vous auprès de l'organisme compétent.

סילוק המוצר

אזהרה!

סילוק סופי של מוצר זה חייב להיות בהתאם להנחיות וחוקי המדינה.

التخلص النهائي من هذا المنتج ينبغي التعامل معه وفقا لجميع القوانين واللوائح الوطنية عند

경고!

이 제품은 해당 국가의 관련 법규 및 규정에 따라 폐기되어야 합니다.

## Waarschuwing

De uiteindelijke verwijdering van dit product dient te geschieden in overeenstemming met alle nationale wetten en reglementen.

## Fan Warning



**Warning!** Hazardous moving parts. Keep away from moving fan blades. The fans might still be turning when you remove the fan assembly from the chassis. Keep fingers, screwdrivers, and other objects away from the openings in the fan assembly's housing.

ファンの警告

警告!回転部品に注意。運転中は回転部(羽根)に触れないでください。シャーシから冷却ファン装置を取り外した際、ファンがまだ回転している可能性があります。ファンの開口部に、指、ドライバー、およびその他のものを近づけないで下さい。

警告!

警告! 危险的可移动性零件。请务必与转动的风扇叶片保持距离。当您从机架移除风扇装置，风扇可能仍在转动。小心不要将手指、螺丝起子和其他物品太靠近风扇

警告

危险的可移动性零件。请务必与转动的风扇叶片保持距离。当您从机架移除风扇装置，风扇可能仍在转动。小心不要将手指、螺丝起子和其他物品太靠近风扇。

**Warnung**

Gefährlich Bewegende Teile. Von den bewegenden Lüfterblätter fern halten. Die Lüfter drehen sich u. U. noch, wenn die Lüfterbaugruppe aus dem Chassis genommen wird. Halten Sie Finger, Schraubendreher und andere Gegenstände von den Öffnungen des Lüftergehäuses entfernt.

**¡Advertencia!**

Riesgo de piezas móviles. Mantener alejado de las aspas del ventilador. Los ventiladores podran dar vuelta cuando usted quite el montaje del ventilador del chasis. Mantenga los dedos, los destornilladores y todos los objetos lejos de las aberturas del ventilador

**Attention**

Pieces mobiles dangereuses. Se tenir a l'écart des lames du ventilateur Il est possible que les ventilateurs soient toujours en rotation lorsque vous retirerez le bloc ventilateur du châssis. Prenez garde à ce que doigts, tournevis et autres objets soient éloignés du logement du bloc ventilateur.

**אזהרה!**

חלקים נעים מסוכנים. התרחק מלהבי המאוורר בפעולה כאשר מסירים את חלקי המאוורר מהמארז, יתכן והמאווררים עדיין עובדים. יש להרחיק למרחק בטוח את האצבעות וכלי עבודה שונים מהפתחים בתוך המאוורר

تحذير! أجزاء متحركة خطيرة. ابتعد عن شفرات المروحة المتحركة. من الممكن أن المراوح لا تزال تدور عند إزالة كتلة المروحة من الهيكل يجب إبقاء الأصابع ومفكات البراغي وغيرها من الأشياء بعيدا عن الفتحات في كتلة المروحة.

**경고!**

움직이는 위험한 부품. 회전하는 송풍 날개에 접근하지 마세요. 새시로부터 팬 조립품을 제거할 때 팬은 여전히 회전하고 있을 수 있습니다. 팬 조립품 외관의 열려있는 부분들로부터 손가락 및 스크류드라이버, 다른 물체들이 가까이 하지 않도록 배치해 주십시오.

**Waarschuwing**

Gevaarlijk bewegende onderdelen. Houd voldoende afstand tot de bewegende ventilatorbladen. Het is mogelijk dat de ventilator nog draait tijdens het verwijderen van het ventilatorsamenstel uit het chassis. Houd uw vingers, schroevendraaiers en eventuele andere voorwerpen uit de buurt van de openingen in de ventilatorbehuizing.

## Power Cable and AC Adapter



**Warning!** When installing the product, use the provided or designated connection cables, power cables and AC adaptors. Using any other cables and adaptors could cause a malfunction or a fire. Electrical Appliance and Material Safety Law prohibits the use of UL or CSA -certified cables (that have UL/CSA shown on the cord) for any other electrical devices than products designated by Supermicro only.

### 電源コードとACアダプター

製品を設置する場合、提供または指定および購入された接続ケーブル、電源コードとACアダプターを該当する地域の条例や安全基準に適合するコードサイズやプラグと共に使用下さい。他のケーブルやアダプタを使用すると故障や火災の原因になることがあります。

電気用品安全法は、ULまたはCSA認定のケーブル(UL/CSAマークがコードに表記)を Supermicro が指定する製品以外に使用することを禁止しています。

### 警告

安装此产品时,请使用本身提供的或指定的或采购的连接线,电源线和电源适配器。包含遵照当地法规和安全要求的合规的电源线尺寸和插头。使用其它线材或适配器可能会引起故障或火灾。除了Supermicro所指定的产品,电气用品和材料安全法律规定禁止使用未经UL或CSA认证的线材。(线材上会显示UL/CSA符号)。

### 警告

安裝此產品時,請使用本身提供的或指定的或採購的連接線,電源線和電源適配器。包含遵照當地法規和安全要求的合規的電源線尺寸和插頭。使用其它線材或適配器可能會引起故障或火災。除了Supermicro所指定的產品,電氣用品和材料安全法律規定禁止使用未經UL或CSA認證的線材。(線材上會顯示UL/CSA符號)。

### Warnung

Nutzen Sie beim Installieren des Produkts ausschließlich die von uns zur Verfügung gestellten Verbindungskabeln, Stromkabeln und/oder Adapter, die Ihre örtlichen Sicherheitsstandards einhalten. Der Gebrauch von anderen Kabeln und Adapter können Fehlfunktionen oder Feuer verursachen. Die Richtlinien untersagen das Nutzen von UL oder CAS zertifizierten Kabeln (mit UL/CSA gekennzeichnet), an Geräten oder Produkten die nicht mit Supermicro gekennzeichnet sind.

## ¡Advertencia!

Cuando instale el producto, utilice la conexión provista o designada o procure cables, Cables de alimentación y adaptadores de CA que cumplan con los códigos locales y los requisitos de seguridad, incluyendo el tamaño adecuado del cable y el enchufe. El uso de otros cables y adaptadores podría causar un mal funcionamiento o un incendio. La Ley de Seguridad de Aparatos Eléctricos y de Materiales prohíbe El uso de cables certificados por UL o CSA (que tienen el certificado UL / CSA en el código) para cualquier otros dispositivos eléctricos que los productos designados únicamente por Supermicro.

## Attention

Lors de l'installation du produit, utilisez les cables de connection fournis ou désigné ou achetez des cables, cables de puissance et adaptateurs respectant les normes locales et les conditions de securite y compris les tailles de cables et les prises electriques appropriées. L'utilisation d'autres cables et adaptateurs peut provoquer un dysfonctionnement ou un incendie. Appareils électroménagers et la Loi sur la Sécurité Matériel interdit l'utilisation de câbles certifiés- UL ou CSA (qui ont UL ou CSA indiqué sur le code) pour tous les autres appareils électriques sauf les produits désignés par Supermicro seulement.

AC ימאתמו מיילמשח מילבכ

!הרהזא

ךרוצל ומאתוה וא ושכרנ רשא AC מימאתמו מיקפס, מילבכב שמתשהל שי, רצומה תא מיניקתמ רשאכ לכב שומיש . עקתהו לבכה לש הנוכח הדימ ללוכ, תוימוקמה תוחיטבה תושירדל ומאתוה רשאו, הנקתהה למשחה ירישכמב שומישה יקוחל מאתהב. ילמשח רצק וא הלקתל מורגל לולע, רחא גוסמ מאתמ וא לבכ לש דוק מהילע עיפומ רשאכ) UL-ב או CSA-ב -ב מיכמומה מילבכב שמתשהל רוסיא מייק, תוחיטבה יקוחו דבלב Supermicro י"ע מאתוה רשא רצומב קר אלא, רחא ילמשח רצומ לכ רובע (UL/CSA)

תאלבאלא אארשב מץ וא אדדחמלא וא ארפוטמלא תאליצוולא מאדחטסאב מץ, אגתנמלא בייקרת דנע לכלז יפ אמב אילחמלא אלאסלא תאבלטתמו נינאווב מאזתלאלא אמ דדרתמלא ראיטלא תאלוחמו אילברמלא קיירח וא לטע יפ בבסטטי דץ ירשא תאלוחמו תאלבאלא יא מאדחטסא. מילסלא סבאלאו לטוולא מץ ח. CSA וא UL לביק נמ אדמתמלא תאלבאלא מאדחטסא תאדעמלא אילברמלא אזהאלל אלאסלא נונאק רזחי Supermicro לביק נמ אדדחמלא אילחמלא תאגתנמלא רייג ירשא תאדעמ יא אמ (UL/CSA) אלאע למחתיטלאו

### 전원 케이블 및 AC 어댑터

경고! 제품을 설치할 때 현지 코드 및 적절한 굵기의 코드와 플러그를 포함한 안전 요구 사항을 준수하여 제공되거나 지정된 연결 혹은 구매 케이블, 전원 케이블 및 AC 어댑터를 사용하십시오.

다른 케이블이나 어댑터를 사용하면 오작동이나 화재가 발생할 수 있습니다. 전기 용품 안전법은 UL 또는 CSA 인증 케이블 (코드에 UL / CSA가 표시된 케이블)을 Supermicro가 지정한 제품 이외의 전기 장치에 사용하는 것을 금지합니다.

### Stroomkabel en AC-Adapter

Waarschuwing! Bij het aansluiten van het Product uitsluitend gebruik maken van de geleverde Kabels of een andere geschikte aan te schaffen Aansluitmethode, deze moet altijd voldoen aan de lokale voorschriften en veiligheidsnormen, inclusief de juiste kabeldikte en stekker. Het gebruik van niet geschikte Kabels en/of Adapters kan een storing of brand veroorzaken. Wetgeving voor Elektrische apparatuur en Materiaalveiligheid verbied het gebruik van UL of CSA -gecertificeerde Kabels (met UL/CSA in de code) voor elke andere toepassing dan de door Supermicro hiervoor beoogde Producten.

# Appendix B

## System Specifications

### Processor (per Node)

Nvidia Grace CPU Superchip via two Mirror Mezz connectors

**Note:** Refer to the motherboard specifications pages on our website for updates to supported processors.

### GPUs (per Node)

One NVIDIA® H100 Tensor Core GPU on GH200 Grace Hopper™ Superchip (Liquid-cooled), highest GPU communication using NVIDIA NVLINK™

### BIOS

256 Mb SPI AMI BIOS® SM Flash UEFI BIOS

### Memory (per Node)

Embedded 480 GB ECC LPDDR5 with up to 500 GB/s throughput

96 GB of HBM3 memory with up to 4 TB/s of memory bandwidth

### Storage Drives (per Node)

Two front E1.S NVMe drive bays

Two M.2 NVMe slots (M-key)

### PCI Expansion Slots (per Node)

Two PCIe 5.0 x16 slots (one FHFL, one low profile)

### Input/Output (per Node)

One RJ45 1 GbE Dedicated IPMI LAN port

One rear USB port

One mini-DP port

### Motherboard

G1SMH-G; 14" (W) x 10" (L) (355.6 x 254 mm)

### Chassis

CSE-MG102TS-R000NDFP-2N, 2U Rackmount, 438.4 x 88 x 900 mm (17.25" x 3.46" x 35.43")

### System Cooling (per system)

Seven heavy-duty 4-cm fans with optimal fan speed control

### Power Supply

Model: PWS-2K71A-1R, two 2700 W redundant modules, 80Plus Titanium level

AC Input

1000 W: 100-127 Vac / 50-60 Hz

1800 W: 200-220 Vac / 50-60 Hz

1980 W: 220-230 Vac / 50-60 Hz

2000 W: 220-240 Vac / 50-60 Hz (for UL only)

2000 W: 230-240 Vac / 50-60 Hz

2000 W: 230-240 Vdc / 50-60 Hz (for CQC only)

+12 V

Max: 83 A / Min: 0 A (100 Vac-127 Vac)

Max: 150 A / Min: 0 A (200 Vac-220 Vac)

Max: 165 A / Min: 0 A (220 Vac-230 Vac)

Max: 166 A / Min: 0 A (230 Vac-240 Vac)

12V SB

Max: 3.5 A / Min: 0 A

**Operating Environment**

Operating Temperature: 10°C to 35°C (50°F to 95°F)

Non-operating Temperature: -40°C to 60°C (-40°F to 140°F)

Operating Relative Humidity: 8% to 90% (non-condensing)

Non-operating Relative Humidity: 5% to 95% (non-condensing)

**Regulatory Compliance**

FCC, ICES, CE, UKCA, VCCI, RCM, NRTL, CB

**Applied Directives, Standards**

EMC/EMI: 2014/30/EU (EMC Directive)

Electromagnetic Compatibility Regulations 2016

FCC Part 15 Subpart B

ICES-003

VCCI-CISPR 32

AS/NZS CISPR 32

BS/EN 55032

BS/EN 55035

CISPR 32

CISPR 24/CISPR 35

BS/EN 61000-3-2

BS/EN 61000-3-3

BS/EN 61000-4-2

BS/EN 61000-4-3

BS/EN 61000-4-4

BS/EN 61000-4-5

BS/EN 61000-4-6

BS/EN 61000-4-8

BS/EN 61000-4-11

Product Safety: 2014/35/EU (LVD Directive)

UL/CSA 62368-1 (USA and Canada)

Electrical Equipment (Safety) Regulations 2016

IEC/BS/EN 62368-1

Environment:

Delegated Directive (EU) 2015/863

Directive 2011/65/EU (RoHS)

REACH Regulation EC 1907/2006

WEEE Directive 2012/19/EU

California Proposition 65

**Warning!** This product can expose you to chemicals including lead, known to the State of California to cause cancer and birth defects or other reproductive harm. For more information, go to [www.P65Warnings.ca.gov](http://www.P65Warnings.ca.gov).

**Perchlorate Warning**

California Best Management Practices Regulations for Perchlorate Materials: This Perchlorate warning applies only to products containing CR (Manganese Dioxide) Lithium coin cells. "Perchlorate Material-special handling may apply.

See "[www.dtsc.ca.gov/hazardouswaste/perchlorate](http://www.dtsc.ca.gov/hazardouswaste/perchlorate)".

**General Data Center Environmental Specifications****Particulate contamination specifications**

Air filtration: Data centers must be kept clean to Class 8 of ISO 14644-1 (ISO 2015). The air entering the data center should be filtered with a MERV 11 filter or better. The air within the data center should be continuously filtered with a MERV 8 filter or better.

Conductive dust: Air should be free of conductive dust, zinc whiskers, or other conductive particles.

Corrosive dust: Air should be free of corrosive dust.

**Gaseous\* contamination specifications**

Copper coupon corrosion rate: <300 Å/month per class G1 as defined by ANSI/ISA71.04-2013, referenced by ASHRAE TC 9.9

Silver coupon corrosion rate: <200 Å/month per class G1 as defined by ANSI/ISA71.04-2013, referenced by ASHRAE TC 9.9

\*If testing with silver or copper coupons results in values less than 200 Å/month or 300 Å/month, respectively, then operating up to 70% relative humidity (RH) is acceptable. If the testing shows corrosion levels exceed these limits, then catalyst-type pollutants are probably present and RH should be driven to 50% or lower.

この装置は、クラスA機器です。この装置を住宅環境で使用すると電波妨害を引き起こすことがあります。この場合には使用者が適切な対策を講ずるよう要求されることがあります。

VCCI – A