

## Information for Lot 9 of ErP (Ecodesign)

This addendum addresses European Union (EU) Ecodesign requirements for servers and storage products. All data and ratings within this addendum are in reference only to the Supermicro product(s) in the manual. The below information conforms to requirements laid down in Annex II of the Commission Regulation 2019/424.

- 3(1)(a): See Section 1.1 of the system manual for the product type.
- 3(1)(b): See the title page and preface of the system manual for the trademark and manufacturer's address.
- 3(1)(c): See the title page of the system manual for product model number(s).
- 3(1)(d): See the serial number on the physical system to determine the year of manufacture.
- 3(1)(e-j): **PSU Efficiency and Power Factor Value (Table) (From 80 Plus report)**

PSU Model #: PWS-1K63A-1R Watts: 1200W	PSU Efficiency				Power Factor
	% of Rated Load	10 %	20 %	50 %	
Single Output (AC-DC)	91.17 %	94.46 %	96.15 %	94.89 %	0.99

### System (EUT) Efficiency in **Idle State** Power (Table)

Representative Configurations	Measured Idle State Power (W)	Calculated Idle Power Allowance (W)
High-End Performance Configuration	561	995.65
Typical Configuration	N/A	N/A
Low-End Performance Configuration	245.3	858.05

### System (EUT) Efficiency in **Active State** Power (Table)

Representative Configurations	Active State Efficiency Score (Effserver)	Minimum Active State Efficiency for 2-Socket Server
High-End Performance Configuration	68.5	9
Typical Configuration	N/A	
Low-End Performance Configuration	77.4	

3(1)(k): The operating condition class is **A2**.

Operating condition class	Dry bulb temp °C		Humidity range, non-condensing		Max dew point (°C)	Maximum rate of change (°C/hr)
	Allowable range	Recommended range	Allowable range	Recommended range		
A1	15- 32	18-27	- 12 °C Dew Point (DP) and 8 % relative humidity (RH) to 17 °C DP and 80 % RH	- 9 °C DP to 15 °C DP and 60 % RH	17	5/20
A2	10-35	18-27	- 12 °C DP and 8 % RH to 21 °C DP and 80 % RH	Same as A1	21	5/20
A3	5-40	18-27	- 12 °C DP and 8 % RH to 24 °C DP and 85 % RH	Same as A1	24	5/20
A4	5-45	18-27	- 12 °C DP and 8 % RH to 24 °C DP and 90 % RH	Same as A1	24	5/20

3(1)(l): The idle state power at the higher boundary temperature of the operating conditions class is 661.98 W.

3(1)(m): The active state efficiency and performance is 68.5.

3(1)(n): There are two methods by which a user can securely delete data from this system. The user performing secure data deletion should be an IT professional.

The first is with a Unified Extensible Firmware Interface (UEFI) shell utility. This utility works on X14 motherboard series with onboard SATA/NVMe devices. Any user may access and download this utility through following link:  
[https://www.supermicro.com/about/policies/disclaimer.cfm?url=/wftp/utility/Lot9\\_Secure\\_Data\\_Deletion\\_UTILITY/](https://www.supermicro.com/about/policies/disclaimer.cfm?url=/wftp/utility/Lot9_Secure_Data_Deletion_UTILITY/)

Download the shell utility package and extract it to a USB flash drive, then plug the drive into the server for which secure data deletion is necessary. Then turn the system on. Navigate to the BIOS setup menu, then place the server system into the UEFI shell environment. Follow the instructions in the README file to invoke the utility and complete the deletion.

The second method is through the secure data deletion tool provided by the original manufacturer of the hard drive. This should be used in a scenario where the shell utility is not applicable. Each manufacturer should have the tool available on their website. If needed, please look on the hard drive label for the name of the manufacturer and model information.

3(1)(o): List of recommended combinations of blade servers with chassis: N/A.

3(1)(p): List of all current SKUs within this product family: SYS-212HA-TN.

3(3)(a): There is no use of cobalt in batteries in this product.

The indicative weight range of neodymium in the HDD is 0.0 if manufactured by Western Digital, and is between 5-25 grams if manufactured by Seagate.

3(3)(b): Please see the disassembly instructions on the next page.

## Illustrated System Disassembly Instructions

*Please note: All the illustrations in the below disassembly instructions are for demonstration only. Components shown here may not match exactly with the components in your system.*

**CAUTION: Always power off the system and unplug the power cord(s) first before disassembling the system!**

---

### 1. Data Storage Devices

*Type and number of fastenings:* One (1) latch and two (2) locking clasps.

*Tools required:* None.

*Procedure:*

1. Push the release button on the drive carrier, which will extend the drive carrier handle.
2. Use the drive carrier handle to pull the drive out of the chassis.
3. Pull the drive out of the carrier.



---

## 2. Memory

Type and number of fastenings: Two (2) latches per memory module.

Tools required: None.

Procedure: Press both release tabs on the ends of the memory module to unlock it. Once the module is loosened, remove it from the memory slot.

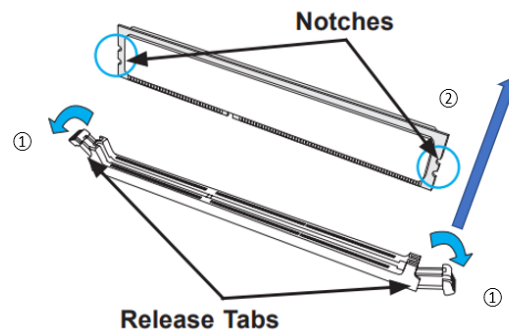

---

## 3. Processor

Type and number of fastenings: Four (4) T30 Torx screws.

Tools required: Screwdriver with T30 Torx bit.

Procedure:

1. Use a screwdriver to loosen the four screws. You can start with any screw, but make sure to loosen the screws in a diagonal pattern.

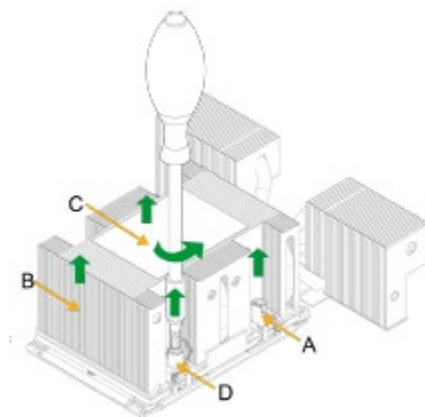

2. Press the four rotating wires inward to unlatch the processor heatsink module from the socket.

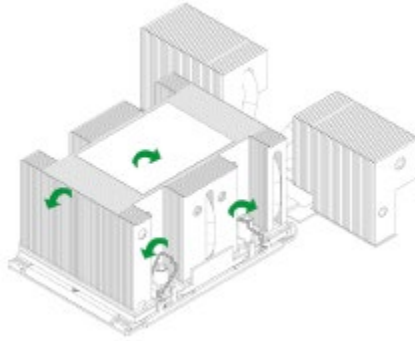

3. Gently lift the processor heatsink module upward to remove it from the socket.

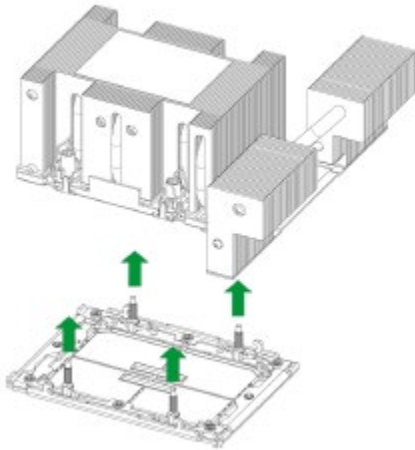

4. To remove the processor from the heatsink, gently lift the lever from the processor carrier.

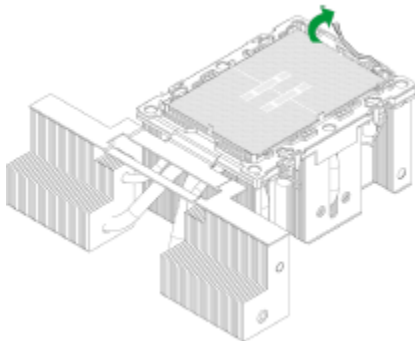

5. To remove the processor, move the lever to its unlocked position and gently remove the processor.

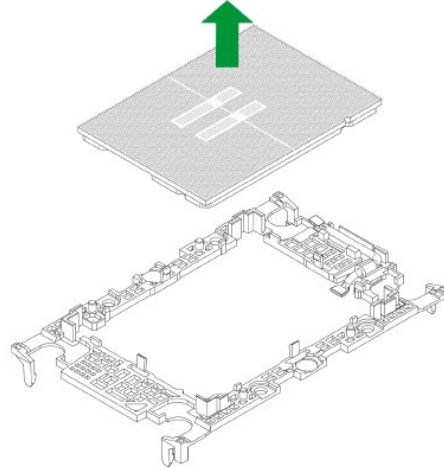

---

#### 4. Motherboard

*Type and number of fastenings:* Two (2) thumbscrews.

*Tools required:* None

*Procedure:* Loosen the thumbscrews on the motherboard and slide the motherboard forward to lift the motherboard out of the chassis.

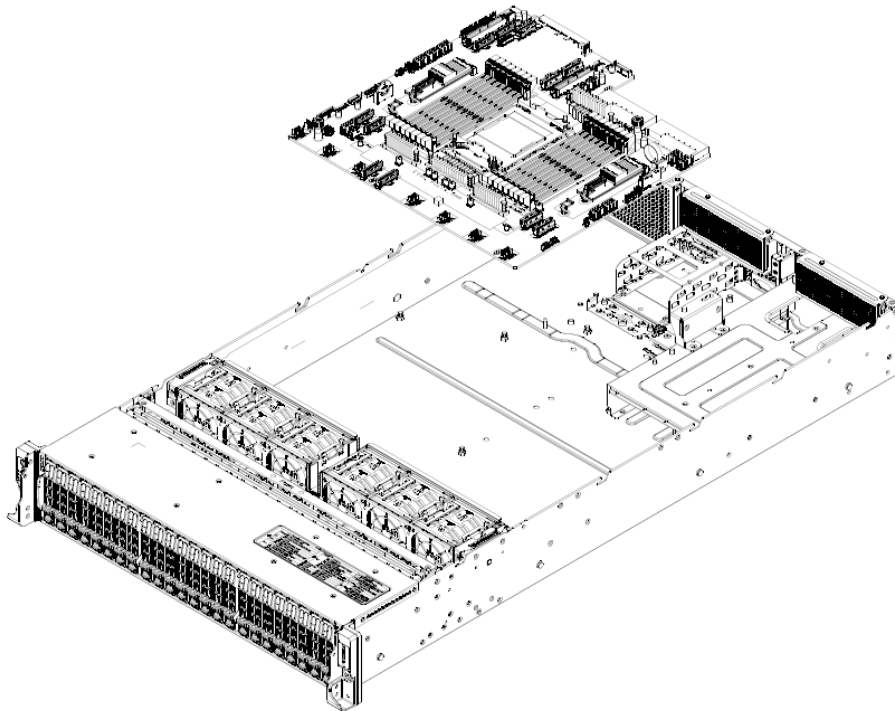

---

## 5. Expansion Card/Graphics Card

*Type and number of fastenings:* One (1) latch per expansion card installed.

*Tools required:* None.

*Procedure:* Unplug any cables connected to the riser card. Lift the riser card bracket from the chassis. Unlatch the expansion card and pull it out from the riser card.

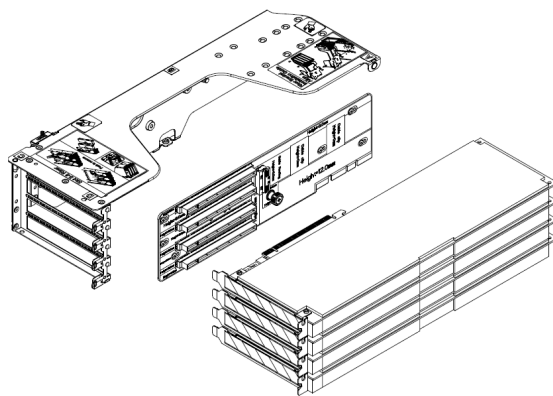
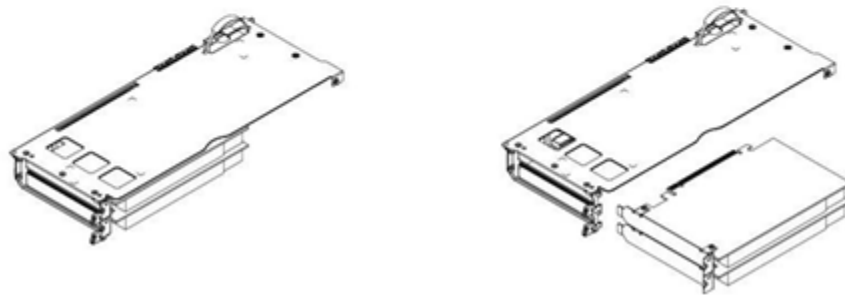
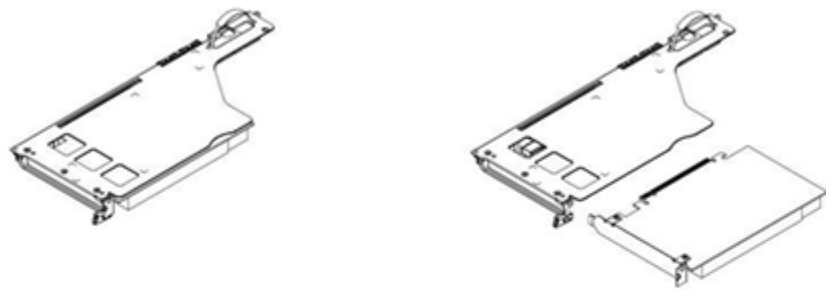

---

## 6. Power Supply Module

*Type and number of fastenings:* One (1) latch per module.

*Tools required:* None.

*Procedure:* Unplug the power cord from the power supply. Push the release tab on the back of the power supply module to the side and pull the module straight out.

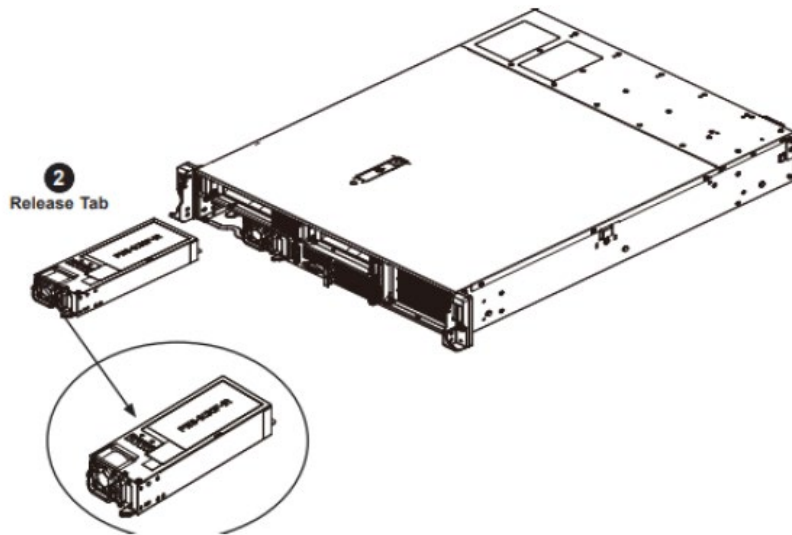

---

## 7. Chassis Cover

Type and number of fastenings: One (1) release button and latch.

Tools required: None.

Procedure: Press the release button and slide the cover toward the rear.

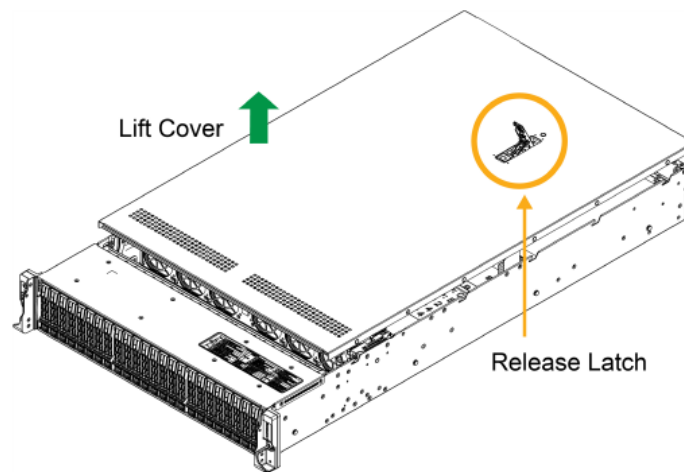

---

## 8. Batteries

Type and number of fastenings: One (1) latch.

Tools required: None.

Procedure: Push aside the small clamp that covers the edge of the battery. When the battery is released, lift it out of the holder.

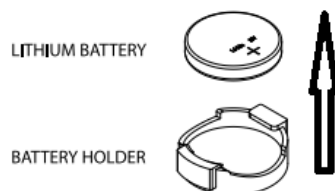

---

## 9. Riser Card

*Type and number of fastenings:* One (1) thumbscrew per riser card.

*Tools required:* None

*Procedure:* Unplug any cables connected to the riser card, and lift the riser card bracket from the chassis. Loosen the thumbscrew on the riser card, and remove the riser card from the riser card bracket.

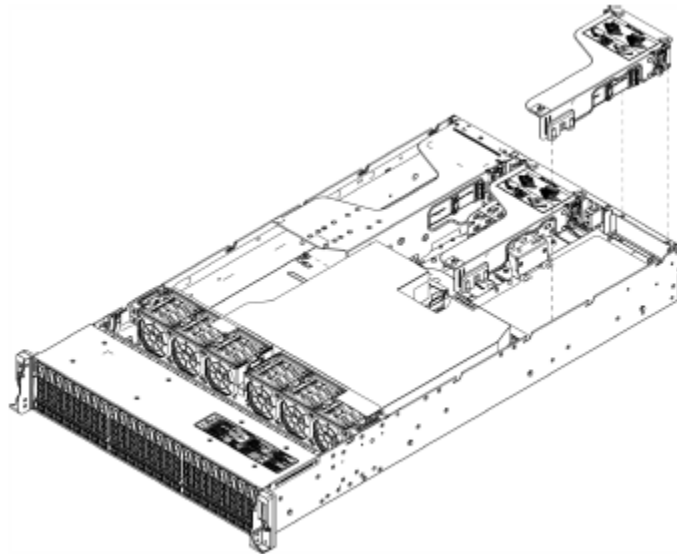

---

## 10. Fans

Type and number of fastenings: One (1) fan header per fan.

Tools required: None.

Procedure: Pull the fan up to disconnect it from the fan header on the motherboard.

