

Information for Lot 9 of ErP (Ecodesign)

This addendum addresses European Union (EU) Ecodesign requirements for servers and storage products. All data and ratings within this addendum are in reference only to the Supermicro product(s) in the manual. The below information conforms to requirements laid down in Annex II of the Commission Regulation 2019/424.

- 3(1)(a): See Section 1.1 of the system manual for the product type.
- 3(1)(b): See the title page and preface of the system manual for the trademark and manufacturer's address.
- 3(1)(c): See the title page of the system manual for product model number(s).
- 3(1)(d): See the serial number on the physical system to determine the year of manufacture.
- 3(1)(e-j): **PSU Efficiency and Power Factor Value (Table) (From 80 Plus report)**

PSU Model #: PWS-1K23A-1R Watts:1200W	PSU Efficiency				Power Factor
	10 %	20 %	50 %	100 %	
% of Rated Load	10 %	20 %	50 %	100 %	50 %
Single Output (AC-DC)	91.79 %	95.21 %	96.37%	94.62%	0.98

System (EUT) Efficiency in **Idle State** Power (Table)

Representative Configurations	Measured Idle State Power (W)	Calculated Idle Power Allowance (W)
High-End Performance Configuration	382.9	554.9175698
Typical Configuration	N/A	N/A
Low-End Performance Configuration	243.7	433.0400804

System (EUT) Efficiency in **Active State** Power (Table)

Representative Configurations	Active State Efficiency Score (Effserver)	Minimum Active State Efficiency for 2-Socket Server
High-End Performance Configuration	46.7	9.5
Typical Configuration	N/A	
Low-End Performance Configuration	37.9	

3(1)(k): The operating condition class is **A2**.

Operating condition class	Dry bulb temp °C		Humidity range, non-condensing		Max dew point (°C)	Maximum rate of change (°C/hr)
	Allowable range	Recommended range	Allowable range	Recommended range		
A1	15- 32	18-27	- 12 °C Dew Point (DP) and 8 % relative humidity (RH) to 17 °C DP and 80 % RH	- 9 °C DP to 15 °C DP and 60 % RH	17	5/20
A2	10-35	18-27	- 12 °C DP and 8 % RH to 21 °C DP and 80 % RH	Same as A1	21	5/20
A3	5-40	18-27	- 12 °C DP and 8 % RH to 24 °C DP and 85 % RH	Same as A1	24	5/20
A4	5-45	18-27	- 12 °C DP and 8 % RH to 24 °C DP and 90 % RH	Same as A1	24	5/20

3(1)(l): The idle state power at the higher boundary temperature of the operating conditions class is **382.9 W**.

3(1)(m): The active state efficiency and performance is **46.7**.

3(1)(n): There are two methods by which a user can securely delete data from this system. The user performing secure data deletion should be an IT professional.

The first is with a Unified Extensible Firmware Interface (UEFI) shell utility. This utility works on X10/X11/X12/X13/X14/H11/H12/H13/H14/M11 motherboard series with onboard SATA/NVMe devices. Any user may access and download this utility through following link:

https://www.supermicro.com/about/policies/disclaimer.cfm?url=/wftp/utility/Lot9_Secure_Data_Deletion_Utility/

Download the shell utility package and extract it to a USB flash drive, then plug the drive into the server for which secure data deletion is necessary. Then turn the system on. Navigate to the BIOS setup menu, then place the server system into the UEFI shell environment. Follow the instructions in the README file to invoke the utility and complete the deletion.

The second method is through the secure data deletion tool provided by the original manufacturer of the hard drive. This should be used in a scenario where the shell utility is not applicable. Each manufacturer should have the tool available on their website. If needed, please look on the hard drive label for the name of the manufacturer and model information.

3(1)(o): List of recommended combinations of blade servers with chassis: N/A.

3(1)(p): List of all current SKUs within this product family: **SYS-621P-TRT**.

3(3)(a): There is no use of cobalt in batteries in this product.

The indicative weight range of neodymium in the HDD is 0.0 if manufactured by Western Digital, and is between 5-25 grams if manufactured by Seagate.

3(3)(b): Please see the disassembly instructions on the next page.

Illustrated System Disassembly Instructions

Please note: All the illustrations in the below disassembly instructions are for demonstration only. Components shown here may not match exactly with the components in your system.

CAUTION: Always power off the system and unplug the power cord(s) first before disassembling the system!

1. Data Storage Devices

Type and number of fastenings: One (1) latch and four (4) Phillips screws.

Tools required: Screwdriver with PH2 bit.

Procedure: Push the release button on the carrier. Swing the handle fully. Grasp the handle and pull the drive carrier out of its bay.

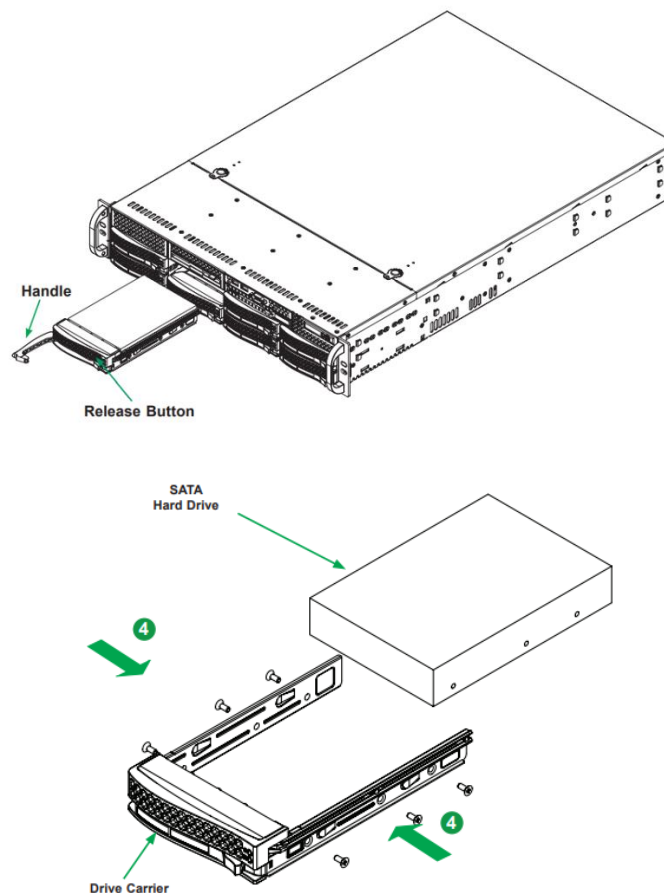

2. Memory

Type and number of fastenings: Two (2) latches per memory module.

Tools required: None.

Procedure: Press both release tabs on the ends of the memory module to unlock it. Once the module is loosened, remove it from the memory slot.

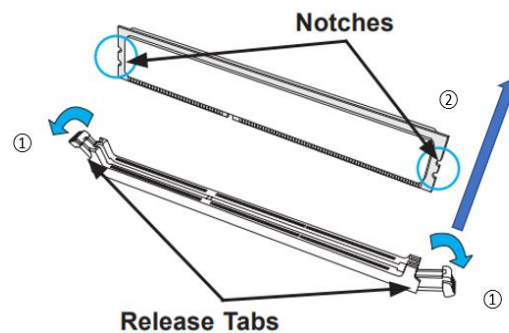

3. Processor

Type and number of fastenings: Four (4) T30 Torx screws.

Tools required: Screwdriver with T30 Torx bit.

Procedure: Remove the screws in the sequence of 4, then 3, then 2, then 1, as marked in the illustration below. After removing the screws, lift the processor heatsink module off the processor socket. Unsnap corners A and B, then C and D of the latch. Push the latch out from the bottom.

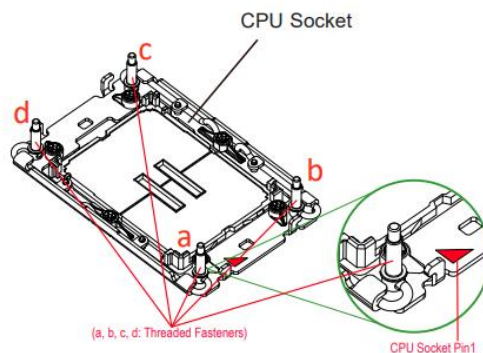

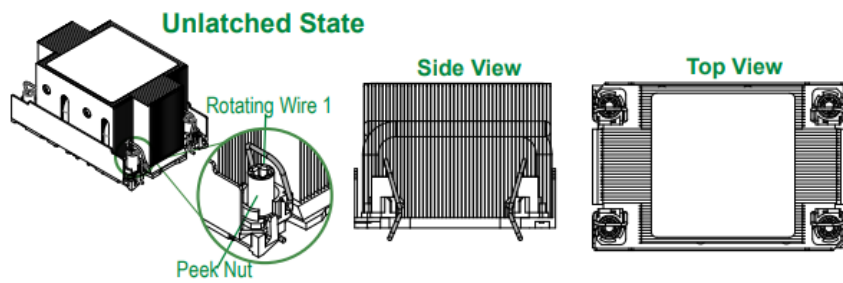
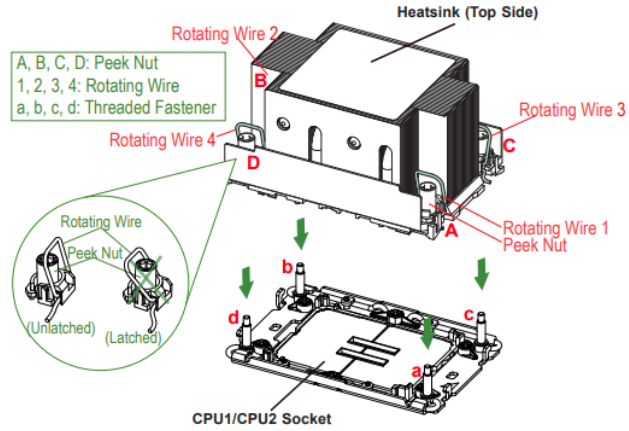

4. Motherboard

Type and number of fastenings: Nine (9) Phillips screws.

Tools required: Screwdriver with PH2 bit.

Procedure: Remove all nine Phillips screws. Lift the motherboard from its base.

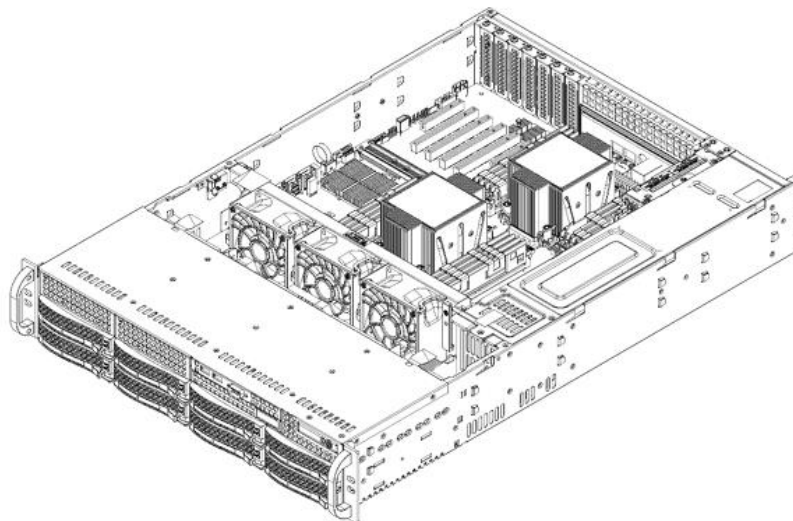

5. Expansion Card/Graphics Card

Type and number of fastenings: One (1) Phillips screw.

Tools required: Screwdriver with PH2 bit.

Procedure: Remove the Phillips screw. Open the rear window latch and carefully remove the expansion card from the riser card slot, lifting it up and away from the system.

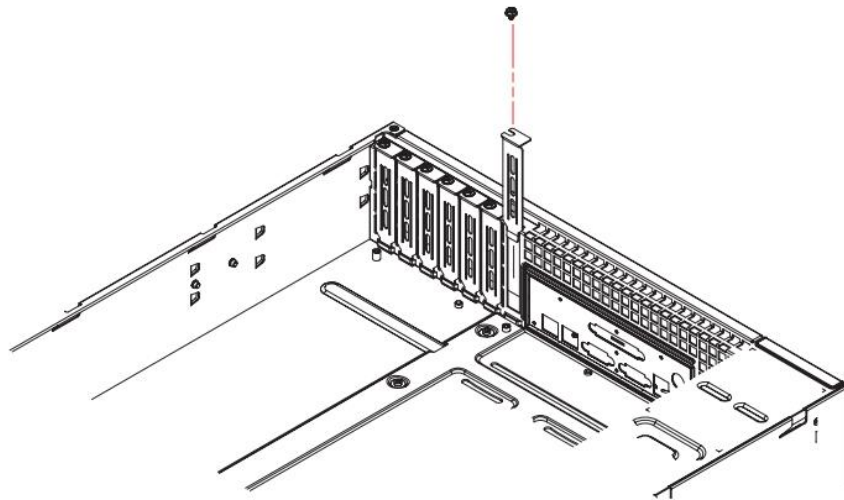

6. Power Supply Module

Type and number of fastenings: One (1) latch per module.

Tools required: None.

Procedure: Unplug the power cord from the power supply. Push the release tab on the back of the power supply module to the side and pull the module straight out.

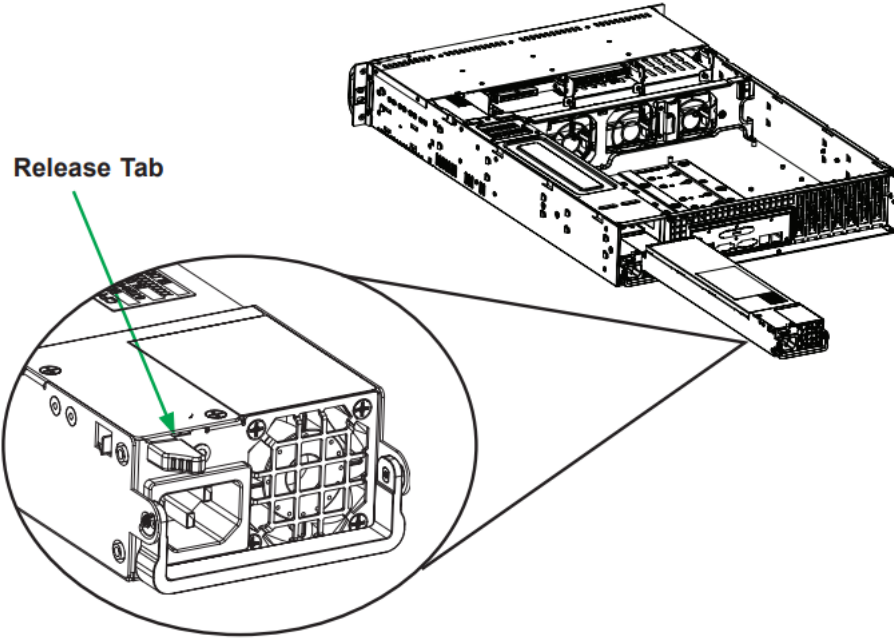

7. Chassis Cover

Type and number of fastenings: Two (2) buttons and two (2) screws.

Tools required: Screwdriver with PH2 bit.

Procedure: Remove the screws. Hold down the two buttons simultaneously while pushing away the top cover.

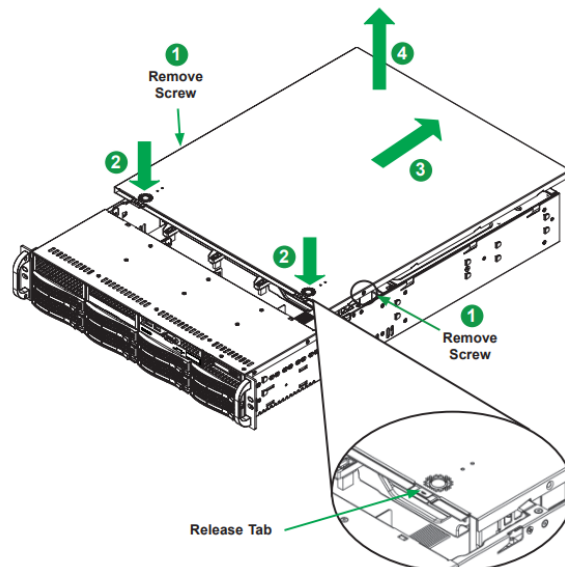

8. Batteries

Type and number of fastenings: One (1) latch.

Tools required: None.

Procedure: Push aside the small clamp that covers the edge of the battery. When the battery is released, lift it out of the holder.

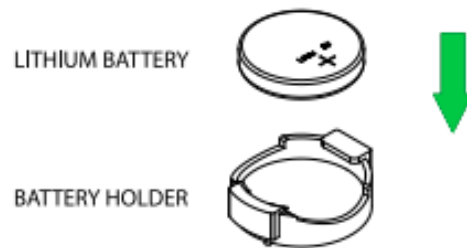

9. Fans

Type and number of fastenings: One (1) fan header per fan.

Tools required: None.

Procedure: Disconnect the fan wiring from the fan header on the motherboard. Then remove the fan from the fan tray.

